



# Precision by ViewSonic®

Home Theater Projector

## User's Manual



ENG

FRN

ESP

# Compliance Information

## FCC Statement

This device complies with part 15 of FCC Rules. Operation is subject to the following two conditions: (1) this device may not cause harmful interference, and (2) this device must accept any interference received, including interference that may cause undesired operation.

This equipment has been tested and found to comply with the limits for a Class B digital device, pursuant to part 15 of the FCC Rules. These limits are designed to provide reasonable protection against harmful interference in a residential installation. This equipment generates, uses, and can radiate radio frequency energy, and if not installed and used in accordance with the instructions, may cause harmful interference to radio communications. However, there is no guarantee that interference will not occur in a particular installation. If this equipment does cause harmful interference to radio or television reception, which can be determined by turning the equipment off and on, the user is encouraged to try to correct the interference by one or more of the following measures:

- Reorient or relocate the receiving antenna.
- Increase the separation between the equipment and receiver.
- Connect the equipment into an outlet on a circuit different from that to which the receiver is connected.
- Consult the dealer or an experienced radio/TV technician for help.

**Warning:** You are cautioned that changes or modifications not expressly approved by the party responsible for compliance could void your authority to operate the equipment.

## For Canada

- This Class B digital apparatus complies with Canadian ICES-003.
- Cet appareil numérique de la classe B est conforme à la norme NMB-003 du Canada.

## CE Conformity for European Countries



The device complies with the requirements of the EEC directive 89/336/EEC as amended by 92/31/EEC and 93/68/EEC Art.5 with regard to "Electromagnetic compatibility", and 73/23/EEC as amended by 93/68/EEC Art.13 with regard to "Safety."

## Following information is only for EU-member states:

The mark shown to the right is in compliance with the Waste Electrical and Electronic Equipment Directive 2002/96/EC (WEEE).

The mark indicates the requirement NOT to dispose the equipment as unsorted municipal waste, but use the return and collection systems according to local law.



## Important Safety Instructions

1. Read these instructions.
2. Keep these instructions.
3. Heed all warnings.
4. Follow all instructions.
5. Do not use this unit near water.
6. Clean with a soft, dry cloth. If still not clean, see "Cleaning the Display" in this guide for further instructions.
7. Do not block any ventilation openings. Install the unit in accordance with the manufacturer's instructions.
8. Do not install near any heat sources such as radiators, heat registers, stoves, or other devices (including amplifiers) that produce heat.
9. Do not defeat the safety purpose of the polarized or grounding-type plug. A polarized plug has two blades with one wider than the other. A grounding type plug has two blades and a third grounding prong. The wide blade and the third prong are provided for your safety. If the provided plug does not fit into your outlet, consult an electrician for replacement of the obsolete outlet.
10. Protect the power cord from being walked on or pinched particularly at plugs. Convenience receptacles and the point where they exit from the unit. Be sure that the power outlet is located near the unit so that it is easily accessible.
11. Only use attachments/accessories specified by the manufacturer.
12.  Use only with the cart, stand, tripod, bracket, or table specified by the manufacturer, or sold with the unit. When a cart is used, use caution when moving the cart/unit combination to avoid injury from tipping over.
13. Unplug this unit when unused for long periods of time.
14. Refer all servicing to qualified service personnel. Servicing is required when the unit has been damaged in any way, such as: if the power-supply cord or plug is damaged, if liquid is spilled onto or objects fall into the unit, if the unit is exposed to rain or moisture, or if the unit does not operate normally or has been dropped.

## Declaration of RoHS Compliance

This product has been designed and manufactured in compliance with Directive 2002/95/EC of the European Parliament and the Council on restriction of the use of certain hazardous substances in electrical and electronic equipment (RoHS Directive) and is deemed to comply with the maximum concentration values issued by the European Technical Adaptation Committee (TAC) as shown below:

Substance	Proposed Maximum Concentration	Actual Concentration
Lead (Pb)	0.1%	< 0.1%
Mercury (Hg)	0.1%	< 0.1%
Cadmium (Cd)	0.01%	< 0.01%
Hexavalent Chromium (Cr <sup>6+</sup> )	0.1%	< 0.1%
Polybrominated biphenyls (PBB)	0.1%	< 0.1%
Polybrominated diphenyl ethers (PBDE)	0.1%	< 0.1%

Certain components of products as stated above are exempted under the Annex of the RoHS Directives as noted below:

Examples of exempted components are:

1. Mercury in compact fluorescent lamps not exceeding 5 mg per lamp and in other lamps not specifically mentioned in the Annex of RoHS Directive.
2. Lead in glass of cathode ray tubes, electronic components, fluorescent tubes, and electronic ceramic parts (e.g. piezoelectronic devices).
3. Lead in high temperature type solders (i.e. lead-based alloys containing 85% by weight or more lead).
4. Lead as an alloying element in steel containing up to 0.35% lead by weight, aluminium containing up to 0.4% lead by weight and as a copper alloy containing up to 4% lead by weight.

## Copyright Information

Copyright© ViewSonic© Corporation, 2007. All rights reserved.  
 Macintosh and Power Macintosh are registered trademarks of Apple Computer, Inc.  
 Microsoft, Windows, Windows NT, and the Windows logo are registered trademarks of Microsoft Corporation in the United States and other countries.  
 ViewSonic, the three birds logo, OnView, ViewMatch, and ViewMeter are registered trademarks of ViewSonic Corporation.  
 VESA is a registered trademark of the Video Electronics Standards Association. DPMS and DDC are trademarks of VESA.  
 PS/2, VGA and XGA are registered trademarks of International Business Machines Corporation.

Disclaimer: ViewSonic Corporation shall not be liable for technical or editorial errors or omissions contained herein; nor for incidental or consequential damages resulting from furnishing this material, or the performance or use of this product.

In the interest of continuing product improvement, ViewSonic Corporation reserves the right to change product specifications without notice. Information in this document may change without notice.

No part of this document may be copied, reproduced, or transmitted by any means, for any purpose without prior written permission from ViewSonic Corporation.

## Product Registration

To meet your future needs, and to receive any additional product information as it becomes available, please register your product on the Internet at: [www.viewsonic.com](http://www.viewsonic.com). The ViewSonic® Wizard CD-ROM also provides an opportunity for you to print the registration form, which you may mail or fax to ViewSonic.

### For Your Records

Product Name:	Pro8100 Home Theater Projector
Model Number:	VS11856
Document Number:	Pro8100_UG_ENG Rev. 1A 09-28-07
Serial Number:	_____
Purchase Date:	_____



The lamp in this product contains mercury.  
 Please dispose of in accordance with local, state or federal laws.

# Table of Contents

## Compliance Information.....i

FCC Statement

For Canada

CE Conformity for European Countries

Following information is only for EU-member states

Important Safety Instructions

Declaration of RoHS Compliance

Copyright Information

Product Registration

## Chapter 1: Introduction.....1

Projector Features

Notes on the AC Power Cord

Package Contents

Projector Overview

Control Panel

Connection ports

Remote Control

Installing the Batteries

Remote Control Operation

## Chapter 2: Installation.....6

Power connection

Audio and Video Devices Connectivity Configuration

Adjusting the Projected Image

Adjusting Projection Image Size

Projection Screen Selection

## Chapter 3: Remote Control direct access.....12

Picture Modes

Color Temperature

PCS (Precision Color System)

HQV

Black Level

Daylight Sensor

Input Source Select

Direct Input Keys

Aspect Ratio

Overscan

Freeze

Keystone

Zoom and Focus

Lens Shift

Power

Light

## Chapter 4: ADVANCED OPERA- TION (OSD Menu).....20

1. Main Menu

2. Setup Menu

2-1. Picture Sub-Menu

2-1-1 Basic Sub-Menu

2-1-2 Color Temperature Sub-Menu

2-1-3 Image Adjust Sub-Menu

2-1-4 Aspect Ratio

2-1-5 Overscan

2-1-6 Geometry Adjust

2-2. Advanced Sub-Menu

2-2-1 Picture Mode

2-2-2 Black Level

2-2-3 HQV

2-2-4 Noise Reduction

2-2-5 Color Space

2-3 Config Sub-Menu

2-3-1 Projector Settings

2-3-2 OSD

2-3-3 Languages

2-3-4 Timers

2-3-5 High Altitude

2-3-6 Auto Iris

2-4 PCS Settings Sub-Menu

2-4-1 PCS

2-4-2 PCS Display

2-4-3 Flesh tone

2-4-4 Edge Enhancement

2-4-5 Gamma Correction

2-4-6 3D Color Management

2-5 Memory Settings Sub-Menu

2-5-1 Custom Color Temperature

2-5-2 Save

2-5-3 Load

2-5-4 Reset

2-5-5 System Status Screen

Maintenance

Cleaning the Lens

Cleaning the Projector Housing

Maintaining the Air Filter

Replacing the Air Filter

Replacing the Lamp

## Appendix.....44

Troubleshooting

List of Compatible Signals

LED Indicator Message

Product Specification

RS232 command code

Remote control code

Customer Support

Limited Warranty

# Chapter 1: Introduction

## Projector Features

The projector integrates high-performance optical engine projection and a user-friendly design to deliver high reliability and ease of use.

- 1080P (1920x1080) Full HD native resolution.
- C<sup>2</sup> Fine™ LCD panel for superior performance.
- Silicon Optix HQV™ for highest quality video.
- Precision Color System for true color image enhancement.
- Power horizontal and vertical lens shift.
- HDMI 1.3 support with HDCP compliance.
- 1.6x power optical zoom lens.
- Auto-iris enables high contrast to produce deeper black levels.
- Daylight sensor for auto setting based on ambient light conditions.

## Notes on the AC Power Cord

AC Power Cord must meet the requirement of countries where you use this projector. Please confirm your AC plug type with the graphics below and ensure that the proper AC Power Cord is used. If the supplied AC Power Cord does not match your AC outlet, please contact your sales dealer. This projector is equipped with a grounding type AC line plug. Please ensure that your outlet fits the plug. Do not defeat the safety purpose of this grounding type plug. We highly recommend using a video source device also equipped with a grounding type AC line plug to prevent signal interference due to voltage fluctuations.

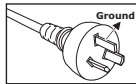

For Australia and Mainland China

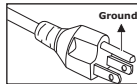

For the U.S.A. and Canada

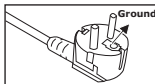

For Continental Europe

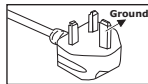

For the U.K.

## Package Contents

When you unpack the projector, make sure you have all these components:

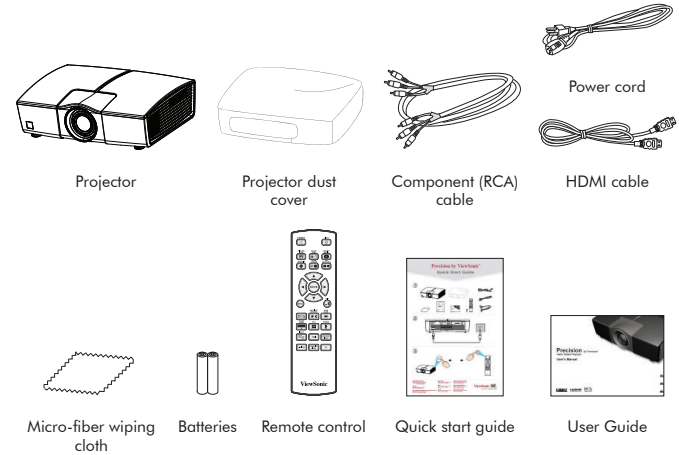

1. Projector
2. Projector dust cover. x1
3. Component (RCA) cable x1
4. Power cord x1
5. HDMI cable x1
6. Micro-fiber wiping cloth. x1
7. AA size batteries for remote control x 2
8. Remote control x1
9. Quick start guide x1
10. User Guide x1

### « NOTE »

- Save the original shipping carton and packing material; they will come in handy if you ever to ship your unit. For maximum protection, repack your unit as it was originally packed at the factory.
- Accessories and components may vary by retailer and region.

## Projector Overview

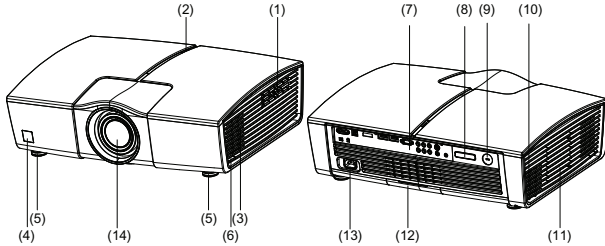

- |                                   |                          |
|-----------------------------------|--------------------------|
| 1. Control panel                  | 9. Kensington lock       |
| 2. LED indicator                  | 10. Air outlet grille    |
| 3. Air inlet grille               | 11. Lamp cover           |
| 4. Front IR remote control sensor | 12. Air filter cover     |
| 5. Elevation foot                 | 13. AC power socket      |
| 6. Elevation button               | 14. Projection lens      |
| 7. Connection ports               | 15. Ceiling mount (3-M6) |
| 8. Rear IR remote control sensor  |                          |

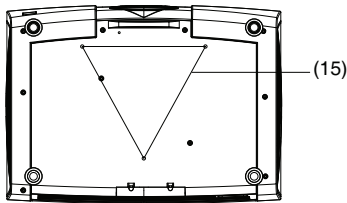

### « NOTE »

- This projector can be used with a ceiling mount for support. The ceiling mount is not included in the package.

## Control Panel

### LED indicator:

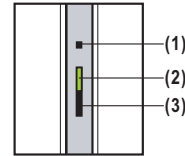

1. Daylight sensor.  
Refer to "LED Indicator Message" (Page 42).
2. Power indicator  
Refer to "LED Indicator Message" (Page 42).
3. Status indicator  
Refer to "LED Indicator Message" (Page 42).

### Button Function:

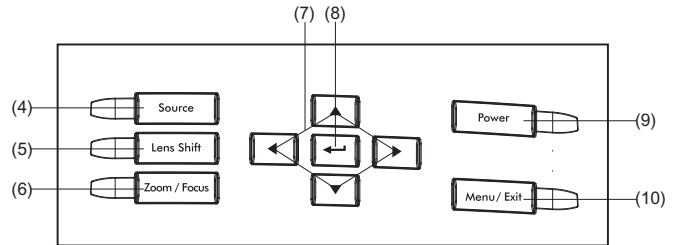

- |   |   |
|---|---|
| 4. Source<br>Manually selects an input source.  | 7. Four directional buttons<br>Use four directional buttons to select items or make adjustments to your selections. |
| 5. Lens Shift<br>Motorized vertical and horizontal lens shift for positioning display image without physically moving the unit. | 8. Enter<br>To confirm selected menu item.  |
| 6. Zoom/Focus<br>Motorized zoom and focus adjust.   | 9. Power<br>Turn on or off the projector.   |
|   | 10. Menu/Exit<br>Opens and Exits the on-screen menu.  |

## Connection ports

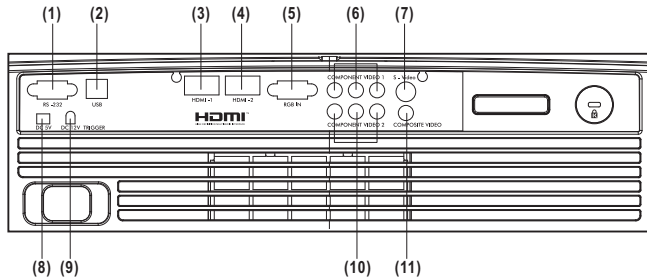

### 1. RS-232 terminal

When operating the projector via a computer, connect this to the controlling computer's RS-232C port.

### 2. USB terminal (Service purpose)

This connector is for firmware upgrade.

### 3. HDMI-1 terminal

Interface for digital video.

### 4. HDMI-2 terminal

Interface for digital video.

### 5. RGB IN terminal

Connects PC input signal (analog) to this jack.

### 6. COMPONENT VIDEO 1 terminals

Analog/digital video interface transmits via three separate signals - Y, Cb/Pb, Cr/Pr.

### 7. S-VIDEO terminal

Connects S-Video output from video equipment to this jack.

### 8. DC 5V terminal

### 9. DC 12V TRIGGER terminal

### 10. COMPONENT VIDEO 2 terminals

Analog/digital video interface transmits via three separate signals - Y, Cb/Pb, Cr/Pr.

### 11. COMPOSITE VIDEO terminal

Connects composite video output from video equipment to this jack.

## Remote Control

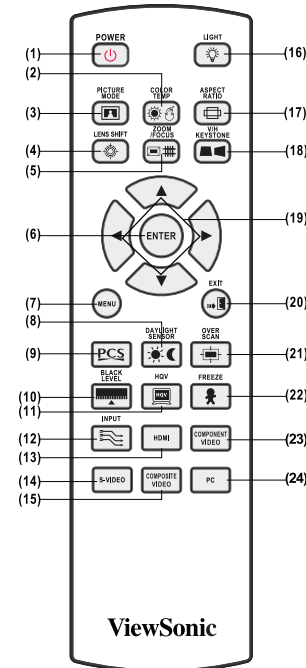

### 1. POWER

Turn on or off the projector.

### 2. COLOR TEMP.

Selections of color shading.

### 3. PICTURE MODE

One-step easy access to ViewSonic customized presets for various viewing pleasures.

### 4. LENS SHIFT

Motorized vertical and horizontal lens shift for positioning display image without physically moving the unit.

### 5. ZOOM/FOCUS

Motorized zoom and focus adjust.

### 6. ENTER

To confirm selected menu item.

### 7. MENU

Opens and Exits the on-screen menu.

### 8. DAYLIGHT SENSOR

Enable daylight sensor to automatically adjust the best viewing condition based on ambient light condition.

### 9. PCS

Enable advanced color enhancement functions such as flesh tone correction, edge enhancement, gamma correction and 3D color management.

### 10. BLACK LEVEL

Defines the brightness levels at the darkest visual image point.

#### 11. HQV

Enable image enhancement functions such as advanced motion, adaptive noise reduction, advanced film mode detection and advanced details enhancement.

#### 12. INPUT

Manually selects an input source.

#### 13. HDMI

Direct access to HDMI inputs. Browse through HDMI 1 and 2 inputs.

#### 14. S-VIDEO

Direct access to S-video input.

#### 15. COMPOSITE VIDEO

Direct access to composite video input.

#### 16. LIGHT

To illuminate remote control key pad backlight.

#### 17. ASPECT RATIO

Selections of screen proportion.

#### 18. V/H KEYSTONE

Adjust image geometry distortion digitally caused by off-center placement of projector.

#### 19. FOUR DIRECTIONAL BUTTONS

Use four directional buttons to select items or make adjustments to your selection.

#### 20. EXIT

To Exits the on-screen menu.

#### 21. OVERSCAN

To push data content out of the viewing area.

#### 22. FREEZE

Freeze the current viewing image.

#### 23. COMPONENT VIDEO

Direct access to component video inputs. Browse through component video 1 and 2 inputs.

#### 24. PC

Direct access to PC input.

## Installing the Batteries

1. Open the battery cover in the direction shown.

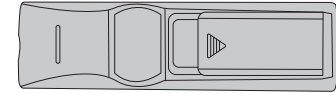

2. Install batteries as indicated by the diagram inside the compartment.

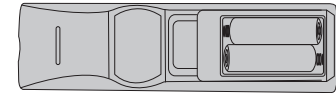

3. Close the battery cover into position.

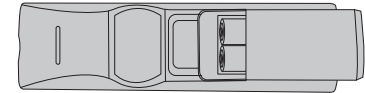

### « NOTE »

- Keep the batteries out of the reach of children. There is a danger of death by accidentally swallowing the battery.
- Remove batteries from remote control when not being used for extended periods.
- Do not dispose of the used battery along with household waste. Dispose of used batteries according to local regulations.
- Danger of explosion may occur if batteries are incorrectly replaced. Replace all the batteries with new ones.



## Remote Control Operation

Point the remote control at the infrared remote sensor and press a button.

- Operating the projector from the front

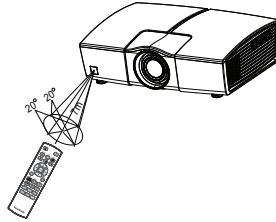

- Operating the projector from the rear

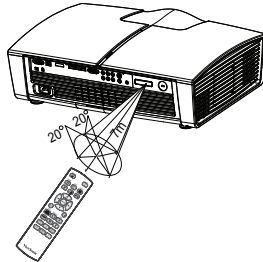

### « NOTE »

- Do not point the LED light pointer directly to the people's eyes (especially small children). There is a danger of injury to the eyes.
- The remote control may not operate when there is sunlight or other strong light such as a fluorescent lamp shining on the remote sensor.
- Operate the remote control from a position where the remote sensor is visible.
- Do not drop the remote control or jolt it.
- Keep the remote control out of locations with excessively high temperature or humidity.
- Do not get water on the remote control or place wet objects on it.
- Do not disassemble the remote control.

# Chapter 2: Installation

## Power connection

1. Remove the projector lens cap.
2. Plug the attached power cord into the AC power socket of this projector.
3. Plug the other end of the power cord into a power outlet.

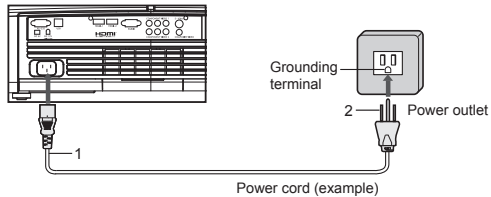

- The power cords for use in the U.S., UK and Europe are included with this projector. Use the appropriate one for your country.
- This projector uses the power plug of three-pin grounding type. Do not remove the grounding pin from the power plug. If the power plug doesn't fit your wall outlet, ask an electrician to change the wall outlet.
- The provided power cord for the U.S. is rated at 120 V. Never connect this cord to any outlet or power supply using other voltages or frequencies than rated. If you use a power supply using other voltage than rated, prepare an appropriate power cord separately.
- Use 100-240 V AC 50/60 Hz to prevent fire or electric shock.
- Do not place any objects on the power cord or do not place the projector near heat sources to prevent damage to the power cord. If the power cord should be damaged, contact your dealer for replacement because it may cause fire or electric shock.
- Do not modify or alter the power cord. If the power cord is modified or altered, it may cause fire or electric shock.

## Caution:

- Plug in the power cord firmly. When unplugging, hold and pull the power plug, not the power cord.
- Do not plug in or out the power cord with your hand wet. It may cause electric shock.

## Audio and Video Devices Connectivity Configuration

ViewSonic Pro8100 offers a full complementary video input connectivity - from the hi-tech HDMI to the basic composite video.

There are vast possibilities of audio & video connectivity configurations user can choose from.

However the best setup combination relies on user's equipments and using preferences.

Please seek professional advice for best matching setup. The video input type priority sequence is listed below:

- HDMI
- Component Video
- S-Video
- Composite Video

The illustration below shows some recommended setup configuration possibilities.

### A. Using Home Theater System as hub

This setup is recommended if a highly sophisticated home theater system is available.

This setup offers a great ease on utility for user, since settings of both audio and video can be changed without manual matching.

Pros: Eliminate audio and video source matching between projector and audio amplifier. Increase number of connecting devices. Reduce cabling to the projector.

Cons: High cost.

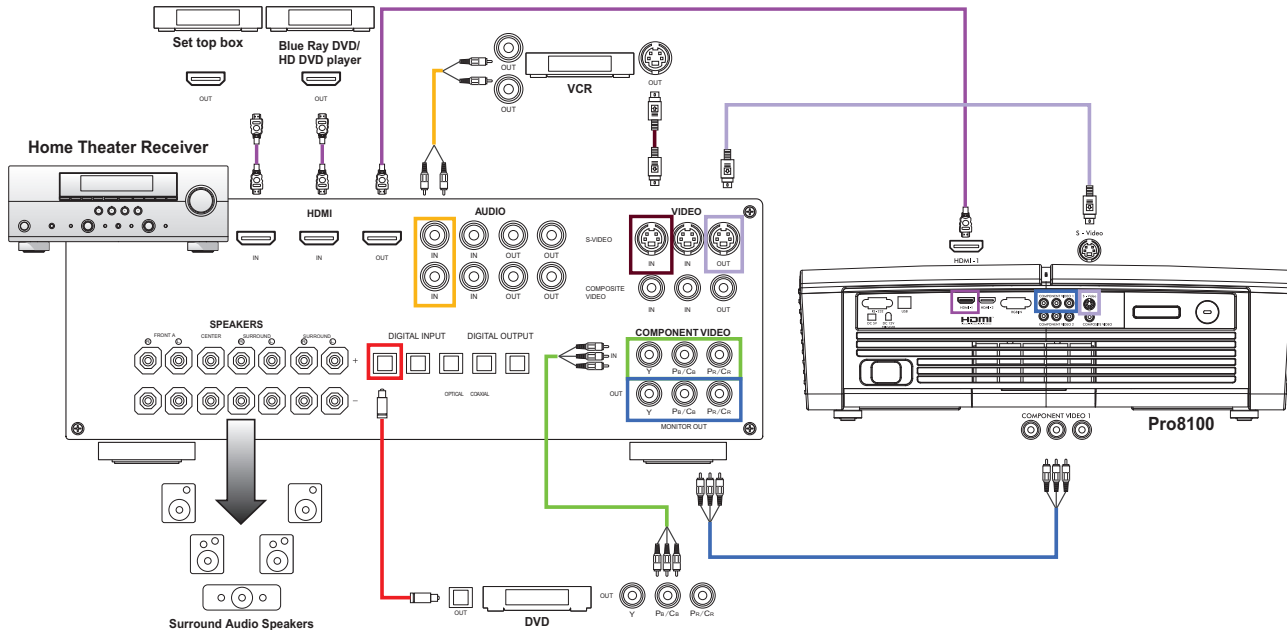

Note: The illustrated home theater receiver contains HDMI out, component video out, S-Video out and composite video out. Not all home theater receiver has full complementary of video output.

## B. Using Projector as hub

This setup is recommended for low to mid range home theater system.

When changing input source, both projector and home theater system's remote controls need to be activated.

Projector and home theater system controls can be centralized controlled by 3rd party's home appliances control system (Projector is via RS232).

Please seek professional advice for best suited type of home appliances control system.

Pros: Low budget.

Cons: It is required to match audio and video sources between projector and audio amplifier manually. Masses of routing cables need to be connected to projector.

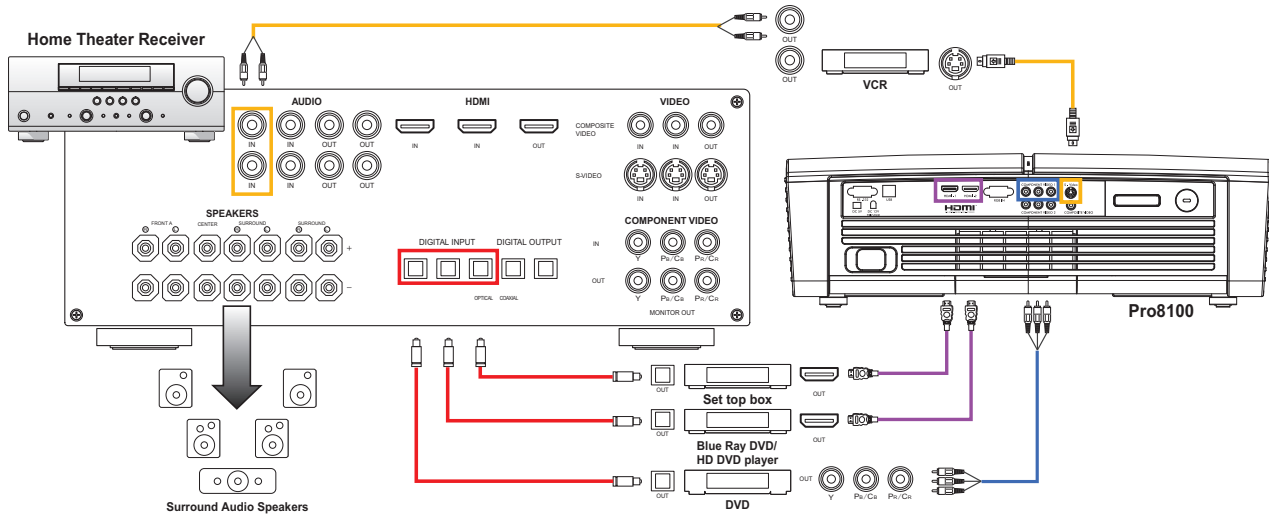

## C. Connecting Cable or Satellite TV

There's no build-in TV tuner in ViewSonic Pro8100.

It will only take direct video output (HDMI, Component Video, S-Video or Composite Video.) with cable or satellite set-top-box.

Please use by the recommended input priority order.

Please use HDMI or Component Video connection only if cable or satellite offers HDTV signals (Check with cable or satellite TV provider.).

#### D. RS232 Connection

The illustration shows the connection to a home appliances control device. ViewSonic Pro8100's RS232 command code table and setup protocol are listed in the Appendix section.

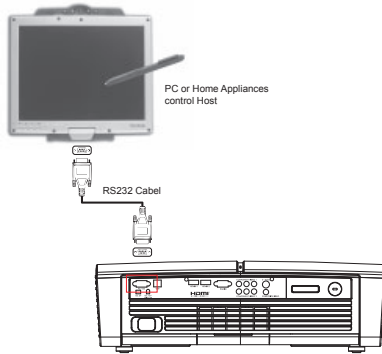

#### E. 12V Screen Curtain Trigger

ViewSonic Pro8100 offers a 12V trigger control pulse upon power-on and power-off. This 12V trigger pulse can be utilized to motor drive of a home theater's curtain or a drop-down projection screen.

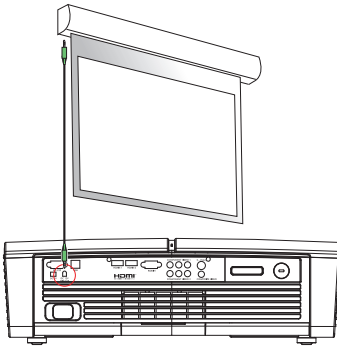

#### F. PC Input

ViewSonic Pro8100 can take analog PC video signal by RGB IN (Shown in the illustration below.).

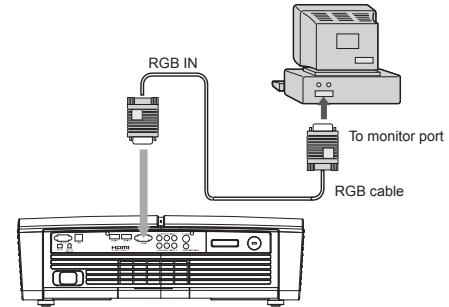

#### « NOTE »

- When connecting cable, power cords of both a projector and external equipment should be disconnected from AC outlet.
- The figure above is a sample connection. This does not mean that all of these devices can or must be connected simultaneously.
- The cables that come with the projector may differ from the above illustration. The included cables are based on actual shipment delivery.

## Adjusting the Projected Image

### Adjusting the Projector Height

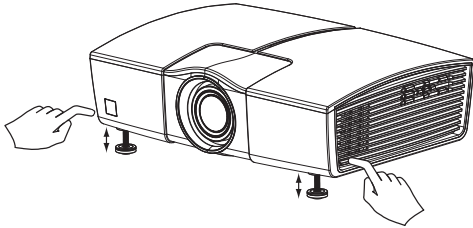

The projector is equipped with two elevation feet to adjust the image height.

To raise the image:

1. Press the elevation button.
2. Raise the image to the desired height angle, then release the button to lock the elevation foot into position.

To lower the image:

1. Press the elevation button.
2. Lower the image, then release the button to lock the elevation feet into position.

#### « NOTE »

- To avoid damaging the projector, make sure that the elevation feet are fully retracted before placing the projector in its package.

### Adjusting the Projector Lens Position

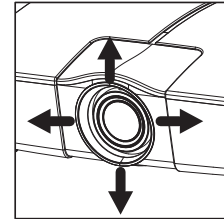

1. Press the Lens Shift button.
2. Use four directional buttons to adjust the lens position.

### The adjustable projection range

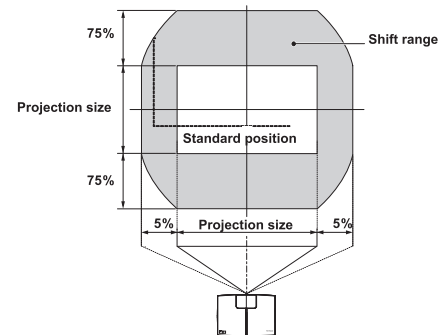

## Adjusting Projection Image Size

Refer to the graphic and table below to determine the screen size and projection distance.

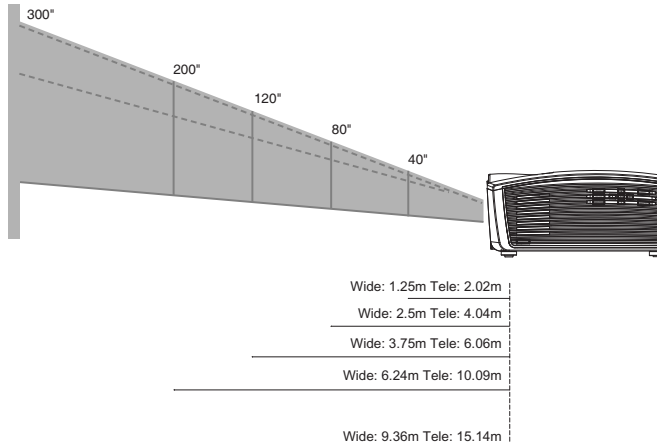

## Projection Screen Selection

ViewSonic Pro8100's preset image modes are calibrated based on a no-gain, pure flat white projection screen. For best preset performance, it is highly recommended to use a no-gain, flat white professional projection screen. The projection screens used in most office are gain-screens. Material used in brightness gain screen will cause decrease in viewing angle and hot-spot symptom. Black level and contrast performances can also be altered by the gain-screen since the gain will also boost the dark level brightness. The so-called hi-contrast gray projection screen can also alter the contrast and black level performance. The best viewing performance can not be brought by the standard factory presets, when using these types of projection screens. Please seek professional help for adapting a specialized screen, when calibrating the projector settings manually.

Screen Size (Diagonal)	16 : 9 Screen			
	Wide Projection Distance		Tele Projection Distance	
	m	inch	m	inch
40"	1.25	49.2	2.02	79.5
50"	1.56	61.5	2.52	99.4
60"	1.87	73.7	3.03	119.2
70"	2.19	86.0	3.53	139.1
80"	2.50	98.3	4.04	159.0
90"	2.81	110.6	4.54	178.8
100"	3.12	122.9	5.05	198.7
120"	3.75	147.5	6.06	238.5
150"	4.68	184.3	7.57	298.1
200"	6.24	245.8	10.09	397.4
250"	7.80	307.2	12.62	496.8
300"	9.36	368.7	15.14	596.2

### « NOTE »

- Position the projector in a horizontal position; other positions can cause heat build-up and damage to the projector.
- Make sure all intake and exhaust ventilation are not blocked.
- Do not use the projector in a smoky environment. Smoke residue can cause buildup on critical parts.



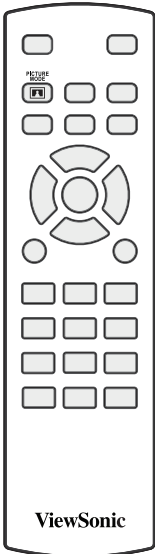

# Chapter 3: Remote Control direct access

## Picture Modes



One step easy access to ViewSonic customized picture modes.

Press  on the remote control to browse through available picture modes.





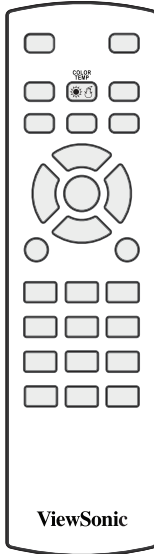

	Normal: Image is presented in original content. All special enhancement features are off.
	Vivid: High contrast, richer color and detail enhancement. Attention: Extended viewing may cause fatigue to the eyes.
	Cinema: Emphasis on enhancements of skin tone performance and cinematic effect.
	Professional: Emphasis on grayscale accuracy and color performance.
	User: Recall customized settings in user memory.

## Color Temperature



Selections of color shading

Press  on the remote control to browse through selections of color temperature.

	14,000K: Deep blue sky color shade.
	11,000K: Light blue sky color shade.
	8,500K: Balanced color shade.
	6,500K: Daylight color, slightly reddish shade.
	5,000K: Dusky sky alike color shade.
	User: Recall customized color temperature settings in user memory



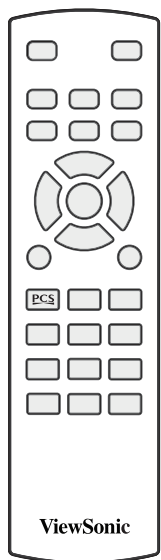

## PCS (Precision Color System)



PCS consists of advanced color enhancement functions such as flesh tone correction, edge enhancement, gamma correction and 3D color management. Preset or customized settings can be selected in the OSD menu, PCS Settings section (page 33).

Press  on the remote control to turn on or off the PCS feature.

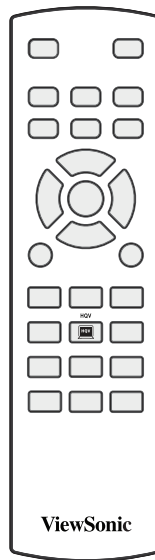

	PCS ON.
	PCS OFF.

## HQV



HQV (Hollywood Quality Video) consists of image enhancement functions such as advanced motion, adaptive noise reduction, advanced film mode detection and advanced details enhancement. User HQV settings can be defined in Advanced Operation section (page 26).

Press  on the remote control to turn on or off the HQV feature.



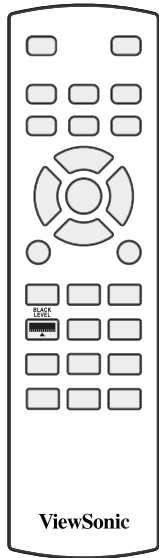

	HQV ON.
	HQV OFF.

## Black Level



Black level defines the brightness levels at the darkest visual image point. Higher black level removes color noise at darker grayscales and increase contrast level. However, darker images will be less visible if black level is set too high.

Press  on the remote control to browse through available black levels

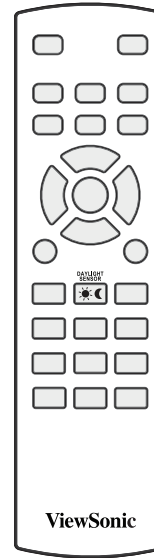

	Normal: Standard NTSC black level. Contents below standard black level will not be visible.
	Low: Portion of color noise reduced at darker grayscales.
	Mid: Majority of color noise reduced at darker grayscales.
	High: All color noise reduced at darker grayscales.
	Blacker than black: Black level is defined at 0 IRE. Image details that are darker than standard black level is visible, resulting in brighter images. Make sure the source content's (such as a DVD player) black level filter is turned off.

## Daylight Sensor



Enable daylight sensor to automatically adjust the best viewing condition based on ambient light condition.

Press  on the remote control to turn on or off the daylight sensor.



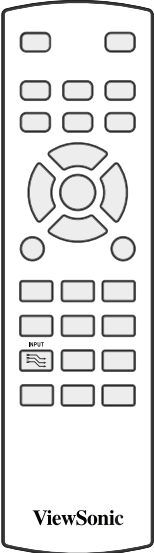

	Daylight Sensor AUTO: Automatically adjust for best viewing setting based on room ambient light condition.
	MANUAL: Recall customized setting in user memory.
	Daylight Sensor OFF: All settings will remain constant.

## Input Source Select



Select connected input sources.

Press  on the remote control to browse through available input sources.



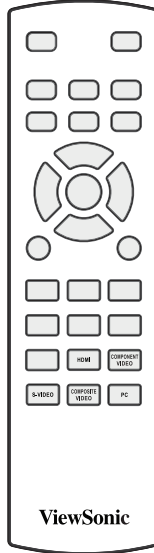

	HDMI: High Definition Multimedia Interface. Combined interface (multiple signals) for digital video and audio. Support up to 1080p. Video performance is constant and less dependence on cable quality in short distance transmission.
	Component Video: Analog/digital video interface transmits via three separate signals – Y, Cb/Pb, Cr/Pr. Support up to 1080p. Video performance relies highly on cable quality when it is in analog format.
	Composite Video: All video signals are combined into one signal line. Lowest video performance quality compared to other input formats.
	S-Video: Separate video. Video signals are transmitted via two lines – Y luminance and C chrominance. A step up in video performance compared to composite video.
	PC: Personal Computer. 15 pins D-sub analog computer VGA signal input.

## Direct Input Keys







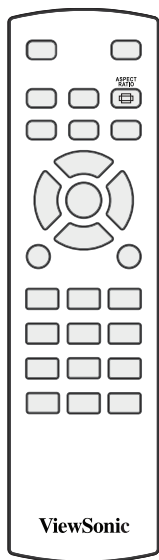

Direct input source switching without browsing through entire input selections.

Press one of the following keys on remote control for direct input access.

	Direct access to HDMI inputs. Browse through HDMI 1 and 2 inputs.
	Direct access to component video inputs. Browse through Component 1 and 2 inputs.
	Direct access to S-video input.
	Direct access to composite video input.
	Direct access to PC input.

## Aspect Ratio



Selections of screen proportion.	
Press  on the remote control to browse through available aspect ratio options.	
	Standard: Original Content's aspect ratio 4:3 source content. The image will be displayed with two black pillar bars on both right & left sides of the screen.
	Full Screen: Contents are displayed in full screen by linear stretch.
	Crop: Original content's aspect ratio is kept; full screen is achieved by cropping off image. Top and bottom sides of image are cropped for 4:3 source content.
	FlexView: Images are displayed in full screen by non-linear stretch, slightly stretching towards both left & right sides of the screen.

## Overscan

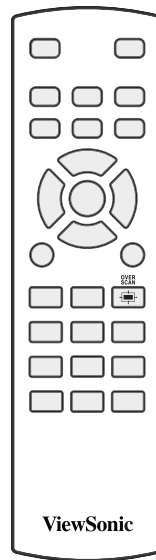

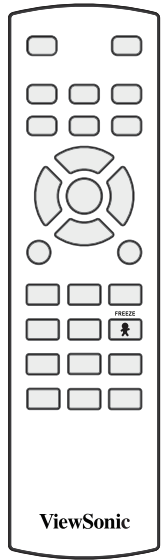

Some video sources have data content around the edges (Displayed as garbage lines). Use the overscan function to push data content out of the viewing area.	
Press  on the remote control to browse through available overscan options.	
OFF	Entire video contents are viewable.
2.5%	2.5% of video contents are pushed out of display area.
5.0%	5.0% of video contents are pushed out of display area.
7.5%	7.5% of video contents are pushed out of display area.
10.0%	10.0% of video contents are pushed out of display area.
Manual	User defined % (check Defined in OSD menu, page 23) of video contents are pushed out of display area.

## Freeze



Freeze the current viewing image.

Press  on the remote control to turn on or off the freeze function.

OFF	Freeze function OFF.
	Freeze function ON.

ViewSonic



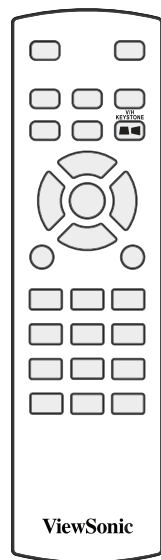

## Keystone



Adjust image geometry distortion digitally caused by improper placement of projector. Note: For best video performance, it is highly recommended to correct image distortion by physically connecting the placement of the unit.

Press  on the remote control to browse through available keystone correction options.

Keystone adjustment operation can be seen in Chapter 4 Advanced Operation, Geometry page 24.

	Vertical Keystone Adjust: Correct projector's tilt position.
	Horizontal Keystone Adjust: Correct projector's pointing direction.
	Rotation Adjust: Correct projector's horizontal placement offset.
	Auto Vertical Keystone Adjust: Enable sensor to automatically correct vertical keystone image distortion.

ViewSonic

## Zoom and Focus

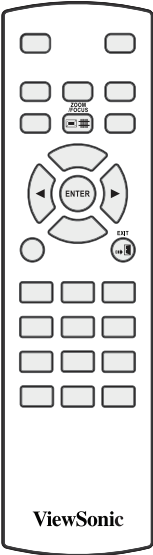







Motorized zoom and focus adjust.

Press  on the remote control to browse through zoom and focus adjust options.

Press  on the remote control to confirm the selection.

Press  on the remote control to leave the adjusting section.

	<p>Enlarge/minimise the image optically. Press  on the remote control/top panel to Zoom in. Press  on the remote control/top panel to Zoom out.</p>
	<p>Adjust the clarity and sharpness of the image optically. Press  and  on the remote control/top panel to adjust the focus.</p>



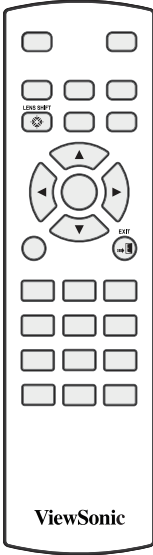

## Lens Shift



Motorized vertical and horizontal lens shift for positioning display image without physically moving the unit.

Press  on the remote control to evoke lens shift adjustment function.



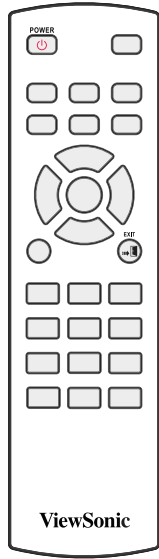

Press  on the remote control to leave the adjusting section.

	<p>Press  on the remote control/top panel to move display image up.</p>
	<p>Press  on the remote control/top panel to move display image down.</p>
	<p>Press  on the remote control/top panel to move display image right.</p>
	<p>Press  on the remote control/top panel to move display image left.</p>

## Power



Power button to turn on or off the projector.

Power ON	Press  on the remote control/top panel to turn on projector.
Power OFF	Press  on the remote control/top panel, it would pop up a confirmation screen showing: "Press Power Button Again to power off." Once this confirmation pops up, Press  on the remote control/top panel again to turn the power off. After lamp cooling cycle is completed, the unit will enter Stand-By mode.
Cancel Power OFF	Press  on the remote control to cancel the power off process, once this confirmation pops up.

## Light

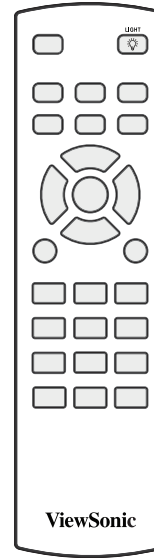

To illuminate remote control keypad backlight.

Light ON, no action	Press  on the remote control to illuminate the remote control keypad backlight. Backlight will automatically switch off after 10 seconds, if no other key is pressed.
Light ON, action	Press any remote control key will illuminate the keypad backlight and calls up the function at the same time. Backlight will automatically switch off after 10 seconds, if no other key is pressed.

# Chapter 4: ADVANCED OPERATION (OSD Menu)

## 1. Main Menu

Press  to enter the main menu (Fig. 1-2).

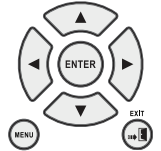
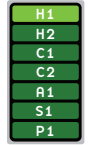









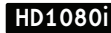

Fig. 1-1  
OSD Navigation Keys

	Press  or  to go to the next input source. Press  to go to the previous input source. Press  to confirm the input source selection.
<b>Input Source Status Indicator:</b>	
	H1 and H2: HDMI input source 1 and 2.
	C1 and C2: Component Video input source 1 and 2.
	A1: Composite Video input source.
	S1: S-Video input source.
	P1: PC VGA input source.
<b>Input Source Content Type:</b>	
	Here displays the source content format, for example HD 1080p, HD 1080i, HD 720p, 480p, 480i, NTSC, PAL or PC resolutions.

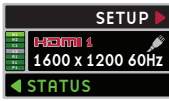









Fig. 1-2  
Main Menu





## 2. Setup Menu

From the Main Menu, press  to enter the Setup Menu (Fig. 2).

Use , ,  and  to navigate the Setup Menu Selections:

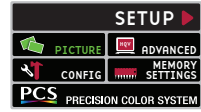

Press  to confirm the Sub-Menu selection.

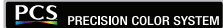
Press  to go to previous menu. Double click  to exit OSD setting.

 <p>Fig. 2 Setup Menu</p>		Picture adjustment Sub-Menu.
		Advanced features adjustment Sub-Menu.
		System Configuration Sub-Menu.
		Memory Settings Sub-Menu.
		PCS Settings Sub-Menu







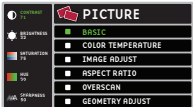



## 2-1. Picture Sub-Menu

Use ▲ and ▼ to navigate the Picture Sub-Menu (Fig. 2-1) Selections:  
 Press  to confirm the Sub-Menu selection.  
 Press  to go to previous menu.

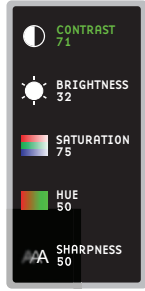

 <p>Fig. 2-1 Picture Sub-Menu</p>	<b>BASIC</b>	Selections of Contrast, Brightness, Saturation, Hue and Sharpness.
	<b>COLOR TEMPERATURE</b>	Selections of Color Temperatures.
	<b>IMAGE ADJUST</b>	Selections of PC timing adjustments.
	<b>ASPECT RATIO</b>	Selections of Screen aspects.
	<b>OVERSCAN</b>	Overscan selections and manual adjustments.
	<b>GEOMETRY ADJUST</b>	Selections of V. Keystone, H. Keystone, Rotation & Auto Keystone On & Off.

## 2-1-1 Basic Sub-Menu

Use ▲ and ▼ to navigate the Basic Sub-Menu Selections.  
 Press  to confirm the Sub-Menu selection.  
 Press  to go to previous menu.

 <p>Fig. 2-1-1 Basic Sub-Menu</p>	 Contrast: Adjust contrast level. Press ► to increase the gain; press ◀ to decrease the gain.
	 Brightness: Adjust brightness level. Press ► to increase the gain; press ◀ to decrease the gain.
	 Saturation: Adjust color saturation level. Press ► to increase the saturation; press ◀ to decrease the saturation.
	 Hue: Adjust green and red balance. Press ► to increase green; press ◀ to increase the red.
	 Sharpness: Adjust the finest of image. Press ► to sharpen the image; press ◀ to soften the image.



## 2-1-2 Color Temperature Sub-Menu

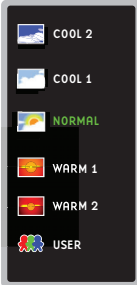



Use ▲ and ▼ to navigate the Color Temperature Sub-Menu Selections.  
 Press  to confirm the Sub-Menu selection.  
 Press  to go to previous menu.

	Cool 2	14,000K color temperature.
	Cool 1	11,000K color temperature.
	Normal	8,500K color temperature.
	Warm 1	6,500K color temperature.
	Warm 2	5,000K color temperature.
	User	Customized color temperature (See page 37 for details see user color setting.).

**Fig. 2-1-2**  
Color Temperature Sub-Menu

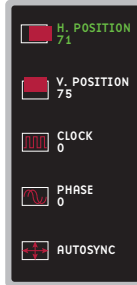
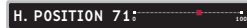
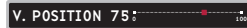
## 2-1-3 Image Adjust Sub-Menu

These functions can only be utilized in PC input.  
 Use ▲ and ▼ to navigate the Image Adjust Sub-Menu Selections.  
 Press  to confirm the Sub-Menu selection.  
 Press  to go to previous menu.

	
	Adjust the horizontal position of image. Press ► to move image to the right; press ◀ to move image to the left.
	
	Adjust the vertical position of image. Press ► to move image upward; press ◀ to move the image downward.
	
	Adjust the clock frequency. Press ► to increase clock freq.; press ◀ to decrease clock freq.
	
Adjust phase timing. Press ► to shift phase to right; press ◀ to shift phase to left.	
	
Synchronize image timing automatically Press  to run the Auto Sync.	

**Fig. 2-1-3**  
Image Adjust Sub-Menu

## 2-1-4 Aspect Ratio

These functions can only be utilized in video inputs.

Use ▲ and ▼ to navigate the Image Adjust Sub-Menu Selections.

Press  to confirm the Sub-Menu selection.

Press  to go to previous menu.

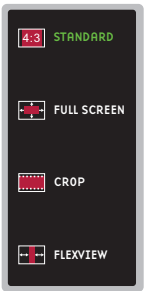
	Standard	Original content aspect ratio
	Full Screen	Full screen by linear stretching.
	Crop	Full screen by cropping.
	Flexview	Full screen by non-linear stretching.

**Fig. 2-1-4**  
Aspect Ratio Sub-Menu



## 2-1-5 Overscan

Overscan controls portions of image being pushed out of the display area.

Use ▲ and ▼ to navigate the Overscan Sub-Menu Selections.

Press  to confirm the Sub-Menu selection.

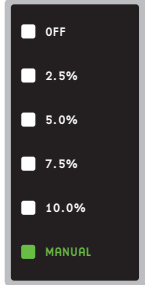
Press  to go to previous menu.

	OFF	No overscan.
	2.5%	2.5% overscan.
	5.0%	5.0% overscan.
	7.5%	7.5% overscan.
	10.0%	10.0% overscan.
		

**Fig. 2-1-5**  
Overscan Sub-Menu

Press ◀ and ▶ to navigate the Manual Overscan selections.  
Press ▲ and ▼ to set overscan portions

## 2-1-6 Geometry Adjust

Adjust image geometry distortion caused by improper placement of projector electronically.

Note: For best video performance, it is highly recommended to correct image distortion by physically correct the placement of the unit.

Use ▲ and ▼ to navigate the Geometry Adjust Sub-Menu Selections.

Press  to confirm the Sub-Menu selection.

Press  to go to previous menu.





	
	Press ◀ and ▶ to set figures of vertical keystone
	
	Press ◀ and ▶ to set figures of horizontal keystone
	
	Press ◀ and ▶ to set figures of rotation
	
	Press ◀ and ▶ to toggle auto vertical keystone on or off.

Fig. 1-6

Geometry Adjust Sub-Menu

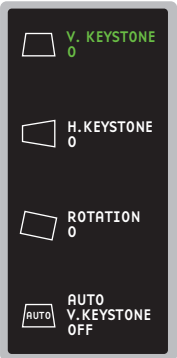
## 2-2. Advanced Sub-Menu

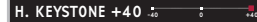
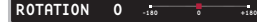
Advanced options for image quality enhancement.

Use ▲ and ▼ to navigate the Advanced features (Fig. 2-2) Selections:

Press  to confirm the Sub-Menu selection.

Press  to go to previous menu.

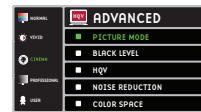
 <p>Fig. 2-2 Advanced Sub-Menu</p>	<b>PICTURE MODE</b>	Selections of Normal, Vivid, Cinema, Professional and User image modes.
	<b>BLACK LEVEL</b>	Selections of Normal, Low, Mid, High and Blacker than Black black-level.
	<b>HQV</b>	Selections of HQV Detail Enhancement, Advanced Film Mode detection, LTI and CTI.
	<b>NOISE REDUCTION</b>	Selections of Motion adaptive HQV Noise Reduction, TNR, MNR and BAR.
	<b>COLOR SPACE</b>	Selections of RGB, YCbCr, YPbPr and Auto color space.

## 2-2-1 Picture Mode

ViewSonic customized presets for various viewing pleasures.

Use ▲ and ▼ to navigate the image Mode (Fig. 2-2-1) Selections.

Press  to confirm the Sub-Menu selection.

Press  to go to previous menu.







		Normal: Image is presented in original content. All special enhancement features are off.
		Vivid: High contrast, richer color and detailed enhancement. Attention: Long time viewing may cause fatigue to the eyes.
		Cinema: Emphasis on enhancements of skin tone performance and cinematic effect.
		Professional: Emphasis on grayscale and color accuracy. Easier viewing condition with tradeoff to contrast and color vividness.
		User: Recall customized settings in user memory.

Fig. 2-2-1  
Image Mode

## 2-2-2 Black Level

Black Level selections for visual brightness levels of the virtual pure black point in video content.

Use ▲ and ▼ to navigate the Black Level Sub-Menu (Fig. 2-2-2). Selections:

Press  to confirm the Sub-Menu selection.

Press  to go to previous menu.







		Normal: Standard NTSC black level. Contents below standard black level will not be visible.
		Low: Portion of color noises reduced at darker grayscales.
		Mid: Majority of color noises reduced at darker grayscales.
		High: All color noises reduced at darker grayscales.
		Blacker than black: Black level is defined at 0 IRE. Image details that are darker than standard black level is visible, resulting in brighter images. Make sure the source content's (such as a DVD player) black level filter is turned off.

Fig. 2-2-2  
Black Level Sub-Menu

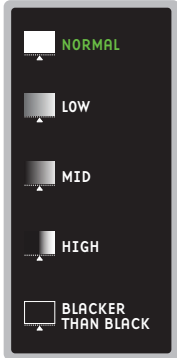
## 2-2-3 HQV

Selections of HQV (Hollywood Quality Video) for further details enhancements, film detecting modes, and luminance level adjustments.

Use ▲ and ▼ to navigate the Basic Sub-Menu (Fig. 2-2-3) Selections.

Press  to confirm the Sub-Menu selection.

Press  to go to previous menu.



**DETAIL ENHANCEMENT** 50 0 100

Detail Enhancement: Enrich details in lower resolution video contents (HD Simulation for SD/ED video.).

Press ► to increase details; press ◀ to lessen details.

**FILM MODE** AUTO VIDEO FILM

Auto: Automatically switch between video and film modes of the video content.

Video: Automatically de-Interlace video signals to achieve optimum viewing quality.

Film: Automatically detects fitting cadence of film for optimum viewing quality.

Press ◀ and ► to select film mode.

Fig. 2-2-3  
HQV Sub-Menu

**LTI** OFF LOW HIGH AUTO

Selections of luminance levels.

Off: No luminance level enhancement.

Low: Low luminance level.

High: High luminance level.

Auto: Automatic luminance level correction.

**CTI** OFF LOW HIGH AUTO

Select the chrominance level.

Off: No chrominance level enhancement.

Low: Low chrominance level.

High: High chrominance level.

Auto: Automatic chrominance level correction.

## 2-2-4 Noise Reduction

HQV technology reduces the irrelevant or noise data (Minimum loss of good data) from signal and creates better viewing quality.

Use ▲ and ▼ to navigate Selections of Noise Reduction Sub-Menu (Fig. 2-2-4).

Press  to confirm the Sub-Menu selection.

Press  to go to previous menu.

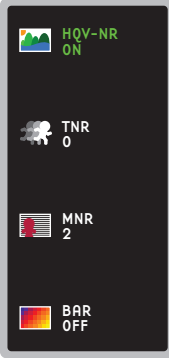

**HQV-NR** OFF ON

To turn On or Off HQV-noise reduction. HQV NR is a per-pixel motion & noise adaptive temporal filter.

**TNR** OFF LOW MEDIUM HIGH

Temporal Recursive Noise Reduction: Filter out the differences by comparing multiple image frames. This technique works best with still image.

Press ► to further reduce noise; press ◀ to restore the original state

Fig. 2-2-4  
Noise Reduction Sub-Menu

**MNR** OFF LOW MEDIUM HIGH

Mosquito Noise Reduction: Reduce noise artifacts around object edges.

Press ► to further reduce noise; press ◀ to restore the original state

**BAR** OFF ON

Block Artifact Removal: Remove block artifact caused by motion image processing.

Select ON to remove artifacts; OFF to restore the original state

## 2-2-5 Color Space

Select the correct color spacing for the given input video format. Wrong selection may result in abnormal color performance. Selections.

Use ▲ and ▼ to navigate Selections of Color Space Sub-Menu (Fig. 2-2-5)

Press  to confirm the Sub-Menu selection.

Press  to go to previous menu.



	<input type="checkbox"/> RGB	For RGB video format. No subsampling. All information is accurately transmitted.
	<input checked="" type="checkbox"/> YCbCr	For component video YCbCr video format. Some subsampling to the color information resulting in reduced transmission with little impact on what is perceived by the viewer. Used in most higher-end digital formats.
	<input type="checkbox"/> YPbPr	For component video YPbPr video format. Best color sampling ratio, used as an intermediate format in high-end film scanners and cinematic production.
	<input type="checkbox"/> AUTO	Automatically choose the most suitable chroma subsampling scheme. Recommended !!

Fig. 2-2-5  
Color Space Sub-Menu

## 2-3 Config Sub-Menu

Configuration options for basic Projector settings

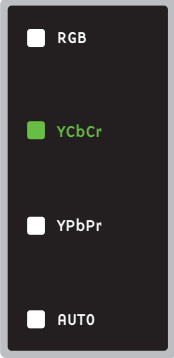
Use ▲ and ▼ to navigate the Config Sub-Menu (Fig. 2-3) Selections.

Press  to confirm the Sub-Menu selection.

Press  to go to previous menu.

	PROJECTOR SETTINGS	Selections of Auto Source, Fixed Sync, Auto Shutdown, Lamp mode, Daylight Sensor and Projection.
	OSD	Selections of OSD Location, Time out and Transparency.
	LANGUAGES	Selections of English, German, French, Spanish, Portuguese, Italian, Russian, Swedish, Finnish, Simplified Chinese & Traditional Chinese.
	TIMERS	Selections of Lamp Timer Reset, Filter Timer Reset & System Time.
	HIGH ALTITUDE	Selections of fan speed for operating at High altitude or Normal environment.
	AUTO IRIS	Selections of automatically adjusting the light output for better contrast performance and feature off.

Fig. 2-3  
Config Sub-Menu  
Projection Front / Desk



## 2-3-1 Projector Settings

Projector Setting selections

Use ▲ and ▼ to navigate Selections of Projector Settings Sub-Menu (Fig. 2-3-1)

Press  to confirm the Sub-Menu selection.

Press  to go to previous menu.

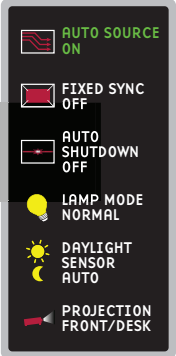

**AUTO SOURCE** OFF ON

Automatically select the next active input source  
Select ON to enable the feature; OFF to disable the feature

**FIXED SYNC** OFF ON

Use default timing data stored in the projector instead of consistent auto sync sampling. Auto sync will cause incorrect image sizing If the on-screen image has black border. The problem is further complicated if the source content's screen resolution is not consistent.

Select ON to enable the feature; OFF to disable the feature

**AUTO SHUTDOWN** 5 15 30 45 60 OFF

Automatically shut down the projector after standby 5 / 15 / 30 / 45 / 60 minutes or feature off.

Fig. 2-3-1

Projector Settings Sub-Menu

**LAMP MODE** NORMAL ECO

Select lamp power efficiency mode  
Normal: Standard mode, maximum lumen and power output  
Eco: Reduced power, less fan noise, and lamp life can be extended.

**DAYLIGHT SENSOR** OFF AUTO MANUAL

Adjust the viewing condition based on ambient light environment  
OFF: Disable the feature  
Auto: Enable the feature and adjust automatically  
Manual: Enable the feature and adjust manually

**MANUAL** LOW MIDDLE HIGH

Manually choose the light rate.  
Low: Dim environment  
Middle: Average light environment  
High: Bright environment

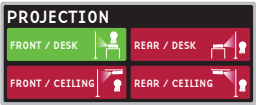

Projection method selections

Use ▲ and ▼ to choose the right projection method.

## 2-3-2 OSD

OSD location

Use ▲ and ▼ to navigate Selections of Projector Settings Sub-Menu (Fig. 2-3-1)

Press  to confirm the Sub-Menu selection.

Press  to go to previous menu.

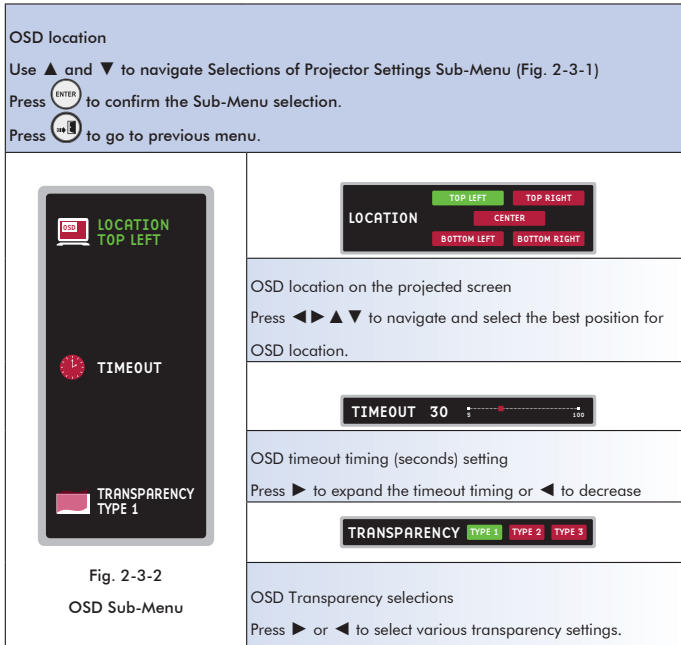

The diagram illustrates the OSD Sub-Menu navigation process. It shows three sequential screens:

- LOCATION TOP LEFT**: The initial OSD location selection screen.
- LOCATION**: A screen with five directional buttons: TOP LEFT (green), TOP RIGHT (red), CENTER (red), BOTTOM LEFT (red), and BOTTOM RIGHT (red). Below this screen, it says "OSD location on the projected screen" and "Press ◀▶▲▼ to navigate and select the best position for OSD location."
- TIMEOUT 30**: A screen showing a slider for the timeout setting, ranging from 5 to 180 seconds. Below this screen, it says "OSD timeout timing (seconds) setting" and "Press ▶ to expand the timeout timing or ◀ to decrease".
- TRANSPARENCY TYPE 1**: A screen showing three transparency options: TYPE 1 (green), TYPE 2 (red), and TYPE 3 (red). Below this screen, it says "OSD Transparency selections" and "Press ▶ or ◀ to select various transparency settings."

**Fig. 2-3-2**  
OSD Sub-Menu

## 2-3-3 Languages

OSD language selections.

Use ▲ and ▼ to navigate the Languages Sub-Menu (Fig. 2-3-3) Selections.

Press  to confirm the Sub-Menu selection.

Press  to go to previous menu.

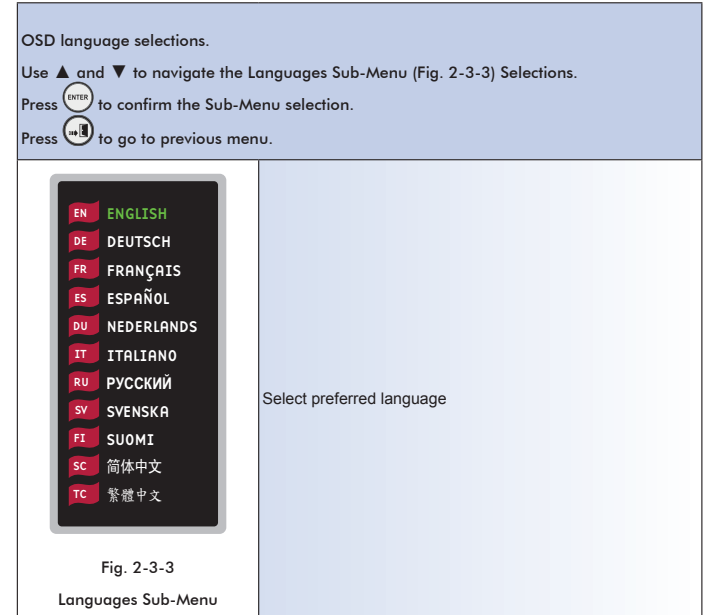

The diagram illustrates the Languages Sub-Menu selection process. It shows two sequential screens:

- Languages List**: A screen displaying a list of languages with their corresponding codes: EN (ENGLISH), DE (DEUTSCH), FR (FRANÇAIS), ES (ESPAÑOL), DU (NEDERLANDS), IT (ITALIANO), RU (РУССКИЙ), SV (SVENSKA), FI (SUOMI), SC (简体中文), and TC (繁體中文). Below this screen, it says "Select preferred language".
- OSD language selections**: A screen where the user can navigate and select a preferred language.

**Fig. 2-3-3**  
Languages Sub-Menu

## 2-3-4 Timers

Timer settings

Use ▲ and ▼ to navigate the Timers Sub-Menu (Fig. 2-3-4) Selections.

Press  to confirm the Sub-Menu selection.

Press  to go to previous menu.





	
	<p>Reset Lamp timer. Reset Lamp timer after each replacement of new lamp.</p> <p>This timer is for user's own tracking purpose; the lamp warranty time will not be renewed by this act. (See section ??? for lamp warranty details.)</p>
	
	<p>Reset filter Timer. Reset filter timer after each cleaning or replacement of new filter.</p>
	
	<p>Total Projector operating time (Operating timer cannot be changed by user).</p>

Fig. 2-3-4

Timers Sub-Menu

## 2-3-5 High Altitude

Using Projector in high altitude. Projector fan spins faster to accommodate the low-atmospheric pressure environment.

Use ▲ and ▼ to navigate Selections of High Altitude Sub-Menu (Fig. 2-3-5).

Press  to confirm the Sub-Menu selection.

Press  to go to previous menu.



		<p>ON: Projector is used in high altitude. High fan speed mode.</p>
		<p>OFF: Projector is not used in high altitude. Normal fan speed mode.</p>

Fig. 2-3-5

High Altitude Sub-Menu

## 2-3-6 Auto Iris

Automatically control the portion of projected light to increase contrast and transition speed

Use ▲ and ▼ to navigate Selections of Auto Iris Sub-Menu (Fig. 2-3-6).

Press  to confirm the Sub-Menu selection.

Press  to go to previous menu.





 		Enable Auto Iris feature
		Disable Auto Iris feature

Fig. 2-3-6  
Auto Iris Sub-Menu

## 2-4 PCS Settings Sub-Menu

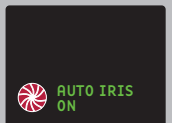
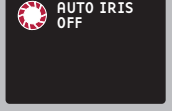
PCS Setting selections

Use ▲ and ▼ to navigate Selections of PCS Setting Sub-Menu (Fig. 2-4)

Press  to confirm the Sub-Menu selection.

Press  to go to previous menu.

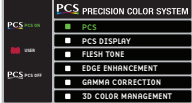
 <p>Fig. 2-4 PCS Settings Sub-Menu</p>	PCS	Precision Color System
	PCS DISPLAY	Split screen for Precision Color System comparison
	FLESH TONE	Skin tone correction
	EDGE ENHANCEMENT	Emphasis on image edges
	GAMMA CORRECTION	Personalized gamma correction.
	3D COLOR MANAGEMENT	Advanced colors enhancement management.

## 2-4-1 PCS

PCS image management

Use ▲ and ▼ to navigate Selections of PCS Sub-Menu (Fig. 2-4-1)

Press  to confirm the Sub-Menu selection.

Press  to go to previous menu.





	
	Enable all default PCS settings
	
	Customized PCS settings.
	
Disable all PCS enhancement settings	

Fig. 2-4-1  
PCS Settings Sub-Menu

## 2-4-2 PCS Display

PCS display selections:

Use ▲ and ▼ to navigate Selections of PCS display Sub-Menu (Fig. 2-4-2)

Press  to confirm the Sub-Menu selection.

Press  to go to previous menu.





		Split screen Left half – PCS enabled screen Right half – PCS disabled screen
		Motion screen Left portion of the bar – PCS enabled screen Right portion of the bar – PCS disabled screen
		PCS display off PCS enabled in full screen
	(Empty space)	(Empty space)

Fig. 2-4-2  
PCS display Sub-Menu

## 2-4-3 Flesh tone

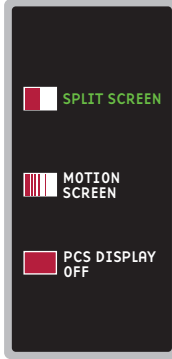
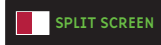
Skin tone correction

Use ▲ and ▼ to navigate Selections of Flesh tone Sub-Menu (Fig. 2-4-3) Selections.

Press  to confirm the Sub-Menu selection.

Press  to go to previous menu.



The interface for the Flesh tone Sub-Menu is shown. On the left is a vertical black bar with a green square and the word "SELECT" in green. On the right is a control panel with three sliders. The top slider is labeled "EFFECTIVE AREA" and has a value of 50. The middle slider is labeled "HUE" and has a value of 50. The bottom slider is labeled "COLOR" and has a value of 50. Above the sliders, there are two color swatches: an orange one labeled "BEFORE" and a yellow one labeled "AFTER", with a double-headed red arrow between them.

Effective Area: The affected color range adjustment.  
Press ► to increase range; press ◀ to decrease range.

Hue: Gradation adjustment of the output color  
Press ► or ◀ to adjust the selected color

Color: Saturation adjustment of the output color  
Color – Press ► for richer color or ◀ for less saturated color

Fig. 2-4-3  
Flesh tone Sub-Menu

## 2-4-4 Edge Enhancement

Adjustment of image outline edge thickness

Use ▲ and ▼ to navigate Selections of Edge Enhancement Sub-Menu (Fig. 2-4-4).

Press  to confirm the Sub-Menu selection.

Press  to go to previous menu.

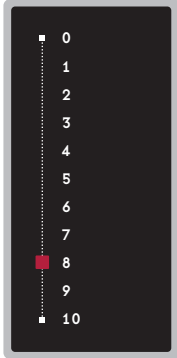

The interface for the Edge Enhancement Sub-Menu is shown. It consists of a vertical black bar with a list of numbers from 0 to 10. A red square is positioned next to the number 8, indicating the current selection.

Press ▲ to increase outline thickness or ▼ or to decrease outline thickness.

Fig. 2-4-4  
Edge Enhancement Sub-Menu

## 2-4-5 Gamma Correction

Gamma selections and custom adjustments.

Use ▲ and ▼ to navigate Selections of Gamma Correction Sub-Menu (Fig. 2-4-5).

Press  to confirm the Sub-Menu selection.

Press  to go to previous menu.



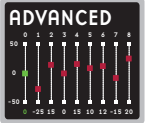

Advanced option: 9 segments of gamma correction for customization.

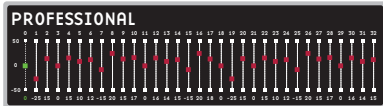

Professional option: 33 segments of gamma correction for customization.

**Fig. 2-4-5**  
Gamma Correction Sub-Menu

## 2-4-6 3D Color Management

Advanced color management. Isolated color correction only affects the selected color.

Use ▲ and ▼ to navigate Selections of 3D Color Management Sub-Menu (Fig. 2-4-6).

Press  to confirm the Sub-Menu selection.

Press  to go to previous menu.

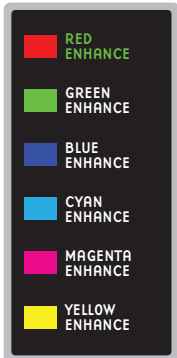

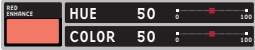

Red color Enhancement

Hue – Press ► for more yellowish or ◀ for magenta tone

Color – Press ► for richer color or ◀ for less saturated color

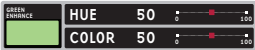

Green color Enhancement

Hue – Press ► for a more cyanic or ◀ for yellowish tone

Color – Press ► for richer color or ◀ for less saturated color

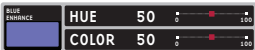



Blue color Enhancement



Hue – Press ► for more magenta or ◀ for cyanic tone

Color – Press ► for richer color or ◀ for less saturated color

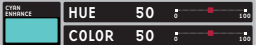
**Fig. 2-4-6**  
3D Color Management Sub-Menu

## 2-5 Memory Settings Sub-Menu

<p>Cyan color Enhancement</p> <p>Hue – Press ► for a more bluish or ◀ for greenish tone</p> <p>Color – Press ► for richer color or ◀ for less saturated color</p>

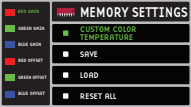
<p>Magenta color Enhancement</p> <p>Hue – Press ► for more reddish or ◀ for bluish tone</p> <p>Color – Press ► for richer color or ◀ for less saturated color</p>

<p>Yellow color Enhancement</p> <p>Hue – Press ► for a more reddish or ◀ for greenish tone</p> <p>Color – Press ► for richer color or ◀ for less saturated color</p>

<p>Use ▲ and ▼ to navigate the Memory Settings (Fig. 2-5) Selections.</p> <p>Press  to confirm the Sub-Menu selection.</p> <p>Press  to go to previous menu.</p>		
 <p>Fig. 2-5 Memory Settings Sub-Menu</p>	<p>CUSTOM COLOR TEMPERATURE</p>	<p>Customized color temperature settings</p>
	<p>SAVE</p>	<p>2 slots for saving changed items. All changes should be saved in memory for future use.</p>
	<p>LOAD</p>	<p>2 slots for loading changed items. Load previously saved customized data. All customized data can be utilized under “User” section of each adjustment.</p>
	<p>RESET ALL</p>	<p>Resetting all ViewSonic defaults. Customized Data will not be overwritten. It can still be recalled by “Load” data option.</p>



## 2-5-1 Custom Color Temperature

Customize color temperature adjustment. This defines color temperature in white balance and offset colors.

Use ▲ and ▼ to navigate through Custom Color Temperature (Fig. 2-5-1) Selections.

Press  to confirm the Sub-Menu selection.

Press  to go to previous menu.







 <p>RED GAIN</p> <p>GREEN GAIN</p> <p>BLUE GAIN</p> <p>RED OFFSET</p> <p>GREEN OFFSET</p> <p>BLUE OFFSET</p>	 <p>Blue color temperature customization</p> <p>Gain – press ► for lighter or ◀ for darker tone at brighter scenes</p>
	 <p>Blue color temperature customization</p> <p>Offset – press ► for lighter or ◀ for darker tone at darker scenes</p>
	 <p>Green color temperature customization</p> <p>Gain – press ► for lighter or ◀ for darker tone at brighter scenes</p>

Fig. 2-5-1  
Custom Color Temperature  
Sub-Menu

 <p>Green color temperature customization</p> <p>Offset – press ► for lighter or ◀ for darker tone at darker scenes</p>
 <p>Red color temperature customization</p> <p>Gain – press ► for lighter or ◀ for darker tone at brighter scenes</p>
 <p>Red color temperature customization</p> <p>Offset – press ► for lighter or ◀ for darker tone at darker scenes</p>

## 2-5-2 Save

Saving Changed Items

Use ▲ and ▼ to navigate the Saving (Fig. 2-5-2) Selections.

Press  to confirm the Sub-Menu selection.

Press  to go to previous menu.





Fig. 2-5-2  
Save Sub-Menu

## 2-5-3 Load

Loading changed items

Use ▲ and ▼ to navigate the Loading (Fig. 2-5-3) Selections.

Press  to confirm the Sub-Menu selection.

Press  to go to previous menu.

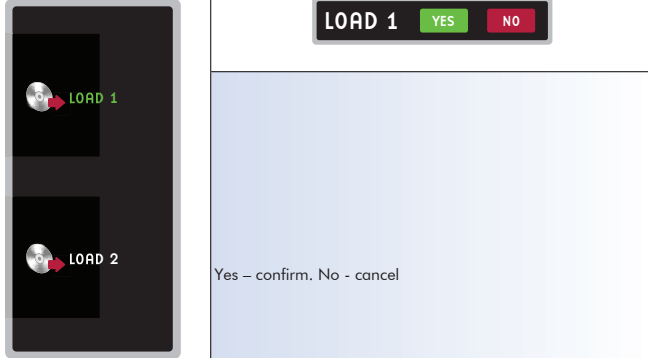



Fig. 2-5-3  
Load Sub-Menu

## 2-5-4 Reset

Resets of ViewSonic defaults

Use ▲ and ▼ to navigate the Reset (Fig. 2-5-4) Selections.

Press  to confirm the Sub-Menu selection.

Press  to go to previous menu.





		<p>Yes – confirm.</p>
---	---	-----------------------

Fig. 2-5-4  
Reset Sub-Menu

## 2-5-5 System Status Screen

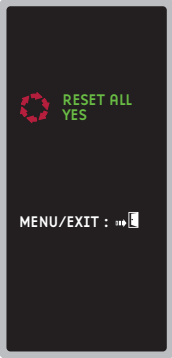
Press  on the remote control to call up the main menu screen (Fig. 2-5-5-1).

Press  on the remote control/side panel to bring up the system status bar (Fig. 2-5-5-1).

The status screen will remain active until it is closed by user.

Press  on the remote control/side panel again to close the system status bar.

Press  on the remote control to close the main menu.























		<p>Lamp timer: Can be reset by user (Refer to timer reset in section 2-3-4). Lamp usage time counter.</p>
		<p>0 ~ 2500hrs: Normal status.</p>
		<p>2501 ~ 3000hrs: Near lamp life time. Place new order of lamp.</p>
		<p>3001hrs or more: Over lamp life time. Please replace with new lamp.</p>
		<p>Filter status, display if filter needs to be cleaned/changed</p>
		

Fig. 2-5-5-1

Fig. 2-5-5-2  
Status Bar

	Daylight sensor status: Indication if daylight sensor is active.
	Auto: Daylight sensor is in automatic mode. Manual: Manually select daylight sensor mode.
	Off: Daylight sensor disabled.
	Precision Color System status, display if PCS is in use On – ViewSonic defined PCS enabled Off – PCS disabled User – User define PCS settings.
	
	

	Picture mode: Indication of current picture mode selection. Picture mode include: Normal, Vivid, Cinema, Professional and User.
	
	
	
	

	<p>System temperature status, display if system is operating under ideal temperature:</p> <p>Normal – System under ideal operating temperature.</p>
	<p>Caution – System is above normal but below critical. Recommend to check setup environment to return operation temperature to normal.</p> <p>Warning – System temperature above recommend level, please shut down the projector and let it cool down to room temperature before further usage.</p>
	<p>If temperature is above critical level, system will automatically shut down.</p>
	<p>F/W version</p>

## Maintenance

The projector needs proper maintenance. You should keep the lens clean as dust, dirt or spots will project on the screen and diminish image quality. If any other parts need replacing, contact your dealer or qualified service personnel. When cleaning any part of the projector, always switch off and unplug the projector first.

### Warning:

Never open any of the covers on the projector. Dangerous electrical voltages inside the projector can cause severe injury. Do not attempt to service this product yourself. Refer all servicing to qualified service personnel.

## Cleaning the Lens

Gently wipe the lens with Micro-fiber wiping cloth. Do not touch the lens with your hands.

## Cleaning the Projector Housing

Gently wipe with a soft cloth. If dirt and stains are not easily removed, use a soft cloth dampened with water, or water and neutral detergent, and wipe dry with a soft, dry cloth.

## Maintaining the Air Filter

The air filter, which is located at the back of the projector, should be replaced or cleaned when warned by system either because 200 hours of use or rise of internal temperature. If it is not cleaned periodically, it can become clogged with dust and prevent the projector from being ventilated properly. This can cause over heating and damage the projector.

### To clean the air filter:

1. Pull down the filter module cover.
2. Remove the filter module cover.
3. Remove the dirty filter directly.
4. Attach the clean air-filter.
5. Attach the filter cover to the projector.

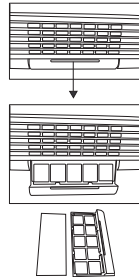

## Replacing the Air Filter

The air filter should be replaced when cleaning is ineffective contact an authorized service center for the optional air filter.

### « NOTE »

- Turn off the projector and remove the AC power cord from the power outlet before beginning maintenance work.
- Make sure the lens is cool before cleaning.
- Do not use detergents or chemicals other than those noted above. Do not use benzene or thinners.
- Do not use chemical sprays.
- Use a soft cloth or lens paper only.

## Replacing the Lamp

Projector lamps have a finite life. Replace the lamp when:

- A warning message “Lamp is approaching the end of its useful life in full power operation. Replacement suggested!” appears on the screen.
- The image becomes darker and hues become weaker after a lamp has been for a long period of time.
- The projector lamp LED indicator turns into amber. Refer to section titled “LED Indicator Messages” for further details.

### « NOTE »

- The lamp will remain in high temperature even after the projector’s power is turned off. Wait for at least 45 minutes after power off to cool down the lamp. Touching the lamp prior proper cool down time can cause skin scalding.
- Do not touch any glass portion of the lamp at any time. The lamp may explode due to improper handling or grease generated from finger.
- Lamp lifetime may differ from lamp to lamp and according to the environment of use. There is no guarantee of the same lifetime for each lamp. Some lamps may fail or terminate their lifetime in a shorter period of time than other similar lamps.
- A lamp may explode as a result of vibration, shock or degradation as a result of hours of use as its lifetime draws to an end. Risk of explosion may differ according to the environment or conditions in which the projector and lamp are being used.
- Wear protective gloves and eyeglasses when fixing or detaching the lamp.
- Short on-off-cycles will damage the lamp and reduce lamp life. Wait at least for 7 minutes to turn off the projector after powering on.
- Do not operate the lamp in proximity to paper, cloth, or other combustible material nor cover it with such materials. Otherwise it could cause a fire.
- Do not operate the lamp in an atmosphere containing an inflammable substance, such as thinner. Otherwise it could cause a fire or explosion.
- Thoroughly ventilate the area or the room when operating the lamp in an oxygen atmosphere (in the air). If ozone is inhaled, it could cause headaches, nausea, dizziness, etc.

- The lamp contains inorganic mercury. If the lamp bursts, the mercury inside the lamp will go out of the projector. Leave the area immediately if the lamp shatters while being operated and ventilate the area for at least 30 minutes in order to avoid the inhalation of mercury fumes. Otherwise it could be harmful to user's health.

#### To replace the lamp:

1. Loosen the two screws of lamp cover.
2. Remove the lamp cover.
3. Loosen the two screws of lamp module.
4. Pull out the old lamp module by lamp handle.
5. Mount the new lamp.
6. Replace the lamp cover.
7. Reset the lamp timer.

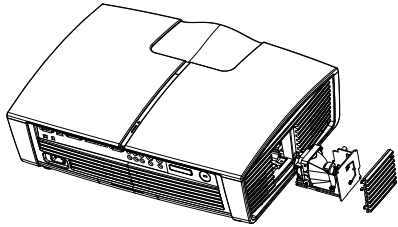

#### « NOTE »

- Dispose of the used lamp according to local regulations.
- Ensure that screws are tightened properly. Screws not tightened fully may result in injury or accidents.
- Since the lamp is made of glass, do not drop the unit and do not scratch the glass.
- Do not reuse the old lamp. This could cause the lamp to explode.
- Be sure to turn off the projector and unplug the AC power cord before replacing the lamp.
- Do not use the projector with the lamp cover removed.

# Appendix

## Troubleshooting

If you think something is wrong, check the followings before contacting customer service.

If This Happens	Check
No power	<ul style="list-style-type: none"> <li>* Is the power cord or battery pack plugged in?</li> <li>* Is it connected to the projector?</li> </ul>
Power is lost during use	<ul style="list-style-type: none"> <li>* Is the ambient temperature high?</li> <li>* Is the air intake or air exhaust blocked?</li> </ul>
No picture	<ul style="list-style-type: none"> <li>* Is the projector turned on?</li> <li>* Are the connections set up correctly?</li> <li>* Are all the connected devices functioning properly?</li> </ul>
Picture not displayed correctly	<ul style="list-style-type: none"> <li>* Is the input signal supported by the projector? ,</li> <li>* Is something generating an abnormal video signal, for instance the video tape?</li> </ul>
Picture blurred Part of picture out of focus	<ul style="list-style-type: none"> <li>* Is the lens dirty?</li> <li>* Is the lens focus adjusted optimally?</li> <li>* Is the projection distance within the projector's supported range?</li> <li>* Is the projector's screen placement angle tilted too far?</li> <li>* Are the sharpness or sampling phase adjustments off?</li> </ul>
Colors too light	<ul style="list-style-type: none"> <li>* Are the color or tint, adjustments off?</li> </ul>
Bad shading	<ul style="list-style-type: none"> <li>* Is the screen dirty?</li> </ul>

## List of Compatible Signals

Analog PC timing			
Mode	Resolution	V-Sync	H Sync
VGA	640 x 480	50 Hz	24.69 kHz
DOS/Text mode visible	640 x 480	60 Hz	31.5 kHz
	640 x 480	72 Hz	37.9 kHz
	640 x 480	75 Hz	37.5 kHz
	640 x 480	85 Hz	43.3 kHz
SVGA	800 x 600	50 Hz	30.99 kHz
	800 x 600	56 Hz	35.2 kHz
	800 x 600	60 Hz	37.9 kHz
	800 x 600	72 Hz	48.1 kHz
	800 x 600	75 Hz	46.9 kHz
	800 x 600	85 Hz	53.7 kHz
XGA	1024 x 768	50 Hz	39.63 kHz
	1024 x 768	60 Hz	48.4 kHz
	1024 x 768	70 Hz	56.5 kHz
	1024 x 768	75 Hz	60.0 kHz
	1024 x 768	85 Hz	68.7 kHz
WXGA	1280x768	60 Hz	47.8 kHz
SXGA	1280 x 1024	64.0 kHz	60 Hz
	1280 x 1024	80.0 kHz	75 Hz



Coordinated Video Timing	640 x 480	67 Hz	35 kHz
	832 x 624	75 Hz	49.72 kHz
	1024 x 768	75 Hz	60.24 kHz
Others	1280 x 720	60 Hz	45.1 kHz
	1280 x 800	60 Hz	49.7 kHz
	1280 x 800	75 Hz	62.8 kHz
	1280 x 800	85 Hz	71.6 kHz
	1360 x 768	60 Hz	47.7 kHz
	1400 x 1050	60 Hz	65.3 kHz
	1440 x 900	60 Hz	55.9 kHz
	1600 x 1200	60 Hz	75 kHz
	1680 x 1050	60 Hz	65.3 kHz
	1920 x 1080	60 Hz	33.8 kHz
	1920 x 1080	60 Hz	67.5 kHz

Digital PC timing (HDMI)			
Mode	Resolution	V-Sync	H Sync
VGA (DOS/Text mode visible)	640 x 480	60 Hz	31.5 kHz
480p	720 x 483	60 Hz	31.5 kHz
SVGA	800 x 600	60 Hz	37.9 kHz
XGA	1024 x 768	60 Hz	48.4 kHz
720p	1280 x 720	60 Hz	45 kHz
WXGA	1280 x 768	60 Hz	47.8 kHz

SXGA	1280 x 1024	60 Hz	64.0 kHz
SXGA+	1400 x 1050	60 Hz	65.3 kHz
WSXGA+	1680 x 1050	60 Hz	65.3 kHz
1080i	1920 x 1080	60 Hz	33.8 kHz
1080p	1920 x 1080	60 Hz	67.5 kHz
UXGA	1600 x 1200	60 Hz	75 kHz
Others	1280 x 800	60 Hz	49.7 kHz
	1280 x 960	60 Hz	60.0 kHz
	1360 x 768	60 Hz	47.7 kHz
	1440 x 900	60 Hz	55.9 kHz

Compatible/Supportive timing			
Note: the Projector may need minor adjustment in the OSD to get optimized performance, when below video signals is input to it through the HDMI connector.			
480i60	720x480	60	15.8k
480p60	720x480	60	31.5k
576i50	720x576	50	15.6k
576p50	720x576	50	31.3k
720p50	1280x720	50	37.5k
720p60	1280x720	60	45.0k
1080i50	1920x1080	50	28.1k
1080i60	1920x1080	60	33.8k
1080p50 (Native)	1920x1080	50	56.3k
1080p60 (Native)	1920x1080	60	67.5k

## LED Indicator Message

Power LED	Status LED	Indicates
Blinking in Green	Off	Standby mode
Green	Green	Warming up
Green	Off	Projector ON.
Green	Blinking in Green	Cooling down
Orange	Green	In-proper shutdown due to power cut off.
Orange	Off	A certain error has been detected.
Orange	Red	Over temp.
Orange	Blinking in Red	Lamp error.

## Product Specification

Display type	3 x 0.74-inch LCD projector
Resolution	1920 x 1080 (1.07 Billion Colors)
F #	F = 1.83 – 2.36
Focal Length	f = 23.5 to 37.6 mm
Focus / Zoom	Motorized / Motorized 1.6x
Lens shift	Vertical: ±75% Horizontal: ±5%
Projection distance	40" – 300"
Computer input	Analog RGB, D-sub 15 pin
Video input	HDMIx2, Component video (YCbCr/YPbPr)x2, Composite videox1, S-Videox1.
Other terminals	RS-232, USB, DC 5V, DC 12V trigger
Computer Compatibility	Please refer to timing table above.
Video Compatibility	NTSC, PAL, SECAM, 1080i/p, 720p, 576i/p, 480i/p
Scanning Frequency	
Horizontal Frequency	15-100kHz
Vertical Frequency	50 - 90Hz
Operating temperature	+41°F (+5°C) to +95°F (+35°C)
Rated voltage	100–120VAC/220–240VAC (Auto Switching)
Dimension (W x H x D)	537 x 170 x 389mm
Weight	19.85 lbs (Approx. 9kg)

## RS232 command code

## 1. Protocol Setting

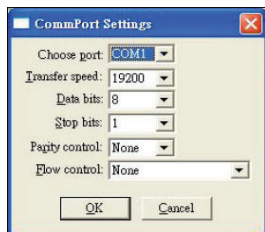

## 2. Power ON/OFF command

Command	Send String (HEX)												
Power ON	BE	EF	10	05	00	C6	FF	11	11	01	00	01	00
Power OFF	BE	EF	02	06	00	57	D0	2E	00	00	00	00	00

## 3. Source select command

Computer ( Analog RGB 1)													
Send String (HEX)	BE	EF	02	06	00	0B	D2	32	00	00	00	00	00
Component 1													
Send String (HEX)	BE	EF	02	06	00	DA	D3	33	00	00	00	00	00
Component 2													
Send String (HEX)	BE	EF	02	06	00	85	DA	5C	00	00	00	00	00
S-Video													
Send String (HEX)	BE	EF	02	06	00	6D	D2	34	00	00	00	00	00
Composite Video													
Send String (HEX)	BE	EF	02	06	00	BC	D3	35	00	00	00	00	00

HDMI-1													
Send String (HEX)	BE	EF	02	06	00	8F	D3	36	00	00	00	00	00
HDMI-2													
Send String (HEX)	BE	EF	02	06	00	5E	D2	37	00	00	00	00	00

## 4. Key-Pad &amp; IR command

Command	Send String (HEX)												
Picture mode	BE	EF	02	06	00	3B	D9	42	00	00	00	00	00
Color Temp.	BE	EF	02	06	00	EA	D8	43	00	00	00	00	00
Aspect Ratio	BE	EF	02	06	00	5D	D9	44	00	00	00	00	00
Menu	BE	EF	02	06	00	8C	D8	45	00	00	00	00	00
Exit	BE	EF	02	06	00	BF	D8	46	00	00	00	00	00
Up	BE	EF	02	06	00	6E	D9	47	00	00	00	00	00
Down	BE	EF	02	06	00	91	D9	48	00	00	00	00	00
Left	BE	EF	02	06	00	40	D8	49	00	00	00	00	00
Right	BE	EF	02	06	00	73	D8	4A	00	00	00	00	00
PCS	BE	EF	02	06	00	A2	D9	4B	00	00	00	00	00
Daylight Sensor	BE	EF	02	06	00	15	D8	4C	00	00	00	00	00
Overscan	BE	EF	02	06	00	C4	D9	4D	00	00	00	00	00
Black level	BE	EF	02	06	00	F7	D9	4E	00	00	00	00	00
HQV	BE	EF	02	06	00	26	D8	4F	00	00	00	00	00
Freeze	BE	EF	02	06	00	49	DA	50	00	00	00	00	00
Input	BE	EF	02	06	00	98	DB	51	00	00	00	00	00
V/H keystone	BE	EF	02	06	00	AB	DB	52	00	00	00	00	00

## 5. Special command

Command	Send String (HEX)											
Lens shift Right	BE	EF	02	06	00	54	DB	5D	00	00	00	00
Lens shift Left	BE	EF	02	06	00	67	DB	5E	00	00	00	00
Lens shift Up	BE	EF	02	06	00	B6	DA	5F	00	00	00	00
Lens shift Down	BE	EF	02	06	00	B9	DF	60	00	00	00	00
Focus +	BE	EF	02	06	00	E3	DA	5A	00	00	00	00
Focus -	BE	EF	02	06	00	32	DB	5B	00	00	00	00
Zoom +	BE	EF	02	06	00	68	DE	61	00	00	00	00
Zoom -	BE	EF	02	06	00	5B	DE	62	00	00	00	00

## 6. Data get

Command	Send String (HEX)																
	Byte 0 ~ Byte 11						Byte12 ~ Byte18										
Error Code Get	BE	EF	1A	0C	00	7A	46	4F	00	01	00	00	00	00	00	00	00
Filter Counter Get	BE	EF	1A	0C	00	91	93	50	00	01	00	00	00	00	00	00	00
Temp Get	BE	EF	1A	0C	00	52	6E	51	00	01	00	00	00	00	00	00	00
Lamp Life Get	BE	EF	1A	0C	00	56	6A	52	00	01	00	00	00	00	00	00	00
Unit on time Get	BE	EF	1A	0C	00	89	8B	5A	00	01	00	00	00	00	00	00	00
Return	1E	--	--	--	--												

## Remote control code

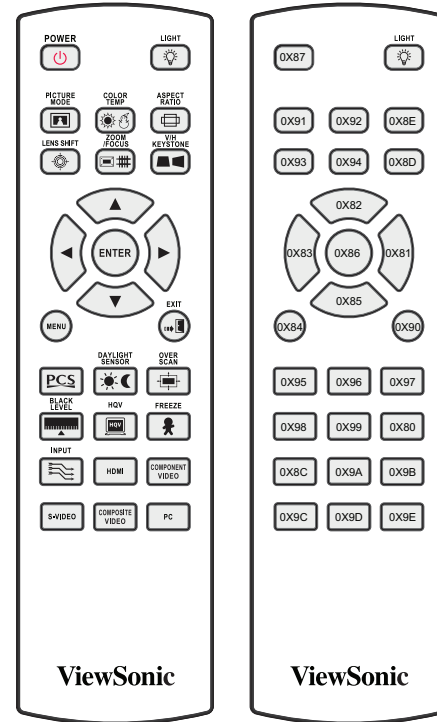

Code Protocol Type: NEC format

## Customer Support

For technical support or product service, see the table below or contact your reseller.

**Note :** You will need the product serial number.

Country/Region	Web Site	T=Telephone F=Fax	E-mail
Australia/New Zealand	www.viewsonic.com.au	AUS=1800 880 818 NZ=0800 008 822	service@au.viewsonic.com
Canada	www.viewsonic.com	T= 1-866-463-4775 F= 1-909-468-5814	service.ca@viewsonic.com
Europe/Middle East/Baltic countries/ North Africa	www.viewsoniceurope.com	Contact your reseller	
Hong Kong	www.hk.viewsonic.com	T= 852 3102 2900	service@hk.viewsonic.com
India	www.in.viewsonic.com	T= 1800 11 9999	service@in.viewsonic.com
Korea	www.kr.viewsonic.com	T= 080 265 9080	service@kr.viewsonic.com
Latin America (Argentina)	www.viewsonic.com/la/	T= 0800-666-0098 F= 1-909-444-5655	soporte@viewsonic.com
Latin America (Brazil)	www.viewsonic.com/la/	T= 0800-891-1829 F= 1-909-444-5655	soporte@viewsonic.com
Latin America (Chile)	www.viewsonic.com/la/	T= 800-440303 F= 1-909-444-5655	soporte@viewsonic.com
Latin America (Columbia)	www.viewsonic.com/la/	T= 01800-9-156588 F= 1-909-444-5655	soporte@viewsonic.com
Latin America (Mexico)	www.viewsonic.com/la/	T= 001-866-823-2004 F= 1-909-444-5655	soporte@viewsonic.com
Renta y Datos, 29 SUR 721, COL. LA PAZ, 72160 PUEBLA, PUE. Tel: 01 222 891 55 77 CON 10 LINEAS Electros, Av Reforma No. 403Gc39 y 41, 97000 Merida, Yucatan. Tel: 01 999 925 19 16 Other places please refer to <a href="http://www.viewsonic.com/la/soporte/index.htm#Mexico">http://www.viewsonic.com/la/soporte/index.htm#Mexico</a>			
Latin America (Peru)	www.viewsonic.com/la/	T= 0800-53311 F= 1-909-444-5655	soporte@viewsonic.com
Macau	www.hk.viewsonic.com	T= 853 700 303	service@hk.viewsonic.com
Puerto Rico & Virgin Islands	www.viewsonic.com	T= 1-800-688-6688 (English) T= 1-866-379-1304 (Spanish) F= 1-909-468-1202	service.us@viewsonic.com soporte@viewsonic.com
Singapore/Malaysia/Thailand	www.ap.viewsonic.com	T= 65 6461 6044	service@sg.viewsonic.com
South Africa	www.viewsoniceurope.com	www.viewsoniceurope.com/uk/Support/Calldesk.htm	
United Kingdom	www.viewsoniceurope.com/uk/	www.viewsoniceurope.com/uk/Support/Calldesk.htm	
United States	www.viewsonic.com	T= 1-800-688-6688 F= 1-909-468-1202	service.us@viewsonic.com

## Limited Warranty

### VIEWSONIC® PROJECTOR

#### What the warranty covers:

ViewSonic warrants its products to be free from defects in material and workmanship, under normal use, during the warranty period. If a product proves to be defective in material or workmanship during the warranty period, ViewSonic will, at its sole option, repair or replace the product with a like product. Replacement product or parts may include remanufactured or refurbished parts or components.

#### How long the warranty is effective:

**North and South America:** 3 years for all parts excluding the lamp, 3 years for labor, 1 year for the original lamp from the date of the first consumer purchase.

**Europe:** 3 years for all parts excluding the lamp, 3 years for labor, 1 year for the original lamp from the date of the first consumer purchase.

**Other regions or countries:** Please check with your local dealer or local ViewSonic office for the warranty information.

Lamp warranty subject to terms and conditions, verification and approval. Applies to manufacturer's installed lamp only.

All accessory lamps purchased separately are warranted for 90 days.

#### Who the warranty protects:

This warranty is valid only for the first consumer purchaser.

#### What the warranty does not cover:

- Any product on which the serial number has been defaced, modified or removed.
- Damage, deterioration or malfunction resulting from:
  - Accident, misuse, neglect, fire, water, lightning, or other acts of nature, unauthorized product modification, or failure to follow instructions supplied with the product.
  - Repair or attempted repair by anyone not authorized by ViewSonic.
  - Any damage of the product due to shipment.
  - Removal or installation of the product.
  - Causes external to the product, such as electric power fluctuations or failure.
  - Use of supplies or parts not meeting ViewSonic's specifications.
  - Normal wear and tear.
  - Any other cause which does not relate to a product defect.
- Any product exhibiting a condition commonly known as "image burn-in" which results when a static image is displayed on the product for an extended period of time.
- Removal, installation, and set-up service charges.

#### How to get service:

- For information about receiving service under warranty, contact ViewSonic Customer Support (please refer to "Customer Support" page). You will need to provide your product's serial number.
- To obtain warranted service, you will be required to provide (a) the original dated sales slip, (b) your name, (c) your address, (d) a description of the problem, and (e) the serial number of the product.

3. Take or ship the product freight prepaid in the original container to an authorized ViewSonic service center or ViewSonic.
4. For additional information or the name of the nearest ViewSonic service center, contact ViewSonic.

**Limitation of implied warranties:**

There are no warranties, express or implied, which extend beyond the description contained herein including the implied warranty of merchantability and fitness for a particular purpose.

**Exclusion of damages:**

ViewSonic's liability is limited to the cost of repair or replacement of the product. ViewSonic shall not be liable for:

1. Damage to other property caused by any defects in the product, damages based upon inconvenience, loss of use of the product, loss of time, loss of profits, loss of business opportunity, loss of goodwill, interference with business relationships, or other commercial loss, even if advised of the possibility of such damages.
2. Any other damages, whether incidental, consequential or otherwise.
3. Any claim against the customer by any other party.

**Effect of state law:**

This warranty gives you specific legal rights, and you may also have other rights which vary from state to state. Some states do not allow limitations on implied warranties and/or do not allow the exclusion of incidental or consequential damages, so the above limitations and exclusions may not apply to you.

**Sales outside the U.S.A. and Canada:**

For warranty information and service on ViewSonic products sold outside of the U.S.A. and Canada, contact ViewSonic or your local ViewSonic dealer.

The warranty period for this product in mainland China (Hong Kong, Macao and Taiwan Excluded) is subject to the terms and conditions of the Maintenance Guarantee Card.

For users in Europe and Russia, full details of warranty provided can be found in [www.viewsoniceurope.com](http://www.viewsoniceurope.com) under Support/Warranty Information.



**ViewSonic**