

ViewSonic®



PJD6250L/PJD6252L/PJD7325/ PJD6550W/PJD6552W/PJD7525W DLP Projector User Guide

IMPORTANT: Please read this User Guide to obtain important information on installing and using your product in a safe manner, as well as registering your product for future service. Warranty information contained in this User Guide will describe your limited coverage from ViewSonic Corporation, which is also found on our web site at <http://www.viewsonic.com> in English, or in specific languages using the Regional selection box in the upper right corner of our website. "Antes de operar su equipo lea cuidadosamente las instrucciones en este manual"

Model No.

VS15912/VS15913/VS15991/VS15915/VS15916/VS15992

Thank you for choosing ViewSonic

With over 25 years as a world leading provider of visual solutions, ViewSonic is dedicated to exceeding the world's expectations for technological evolution, innovation, and simplicity. At ViewSonic, we believe that our products have the potential to make a positive impact in the world, and we are confident that the ViewSonic product you have chosen will serve you well.

Once again, thank you for choosing ViewSonic !



Compliance Information

FCC Compliance Statement

This device complies with part 15 of FCC Rules. Operation is subject to the following two conditions: (1) this device may not cause harmful interference, and (2) this device must accept any interference received, including interference that may cause undesired operation.

This equipment has been tested and found to comply with the limits for a Class B digital device, pursuant to part 15 of the FCC Rules. These limits are designed to provide reasonable protection against harmful interference in a residential installation. This equipment generates, uses, and can radiate radio frequency energy, and if not installed and used in accordance with the instructions, may cause harmful interference to radio communications. However, there is no guarantee that interference will not occur in a particular installation. If this equipment does cause harmful interference to radio or television reception, which can be determined by turning the equipment off and on, the user is encouraged to try to correct the interference by one or more of the following measures:

- Reorient or relocate the receiving antenna.
- Increase the separation between the equipment and receiver.
- Connect the equipment into an outlet on a circuit different from that to which the receiver is connected.
- Consult the dealer or an experienced radio/TV technician for help.

Warning: You are cautioned that changes or modifications not expressly approved by the party responsible for compliance could void your authority to operate the equipment.

Industry Canada Statement

CAN ICES-3 (B)/NMB-3(B)

CE Conformity for European Countries

 The device complies with the EMC Directive 2004/108/EC and Low Voltage Directive 2006/95/EC.

Following information is only for EU-member states:

The mark is in compliance with the Waste Electrical and Electronic Equipment Directive 2012/19/EC (WEEE).

The mark indicates the requirement NOT to dispose the equipment including any spent or discarded batteries or accumulators as unsorted municipal waste, but use the return and collection systems available.

If the batteries, accumulators and button cells included with this equipment, display the chemical symbol Hg, Cd, or Pb, then it means that the battery has a heavy metal content of more than 0.0005% Mercury or more than, 0.002% Cadmium, or more than 0.004% Lead.



Declaration of RoHS2 Compliance

This product has been designed and manufactured in compliance with Directive 2011/65/EU of the European Parliament and the Council on restriction of the use of certain hazardous substances in electrical and electronic equipment (RoHS2 Directive) and is deemed to comply with the maximum concentration values issued by the European Technical Adaptation Committee (TAC) as shown below:

Substance	Proposed Maximum Concentration	Actual Concentration
Lead (Pb)	0.1%	< 0.1%
Mercury (Hg)	0.1%	< 0.1%
Cadmium (Cd)	0.01%	< 0.01%
Hexavalent Chromium (Cr ⁶⁺)	0.1%	< 0.1%
Polybrominated biphenyls (PBB)	0.1%	< 0.1%
Polybrominated diphenyl ethers (PBDE)	0.1%	< 0.1%

Certain components of products as stated above are exempted under the Annex III of the RoHS2 Directives as noted below:

Examples of exempted components are:

1. Mercury in cold cathode fluorescent lamps and external electrode fluorescent lamps (CCFL and EEFL) for special purposes not exceeding (per lamp):
 - (1) Short length (≤ 500 mm): maximum 3.5 mg per lamp.
 - (2) Medium length (> 500 mm and $\leq 1,500$ mm): maximum 5 mg per lamp.
 - (3) Long length ($> 1,500$ mm): maximum 13 mg per lamp.
2. Lead in glass of cathode ray tubes.
3. Lead in glass of fluorescent tubes not exceeding 0.2% by weight.
4. Lead as an alloying element in aluminium containing up to 0.4% lead by weight.
5. Copper alloy containing up to 4% lead by weight.
6. Lead in high melting temperature type solders (i.e. lead-based alloys containing 85% by weight or more lead).
7. Electrical and electronic components containing lead in a glass or ceramic other than dielectric ceramic in capacitors, e.g. piezoelectric devices, or in a glass or ceramic matrix compound.

Indian Restriction of Hazardous Substances

Restriction on Hazardous Substances statement (India) This product complies with the "India E-waste Rule 2011" and prohibits use of lead, mercury, hexavalent chromium, polybrominated biphenyls or polybrominated diphenyl ethers in concentrations exceeding 0.1 weight % and 0.01 weight % for cadmium, except for the exemptions set in Schedule 2 of the Rule.

Important Safety Instructions

1. Read these instructions.
2. Keep these instructions.
3. Heed all warnings.
4. Follow all instructions.
5. Do not use this unit near water.
6. Clean with a soft, dry cloth.
7. Do not block any ventilation openings. Install the unit in accordance with the manufacturer's instructions.
8. Do not install near any heat sources such as radiators, heat registers, stoves, or other devices (including amplifiers) that produce heat.
9. Do not defeat the safety purpose of the polarized or grounding-type plug. A polarized plug has two blades with one wider than the other. A grounding type plug has two blades and a third grounding prong. The wide blade and the third prong are provided for your safety. If the provided plug does not fit into your outlet, consult an electrician for replacement of the obsolete outlet.
10. Protect the power cord from being walked on or pinched particularly at plugs. Convenience receptacles and the point where they exit from the unit. Be sure that the power outlet is located near the unit so that it is easily accessible.
11. Only use attachments/accessories specified by the manufacturer.
12. Use only with the cart, stand, tripod, bracket, or table specified by the manufacturer, or sold with the unit. When a cart is used, use caution when moving the cart/unit combination to avoid injury from tipping over.
13. Unplug this unit when unused for long periods of time.
14. Refer all servicing to qualified service personnel. Servicing is required when the unit has been damaged in any way, such as: if the power-supply cord or plug is damaged, if liquid is spilled onto or objects fall into the unit, if the unit is exposed to rain or moisture, or if the unit does not operate normally or has been dropped.



Copyright Information

Copyright © ViewSonic Corporation, 2015. All rights reserved.

Macintosh and Power Macintosh are registered trademarks of Apple Inc.

Microsoft, Windows, and the Windows logo are registered trademarks of Microsoft Corporation in the United States and other countries.

ViewSonic and the three birds logo are registered trademarks of ViewSonic Corporation.

VESA is a registered trademark of the Video Electronics Standards Association.

DPMS and DDC are trademarks of VESA.

PS/2, VGA and XGA are registered trademarks of International Business Machines Corporation.

Disclaimer: ViewSonic Corporation shall not be liable for technical or editorial errors or omissions contained herein; nor for incidental or consequential damages resulting from furnishing this material, or the performance or use of this product.

In the interest of continuing product improvement, ViewSonic Corporation reserves the right to change product specifications without notice. Information in this document may change without notice.

No part of this document may be copied, reproduced, or transmitted by any means, for any purpose without prior written permission from ViewSonic Corporation.

Product Registration

To fulfill possible future product needs, and to receive additional product information as it becomes available, please visit your region section on ViewSonic's website to register your product online.

The ViewSonic CD also provides an opportunity for you to print the product registration form. Upon completion, please mail or fax to a respective ViewSonic office. To find your registration form, use the directory “:\CD\Registration”.

Registering your product will best prepare you for future customer service needs. Please print this user guide and fill the information in the “For Your Records” section. For additional information, please see the “Customer Support” section in this guide.

For Your Records

Product Name:	PJD6250L/PJD6252L/PJD7325/PJD6550W/PJD6552W/ PJD7525W ViewSonic DLP Projector
Model Number:	VS15912/VS15913/VS15991/VS15915/VS15916/VS15992
Document Number:	PJD6250L/PJD6252L/PJD7325/PJD6550W/PJD6552W/ PJD7525W_UG_ENG Rev. 1A 06-08-15
Serial Number:	_____
Purchase Date:	_____

Product disposal at end of product life

The lamp in this product contains mercury which can be dangerous to you and the environment. Please use care and dispose of in accordance with local, state or federal laws.

ViewSonic respects the environment and is committed to working and living green.

Thank you for being part of Smarter, Greener Computing.

Please visit ViewSonic website to learn more.

USA & Canada: <http://www.viewsonic.com/company/green/recycle-program/>

Europe: <http://www.viewsoniceurope.com/uk/support/recycling-information/>

Taiwan: <http://recycle.epa.gov.tw/recycle/index2.aspx>

FCC notice

This equipment has been tested and found to comply with the limits for a Class B digital device, pursuant to part 15 of the FCC Rules. These limits are designed to provide reasonable protection against harmful interference in residential installation. This equipment generates, uses and can radiate radio frequency energy and if not installed and used in accordance with the instructions, may cause harmful interference to radio communications. However, there is no guarantee that interference will not occur in a particular installation. If this equipment does cause harmful interference to radio or television reception, detectable by turning the equipment in question off and on, the user is encouraged to try to correct the interference by one or more of the following measures:

- Reorient or relocate the receiving antenna
- Increase the distance between the equipment and the receiver
- Connect the equipment to an outlet on a different circuit than that which the receiver is connected to
- Or consult the dealer or an experienced radio/TV technician for help.

This device complies with Part 15 of the FCC Rules. Operation is subject to following two conditions:

1. This device may not cause harmful interference, and
2. This device must accept any interference that may cause undesired operation.

Safety instructions

Read all of these instructions before you operate your projector and save for future reference.

1. **Read instructions**
All the safety and operating instructions should be read before the appliance is operated.
2. **Notes and warnings**
All notes and warnings in the operating instructions should be adhered to.
3. **Cleaning**
Unplug the projector from the wall socket before cleaning. Use a damp cloth for cleaning the projector housing. Do not use liquid or aerosol cleaners.
4. **Accessories**
Do not place this product on an unstable cart, stand, or table. The product may fall, causing serious damage to the product.
Keep the plastic packing materials (from the projector, accessories and optional parts) out of the reach of children as these bags may result in death by suffocation. Be particularly careful around the small children.
5. **Ventilation**
The projector is equipped with ventilation holes (intake) and ventilation holes (exhaust).
Do not block or place anything near these slots, or internal heat build-up may occur, causing picture degradation or damage to the projector.
6. **Power sources**
Check that the operating voltage of your unit is identical with the voltage of your local power supply.
7. **Servicing**
Do not attempt to service this projector yourself. Refer all servicing to qualified service personnel.
8. **Replacement parts**
When replacement parts are required, be sure that the replacement parts are specified by the manufacture. Unauthorized substitutions may result in fire, electric shock or other hazards.
9. **Moisture Condensation**
Never operate this projector immediately after moving it from a cold location to a warm one. When the projector is exposed to such a change in temperature, moisture may condense on the lens and the crucial internal parts. To prevent the unit from possible damage, do not use the projector for at least 2 hours when there is an extreme or sudden change in temperature.

Notes on the AC power cord

AC Power Cord must meet the requirement of countries where you use this projector. Please confirm your AC plug type with the graphics below and ensure that the proper AC Power Cord is used. If the supplied AC Power Cord does not match your AC outlet, please contact your sales dealer. This projector is equipped with a grounding type AC line plug. Please ensure that your outlet fits the plug. Do not defeat the safety purpose of this grounding type plug. We highly recommend using a video source device also equipped with a grounding type AC line plug to prevent signal interference due to voltage fluctuations.

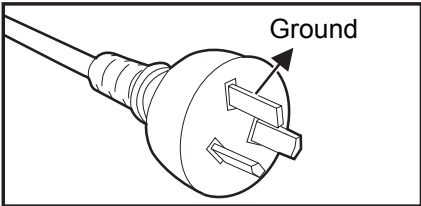

For Australia and Mainland China

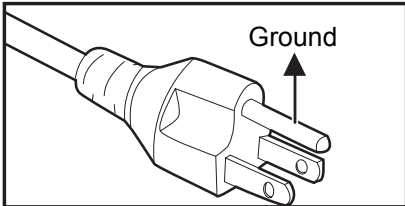

For the U.S.A. and Canada

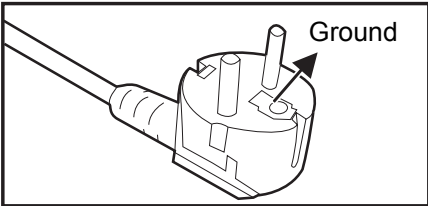

For Continental Europe

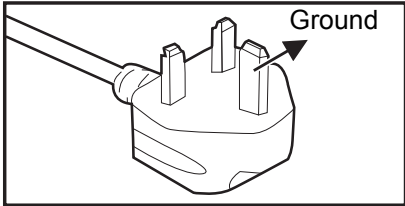

For the U.K.

Table of contents

Introduction	1
Projector features	1
Package contents	2
Projector overview	3
Using the product	5
Control panel	5
Connection ports	7
Remote control	8
Installing the batteries	12
Remote control operation	13
Connection	14
Connecting a computer or monitor	15
Connecting Video source devices	16
Playing sound through the projector	18
Operation	19
Powering on/off the projector	19
Adjusting the projector height	20
Adjusting the projector zoom and focus	20
Adjusting projection image size	21
Securing the projector	23
Locking control keys	25
Setting the presentation timer	26
Menu operation	27
Controlling the projector through a LAN environment	44
Using the projector in standby mode	50
Adjusting the sound	50
Maintenance	52
Cleaning the lens	52
Cleaning the projector housing	52
Installing the dust filter (optional accessory)	53
Installing the cable management cover (optional accessory)	54
Replacing the lamp	55
Specifications	57
Dimensions	58
Ceiling mount installation	58
Appendix	59
LED indicator messages	59
Compatibility modes	60
Troubleshooting	62
RS-232 command and configuration	63
IR control table	69

Introduction

Projector features

The projector integrates high-performance optical engine projection and a user - friendly design to deliver high reliability and ease of use.

The projector offers the following features:

- Compatibility with Macintosh® computers
- Compatibility with NTSC, PAL, SECAM and HDTV
- D-Sub 15-pin terminal for analog video connectivity
- Equipped with HDMI connection supporting HDCP
- Multi-language On-Screen Display (OSD) menus
- Digital keystone correction to correct distorted images
- RS-232 connector for serial control
- Power saving function decreasing the power consumption of the lamp by up to 30% when no input signal can be detected for a set period of time.
- Presentation timer for better control of time during presentations
- Blu-Ray 3D function supported
- Selectable quick power off function
- Color Management allowing color adjustments to your liking
- Screen Color correction allowing projection on surfaces of several predefined colors
- Quick auto search speeding up the signal detecting process
- HDMI CEC (Consumer Electronics Control) function allows synchronized power ON/OFF operation between the projector and a CEC-compatible DVD player device connected to the HDMI input of the projector
- LAN setting allowing management of projector status from a remote computer

Note

- ***The information in this manual is subject to change without notices.***
- ***The reproduction, transfer or copy of all or any part of this document is not permitted without express written consent.***

Package contents

When you unpack the projector, make sure you have all these components:

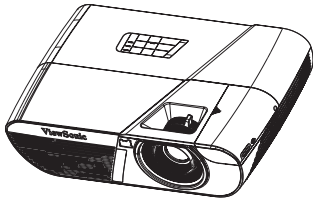

PJD6250L/PJD6252L/PJD7325/
PJD6550W/PJD6552W/
PJD7525W projector



Remote control (IR) &
batteries (AAA *2 PCS)

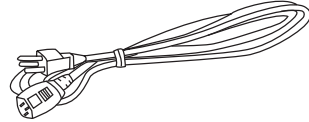

AC power cord

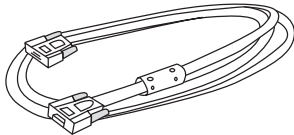

VGA cable (D-SUB to D-SUB)

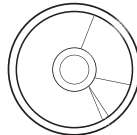

ViewSonic CD wizard

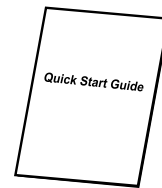

Quick start guide

Optional accessories

1. Cable management cover (rear cable cover)
2. Carry bag
3. Dust filter

Note

- **Contact your dealer immediately if any items are missing, appear damaged, or if the unit does not work.**
- **For maximum protection of the product, please save the original shipping carton and packing materials and repack your product as it was originally packed at the factory if you need to ship it.**

Projector overview

Front view

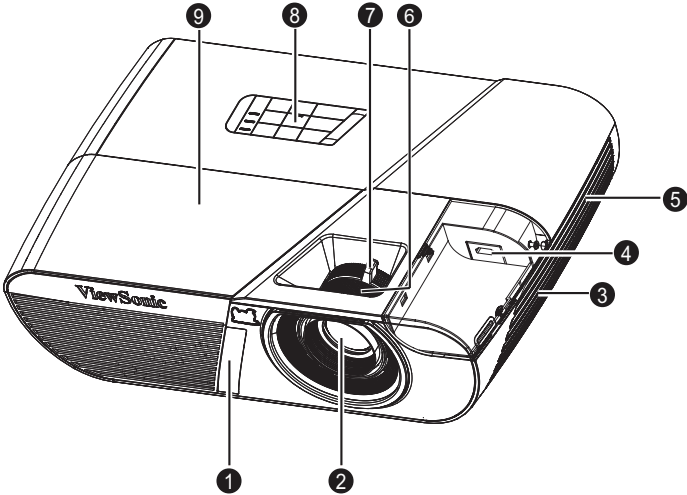

- 1. Front IR remote control sensor
- 2. Projection lens
- 3. Speaker
- 4. HDMI/MHL dongle port
- 5. Ventilation holes
- 6. Focus ring
- 7. Zoom ring
- 8. Control panel
- 9. Lamp cover

Rear View

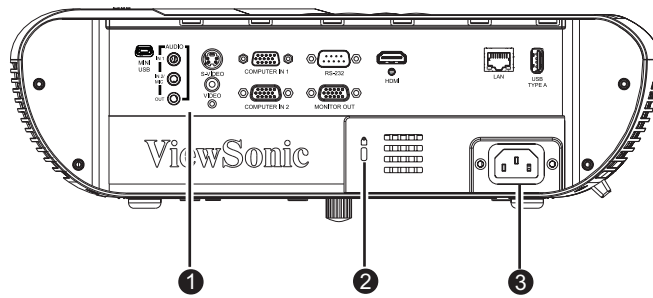

1. Connection ports
2. Kensington lock
3. AC power socket

Bottom View

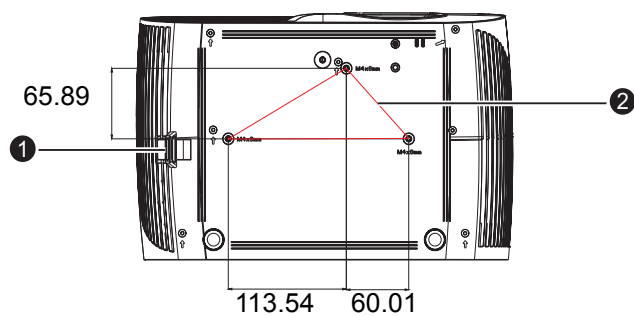

Ceiling mount screws:
M4 x 8 (Max. L = 8 mm)

Unit: mm

1. Security bar
2. Ceiling mount holes

Note

- ***This projector can be used with a ceiling mount for support. The ceiling mount is not included in the package.***
- ***Contact your dealer for information to mount the projector on a ceiling.***

Using the product

Control panel

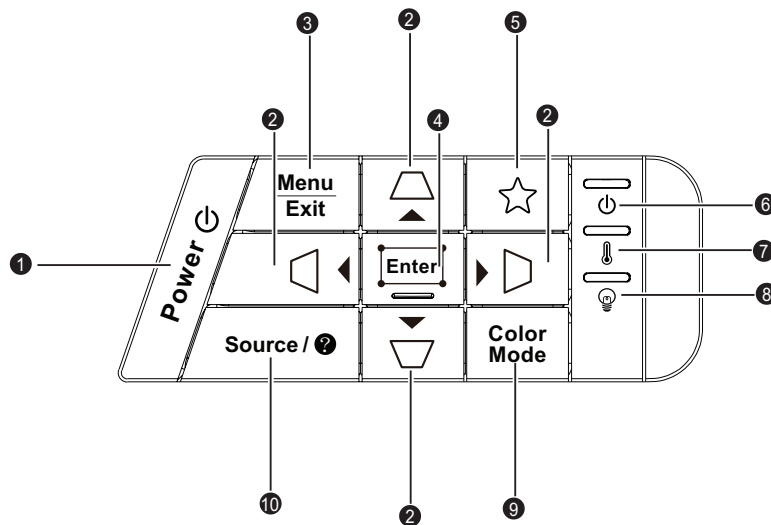

1. **⏻ POWER**
Turn the projector on or off.
2. **▭/▭/▭/▭ (Keystone)**
Manually corrects distorted images resulting from an angled projection.
▲ Up/▼ Down/◀ Left/▶ Right
Selects the desired menu items and makes adjustments.
3. **Menu/Exit**
Menu: Display or exit the on-screen display menus.
Exit: Goes back to previous OSD menu, exits and saves menu settings.
4. **Enter/▭ (Corner Adj.)**
Enacts the selected On-Screen Display (OSD) menu item.
Displays the Corner Adj. page.
5. **☆ (My Button)**
User definable key for customized function.
6. **⏻ (Power LED indicator)**
Refer to “LED Indicator Messages”.
7. **🌡️ (Temp LED indicator)**
Refer to “LED Indicator Messages”.
8. **💡 (Lamp LED indicator)**
Refer to “LED Indicator Messages”.
9. **Color Mode**
Select the picture setup mode.
10. **Source/? (Help)**

Source: Display the source selection bar.

Help: Display the HELP menu by a long press for 3 seconds.

Connection ports

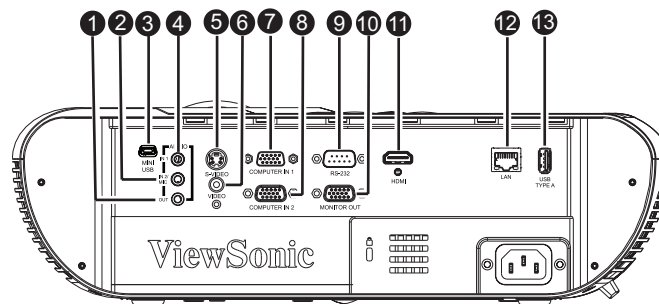

- 1. AUDIO OUT**
Connect to a speaker or other audio input equipment.
- 2. AUDIO IN 2 / MIC**
Connect an audio output from video equipment / computer or Microphone to this jack.
Note: The function for switching to Audio in 2 / Microphone in is in OSD menu.
- 3. MINI USB**
This connector is for firmware update and mouse function support.
- 4. AUDIO IN 1**
Connect an audio output from video equipment or computer to this jack.
- 5. S-VIDEO**
Connect S-Video output from video equipment to this jack.
- 6. VIDEO**
Connect composite video output from video equipment to this jack.
- 7. COMPUTER IN 1**
Connect image input signal (analog RGB or component) to this jack.
- 8. COMPUTER IN 2**
Connect image input signal (analog RGB or component) to this jack.
- 9. RS-232**
When operating the projector via a computer, connect this to the controlling computer's RS-232C port.
- 10. MONITOR OUT**
Connect to a computer display, etc.
- 11. HDMI**
Connect HDMI output from video equipment to this jack.
- 12. LAN**
RJ45 connector for Ethernet connection.
- 13. USB TYPE A**
5V/2A out for power charging.

Remote control

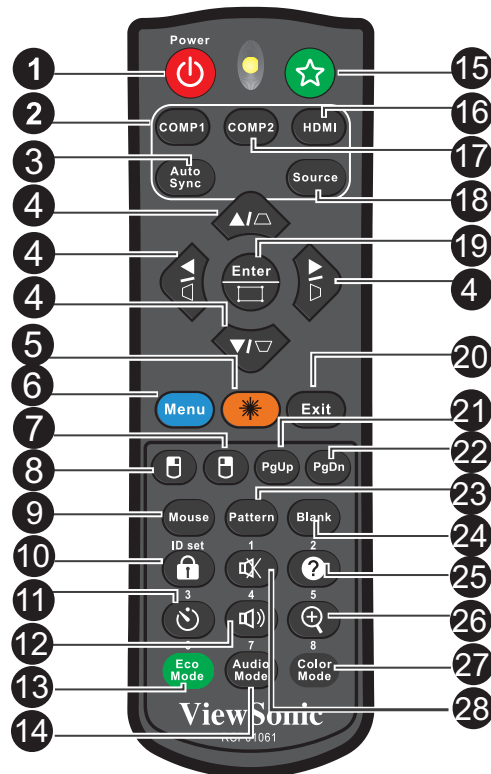

1. **Power**
Turn the projector on or off.
2. **COMP1**
Display COMPUTER IN 1 signal.
3. **Auto Sync**
Automatically determines the best picture timings for the displayed image.
4. **Keystone**
Manually corrects distorted images resulting from an angled projection.
▲ Up/▼ Down/◀ Left/▶ Right
Selects the desired menu items and makes adjustments.
5. **Laser**
Aim the remote at the viewing screen, press and hold this button to activate the laser pointer.
6. **Menu**
Display on-screen display menus.
7. **(Right mouse)**
Perform the right button of the mouse when mouse mode is activated.
8. **(Left mouse)**
Perform the left button of the mouse when mouse mode is activated.
9. **Mouse**

Switch between the normal and mouse modes.

10.  (Lock)/ID Set

Lock: Activates or disables panel key lock.

ID Set: Sets remote control code.

11.  (Timer)

Activate P-Timer OSD menu.

12.  (Volume+)

Increase the volume level.

13. Eco Mode

Switch the lamp mode from Normal, Economic, Dynamic to Sleep.

14.  (Volume-)

Decrease the volume level.

15.  (My Button)

User definable key for customized function.

16. HDMI

Display HDMI signal.

17. COMP2

Not available for PJD5 series.

18. Source

Display the source selection bar.

19. Enter/  (Corner Adj.)

Enacts the selected On-Screen Display (OSD) menu item.

Displays the Corner Adj. page.

20. Exit

Goes back to previous OSD menu, exits and saves menu settings.

21. PgUp (Page Up)

Perform page up function when mouse mode is activated.

22. PgDn (Page Down)

Perform page down function when mouse mode is activated.

23. Pattern

Display embedded test pattern.

24. Blank

Hide the screen picture.

25.  (Help)

Display the Help menu.

26.  (Magnify)

Displays the zoom bar that magnifies or reduces the projected picture size.

27. Color Mode

Select the picture setup mode.

28.  (Mute)

Toggles the projector audio between on and off.

Operating the Laser pointer

The laser beam is visible. It is necessary to press and hold **LASER** for continuous output.

The laser pointer is not a toy. Parents should be mindful of the dangers of laser energy and keep this remote control out of the reach of children.





Caution

- *Do not look into the laser light window or shine the laser light beam on yourself or others. See the warning messages on the back of the remote control prior to using it.*

Using the remote mouse control

The capability of operating your computer with the remote control gives you more flexibility when delivering presentations.

1. Connect the projector to your PC or notebook with a USB cable prior to using the remote control in place of your computer's mouse. See "[Connection](#)" on page 14 for details.
2. Set the input signal to **COMPUTER**.
3. Press Mouse on the remote control to switch from the normal mode to the mouse mode. An icon appears on the screen to indicate the activation of the mouse mode.
4. Perform the desired mouse controls on your remote control.
 - To move the cursor on the screen, press ▲/ ▼/ ◀/▶ .
 - To left-click, press .
 - To right-click, press .
 - To operate your display software program (on a connected PC) which responds to page up/down commands (like Microsoft PowerPoint), press **Page Up/Page Down**.
 - To return to the normal mode, press **Mouse** again or other keys except for the mouse related multi-function keys.

Remote control code

The projector can be assigned to 8 different remote control codes, 1 to 8. When several adjacent projectors are in operation at the same time, switching the remote control codes can prevent interference from other remote controls. Set the remote control code for the projector first before changing that for the remote control.

To switch the code for the projector, select from among 1 to 8 in the **SYSTEM SETTING: ADVANCED > Remote Control Code** menu.



To switch the code for the remote control, press **ID set** and the corresponding button from 1 to 8 buttons on the remote control together for 5 seconds or more. The initial code is set to 1. When the code is switched to 8, the remote control can control every projector.

 **Note**

- ***If different codes are set on the projector and remote control, there will be no response from the remote control. When that happens, switch the code for the remote control again.***

Installing the batteries

1. Open the battery cover in the direction shown.

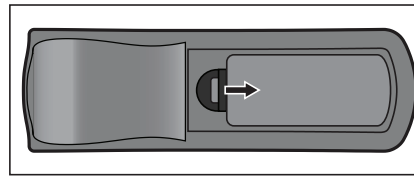

2. Install batteries as indicated by the diagram inside the compartment.

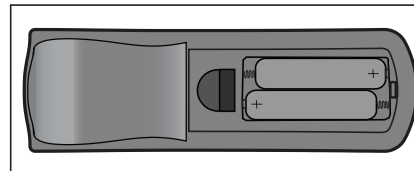

3. Close the battery cover into position.

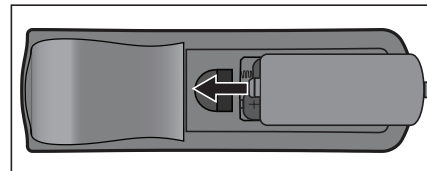

Caution

- *Risk of explosion if battery is replaced by an incorrect type.*
- *Dispose of used batteries according to the instructions.*
- *Make sure the plus and minus terminals are correctly aligned when loading a battery.*



Note

- *Keep the battery out of the reach of children.*
- *Remove batteries from remote control when not using for extended periods.*
- *Do not recharge the battery or expose the battery to fire or water.*
- *Do not dispose the used battery along with household waste. Dispose used batteries according to local regulations.*
- *Danger of explosion may happen if batteries are incorrectly replaced. Replace only with the same type recommended by the manufacturer.*
- *Battery should not be in or near to fire or water, keep batteries in a dark, cool and dry place.*
- *If suspect battery leakage, wipe out the leakage and then replace a new battery. If the leakage adheres to your body or clothes, rinse well with water immediately.*

Remote control operation

Point the remote control at the infrared remote sensor and press a button.

- Operating the projector from the front.

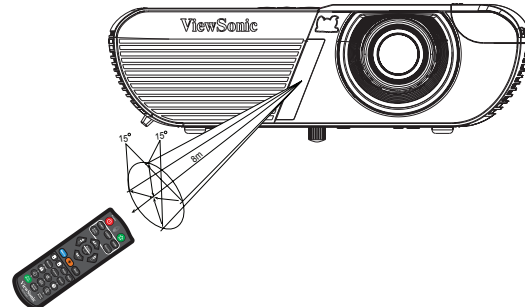

Note

- *The remote control may not operate when there is sunlight or other strong light such as a fluorescent lamp shining on the remote sensor.*
- *Operate the remote control from a position where the remote sensor is visible.*
- *Do not drop the remote control or jolt it.*
- *Keep the remote control out of locations with excessively high temperature or humidity.*
- *Do not get water on the remote control or place wet objects on it.*
- *Do not disassemble the remote control.*

Connection

When connecting a signal source to the projector, be sure to:

1. Turn all equipment off before making any connections.
2. Use the correct signal cables for each source.
3. Ensure the cables are firmly inserted.

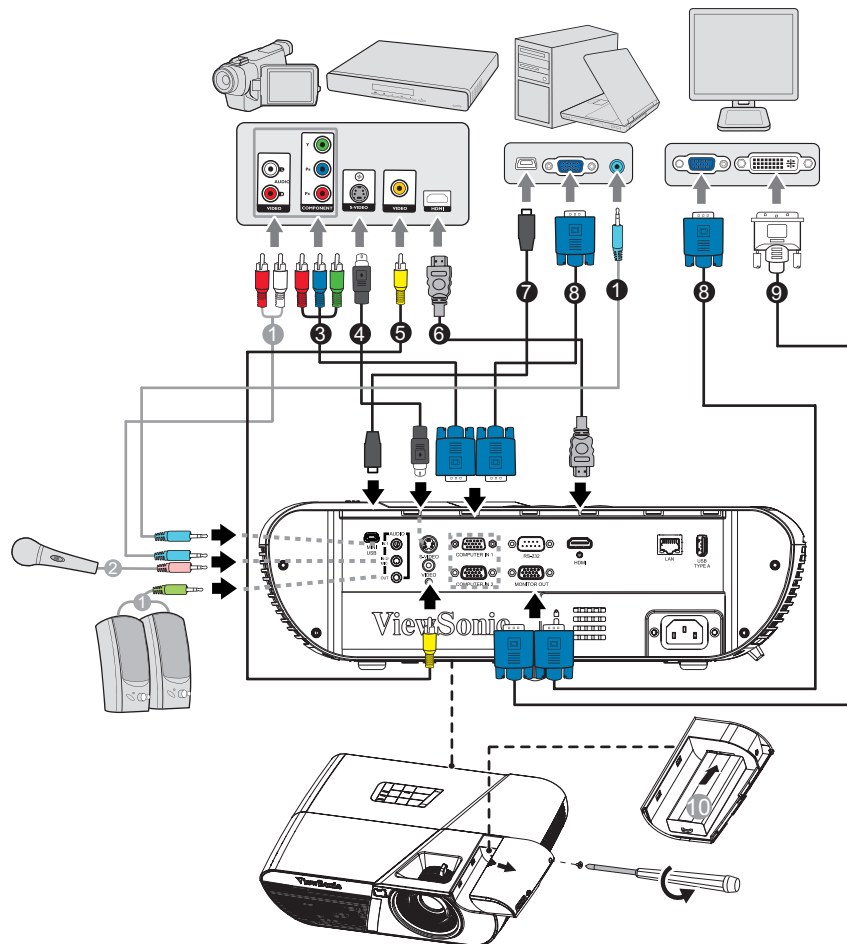

- | | |
|--------------------------------------|-----------------------------------|
| 1. Audio cable | 2. Microphone 3.5 mini jack cable |
| 3. VGA (D-Sub) to HDTV (RCA) cable | 4. S-Video cable |
| 5. Composite Video cable | 6. HDMI cable |
| 7. USB cable (mini-B type to A type) | 8. VGA cable (D-Sub to D-Sub) |
| 9. VGA to DVI-A cable | 10. HDMI/MHL dongle |

Important

- ***In the connections shown above, some cables may not be included with the projector (see "Package contents" on page 2). They are commercially available from electronics stores.***
- ***The connection illustrations above are for reference only. The rear connecting jacks available on the projector vary with each projector model.***
- ***For detailed connection methods, see pages 15-17.***

Connecting a computer or monitor

Connecting a computer

The projector provides two VGA input sockets that allow you to connect them to both IBM® compatibles and Macintosh® computers. A Mac adapter is needed if you are connecting legacy version Macintosh computers.

To connect the projector to a notebook or desktop computer:

1. Take the supplied VGA cable and connect one end to the D-Sub output socket of the computer.
2. Connect the other end of the VGA cable to the **COMPUTER IN 1** or **COMPUTER IN 2** signal input socket on the projector.

Important

- *Many notebooks do not turn on their external video ports when connected to a projector. Usually a key combo like FN + F3 or CRT/LCD key turns the external display on/off. Locate a function key labeled CRT/LCD or a function key with a monitor symbol on the notebook. Press FN and the labeled function key simultaneously. Refer to your notebook's documentation to find your notebook's key combination.*

Connecting a monitor

If you want to view your presentation close-up on a monitor as well as on the screen, you can connect the **MONITOR OUT** signal output socket on the projector to an external monitor with a VGA cable following the instructions below:

To connect the projector to a monitor:

1. Connect the projector to a computer as described in "[Connecting a computer](#)" on [page 15](#).
2. Take a suitable VGA cable (only one supplied) and connect one end of the cable to the D-Sub input socket of the video monitor.

Or if your monitor is equipped with a DVI input socket, take a VGA to DVI-A cable and connect the DVI end of the cable to the DVI input socket of the video monitor.

3. Connect the other end of the cable to the **MONITOR OUT** socket on the projector.

Important



- *In standby mode, the **MONITOR OUT** output only works when **COMPUTER IN 1** is made to the projector.*

Connecting Video source devices

You can connect your projector to various Video source devices that provide any one of the following output sockets:

- HDMI
- Component Video
- S-Video
- Video (composite)

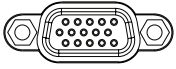
You need only connect the projector to a Video source device using just one of the above connecting methods, however each provides a different level of video quality. The method you choose will most likely depend upon the availability of matching terminals on both the projector and the Video source device as described below:

Terminal name	Terminal appearance	Reference	Picture quality
HDMI	HDMI 	"Connecting an HDMI source device" on page 16	Best
Component Video	COMPUTER IN 1/ COMPUTER IN 2 	"Connecting a Component Video source device" on page 16	Better
S-Video	S-VIDEO 	"Connecting an S-Video source device" on page 17	Good
Video	VIDEO 	"Connecting a composite Video source device" on page 17	Normal

Connecting an HDMI source device

Examine your Video source device to determine if it has a set of unused HDMI output jacks available:

- If so, you can continue with this procedure.
- If not, you will need to reassess which method you can use to connect to the device.

To connect the projector to an HDMI source device:

1. Take an HDMI cable and connect one end to the HDMI output jack of the HDMI source device.
2. Connect the other end of the HDMI cable to the **HDMI** jack on the projector.

Connecting a Component Video source device

Examine your Video source device to determine if it has a set of unused Component Video output sockets available:

- If so, you can continue with this procedure.
- If not, you will need to reassess which method you can use to connect to the device.

To connect the projector to a Component Video source device:

1. Take a VGA (D-Sub) to HDTV (RCA) cable and connect the end with 3 RCA type connectors to the Component Video output sockets of the Video source device. Match the color of the plugs to the color of the sockets; green to green, blue to blue, and red to red.
2. Connect the other end of the cable (with a D-Sub type connector) to the **COMPUTER IN 1** or **COMPUTER IN 2** socket on the projector.

Important

- *If the selected video image is not displayed after the projector is turned on and the correct video source has been selected, check that the Video source device is turned on and operating correctly. Also check that the signal cables have been connected correctly.*

Connecting an S-Video source device

Examine your Video source device to determine if it has an unused S-Video output socket available:

- If so, you can continue with this procedure.
- If not, you will need to reassess which method you can use to connect to the device.

To connect the projector to an S-Video source device:

1. Take an S-Video cable and connect one end to the S-Video output socket of the Video source device.
2. Connect the other end of the S-Video cable to the **S-VIDEO** socket on the projector.

Important

- *If the selected video image is not displayed after the projector is turned on and the correct video source has been selected, check that the Video source device is turned on and operating correctly. Also check that the signal cables have been connected correctly.*
- *If you have already made a Component Video connection between the projector and this S-Video source device using Component Video connections, you need not connect to this device using an S-Video connection as this makes an unnecessary second connection of poorer picture quality. See "[Connecting Video source devices](#)" on page 16 for details.*

Connecting a composite Video source device

Examine your Video source device to determine if it has a set of unused composite Video output sockets available:

- If so, you can continue with this procedure.
- If not, you will need to reassess which method you can use to connect to the device.

To connect the projector to a composite Video source device:

1. Take a Video cable and connect one end to the composite Video output socket of the Video source device.
2. Connect the other end of the Video cable to the **VIDEO** socket on the projector.

Important

- *If the selected video image is not displayed after the projector is turned on and the correct video source has been selected, check that the Video source device is turned on and operating correctly. Also check that the signal cables have been connected correctly.*
- *You need only connect to this device using a composite Video connection if Component Video and S-Video inputs are unavailable for use. See "[Connecting Video source devices](#)" on page 16 for details.*

Playing sound through the projector

You can make use of the projector (mixed mono) speaker in your presentations, and also connect separate amplified speakers to the **AUDIO OUT** socket of the projector.

If you have a separate sound system, you will most likely want to connect the audio output of your Video source device to that sound system, instead of to the mono audio projector.

You can also use a microphone to output the sound through the projector speaker when the **SYSTEM SETTING: ADVANCED > Audio Settings > Audio In 2** menu is set to **Microphone**. See "[Adjusting the Audio In 2 setting](#)" on page 51 for details.

Once connected, the audio can be controlled by the projector On-Screen Display (OSD) menus. See "[Adjusting the sound](#)" on page 50 for details.

About the microphone input

- If you wish to use a microphone, connect a 3.5 mini jack cable microphone to the projector.
- There are two ways to adjust microphone volumes.
 - Directly set microphone volume levels in the **SYSTEM SETTING: ADVANCED > Audio Settings > Microphone Volume** menu.
 - Set projector volume levels in the **SYSTEM SETTING: ADVANCED > Audio Settings > Audio Volume** menu, or press Volume keys (+, -) on the remote control. (The projector volume setting will affect the microphone volume.)
- To make the microphone input available when the projector is in standby mode, turn on the **SYSTEM SETTING: ADVANCED > Audio Settings > Active Audio out** menu.
- If the microphone is not working, check the volume setting and cable connection.
- You might get feedback noise from the microphone when you are too close to the speaker of the projector. Move the microphone away from the speaker of the projector. The greater volume you require, the greater distance you need to be away from the Speaker to prevent the noise.

Operation

Powering on/off the projector

Powering on the projector:



1. Complete the AC power cord and peripheral signal cable(s) connections.
2. Press  to turn on the projector.
The projector takes a minute or so to warm up.
 - If the projector is still hot from previous activity, it will run the cooling fan for approximately 60 seconds before energizing the lamp.
3. Turn on your source (computer, notebook, DVD, etc.).
 - If you are connecting multiple sources to the projector simultaneously, press **Source** to select your desired signal or press your desired signal key on the remote control.
 - If the projector doesn't detect a valid signal, the message 'No Signal' will continue to be displayed.
 - Be sure the **Quick Auto Search** function in the **SOURCE** menu is **On** if you want the projector to automatically search for the signals.



Warning

- *Never look into the lens when the lamp is on. This can damage your eyes.*
- *This focal point concentrates high temperature. Do not place any object near it to avoid possible fire hazard.*

Powering off the projector:

1. Press  to turn off the projector lamp. You will see a message "Power off? Press Power again" appear on the screen.
2. Press  again to confirm.
 - When Active VGA out/Active Audio out function is turned off, the Power LED begins flashing and the projector has entered stand-by mode.
 - When Active VGA out/Active Audio out function is turned on, the Power LED becomes steady light and the projector has entered stand-by mode.
 - If you want to turn the projector back on, you must wait until the projector has completed the cooling cycle and has entered stand-by mode. Once in stand-by mode, simply press  to restart the projector.
3. Disconnect the AC power cord from the electrical outlet and the projector.
4. Do not turn on the projector right after power off.

Adjusting the projector height

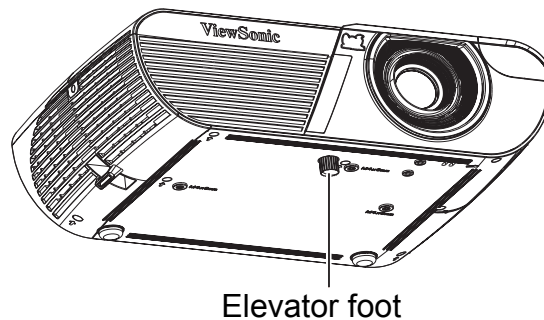

The projector is equipped with an elevator foot to adjust the image height. To raise or lower the image, turn the elevator foot to fine-tune the height.

Note

- *To avoid damaging the projector, make sure that the elevator foot is fully retracted before placing the projector in its carrying case.*

Adjusting the projector zoom and focus

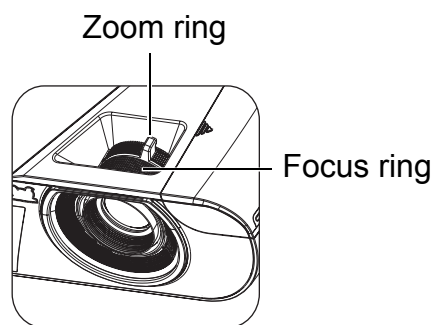

1. Sharpen the image by rotating the focus ring.
2. Adjust the image size by rotating the zoom ring or moving the projector forward or backward.

Adjusting projection image size

Refer to the graphic and table below to determine the screen size and projection distance.

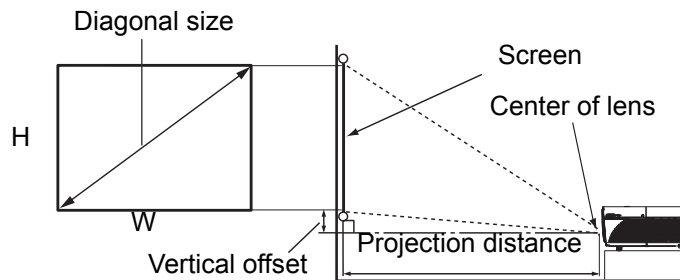

PJD6250L/PJD6252L/PJD7325

4 : 3 Screen diagonal					
Screen size			Projection distance [inch (m)]		Vertical offset [inch (cm)]
Diagonal [inch (cm)]	W [inch (cm)]	H [inch (cm)]	(min.)	(max.)	
30 (76)	24 (61)	18 (46)	47 (1.2)	51 (1.3)	2.7 (6.9)
40 (102)	32 (81)	24 (61)	62 (1.6)	69 (1.7)	3.6 (9.1)
60 (152)	48 (122)	36 (91)	94 (2.4)	103 (2.6)	5.4 (13.7)
80 (203)	64 (163)	48 (122)	125 (3.2)	137 (3.5)	7.2 (18.3)
100 (254)	80 (203)	60 (152)	156 (4.0)	172 (4.4)	9.0 (22.9)
150 (381)	120 (305)	90 (229)	234 (5.9)	257 (6.5)	13.5 (34.3)
200 (508)	160 (406)	120 (305)	312 (7.9)	343 (8.7)	18.0 (45.7)
250 (635)	200 (508)	150 (381)	390 (9.9)	429 (10.9)	22.5 (57.2)
300 (762)	240 (610)	180 (457)	468 (11.9)	515 (13.1)	27.0 (68.6)

PJD6550W/PJD6552W/PJD7525W

16 : 10 Screen diagonal					
Screen size			Projection distance [inch (m)]		Vertical offset [inch (cm)]
Diagonal [inch (cm)]	W [inch (cm)]	H [inch (cm)]	(min.)	(max.)	
30 (76)	26 (65)	16 (40)	36 (0.9)	46 (1.2)	1.2 (3.0)
40 (102)	34 (86)	21 (54)	49 (1.2)	61 (1.5)	1.6 (4.1)
60 (152)	51 (130)	32 (81)	75 (1.9)	93 (2.4)	2.4 (6.1)
80 (203)	68 (173)	42 (108)	100 (2.5)	124 (3.2)	3.2 (8.1)
100 (254)	85 (216)	53 (135)	126 (3.2)	156 (4.0)	4.0 (10.1)
150 (381)	128 (324)	80 (202)	189 (4.8)	235 (6.0)	6.0 (15.2)
200 (508)	170 (432)	106 (269)	253 (6.4)	313 (8.0)	8.0 (20.2)
250 (635)	213 (540)	133 (337)	317 (8.0)	392 (10.0)	10.0 (25.3)
300 (762)	255 (648)	159 (404)	380 (9.7)	-	12.0 (30.4)

 **Note**

- ***Position the projector in a horizontal position; other positions can cause heat build-up and damage to the projector.***
- ***Keep a space of 30 cm or more between the sides of the projector.***
- ***Do not use the projector in a smoky environment. Smoke residue may build-up on critical parts and damage the projector or its performance.***

Securing the projector

Setting a password

1. Open the OSD menu and go to the **SYSTEM SETTING: ADVANCED > Advanced > Security Settings** menu. Press **Enter**. The **Security Settings** page displays.
2. Highlight **Change Password** and press **Enter**.
3. According to the password you desire to set, press the arrow keys to enter six digits for the password.
4. Confirm the new password by re-entering the new password.
5. Go back to **SYSTEM SETTING: ADVANCED > Advanced > Security Settings > Power on Lock** menu, and press **Enter**. You will be asked to input password. Once the password is set, the OSD menu returns to the **Power on Lock**. Select **On** by pressing **◀/▶**.
6. To leave the OSD menu, press **Menu/Exit**.

Entering the password recall procedure

If the password function is activated, you will be asked to enter the six-digit password every time you turn on the projector.

1. If you enter an incorrect password 5 times in succession, the projector will display a coded number on the screen when you press the auto key 3~5 seconds.
2. Write down the number and turn off your projector.
3. Seek help from the local ViewSonic service center to decode the number. You may be required to provide proof of purchase documentation to verify that you are an authorized user of the projector.

Changing the password

1. Open the OSD menu and go to the **SYSTEM SETTING: ADVANCED > Advanced > Security Settings > Change Password** menu and press **Enter**.
2. Enter the old password.
 - If the password is correct, another message **"INPUT NEW PASSWORD"** displays.
 - If the password is incorrect, the password error message displays, and the message **"INPUT CURRENT PASSWORD"** displays for your retry. You can press **Menu/Exit** to cancel the change or try another password.
3. Enter a new password.
4. Confirm the new password by re-entering the new password.
5. You have successfully assigned a new password to the projector. Remember to enter the new password next time the projector is started.
6. To leave the OSD menu, press **Menu/Exit**.

Disabling the password function

To disable password protection, go back to **SYSTEM SETTING: ADVANCED > Advanced > Security Settings > Power on Lock** menu, and press **Enter**. You will be asked to input password. Once the password is set, the OSD menu returns to the **Power on Lock**. Select **Off** by pressing **◀/▶**. To leave the OSD menu, press **Menu/Exit**.

Locking control keys

With the control keys on the projector locked, you can prevent your projector settings from being changed accidentally (by children, for example). When the **Panel Key Lock is On**, no control keys on the projector will operate except **Power**.

1. Press **Lock** on the remote control for 3 seconds.
Press Lock on the remote control, a confirmation message "**Are you sure to lock panel keys?**" is displayed. Select **Yes** to confirm.



To release panel key lock:

1. Press **Lock** on the remote control directly. **The Panel keys are unlock.**

Important

- **If you press **Power** to turn off the projector without disabling panel key lock, the projector will still be in locked status the next time it is turned on.**
- **Keys on the remote control are still functional when panel key lock is enabled.**

Setting the presentation timer

The presentation timer can indicate the presentation time on the screen to help you achieve better time management when giving presentations. Follow these steps to utilize this function:

1. Press **Timer** on the remote control to access the Presentation Timer menu or go to the **SYSTEM SETTING: BASIC > Advanced > Presentation Timer** menu and press **Enter** to display the Presentation Timer page.
2. Highlight **Timer Period** and decide the timer period by pressing **◀/▶**.
3. Press **▼** to highlight **Timer Display** and choose if you want the timer to show up on the screen by pressing **◀/▶**.



Selection	Description
Always	Displays the timer on screen throughout the presentation time.
1 min/2 min/3 min	Displays the timer on screen in the last 1/2/3 minute(s).
Never	Hides the timer throughout the presentation time.

4. Press **▼** to highlight **Timer Position** and set the timer position by pressing **◀/▶**.
Top-Left → Bottom-Left → Top-Right → Bottom-Right
5. Press **▼** to highlight **Timer Counting Direction** and select your desired counting direction by pressing **◀/▶**.

Selection	Description
Count Up	Increases from 0 to the preset time.
Count Down	Decrease from the preset time to 0.

6. Press **▼** to highlight **Sound Reminder** and select your desired counting direction by pressing **◀/▶**. If you select **On**, a double beep sound will be heard at the last 30 seconds of counting down/up, and a triple beep sound will be produced when the timer is up.
7. To activate the presentation timer, press **▼** to highlight **Start Counting** and select **Yes**.
8. To cancel the timer, highlight **Start Counting** and select **No**.



Menu operation

The projector has multilingual on-screen display menus that allow you to make image adjustments and change a variety of settings.

How to operate

1. Press **Menu** to open the OSD menu.
2. When OSD is displayed, use ◀/▶ to select any feature in the main menu.
3. After selecting the desired main menu item, press ▼ to enter sub-menu for feature setting.
4. Use ▲/▼ to select the desired item and adjust the settings with ◀/▶.
5. Press **Menu**, the screen will return to the main menu or go back to the upper level of the menu.

Menu tree

Main Menu	Sub Menu	Settings	
 DISPLAY	Screen Color	Off / Blackboard / Greenboard / Whiteboard	
	Aspect Ratio	(1) PJD6250L/PJD6252L/PJD7325: Auto / 4:3 / 16:9 / Anamorphic / 2.35:1 (2) PJD6550W/PJD6552W/PJD7525W: Auto / 4:3 / 16:9 / Panorama / Anamorphic / 2.35:1 / 16:10	
	Keystone	-30 - 30	
	Corner Adj.	Top-Right / Top-Left / Bottom-Left / Bottom-Right	
	Position	X: -5 - 5 Y: - 5 - 5	
	Phase	0 - 31	
	H. Size	-15 - 15	
	Zoom	PC: 0.8X - 2.0X Video: 0.8X - 1.8X	
 PICTURE	Color Mode	Brightest / Dynamic / Standard / ViewMatch / Movie	
	Brightness	0 - 100	
	Contrast	-50 - 50	
	Color Temp.	Warm / Normal / Neutral / Cool	
		Red Gain	
		Green Gain	
		Blue Gain	
		Red Offset	
		Green Offset	
	OverScan	Off / 1 / 2 / 3 / 4 / 5	
	HDMI Settings	HDMI Format	Auto / RGB / YUV
		HDMI Range	Auto / Enhanced / Normal
	Advanced	Tint	-50 - 50
		Color	-50 - 50
		Sharpness	0 - 31
		Gamma	1 / 2 / 3 / 4 / 5 / 6 / 7 / 8
		Brilliant Color	Off / 1 / 2 / 3 / 4 / 5 / 6 / 7 / 8 / 9 / 10
Noise Reduction		0 - 31	
Color Management		Primary color	R / G / B / C / M / Y
		Hue	-99 - 99
	Saturation	0 - 199	
	Gain	5 - 195	
Reset Color Settings	Reset / Cancel		





SOURCE	Quick Auto Search		Off / On
	3D Settings	3D Sync	Auto
			Off
			Frame Sequential
			Frame Packing
			Top-Bottom
	Standby Settings	3D Sync Invert	Disable / Invert
		Active VGA out	Off / On
		Active Audio out	Off / On
	Auto Power On	LAN Control	Off / On
		Computer	Disable / Enable
		CEC	Disable / Enable
	Power Saving	Direct Power On	Off / On
		Auto Power Off	Disable / 10 / 20 / 30 min
	Smart Restart	Sleep Timer	Disable / 30 min / 1 hr / 2 hr / 3 hr / 4 hr / 8 hr / 12 hr
		Energy Saving	Enable / Disable
	Quick Power Off		Disable / Enable
		LAN Control Settings	LAN Settings
	Projector IP Address		
	Subnet Mask		
	Default Gateway		
DNS Server			
	Apply		



SYSTEM
SETTING:
BASIC

SYSTEM SETTING: BASIC	Language	English / Deutsch / Français / Español / Italiano / Русский / 한국어 / ไทย / Português / 简体中文 / 繁體中文 / 日本語 / Nederlands / Svenska / Türkçe / Čeština / Suomi / Polski / Indonesia / العربية / हिन्दी			
	Projector Position		Front Table / Rear Table / Rear Ceiling / Front Ceiling		
	Menu Settings	Menu Display Time	5 sec / 10 sec / 15 sec / 20 sec / 25 sec / 30 sec		
		Menu Position	Center / Top-Left / Top-Right / Bottom-Left / Bottom-Right		
	Blank Timer		Disable / 5 min / 10 min / 15 min / 20 min / 25 min / 30 min		
	Splash Screen		Black / Black / ViewSonic / Off		
	My Button	Auto Sync / Projector Position / Menu Position / Color Temp. / Brightness / Contrast / 3D Settings / Screen Color / Splash Screen / Message / Quick Auto Search / CEC / Audio Mode / Lamp Mode / DCR / Closed Caption / Power Saving / Informa- tion			
	Advanced	Pattern	Off / 1 / 2 / 3		
		Message	On / Off		
		Presentation Timer	Timer Period	1 ~ 240 min	
			Timer Display	Always / 1 min / 2 min / 3 min / Never	
			Timer Position	Top-Left / Bottom-Left / Top-Right / Bottom-Right	
			Timer Count- ing Direction	Count Down / Count Up	
Sound Reminder			On / Off		
Start Count- ing / Off	Yes / No				

 SYSTEM SETTING: ADVANCED	High Altitude Mode		Off / On	
	DCR		Off / On	
	Audio Settings	Audio Mode	Standard / Speech / Entertainment	
		Mute	Off / On	
		Audio Volume	0 - 20	
		Audio In 2	Audio / Microphone	
		Microphone Volume	0 - 10	
		Power On/Off Ring Tone	On / Off	
	Closed Caption		Off / CC1 / CC2 / CC3 / CC4	
	Lamp Settings	Lamp Mode	Normal / Eco / Dynamic / SuperEco	
		Reset Lamp Hours	Reset / Cancel	
		Lamp Hours		
	Filter Settings	Filter Mode	Off / On	
		Reset Filter Hours	Reset / Cancel	
		Filter Hours		
Remote Control Code		1 / 2 / 3 / 4 / 5 / 6 / 7 / 8 (All)		
Advanced	Security Settings	Change Password		
		Power on Lock	Off / On	
	Panel Key Lock	Off / On		
Reset Settings		Reset / Cancel		
 INFORMATION	Current System Status	Source		
		Color Mode		
		Resolution		
		Color System		
		Lamp Hours		
		Filter Hours		
		IP Address		
		MAC Address		
		Firmware Version		

DISPLAY

Screen Color

The Screen Color feature can help correct the projected picture's colors to prevent possible color difference between the source and projected pictures.

There are several precalibrated colors to choose from: Whiteboard, Greenboard, and Blackboard.

Aspect Ratio

Select how the picture fits on the screen:

PJD6250L/PJD6252L/PJD7325:

- Auto:
Scales an image proportionally to fit the projector's native resolution in its horizontal or vertical width. You want to make most use of the screen without altering the source image's aspect ratio.
- 4:3:
Scales an image so that it is displayed in the center of the screen with a 4:3 aspect ratio, as it displays them without aspect alteration.
- 16:9:
Scales an image so that it is displayed in the center of the screen with a 16:9 aspect ratio, as it displays them without aspect alteration.
- Anamorphic:
Scales a 16:9 aspect image vertically and horizontally in a non-linear manner so that it fills the screen with a 4:3 aspect ratio.
- 2.35: 1
Scales an image so that it is displayed in the center of the screen with a 2.35:1 aspect ratio without aspect alteration.

PJD6550W/PJD6552W/PJD7525W:

- Auto:
Scales an image proportionally to fit the projector's native resolution in its horizontal or vertical width. You want to make most use of the screen without altering the source image's aspect ratio.
- 4:3:
Scales an image so that it is displayed in the center of the screen with a 4:3 aspect ratio, as it displays them without aspect alteration.
- 16:9:
Scales an image so that it is displayed in the center of the screen with a 16:9 aspect ratio, as it displays them without aspect alteration.
- Panorama
Scales a 4:3 image vertically and horizontally in a non-linear manner so that it fills the screen.

- Anamorphic:

Scales a 2.35:1 aspect image so that it fills the screen.

- 2.35: 1

Scales an image so that it is displayed in the center of the screen with a 2.35:1 aspect ratio without aspect alteration.

- 16:10:

Scales an image so that it is displayed in the center of the screen with a 16:10 aspect ratio, as it displays them without aspect alteration.

Keystone

Manually correct distorted images resulting from an angled projection.

Press Keystone  on the projector or remote control to display the Keystone correction page.

Press  to correct keystone at the top of the image.



Press  to correct keystone at the bottom of the image.

Press  to correct keystone at the left of the image.

Press  to correct keystone at the right of the image.

Corner Adj.

Manually adjust four corners of the image by setting the horizontal and vertical values.

1. Press  to select one of the four corners and press **Enter**.
2. Press  to adjust vertical values.
3. Press  to adjust horizontal values.

Position

Displays the position adjacent page. This function is only available when a PC type input signal is selected.

Phase







Adjusts the clock phase to reduce image distortion. This function is only available when a PC type input signal is selected.

H. Size

Adjusts the horizontal width of the image. This function is only available when a PC type input signal is selected.

Zoom

Using the remote control

1. Press  on the remote control to display the Zoom bar.
2. Press  to magnify the picture to a desired size.
3. Press  repeatedly to magnify the picture to a desired size.
4. To navigate the picture, press **Enter** to switch to the panning mode and press the directional arrows (, , , ) to navigate the picture.

5. To reduce size of the picture, press **Enter** to switch back to the zoom in/out functionality, and press **Auto Sync** to restore the picture to its original size. You can also press ▼ repeatedly until it is restored to the original size.

Using the OSD menu

1. Press **Menu** and then press ► until the **DISPLAY** menu is highlighted.
2. Press ▼ to select **Zoom** and press **Enter**. The Zoom bar displays.
3. Repeat steps 3-5 in the section of Using the remote control above.

PICTURE

Color Mode

There are many factory presets optimized for various types of images.

- **Brightest:** Maximizes the brightness of the projected image. This mode is suitable for environments where extra-high brightness is required.
- **Dynamic:** Is designed for presentations under daylight environment to match PC and notebook coloring. In addition, the projector will optimize the image quality using the dynamic PC function in accordance with the projected contents.
- **Standard:** Is designed for presentations under daylight environment to match PC and notebook coloring.
- **ViewMatch:** Switches between high brightness performance and accurate color performance.
- **Movie:** Is appropriate for playing colorful movies. This mode is suitable for viewing in a blackened (little light) environment

Brightness

Brighten or darken the image.

Contrast

Sets the difference between light and dark areas.

Color Temp.

Sets a color temperature from Warm, Normal, Neutral and Cool.

- **Cool:** With the highest color temperature, Cool makes the image appear the most bluish white than other settings.
- **Neutral:** Makes images appear bluish white.
- **Normal:** Maintains normal colorings for white.
- **Warm:** Makes images appear reddish white.
- **Red Gain/Green Gain/Blue Gain:** Adjusts the contrast levels of Red, Green, and Blue.
- **Red Offset/Green Offset/Blue Offset:** Adjusts the brightness levels of Red, Green, and Blue.

OverScan

OverScan function removes the noise in a video image. Overscan the image to remove video encoding noise on the edge of video source.

HDMI Settings

HDMI Format

Selects appropriate HDMI format automatically or manually.

Note

- *This function is only available when the HDMI-input port is in use.*

HDMI Range

- Enhanced : The range for HDMI output signal is from 0 - 255.
- Normal: The range for HDMI output signal is from 16 - 235.

Advanced

Tint

Adjusts the red and green color tones of the image.

Color

The higher the value, the more reddish the picture becomes. The lower the value, the more greenish the picture becomes.

Sharpness

Adjusts the image to make it look sharper or softer.

Gamma

Effect the represent of dark scenery. With greater gamma value, dark scenery will look brighter.

Brilliant Color

This adjustable item utilizes a new color-processing algorithm and system level enhancements to enable higher brightness while providing true, more vibrant colors in picture. The range is from “1” to “10”. If you prefer a stronger enhanced image, adjust toward the maximum setting. For a smoother, more natural image, adjust toward the minimum setting.

Noise Reduction

This function reduces electrical image noise caused by different media players. The higher the setting, the less the noise.

Color Management

The Color Management provides six sets (RGBCMY) of colors to be adjusted. When you select each color, you can independently adjust its hue, saturation and gain according to your preference.

Reset Color Settings

Reset the Color Mode settings of the current input source to default values.

SOURCE

Quick Auto Search

Automatically scan through all the input source if the function in the OSD menu is On. The function will stop the signal auto scan process and fix the signal source you preferred if you turn Off the Quick Auto Search.

3D Settings

This projector features a 3D function which enables you to enjoy the 3D movies, videos, and sporting events in a more realistic way by presenting the depth of the images. You need to wear a pair of 3D glasses to view the 3D images.

3D Sync

When you discover the inversion of the image depth, enable this function to correct the problem.

3D Sync Invert

When you discover the inversion of the image depth, enable this function to correct the problem.

Standby Settings

Active VGA out

Set whether the VGA out function works when the projector is in standby (powered off but connected to AC power). When selecting **On**, **COMPUTER IN 1** will be output. When selecting **Off**, power consumption is under 0.5W.

Active Audio out

Set whether the audio out function works when the projector is in standby (powered off but connected to AC power). When selecting **On**, **AUDIO IN1** will be output. **AUDIO OUT** port is also active (from AUDIO IN 1). When selecting **Off**, power consumption is under 0.5W. When selecting **Off**, both **AUDIO IN** and **AUDIO OUT** are **Off**.

LAN Control

Set whether the network function works when the projector is in standby (powered off but connected to AC power).

Note

- *Less than 0.5W power consumption when LAN Control is turned Off.*
- *When Power Saving is On, the Active VGA out and Active Audio out settings are not available.*

Auto Power On

Computer

Selecting Enable the projector will turn on automatically when COMPUTER signal is detected.

CEC

This projector supports CEC (Consumer Electronics Control) function for synchronized power on/off operation via HDMI connection. That is, if a device that also supports CEC function is connected to the HDMI input of the projector, when the projector's power is turned off, the power of the connected device will also be turned off automatically. When the power of the connected device is turned on, the projector's power will be turned on automatically.

Note

- *When connected to the HDMI input of the projector via an HDMI cable, and its CEC function is turned on.*
- *Depending on the connected device, the CEC function may not work.*
- *The function can't be enabled when Active VGA out/Active Audio out function is disabled.*

Direct Power On

Selecting **On** the projector will turn on automatically after the power cord has been connected and power has been applied.

Auto Power Off

Power Saving

The projector lowers the projector power if no input source is detected after 5 minutes to prevent unnecessary waste of lamp life. You can further decide if you would like the projector to turn off automatically after a set period of time.

When **Disable** is selected, the projector power will be reduced to 30% after no signal is detected for 5 minutes.

If you select **10 min**, **20 min** or **30 min**, the projector power will be reduced to 30% after no signal is detected for 5 minutes. And when **10 min**, **20 min** or **30 min** is up, the projector will turn off automatically.

Sleep Timer

This function allows the projector to turn off automatically after a set period of time to prevent unnecessary waste of lamp life.

Smart Restart

It takes some time to initiate this function. Make sure the projector has been turned on for more than 4 minutes. If the projector is resumed by using the Smart Restart feature, this function can be executed immediately.

Quick Power Off

- **Enable:** Quick power on function speeds up the cooling process when turning off the projector.
- **Disable:** Turn off with cooling procedure.

Note

- *When Disable is selected, the Smart Restart function will be automatically turned Off.*

LAN Control Settings

Allow you to configure the wired LAN settings. Refer to page [44](#).

- LAN Settings:
 - When selecting "DHCP on", "Projector IP Address", "Subnet Mask", "Default Gateway" and "DNS Server" will be gray out.
 - When selecting "Static IP", "Projector IP Address", "Subnet Mask", "Default Gateway" and "DNS Server" will be available.
- Projector IP Address: Numerical address to identify networked computers.
 - The IP Address is the number that identifies this projector on the network. You cannot have two devices with the same IP Address on the same network.
 - The IP Address "0.0.0.0" is prohibited.
- Subnet Mask: A numeric value to define the number of bits used for a network address of a divided network (or subnet) in an IP Address.
 - The Subnet Mask "0.0.0.0" is prohibited.
- Default Gateway: A server (or router) to communicate across networks (subnets) that are divided by Subnet Mask.
- DNS Server: Setup DNS server address when DHCP is disable.
- Apply: Save and execute the wired LAN settings.

SYSTEM SETTING: BASIC

Language

Select the language used by the on-screen menu.

Projector Position

Adjust the picture to match the orientation of the projector: upright or upside-down, in front of or behind the screen. Invert or reverse the image accordingly.

Menu Settings

Menu Display Time

Duration of OSD menu display countly starts (at idle state by second).

Menu Position

Choose the menu location on the display screen.

Blank Timer

Sets the image blank time when the Blank Timer feature is activated, once elapsed the image will return to the screen.

Splash Screen

Allows you to select which logo screen will display during projector start-up.

My Button

Allow user to define a short cut key on the remote control, and the function item is selected in OSD menu. Available options are: Auto Sync, Projector Position, Menu Position, Color Temp., Brightness, Contrast, 3D Settings, Screen Color, Splash Screen, Message, Quick Auto Search, CEC, Audio Mode, Lamp Mode, DCR, Closed Caption, Power Saving and Information.

Advanced

Pattern

Display embedded test pattern.

Message

Enable or disable the message box at the right bottom of the screen.

Presentation Timer

Remind the presenter to finish the presentation within a certain time frame. See "[Setting the presentation timer](#)" on page 26.

SYSTEM SETTING: ADVANCED

High Altitude Mode

Use this function to allow the fans operate at full speed continuously to achieve proper high altitude cooling of the projector.

DCR

DCR (Dynamic Contrast Ratio): Enable DCR will further enhance contrast ratio by darkening the black scenes. Disable DCR will resume to normal contrast performance. DCR will impact lamp life and system noise performance.

Audio Settings

See ["Adjusting the sound" on page 50](#) for details.

Audio Mode

Press ◀/▶ to select a preferred audio mode.

Mute

Cuts off the sound temporarily.

Audio Volume

Adjusts the projector's volume level.

Audio In 2

Switch Audio In 2 function for Audio in or Microphone in function.

Microphone Volume

Adjust the microphone's volume level.

Power On/Off Ring Tone

Setting the sound mute or changing the sound level will not affect the Power On/Off Ring Tone. The only way to change Power On/Off Ring Tone is setting On or Off here.

Closed Caption

Enable or disable closed captions by selecting CC1 (closed caption1, the most common channel), CC2, CC3, CC4, T1, T2 or Off.

Lamp Settings

Lamp Mode

Sets the Lamp Mode.

- Normal: 100% lamp power
- Economic: 80% lamp power
- Dynamic: 30~100% lamp power based on signal
- Sleep: 30% lamp power

Reset Lamp Hours

Reset the lamp Hour to 0 hours.

Lamp Hours

Display the lamp's elapsed operating time (in hours).

Filter Settings (Optional)

Filter Mode

Use this function to activate filter mode after the projector is installed an optional filter cover.

Reset Filter Hours

Reset the filter Hour to 0 hours.

Filter Hours

Display the filter's elapsed operating time (in hours).

Remote Control Code

See ["Remote control code" on page 10](#) for details.

Advanced

Security Settings

- Change Password: Allows you to set or change the password.
- Power on Lock: If you enable this function, you will have to enter the password next time you turn on the projector.

See ["Securing the projector" on page 23](#) for details.

Panel Key Lock

Disables or enables all panel key functions except Power on the projector and keys on the remote control. See ["Locking control keys" on page 25](#) for details.

Reset Settings

Restore settings to factory default. The following settings will still remain: Keystone, Language, Projector Position, High Altitude Mode, Security Settings, Remote Control Code.

INFORMATION

Current System Status

Shows the current system status.

Source

Shows the current signal source.

Color Mode

Shows the selected mode in the Color Mode menu.

Resolution

Shows the native resolution of the input signal.

Color System

Shows input system format, NTSC, PAL, SECAM, or RGB.

Lamp Hours

Displays the number of hours the lamp has been used.

Filter Hours

Displays the number of hours the filter has been used.

IP Address

Display the IP address.

MAC Address

Display the MAC address.

Firmware Version

Shows firmware version.

Controlling the projector through a LAN environment

You can manage and control the projector from one or more remote computers when they are properly connected to the same local area network.

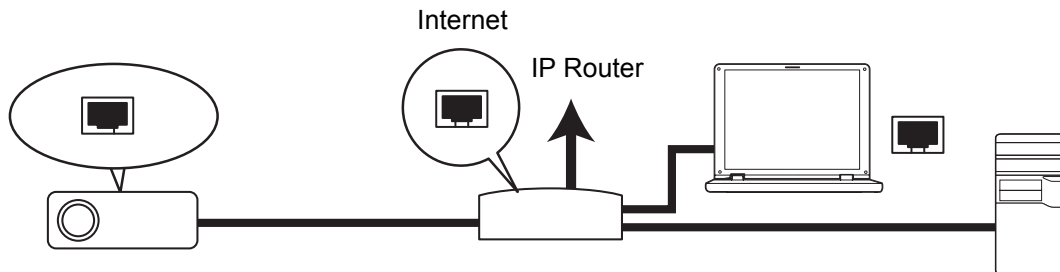

If you are in a DHCP on environment:

1. Take a RJ45 cable and connect one end to the RJ45 LAN input jack of the projector and the other end to the RJ45 port on your Ethernet or router.
2. Press **Menu** and then go to **SOURCE > LAN Control Settings** menu.
3. Make sure the **LAN Settings** is **DHCP on**.
4. Press **▼** to highlight **Apply** and press **Enter**.
5. Please wait for around 15 - 20 seconds, and then re-enter the Wired LAN page. The **Projector IP Address**, **Subnet Mask**, **Default Gateway** and **DNS Server** settings will be displayed. Note down the IP address displayed in the **Projector IP Address** row.

Important

- *If the Projector IP Address still does not appear, contact your network administrator.*
- *If the RJ45 cables are not properly connected, the Projector IP Address, Subnet Mask, Default Gateway and DNS Server settings will display 0.0.0.0. Make sure the cables are properly connected and perform the procedures above again.*
- *If you wish to connect to the projector in its standby mode, be sure you have selected RJ45 and obtained the Projector IP Address, Subnet Mask, Default Gateway and DNS Server information when the projector is on.*

If you are in a Static IP environment:

1. Repeat steps 1-2 above.
2. Make sure the **LAN Settings** is **Static IP**.
3. Contact your ITS administrator for information on the **Projector IP Address**, **Subnet Mask**, **Default Gateway**, and **DNS Server** settings.
4. Press **▼** to select the item you want to modify and press **Enter**.
5. Press **◀ / ▶** to move the cursor and then enter the value.
6. To save the settings, press **Enter**. If you do not want to save the settings, press **Exit**.
7. Press **▼** to highlight **Apply** and press **Enter**.

Important

- **If the RJ45 cables are not properly connected, the Projector IP Address, Subnet Mask, Default Gateway and DNS Server settings will display 0.0.0.0. Make sure the cables are properly connected and perform the procedures above again.**
- **If you wish to connect to the projector in its standby mode, be sure you have selected RJ45 and obtained the Projector IP Address, Subnet Mask, Default Gateway and DNS Server information when the projector is on.**

Controlling the projector remotely through a web browser

Once you have the correct IP address for the projector and the projector is on or in standby mode, you can use any computer that is on the same local area network to control the projector.

- **If you are using Microsoft Internet Explorer, make sure it is version 7.0 or higher.**
- **The screen shots in this manual are for reference only, and may differ from the actual design.**

1. Enter the address of the projector in the address bar of your browser and press **Enter**.

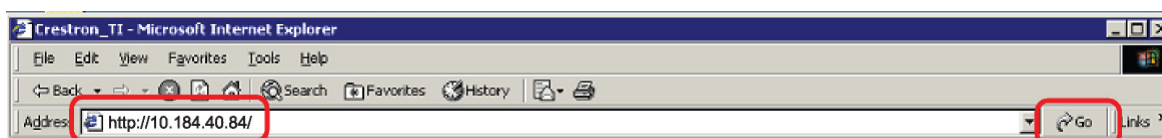

2. The main page of the Network Control appears.

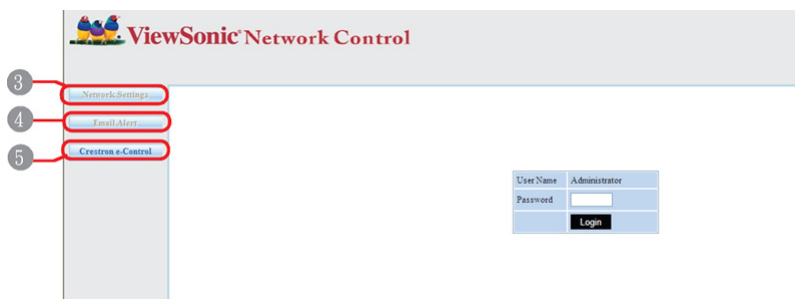

- **Accessing to Network Settings or Email Alert page requires Administrator password. The default password is "0000".**

- This page allows you to make adjustments to the AMX and SNMP settings. In the AMX device discover row, when ON is selected, the projector can be detected by controllers of AMX connected to the same network. For the Details of AMX Device Discovery, visit the AMX web site at <http://www.amx.com/>.

- If your projector is connected to a network which supports Simple Mail Transfer Protocol (SMTP), you can configure it to alert you via email on significant events.

- The Crestron (e-Control) page displays the Crestron e-Control user interface. See "[About Crestron e-Control®](#)" on page 47 for details.

Please pay attention to the limitation of input length (including space and other punctuation keys) in the list blow:

Category Item	Input-Length	Maximum Number of Characters
Network Settings	DHCP/Manual	(N/A)
	IP Address	XXX.XXX.XXX.XXX
	Subnet Mask	XXX.XXX.XXX.XXX
	Gateway	XXX.XXX.XXX.XXX
	DNS Server	XXX.XXX.XXX.XXX
	AMX device discovery	(N/A)
	Administrator	(N/A)
	New Password	4
	Confirm Password	4
	SysLocation	22
SysName	22	
SysContact	22	

Email Alert	Email Setting	To	40
		Cc	40
		Subject	15
		From	40
	SMTP Setting	Server	30
		User Name	40
		Password	14
	Alert Condition	Fan Error	(N/A)
		Lamp Error	(N/A)
		Temperature Error	(N/A)
		Submit	(N/A)
		Issue Test Mail	(N/A)

• / > < \$ % + \ ' " are prohibited.

About Crestron e-Control®

1. The Crestron e-Control® page provides a variety of virtual keys to control the projector or adjust the projected pictures.

You can press ◀/▶ to reveal more buttons.

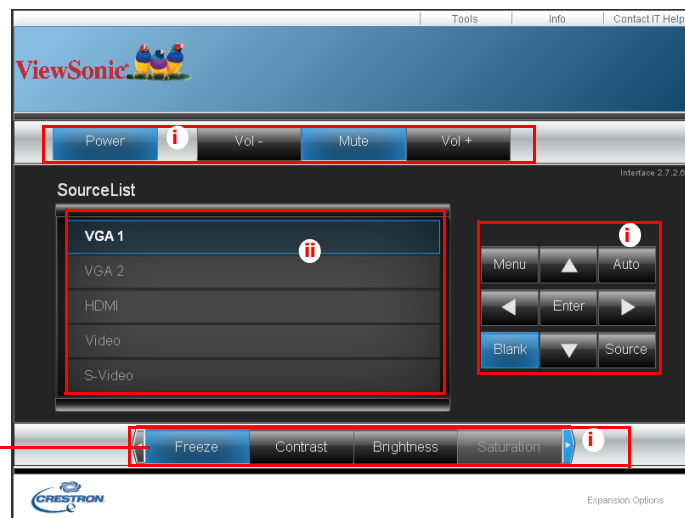

- i. These buttons function the same as the ones on the OSD menus or remote control.
- ii. To switch input source, click on your desired signal.

Important

- **The Menu button can also be used to go back to previous OSD menu, exit and save menu settings.**
- **The source list varies according to the connectors available on the projector.**
- **When you use the projector control panel or remote control to change the OSD menu settings, it may take a while for the web browser to synchronize these changes with the projector.**

2. The tools page allows you to manage the projector, configure the Lan control settings and secure access of remote network operation on this projector.

The screenshot shows the ViewSonic web interface with several configuration sections highlighted by red boxes and labeled with circled letters:

- Crestron Control (i):** Includes fields for Ip Addr (255.255.255.255), Ip Id (7), and Port (41794), with a Send button.
- Projector (ii):** Includes fields for Projector Name, Location, and Assigned To (ViewSonic Projector), with a Send button.
- User Password (iv):** Includes a checkbox for Enabled, New Password, and Confirm fields, with a Send button.
- Network Configuration (iii):** Includes a DHCP checkbox (checked/Enabled) and fields for Ip Address (192.168.0.193), Subnet Mask (255.255.255.0), Default Gateway (192.168.0.1), and DNS Server (192.168.0.1), with a Send button.
- Admin Password (v):** Includes a checkbox for Enabled, New Password, and Confirm fields, with a Send button.
- exit (vi):** A button at the bottom center to return to the previous page.

- i. This section is only used with the Crestron Control System. Please contact Crestron or refer to its user manual for setup information.
 - ii. You can name the projector, keep track of its location and the person in charge of it.
 - iii. You can adjust the **Lan control setting**.
 - iv. Once set, access to the remote network operation on this projector has been password-protected.
 - v. Once set, access to the tools page has been password-protected.
 - **To prevent errors, only input the English alphabet and digits on the tools page.**
 - **After making the adjustments, press the Send button and the data will be saved in the projector.**
 - vi. Press **exit** to go back to the Crestron remote network operation page.
- Please pay attention to the limitation of input length (including space and other punctuation keys) in the list below:

Category Item	Input-Length	Maximum Number of Characters
Crestron Control	IP Address	15
	IP ID	2
	Port	5
Projector	Projector Name	10
	Location	9
	Assigned To	9
Network Configuration	DHCP (Enabled)	(N/A)
	IP Address	15
	Subnet Mask	15
	Default Gateway	15
	DNS Server	15
User Password	Enabled	(N/A)
	New Password	20
	Confirm	2
Admin Password	Enabled	(N/A)
	New Password	20
	Confirm	20

3. The info page displays the information and status of this projector.

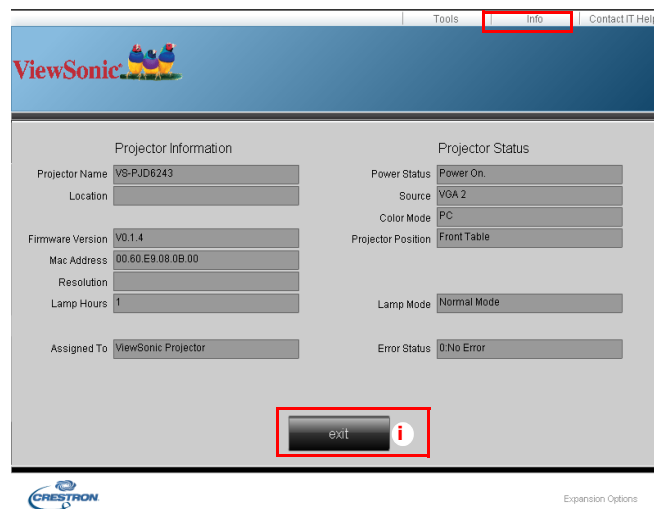

- i. Press **exit** to go back to the Crestron remote network operation page.
4. After pressing the button “Contact IT Help”, the HELP DESK window will appear in the upper right corner of the screen. You will be able to deliver messages to RoomView™ software administrators/users who connect to the same local area network.

• For more information, visit <http://www.crestron.com> & www.crestron.com/getroomview.

Crestron RoomView

On the “Edit Room” page, enter the IP Address (or hostname) as shown on the projector’s on-screen display (OSD) menu, and “02” for IPID, “41794” for the reserved Crestron control port.

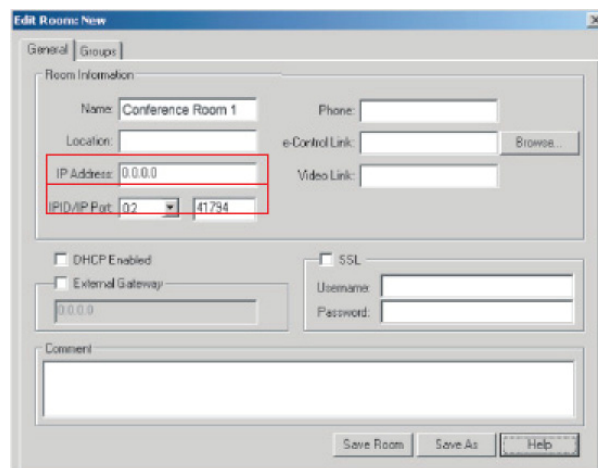

About Crestron RoomView™ setting and command method, please access below website to get RoomView™ User Guide and more information: http://www.crestron.com/products/roomview_connected_embedded_projectors_devices/resources.asp

Using the projector in standby mode

Some of the projector functions are available in standby mode (plugged in but not turned on). To use these functions, be sure you have turned on the corresponding menus under **SOURCE > Standby Settings**, and the cable connections are correctly made. For the connection methods, see the "[Connection](#)" on page 14 chapter.

Active VGA out

Selecting **On** outputs a VGA signal when the **COMPUTER IN 1** and **COMPUTER OUT** sockets are correctly connected to devices. The projector outputs the signal received only from **COMPUTER IN 1**.

Active Audio out

Selecting **On** outputs an audio signal when the **AUDIO IN 1** socket is correctly connected to a proper device.

LAN Control

Selecting **On** allows the projector to provide the network function when it is in standby mode. See "[Controlling the projector through a LAN environment](#)" on page 44 for details.

Adjusting the sound

The sound adjustments made as below will have an effect on the projector speaker. Be sure you have made a correct connection to the projector audio input/output jacks. See "[Connection](#)" on page 14 for more details.

Adjusting the audio mode

1. Open the OSD menu and go to the **SYSTEM SETTING: ADVANCED > Audio Settings > Audio Mode** menu.
2. Press **◀ / ▶** to select a preferred audio mode.
 - *If available, you can press **Audio Mode** on the remote control to select a preferred audio mode.*

Muting the sound

1. Open the OSD menu and go to the **SYSTEM SETTING: ADVANCED > Audio Settings > Mute** menu.
2. Press **◀ / ▶** to select **On**.
 - *If available, you can press **Mute** on the remote control to toggle the projector audio between on and off.*

Adjusting the sound level

1. Open the OSD menu and go to the **SYSTEM SETTING: ADVANCED > Audio Settings > Audio Volume** menu.

2. Press ◀ / ▶ to select a desired sound level.

- *If available, you can press 🔊+ / 🔊- on the remote control to adjust the projector's sound level.*

Adjusting the Audio In 2 setting

1. Open the OSD menu and go to the **SYSTEM SETTING: ADVANCED > Audio Settings > Audio In 2** menu.
2. Press ◀ / ▶ to decide the audio input source for the **AUDIO IN 2/MIC** port. This will affect the connection method for different devices, and where the sound is from.

- When **Audio** is selected:

Device	COMPUTER IN 1	COMPUTER IN 2	Video/S-Video
Audio input port	AUDIO IN 1	AUDIO IN 2	AUDIO IN 2
The projector can play the sound from...	AUDIO IN 1	AUDIO IN 2	AUDIO IN 2
Audio output port	AUDIO OUT	AUDIO OUT	AUDIO OUT

- *The selected input signal determines which sound will be played by the projector speaker, and which sound will be output from the projector when AUDIO OUT is connected. For instance, if you select a D-Sub / Comp. 1 source, the projector can play the sound received from AUDIO IN 1.*

- When **Microphone** is selected:

Device	COMPUTER IN 1	COMPUTER IN 2	Video/S-Video
The projector can play the sound from...	MIC	MIC	MIC
Audio output port	AUDIO OUT	AUDIO OUT	AUDIO OUT

Adjusting the microphone sound level

1. Open the OSD menu and go to the **SYSTEM SETTING: ADVANCED > Audio Settings > Microphone Volume** menu.
 2. Press ◀ / ▶ to select a desired sound level.
- *This function is only available when the SYSTEM SETTING: ADVANCED > Audio Settings > Audio In 2 menu is set to Microphone.*

Turning off the Power On/Off Ring Tone

1. Open the OSD menu and go to the **SYSTEM SETTING: ADVANCED > Audio Settings > Power On/Off Ring Tone** menu.
 2. Press ◀ / ▶ to select **Off**.
- *The only way to change Power On/Off Ring Tone is setting On or Off here. Setting the sound mute or changing the sound level will not affect the Power On/Off Ring Tone.*

Maintenance

The projector needs proper maintenance. You should keep the lens clean as dust, dirt or spots will project on the screen and diminish image quality. If any other parts need replacing, contact your dealer or qualified service personnel. When cleaning any part of the projector, always switch off and unplug the projector first.



Warning

- ***Never open any of the covers on the projector. Dangerous electrical voltages inside the projector can cause severe injury. Do not attempt to service this product yourself. Refer all servicing to qualified service personnel.***

Cleaning the lens

Gently wipe the lens with lens cleaning paper. Do not touch the lens with your hands.

Cleaning the projector housing

Gently wipe with a soft cloth. If dirt and stains are not easily removed, use a soft cloth dampened with water, or water and neutral detergent, and wipe dry with a soft, dry cloth.



Note

- ***Turn off the projector and remove the AC power cord from the power outlet before beginning maintenance work.***
- ***Make sure the lens is cool before cleaning.***
- ***Do not use detergents or chemicals other than those noted above. Do not use benzene or thinners.***
- ***Do not use chemical sprays.***
- ***Use a soft cloth or lens paper only.***

Installing the dust filter (optional accessory)

Caution

- *It is important to clean the dust filter every 100 hours after the dust filter is installed.*
- *Be sure to turn off the projector and unplug it from power source before installing or detaching the filter.*
- *If your projector is ceiling-mounted or is not easily accessible, pay special attention to your personal safety when replacing the dust filter.*

Installing the dust filter

1. Be sure to turn off the projector and unplug it from power source.
2. As the arrows shown to the right, fit the filter by aligning and inserting it into the projector slots. Make sure it clicks into place.

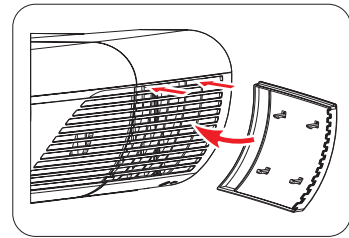

For first time installation:

3. Open the OSD menu and go to the **SYSTEM SETTING: ADVANCED > Filter Settings** menu.
4. Press **Enter** and the **Filter Settings** page is displayed.
5. Highlight **Filter Mode** and select "On". The filter timer starts counting and the projector will remind you to clean the filter when the filter is in use for over 100 hours.

Caution

- *Set Filter Mode to On only when using the projector after the dust filter (optional accessory) is properly attached. Failing to do so will result in a shorter lamp life.*

Obtaining the filter hour information

1. Open the OSD menu and go to the **SYSTEM SETTING: ADVANCED > Filter Settings** menu.
2. Press **Enter** and the **Filter Settings** page is displayed.
3. You will see the **Filter Hours** information on the menu.

Cleaning the dust filter

1. Be sure to turn off the projector and unplug it from power source.
2. Press the latches on the dust filter and remove the filter from the projector.
3. Use a small vacuum cleaner or a soft brush to sweep the dust on the filter away.
4. Re-install the dust filter.

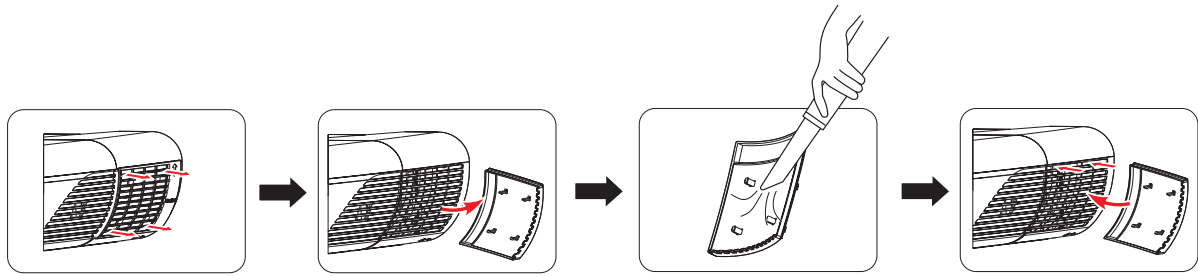

Resetting the filter timer

5. Open the OSD menu and go to the **SYSTEM SETTING: ADVANCED > Filter Settings** menu.
6. Press **Enter** and the **Filter Settings** page is displayed.
7. Highlight **Reset Filter** Hours and press **Enter**. A warning message is displayed asking if you want to reset the filter timer.
8. Highlight **Reset** and press **Enter**. The lamp timer will be reset to '0'.

Caution

- *Remember to use **Filter Mode to Off** in the **SYSTEM SETTING: ADVANCED > Filter Settings** menu when using the projector with the dust filter removed. Setting **Filter Mode to Off** does not reset the filter timer. The timer will continue counting the next time you fit the filter back on and set **Filter Mode to On**.*

Installing the cable management cover (optional accessory)

1. Make sure that all the cables are properly connected to the projector.
2. Attach the cable management cover to the back of the projector.
3. Tighten the screws that secure the cable management cover.

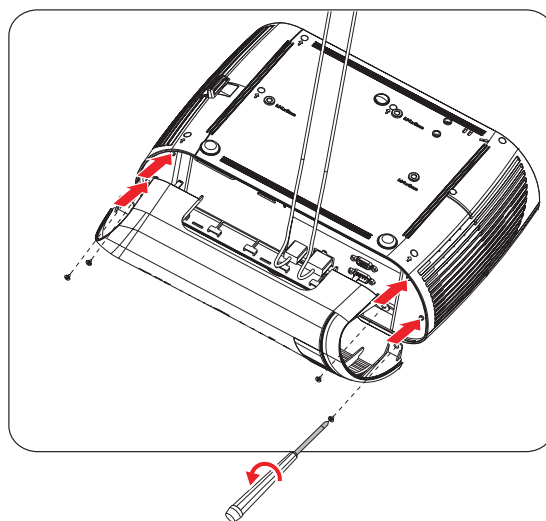

Replacing the lamp

As the projector operates over time, the brightness of the projector lamp gradually decreases and the lamp becomes more susceptible to breakage. We recommend replacing the lamp if a warning message is displayed. Do not attempt to replace the lamp yourself. Contact the qualified service personnel for replacement.

Note

- *The lamp is extremely hot right after turning off the projector. If you touch the lamp, you may scald your finger. When you replace the lamp, wait for at least 45 minutes for the lamp to cool down.*
- *Do not touch the lamp glass at any time. The lamp may explode due to improper handling, including the touching of the lamp glass.*
- *Lamp lifetime may differ from lamp to lamp and according to the environment of use. There is no guarantee of the same lifetime for each lamp. Some lamps may fail or terminate their lifetime in a shorter period of time than other similar lamps.*
- *A lamp may explode as a result of vibration, shock or degradation as a result of hours of use as its lifetime draws to an end. Risk of explosion may differ according to the environment or conditions in which the projector and lamp are being used.*
- *Wear protective gloves and eyeglasses when fixing or detaching the lamp.*
- *Faster on-off-cycles will damage the lamp and reduce lamp life. Wait at least for 5 minutes to turn off the projector after powering on.*
- *Do not operate the lamp in proximity to paper, cloth, or other combustible material nor cover it with such materials.*
- *Do not operate the lamp in an atmosphere containing an inflammable substance, such as thinner.*
- *Thoroughly ventilate the area or the room when operating the lamp in an oxygen atmosphere (in the air). If ozone is inhaled, it could cause headaches, nausea, dizziness, and other symptoms.*
- *The inorganic mercury is involved in the lamp. If the lamp bursts, the mercury inside the lamp will be exposed. Leave the area immediately if the lamp shatters while being operated and ventilate the area for at least 30 minutes in order to avoid the inhalation of mercury fumes. Otherwise it could be harmful to user's health.*

1. Turn off the projector.
2. If the projector is installed in a ceiling mount, remove it.
3. Unplug the power cord.
4. Loosen the screw in the side of the lamp cover. **1**
5. Remove the cover. **2**
6. Loosen the screws from the lamp module. **3**
7. Raise the handle and pull out the lamp module slowly and carefully. **4**
8. Insert the new lamp module into the projector and tighten the screws.
9. Replace the lamp cover and tighten the screw.
10. Turn on the projector. If the lamp does not turn on after the warm-up period, try reinstalling the lamp.
11. Reset the lamp hour. Refer to the “**SYSTEM SETTING: ADVANCED > Lamp Settings > Reset Lamp Hours**” menu.

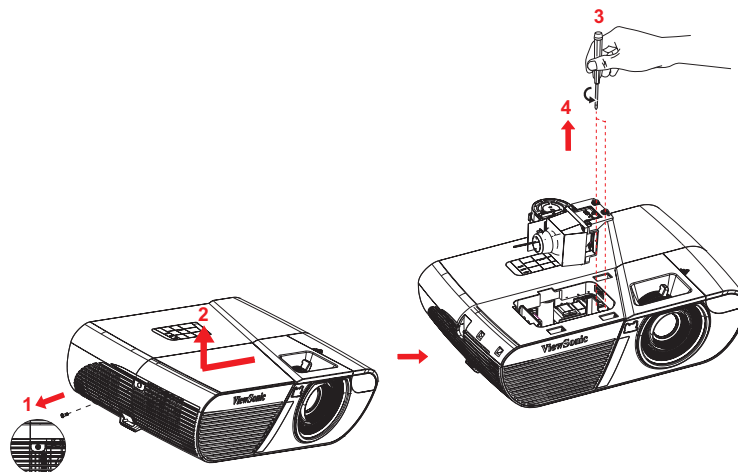

Note

- *Dispose the used lamp according to local regulations.*
- *Ensure that screws are tightened properly. Screws not tightened fully may result in injury or accidents.*
- *Since the lamp is made of glass, do not drop the unit and do not scratch the glass.*
- *Do not reuse the old lamp. This could cause the lamp to explode.*
- *Be sure to turn off the projector and unplug the AC power cord before replacing the lamp.*
- *Do not use the projector with the lamp cover removed.*

Specifications

Model name	PJD6250L	PJD6252L	PJD7325	PJD6550W	PJD6552W	PJD7525W
Display system	Single 0.55" DLP panel			Single 0.65" DLP panel		
Resolution	XGA (1024 x 768 pixels)			WXGA (1280 x 800 pixels)		
Zoom	1.1x			1.2x		
F/No.	2.5 - 2.7			2.56		
Focal length	22.08 - 24.28mm			20.99 - 25.61mm		
Screen size	30" - 300"					
Lamp	203W	220W	250W	203W	220W	250W
Input terminal	D-Sub 15-pin x 2, HDMI x 1, S-Video x 1, Video x 1, Audio signal input (3.5 mm stereo mini jack) x 1, Audio signal input/Microphone input x 1					
Output terminal	D-Sub 15 pin x 1, Audio signal output (3.5 mm stereo mini jack) x 1, USB type A port for power charging (5V/2A)					
Control terminal	RS-232 x 1, Mini-B USB x1 (supports firmware upgrade and remote mouse control), RJ45 x 1					
Speaker	16 watt x 1					
Video compatibility	NTSC, NTSC 4.43 PAL, PAL-N, PAL M SECAM, HDTV (480i/p, 576p, 720p, 1080i/p), Composite video					
Scanning frequency	31 - 100 KHz					
Horizontal frequency	24 - 120 Hz					
Vertical frequency	Operating: Temperature: 0°C to 40°C Humidity: 10%-90% Storage: Temperature: -20°C to 60°C Humidity: 10%-90%					
Environment	AC 100-240 V, 50 - 60 Hz, 5.2A					
Power requirement	265W (Max.)	275W (Max.)	315W (Max.)	265W (Max.)	275W (Max.)	315W (Max.)
Power consumption	362 x 231 x 109 mm					
Dimension (W x D x H)	2.7 kg (6.0 lb) without cable management cover					
Weight	Note: Design and Specifications are subject to change without prior notice.					

Dimensions

362 mm (W) x 231 mm (D) x 109 mm (H)

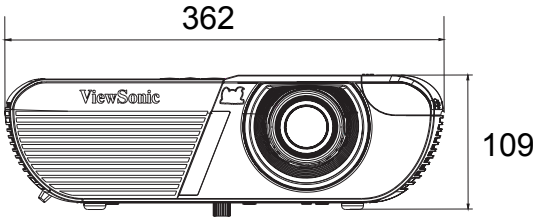
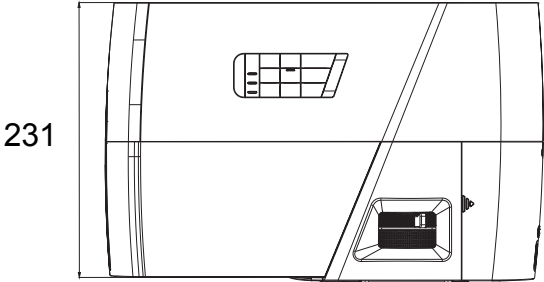

Ceiling mount installation

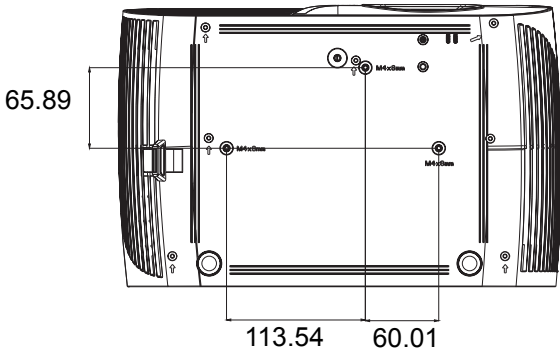

Ceiling mount screws:
M4 x 8 (Max. L = 8 mm)

Unit: mm

Appendix

LED indicator messages

LED Type	Color	Status	Meaning
Power LED	Blue	Solid	Normal power of standby mode .
Temp LED	Red	Off	
Lamp LED	Red	Off	
Power LED	Blue	Flash	Low power of standby mode.
Temp LED	Red	Off	
Lamp LED	Red	Off	
Power LED	Blue	Flash	Powering up
Temp LED	Red	Off	
Lamp LED	Red	Off	
Power LED	Blue	Solid	Normal operation
Temp LED	Red	Off	
Lamp LED	Red	Off	
Power LED	Blue	Solid	Powering down
Temp LED	Red	Off	
Lamp LED	Red	Off	
Power LED	Blue	Solid	If the projector system has some problems with its fans, the projector will shut down.
Temp LED	Red	Flash	
Lamp LED	Red	Flash	
Power LED	Blue	Solid	The lamp has reached its end of life and must be changed soon. The lamp will continue to operate until it fails. Change the lamp. If the lamp is off, then the ballast will become malfunction.
Temp LED	Red	Off	
Lamp LED	Red	Flash	
Power LED	Blue	Flash	1. Temperature is too high. The lamp will turn off. The fan motor is cooling the lamp. Or 2. The cooling process is not complete after the projector is shut down and re-started right away.
Temp LED	Red	Flash	
Lamp LED	Red	Off	
Power LED	Blue	Flash	The lamp ignition failed. If temperature is too high, the fans will cool the lamp.
Temp LED	Red	Off	
Lamp LED	Red	Solid	
Power LED	Blue	Solid	Color wheel start fail
Temp LED	Red	Solid	
Lamp LED	Red	Solid	

Compatibility modes

Supported 3D signal for PC input

Resolution	Horizontal frequency (KHz)	Vertical frequency (Hz)	Pixel Frequency (MHz)	3D frame sequential	3D top bottom	3D side by side
640 x 480	59.94	31.469	25.175	⊙	⊙	⊙
	72.809	37.861	31.500			
	75	37.5	31.500			
	85.008	43.269	36.000			
720 x 400	70.087	31.469	28.3221			
800 x 600	60.317	37.879	40.000	⊙	⊙	⊙
	72.188	48.077	50.000			
	75	46.875	49.500			
	85.061	53.674	56.250			
	119.854	77.425	83.000	⊙		
1024 x 768	60.004	48.363	65.000	⊙	⊙	⊙
	70.069	56.476	75.000			
	75.029	60.023	78.750			
	84.997	68.667	94.500			
	119.989	97.551	115.5	⊙		
1152 x 864	75	67.5	108			
1280 x 720	60	45	74.250	⊙	⊙	⊙
	120	90.000	148.500	⊙		
1280 x 768	59.87	47.776	79.5	⊙	⊙	⊙
1280 x 800	59.81	49.702	83.500	⊙	⊙	⊙
	74.934	62.795	106.500			
	84.88	71.554	122.500			
	119.909	101.563	146.25	⊙		
1280 x 1024	60.02	63.981	108.000		⊙	⊙
	75.025	79.976	135.000			
	85.024	91.146	157.500			
1280 x 960	60	60	108.000		⊙	⊙
	85.002	85.938	148.500			
1360 x 768	60.015	47.712	85.5		⊙	⊙
1440 x 900	59.887	55.935	106.500		⊙	⊙
1400 x 1050	59.978	65.317	121.750		⊙	⊙
1600 x 1200	60	75	162.000		⊙	⊙
1680 x 1050	59.954	65.29	146.25		⊙	⊙
1920 x 1200	59.95	74.038	154.000		⊙	⊙
640 x 480 @67Hz	66.667	35	30.240			
832 x 624 @75Hz	74.546	49.722	57.280			
1024 x 768 @75Hz	75.02	60.241	80.000			
1152 x 870 @75Hz	75.06	68.68	100.000			

- The timings showing above may not be supported due to EDID file and VGA graphic card limitations. It is possible that some timings cannot be chosen.
- 120Hz is signals are supported for frame sequential format only.

Supported timing for Component-YPbPr input

Timing	Resolution	Vertical Frequency (Hz)	Horizontal Frequency (kHz)	Pixel Frequency (MHz)
480i*	720 x 480	59.94	15.73	13.5
480p*	720 x 480	59.94	31.47	27
576i	720 x 576	50	15.63	13.5
576p	720 x 576	50	31.25	27
720/50p	1280 x 720	50	37.5	74.25
720/60p*	1280 x 720	60	45.00	74.25
1080/50i	1920 x 1080	50	28.13	74.25
1080/60i	1920 x 1080	60	33.75	74.25
1080/24P	1920 x 1080	24	27	74.25
1080/25P	1920 x 1080	25	28.13	74.25
1080/30P	1920 x 1080	30	33.75	74.25
1080/50P	1920 x 1080	50	56.25	148.5
1080/60P	1920 x 1080	60	67.5	148.5

- *Supported timing for 3D signal with Frame Sequential format.
- Displaying a 1080i(1125i)@60Hz or 1080i(1125i)@50Hz signal may result in slight image vibration.

Troubleshooting

Refer to the symptoms and measures listed below before sending the projector for repairs. If the problem persists, contact your local reseller or service center. Please refer to "LED Indicator Messages" as well.

Start-up problems

If no lights turn on:

- Be sure that the power cord is securely connected to the projector and the other end is plugged into an outlet with power.
- Press the power button again.
- Unplug the power cord and wait for a short while, then plug it in and press the power button again.

Image problems

If the searching source is displayed:

- Press **Source** to select an active input source.
- Be sure the external source is turned on and connected.
- For a computer connection, ensure your notebook computer's external video port is turned on. Refer to the computer manual.

If the image is out of focus:

- While displaying the on-screen menu, adjust the focus ring. (The image size should not change; if it does, you are adjusting the zoom, not the focus.)
- Check the projection lens to see if it needs cleaning.
- If the image is flickering or unstable for a computer connection:
- Press **Menu**, go to **DISPLAY** and adjust **Phase** or **H. Size**.

Remote control problems

If the remote control does not operate:

- Be sure nothing is blocking the remote control receiver on the front of the projector. Use the remote control within the effective range.
- Aim the remote control at the screen or at the front of the projector.
- Move the remote control so it is more directly in front of the projector and not as far to the side.

RS-232 command and configuration

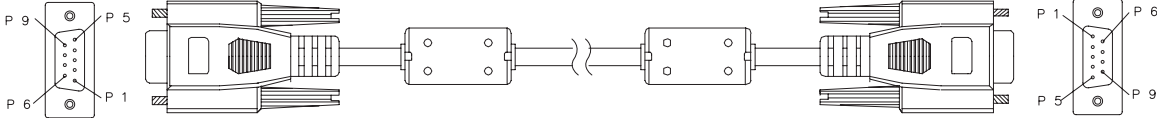

D-Sub 9 pin

1	1 CD
2	RXD
3	TXD
4	DTR
5	GND
6	DSR
7	RTS
8	CTS
9	RI

Wire List

C1	COLOR	C2
1	Black	1
2	Brown	3
3	Red	2
4	Orange	6
5	Yellow	5
6	Green	4
7	Blue	8
8	Purple	7
9	White	9
SHELL	DW	SHELL

Baud Rate	115200 bps
Data Length	8 bit
Parity Check	None
Stop Bit	1 bit
Flow Control	None

Function	Status	Action	cmd
Power	Write	Power on	0x06 0x14 0x00 0x04 0x00 0x34 0x11 0x00 0x00 0x5D
		Power off	0x06 0x14 0x00 0x04 0x00 0x34 0x11 0x01 0x00 0x5E
	Read	Power status (on/off)	0x07 0x14 0x00 0x05 0x00 0x34 0x00 0x00 0x11 0x00 0x5E
Reset all settings		Execute	0x06 0x14 0x00 0x04 0x00 0x34 0x11 0x02 0x00 0x5F
Reset Color Settings		Execute	0x06 0x14 0x00 0x04 0x00 0x34 0x11 0x2A 0x00 0x87
Splash Screen	Write	Splash Screen Black	0x06 0x14 0x00 0x04 0x00 0x34 0x11 0x0A 0x00 0x67
		Splash Screen Blue	0x06 0x14 0x00 0x04 0x00 0x34 0x11 0x0A 0x01 0x68
		Splash Screen ViewSonic	0x06 0x14 0x00 0x04 0x00 0x34 0x11 0x0A 0x02 0x69
		Splash Screen Screen Capture	0x06 0x14 0x00 0x04 0x00 0x34 0x11 0x0A 0x03 0x6A
		Splash Screen Off	0x06 0x14 0x00 0x04 0x00 0x34 0x11 0x0A 0x04 0x6B
	Read	Splash Screen status	0x07 0x14 0x00 0x05 0x00 0x34 0x00 0x00 0x11 0x0A 0x68
Quick Power Off	Write	Quick Power Off Off	0x06 0x14 0x00 0x04 0x00 0x34 0x11 0x0B 0x00 0x68
		Quick Power Off On	0x06 0x14 0x00 0x04 0x00 0x34 0x11 0x0B 0x01 0x69
	Read	Quick Power Off status	0x07 0x14 0x00 0x05 0x00 0x34 0x00 0x00 0x11 0x0B 0x69
High Altitude Mode	Write	High Altitude Mode Off	0x06 0x14 0x00 0x04 0x00 0x34 0x11 0x0C 0x00 0x69
		High Altitude Mode On	0x06 0x14 0x00 0x04 0x00 0x34 0x11 0x0C 0x01 0x6A
	Read	High Altitude Mode status	0x07 0x14 0x00 0x05 0x00 0x34 0x00 0x00 0x11 0x0C 0x6A
Lamp Mode	Write	Normal	0x06 0x14 0x00 0x04 0x00 0x34 0x11 0x10 0x00 0x6D
		Economic	0x06 0x14 0x00 0x04 0x00 0x34 0x11 0x10 0x01 0x6E
		Dynamic	0x06 0x14 0x00 0x04 0x00 0x34 0x11 0x10 0x02 0x6F
		Sleep Mode	0x06 0x14 0x00 0x04 0x00 0x34 0x11 0x10 0x03 0x70
	Read	Lamp Mode status	0x07 0x14 0x00 0x05 0x00 0x34 0x00 0x00 0x11 0x10 0x6E
Message	Write	Message Off	0x06 0x14 0x00 0x04 0x00 0x34 0x11 0x27 0x00 0x84
		Message On	0x06 0x14 0x00 0x04 0x00 0x34 0x11 0x27 0x01 0x85
	Read	Message status	0x07 0x14 0x00 0x05 0x00 0x34 0x00 0x00 0x11 0x27 0x85
Projector Position	Write	Front Table	0x06 0x14 0x00 0x04 0x00 0x34 0x12 0x00 0x00 0x5E
		Rear Table	0x06 0x14 0x00 0x04 0x00 0x34 0x12 0x00 0x01 0x5F
		Rear Ceiling	0x06 0x14 0x00 0x04 0x00 0x34 0x12 0x00 0x02 0x60
		Front Ceiling	0x06 0x14 0x00 0x04 0x00 0x34 0x12 0x00 0x03 0x61
	Read	Projector position status	0x07 0x14 0x00 0x05 0x00 0x34 0x00 0x00 0x12 0x00 0x5F
3D Sync	Write	OFF	0x06 0x14 0x00 0x04 0x00 0x34 0x12 0x20 0x00 0x7E
		Auto	0x06 0x14 0x00 0x04 0x00 0x34 0x12 0x20 0x01 0x7F
		Frame Sequential	0x06 0x14 0x00 0x04 0x00 0x34 0x12 0x20 0x02 0x80
		Frame Packing	0x06 0x14 0x00 0x04 0x00 0x34 0x12 0x20 0x03 0x81
		Top-Bottom	0x06 0x14 0x00 0x04 0x00 0x34 0x12 0x20 0x04 0x82
		Side-by-Side	0x06 0x14 0x00 0x04 0x00 0x34 0x12 0x20 0x05 0x83
	Read	3D Sync Status	0x07 0x14 0x00 0x05 0x00 0x34 0x00 0x00 0x12 0x20 0x7F
3D Sync Invert	Write	Off	0x06 0x14 0x00 0x04 0x00 0x34 0x12 0x21 0x00 0x7F
		On	0x06 0x14 0x00 0x04 0x00 0x34 0x12 0x21 0x01 0x80
	Read	3D Sync Invert Status	0x07 0x14 0x00 0x05 0x00 0x34 0x00 0x00 0x12 0x21 0x80

Contrast	Write	Contrast decrease	0x06 0x14 0x00 0x04 0x00 0x34 0x12 0x02 0x00 0x60
		Contrast increase	0x06 0x14 0x00 0x04 0x00 0x34 0x12 0x02 0x01 0x61
	Read	Contrast ratio	0x07 0x14 0x00 0x05 0x00 0x34 0x00 0x00 0x12 0x02 0x61
Brightness	Write	Brightness decrease	0x06 0x14 0x00 0x04 0x00 0x34 0x12 0x03 0x00 0x61
		Brightness increase	0x06 0x14 0x00 0x04 0x00 0x34 0x12 0x03 0x01 0x62
	Read	Brightness	0x07 0x14 0x00 0x05 0x00 0x34 0x00 0x00 0x12 0x03 0x62
Aspect ratio	Write	Aspect ratio Auto	0x06 0x14 0x00 0x04 0x00 0x34 0x12 0x04 0x00 0x62
		Aspect ratio 4:3	0x06 0x14 0x00 0x04 0x00 0x34 0x12 0x04 0x02 0x64
		Aspect ratio 16:9	0x06 0x14 0x00 0x04 0x00 0x34 0x12 0x04 0x03 0x65
		Aspect ratio 16:10	0x06 0x14 0x00 0x04 0x00 0x34 0x12 0x04 0x04 0x66
		Aspect ratio Anamorphic	0x06 0x14 0x00 0x04 0x00 0x34 0x12 0x04 0x06 0x68
	Aspect ratio Wide	0x06 0x14 0x00 0x04 0x00 0x34 0x12 0x04 0x06 0x68	
	Read	Aspect ratio	0x07 0x14 0x00 0x05 0x00 0x34 0x00 0x00 0x12 0x04 0x63
Auto Adjust		Execute	0x06 0x14 0x00 0x04 0x00 0x34 0x12 0x05 0x00 0x63
Horizontal position	Write	Horizontal position shift right	0x06 0x14 0x00 0x04 0x00 0x34 0x12 0x06 0x01 0x65
		Horizontal position shift left	0x06 0x14 0x00 0x04 0x00 0x34 0x12 0x06 0x00 0x64
	Read	Horizontal position	0x07 0x14 0x00 0x05 0x00 0x34 0x00 0x00 0x12 0x06 0x65
Vertical position	Write	Vertical position shift up	0x06 0x14 0x00 0x04 0x00 0x34 0x12 0x07 0x00 0x65
		Vertical position shift down	0x06 0x14 0x00 0x04 0x00 0x34 0x12 0x07 0x01 0x66
	Read	read Vertical position	0x07 0x14 0x00 0x05 0x00 0x34 0x00 0x00 0x12 0x07 0x66
Color temperature	Write	color temperature Warm	0x06 0x14 0x00 0x04 0x00 0x34 0x12 0x08 0x00 0x66
		color temperature Normal	0x06 0x14 0x00 0x04 0x00 0x34 0x12 0x08 0x01 0x67
		color temperature Neutral	0x06 0x14 0x00 0x04 0x00 0x34 0x12 0x08 0x02 0x68
		color temperature Cool	0x06 0x14 0x00 0x04 0x00 0x34 0x12 0x08 0x03 0x69
	Read	color temperature status	0x07 0x14 0x00 0x05 0x00 0x34 0x00 0x00 0x12 0x08 0x67
Blank	Write	Blank On	0x06 0x14 0x00 0x04 0x00 0x34 0x12 0x09 0x01 0x68
		Blank Off	0x06 0x14 0x00 0x04 0x00 0x34 0x12 0x09 0x00 0x67
	Read	Blank status	0x07 0x14 0x00 0x05 0x00 0x34 0x00 0x00 0x12 0x09 0x68
Keystone-Vertical	Write	Decrease	0x06 0x14 0x00 0x04 0x00 0x34 0x11 0x31 0x00 0x8E
		Increase	0x06 0x14 0x00 0x04 0x00 0x34 0x11 0x31 0x01 0x8F
	Read	Keystone status	0x07 0x14 0x00 0x05 0x00 0x34 0x00 0x00 0x11 0x31 0x8F
Keystone-Horizontal	Write	Decrease	0x06 0x14 0x00 0x04 0x00 0x34 0x11 0x31 0x00 0x8E
		Increase	0x06 0x14 0x00 0x04 0x00 0x34 0x11 0x31 0x01 0x8F
	Read	Keystone status	0x07 0x14 0x00 0x05 0x00 0x34 0x00 0x00 0x11 0x31 0x8F
Color mode	Write	Brightest	0x06 0x14 0x00 0x04 0x00 0x34 0x12 0x0B 0x00 0x69
		Movie	0x06 0x14 0x00 0x04 0x00 0x34 0x12 0x0B 0x01 0x6A
		PC	0x06 0x14 0x00 0x04 0x00 0x34 0x12 0x0B 0x04 0x6D
		ViewMatch	0x06 0x14 0x00 0x04 0x00 0x34 0x12 0x0B 0x05 0x6E
	Dynamic	0x06 0x14 0x00 0x04 0x00 0x34 0x12 0x0B 0x08 0x71	
	Read	Preset mode status	0x07 0x14 0x00 0x05 0x00 0x34 0x00 0x00 0x12 0x0B 0x6A

Primary Color	Write	Primary color R	0x06 0x14 0x00 0x04 0x00 0x34 0x12 0x10 0x00 0x6E
		Primary color G	0x06 0x14 0x00 0x04 0x00 0x34 0x12 0x10 0x01 0x6F
		Primary color B	0x06 0x14 0x00 0x04 0x00 0x34 0x12 0x10 0x02 0x70
		Primary color C	0x06 0x14 0x00 0x04 0x00 0x34 0x12 0x10 0x03 0x71
		Primary color M	0x06 0x14 0x00 0x04 0x00 0x34 0x12 0x10 0x04 0x72
		Primary color Y	0x06 0x14 0x00 0x04 0x00 0x34 0x12 0x10 0x05 0x73
	Read	Primary color status	0x07 0x14 0x00 0x05 0x00 0x34 0x00 0x00 0x12 0x10 0x6F
Hue	Write	Hue decrease	0x06 0x14 0x00 0x04 0x00 0x34 0x12 0x11 0x00 0x6F
		Hue increase	0x06 0x14 0x00 0x04 0x00 0x34 0x12 0x11 0x01 0x70
	Read	Hue	0x07 0x14 0x00 0x05 0x00 0x34 0x00 0x00 0x12 0x11 0x70
Saturation	Write	Saturation decrease	0x06 0x14 0x00 0x04 0x00 0x34 0x12 0x12 0x00 0x70
		Saturation increase	0x06 0x14 0x00 0x04 0x00 0x34 0x12 0x12 0x01 0x71
	Read	Saturation	0x07 0x14 0x00 0x05 0x00 0x34 0x00 0x00 0x12 0x12 0x71
Gain	Write	Gain decrease	0x06 0x14 0x00 0x04 0x00 0x34 0x12 0x13 0x00 0x71
		Gain increase	0x06 0x14 0x00 0x04 0x00 0x34 0x12 0x13 0x01 0x72
	Read	Gain	0x07 0x14 0x00 0x05 0x00 0x34 0x00 0x00 0x12 0x13 0x72
Freeze	Write	Freeze On	0x06 0x14 0x00 0x04 0x00 0x34 0x13 0x00 0x01 0x60
		Freeze Off	0x06 0x14 0x00 0x04 0x00 0x34 0x13 0x00 0x00 0x5F
	Read	Freeze status	0x07 0x14 0x00 0x05 0x00 0x34 0x00 0x00 0x13 0x00 0x60
Source input	Write	Input source VGA	0x06 0x14 0x00 0x04 0x00 0x34 0x13 0x01 0x00 0x60
		Input source VGA2	0x06 0x14 0x00 0x04 0x00 0x34 0x13 0x01 0x08 0x68
		Input source HDMI	0x06 0x14 0x00 0x04 0x00 0x34 0x13 0x01 0x03 0x63
		Input source HDMI2	0x06 0x14 0x00 0x04 0x00 0x34 0x13 0x01 0x07 0x67
		Input source Composite	0x06 0x14 0x00 0x04 0x00 0x34 0x13 0x01 0x05 0x65
		Input source SVIDEO	0x06 0x14 0x00 0x04 0x00 0x34 0x13 0x01 0x06 0x66
	Read	Source	0x07 0x14 0x00 0x05 0x00 0x34 0x00 0x00 0x13 0x01 0x61
Quick Auto Search	Write	Quick Auto Search on	0x06 0x14 0x00 0x04 0x00 0x34 0x13 0x02 0x01 0x62
		Quick Auto Search off	0x06 0x14 0x00 0x04 0x00 0x34 0x13 0x02 0x00 0x61
	Read	Quick Auto Search status	0x07 0x14 0x00 0x05 0x00 0x34 0x00 0x00 0x13 0x02 0x62
Mute	Write	Mute on	0x06 0x14 0x00 0x04 0x00 0x34 0x14 0x00 0x01 0x61
		Mute off	0x06 0x14 0x00 0x04 0x00 0x34 0x14 0x00 0x00 0x60
	Read	Mute status	0x07 0x14 0x00 0x05 0x00 0x34 0x00 0x00 0x14 0x00 0x61
Volume	Write	Increase Volume	0x06 0x14 0x00 0x04 0x00 0x34 0x14 0x01 0x00 0x61
		Decrease Volume	0x06 0x14 0x00 0x04 0x00 0x34 0x14 0x02 0x00 0x62
	Read	Volume	0x07 0x14 0x00 0x05 0x00 0x34 0x00 0x00 0x14 0x03 0x64

Language	Write	English	0x06 0x14 0x00 0x04 0x00 0x34 0x15 0x00 0x00 0x61
		Français	0x06 0x14 0x00 0x04 0x00 0x34 0x15 0x00 0x01 0x62
		Deutsch	0x06 0x14 0x00 0x04 0x00 0x34 0x15 0x00 0x02 0x63
		Italiano	0x06 0x14 0x00 0x04 0x00 0x34 0x15 0x00 0x03 0x64
		Español	0x06 0x14 0x00 0x04 0x00 0x34 0x15 0x00 0x04 0x65
		Русский	0x06 0x14 0x00 0x04 0x00 0x34 0x15 0x00 0x05 0x66
		繁體中文	0x06 0x14 0x00 0x04 0x00 0x34 0x15 0x00 0x06 0x67
		简体中文	0x06 0x14 0x00 0x04 0x00 0x34 0x15 0x00 0x07 0x68
		日本語	0x06 0x14 0x00 0x04 0x00 0x34 0x15 0x00 0x08 0x69
		한국어	0x06 0x14 0x00 0x04 0x00 0x34 0x15 0x00 0x09 0x6A
		Svenska	0x06 0x14 0x00 0x04 0x00 0x34 0x15 0x00 0x0a 0x6B
		Nederlands	0x06 0x14 0x00 0x04 0x00 0x34 0x15 0x00 0x0b 0x6C
		Türkçe	0x06 0x14 0x00 0x04 0x00 0x34 0x15 0x00 0x0c 0x6D
		Čeština	0x06 0x14 0x00 0x04 0x00 0x34 0x15 0x00 0x0d 0x6D
		Português	0x06 0x14 0x00 0x04 0x00 0x34 0x15 0x00 0x0e 0x6F
		ไทย	0x06 0x14 0x00 0x04 0x00 0x34 0x15 0x00 0x0f 0x70
		Polski	0x06 0x14 0x00 0x04 0x00 0x34 0x15 0x00 0x10 0x71
		Suomi	0x06 0x14 0x00 0x04 0x00 0x34 0x15 0x00 0x11 0x72
		العربية	0x06 0x14 0x00 0x04 0x00 0x34 0x15 0x00 0x12 0x73
	Indonesia	0x06 0x14 0x00 0x04 0x00 0x34 0x15 0x00 0x13 0x74	
हिन्दी	0x06 0x14 0x00 0x04 0x00 0x34 0x15 0x00 0x14 0x75		
	Read	Language	0x07 0x14 0x00 0x05 0x00 0x34 0x00 0x00 0x15 0x00 0x62
Lamp Time	Write	Reset Lamp usage hour	0x06 0x14 0x00 0x04 0x00 0x34 0x15 0x01 0x00 0x62
	Read	Lamp usage hour	0x07 0x14 0x00 0x05 0x00 0x34 0x00 0x00 0x15 0x01 0x63
HDMI Format	Write	RGB	0x06 0x14 0x00 0x04 0x00 0x34 0x11 0x28 0x00 0x85
		YUV	0x06 0x14 0x00 0x04 0x00 0x34 0x11 0x28 0x01 0x86
		Auto	0x06 0x14 0x00 0x04 0x00 0x34 0x11 0x28 0x02 0x87
	Read	HDMI Format status	0x07 0x14 0x00 0x05 0x00 0x34 0x00 0x00 0x11 0x28 0x86
HDMI Range	Write	Enhanced	0x06 0x14 0x00 0x04 0x00 0x34 0x11 0x29 0x00 0x86
		Normal	0x06 0x14 0x00 0x04 0x00 0x34 0x11 0x29 0x01 0x87
		Auto	0x06 0x14 0x00 0x04 0x00 0x34 0x11 0x29 0x02 0x88
	Read	HDMI Range status	0x07 0x14 0x00 0x05 0x00 0x34 0x00 0x00 0x11 0x29 0x87
CEC	Write	Off	0x06 0x14 0x00 0x04 0x00 0x34 0x11 0x2B 0x00 0x88
		On	0x06 0x14 0x00 0x04 0x00 0x34 0x11 0x2B 0x01 0x89
	Read	CEC status	0x07 0x14 0x00 0x05 0x00 0x34 0x00 0x00 0x11 0x2B 0x89
Error status	Read	Read error status	0x07 0x14 0x00 0x05 0x00 0x34 0x00 0x00 0x0C 0x0D 0x66
Brilliant Color	Write	Brilliant Color 0	0x06 0x14 0x00 0x04 0x00 0x34 0x12 0x0F 0x00 0x6D
		Brilliant Color 1	0x06 0x14 0x00 0x04 0x00 0x34 0x12 0x0F 0x01 0x6E
		Brilliant Color 2	0x06 0x14 0x00 0x04 0x00 0x34 0x12 0x0F 0x02 0x6F
		Brilliant Color 3	0x06 0x14 0x00 0x04 0x00 0x34 0x12 0x0F 0x03 0x70
		Brilliant Color 4	0x06 0x14 0x00 0x04 0x00 0x34 0x12 0x0F 0x04 0x71
		Brilliant Color 5	0x06 0x14 0x00 0x04 0x00 0x34 0x12 0x0F 0x05 0x72
		Brilliant Color 6	0x06 0x14 0x00 0x04 0x00 0x34 0x12 0x0F 0x06 0x73
		Brilliant Color 7	0x06 0x14 0x00 0x04 0x00 0x34 0x12 0x0F 0x07 0x74
		Brilliant Color 8	0x06 0x14 0x00 0x04 0x00 0x34 0x12 0x0F 0x08 0x75
		Brilliant Color 9	0x06 0x14 0x00 0x04 0x00 0x34 0x12 0x0F 0x09 0x76
	Brilliant Color 10	0x06 0x14 0x00 0x04 0x00 0x34 0x12 0x0F 0x0A 0x77	
	Read	Brilliant Color status	0x07 0x14 0x00 0x05 0x00 0x34 0x00 0x00 0x12 0x0F 0x6E

Remote Control code	Write	code 1	0x06 0x14 0x00 0x04 0x00 0x34 0x0C 0x48 0x00 0xA0
		code 2	0x06 0x14 0x00 0x04 0x00 0x34 0x0C 0x48 0x01 0xA1
		code 3	0x06 0x14 0x00 0x04 0x00 0x34 0x0C 0x48 0x02 0xA2
		code 4	0x06 0x14 0x00 0x04 0x00 0x34 0x0C 0x48 0x03 0xA3
		code 5	0x06 0x14 0x00 0x04 0x00 0x34 0x0C 0x48 0x04 0xA4
		code 6	0x06 0x14 0x00 0x04 0x00 0x34 0x0C 0x48 0x05 0xA5
		code 7	0x06 0x14 0x00 0x04 0x00 0x34 0x0C 0x48 0x06 0xA6
		code 8	0x06 0x14 0x00 0x04 0x00 0x34 0x0C 0x48 0x07 0xA7
	Read	Remote Control code status	0x07 0x14 0x00 0x05 0x00 0x34 0x00 0x00 0x0C 0x048 0xA1
Screen Color	Write	Screen color Off	0x06 0x14 0x00 0x04 0x00 0x34 0x11 0x32 0x00 0x8F
		Blackboard	0x06 0x14 0x00 0x04 0x00 0x34 0x11 0x32 0x01 0x90
		Greenboard	0x06 0x14 0x00 0x04 0x00 0x34 0x11 0x32 0x02 0x91
		Whiteboard	0x06 0x14 0x00 0x04 0x00 0x34 0x11 0x32 0x03 0x92
	Read	Screen Color status	0x07 0x14 0x00 0x05 0x00 0x34 0x00 0x00 0x11 0x32 0x90
Over Scan	Write	Overscan Off	0x06 0x14 0x00 0x04 0x00 0x34 0x11 0x33 0x00 0x90
		Overscan 1	0x06 0x14 0x00 0x04 0x00 0x34 0x11 0x33 0x01 0x91
		Overscan 2	0x06 0x14 0x00 0x04 0x00 0x34 0x11 0x33 0x02 0x92
		Overscan 3	0x06 0x14 0x00 0x04 0x00 0x34 0x11 0x33 0x03 0x93
		Overscan 4	0x06 0x14 0x00 0x04 0x00 0x34 0x11 0x33 0x04 0x94
		Overscan 5	0x06 0x14 0x00 0x04 0x00 0x34 0x11 0x33 0x05 0x95
	Read	Overscan status	0x07 0x14 0x00 0x05 0x00 0x34 0x00 0x00 0x11 0x33 0x91
Remote Key	Write	Menu	0x02 0x14 0x00 0x04 0x00 0x34 0x02 0x04 0x0F 0x61
		Exit	0x02 0x14 0x00 0x04 0x00 0x34 0x02 0x04 0x13 0x65
		Top	0x02 0x14 0x00 0x04 0x00 0x34 0x02 0x04 0x0B 0x5D
		Bottom	0x02 0x14 0x00 0x04 0x00 0x34 0x02 0x04 0x0C 0x5E
		Left	0x02 0x14 0x00 0x04 0x00 0x34 0x02 0x04 0x0D 0x5F
		Right	0x02 0x14 0x00 0x04 0x00 0x34 0x02 0x04 0x0E 0x60
		Source	0x02 0x14 0x00 0x04 0x00 0x34 0x02 0x04 0x04 0x56
		Enter	0x02 0x14 0x00 0x04 0x00 0x34 0x02 0x04 0x15 0x67
		Auto	0x02 0x14 0x00 0x04 0x00 0x34 0x02 0x04 0x08 0x5A
		My Button	0x02 0x14 0x00 0x04 0x00 0x34 0x02 0x04 0x11 0x63

IR control table

System Code: 83F4
Format : NEC



Key	Format	Byte1	Byte2	Byte3	Byte4
Freeze	NEC	X3	F4	03	FC
PgDn	NEC	X3	F4	05	FA
PgUp	NEC	X3	F4	06	F9
Blank	NEC	X3	F4	07	F8
Auto sync	NEC	X3	F4	08	F7
Up	NEC	X3	F4	0B	F4
Down	NEC	X3	F4	0C	F3
Left	NEC	X3	F4	0E	F1
Right	NEC	X3	F4	0F	F0
Color Mode	NEC	X3	F4	10	EF
Aspect	NEC	X3	F4	13	EC
Mute	NEC	X3	F4	14	EB
Enter	NEC	X3	F4	15	EA
Power ON	NEC	X3	F4	17	E8
Magnify	NEC	X3	F4	32	CD
Presentation Timer	NEC	X3	F4	27	D8
Exit	NEC	X3	F4	28	D7
D. ECO (Eco mode)	NEC	X3	F4	2B	D4
Menu	NEC	X3	F4	30	CF
Mouse	NEC	X3	F4	31	CE
Mouse Left	NEC	X3	F4	36	C9
Mouse Right	NEC	X3	F4	37	C8
Source	NEC	X3	F4	40	BF
VGA (PC)	NEC	X3	F4	41	BE
Pattern	NEC	X3	F4	55	AA
My button	NEC	X3	F4	56	A9
HDMI	NEC	X3	F4	58	A7
Volume+	NEC	X3	F4	82	7D
Volume-	NEC	X3	F4	83	7C
Key pad lock	NEC	X3	F4	8E	71
RC ID	NEC	X3	F4	96	69

Address code

Code 1	83F4
Code 2	93F4
Code 3	A3F4
Code 4	B3F4
Code 5	C3F4
Code 6	D3F4
Code 7	E3F4
Code 8	F3F4

Customer Support

For technical support or product service, see the table below or contact your reseller.

NOTE: You will need the product serial number.

Country/Region	Website	T= Telephone C = CHAT ONLINE	Email
Australia New Zealand	www.viewsonic.com.au	AUS= 1800 880 818 NZ= 0800 008 822	service@au.viewsonic.com
Canada	www.viewsonic.com	T (Toll-Free)= 1-866-463-4775 T (Toll)= 1-424-233-2533	service.ca@viewsonic.com
Europe	www.viewsoniceurope.com	www.viewsoniceurope.com/uk/support/call-desk/	
Hong Kong	www.hk.viewsonic.com	T= 852 3102 2900	service@hk.viewsonic.com
India	www.in.viewsonic.com	T= 1800 419 0959	service@in.viewsonic.com
Korea	ap.viewsonic.com/kr/	T= 080 333 2131	service@kr.viewsonic.com
Latin America (Argentina)	www.viewsonic.com/la/	C= http://www.viewsonic.com/la/soporte/servicio-tecnico	soporte@viewsonic.com
Latin America (Chile)	www.viewsonic.com/la/	C= http://www.viewsonic.com/la/soporte/servicio-tecnico	soporte@viewsonic.com
Latin America (Columbia)	www.viewsonic.com/la/	C= http://www.viewsonic.com/la/soporte/servicio-tecnico	soporte@viewsonic.com
Latin America (Mexico)	www.viewsonic.com/la/	C= http://www.viewsonic.com/la/soporte/servicio-tecnico	soporte@viewsonic.com
Nexus Hightech Solutions, Cincinnati #40 Desp. 1 Col. De los Deportes Mexico D.F. Tel: 55) 6547-6454 55)6547-6484 Other places please refer to http://www.viewsonic.com/la/soporte/servicio-tecnico#mexico			
Latin America (Peru)	www.viewsonic.com/la/	C= http://www.viewsonic.com/la/soporte/servicio-tecnico	soporte@viewsonic.com
Macau	www.hk.viewsonic.com	T= 853 2870 0303	service@hk.viewsonic.com
Middle East	ap.viewsonic.com/me/	Contact your reseller	service@ap.viewsonic.com
Puerto Rico & Virgin Islands	www.viewsonic.com	T= 1-800-688-6688 (English) C= http://www.viewsonic.com/la/soporte/servicio-tecnico	service.us@viewsonic.com soporte@viewsonic.com
Singapore/ Malaysia/Thailand	www.ap.viewsonic.com	T= 65 6461 6044	service@sg.viewsonic.com
South Africa	ap.viewsonic.com/za/	Contact your reseller	service@ap.viewsonic.com
United States	www.viewsonic.com	T (Toll-Free)= 1-800-688-6688 T (Toll)= 1-424-233-2530	service.us@viewsonic.com

Limited Warranty

ViewSonic® Projector

What the warranty covers:

ViewSonic warrants its products to be free from defects in material and workmanship, under normal use, during the warranty period. If a product proves to be defective in material or workmanship during the warranty period, ViewSonic will, at its sole option, repair or replace the product with a like product. Replacement product or parts may include remanufactured or refurbished parts or components.

Limited Three (3) year General Warranty

Subject to the more limited one (1) year warranty set out below, North and South America: Three (3) years warranty for all parts excluding the lamp, three (3) years for labor, and one (1) year for the original lamp from the date of the first consumer purchase.

Other regions or countries: Please check with your local dealer or local ViewSonic office for the warranty information.

Limited One (1) year Heavy Usage Warranty:

Under heavy usage settings, where a projector's use includes more than fourteen (14) hours average daily usage, North and South America: One (1) year warranty for all parts excluding the lamp, one (1) year for labor, and ninety (90) days for the original lamp from the date of the first consumer purchase; Europe: One (1) year warranty for all parts excluding the lamp, one (1) year for labor, and ninety (90) days for the original lamp from the date of the first consumer purchase.

Other regions or countries: Please check with your local dealer or local ViewSonic office for the warranty information.

Lamp warranty subject to terms and conditions, verification and approval. Applies to manufacturer's installed lamp only. All accessory lamps purchased separately are warranted for 90 days.

Who the warranty protects:

This warranty is valid only for the first consumer purchaser.

What the warranty does not cover:

1. Any product on which the serial number has been defaced, modified or removed.
2. Damage, deterioration or malfunction resulting from:
 - a. Accident, abuse, misuse, neglect, fire, water, lightning, or other acts of nature, improper maintenance, unauthorized product modification, or failure to follow instructions supplied with the product.
 - b. Operation outside of product specifications.
 - c. Operation of the product for other than the normal intended use or not under normal conditions.
 - d. Repair or attempted repair by anyone not authorized by ViewSonic.
 - e. Any damage of the product due to shipment.
 - f. Removal or installation of the product.
 - g. Causes external to the product, such as electric power fluctuations or failure.
 - h. Use of supplies or parts not meeting ViewSonic's specifications.
 - i. Normal wear and tear.
 - j. Any other cause which does not relate to a product defect.
3. Removal, installation, one way transportation, insurance, and set-up service charges.

How to get service:

1. For information about receiving service under warranty, contact ViewSonic Customer Support (Please refer to Customer Support page). You will need to provide your product's serial number.
2. To obtain warranty service, you will be required to provide (a) the original dated sales slip, (b) your name, (c) your address, (d) a description of the problem, and (e) the serial number of the product.
3. Take or ship the product freight prepaid in the original container to an authorized ViewSonic service center or ViewSonic.
4. For additional information or the name of the nearest ViewSonic service center, contact ViewSonic.

Limitation of implied warranties:

There are no warranties, express or implied, which extend beyond the description contained herein including the implied warranty of merchantability and fitness for a particular purpose.

Exclusion of damages:

ViewSonic's liability is limited to the cost of repair or replacement of the product. ViewSonic shall not be liable for:

1. Damage to other property caused by any defects in the product, damages based upon inconvenience, loss of use of the product, loss of time, loss of profits, loss of business opportunity, loss of goodwill, interference with business relationships, or other commercial loss, even if advised of the possibility of such damages.
2. Any other damages, whether incidental, consequential or otherwise.
3. Any claim against the customer by any other party.
4. Repair or attempted repair by anyone not authorized by ViewSonic.

Effect of state law:

This warranty gives you specific legal rights, and you may also have other rights which vary from state to state. Some states do not allow limitations on implied warranties and/or do not allow the exclusion of incidental or consequential damages, so the above limitations and exclusions may not apply to you.

Sales outside the U.S.A. and Canada:

For warranty information and service on ViewSonic products sold outside of the U.S.A. and Canada, contact ViewSonic or your local ViewSonic dealer.

The warranty period for this product in mainland China (Hong Kong, Macao and Taiwan Excluded) is subject to the terms and conditions of the Maintenance Guarantee Card.

For users in Europe and Russia, full details of warranty provided can be found in www.viewsoniceurope.com under Support/Warranty Information.

Mexico Limited Warranty

ViewSonic® Projector

What the warranty covers:

ViewSonic warrants its products to be free from defects in material and workmanship, under normal use, during the warranty period. If a product proves to be defective in material or workmanship during the warranty period, ViewSonic will, at its sole option, repair or replace the product with a like product. Replacement product or parts may include remanufactured or refurbished parts or components & accessories.

How long the warranty is effective:

3 years for all parts excluding the lamp, 3 years for labor, 1 year for the original lamp from the date of the first consumer purchase.

Lamp warranty subject to terms and conditions, verification and approval. Applies to manufacturer's installed lamp only.

All accessory lamps purchased separately are warranted for 90 days.

Who the warranty protects:

This warranty is valid only for the first consumer purchaser.

What the warranty does not cover:

1. Any product on which the serial number has been defaced, modified or removed.
2. Damage, deterioration or malfunction resulting from:
 - a. Accident, misuse, neglect, fire, water, lightning, or other acts of nature, unauthorized product modification, unauthorized attempted repair, or failure to follow instructions supplied with the product.
 - b. Any damage of the product due to shipment.
 - c. Causes external to the product, such as electrical power fluctuations or failure.
 - d. Use of supplies or parts not meeting ViewSonic's specifications.
 - e. Normal wear and tear.
 - f. Any other cause which does not relate to a product defect.
3. Any product exhibiting a condition commonly known as "image burn-in" which results when a static image is displayed on the product for an extended period of time.
4. Removal, installation, insurance, and set-up service charges.

How to get service:

For information about receiving service under warranty, contact ViewSonic Customer Support (Please refer to the attached Customer Support page). You will need to provide your product's serial number, so please record the product information in the space provided below on your purchase for your future use. Please retain your receipt of proof of purchase to support your warranty claim.

For Your Records

Product Name: _____ Model Number: _____

Document Number: _____ Serial Number: _____

Purchase Date: _____ Extended Warranty Purchase? _____ (Y/N)

If so, what date does warranty expire? _____

1. To obtain warranty service, you will be required to provide (a) the original dated sales slip, (b) your name, (c) your address, (d) a description of the problem, and (e) the serial number of the product.
2. Take or ship the product in the original container packaging to an authorized ViewSonic service center.
3. Round trip transportation costs for in-warranty products will be paid by ViewSonic.

Limitation of implied warranties:

There are no warranties, express or implied, which extend beyond the description contained herein including the implied warranty of merchantability and fitness for a particular purpose.

Exclusion of damages:

ViewSonic's liability is limited to the cost of repair or replacement of the product. ViewSonic shall not be liable for:

1. Damage to other property caused by any defects in the product, damages based upon inconvenience, loss of use of the product, loss of time, loss of profits, loss of business opportunity, loss of goodwill, interference with business relationships, or other commercial loss, even if advised of the possibility of such damages.
2. Any other damages, whether incidental, consequential or otherwise.
3. Any claim against the customer by any other party.
4. Repair or attempted repair by anyone not authorized by ViewSonic.

Contact Information for Sales & Authorized Service (Centro Autorizado de Servicio) within Mexico:	
Name, address, of manufacturer and importers: México, Av. de la Palma #8 Piso 2 Despacho 203, Corporativo Interpalmas, Col. San Fernando Huixquilucan, Estado de México Tel: (55) 3605-1099 http://www.viewsonic.com/la/soporte/index.htm	
NÚMERO GRATIS DE ASISTENCIA TÉCNICA PARA TODO MÉXICO: 001.866.823.2004	
Hermosillo: Distribuciones y Servicios Computacionales SA de CV. Calle Juarez 284 local 2 Col. Bugambillas C.P: 83140 Tel: 01-66-22-14-9005 E-Mail: disc2@hmo.megared.net.mx	Villahermosa: Compumantenimientos Garantizados, S.A. de C.V. AV. GREGORIO MENDEZ #1504 COL, FLORIDA C.P. 86040 Tel: 01 (993) 3 52 00 47 / 3522074 / 3 52 20 09 E-Mail: compumantenimientos@prodigy.net.mx
Puebla, Pue. (Matriz): RENTA Y DATOS, S.A. DE C.V. Domicilio: 29 SUR 721 COL. LA PAZ 72160 PUEBLA, PUE. Tel: 01(52).222.891.55.77 CON 10 LINEAS E-Mail: datos@puebla.megared.net.mx	Veracruz, Ver.: CONEXION Y DESARROLLO, S.A DE C.V. Av. Americas # 419 ENTRE PINZÓN Y ALVARADO Fracc. Reforma C.P. 91919 Tel: 01-22-91-00-31-67 E-Mail: gacosta@qplus.com.mx
Chihuahua Soluciones Globales en Computación C. Magisterio # 3321 Col. Magisterial Chihuahua, Chih. Tel: 4136954 E-Mail: Cefeo@soluglobales.com	Cuernavaca Compusupport de Cuernavaca SA de CV Francisco Leyva # 178 Col. Miguel Hidalgo C.P. 62040, Cuernavaca Morelos Tel: 01 777 3180579 / 01 777 3124014 E-Mail: aquevedo@compusupportcva.com
Distrito Federal: QPLUS, S.A. de C.V. Av. Coyoacán 931 Col. Del Valle 03100, México, D.F. Tel: 01(52)55-50-00-27-35 E-Mail : gacosta@qplus.com.mx	Guadalajara, Jal.: SERVICRECE, S.A. de C.V. Av. Niños Héroes # 2281 Col. Arcos Sur, Sector Juárez 44170, Guadalajara, Jalisco Tel: 01(52)33-36-15-15-43 E-Mail: mmiranda@servicrece.com
Guerrero Acapulco GS Computación (Grupo Sesicomp) Progreso #6-A, Colo Centro 39300 Acapulco, Guerrero Tel: 744-48-32627	Monterrey: Global Product Services Mar Caribe # 1987, Esquina con Golfo Pérsico Fracc. Bernardo Reyes, CP 64280 Monterrey N.L. México Tel: 8129-5103 E-Mail: aydeem@gps1.com.mx
MERIDA: ELECTROSER Av Reforma No. 403Gx39 y 41 Mérida, Yucatán, México CP97000 Tel: (52) 999-925-1916 E-Mail: rrrb@sureste.com	Oaxaca, Oax.: CENTRO DE DISTRIBUCION Y SERVICIO, S.A. de C.V. Murguía # 708 P.A., Col. Centro, 68000, Oaxaca Tel: 01(52)95-15-15-22-22 Fax: 01(52)95-15-13-67-00 E-Mail: gpotai2001@hotmail.com
Tijuana: STD Av Ferrocarril Sonora #3780 L-C Col 20 de Noviembre Tijuana, Mexico	FOR USA SUPPORT: ViewSonic Corporation 14035 Pipeline Ave. Chino, CA 91710, USA Tel: 800-688-6688 (English); 866-323-8056 (Spanish); E-Mail: http://www.viewsonic.com



ViewSonic®