

myprojectorlamps.com

**The most trusted, dependable name
in projector lamp sales.**



<http://www.myprojectorlamps.com>



<http://www.myprojectorlamps.ca>



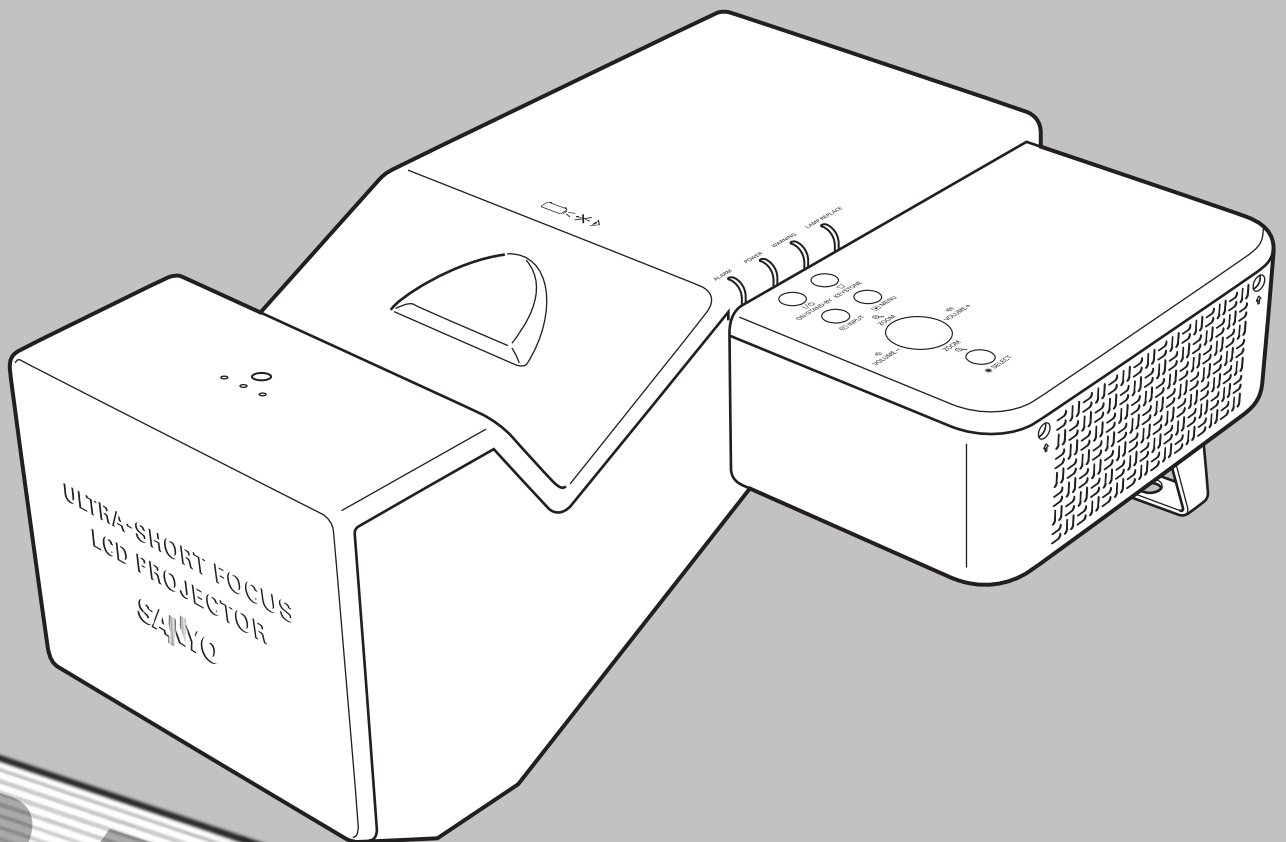
<http://www.myprojectorlamps.eu>

The following projector manual has not been modified or altered in any way.

SANYO

Multimedia Projector

MODEL PLC-XL50



PROJECTOR

Owner's Manual

Features and Design

This Multimedia Projector is designed with the most advanced technology for portability, durability, and ease of use. This projector utilizes built-in multimedia features, a palette of 16.77 million colors, and matrix liquid crystal display (LCD) technology.

◆ **Large Screen in Limited Space**

Short focus lens allows you to project large images from short distance (p.14). Images can be projected on the floor.

◆ **Security Function**

The Security function helps you to ensure security of the projector. With the Key lock function, you can lock the operation on the top control or remote control (p.51). PIN code lock functions prevents unauthorized use of the projector (pp.20, 52–53).

◆ **Logo Function**

The Logo function allows you to customize the screen logo. The Logo page identifies the owner of the projector (pp.47, 48).

◆ **Antitheft Alarm Function**

This projector is equipped with an Antitheft alarm function which sounds when vibration is detected (pp.55–58). A built-in rechargeable battery is used for the alarm.

◆ **Simple Computer System Setting**

The projector has a Multi-scan system to conform to almost all computer output signals quickly (p.28).

◆ **Compatibility**

The projector widely accepts various video and computer input signals including; Computers, 6 Color systems (PAL, SECAM, NTSC, NTSC4.43, PAL-M, or PAL-N), Component video, S-Video and RGB scart.

◆ **Quick Termination**

The AC power cord can be unplugged immediately after turning off the projector without waiting for the projector to cool down (p.21).

✓ **Note:**

- The On-Screen Menu and figures in this manual may differ slightly from the product.
- The contents of this manual are subject to change without notice.

◆ **Digital Zoom (for Computer)**

The digital zoom function expands (to approx. 16 times of the screen size) the image size, allowing you to focus on crucial information during the presentation. (p.36)

◆ **Blackboard Function**

A blackboard can be used as a projection screen. (pp.32-33, 40-41) *The board color is limited to Green.

◆ **Colorboard Function**

At the time of simple projection on the colored wall, you can get the close color image to the color image projected on a white screen by selecting the similar color to the wall color from the preset four colors.

◆ **Multilanguage Menu Display**

The Operation menu is available in 16 languages: English, German, French, Italian, Spanish, Portuguese, Dutch, Swedish, Finnish, Polish, Hungarian, Romanian, Russian, Chinese, Korean, and Japanese (p.45).

◆ **Switchable Interface Terminal**

The projector provides a switchable interface terminal. You can use the terminal as computer input or monitor output conveniently (p.49).

◆ **Power Management**

The Power management function reduces power consumption and maintains lamp life (p.50).

◆ **Input Search Function**

Input signal can be searched automatically. (p.49)

Table of Contents

Features and Design	2	Computer Input	27
Table of Contents	3	Input Source Selection	27
To the Owner	4	Computer System Selection	28
Safety Instructions	5	Auto PC Adjustment	29
Air Circulation	6	Manual PC Adjustment	30
Moving the Projector	6	Image Level Selection	32
Installing the Projector in Proper Position	7	Image Level Adjustment	34
Compliance	8	Screen Size Adjustment	35
Part Names and Functions	9	Video Input	37
Front	9	Input Source Selection	
Back	9	(Video, S-Video, Component)	37
Bottom	9	Input Source Selection (RGB Scart 21-pin)	38
Rear Terminal	10	Video System Selection	39
Top	11	Image Level Selection	40
Remote Control	12	Image Level Adjustment	42
Remote Control Battery Installation	13	Screen Size Adjustment	44
Operating Range	13	Setting	45
Installation	14	Setting	45
Positioning the Projector	14	Antitheft Alarm Function	55
Adjustable Feet	14	How to Use the Antitheft Alarm Function	55
Mounting the Rear Leg and the Stand	15	Maintenance and Cleaning	59
Connecting to Computer	16	Warning Indicator	59
Connecting to Video Equipment		Cleaning the Air Filter	60
(Video, S-Video)	17	Resetting the Filter Counter	60
Connecting to Video Equipment		Cleaning the Projection Window	61
(Component and RGB Scart)	18	Cleaning the Projector Cabinet	61
Connecting the AC Power Cord	19	Lamp Replacement	62
Basic Operation	20	Lamp Replacement Counter	63
Turning On the Projector	20	Appendix	64
Turning Off the Projector	21	Troubleshooting	64
How to Operate the On-Screen Menu	22	Menu Tree	67
Menu Bar	23	Indicators and Projector Condition	69
Zoom Adjustment	24	Compatible Computer Specifications	70
Screen Position Adjustment	24	Technical Specifications	71
Focus Adjustment	24	Optional Parts	72
Keystone Correction	24	Configurations of Terminals	73
Sound Adjustment	25	Dimensions	73
Remote Control Operation	25	PIN Code Number Memo	74

Trademarks

Each name of corporations or products in this book is either a registered trademark or a trademark of its respective corporation.





To the Owner

Before installing and operating this projector, read this manual thoroughly and operate the projector properly.

This projector provides many convenient features and functions. Operating the projector properly enables you to manage those features and maintain it in good condition for many years to come.

Improper operation may result in not only shortening the product life, but also malfunctions, fire hazard, or other accidents.

If your projector seems to operate improperly, read this manual again, check operations and cable connections, and try the solutions in the "Troubleshooting" section in the back of this manual. If the problem still persists, contact the dealer where you purchased the projector or the service center.

	CAUTION RISK OF ELECTRIC SHOCK DO NOT OPEN	
CAUTION: TO REDUCE THE RISK OF ELECTRIC SHOCK, DO NOT REMOVE COVER (OR BACK). NO USER-SERVICEABLE PARTS INSIDE EXCEPT LAMP REPLACEMENT. REFER SERVICING TO QUALIFIED SERVICE PERSONNEL.		
	THIS SYMBOL INDICATES THAT DANGEROUS VOLTAGE CONSTITUTING A RISK OF ELECTRIC SHOCK IS PRESENT WITHIN THIS UNIT.	
	THIS SYMBOL INDICATES THAT THERE ARE IMPORTANT OPERATING AND MAINTENANCE INSTRUCTIONS IN THE OWNER'S MANUAL WITH THIS UNIT.	

NOTE: This symbol and recycle system are applied only to EU countries and not applied to the countries in the other area of the world.



Your SANYO product is designed and manufactured with high quality materials and components which can be recycled and reused.

This symbol means that electrical and electronic equipment, at their end-of-life, should be disposed of separately from your household waste.

Please dispose of this equipment at your local community waste collection/recycling centre. In the European Union there are separate collection systems for used electrical and electronic products. Please help us to conserve the environment we live in!

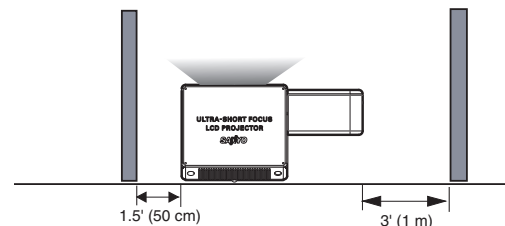
READ AND KEEP THIS OWNER'S MANUAL FOR LATER USE.



Safety Precaution

WARNING: TO REDUCE THE RISK OF FIRE OR ELECTRIC SHOCK, DO NOT EXPOSE THIS APPLIANCE TO RAIN OR MOISTURE.

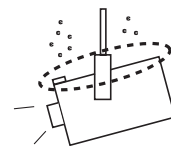
- This projector produces intense light from the projection lens. Avoid staring directly into the lens, otherwise eye damage could result. Be especially careful that children do not stare directly into the beam.
- Install the projector in a proper position. Otherwise it may result in fire hazard.
- Allowing the proper amount of space on the projector cabinet is critical for proper air circulation and cooling of the unit. The dimensions shown here indicate the minimum space required. If the projector is to be built into a compartment or similarly enclosed, these minimum distances must be maintained. Do not cover the ventilation slot on the projector. Heat build-up can reduce the service life of your projector, and can also be dangerous.



- If the projector is unused for an extended time, unplug the projector from the power outlet.



CAUTION ON HANGING FROM THE CEILING



When hanging the projector from the ceiling, clean air intake vents, air filters, or top of the projector periodically with a vacuum cleaner. If you leave the projector without cleaning for a long time, the dust will block the operation of the cooling function, and it may cause a breakdown or a disaster.

DO NOT SET THE PROJECTOR IN GREASY, WET, OR SMOKY CONDITIONS SUCH AS IN A KITCHEN TO PREVENT A BREAKDOWN OR A DISASTER. IF THE PROJECTOR COMES IN CONTACT WITH OIL OR CHEMICALS, IT MAY BECOME DETERIORATED.

CAUTION

Not for use in a computer room as defined in the Standard for the Protection of Electronic Computer/Data Processing Equipment, ANSI/NFPA 75.

Ne peut être utilisé dans une salle d'ordinateurs telle que définie dans la norme ANSI/NFPA 75 Standard for Protection of Electronic Computer/Data Processing Equipment.

Safety Instructions

All the safety and operating instructions should be read before the product is operated.

Read all of the instructions given here and retain them for later use. Unplug this projector from AC power supply before cleaning. Do not use liquid or aerosol cleaners. Use a damp cloth for cleaning.

Follow all warnings and instructions marked on the projector.

For added protection to the projector during a lightning storm, or when it is left unattended and unused for long periods of time, unplug it from the wall outlet. This will prevent damage due to lightning and power line surges.

Do not expose this unit to rain or use near water... for example, in a wet basement, near a swimming pool, etc...

Do not use attachments not recommended by the manufacturer as they may cause hazards.

Do not place this projector on an unstable cart, stand, or table. The projector may fall, causing serious injury to a child or adult, and serious damage to the projector. Use only with a cart or stand recommended by the manufacturer, or sold with the projector. Wall or shelf mounting should follow the manufacturer's instructions, and should use a mounting kit approved by the manufacturers.

An appliance and cart combination should be moved with care. Quick stops, excessive force, and uneven surfaces may cause the appliance and cart combination to overturn.



Slots and openings in the back and bottom of the cabinet are provided for ventilation, to ensure reliable operation of the equipment and to protect it from overheating.

The openings should never be covered with cloth or other materials, and the bottom opening should not be blocked by placing the projector on a bed, sofa, rug, or other similar surface. This projector should never be placed near or over a radiator or heat register.

This projector should not be placed in a built-in installation such as a book case unless proper ventilation is provided.

Never push objects of any kind into this projector through cabinet slots as they may touch dangerous voltage points or short out parts that could result in a fire or electric shock. Never spill liquid of any kind on the projector.

Do not install the projector near the ventilation duct of air-conditioning equipment.

This projector should be operated only from the type of power source indicated on the marking label. If you are not sure of the type of power supplied, consult your authorized dealer or local power company.

Do not overload wall outlets and extension cords as this can result in fire or electric shock. Do not allow anything to rest on the power cord. Do not locate this projector where the cord may be damaged by persons walking on it.

Do not attempt to service this projector yourself as opening or removing covers may expose you to dangerous voltage or other hazards. Refer all servicing to qualified service personnel.

Unplug this projector from wall outlet and refer servicing to qualified service personnel under the following conditions:

- a. When the power cord or plug is damaged or frayed.
- b. If liquid has been spilled into the projector.
- c. If the projector has been exposed to rain or water.
- d. If the projector does not operate normally by following the operating instructions. Adjust only those controls that are covered by the operating instructions as improper adjustment of other controls may result in damage and will often require extensive work by a qualified technician to restore the projector to normal operation.
- e. If the projector has been dropped or the cabinet has been damaged.
- f. When the projector exhibits a distinct change in performance this indicates a need for service.

When replacement parts are required, be sure the service technician has used replacement parts specified by the manufacturer that have the same characteristics as the original part. Unauthorized substitutions may result in fire, electric shock, or injury to persons.

Upon completion of any service or repairs to this projector, ask the service technician to perform routine safety checks to determine that the projector is in safe operating condition.

Safety Instructions

Air Circulation

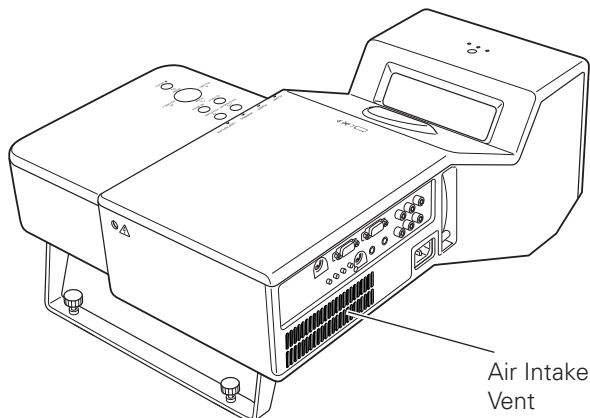
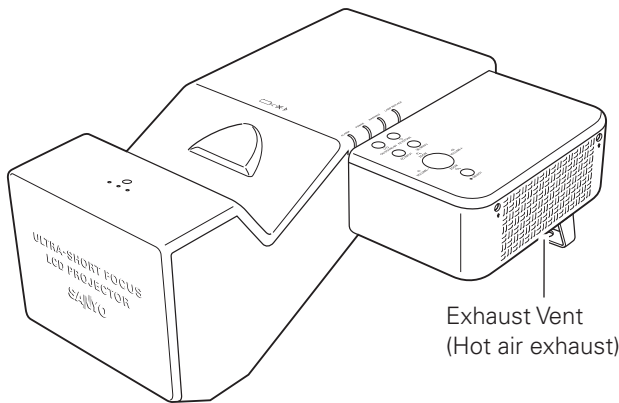
Openings in the cabinet are provided for ventilation. To ensure reliable operation of the product and to protect it from overheating, these openings must not be blocked or covered.

CAUTION

Hot air is exhausted from the exhaust vent. When using or installing the projector, the following precautions should be taken.

- Do not put any flammable objects or spray can near the projector. Hot air is exhausted from the air vents.
- Keep the exhaust vent at least 3' (1 m) away from any objects.
- Do not touch a peripheral part of the exhaust vent, especially screws and metallic part. This area will become hot while the projector is being used.
- Do not put anything on the projector. Objects put on the cabinet will not only get damaged but also may cause fire hazard by heat.

Cooling fans are provided to cool down the projector. The fan's running speed is changed according to the temperature inside the projector.



Moving the Projector

When the projector is not in use for an extended period, put it into a suitable case.

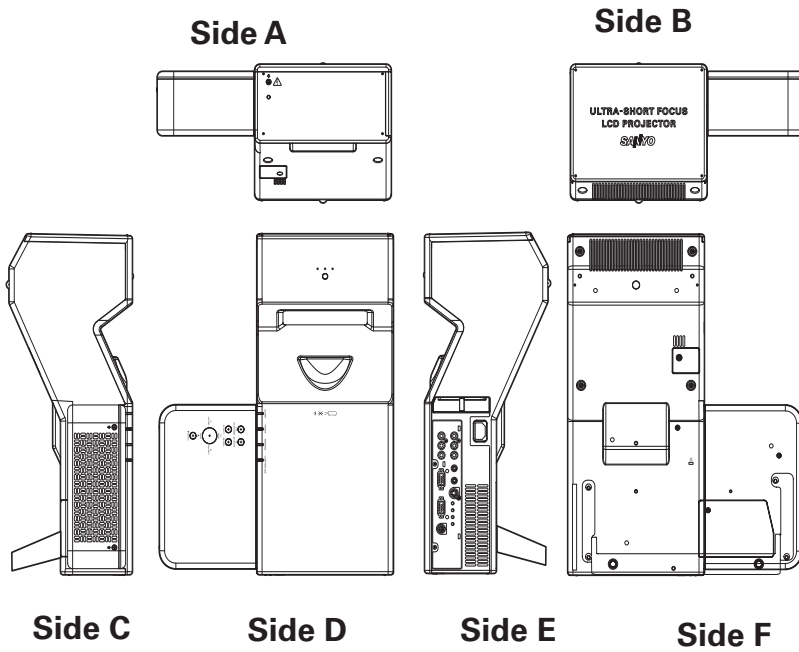
Handle the projector carefully; do not drop, bump, subject it to strong forces, or put other things on the cabinet.

CAUTION IN CARRYING OR TRANSPORTING THE PROJECTOR

- Do not drop or bump the projector, otherwise damages or malfunctions may result.
- Do not hold the rear leg.
- When carrying the projector, use a suitable carrying case.
- Do not transport the projector by courier or any other transport service in an unsuitable transport case. This may cause damage to the projector. For information about transporting the projector by courier or any other transport service, consult your dealer.
- Do not put the projector in a case before it is cooled enough.

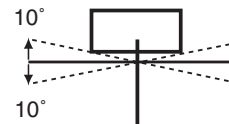
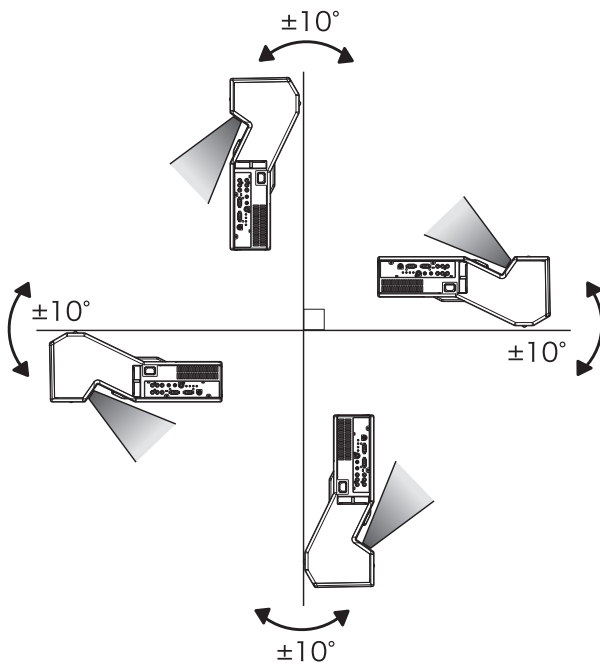
Installing the Projector in Proper Position

Install the projector properly. Improper Installation may reduce the lamp life and cause fire hazard.



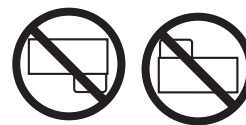
CAUTION

- Do not put anything or sit on the projector, otherwise, it may fall down or cause failure of the projector or injury.

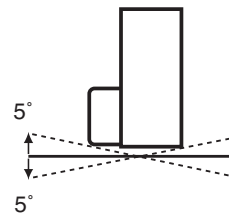


Do not roll the projector more than 10 degrees from side to side.

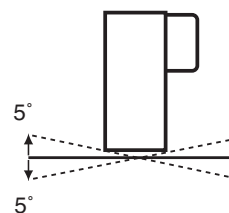
This side is Side A or B.



Do not put the projector on either side C or E to project an image.



Do not roll the projector more than 5 degrees from side to side when side A or B is downward.



✓ Note:

- Fix the projector when installing it so that the projector would not fall down.

Federal Communications Commission Notice

This equipment has been tested and found to comply with the limits for a Class B digital device, pursuant to Part 15 of the FCC Rules. These limits are designed to provide reasonable protection against harmful interference in a residential installation. This equipment generates, uses, and can radiate radio frequency energy. If it is not installed and used in accordance with the instructions, it may cause harmful interference to radio communications. However, there is no guarantee that interference will not occur in a particular installation. If this equipment does cause harmful interference to radio or television reception, which can be determined by turning the equipment off and on, the user is encouraged to try to correct the interference by one or more of the following measures:

- Reorient or relocate the receiving antenna.
- Increase the separation between the equipment and receiver.
- Connect the equipment into an outlet on a circuit different from that to which the receiver is connected.
- Consult the dealer or an experienced radio/TV technician for help.

Use of shielded cable is required to comply with Class B limits in Subpart B of Part 15 of FCC Rules.

Do not make any changes or modifications to the equipment unless otherwise specified in the instructions. If such changes or modifications should be made, you could be required to stop operation of the equipment.

Model Number(s) : PLC-XL50
Trade Name : Sanyo
Responsible party : SANYO FISHER COMPANY
Address : 21605 Plummer Street, Chatsworth, California 91311
Telephone No. : (818)998-7322

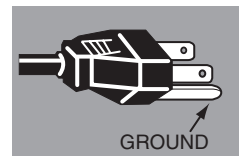
AC Power Cord Requirement

The AC Power Cord supplied with this projector meets the requirement for use in the country you purchased it.

AC Power Cord for the United States and Canada:

AC Power Cord used in the United States and Canada is listed by the Underwriters Laboratories (UL) and certified by the Canadian Standard Association (CSA).

AC Power Cord has a grounding-type AC line plug. This is a safety feature to be sure that the plug will fit into the power outlet. Do not try to defeat this safety feature. Should you be unable to insert the plug into the outlet, contact your electrician.



AC Power Cord for the United Kingdom:

This cord is already fitted with a moulded plug incorporating a fuse, the value of which is indicated on the pin face of the plug. Should the fuse need to be replaced, an ASTA approved BS 1362 fuse must be used of the same rating, marked thus \diamond . If the fuse cover is detachable, never use the plug with the cover omitted. If a replacement fuse cover is required, ensure it is of the same colour as that visible on the pin face of the plug (i.e. red or orange). Fuse covers are available from the Parts Department indicated in your User Instructions.

If the plug supplied is not suitable for your socket outlet, it should be cut off and destroyed.

The end of the flexible cord should be suitably prepared and the correct plug fitted.

WARNING: A PLUG WITH BARED FLEXIBLE CORD IS HAZARDOUS IF ENGAGED IN A LIVE SOCKET OUTLET.

The Wires in this mains lead are coloured in accordance with the following code:

Green-and-yellow Earth
Blue Neutral
Brown Live

As the colours of the wires in the mains lead of this apparatus may not correspond with the coloured markings identifying the terminals in your plug proceed as follows:

The wire which is coloured green-and-yellow must be connected to the terminal in the plug which is marked by the letter E or by the safety earth symbol \perp or coloured green or green-and-yellow.

The wire which is coloured blue must be connected to the terminal which is marked with the letter N or coloured black.

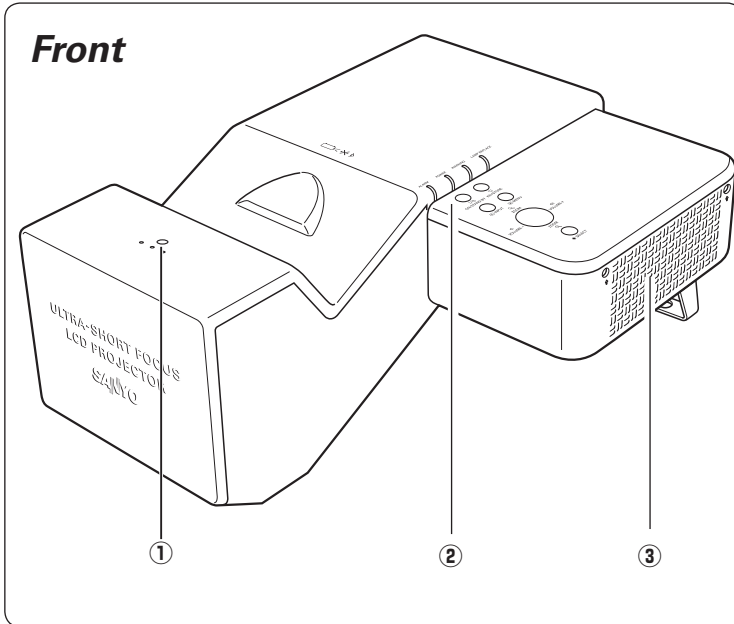
The wire which is coloured brown must be connected to the terminal which is marked with the letter L or coloured red.

WARNING: THIS APPARATUS MUST BE EARTHED.

THE SOCKET-OUTLET SHOULD BE INSTALLED NEAR THE EQUIPMENT AND EASILY ACCESSIBLE.

Part Names and Functions

Front



① Infrared Remote Receiver



The Infrared Remote Receiver sticks out beyond the cabinet surface. If the Infrared Remote Receiver is put on the wall or floor directly, the Infrared Remote Receiver may damage.

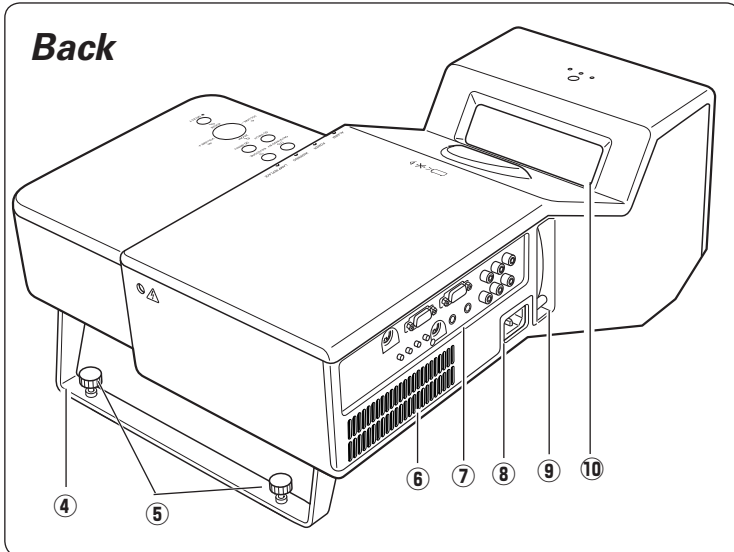
② Top controls and Indicators

③ Exhaust Vent



Hot air is exhausted from the exhaust vent. Do not put heat-sensitive objects near this side.

Back



④ Rear Leg

⑤ Adjustable Feet

⑥ Air Intake Vent

⑦ Terminals and Connectors

⑧ Power Cord Connector

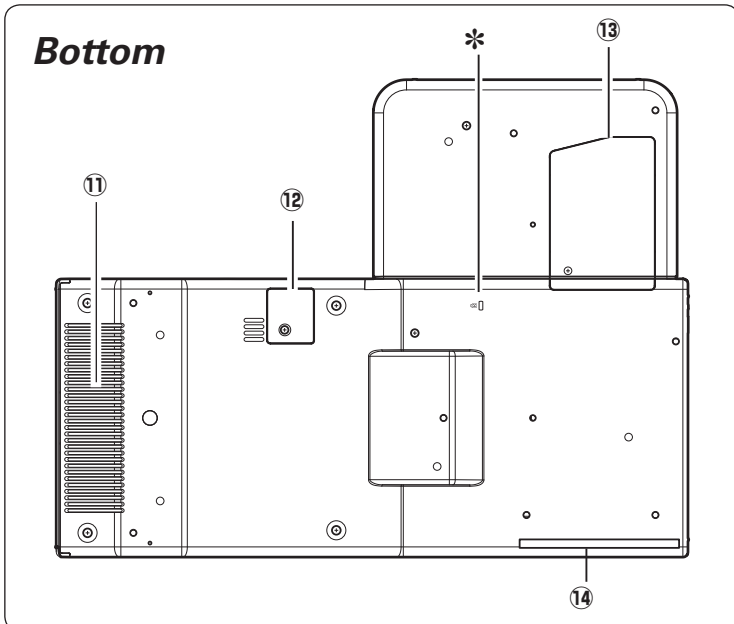
⑨ Focus Lever

⑩ Projection Window

✓ Note:

Do not touch the projection window, otherwise, the window may be soiled and the image can be smudgy.

Bottom



⑪ Speaker

⑫ Battery Cover

⑬ Lamp Cover

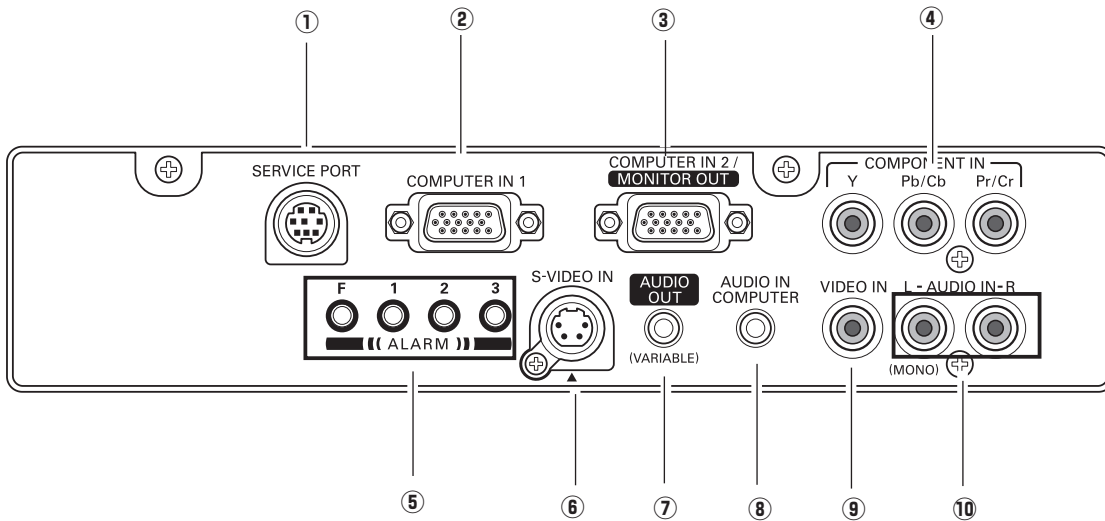
⑭ Air Filter

*Kensington Security Slot

This slot is for a Kensington lock used to deter theft of the projector.

*Kensington is a registered trademark of ACCO Brands Corporation.

Rear Terminal



① **SERVICE PORT**

This jack is used to service the projector.

② **COMPUTER IN 1**

Connect output signal from a computer, or RGB scart 21-pin video output to this terminal (pp.16, 18).

When the cable is of the longer variety, it is advisable to use this terminal and not COMPUTER IN 2/MONITOR OUT.

③ **COMPUTER IN 2/MONITOR OUT**

This terminal is switchable and can be used for input from a computer or output to the other monitor.

Set the terminal up as either Computer input or Monitor output properly. [Used for Monitor out, this terminal outputs only incoming signal from COMPUTER IN 1 terminal (pp. 16, 49)].

④ **COMPONENT IN**

Connect the component video output signal to these jacks (p.18).

⑤ **ALARM buttons**

Use these buttons when setting up the Alarm function (pp.55-56).

⑥ **S-VIDEO IN**

Connect the S-VIDEO output from video equipment to this jack (p.17).

⑦ **AUDIO OUT(VARIABLE)**

Connect an external audio amplifier to this jack (pp.16-18).

This terminal outputs sound from AUDIO IN terminal (⑧ or ⑩).

⑧ **AUDIO IN COMPUTER**

Connect the audio output (stereo) from a computer connected to ② or ③ to this jack (pp.16, 18).

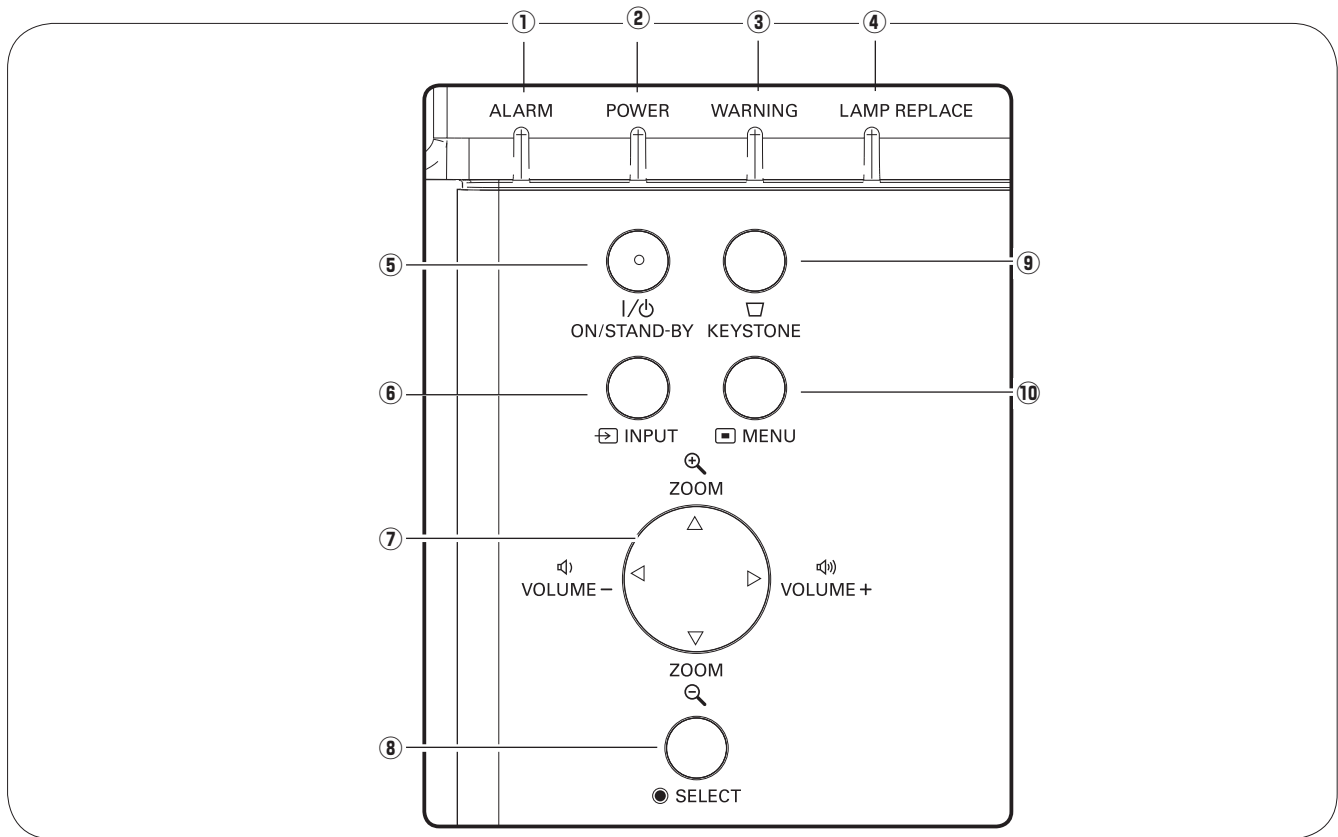
⑨ **VIDEO IN**

Connect the composite video output from video equipment to VIDEO jack (p.17).

⑩ **AUDIO IN**

Connect the audio output from video equipment connected to ④, ⑥ or ⑨ to this jack. [When the audio output is monaural, connect it to L (MONO) jack (p.17, 18).

Top



① ALARM indicator

Blinks red to indicate the battery condition or key operation.

② POWER indicator

- Lights red when the projector is in stand-by mode.
- Lights green during operations.
- Blinks green in the Power management mode (pp.50, 69).

③ WARNING indicator

- Lights red when the projector detects an abnormal condition.
- Blinks red when the internal temperature of the projector exceeds the operating range (pp.59, 69).

④ LAMP REPLACE indicator

Turn yellow when the life of the projection lamp draws to an end (pp.62, 69).

⑤ ON/STAND-BY button

Turn the projector on or off (pp.20-21).

⑥ INPUT button

Select input source (pp.27, 37, 38).

⑦ POINT (▲▼◀▶) buttons

- Select an item or adjust the value in the On-Screen Menu (p.22).
- Pan the image in Digital zoom + mode (p.36).
- Adjust the volume level (Point ◀▶ buttons) (p.25).
- Adjust the screen size (Point ▲▼ buttons) (p.24).

⑧ SELECT button

- Execute the selected item (p.22).
- Expand or compress the image in Digital zoom mode (p.36).

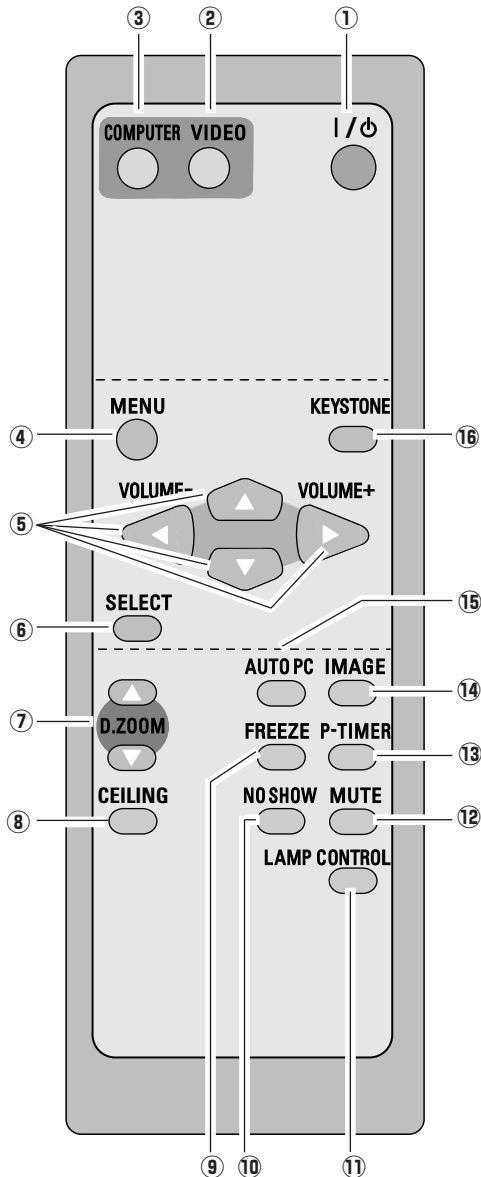
⑨ KEYSTONE button

Correct the keystone distortion (pp.24, 45).

⑩ MENU button

Open or close the On-Screen Menu (p.22).

Remote Control



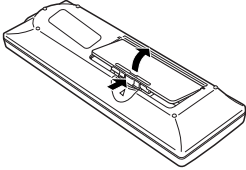
- ① **ON/STAND-BY button**
Turn the projector on or off (pp.20, 21).
- ② **VIDEO button**
Select VIDEO input source (pp.25, 37).
- ③ **COMPUTER button**
Select COMPUTER input source (pp.25, 27, 38).
- ④ **MENU button**
Open or close the On-Screen Menu (p.22).
- ⑤ **Point ▲▼◀▶ (VOLUME + / -) buttons**
 - Select an item or adjust the value in the On-Screen Menu. (p.22)
 - Pan the image in Digital zoom + mode (p.36).
 - Adjust the volume level (Point ◀▶ buttons) (p.25).
- ⑥ **SELECT button**
 - Execute the selected item (p.22).
 - Expand or compress the image in Digital zoom mode. (p.36).
- ⑦ **D.ZOOM ▲▼ buttons**
Zoom in and out the images (pp.26, 36).
- ⑧ **CEILING button**
Reverse the top/bottom and left/right of image (p.49).
- ⑨ **FREEZE button**
Freeze the picture (p.25).
- ⑩ **NO SHOW button**
Temporarily turn off the image on the screen (p.26).
- ⑪ **LAMP CONTROL button**
Select the lamp mode (pp.26, 50).
- ⑫ **MUTE button**
Mute the sound (p.25).
- ⑬ **P-TIMER button**
Operate the P-timer function (p.26).
- ⑭ **IMAGE button**
Select the image level (pp.26, 32, 40).
- ⑮ **AUTO PC button**
Automatically adjust the computer image to its optimum setting (pp.26, 29).
- ⑯ **KEYSTONE button**
Correct the keystone distortion (pp.24, 45).

✓ **Note:**

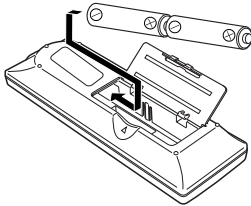
- To ensure safe operation, observe the following precautions:*
- Do not bend, drop, or expose the remote control to moisture or heat.
 - For cleaning, use a soft dry cloth. Do not apply benzene, thinner, spray, or any other chemicals.

Remote Control Battery Installation

1 Open the battery compartment lid.

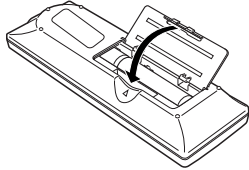


2 Install new batteries into the compartment.



Two AA size batteries
For correct polarity (+ and -), be sure battery terminals are in contact with pins in the compartment.

3 Replace the compartment lid.

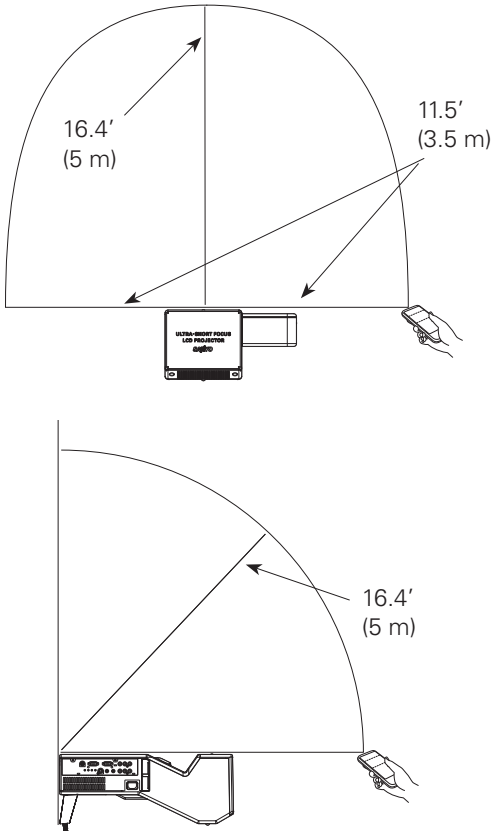


To ensure safe operation, please observe the following precautions:

- Use two (2) AA or LR6 type alkaline batteries.
- Always replace batteries in sets.
- Do not use a new battery with a used battery.
- Avoid contact with water or liquid matter.
- Do not expose the remote control to moisture or heat.
- Do not drop the remote control.
- If the battery has leaked on the remote control, carefully wipe the case clean and install new batteries.
- Risk of explosion if a battery is replaced by an incorrect type.
- Dispose of used batteries according to the instructions.

Operating Range

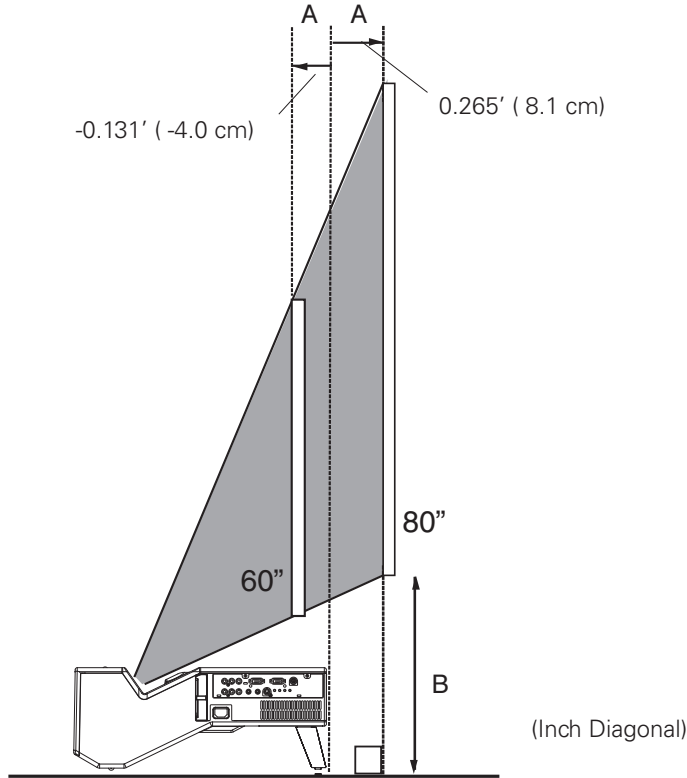
Point the remote control toward the projector (Infrared Remote Receiver) when pressing any button. See the right figures indicating Maximum operating range for the remote control.



Installation

Positioning the Projector

For the projector positioning, see the figures below.
The projector should be set perpendicularly to the plane of the screen.



✓ Note:

- This projector is not equipped with an optical zoom. To adjust the screen size, change the throw distance.
- The brightness in the room has a great influence on picture quality. It is recommended to limit the ambient lighting in order to get the best image.
- All measurements are approximate and may vary from the actual sizes. Make sure to check the position of images by projecting images on the screen before installing the projector and screen, since each projector shows slight variations.
- Make sure to project images on a flat screen.
- Even slight warpage or irregularities of the screen may have an effect on the quality of the projected images.

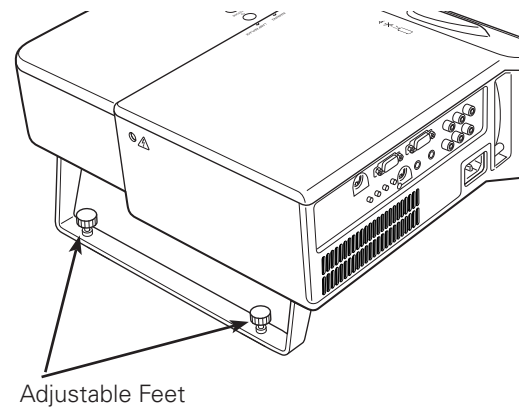
Screen Size (W x H) mm 4:3 aspect ratio	60"	70"	80"
A	-0.131' (-4.0 cm)	0.068' (2.1 cm)	0.265' (8.1 cm)
B	1.010' (30.8 cm)	1.106' (33.7 cm)	1.198' (36.5 cm)

Adjustable Feet

Projection angle can be adjusted up to 1.0 degree with the adjustable feet.

Rotate the adjustable feet to adjust the position and tilt.

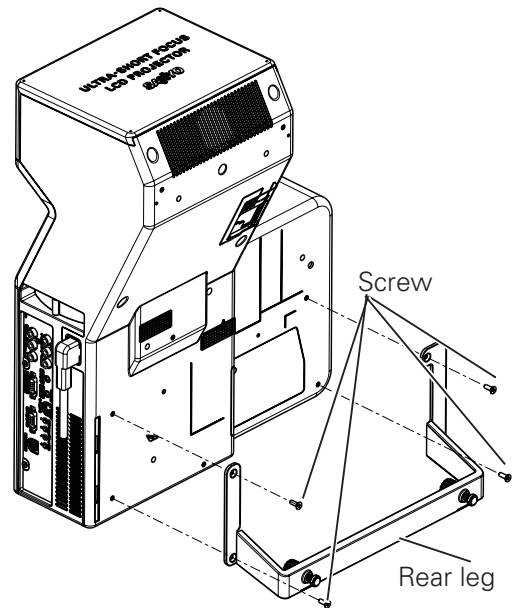
Keystone distortion of the projected image can be corrected by menu operation (pp.24, 45).



Mounting the Rear Leg and the Stand

Rear Leg

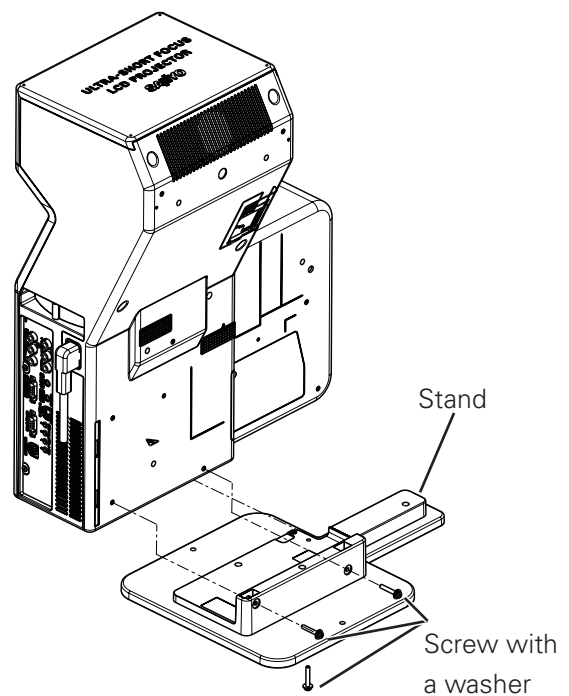
- 1 Turn off the projector and unplug the AC power cord.
- 2 Secure the rear leg with the four (4) screws.



Stand*

- 1 Turn off the projector and unplug the AC power cord.
- 2 Secure the stand with three (3) sets of the screw with a washer.

*The stand is included in standard accessories.



✓ Note:

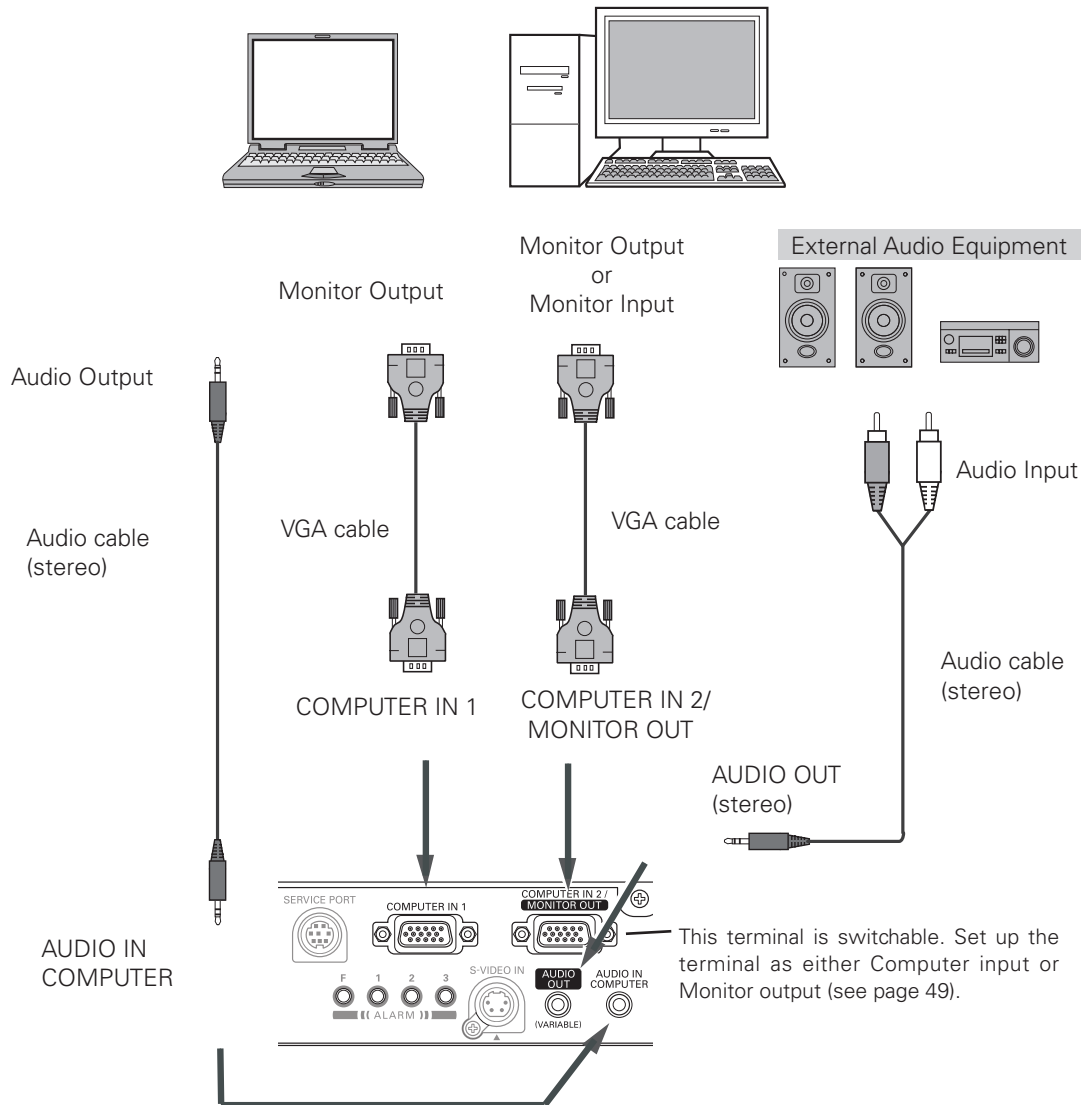
- Make sure not to lose screws when installing the rear leg or the stand.

Connecting to Computer

Cables used for connection

- VGA Cables (Mini D-sub 15 pin)*
- Audio Cables (Mini Plug: stereo)

(*One cable is supplied; other cables are not supplied with the projector.)



✓Note:

- Input sound to the **AUDIO IN COMPUTER** terminal when using the **COMPUTER IN 1** and the **COMPUTER IN 2 / MONITOR OUT** terminal as input.
- When the **AUDIO OUT** is plugged-in, the projector's built-in speaker is not available.
- When the cable is of the longer variety, it is advisable to use the **COMPUTER IN 1** and not the **COMPUTER IN 2 / MONITOR OUT**.
- See page 72 for ordering optional cables.

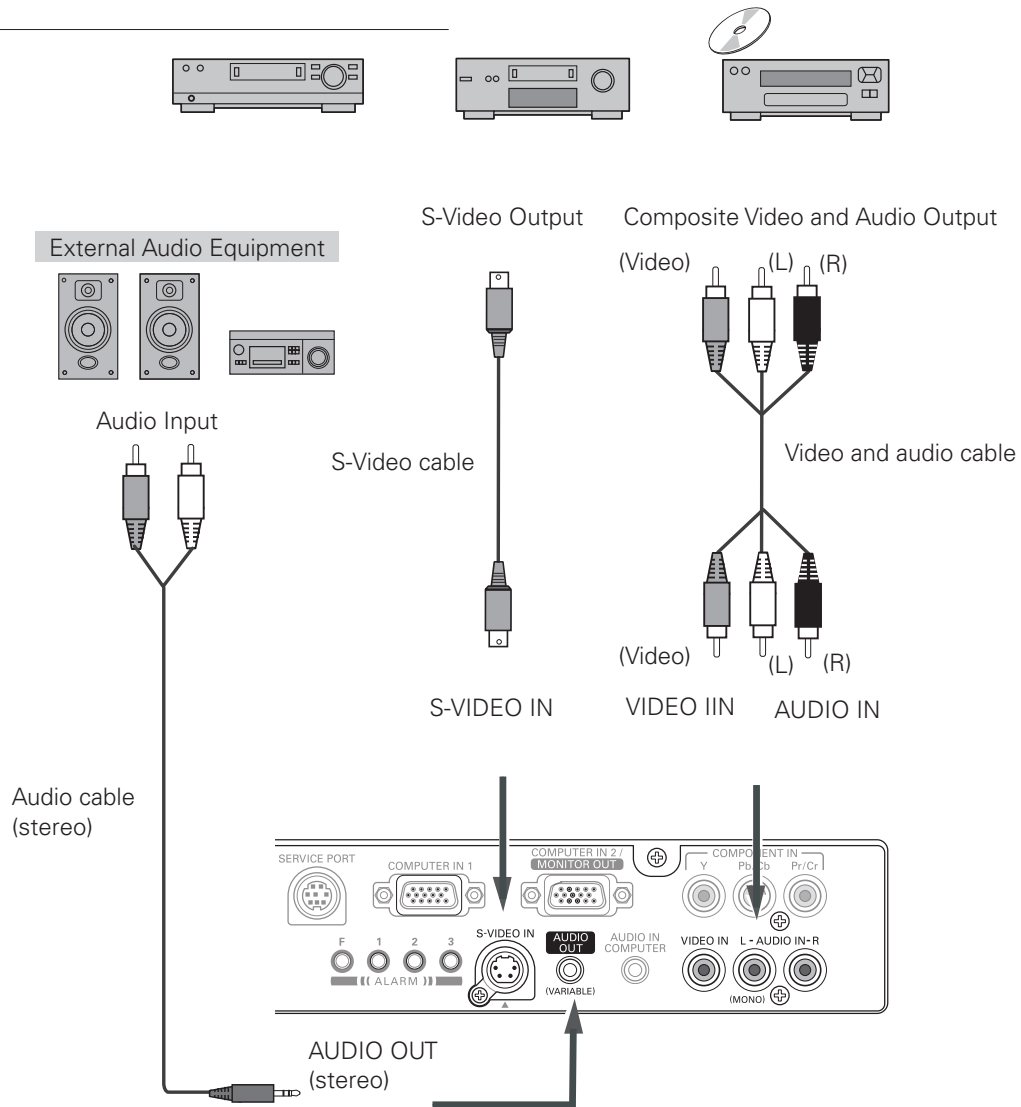


Unplug the power cords of both the projector and external equipment from the AC outlet before connecting the cables.

Connecting to Video Equipment (Video, S-Video)

Cables used for connection

- Video and Audio Cable (RCA x 3)
 - S-VIDEO Cable
 - Audio Cable (Mini Plug: stereo)
- (Cables are not supplied with the projector.)



✓ Note:

- When the AUDIO OUT is plugged-in, the projector's built-in speaker is not available.
- The S-VIDEO jack connection overrides the VIDEO jack connection when AUTO is selected in the Input Menu (p.37).



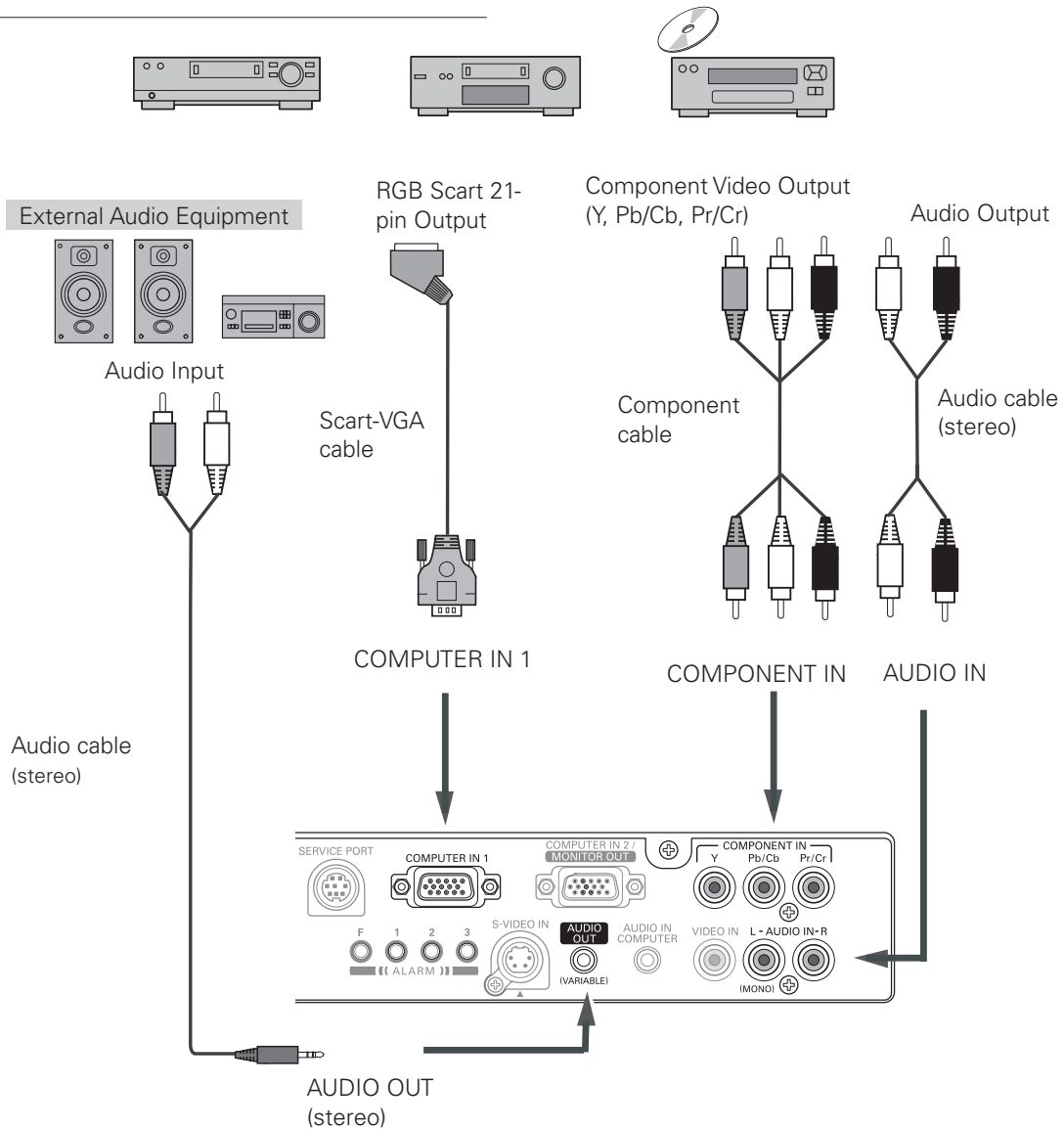
Unplug the power cords of both the projector and external equipment from the AC outlet before connecting the cables.

Connecting to Video Equipment (Component and RGB Scart)

Cables used for connection

- Audio Cables (Mini Plug: stereo, RCA x 2)
- Scart-VGA Cable
- Component Cable

(Cables are not supplied with the projector.)



✓ Note:

- When the **AUDIO OUT** is plugged-in, the projector's built-in speaker is not available.
- See page 72 for ordering optional cables.



Unplug the power cords of both the projector and external equipment from the AC outlet before connecting the cables.

Connecting the AC Power Cord

This projector uses nominal input voltages of 100–120 V or 200–240 V AC and it automatically selects the correct input voltage. It is designed to work with single-phase power systems having a grounded neutral conductor. To reduce the risk of electrical shock, do not plug into any other type of power system.

If you are not sure of the type of power being supplied, consult your authorized dealer or service station. Connect the projector with all peripheral equipment before turning it on.

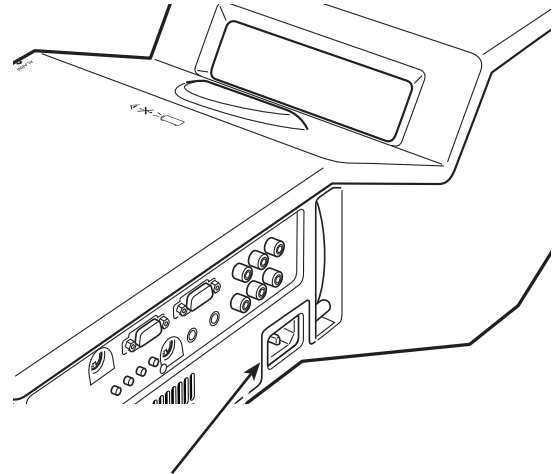


CAUTION

The AC outlet must be near this equipment and must be easily accessible.

✓ Note:

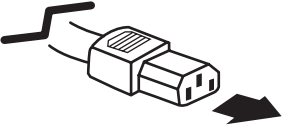
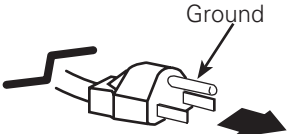
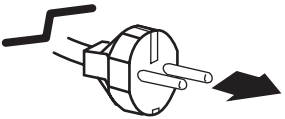
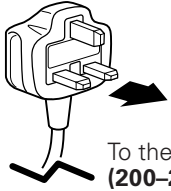
- *Unplug the AC power cord when the projector is not in use. When the projector is connected to an outlet with AC power cord, it is in stand-by mode and consumes a little electric power.*



Connect the AC power cord (supplied) to the projector.

NOTE ON THE POWER CORD

AC power cord must meet the requirements of the country where you use the projector. Confirm the AC plug type with the chart below and proper AC power cord must be used. If the supplied AC power cord does not match your AC outlet, contact your sales dealer.

Projector side	AC outlet side		
 <p>To power cord connector on your projector.</p>	<p>For the U.S.A. and Canada</p>  <p>To the AC outlet. (120 V AC)</p>	<p>For Continental Europe</p>  <p>To the AC outlet. (200–240 V AC)</p>	<p>For the U.K.</p>  <p>To the AC outlet. (200–240 V AC)</p>

Basic Operation

Turning On the Projector

- 1 Complete peripheral connections (with a computer, VCR, etc.) before turning on the projector.
- 2 Connect the projector's AC power cord into an AC outlet. The POWER indicator turns red.
- 3 Press the ON/STAND-BY button on the top control or on the remote control. The POWER indicator becomes green and the cooling fans start to operate. The preparation display appears on the screen and the count down starts.
- 4 After the countdown, the input source that was selected the last time and the Lamp mode status icon (see page 50) will appear on the screen. If the projector is locked with a PIN code, a PIN code Input Dialog Box appears. Enter the PIN code as instructed below.

Enter a PIN code

Select a number by pressing the Point ▲▼ buttons, and then press the Point ► button to fix the number and move the pointer. The number changes to "*". If you fixed an incorrect number, move the pointer to the number you want to correct by pressing the Point ◀ button, and then select the correct number by pressing the Point ▲▼ buttons.

Repeat this step to complete entering a four-digit number. "1234" is set as the initial PIN code at the factory.

After entering the four-digit number, move the pointer to "Set" by pressing the Point ► button. Press the SELECT button so that you can start to operate the projector.

If you entered an incorrect PIN code, "PIN code" and the number (****) turns red. Enter the correct PIN code all over again.

What is PIN code?

PIN (Personal Identification Number) code is a security code that allows the person who knows it to operate the projector. Setting the PIN code prevents unauthorized use of the projector.

A PIN code consists of a four-digit number. Refer to the PIN code lock function in the Setting Menu on pages 52-53 for locking operation of the projector with your PIN code.



CAUTION ON HANDLING THE PIN CODE

If you forget your PIN code, the projector can no longer be started. Take a special care in setting a new PIN code; write down the number in a column on page 74 of this manual and keep it at hand. Should the PIN code be missing or forgotten, consult your dealer or service center.



The preparation display disappears after 30 seconds.

Selected Input Source and Lamp Mode

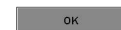
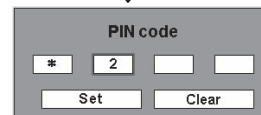
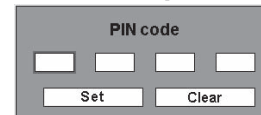


See page 50 for the Lamp mode.

✓Note:

- The Lamp replacement icon and the Filter warning icon may appear on the screen depending on the usage state of the projector.

PIN Code Input Dialog Box



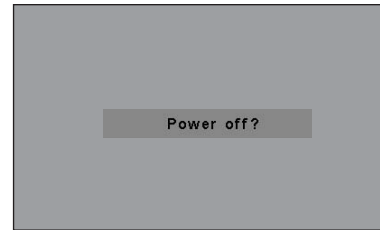
After the OK icon disappears, you can operate the projector.

✓Note:

- When the Input Search function is set on On1 or On2, the input signal will be searched automatically (p.49).
- When the Logo select function is "Off," the logo will not be displayed on the screen (p.47).
- When the "Countdown off" or "Off" is selected in the Display function, the countdown will not be shown on the screen (p.46).
- During the countdown period, all operations are invalid.
- If the correct PIN code number is not entered for 3 minutes after the PIN code dialog box appeared, the projector will be turned off automatically.

Turning Off the Projector

- 1 Press the ON/STAND-BY button on the top control or on the remote control, and "Power off?" appears on the screen.
- 2 Press the ON/STAND-BY button again to turn off the projector. The POWER indicator starts to blink red, and the cooling fans keep running. (You can select the level of the fans' quietness and running speed. See page 54.) At this time you can unplug the AC power cord even if the fans are still running.
- 3 When the projector has cooled down enough to be turned on again, the POWER indicator stops blinking.



"Power off" disappears after 4 seconds.



TO MAINTAIN THE LAMP LIFE, ONCE YOU TURN THE PROJECTOR ON, WAIT AT LEAST 5 MINUTES BEFORE TURNING IT OFF.



DO NOT OPERATE THE PROJECTOR CONTINUOUSLY WITHOUT REST. CONTINUOUS USE MAY RESULT IN SHORTENING THE LAMP LIFE. TURN OFF THE PROJECTOR AND LET STAND FOR ABOUT AN HOUR IN EVERY 24 HOURS.

✓Note:

- When the On start function is "On," this projector is turned on automatically by connecting the AC power cord to an AC outlet (p. 50).
- The running speed of cooling fans is changed according to the temperature inside the projector.
- Do not put the projector in a case before the projector is cooled enough.
- If the WARNING indicator blinks or emits a red light, see "Warning Indicator" on page 59.
- While the POWER indicator is blinking, the lamp is being cooled down and the projector cannot be turned on. Wait until the POWER indicator stops blinking to turn on the projector again.
- The fan rotation will terminate directly if the AC power cord is unplugged immediately after the projector is turned off.
- The projector can be turned on after the POWER indicator turns red. The waiting time to restart will be shortened when the normal power-off processing for fan cooling is completed, compared with the time the AC power cord is immediately unplugged after the power-off.

How to Operate the On-Screen Menu

The projector can be adjusted or set via the On-Screen Menu. For each adjustment and setting procedure, refer to the respective sections in this manual.

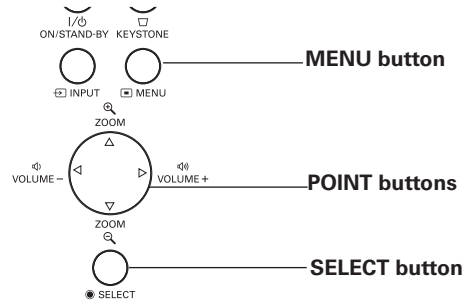
- 1** Press the MENU button on the top control or on the remote control to display the On-Screen Menu.
- 2** Use the Point ◀▶ buttons to select a Menu icon; use the Point ▲▼ buttons to select an item.
- 3** Press the SELECT button to show the item data. To adjust the data, use the Point ◀▶ buttons. Refer to the relevant pages for more details about each adjustment.

To close the On-Screen Menu, press the MENU button again.

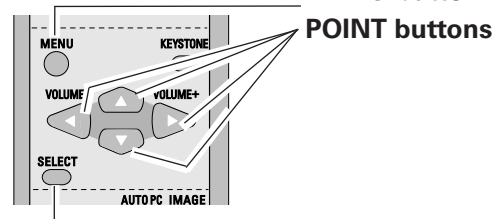
✓ Note:

- The selected item is not active until the SELECT button is pressed.

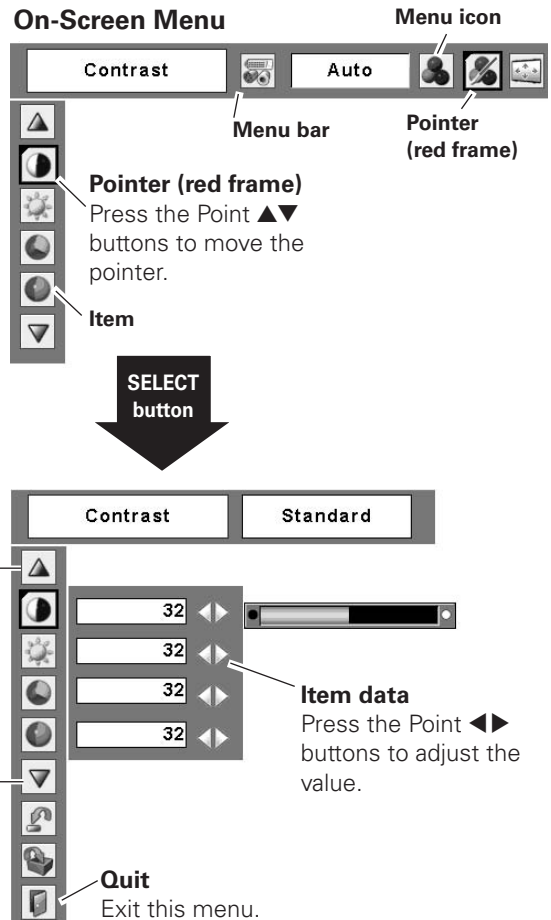
Top Control



Remote Control



On-Screen Menu



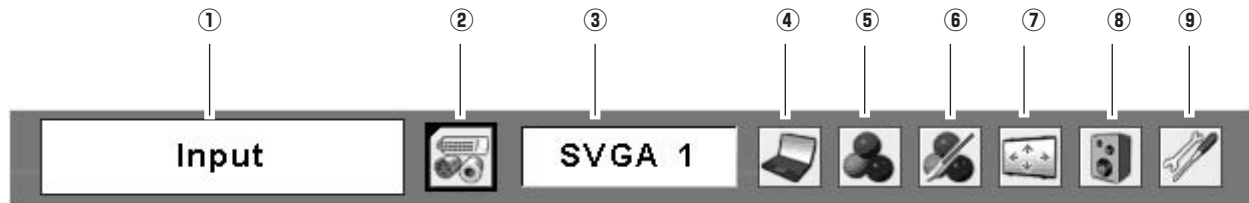
Press the SELECT button here to display previous items.

Press the SELECT button here to display next items.

Menu Bar

For detailed functions, see Menu Tree on pages 67-68.

For computer source



① Guide Window

Shows the selected Menu of the On-Screen Menu.

② Input Menu

Used to select the input source, Computer or Video (p.27).

③ PC System Menu

Used to select the computer system (p.28).

④ PC Adjust Menu

Used to adjust parameters to match with input signal format (pp.29-31).

⑤ Image Select Menu

Used to select an image level from Dynamic, Standard, Real, Blackboard (Green), Colorboard and Image 1-4 (pp.32-33).

⑥ Image Adjust Menu

Used to adjust the computer image from Contrast, Brightness, Color temp., White balance (R/G/B), Sharpness, and Gamma (pp.34-35)

⑦ Screen Menu

Used to adjust the size of image from Normal, True, Wide, Full and Digital zoom +/- (pp.35-36).

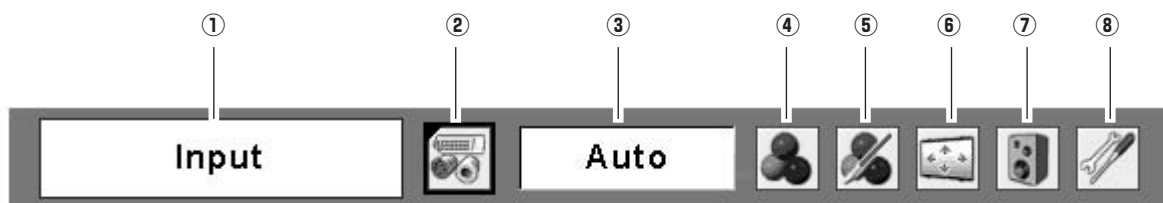
⑧ Sound Menu

Used to adjust the volume or mute the sound (p.25).

⑨ Setting Menu

Used to set the projector's operating configurations (pp.45-54).

For video source



① Guide Window

Shows the selected Menu of the On-Screen Menu.

② Input Menu

Used to select input source, Video or Computer (pp.37-38).

③ AV System Menu

Used to select the system of selected video source (p.39).

④ Image Select Menu

Used to select an image level from Dynamic, Standard, Cinema, Blackboard (Green), Colorboard and Image 1-4 (pp.40-41).

⑤ Image Adjust Menu

Used to adjust the picture image from Contrast, Brightness, Color, Tint, Color temp., White balance (R/G/B), Sharpness, Gamma, Noise reduction, and Progressive (pp.42-43).

⑥ Screen Menu

Used to set the size of image to Normal or Wide (p.44).

⑦ Sound Menu

Used to adjust the volume or mute the sound (p.25).

⑧ Setting Menu

Used to set the projector's operating configurations (pp.45-54).

Zoom Adjustment

Press the ZOOM +/- buttons on the top control to adjust the screen size. Screen size can be adjusted 84% to 100% from its maximum screen size.

It is not available when On-Screen menu is displayed.

Zoom adjustment can be memorized. (p.45)

Screen Position Adjustment

Screen position can be adjusted in the Zoom Adjustment.

- 1 Press the ZOOM+ or ZOOM- buttons on the top control.
- 2 While ZOOM+ or ZOOM- is displayed on the screen, press the SELECT button. Arrow marks displayed on the screen.
- 3 Press the point ▲▼◀▶ buttons to adjust screen positions.

Screen position can not be adjusted at ZOOM maximum.

Focus Adjustment

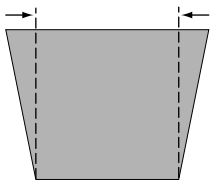
Adjust the lens focus with the focus lever.

Keystone Correction

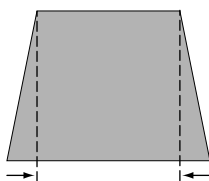
If a projected picture has keystone distortion, correct the image with the Keystone function.

Press the KEYSTONE button on the top control or on the remote control. The keystone dialog box appears. Correct keystone distortion with the Point ▲▼ buttons. Keystone adjustment can be stored (p.45).

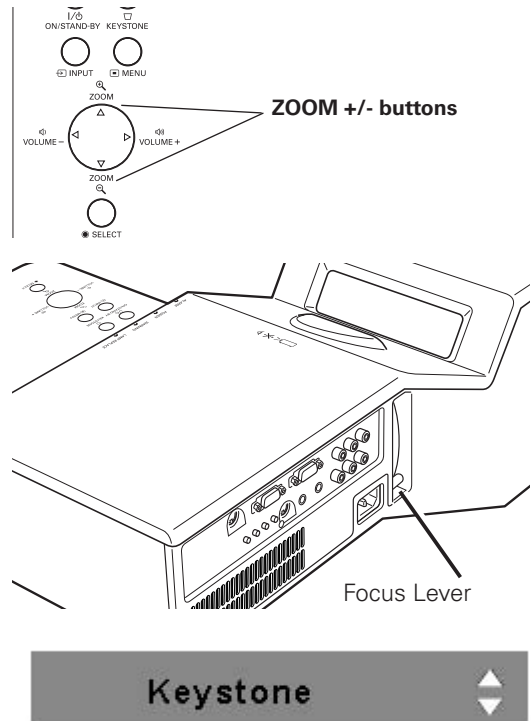
Reduce the upper width with the Point ▲ button.



Reduce the lower width with the Point ▼ button.

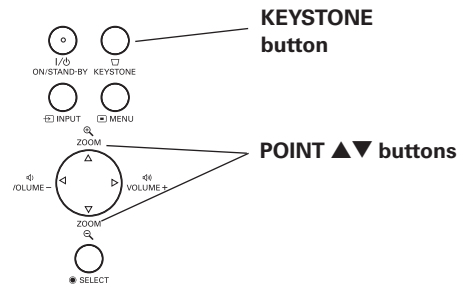


Top Control

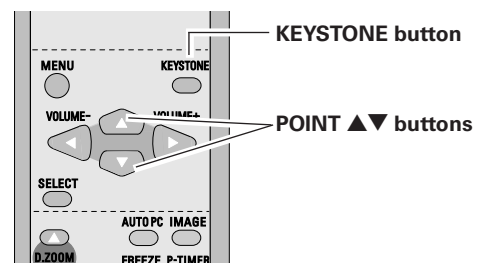


- The arrows are white when there is no correction.
- The direction of the arrow which are being corrected turns red.
- The arrows disappear at the maximum correction.
- If you press the KEYSTONE button on the top control or on the remote control once more while the keystone dialog box is being displayed, the keystone adjustment is canceled.
- The adjustable range can be limited depending on the input signal.
- The projected picture may fluctuate momentarily depending on the keystone adjustment.
- "Keystone" disappears after 4 seconds.

Top Control



Remote Control



Sound Adjustment

Direct Operation

Volume

Press the VOLUME+/- buttons on the top control or on the remote control to adjust the volume. The volume dialog box appears on the screen for a few seconds.

Mute

Press the MUTE button on the remote control to turn off the sound. To restore the sound to its previous level, press the MUTE button again or press the VOLUME+/- buttons. Mute function is also effective for AUDIO OUT jack.

Menu Operation

- 1 Press the MENU button to display the On-Screen Menu. Use the Point ◀▶ buttons to move the red frame pointer to the Sound Menu icon.
- 2 Press the Point ▲▼ buttons to move the red frame pointer to the desired item, and then press the SELECT button.

Volume

Press the Point ▶ button to turn up the volume; press the Point ◀ button to turn down the volume.

Mute

Press the Point ◀▶ buttons to turn off the sound. The mute dialog box display is changed to "On" and the sound is turned off. To restore the sound to its previous level, press the Point ◀▶ buttons again.

Remote Control Operation

Using the remote control for some frequently used operations is advisable. Just pressing one of the buttons enables you to make the desired operation quickly without calling up the On-Screen Menu.

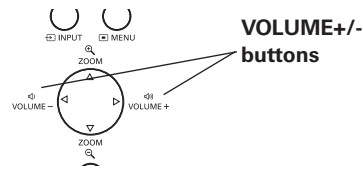
COMPUTER/VIDEO button

Press the COMPUTER or VIDEO button to select an input source. See pages 27, 37-38 for more details.

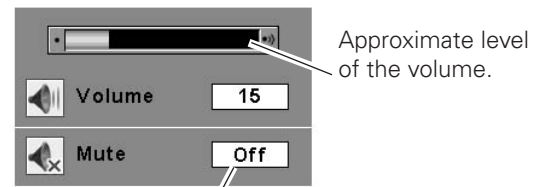
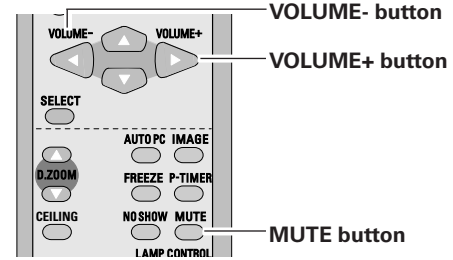
FREEZE button

Press the FREEZE button to freeze the picture on the screen. To cancel the Freeze function, press the FREEZE button again or press any other button.

Top Control

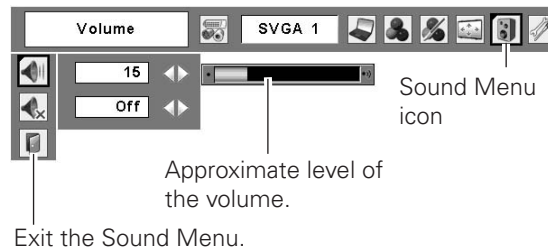


Remote Control

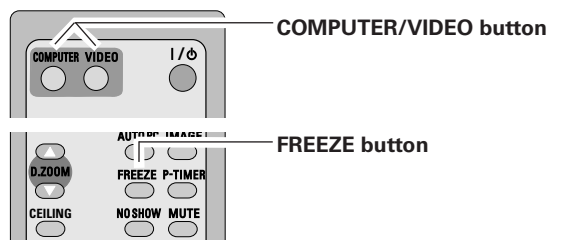


Press the MUTE button to set the Mute function On or Off. The display disappears after 4 seconds.

Sound Menu



Remote Control



✓Note:

- See the next page for the description of other buttons.

AUTO PC button

Press the AUTO PC button to operate the Auto PC function. See page 24 for more details.

D.ZOOM buttons

Press the D.ZOOM buttons to zoom in and zoom out the images. See page 36 for more details.

CEILING button

Press the CEILING button to reverse the top/bottom and left/right of image (p49).

NO SHOW button

Press the NO SHOW button to black out the image. To restore to normal, press the NO SHOW button again or press any other button. When the projected image is captured and is set as "User" in the Logo selection (p.47), the screen changes each time you press the NO SHOW button as follows.

black out → the captured image → normal →

KEystone button

For details, see page 24.

IMAGE button

Press the IMAGE button to select an image level of the screen. See pages 32, 40 for more details.

P-TIMER button

Press the P-TIMER button. The timer display "00:00" appears on the screen and the timer starts to count time (00:00–59:59).

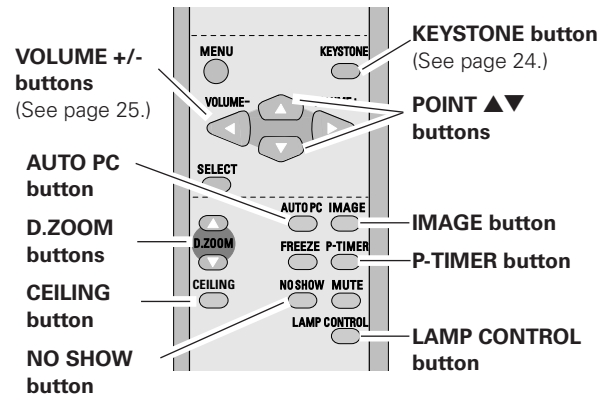
To stop the P-Timer, press the P-TIMER button. Press the P-TIMER button again, then the P-Timer display disappears.

LAMP CONTROL button

Press the LAMP CONTROL button to select the lamp mode to change the brightness of the screen.

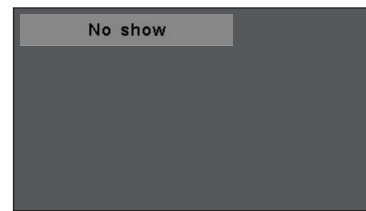
- ☾ Normal ... Normal brightness
- ☾ Auto Brightness according with the input signal
- ☾ Eco Lower brightness reduces the lamp power consumption and extends the lamp life.

Remote Control



✓ Note:

- See the previous page for the description of other buttons.



"No show" disappears after 4 seconds.



P-Timer display

Computer Input

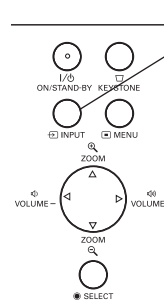
Input Source Selection

Direct Operation

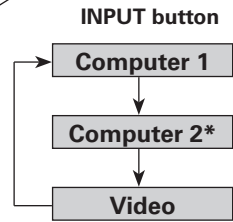
Press the INPUT button on the top control or the COMPUTER button on the remote control to select either Computer 1 or Computer 2.

Before using the INPUT or COMPUTER buttons, select the correct input source through Menu operation as described below.

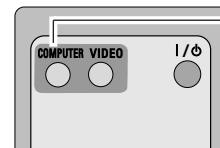
Top Control



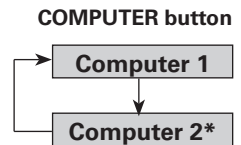
INPUT button



Remote Control



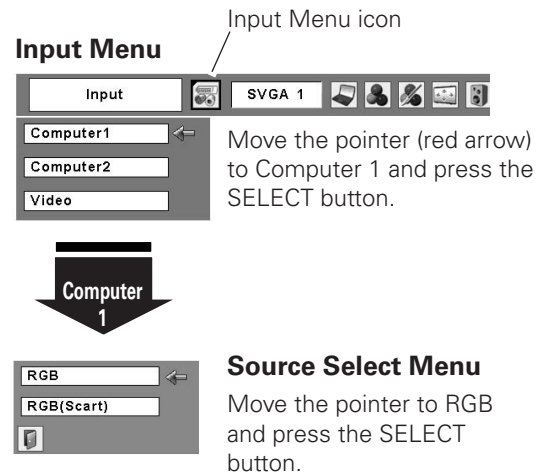
COMPUTER button



*See Notes at the bottom of this page.

Menu Operation

- 1 Press the MENU button to display the On-Screen Menu. Use the Point ◀▶ buttons to move the red frame pointer to the Input Menu icon.
- 2 Use the Point ▲▼ buttons to move the red arrow pointer to either Computer 1 or Computer 2, and then press the SELECT button.
- 3 After the Source Select Menu appeared for Computer 1, move the pointer to RGB and then press the SELECT button.



✓Note:

- Computer 2 is not displayed when the COMPUTER IN 2/ MONITOR OUT terminal is set as Monitor out (p.49).
- Computer 2 (COMPUTER IN 2/MONITOR OUT) can accept only the RGB signal.
- When the Input Search function is set On1 or On2, the input signal will be searched automatically (p.49)

Input Menu



Computer System Selection

The projector automatically tunes to various types of computers based on VGA, SVGA, XGA, SXGA, WXGA, or UXGA with its Multi-scan system and Auto PC Adjustment. If computer is selected as a signal source, the projector automatically detects the signal format and tunes to project proper images without any additional setting. (Signal formats provided in this projector is shown on page 69.)

One of the following messages may appear when:

Auto

The projector cannot recognize the connected signal conforming to the provided PC Systems. "Auto" is displayed on the PC System Menu icon and the Auto PC Adjustment function works to display proper images. If images are not projected properly, adjust manually. (pp.30-31)

There is no signal input from computer. Check the connection between your computer and the projector. (See "Troubleshooting" on page 64.)

Mode 1

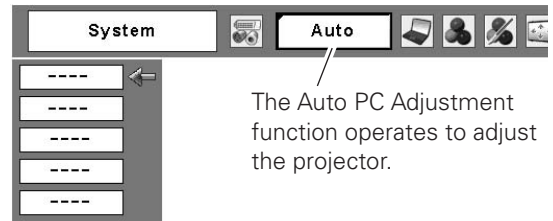
The preset system is manually adjusted in the PC Adjust Menu. The adjusted data can be stored in Mode 1-5 (pp.30-31).

SVGA 1

A PC System provided in the projector is selected. The projector selects a proper system provided in the projector and displays it.

*Mode 1 and SVGA 1 are examples.

PC System Menu

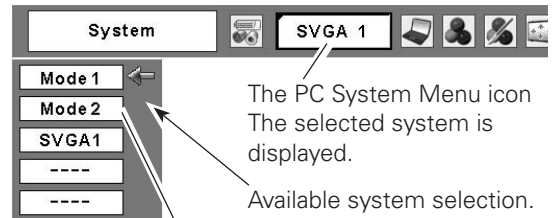


Selecting Computer System Manually

PC system can also be selected manually.

- 1 Press the MENU button to display the On-Screen Menu. Use the Point ◀▶ buttons to move the red frame pointer to the PC System Menu icon.
- 2 Use the Point ▲▼ buttons to move the red arrow pointer to the desired system, and then press the SELECT button.

PC System Menu



Custom Mode (1-5) set in the PC Adjust Menu (pp.30-31).

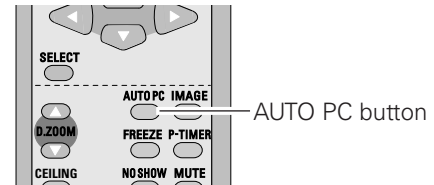
Auto PC Adjustment

Auto PC Adjustment function is provided to automatically adjust Fine sync, Total dots, Horizontal, and Vertical positions to conform to your computer.

Direct Operation

The Auto PC adjustment function can be operated directly with the AUTO PC button on the remote control.

Remote Control



Menu Operation

Auto PC Adj.

- 1 Press the MENU button to display the On-Screen Menu. Use the Point ◀▶ buttons to move the red frame pointer to PC Adjust Menu.
- 2 Use the Point ▲▼ buttons to move the red frame pointer to Auto PC Adj. and then press the SELECT button twice.

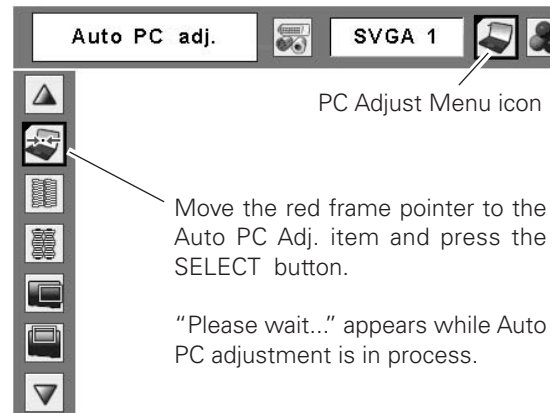
To store the adjusted parameters

The system parameters adjusted in the Auto PC Adjustment can be stored in the projector. Once parameters are stored, the setting can be done just by selecting a Mode in the PC System Menu (p.28). See "Store" on page 31, for details.

✓Note:

- Fine sync, Total dots, Horizontal, and Vertical positions of some computers cannot be fully adjusted with this Auto PC Adjustment function. When the image is not provided properly with this operation, manual adjustments are required (pp.30-31).
- The Auto PC Adjustment cannot be operated when 480i, 575i, 480p, 575p, 720p, 1035i, or 1080i is selected in the PC System Menu (p.28).

PC Adjust Menu



Manual PC Adjustment

Some computers employ special signal formats which may not be tuned by Multi-scan system of this projector. Manual PC Adjustment enables you to precisely adjust several parameters to match those signal formats. The projector has five independent memory areas (Mode 1–5) to store those parameters manually adjusted, which allows you to recall the setting for a specific computer.

- 1 Press the MENU button to display the On-Screen Menu. Use the Point ◀▶ buttons to move the red frame pointer to the PC Adjust Menu icon.
- 2 Use the Point ▲▼ buttons to move the red frame pointer to the desired item and then press the SELECT button to display the adjustment dialog box. Press the Point ◀▶ buttons to adjust the value.

Fine sync

Use the Point ◀▶ buttons to adjust the value to cut off flicker from the image displayed (from 0 to 31).

Total dots

Use the Point ◀▶ buttons to adjust the number of total dots in one horizontal period to match your PC image.

Horizontal

Use the Point ◀▶ buttons to adjust the horizontal picture position.

Vertical

Use the Point ◀▶ buttons to adjust the vertical picture position.

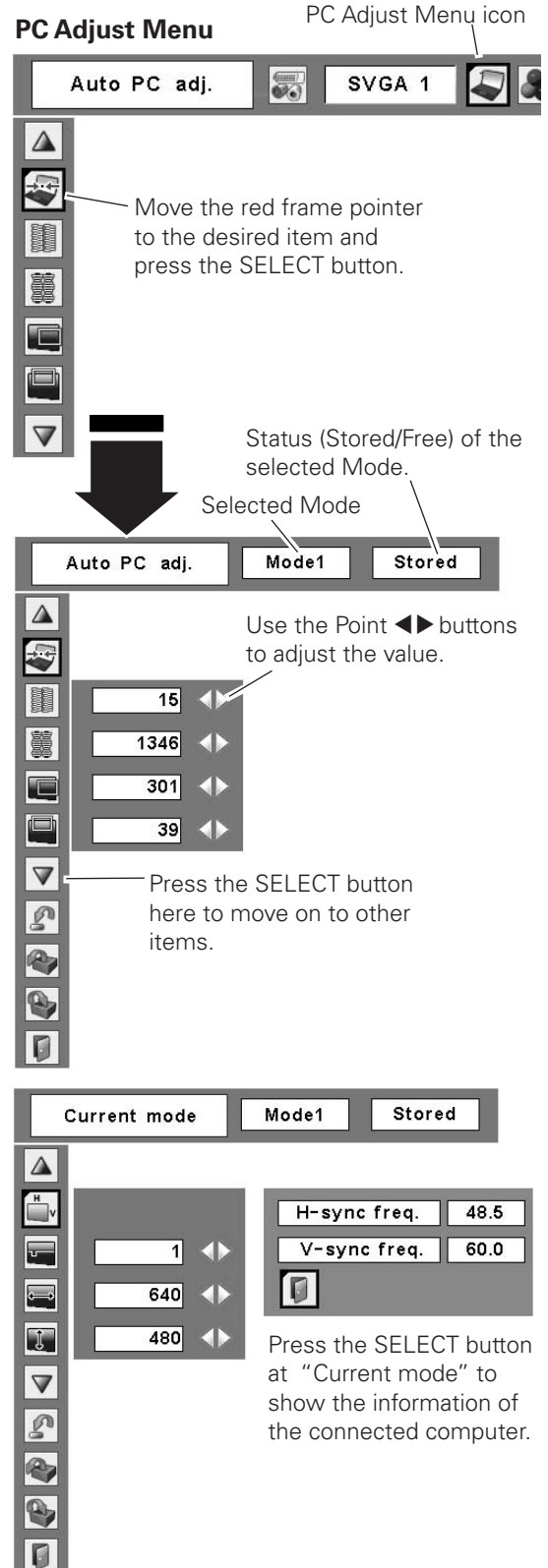
Current mode

Press the SELECT button to show H-sync freq. and V-sync freq. of the connected computer.

Clamp

Use the Point ◀▶ buttons to adjust the clamp level. When the image has dark bars, try this adjustment.

PC Adjust Menu PC Adjust Menu icon



Auto PC adj. SVGA 1

Move the red frame pointer to the desired item and press the SELECT button.

Status (Stored/Free) of the selected Mode.

Selected Mode

Auto PC adj. Mode1 Stored

Use the Point ◀▶ buttons to adjust the value.

Press the SELECT button here to move on to other items.

Current mode Mode1 Stored

H-sync freq. 48.5
V-sync freq. 60.0

Press the SELECT button at "Current mode" to show the information of the connected computer.

 **Display area H**

Use the Point ◀▶ buttons to adjust the horizontal area displayed by this projector.

 **Display area V**

Use the Point ◀▶ buttons to adjust the vertical area displayed by this projector.

 **Reset**

To reset the adjusted data, select "Reset" and press the SELECT button. A confirmation box appears and then select "Yes." All adjustments return to their previous figures.

 **Mode free**

To clear the stored data, select "Mode free" and then press the SELECT button. Move the red arrow pointer to the Mode that you want to clear and then press the SELECT button.

 **Store**

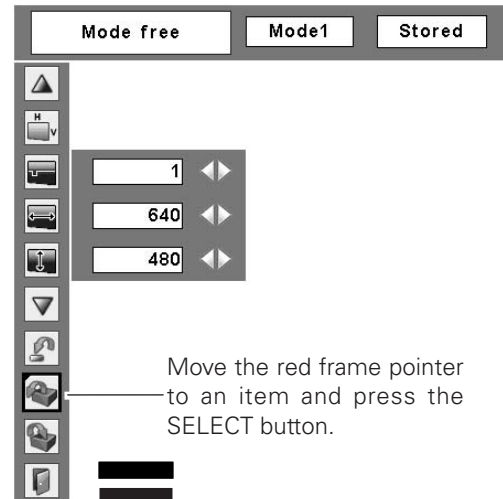
To store the adjusted data, select "Store" and then press the SELECT button. Move the red arrow pointer to one of the Mode 1 to 5 in which you want to store, and then press the SELECT button.

 **Quit**

Exit the PC Adjust Menu.

✓ **Note:**

- Display area (H/V) cannot be selected when 480i, 575i, 480p, 575p, 720p, 1035i, or 1080i is selected in the PC System Menu (p.28).



Move the red frame pointer to an item and press the SELECT button.

To clear adjusted data

This Mode has stored parameters.

Where to free?

Mode1	Stored	800	142	34	1024	768
Mode2	Free	800	142	34	1024	768
Mode3	Free	800	142	34	1024	768
Mode4	Free	800	142	34	1024	768
Mode5	Free	800	142	34	1024	768

Vacant Mode

Values of "Total dots," "Horizontal," "Vertical," "Display area H," and "Display area V."

To store adjusted data

Where to store?

Mode1	Stored	800	142	34	1024	768
Mode2	Free	800	142	34	1024	768
Mode3	Free	800	142	34	1024	768
Mode4	Free	800	142	34	1024	768
Mode5	Free	800	142	34	1024	768

Close this dialog box.

Image Level Selection

Direct Operation

Select an image level from among Dynamic, Standard, Real, Blackboard (Green), Colorboard, Image 1, Image 2, Image 3, or Image 4 with the IMAGE button on the remote control.

Dynamic

For viewing pictures in a bright room.

Standard

Normal picture level preset on the projector.

Real

Picture level with improved halftone for graphics.

Blackboard (Green)

For viewing the image projected on a blackboard. This mode assists to enhance the image projected on a blackboard. This is mainly effective on a green colored board, not truly effective on a black colored board.

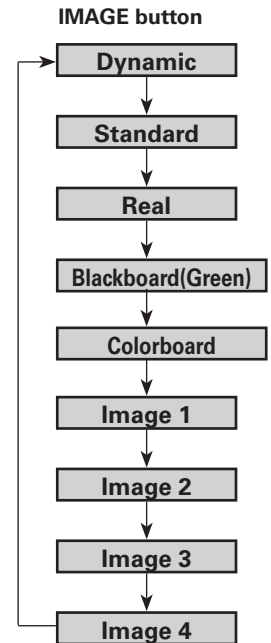
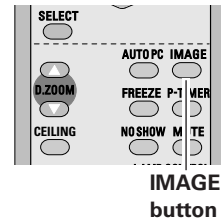
Colorboard

At the time of simple projection on the colored wall, you can get the close color image to the color image projected on a white screen by selecting the similar color to the wall color from the preset four colors. See the next page.

Image 1-4

User preset image in the Image Adjust Menu (p.35).

Remote Control



Menu Operation

- 1 Press the MENU button to display the On-Screen Menu. Use the Point ◀▶ buttons to move the red frame pointer to the Image Select Menu icon.
- 2 Use the Point ▲▼ buttons to move the red frame pointer to the desired level and then press the SELECT button.

 **Dynamic**

For viewing pictures in a bright room.

 **Standard**

Normal picture level preset on this projector.

 **Real**

Picture level with improved halftone for graphics.

 **Blackboard(Green)**

For viewing the image projected on a blackboard. This mode assists to enhance the image projected on a blackboard. This is mainly effective on a green colored board, not truly effective on a black colored board.

 **Colorboard**

At the time of simple projection on the colored wall, you can get the close color image to the color image projected on a white screen by selecting the similar color to the wall color from the preset four colors. Press the SELECT button to choose the color.

 **Image 1-4**

User preset image in the Image Adjust Menu (p.35).

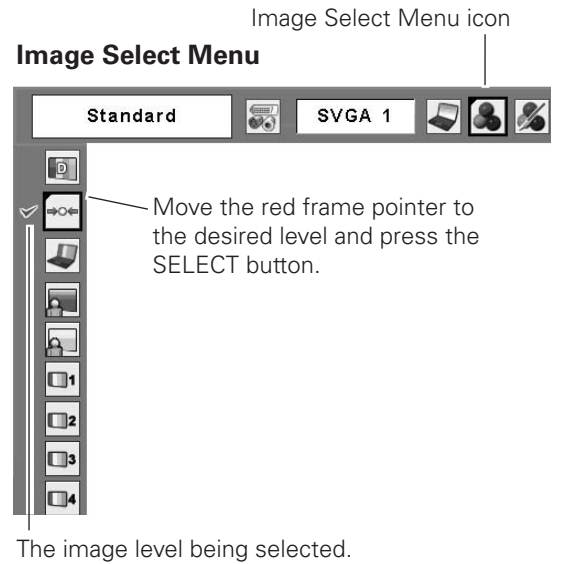


Image Level Adjustment

- 1 Press the MENU button to display the On-Screen Menu. Use the Point ◀▶ buttons to move the red frame pointer to the Image Adjust Menu icon.
- 2 Use the Point ▲▼ buttons to move the red frame pointer to the desired item, and then press the SELECT button. The level of each item is displayed. Use the Point ◀▶ buttons to adjust each level.

Contrast

Press the Point ◀ button to decrease the contrast; press the Point ▶ button to increase the contrast (from 0 to 63).

Brightness

Press the Point ◀ button to decrease the brightness; press the Point ▶ button to increase the brightness (from 0 to 63).

Color temp.

Use the Point ◀▶ buttons to select the desired Color temp. level (XLow, Low, Mid, or High).

White balance (Red)

Press the Point ◀ button to lighten the red tone; press the Point ▶ button to deepen the red tone (from 0 to 63).

White balance (Green)

Press the Point ◀ button to lighten the green tone; press the Point ▶ button to deepen the green tone (from 0 to 63).

White balance (Blue)

Press the Point ◀ button to lighten the blue tone; press the Point ▶ button to deepen the blue tone (from 0 to 63).

Sharpness

Press the Point ◀ button to decrease the sharpness of the image; press the Point ▶ button to increase the sharpness of the image (from 0 to 15).

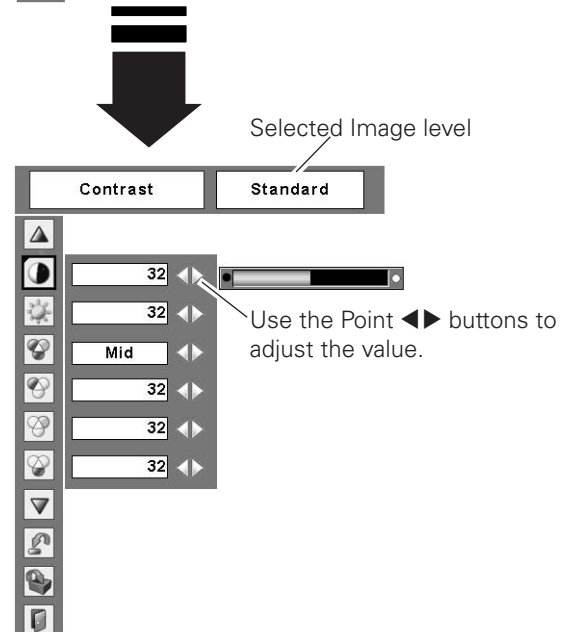
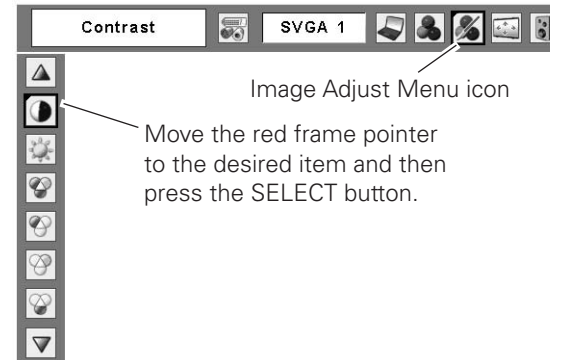
Gamma

Use the Point ◀▶ buttons to adjust the gamma value to get better balance of contrast (from 0 to 15).

Reset

To reset the adjusted data, select "Reset" and press the SELECT button. A confirmation box appears and then select "Yes." All adjustments return to their previous figures.

Image Adjust Menu



✓Note:

- After adjusting the White balance Red, Green, or Blue, the Color temp. level will change to "Adj."

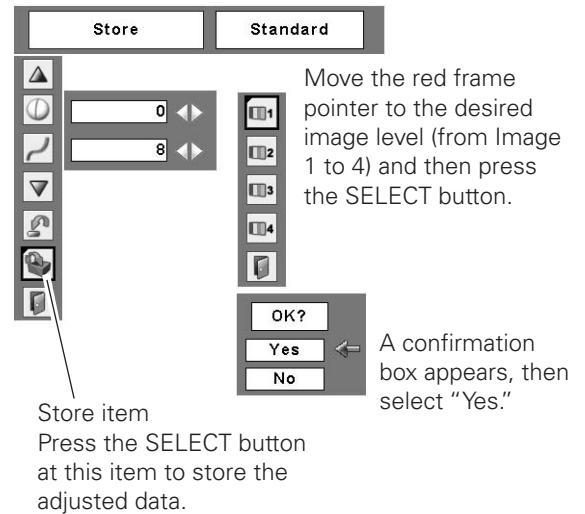
 **Store**

To store the adjusted data, select "Store" and press the SELECT button. The Image Level Menu appears. Use the Point ▲▼ buttons to choose one of the four image level and press the SELECT button. A confirmation box appears and then select "Yes."

The stored data can be called up by selecting "Image" in the Image Level Selection on page 32-33.

 **Quit**

Exit the Image Adjust Menu.



Screen Size Adjustment

This projector has the picture screen resize function, which enables you to customize the image size.

- 1 Press the MENU button to display the On-Screen Menu. Use the Point ◀▶ buttons to move the red frame pointer to the Screen Menu icon.
- 2 Use the Point ▲▼ buttons and move the red frame pointer to the desired function and then press the SELECT button.

 **Normal**

Provide the image to fit the screen size with the original aspect ratio of input signal.

 **True**

Provide the image in its original size. When the original image size is larger than the screen size (1024 x 768), the projector automatically switches to the panning mode. Use the Point ▲▼◀▶ buttons to pan the image. When adjusted, the arrows turn red. When reached to the correction limit, the arrows disappear.

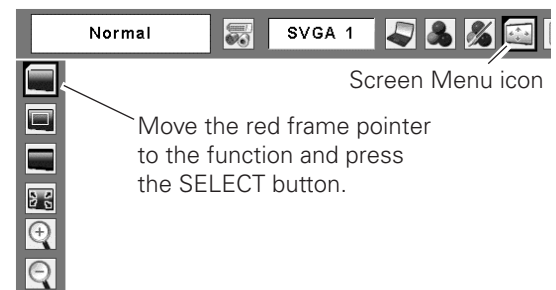
 **Wide**

Provide the image to fit wide video aspect ratio (16:9) by expanding the image width uniformly. This function can be used to provide the squeezed video signal at 16:9.

 **Full**

Provide the full screen image.

Screen Menu



✓ **Note:**

- The Screen Menu, except for "Normal", cannot be operated when 720p, 1035i, or 1080i is selected in the PC System Menu (p.28).
- This projector cannot display any resolution higher than 1600 x 1200. If your computer's resolution is higher than that, lower the resolution before connecting to the projector.
- The image data other than 1024 x 768 is modified to fit the screen size in initial mode.
- True, Full, and Digital zoom +/- cannot be selected when 480i, 575i, 480p, or 575p is selected in the PC System Menu (p.28).

For zooming in and out the images

Digital zoom +

When Digital zoom + is selected, the On-Screen Menu disappears and "D. zoom +" is displayed. Press the SELECT button to expand the image size. Use the Point ▲▼◀▶ buttons to pan the image. The Panning function can work only when the image is larger than the screen size. A projected image can be also expanded by pressing the D.ZOOM ▲ button on the remote control.

Digital zoom -

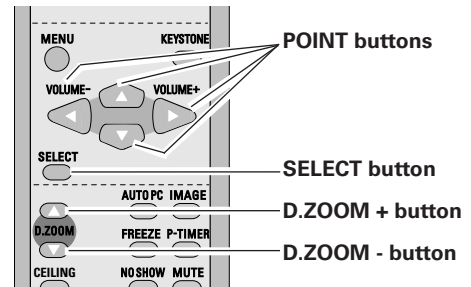
Digital zoom - is used to reduce the image size into its original size when the image size is expanded.

When Digital zoom - is selected, the On-Screen Menu disappears and "D. zoom -" is displayed. Press the SELECT button to compress image size. The projected image can be also compressed by pressing the D.ZOOM ▼ button on the remote control.

To exit the Digital zoom +/- mode, press any button except the D.ZOOM ▲▼, SELECT, and Point buttons.

To return to the previous screen size, select a screen size in the Screen Size Adjustment or select an input source from the Input Source Selection (p.27) again, or adjust the screen size with the D.ZOOM ▲▼ buttons.

Remote Control



✓Note:

- The panning function may not operate properly if the stored Mode in the PC Adjust Menu is used (p.31).
- True, Full, and Digital zoom +/- cannot be selected when 480i, 575i, 480p, or 575p is selected in the PC System Menu (p.28).
- Digital zoom +/- cannot be selected when Full or True is selected.

Video Input

Input Source Selection (Video, S-Video, Component)

Direct Operation

Press the INPUT button on the top control or VIDEO button on the remote control to select "Video."

Before using the INPUT or VIDEO buttons, select the correct input source through menu operation as described below.

Menu Operation

- 1 Use the MENU button to display the On-Screen Menu. Press the Point ◀▶ buttons to move the red frame pointer to the Input Menu icon.
- 2 Use the Point ▲▼ buttons to move the red arrow pointer to Video and then press the SELECT button to display the Source Select Menu .
- 3 Move the pointer to the desired source and then press the SELECT button.

Auto

When selecting "Auto," the projector automatically detects the incoming video signal, and adjusts itself to optimize its performance. The projector selects connection in the following order:

1. Component
2. S-Video
3. Video

Video

When the video input signal is connected to the VIDEO jack, select Video.

S-Video

When the video input signal is connected to the S-VIDEO jack, select S-Video.

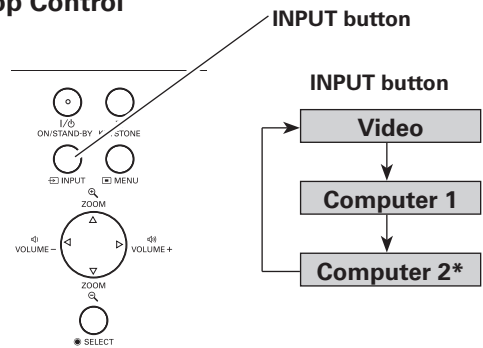
Component

When the input source is coming from video equipment connected to the COMPONENT IN terminal with a Component Cable (not supplied), select Component.

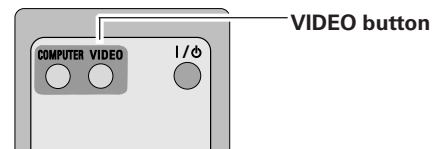
✓Note:

- Computer 2 is not displayed when the COMPUTER IN 2/ MONITOR OUT terminal is set as Monitor out (p.49).
- When the Input Search function is set On1 or On2, the input signal will be searched automatically (p.49)

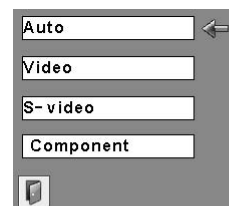
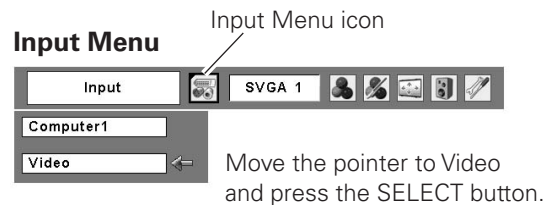
Top Control



Remote Control



Input Menu



Source Select Menu (VIDEO)

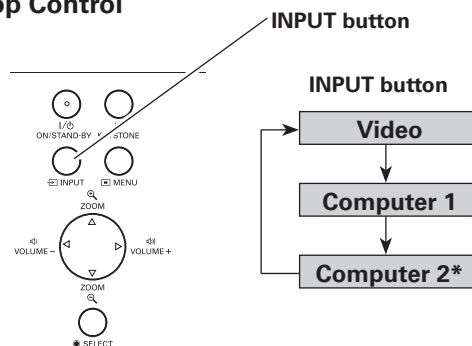
Move the pointer to the desired source and press the SELECT button.

Input Source Selection (RGB Scart 21-pin)

Direct Operation

Press the INPUT button on the top control or COMPUTER button on the remote control to select Computer 1. Before using INPUT or COMPUTER buttons, select the correct input source through Menu operation as described below.

Top Control



Menu Operation

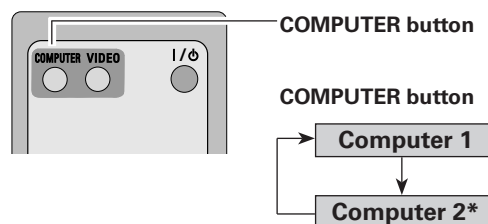
- 1 Use the MENU button to display the On-Screen Menu. Press the Point ◀▶ buttons to move the red frame pointer to the Input Menu icon.
- 2 Use the Point ▲▼ buttons to move the red arrow pointer to Computer 1 and then press the SELECT button.
- 3 After the Source Select Menu appeared for Computer 1, move the pointer to RGB (Scart) and then press the SELECT button.

RGB (Scart) When the input source is coming from video equipment connected to the COMPUTER IN 1 terminal with a Scart-VGA Cable (not supplied), select RGB (Scart).

✓ Note:

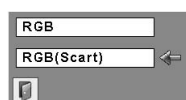
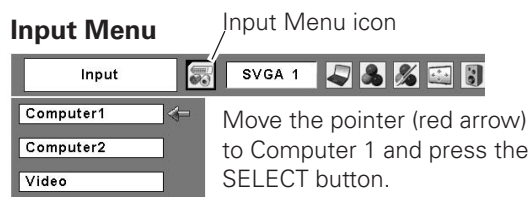
- Computer 2 is not displayed when the COMPUTER IN 2/MONITOR OUT terminal is set as Monitor out (p.49).
- Computer 2 (COMPUTER IN 2/MONITOR OUT) can accept only RGB signal.
- When the Input Search function is set On1 or On2, the input signal will be searched automatically (p.49)

Remote Control



* See Note at the bottom of this page.

Input Menu



Source Select Menu

Move the pointer to RGB (Scart) and press the SELECT button.

Video System Selection

- 1 Press the MENU button to display the On-Screen Menu. Use the Point ◀▶ buttons to move the red frame pointer to the AV System Menu icon.
- 2 Use the Point ▲▼ buttons to move the red arrow pointer to the desired system and then press the SELECT button.

Video or S-Video

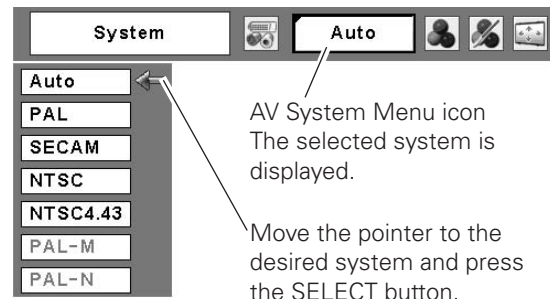
Auto

The projector automatically detects an incoming video system, and adjusts itself to optimize its performance. When Video System is PAL-M or PAL-N, select the system manually.

PAL/SECAM/NTSC/NTSC4.43/PAL-M/PAL-N

If the projector cannot reproduce proper video image, select a specific broadcast signal format from among PAL, SECAM, NTSC, NTSC 4.43, PAL-M, and PAL-N.

AV System Menu (Video or S-Video)



Component

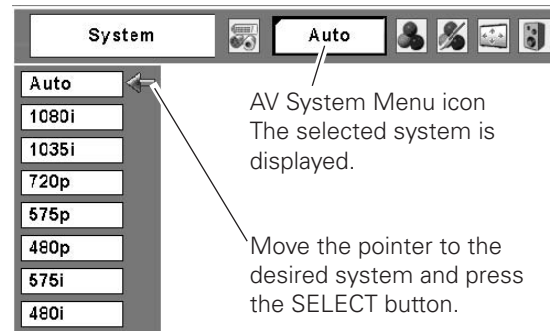
Auto

The projector automatically detects an incoming video signal, and adjusts itself to optimize its performance.

COMPONENT VIDEO SIGNAL FORMAT

If the projector cannot reproduce proper video image, select a specific component video signal format from among 480i, 575i, 480p, 575p, 720p, 1035i, and 1080i.

AV System Menu (Component)



✓ Note:

- The AV System Menu cannot be selected when selecting RGB (Scart).

Image Level Selection

Direct Operation

Select an image level from among Dynamic, Standard, Cinema, Blackboard (Green), Colorboard, Image 1, Image 2, Image 3, and Image 4 with the IMAGE button on the remote control.

Dynamic

For viewing pictures in a bright room.

Standard

Normal picture level preset on this projector.

Cinema

Picture level adjusted for the picture with fine tone.

Blackboard(Green)

For viewing the image projected on a blackboard.
This mode assists to enhance the image projected on a blackboard. This is mainly effective on a green colored board, not truly effective on a black colored board.

Colorboard

At the time of simple projection on the colored wall, you can get the close color image to the color image projected on a white screen by selecting the similar color to the wall color from the preset four colors. See the next page.

Image 1-4

User preset image in the Image Adjust Menu (pp.42-43).

Remote Control

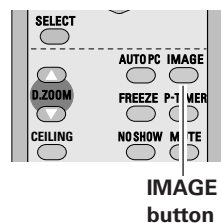
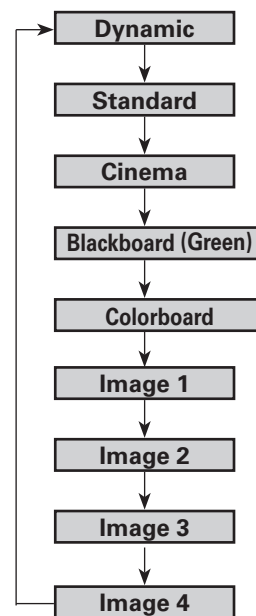


IMAGE button



Menu Operation

- 1 Use the MENU button to display the On-Screen Menu. Press the Point ◀▶ buttons to move the red frame pointer to the Image Select Menu icon.
- 2 Use the Point ▲▼ buttons to move the red frame pointer to the desired level and then press the SELECT button.

Dynamic

For viewing picture in a bright room.

Standard

Normal picture level preset on this projector.

Cinema

Picture level adjusted for the picture with fine tone.

Blackboard (Green)

For viewing the image projected on a blackboard.
This mode assists to enhance the image projected on a blackboard. This is mainly effective on a green colored board, not truly effective on a black colored board.

Colorboard

At the time of simple projection on the colored wall, you can get the close color image to the color image projected on a white screen by selecting the similar color to the wall color from the preset four colors. Press the SELECT button to choose the color.

Image1-4

User preset image in the Image Adjust Menu (pp.42-43).

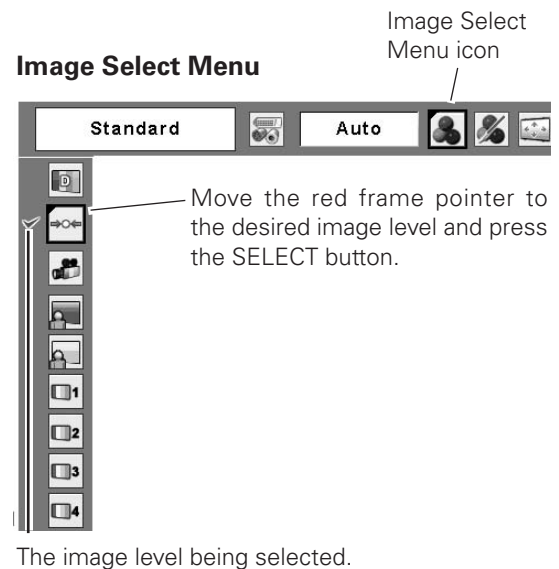


Image Level Adjustment

- 1 Press the MENU button to display the On-Screen Menu. Use the Point ◀▶ buttons to move the red frame pointer to the Image Adjust Menu icon.
- 2 Use the Point ▲▼ buttons to move the red frame pointer to the desired item and then press the SELECT button. The level of each item is displayed. Adjust each level by pressing the Point ◀▶ buttons.

Contrast

Press the Point ◀ button to decrease the contrast; press the Point ▶ button to increase the contrast (from 0 to 63).

Brightness

Press the Point ◀ button to decrease the brightness; press the Point ▶ button to increase the brightness (from 0 to 63).

Color

Press the Point ◀ button to decrease the intensity of the color; press the Point ▶ button to increase the intensity of the color (from 0 to 63).

Tint

Use the Point ◀▶ buttons to adjust the tint value to get a proper color balance (from 0 to 63).

Color temp.

Use the Point ◀▶ buttons to select the desired Color temp. level (XLow, Low, Mid, or High).

White balance (Red)

Press the Point ◀ button to lighten the red tone; press the Point ▶ button to deepen the red tone (from 0 to 63).

White balance (Green)

Press the Point ◀ button to lighten the green tone; press the Point ▶ button to deepen the green tone (from 0 to 63).

White balance (Blue)

Press the Point ◀ button to lighten the blue tone; press the Point ▶ button to deepen the blue tone (from 0 to 63).

✓ Note:

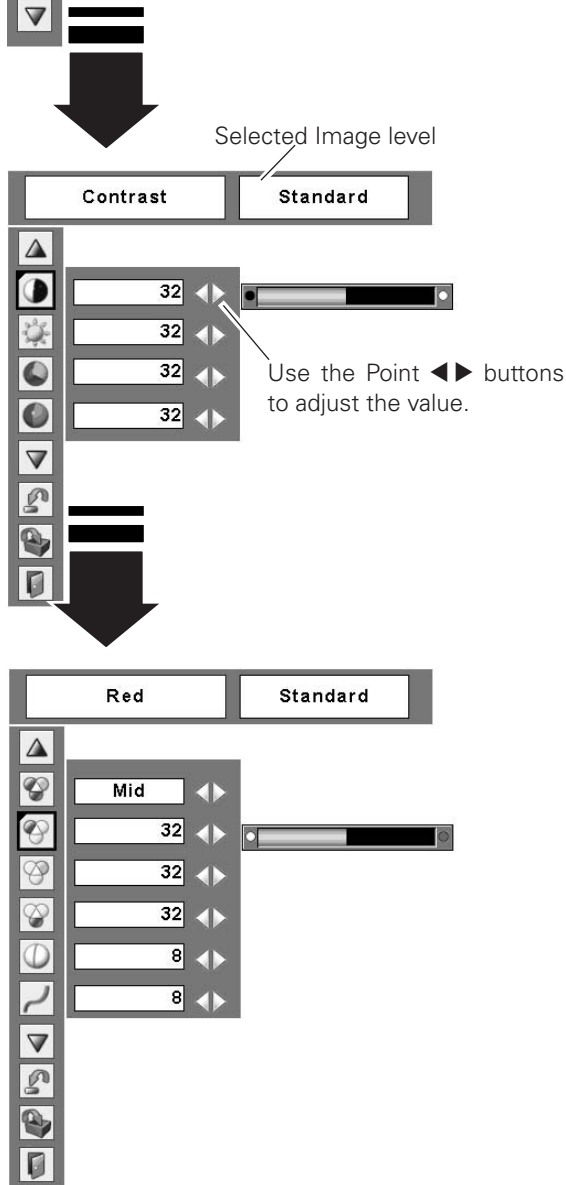
- The Tint cannot be selected when the video system is PAL, SECAM, PAL-M, or PAL-N.
- After adjusting the White balance Red, Green or Blue, the Color temp. level will change to "Adj."

Image Adjust Menu



Image Adjust Menu icon

Move the red frame pointer to the desired item and then press the SELECT button.



Sharpness

Press the Point ◀ button to decrease the sharpness of the image; press the Point ▶ button to increase the sharpness of the image (from 0 to 15).

Gamma

Use the Point ◀▶ buttons to adjust the gamma value to get better balance of contrast (from 0 to 15).

Noise reduction

Noise interference on the screen can be reduced. Select one of the following options to get smoother images.

- Off.....Disabled.
- L1Lower reduction
- L2Higher reduction

Progressive

An interlaced video signal can be displayed in a progressive picture. Select one of the following options.

- Off.....Disabled.
- L1 For an active picture.
- L2 For a still picture.
- Film..... For watching a film. With this function, the projector reproduces pictures faithful to the original film quality.

Reset

To reset the adjusted data, select Reset and press the SELECT button. A confirmation box appears and then select "Yes." All adjustments return to their previous figures.

Store

To store the adjusted data, select Store and press the SELECT button. Select a level from Image 1 to 4 with the Point ▲▼ buttons and press the SELECT button. A confirmation box appears and then select "Yes." Stored data can be called up by selecting "Image" in the Image Level Selection on page 40-41.

Quit

Exit the Image Adjust Menu.

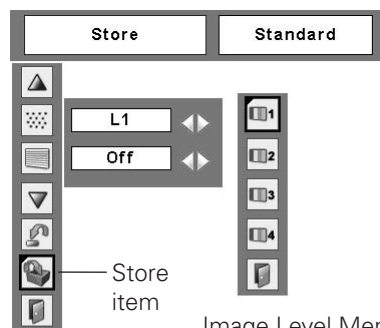


Image Level Menu
Move the red frame pointer to an image item to be set and then press the SELECT button.



A confirmation box appears and then select "Yes."

✓ Note:

- Noise reduction and Progressive cannot be selected when 480p, 575p, 720p, 1035i, or 1080i is selected (p.39).

Screen Size Adjustment

This projector has the picture screen resize function, which enables you to customize the image size.

- 1 Press the MENU button to display the On-Screen Menu. Use the Point ◀▶ buttons to move the red frame pointer to the Screen Menu icon.
- 2 Use the Point ▲▼ buttons and move the red frame pointer to the desired function and then press the SELECT button.

Normal

Provide the image at a normal video aspect ratio of 4:3.

Wide

Provide the image at a wide screen ratio of 16:9.

✓ **Note:**

- Wide is not available when 720p, 1035i, or 1080i is selected in the AV System Menu (p.39).

Screen Menu



Move the red frame pointer to the desired function and press the SELECT button.

Setting

Setting

This projector has Setting menu that allows you to set up the other various functions described as follows:

- 1 Press the MENU button to display the On-Screen Menu. Use the Point ◀▶ buttons to move the red frame pointer to the Setting Menu icon.
- 2 Use the Point ▲▼ buttons to move the red frame pointer to the item that you want to set and then press the SELECT button. The Setting dialog box appears.

Language

The language used in the On-Screen Menu is available in English, German, French, Italian, Spanish, Portuguese, Dutch, Swedish, Finnish, Polish, Hungarian, Romanian, Russian, Chinese, Korean, or Japanese.

Zoom

This function is used to memorize the Zoom adjustment with the ZOOM +/- buttons on the top control. Press the Point ◀▶ buttons to select Store 1, Store 2 or Reset.

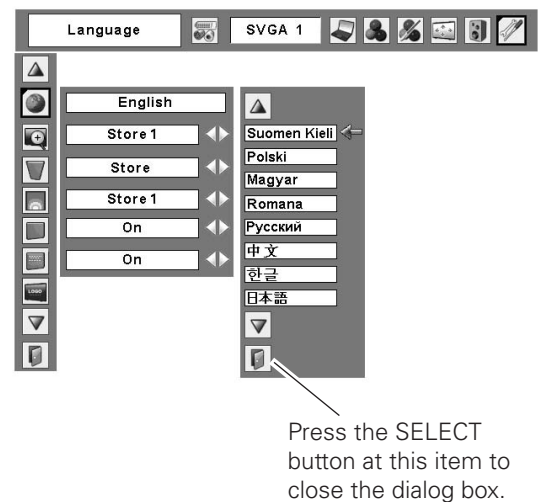
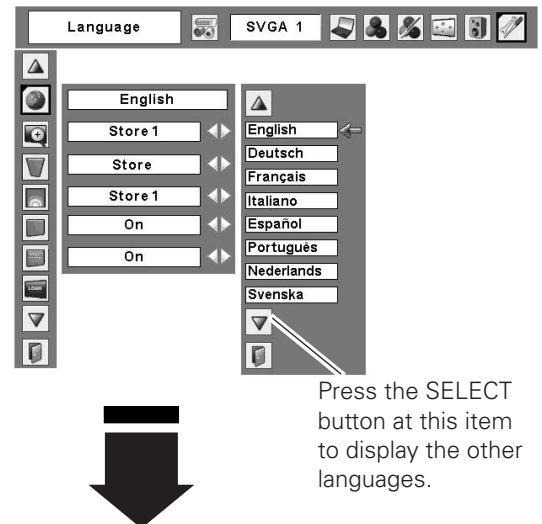
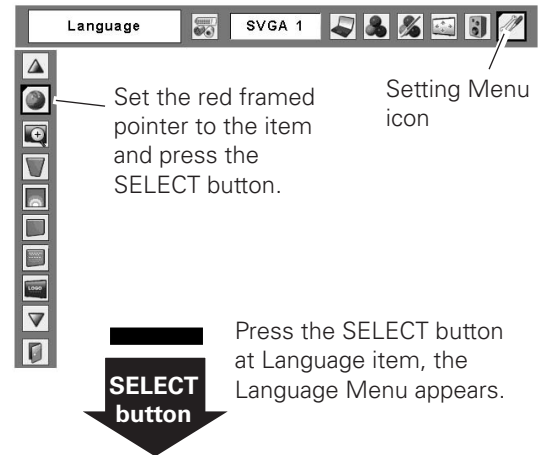
- Store 1.....Store the Zoom setting even when the projector is turned off. Zoom setting is cleared when the AC power cord is unplugged.
- Store 2.....Store the Zoom setting even when the AC power cord is unplugged.
- Reset.....Reset the Zoom adjustment when the projector is turned off or the AC power cord is unplugged.

Keystone

This function corrects distortion of a projected image. Select either Store or Reset with the Point ◀▶ buttons, and then press the SELECT button. Adjust the balance with the Point ▲▼ buttons.

- Store.....Store the keystone correction even when the AC power cord is unplugged.
- Reset.....Reset the keystone correction when the AC power cord is unplugged.

Setting Menu (Language)





Uniformity adj.

This function adjusts the brightness uniformity on a screen. Select either Store 1, Store 2 or Reset with the Point ◀ ▶ buttons, and then press the SELECT button. Press the Point ◀ ▶ buttons to adjust the brightness uniformity (from 0 to 7).

- Store 1.....Store the uniformity adjustment even when the projector is turned off. Reset the uniformity adjustment when the AC power cord is unplugged.
- Store 2.....Store the uniformity adjustment even when the projector is turned off or the AC power cord is unplugged.
- Reset.....Reset the Uniformity adjustment when the projector is turned off or the AC power cord is unplugged.

✓Note:

- Sometimes, the brightness uniformity can not be adjusted under certain conditions. With the adjustment of brightness uniformity, the balance of color or contrast also changes.



Blue back

Press the Point ◀ ▶ buttons to switch on/off. When this function is "On," a blue image is displayed while the input signal is not detected.



Display

Press the Point ◀ ▶ buttons to switch on/off. This function decides to display the On-Screen Displays.

- OnDisplay all the On-Screen Displays. Use this function when you want to project images after the lamp becomes bright enough. This mode is set as a default.
- Countdown off... Display the input image instead of the countdown when turning on the projector. Use this function when you want to project the image as early as possible even when the lamp is not bright enough.
- Off.....Do not show the On-Screen Displays. except:

- On-Screen Menu
- "Power off?"
- P-Timer
- "No signal" for Power management item (p.50)
- "Please wait..."
- Arrows for panning mode (pp.36)



Logo (Logo and Logo PIN code lock settings)

This function allows you to customize the screen logo with Logo select, Capture, and Logo PIN code lock functions.

✓Note:

- When "On" is selected in Logo PIN code lock function, Logo select and Capture functions cannot be selected.



Logo select

This function decides the start-up display as follows:

- User.....The image you captured
- Default.....The factory-set logo
- Off.....Countdown only



Capture

This function enables you to capture the image being projected and use it for a start-up display or interval of presentations.

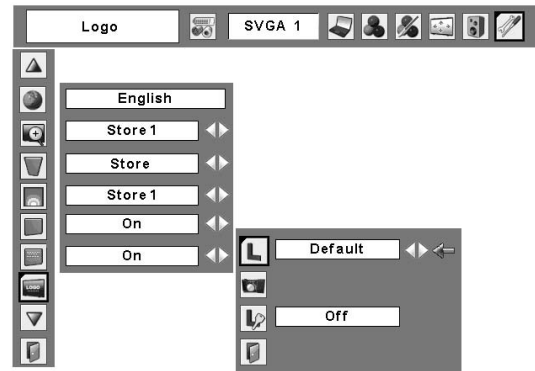
After capturing the projected image, go to the Logo select function and set it to "User." Then the captured image is displayed when the projector is turned on next time or the NO SHOW button is pressed (p 26).

To capture the image, select "Yes." To cancel the Capture function, select "No."

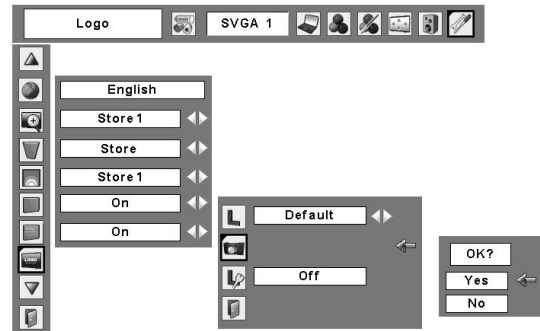
✓Note:

- Before capturing an image, select "Standard" in the Image Select Menu to capture a proper image (pp.32-33, 40-41).
- A signal from a computer can be captured up to XGA(1024x 768). A signal from video equipment can be captured except for 720p, 1035i, and 1080i.
- When you capture the image that has been adjusted by the Keystone function, the adjusted data is automatically reset and the projector captures an image without keystone adjustment.
- When the Logo PIN code lock function is "On," Capture menu cannot be selected.
- When you start to capture a new image, the previously stored image is cleared even if you cancel the capturing.
- User cannot be selected when the image is not captured.

Logo select



Capture



Select "Yes" to capture the projected image.



Select "Yes" to stop capturing.



Logo PIN code lock

This function prevents an unauthorized person from changing the screen logo.

- Off.....the screen logo can be changed freely from the Logo select menu (p.47).
- On.....the screen logo cannot be changed without the Logo PIN code.

If you want to change the Logo PIN code lock setting, enter a Logo PIN code along the following steps. The initial Logo PIN code is set "4321" at the factory.

Enter a Logo PIN code

Select a number by pressing the Point ▲▼ buttons. And then press the Point ► button to fix the number and move the pointer. The number changes to "*". If you fixed an incorrect number, move the pointer to the number you want to correct by pressing the Point ◀ button, and then select the correct number by pressing the Point ▲▼ buttons.

Repeat this step to complete entering a four-digit number.

After entering the four-digit number, move the pointer to "Set" by pressing the Point ► button. Press the SELECT button so that you can change the following Logo PIN code lock settings.

If you entered an incorrect PIN code, "Logo PIN code" and the number (****) turns red. Enter a correct Logo PIN code all over again.

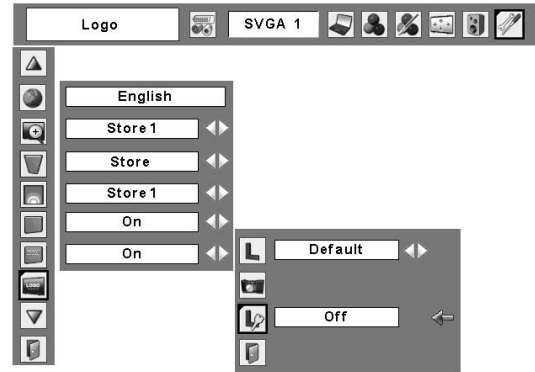
Change the Logo PIN code

Logo PIN code can be changed to your desired four-digit number. Select "Logo PIN code change" with the Point ▼ button and press the SELECT button. Set a new Logo PIN code.

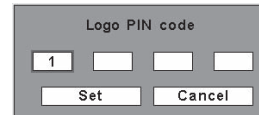
Be sure to note the new Logo PIN code and keep it at hand. If you lost the number, you could no longer change the Logo PIN code setting. For details on PIN code setting, refer to relevant instructions of the PIN code lock function on pages 52-53.

CAUTION:
WHEN YOU HAVE CHANGED THE LOGO PIN CODE, WRITE DOWN THE NEW PIN CODE IN COLUMN OF THE LOGO PIN CODE NO. MEMO ON PAGE 74, AND KEEP IT SECURELY. SHOULD THE LOGO PIN CODE BE LOST OR FORGOTTEN, THE LOGO PIN CODE SETTING CAN NO LONGER BE CHANGED.

Logo PIN code lock



Logo PIN code lock Dialog Box



After a correct Logo PIN code is entered, the following dialog box appears.



Select On/Off by pressing the Point ◀► buttons or change the Logo PIN code.

Ceiling

When this function is set to “On,” the picture is top/bottom and left/right reversed. This function is used to project the image from a ceiling-mounted projector.

Rear

When this function is set to “On,” the picture is left/right reversed. This function is used to project the image to a rear projection screen.

Terminal

The COMPUTER IN 2/MONITOR OUT terminal on the back of the projector is switchable for computer input or monitor output (p.10). Select Computer 2 or Monitor Out with the Point ◀▶ buttons.

Computer 2.....computer input
Monitor Out.....monitor out

Terminal function is not available when Computer 2 to the input source is selected. Change the input source to the others (Computer1 or Video) so that the Terminal function is available (pp.27, 37–38).

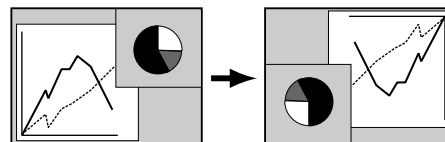
Input search

This function detects the input signal automatically. When finding a signal, the search will stop. Use the Point ◀▶ buttons to select one of the followings.

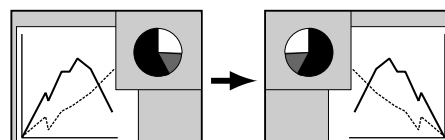
- Off Input search does not work.
- On1 Input search works under the situation below.
 - When the COMPUTER button or VIDEO button on the remote control is pressed.
- On2 Input search works under the situation below.
 - When the projector is turned on with pressing the ON/STAND-BY button on the remote control. (After the countdown)
 - When the COMPUTER button or VIDEO button on the remote control is pressed.
 - When the current input signal is missed. *

* If the No show or Freeze function is active, cancel it to activate the Input search. It is not available when On-Screen menu is displayed.

Ceiling



Rear



✓Note:

- While Input search is set On1 or On2, the status of Input and Lamp are displayed every time the signal is switched.
- Only the input source selected at the last time can be detected.
- If the COMPUTER/VIDEO button on the remote control is pressed while Input search is on, Input search will stop and go back to the previous input sign.



Power management

For reducing power consumption as well as maintaining the lamp life, the Power management function turns off the projection lamp when the input signal is interrupted and no button is pressed for a certain period.

When the input signal is interrupted and no button is pressed for more than 30 seconds, the timer display with "No signal" appears. The countdown starts to turn off the lamp.

Select one of the operations.

- Ready.....When the lamp has been fully cooled down, the POWER indicator changes to green blinking. In this condition, the projection lamp is turned on if the input signal is reconnected or any button on the remote control is pressed.
- Shut down...When the lamp has been fully cooled down, the power is turned off.
- Off..... Power management function is off.

Then set the countdown timer with the Point ◀▶ buttons.

✓ Note:

- Factory default is "Ready: 5 min."



On start

When this function is set to "On," the projector is automatically turned on just by connecting the AC power cord to an outlet.

✓ Note:

- Be sure to turn the projector off properly (see "Turning Off the Projector" on page 21). If the projector is turned off in the incorrect sequence, the On start function does not operate properly.



Lamp control

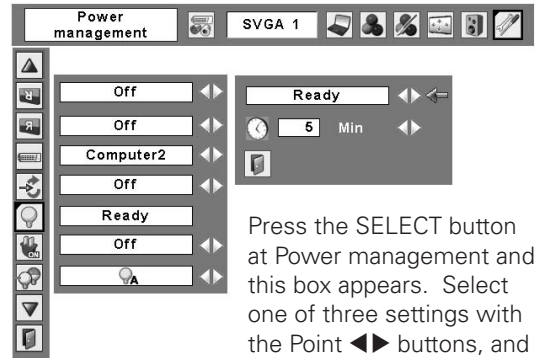
You can change the brightness of the screen.

- ⬤ Normal ... Normal brightness
- ⬤ Auto Brightness according with the input signal
- ⬤ Eco Lower brightness reduces the lamp power consumption and extends the lamp life.

Power management

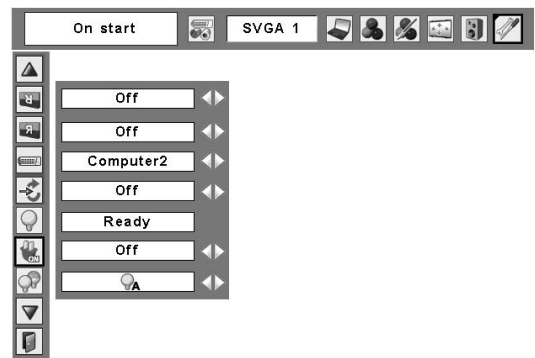


Time left before Lamp is off.



Press the SELECT button at Power management and this box appears. Select one of three settings with the Point ◀▶ buttons, and go to the timer with the Point ▲▼ buttons and set time with the Point ◀▶ buttons.

On start



Remote control

This projector provides two different remote control codes; the factory-set, initial code (Code 1) and the secondary code (Code 2). This switching function prevents remote control interference when several projectors or video equipment are operated at the same time.

When the projector is operated in "Code 2," both the projector and the remote control must be switched to "Code 2."

To change the code for the projector:

Select either "Code 1" or "Code 2" in this Setting Menu.

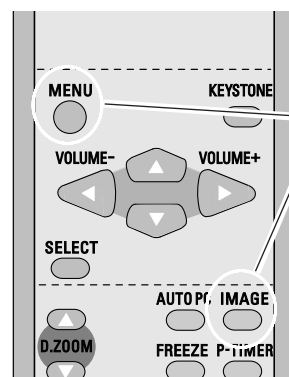
To change the code for the remote control:

Press and hold both the MENU and IMAGE buttons together for more than 5 seconds. After changing the code, make sure the remote control operates properly.

✓ Note:

- When different codes are set on the projector and on the remote control, any operation cannot be made. In that case, switch the code on the remote control to fit the code on the projector.
- If the batteries are removed from the remote control for a long period of time, the remote control code will be reset.

Remote control






Press and hold MENU and IMAGE buttons for more than 5 seconds.

Security (Key lock, PIN code lock, Alarm settings)

This function allows you to use the Key lock, PIN code lock, and Alarm function to set the security for the projector operation.

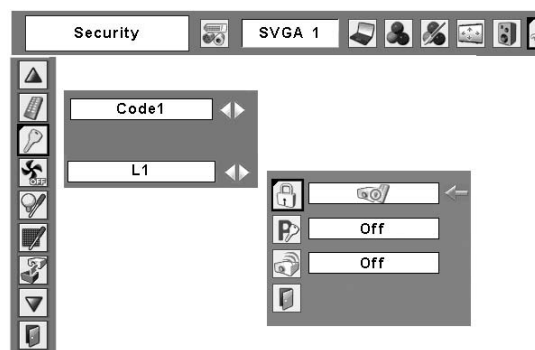
Key lock

This function locks the top control and remote control buttons to prevent operation by unauthorized persons.

-  Unlocked.
-  Lock the operation of the top control. To unlock, use the remote control.
-  lock the operation of the remote control. To unlock, use the top control.

If the top control accidentally becomes locked and you do not have the remote control nearby or there is something wrong with your remote control, contact the dealer where you purchased the projector or the service center.

Key lock



Select Key lock. Use the Point ▲▼ buttons to choose one of the options and select [Yes] to activate it.



PIN code lock

This function prevents the projector from being operated by unauthorized persons and provides the following setting options for security.

- Off..... The projector is not locked with the PIN code.
- On1..... Requires to enter a PIN code every time turning on the projector.
- On2..... Requires to enter a PIN code to operate the projector once the power cord is unplugged; as long as the AC power cord is connected, the projector can be operated without a PIN code.

Whenever you change the PIN code lock setting or the PIN code (a four-digit number), you are required to enter the PIN code. "1234" is set as the initial PIN code at the factory.

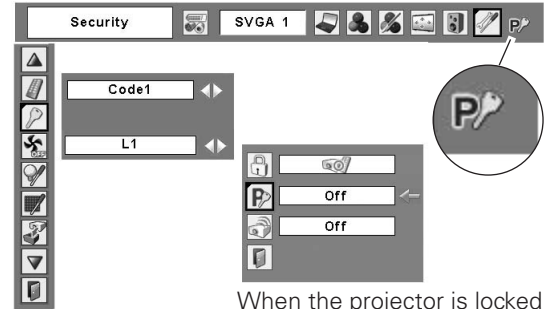
Enter a PIN code

Select a number by pressing the Point ▲▼ buttons. And then press the Point ► button to fix the number and move the pointer. The number changes to "*". If you fixed an incorrect number, move the pointer to the number you want to correct by pressing the Point ◀ button, and then select the correct number by pressing the Point ▲▼ buttons.

Repeat this step to complete entering a four-digit number.

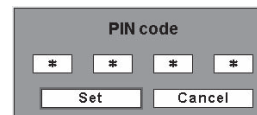
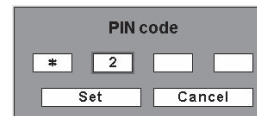
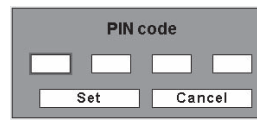
After entering the four-digit number, move the pointer to "Set" by pressing the Point ► button. Press the SELECT button so that you can change the following PIN code lock settings. If you entered an incorrect PIN code, "PIN code" and the number (****) turns red. Enter a correct PIN code all over again.

PIN code lock



When the projector is locked with the PIN code, the PIN code lock symbol appears on the menu bar.

Enter a PIN code



The input numbers change to "*" for security reasons.

Move the pointer to "Set" by pressing the Point ► button. And then press the SELECT button.

Change the PIN code lock setting

Select Off, On1, or On2 with the Point ◀▶ buttons and then move the red frame pointer to "Quit" with the Point ▼ button. Press the SELECT button to close the dialog box.

Change the PIN code

The PIN code can be changed to your desired four-digit number.

Select "PIN code change" with the Point ▼ button, and press the SELECT button to display the New PIN code input dialog box.

Select a number by pressing the Point ▲▼ buttons. And then press the Point ▶ button to fix the number and move the pointer. Repeat it to complete entering a four-digit number. After entering the four-digit number, move the pointer to "Set" by pressing the Point ▶ button. Then press the SELECT button.

CAUTION:
WHEN YOU HAVE CHANGED THE PIN CODE, WRITE DOWN THE NEW PIN CODE IN COLUMN OF THE PIN CODE NO. MEMO ON PAGE 74, AND KEEP IT SECURELY. IF YOU FORGET YOUR PIN CODE, THE PROJECTOR CAN NO LONGER BE STARTED.

Alarm

This function allows you to configure the Alarm operation. See "How to Use the Antitheft Alarm Function" on pages 55-58.

Change the PIN code lock setting

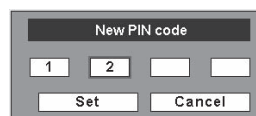


Select a desired setting with the Point ◀▶ buttons.

Change the PIN code



Select PIN code change and press the SELECT button. The New PIN code input dialog box appears.



The input numbers are being displayed for confirmation.



Fan

This function provides the following options in the cooling fans' operation after turning off the projector (p.21).

- L1 Normal operation
- L2 Slower and lower-sound than the normal operation (L1), but it takes longer to cool down the projector.



Lamp counter

This function is used to reset the lamp counter.

When the lamp life is left less than 100 hours, the Lamp replacement icon appears on the screen, indicating that the end of lamp life is approaching.

When the lamp life is counted down to 0 hour, the Lamp replacement icon (Fig.2) will appear on the screen, indicating that the end of lamp life is reached.

When replacing the projection lamp, reset the lamp counter. See "Lamp Replacement Counter" on page 62.

✓ Note:

- The Lamp replacement icon will not appear when the Display function is set to "Off" (p.46), during "Freeze" (p.25), or "No show" (p.26).



Filter counter

This function is used to set a frequency for the filter cleaning.

When the projector reached a specified time between cleanings, a Filter warning icon appears on the screen, notifying the cleaning is necessary. After cleaning the filter, be sure to select RESET and set the timer. The Filter warning icon will not turn off until the filter counter is reset.

For details about resetting the timer, refer to "Resetting the Filter Counter" on page 60.

✓ Note:

- At selecting input source, the icon (Fig.4) will appear.
- The Filter warning icon (Fig.3 and Fig.4) will not appear when the Display function is set to "Off" (p.46), during "Freeze" (p.25), or "No show" (p.26).



Factory default

This function returns all setting values except for the user logo, PIN code lock, Logo PIN code lock, the lamp counter, and the filter counter to the factory default settings.



Quit

Exit the Setting Menu.

Lamp Replacement icon



Fig.1 Lamp replacement icon

This icon appears on the screen when the end of lamp life is approaching.

✓ Note:

- This icon also appears at turning on and selecting input source..

Lamp replacement



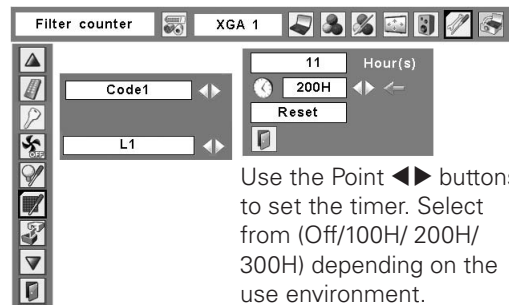
Fig.2 Lamp replacement icon

This icon appears on the screen when the end of lamp life is reached.

✓ Note:

- At turning on, the icon (Fig.2) will appear.
- At selecting input source, the icon (Fig.1) will appear.

Filter counter



Use the Point ◀▶ buttons to set the timer. Select from (Off/100H/ 200H/ 300H) depending on the use environment.

Filter warning



Fig.3 Filter warning icon

Filter warning icon (Fig.3) appears on the screen at a set time.

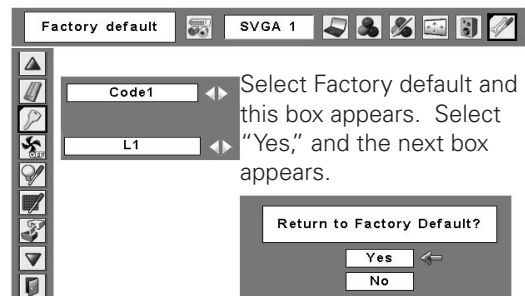
✓ Note:

- The icon (Fig.3) appears at turning on.

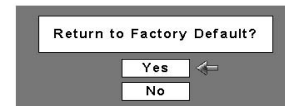


Fig.4 Filter warning icon

Factory default



Select Factory default and this box appears. Select "Yes," and the next box appears.



Select "Yes" to activate it.

Antitheft Alarm Function

How to Use the Antitheft Alarm Function

Antitheft alarm function is provided to prevent the projector from being stolen. When this function is set to "On," the alarm rings as an unauthorized person tries to move the projector.

To activate the Alarm function for the first time after purchase, you must turn on the power once.

✓ Note:

- This function is not a guarantee against stealing.
- The alarm does not ring while the AC power cord is connected to an outlet even if the projector detects vibrations.
- The alarm will stop, as the AC power cord is connected to an outlet, except when the battery cover is open.
- Pressing the buttons is always accompanied by a sound. If no sound is produced after pressing a button, you need to press it again.

The Alarm function is operated by a built-in rechargeable battery. The alarm will not work properly if the battery is not charged enough. See page 57 for details.

Set and release the Antitheft alarm function

The Alarm setting and release and PIN Code change can be made without an AC power connection.

Set the alarm

Press the F button three times to turn the alarm function on. The ALARM indicator blinks for a few seconds and the projector enters the warning mode. (If the battery is not charged enough for the alarm function to operate normally, it beeps and the Alarm indicator will blink red every 20 seconds.)

During the Antitheft alarm function is on, the projector emits a low-pitched sound when it detects vibration.

When the projector does not detect vibration for a few seconds after the sound, it goes back to the warning mode.

When the projector detects more vibrations after the low-pitched sound, the alarm starts ringing.

The Alarm operating configuration (Battery charge, Alarm volume, Sensitivity, and Ringing time) can be selected in the menu. See page 56.

✓ Note:

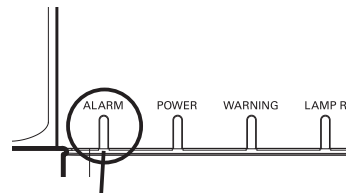
- You can test the alarm sound without setting the alarm function. Press and hold the F button, then the alarm starts ringing. The duration of the alarm sound is the same as the "Ringing Time" setting (p.56).
- If you want to stop the alarm while it is ringing, insert the AC power cord to an outlet or press the F button and enter the four-digit PIN code number.

Release the alarm setting

Press the F button and enter the four-digit PIN code number within about 10 seconds. (The default PIN code is set to "1111.") When the alarm is released, you will hear a high-pitched confirmation sound.

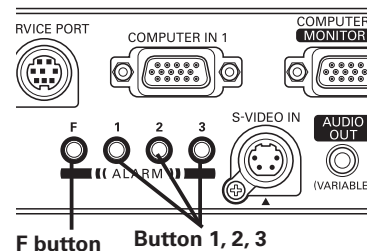
When you enter an incorrect PIN code, you will hear a low-pitched sound. If you enter an incorrect PIN code three times in a row, the alarm will start ringing.

Indicator



ALARM indicator

Terminal



Antitheft Alarm Function

Other settings

Change the PIN code

- 1 Press the F button and enter the four-digit PIN code number within about 10 seconds. The ALARM indicator blinks red for a few seconds and a high-pitched confirmation sound is produced.
- 2 While the indicator is blinking, enter a new PIN code, then you will hear a high-pitched confirmation sound and the ALARM indicator is turned off.

When you enter an incorrect PIN code, you will hear a low-pitched sound. If you enter incorrect PIN code three times in a row, the alarm will start ringing.

The PIN code for the Antitheft alarm function is a combination of 1, 2, or 3. Use the buttons 1, 2, and 3 to enter the PIN code. The default PIN code is "1111."

Reset the settings

Select "Factory default" in the Setting menu to reset the settings for the Antitheft alarm function.

✓ Note:

- This is effective only when the Antitheft alarm setting is released.

Alarm operating configuration

The Alarm operating configuration can be changed when the Antitheft alarm function is set to "Off." See page 55 for setting or releasing this function.

Press the SELECT button at Alarm icon in the Setting Menu to display the Alarm setting dialog box. Use the Point ▲▼ buttons to select the desired option; use the Point ◀▶ buttons to set the selected option.

Battery charge

See the next page for details.

Alarm volume

Small, Medium, Large (default)

Sensitivity

- Low..... Less sensitive
- Medium Normal sensitivity
- High Highly sensitive (default)

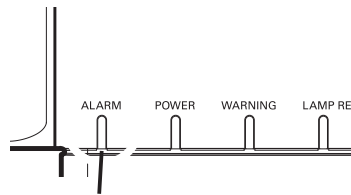
Ringing time

- 10 seconds Rings about 10 seconds (default).
- 60 seconds Rings about 60 seconds.
- Long time Rings until the end of the battery life.

CAUTION:

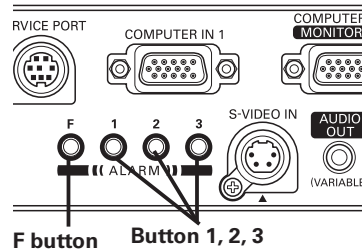
WHEN YOU HAVE CHANGED THE PIN CODE, WRITE DOWN THE NEW PIN CODE IN COLUMN OF THE PIN CODE NO. MEMO ON PAGE 74, AND KEEP IT SECURELY. IF YOU FORGET YOUR PIN CODE, SOME SETTINGS OF THE ANTITHEFT ALARM FUNCTION CAN NO LONGER BE CHANGED.

Indicator

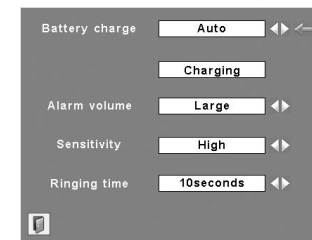
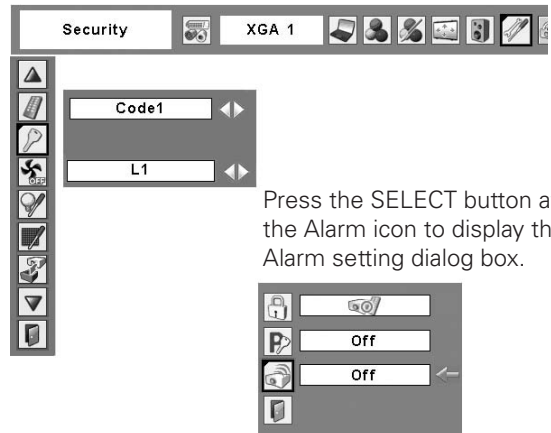


ALARM indicator

Terminal



Alarm



Use the Point ◀▶ buttons to set the selected option.

✓ Note:

- The Alarm icon appears dimmed and can be unavailable when the Antitheft alarm function is set to "On" or if the battery is not installed, discharged, or coming to the end of its life.
- While the Alarm icon is selected, the Antitheft alarm setting buttons can be unavailable.
- When selecting "Long time" option in the Ringing time, the duration of alarm sounding differs depending on the battery life.

Charge the built-in batteries

Set the Battery charge option in the Alarm setting menu to "Auto." The default setting is "Auto."

As long as the AC power cord is connected and this option is set to "Auto," the built-in battery for Alarm function is being charged at all times. While charging the battery, "Charging" is displayed in the menu.

The "Charging" appears dimmed when the battery is fully charged or the Battery charge option is set to "Off," or if charging malfunction occurs. Set the option to "Off" when not using the Alarm function. This can save the power and battery life.

Replace the rechargeable batteries

Use only the specified battery for this projector. Using other types of battery may cause accident or fire hazard.

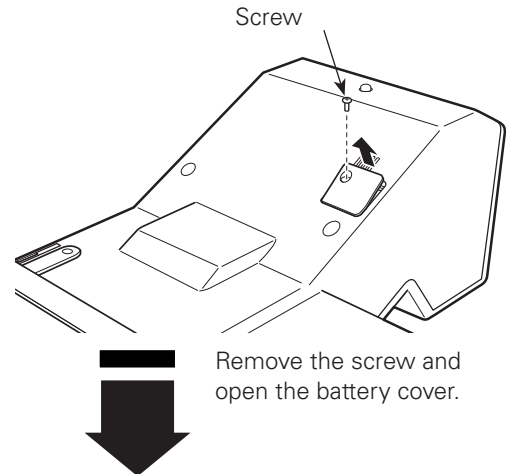
Replacement Battery: SANYO Ni-MH BATTERY PACK
Part No. 645 089 8587

How to replace the rechargeable batteries

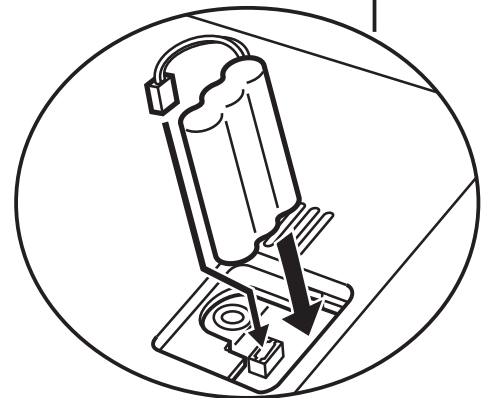
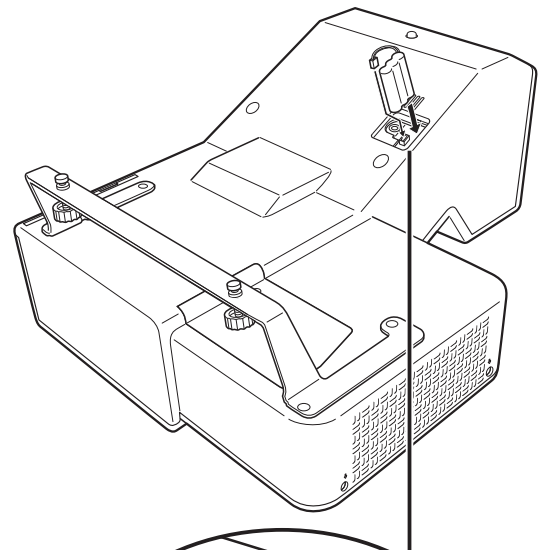
- 1 Unplug the AC power cord from a wall outlet.
- 2 Set the Alarm function to "Off" (see page 55). If it is not released, the alarm will start ringing when you try to remove the rechargeable battery cover.
- 3 Remove the screw from the rechargeable battery cover and open the cover.
- 4 Pull out the battery connector and remove the battery.
- 5 Install new battery and plug the connector into the socket.
Note: The battery connector has polarity. Observe battery polarity when installing.
- 6 Put back the battery cover and secure it with the screw.
Caution: Tighten the screw securely. If you fail to do so, the alarm will not operate. Do not use any other screws. This may cause damage to the projector.

✓ Note:

- The PIN code and settings you have changed are effective even after the battery is changed.
- When replacing the rechargeable batteries, protect the infrared remote receiver with a soft cloth to avoid damaging it.
- Unplug the battery connector if you carry your projector frequently and use the carrying case. If you do not unplug the battery connector, the alarm may be triggered when the Alarm buttons are accidentally pressed inside the carrying case..



Remove the screw and open the battery cover.



Install the battery, then put back the battery cover and secure it with the screw.



SAFETY PRECAUTIONS FOR SANYO Ni-MH BATTERY PACK

Observe the following precautions when handling the built-in battery pack of the projector:

- MAKE SURE THAT THE BATTERY PACK IS INSTALLED IN THE PROJECTOR WHEN RECHARGING. USING THE CHARGERS OTHER THAN THE PROJECTOR MAY CAUSE EXPLOSION OR A FIRE.
- The rechargeable battery pack is for use exclusively with this projector. Do not use in other products or this may cause accident.
- Do not throw the battery into fire or heat it. Doing so may cause an explosion or fire.
- Never attempt to disassemble, modify, reconstruct, or solder lead wires directly on to the battery.
- Do not drop or subject to strong forces. Doing so may cause the battery to leak fluid or explode.
- Do not expose to direct sunlight or high temperatures. This may degrade battery performance or cause leakage.
- Avoid contact with water or liquid. Exposure to water or liquid could result in battery corrosion or damage.
- Keep out of reach of children. They may accidentally swallow the battery.
- Do not short-circuit battery terminals with metal objects. Do not store with metal objects or in a metal case.
- The rechargeable battery pack has a limited number of charge cycles and eventually need to be replaced. If it can no longer be recharged, stop charging immediately and replace it with new one.
- Recharge the battery in a place where the temperature is always between **32°F to 104°F (0°C to 40°C)**. Charging in the temperature out of this range may result in fluid leak, heat generation, or shortening battery life.
- If you do not use the projector or the Antitheft alarm function for a long period of time, remove the battery from the projector and store it in a place where the temperature is always between **-4°F to 86°F (-20°C to 30°C)**.
- If a battery leaks and fluid comes in contact with skin, this may cause skin irritation. Flush the affected area thoroughly with water.
- If a battery leaks and fluid gets in contact with eyes, wash your eyes with water immediately and seek medical attention.
- Dispose of used batteries according to your local disposal rule and guidelines.



Maintenance and Cleaning

Warning Indicator

The WARNING indicator shows the state of the function which protects the projector. Check the state of the WARNING indicator and the POWER indicator to take proper maintenance.

The projector is shut down and the WARNING indicator is blinking red.

When the temperature inside the projector reaches a certain level, the projector is automatically shut down to avoid overheating. The POWER indicator is blinking while the projector is being cooled down. When the projector has cooled down enough (to its normal operating temperature), it can be turned on again by pressing the ON/STAND-BY button.

✓ **Note:**

- The WARNING indicator continues to blink even after the temperature inside the projector returns to normal. When the projector is turned on again, the WARNING indicator stops blinking.

Then check the matters below:

- Did you provide appropriate space for the projector to be ventilated? Check the installing condition to see if ventilation slots are not blocked.
- Has the projector been installed near an Air-Conditioning/ Heating Duct or Vent? Move the installation of the projector away from the duct or vent.
- Are the air filters clean? Clean the air filters periodically. (p.60)

The projector is shut down and the WARNING indicator lights red.

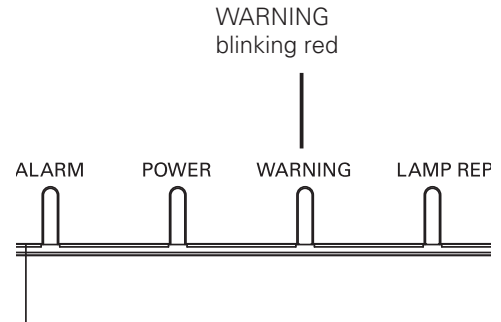
When the projector detects an abnormal condition, it is automatically shut down to protect the inside of the projector and the WARNING indicator lights red. In this case, unplug the AC power cord and plug it, and then turn on the projector once again to verify operation. If the projector cannot be turned on and the WARNING indicator lights red, unplug the AC power cord and contact the service station.



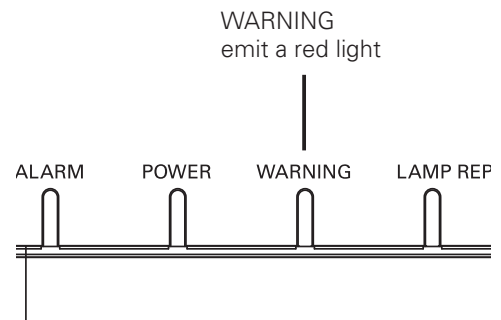
CAUTION

DO NOT LEAVE THE PROJECTOR WITH THE AC POWER CORD CONNECTED UNDER AN ABNORMAL CONDITION. IT MAY RESULT IN FIRE OR ELECTRIC SHOCK.

Indicators



Indicators



Cleaning the Air Filter

The air filter prevents dust from accumulating on the surface of the optical elements inside the projector. Should the air filter become clogged with dust particles, it will reduce cooling fans' effectiveness and may result in a buildup of internal heat and adversely affects the life of the projector. Clean the air filter by following the steps below.

- 1 Turn off the projector, and unplug the AC power cord from the AC outlet.
- 2 Turn over the projector and remove the air filter by pulling the latches upward.
- 3 Clean up the dust on the projector and around the air vents.
- 4 Gently clean the filter by using a brush or blower.

WARNING: Do not wash the filter with water and any other liquid matter. Otherwise the filter may be damaged.

- 5 Reinstall the filter into the projector properly.
- 6 Reset the filter counter in the Setting Menu. See "Resetting the Filter Counter" below.



CAUTION

Do not operate the projector with the air filter removed. Dust may accumulate on the optical elements degrading picture quality. Do not put anything into the air intake vents. Otherwise it may result in malfunction of the projector.

RECOMMENDATION

We recommend avoiding dusty/smoky environments when you operate the projector. Usage in these environments may cause poor image quality.

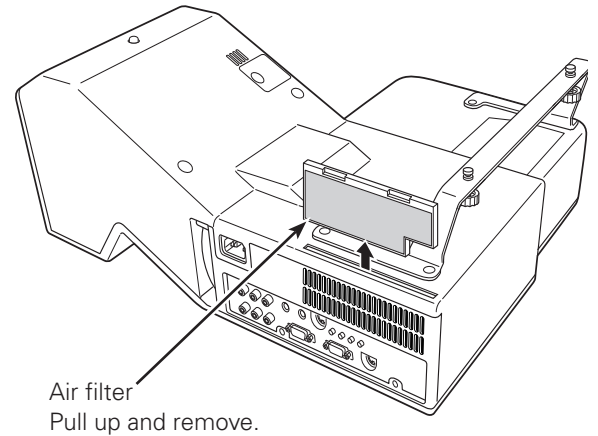
When you use the projector under dusty or smoky conditions, dust may accumulate on the lens, LCD panels, or optical elements inside the projector degrading the quality of a projected image.

When the symptoms above are noticed, contact your authorized dealer or service station for proper cleaning.

Resetting the Filter Counter

Be sure to reset the Filter counter after cleaning or replacing the filter.

- 1 Press the MENU button to display the On-Screen Menu. Use the Point ◀▶ buttons to move the red frame pointer to the Setting Menu icon.
- 2 Use the Point ▲▼ buttons to move the red frame pointer to Filter counter and then press the SELECT button. A dialog box appears showing the total accumulated time of the filter use, a timer setting option, and the reset option. Select Reset and the "Filter counter Reset?" appears. Select [Yes] to continue.
- 3 Another confirmation dialog box appears, select [Yes] to reset the Filter counter.

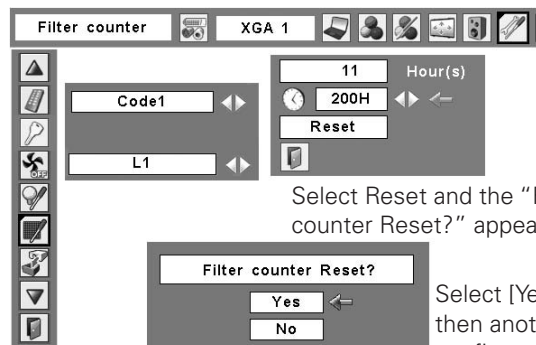


✓Note:

- When cleaning the air filter, protect the infrared remote receiver with a soft cloth to avoid damaging it.
- If the filter is heavily clogged and unable to clean, replace it with a new one. Consult your dealer for details.

Replacement Filter Part No.: 610 335 4057

Filter counter



Select Reset and the "Filter counter Reset?" appears.

Select [Yes], then another confirmation box appears.

Select [Yes] again to reset the Filter counter.

Cleaning the Projection Window



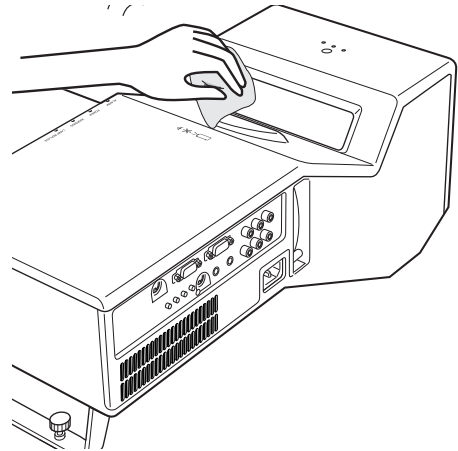
This projector is equipped with a projection window.

Do not rub the projection window with a hard fiber cloth or hit it with something hard to prevent the projection window from scratching. Do not use a chemical cleaner (liquid and solid) to avoid deteriorating the projection window.

Unplug the AC power cord before cleaning.

First, remove the dust with a blower. Then gently wipe the projection window surface. Use a cleaning paper moistened with methyl alcohol (methanol). Avoid excessive use of cleaner.

Do not use abrasive cleaners, solvents, or other harsh chemical cleaners to avoid damaging the projection window.



Cleaning the Projector Cabinet

Unplug the AC power cord before cleaning.

Gently wipe the projector body with a soft dry cleaning cloth. When it is heavily soiled, use a small amount of mild detergent and finish with the cleaning cloth. Avoid excessive use of cleaner. Abrasive cleaners, solvents, or other harsh chemicals might scratch the surface of the cabinet.

When the projector is not in use, put the projector in an appropriate case to avoid dust and being scratched.

Lamp Replacement

When the projection lamp of the projector reaches its end of life, the Lamp replacement icon appears on the screen and LAMP REPLACE indicator lights yellow. Replace the lamp with a new one promptly. The timing when the LAMP REPLACE indicator should light is depending on the lamp mode.

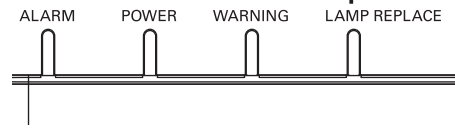


✓ **Note:**

- The Lamp replacement icon will not appear when the Display function is set to "Off" (p.46), during "Freeze" (p.25), or "No show" (p.26).

Indicators

LAMP REPLACE indicator



Lamp replacement



Lamp replacement icon



CAUTION

Allow a projector to cool for at least 45 minutes before you open the Lamp cover. The inside of the projector can become very hot.



CAUTION

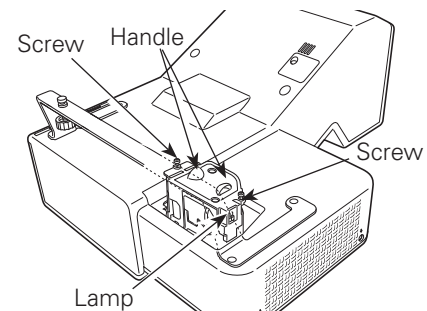
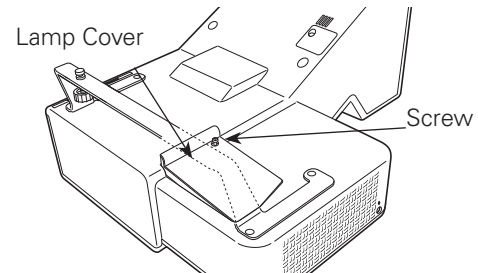
For continued safety, replace with a lamp of the same type. Do not drop a lamp or touch a glass bulb! The glass can shatter and may cause injury.

Follow these steps to replace the lamp.

- 1** Turn off the projector and unplug the AC power cord. Let the projector cool for at least 45 minutes.
- 2** Remove the screw from the lamp cover and open the cover.
- 3** Loosen the two (2) screws that secure the lamp. Lift the lamp out of the projector by using the handle.
- 4** Replace the lamp with a new one and secure the two (2) screws. Make sure that the lamp is set properly. Close the lamp cover and secure the screw.
- 5** Connect the AC power cord to the projector and turn on the projector.
- 6** **Reset the lamp counter.**
See "Lamp Replacement Counter" on the next page.

✓ **Note:**

- When replacing the projection lamp, protect the infrared remote receiver with a soft cloth to avoid damaging it.



ORDER REPLACEMENT LAMP

Replacement lamp can be ordered through your dealer. When ordering a projection lamp, give the following information to the dealer.

- **Model No. of your projector** : **PLC-XL50**
- **Replacement Lamp Type No.** : **POA-LMP121**
(Service Parts No. 610 337 9937)

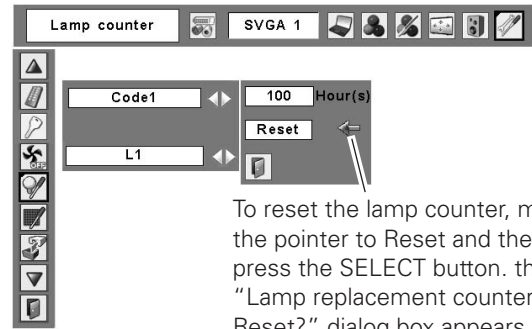
Lamp Replacement Counter

Be sure to reset the Lamp replacement counter after the lamp is replaced. When the Lamp replacement counter is reset, the LAMP REPLACE indicator stops lighting.

- 1 Turn the projector on and press the MENU button to display the On-Screen Menu. Use the Point ◀▶ buttons to move the red frame pointer to the Setting Menu icon.
- 2 Use the Point ▲▼ buttons to move the red frame pointer to Lamp counter and then press the SELECT button. The first dialog box appears showing the total accumulated lamp time and reset option. If you select Reset, "Lamp replacement counter Reset?" appears. Select "Yes" to continue.
- 3 Another confirmation dialog box appears, and select "Yes" to reset the Lamp replacement counter.

✓Note:

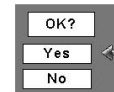
- Do not reset the Lamp replacement counter without implementing lamp replacement. Be sure to reset the Lamp replacement counter only after replacing the lamp.



To reset the lamp counter, move the pointer to Reset and then press the SELECT button. the "Lamp replacement counter Reset?" dialog box appears.



Select "Yes," then another confirmation box appears.



Select "Yes" again to reset the lamp counter.



LAMP HANDLING PRECAUTIONS

This projector uses a high-pressure lamp which must be handled carefully and properly. Improper handling may result in accidents, injury, or create a fire hazard.

- Lamp life may differ from lamp to lamp and according to the environment of use. There is no guarantee of the same life for each lamp. Some lamps may fail or terminate their life in a shorter period of time than other similar lamps.
- If the projector indicates that the lamp should be replaced, i.e., if the LAMP REPLACE indicator lights up, replace the lamp with a new one IMMEDIATELY after the projector has cooled down. (Follow carefully the instructions in the Lamp Replacement section of this manual.) Continuous use of the lamp with the LAMP REPLACE indicator lighted may increase the risk of lamp explosion.
- A Lamp may explode as a result of vibration, shock, or degradation as a result of hours of use, as it comes to the end of life. Risk of explosion may differ according to the environment or conditions in which the projector and lamp are being used.

IF A LAMP EXPLODES, THE FOLLOWING SAFETY PRECAUTIONS SHOULD BE TAKEN.

If a lamp explodes, disconnect the projector's AC plug from the AC outlet immediately. Contact an authorized service station for a checkup of the unit and replacement of the lamp. Additionally, check carefully to ensure that there are no broken shards or pieces of glass around the projector or coming out from the cooling air circulation holes. Any broken shards found should be cleaned up carefully. No one should check the inside of the projector except those who are authorized trained technicians and who are familiar with projector service. Inappropriate attempts to service the unit by anyone, especially those who are not appropriately trained to do so, may result in an accident or injury caused by pieces of broken glass.

Troubleshooting

Before calling your dealer or service center for assistance, check the items below once again.

- Make sure you have properly connected the projector to peripheral equipment as described on pages 16-18.
- Make sure all equipment is connected to the AC outlet and the power is turned on.
- When you operate the projector with a computer and it does not project an image, restart the computer.

Problem:

– Solutions

No power

- Plug the power cord of the projector into the AC outlet.
- See if the POWER indicator lights red.
- Wait until the POWER indicator stops blinking to turn on the projector again. The projector can be turned on after the POWER indicator turns red. (see page 21).
- Check the WARNING indicator. If the WARNING indicator lights red, the projector cannot be turned on (see on page 59).
- Check the projection lamp (see page 62).
- Check if the projector is installed in proper position. (See page 7)
- Unlock the Key lock function for the projector. See page 51.

PIN code dialog box appears at start-up.

- PIN code lock is being set. Enter a PIN code; the “1234” or numbers you have set (see pages 20, 52-53)

The initial display is not shown.

- Make sure “Off ” or “Countdown Off” are not chosen at Display function. (See “SETTING” section on page 46)

The initial display is not same with the default one.

- Make sure “User” or “Off” are not chosen at Logo select function. (See “SETTING” section on page 47)

Input signal switches automatically. (or does not switch automatically)

- Make sure Input search function is adjusted properly. See page 49.

When the projector is on and you press the input button, an icon other than the Lamp mode icon appears.

- That is the Filter warning icon. Refer to page 54.

An icon other than Input mode or Lamp mode icon appears.

- That is the Lamp replacement icon or the Filter warning icon. See page 54.

No image

- Check the connection between your computer or video equipment and the projector (see pages 16-18).
 - See if the input signal is correctly output from your computer. Some laptop computers may need to be changed the setting for monitor output when connected to the projector. See your computer’s instruction manual for the setting.
 - It takes about 30 seconds to display an image after turning on the projector.
 - See if the selected system is corresponding with your computer or video equipment (see pages 28, 39).
 - Select correct input source once again through menu operation (see pages 27, 37–38).
 - Make sure the temperature is not out of the specified operating temperature (41 °F–95 °F [5 °C–35 °C]).
 - When “No Show is operating, the image can not be displayed. Press the NO SHOW button or any other button on the remote control.
-

Image is out of focus.	<ul style="list-style-type: none"> - Adjust focus of the projector (see page 24). - Provide proper distance between the projector and the projection screen (see page 14). - Check the projection window to see if it needs cleaning (see page 61). - Moving the projector from a cool to warm place may result in moisture condensation on the projection lens. If this occurs, leave the projector off and wait until condensation evaporates. - Projecting from excessive slant angle to the screen may cause keystone distortion and partial imperfect focus.
Picture is not bright enough.	<ul style="list-style-type: none"> - Check if "Contrast" or "Brightness" are adjusted properly. (See page 34, 42) - Check if "Image level" is selected properly. (See pages 32-33, 40-41) - Check the Lamp control function. (See "SETTING" section on page 50) - Check the Lamp replace indicator. If it lights, the end of lamp life is approaching. Replace the lamp with a new one promptly. (See page 62)
The color is strange.	<ul style="list-style-type: none"> - Check the Input signal, color system, video system, or computer system mode. - Adjust the Image Level properly. See pages 32-33, 40-41.
Image is Left/Right reversed. Image is Top/Bottom reversed	<ul style="list-style-type: none"> - Check the Ceiling/Rear function (see page 49). - Check the Ceiling function (see page 49).
The image is distorted or runs off.	<ul style="list-style-type: none"> - Check "PC Adjustment" menu or " Screen" menu and adjust them.
No sound	<ul style="list-style-type: none"> - Check the audio cable connection from audio input source. - Adjust the audio source. - Press the Volume + button (see page 25). - Press the Mute button (see page 25). - Is the image projected? You will hear the sound only when the image is projected. - When the AUDIO OUT is plugged in, the projector's built-in speaker is not available.
Auto PC adjustment function does not work.	<ul style="list-style-type: none"> - Check the Input signal. Auto PC Adjustment function can not work when 480p, 575p, 720p, 480i, 575i, 1035i, or 1080i is selected. (See page 29)
Some displays are not seen during the operation.	<ul style="list-style-type: none"> - Check the Display function (see page 46).
The setting does not remain after turning off power.	<ul style="list-style-type: none"> - Make sure you selected "Store" after adjusting settings. Some settings can not be stored if not registered with "Store"
Power management function does not work.	<ul style="list-style-type: none"> - Power management function can not work while "Freeze" or "No Show" function is running.
Image disappears automatically.	<ul style="list-style-type: none"> - Check the power management function in the Setting. The power management is set to "On" at the factory.
Capture function does not work.	<ul style="list-style-type: none"> - Check the connection and input signal to see if there is signal.

The Remote Control does not work.

- Check the batteries.
- Make sure no obstruction is between the projector and the remote control.
- Make sure you are not too far from the projector when using the remote control. Maximum operating range is 11.5' (3.5 m).
- Make sure the code of the remote control is conformed to that of the projector (see page 51).
- Unlock the Key lock function for the remote control. See page 51.

Indicators blinks or lights.

- Check the status of the projector with referring to " INDICATORS AND PROJECTOR CONDITION" on page 69.
- For Alarm indicator, see pages 55-56.

Alarm does not stop ringing.

- Connect the AC power cord to the AC outlet. (Alarm will not stop ringing when the alarm goes off while trying to remove the rechargeable battery cover.) See page 53-55.

Warning mode is not turned on.

- If you cannot hear the bleeping sound when you press the Alarm buttons, you are not pressing the buttons correctly. Try to set the Alarm setting again. See page 55.

Computer 2 cannot be selected.

- Select Computer 2 in the Terminal function (see page 49).

The Terminal function cannot be selected.

- The Terminal function cannot be selected after Computer 2 is selected. Select other input source such as Computer 1 or Video with the COMPUTER button or the VIDEO button on the remote control so that the Terminal function can be selected.



appears on the screen

- Your operation is invalid. Operate correctly.

Unable to unlock the Logo PIN code lock, Security key lock or Security PIN code lock.

- Contact the dealer where you purchased the projector or the service center.

WARNING :

High voltages are used to operate this projector. Do not attempt to open the cabinet.

If problems still persist after following all operating instructions, contact the dealer where you purchased the projector or the service center. Specify the model number and explain about the problem. We will advise you how to obtain service.



The CE Mark is a Directive conformity mark of the European Community (EC).



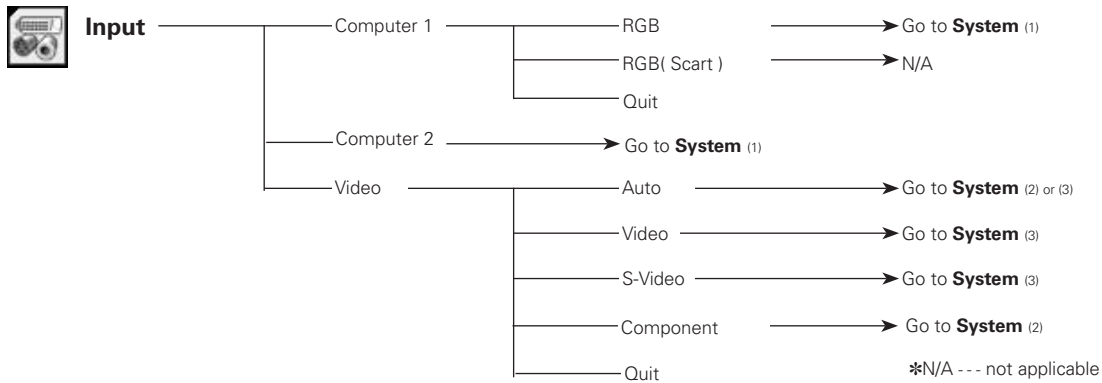
This symbol on the nameplate means the product is Listed by Underwriters Laboratories Inc. It is designed and manufactured to meet rigid U.L. safety standards against risk of fire, casualty and electrical hazards.



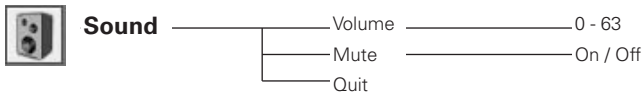
Pixelworks ICs used.

Menu Tree

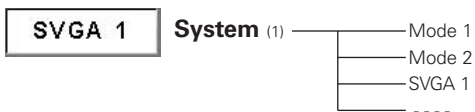
Computer Input/Video Input



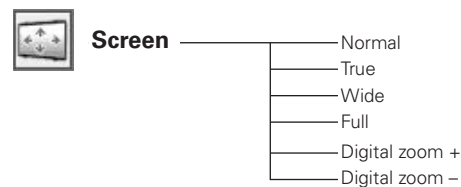
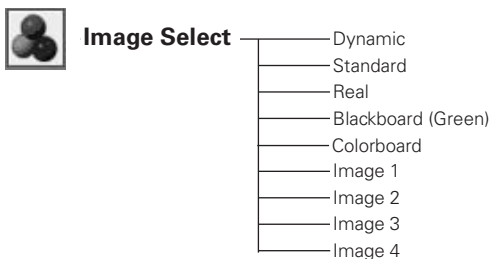
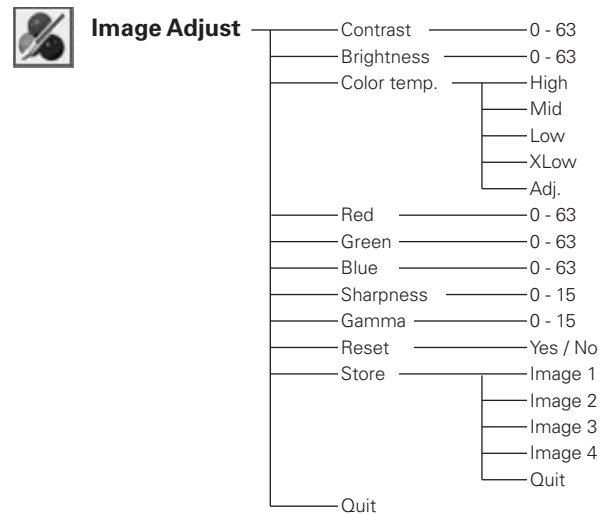
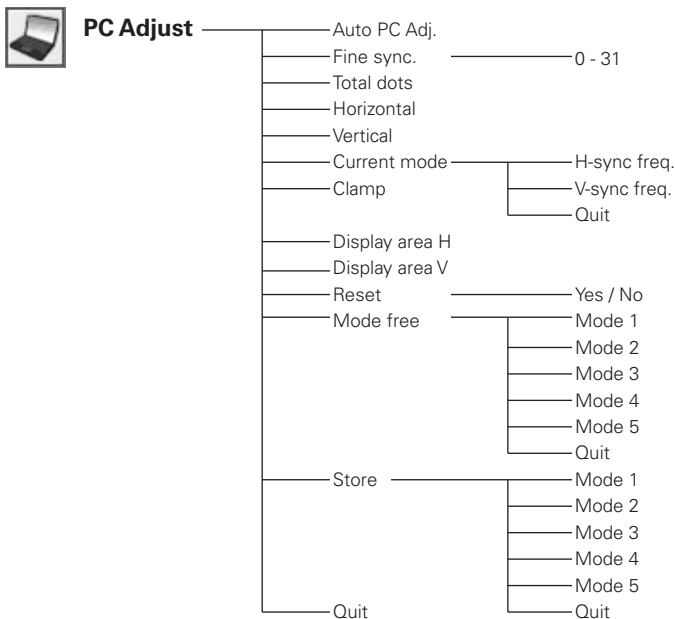
Sound



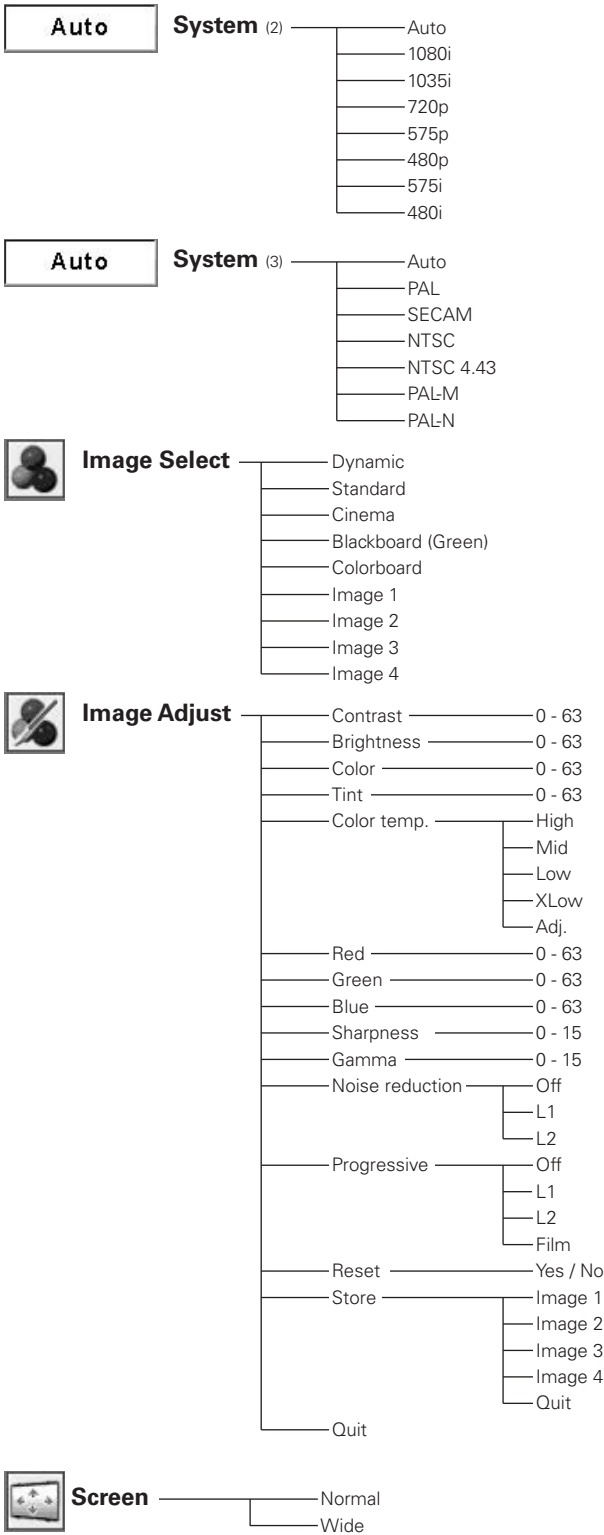
Computer Input



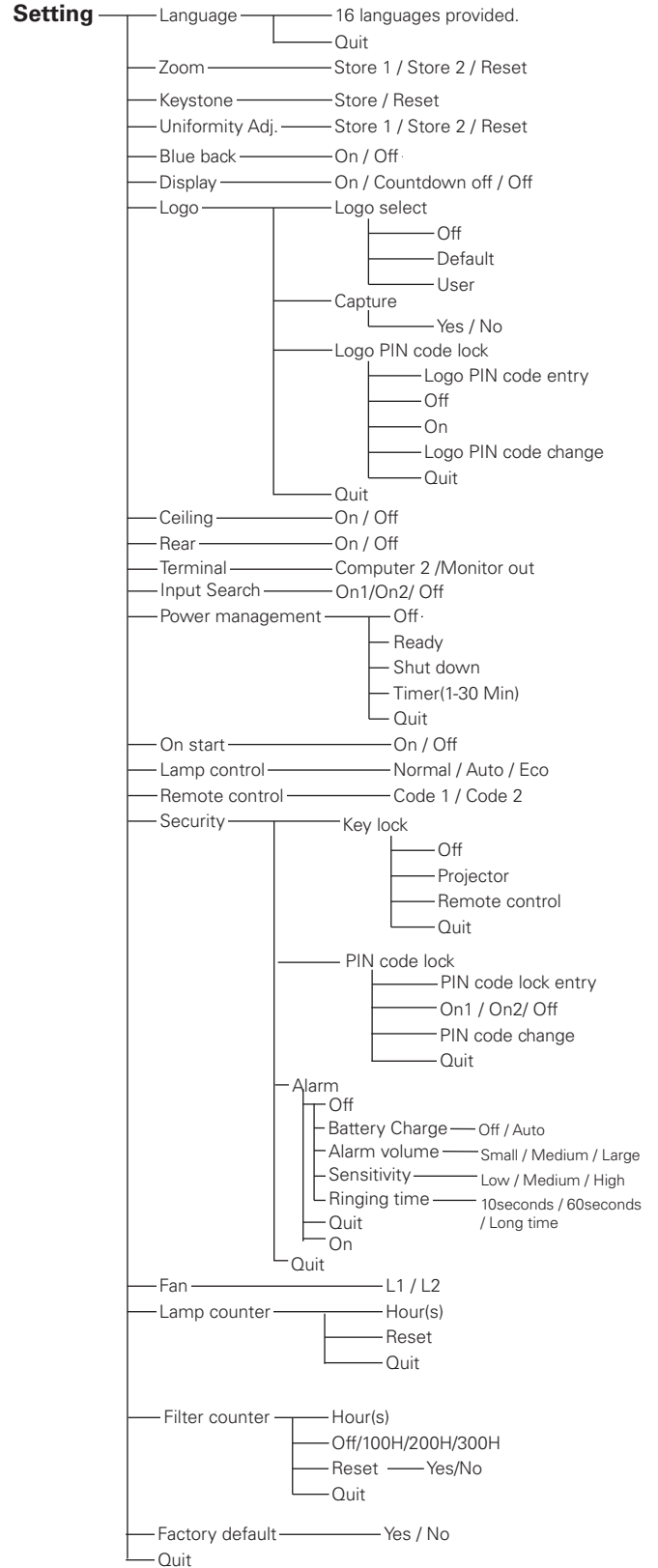
*Systems displayed in the System Menu vary depending on an input signal.



Video Input



Setting



Indicators and Projector Condition

Check the indicators for projector condition. For Alarm indicator, see pages 55-56.

Indicators			Projector Condition
POWER red/green	WARNING red	LAMP REPLACE yellow	
●	●	●	The projector is off. (The AC power cord is unplugged.)
⦿	●	*	The projector is preparing for stand-by or the projection lamp is being cooled down. The projector cannot be turned on until cooling is completed.
⦿	●	*	The projector is ready to be turned on with the ON/STAND-BY button.
○	●	*	The projector is operating normally.
⦿	●	*	The projector is in the Power management mode.
⦿	⦿	*	The temperature inside the projector is abnormally high. The projector cannot be turned on. When the projector is cooled down enough and the temperature returns to normal, the POWER indicator lights red and the projector can be turned on. (The WARNING indicator keeps blinking.) Check and clean the air filters.
⦿	⦿	*	The projector has been cooled down enough and the temperature returns to normal. When turning on the projector, the WARNING indicator stops blinking. Check and clean the air filters.
●	⦿	*	The projector detects an abnormal condition and cannot be turned on. Unplug the AC power cord and plug it again to turn on the projector. If the projector is turned off again, unplug the AC power cord and contact the dealer or the service center for service and checkup. Do not leave the projector on. It may cause an electric shock or a fire hazard.

○ ●●● green.

⦿ ●●● red

● ●●● off

⦿ ●●● blinks green.

⦿ ●●● blinks red.

* When the projection lamp reaches the end of its life, the LAMP REPLACE indicator lights yellow. When this indicator lights yellow, replace the projection lamp with a new one promptly. Reset the lamp replacement counter after replacing the lamp. See pages 62-63.

Compatible Computer Specifications

Basically this projector can accept the signal from all computers with the V-, H-Frequency mentioned below and less than 140 MHz of Dot Clock.

When selecting these modes, PC adjustment can be limited.

ON-SCREEN DISPLAY	RESOLUTION	H-Freq. (kHz)	V-Freq. (Hz)
VGA1	640x480	31.47	59.88
VGA2	720x400	31.47	70.09
VGA3	640x400	31.47	70.09
VGA4	640x480	37.86	74.38
VGA5	640x480	37.86	72.81
VGA6	640x480	37.50	75.00
VGA7	640x480	43.269	85.00
MAC LC13	640x480	34.97	66.60
MAC 13	640x480	35.00	66.67
480p	640x480	31.47	59.88
575p	768x575	31.25	50.00
575i	768x576	15.625	50.00 (Interlace)
480i	640x480	15.734	60.00 (Interlace)
SVGA1	800x600	35.156	56.25
SVGA2	800x600	37.88	60.32
SVGA3	800x600	46.875	75.00
SVGA4	800x600	53.674	85.06
SVGA5	800x600	48.08	72.19
SVGA6	800x600	37.90	61.03
SVGA7	800x600	34.50	55.38
SVGA8	800x600	38.00	60.51
SVGA9	800x600	38.60	60.31
SVGA10	800x600	32.70	51.09
SVGA11	800x600	38.00	60.51
MAC16	832x624	49.72	74.55
XGA1	1024x768	48.36	60.00
XGA2	1024x768	68.677	84.997
XGA3	1024x768	60.023	75.03
XGA4	1024x768	56.476	70.07
XGA5	1024x768	60.31	74.92
XGA6	1024x768	48.50	60.02
XGA7	1024x768	44.00	54.58
XGA8	1024x768	63.48	79.35
XGA9	1024x768	36.00	87.17 (Interlace)
XGA10	1024x768	62.04	77.07
XGA11	1024x768	61.00	75.70
XGA12	1024x768	35.522	86.96 (Interlace)
XGA13	1024x768	46.90	58.20
XGA14	1024x768	47.00	58.30
XGA15	1024x768	58.03	72.00
MAC19	1024x768	60.24	75.08

ON-SCREEN DISPLAY	RESOLUTION	H-Freq. (kHz)	V-Freq. (Hz)
SXGA1	1152x864	64.20	70.40
SXGA2	1280x1024	62.50	58.60
SXGA3	1280x1024	63.90	60.00
SXGA4	1280x1024	63.34	59.98
SXGA5	1280x1024	63.74	60.01
SXGA6	1280x1024	71.69	67.19
SXGA7	1280x1024	81.13	76.107
SXGA8	1280x1024	63.98	60.02
SXGA9	1280x1024	79.976	75.025
SXGA10	1280x960	60.00	60.00
SXGA11	1152x900	61.20	65.20
SXGA12	1152x900	71.40	75.60
SXGA13	1280x1024	50.00	86.00 (Interlace)
SXGA14	1280x1024	50.00	94.00 (Interlace)
SXGA15	1280x1024	63.37	60.01
SXGA16	1280x1024	76.97	72.00
SXGA17	1152x900	61.85	66.00
SXGA18	1280x1024	46.43	86.70 (Interlace)
SXGA19	1280x1024	63.79	60.18
SXGA20	1280x1024	91.146	85.024
SXGA +1	1400x1050	63.979	60.190
SXGA +2	1400x1050	65.346	60.116
SXGA +3	1400x1050	65.121	59.902
MAC21	1152x870	68.68	75.06
MAC	1280x960	75.00	75.08
MAC	1280x1024	80.00	75.08
WXGA1	1366x768	48.36	60.00
WXGA2	1360x768	47.70	60.00
WXGA3	1376x768	48.36	60.00
WXGA4	1360x768	56.16	72.00
WXGA6	1280x768	47.776	59.870
WXGA7	1280x768	60.289	74.893
WXGA8	1280x768	68.633	84.837
WXGA9	1280x800	49.600	60.050
UXGA1	1600x1200	75.00	60.00
UXGA2	1600x1200	81.25	65.00
UXGA3	1600x1200	87.5	70.00
UXGA4	1600x1200	93.75	75.00
720p	1280x720	45.00	60.00
1035i	1920x1035	33.75	60.00 (Interlace)
1080i	1920x1080	33.75	60.00 (Interlace)
1080i	1920x1080	28.125	50.00 (Interlace)

Technical Specifications

Mechanical Information

Projector Type	Multi-media Projector
Dimensions (W x H x D)	14.72" x 7.75" x 19.49" (374 mm x 196.8 mm x 495 mm) (Not including Rear leg)
Net Weight	16.74 lbs (7.6 kg)
Feet Adjustment	0° to 1.0°

Panel Resolution

LCD Panel System	0.8" P-Si TFT Active Matrix type
Panel Resolution	1,024 x 768 dots
Number of Pixels	2,359,296 (1,024 x 768 x 3 panels)

Signal Compatibility

Color System	PAL, SECAM, NTSC, NTSC4.43, PAL-M, and PAL-N
High Definition TV Signal	480i, 480p, 575i, 575p, 720p, 1035i, and 1080i
Scanning Frequency	H-sync. 15 kHz–100 kHz, V-sync. 50–100 Hz

Optical Information

Projection Image Size (Diagonal)	Adjustable from 60" to 80"
Projection Lens	F 1.85 lens with f 4.83 mm with manual focus
Distance (Screen - Projector)	-0.131' – 0.265' (-4.0 cm – 8.1 cm)
Projection Lamp	275 W

Interface

Video Input Jack	RCA Type x 1
S-Video Input Jack	Mini DIN 4 pin x 1
Audio Input Jacks	RCA Type x 2
Component Input Jacks	RCA Type x 3
Computer Input 1 Input Terminal	Analog RGB (Mini D-sub 15 pin) Terminal x 1
Computer Input 2 / Monitor Output Terminal	Analog RGB (Mini D-sub 15 pin) Terminal x 1 (In/Out switchable)
Audio Input Computer Jack	Mini Jack (stereo) x 1
Service Port Connector	Mini DIN 8 pin x 1
Audio Output Jack	Mini Jack (stereo) x 1 (Variable)

Audio

Internal Audio Amp	2.0 W RMS
Built-in Speaker	1 speaker, ø2.0" (50 mm)

Power

Voltage and Power Consumption	AC 100–120 V (3.2 A Max. Ampere), 50/60 Hz (The U.S.A and Canada) AC 200–240 V (1.6 A Max. Ampere), 50/60 Hz (Continental Europe and The U.K.)
-------------------------------	---

Operating Environment

Operating Temperature	41°F–95°F (5°C–35°C)
Storage Temperature	14°F–140°F (-10°C–60°C)

Remote Control

Battery	AA or LR6 1.5V ALKALINE TYPE x 2
Operating Range	11.5' (3.5 m) / ±90°
Dimensions	1.9" (W) x 0.87" (H) x 5.7" (D) (49 mm x 22 mm x 145.3 mm)
Net Weight	3.53 oz (100 g) (including batteries)

Accessories

Owner's Manual(CD-ROM)
Quick Reference Guide
AC Power Cord
Remote Control and Batteries
VGA Cable
PIN Code Label
Alarm Label
Lamp Replacement Label
Stand

- The specifications are subject to change without notice.
- LCD panels are manufactured to the highest possible standards. Even though 99.99% of the pixels are effective, a tiny fraction of the pixels (0.01% or less) may be ineffective by the characteristics of the LCD panels.

Optional Parts

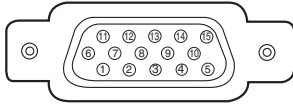
The parts listed below are optionally available. When ordering those parts, specify the item name and Model No. to the sales dealer.

	<i>Model No.</i>
SCART-VGA Cable	: POA-CA-SCART
VGA-Cable (10 m)	: KA-MC-DB10
Ceiling Hanger	: POA-CHS-PS02 (for low ceiling)
	: POA-CHL-PL02 (for high ceiling)
	: POA-CHB-XL50
Wall Anchor Kit	: POA-CH-EX03

Configurations of Terminals

COMPUTER INPUT / MONITOR OUTPUT TERMINAL (ANALOG)

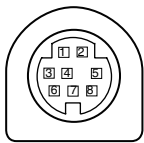
Terminal : Analog RGB (Mini D-sub 15 pin)



1	Red Input / Output	9	5V / ----
2	Green Input / Output	10	Ground (Vert.sync.)
3	Blue Input / Output	11	Ground / ----
4	----	12	DDC data / ----
5	Ground (Horiz.sync.)	13	Horiz. sync. Input/Output (Composite H/V sync.)
6	Ground (Red)	14	Vert. sync.
7	Ground (Green)	15	DDC clock/ ----
8	Ground (Blue)		

SERVICE PORT CONNECTOR

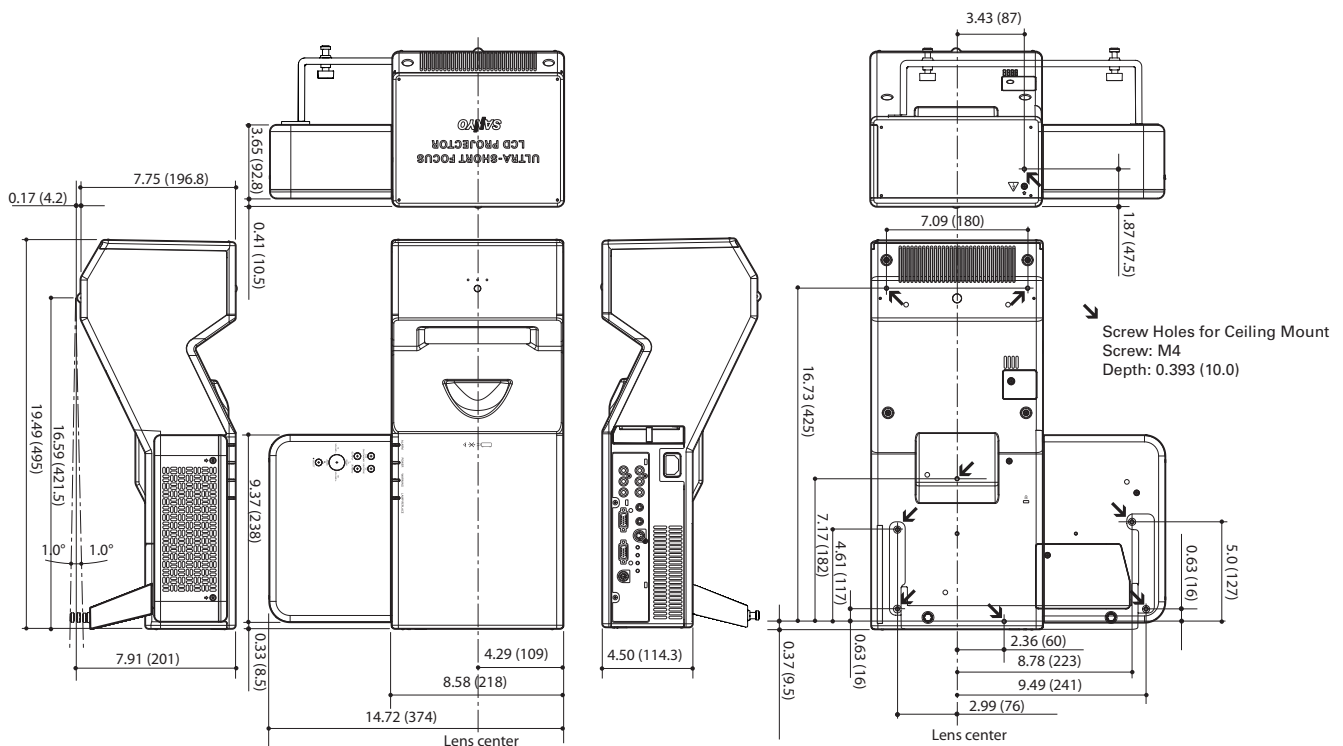
Terminal : Mini DIN 8-PIN



	Serial
1	R X D
2	----
3	----
4	GND
5	RTS / CTS
6	T X D
7	GND
8	GND

Dimensions

Unit: inch (mm)



PIN Code Number Memo

Write down the PIN code number in the column below and keep it with this manual securely. If you forgot or lost the number and unable to operate the projector, contact the service station.

PIN Code Lock No.	<table border="1" style="width: 100px; height: 30px;"> <tr> <td style="width: 25px; height: 25px;"></td> <td style="width: 25px; height: 25px;"></td> <td style="width: 25px; height: 25px;"></td> <td style="width: 25px; height: 25px;"></td> </tr> </table> <p style="text-align: center;">Factory default set No: 1 2 3 4*</p>				
Logo PIN Code Lock No.	<table border="1" style="width: 100px; height: 30px;"> <tr> <td style="width: 25px; height: 25px;"></td> <td style="width: 25px; height: 25px;"></td> <td style="width: 25px; height: 25px;"></td> <td style="width: 25px; height: 25px;"></td> </tr> </table> <p style="text-align: center;">Factory default set No: 4 3 2 1*</p>				
Alarm PIN Code No.	<table border="1" style="width: 100px; height: 30px;"> <tr> <td style="width: 25px; height: 25px;"></td> <td style="width: 25px; height: 25px;"></td> <td style="width: 25px; height: 25px;"></td> <td style="width: 25px; height: 25px;"></td> </tr> </table> <p style="text-align: center;">Factory default set No: 1 1 1 1*</p> <p style="text-align: center;">*Should the four-digit number be changed, the factory set number will be invalid.</p>				

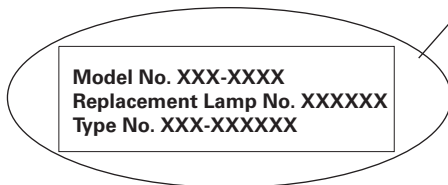
While the projector is locked with the PIN code...

Put the label below (supplied) to a prominent place of the projector's body while it is locked with a PIN code.



While the Antitheft alarm function is set...

Put the label below (supplied) on in a prominent place of the projector's body while the Antitheft alarm function is set.



Lamp Replacement Label

When using the projector ceiling-mounted, put the Lamp replacement label (supplied) on in a prominent place of the projector's body to check the Replacement Lamp Type Number.

