

myprojectorlamps.com

**The most trusted, dependable name
in projector lamp sales.**



<http://www.myprojectorlamps.com>



<http://www.myprojectorlamps.ca>



<http://www.myprojectorlamps.eu>

The following projector manual has not been modified or altered in any way.

IBM iLM300 MicroPortable Projector



User's Guide

IBM iLM300 MicroPortable Projector



User's Guide

Note: Before using this information and the product it supports, read the information under Appendix F, “Warranty information” on page 41 and Appendix G, “Notices” on page 51.

Second Edition (June 2002)

© **Copyright International Business Machines Corporation 2001. All rights reserved.**

US Government Users Restricted Rights – Use, duplication or disclosure restricted by GSA ADP Schedule Contract with IBM Corp.

Contents

Safety: Read first.	v
About this book.	vii
Registering your option	vii
Chapter 1. Installing the projector	1
Introduction	1
Image resolution	1
Compatibility	1
Unpacking the projector	1
Usage guidelines	2
Setting up the projector.	4
Connecting a computer to the projector	4
Connecting a video player.	6
Chapter 2. Using the projector	9
Adjusting the image	9
Adjusting the image focus	9
Using the projector keypad and remote control	10
Keypad or remote control	10
Using the remote control	11
Left (L) and Right (R) remote buttons.	11
Up/down arrow buttons	11
Using the on-screen menus	12
Navigating on-screen menus.	12
Basic menu	12
Setup menu	14
Appendix A. Product specifications and accessories	25
Specifications	25
Accessories	25
Replacement lamps.	25
Appendix B. Maintenance and troubleshooting	27
Cleaning the lens	27
Replacing the projection lamp	27
Replacing the batteries in the remote control	29
Troubleshooting	30
Adding security	31
Appendix C. Portable and mobile computer activation	33
Appendix D. Using video mirroring	37
Using video mirroring with a PowerBook computer.	37
Using Simulscan.	37
Appendix E. Projected image size	39
Appendix F. Warranty information	41
Warranty period.	41
Replacement lamps.	41
Service and support	41
Warranty information on the World Wide Web	41

Online technical support	41
Telephone technical support	42
IBM Statement of Limited Warranty Z125-4753-06 8/2000	43
Part 1 - General Terms.	43
Part 2 - Country-unique Terms	45
Appendix G. Notices	51
Trademarks	51
Federal Communications Commission (FCC) statement.	52

Safety: Read first

Before installing this product, read the Safety Information.

مج، يجب قراءة دات السلامة

Antes de instalar este produto, leia as Informações de Segurança.

在安装本产品之前，请仔细阅读 **Safety Information**
(安全信息)。

Prije instalacije ovog produkta obavezno pročitajte Sigurnosne Upute.

Před instalací tohoto produktu si přečtěte příručku bezpečnostních instrukcí.

Læs sikkerhedsforskrifterne, før du installerer dette produkt.

Ennen kuin asennat tämän tuotteen, lue turvaohjeet kohdasta Safety Information.

Avant d'installer ce produit, lisez les consignes de sécurité.

Vor der Installation dieses Produkts die Sicherheitshinweise lesen.

Πριν εγκαταστήσετε το προϊόν αυτό, διαβάστε τις πληροφορίες ασφάλειας
(safety information).

לפני שתתקינו מוצר זה, קראו את הוראות הבטיחות.

A termék telepítése előtt olvassa el a Biztonsági előírásokat!

Prima di installare questo prodotto, leggere le Informazioni sulla Sicurezza.

製品の設置の前に、安全情報をお読みください。

본 제품을 설치하기 전에 안전 정보를 읽으십시오.

Пред да се инсталира овој продукт, прочитајте информацијата за безбедност.

Lees voordat u dit product installeert eerst de veiligheidsvoorschriften.

Les sikkerhetsinformasjonen (Safety Information) før du installerer dette produktet.

Przed zainstalowaniem tego produktu, należy zapoznać się
z książką "Informacje dotyczące bezpieczeństwa" (Safety Information).

Antes de instalar este produto, leia as Informações sobre Segurança.

Перед установкой продукта прочтите инструкции по
технике безопасности.

Pred inštaláciou tohto zariadenia si pečítajte Bezpečnostné predpisy.

Pred namestitvijo tega proizvoda preberite Varnostne informacije.

Antes de instalar este producto lea la información de seguridad.

Läs säkerhetsinformationen innan du installerar den här produkten.

安裝本產品之前，請先閱讀「安全資訊」。

About this book

This manual contains instructions for setting up, using, maintaining, and troubleshooting the iLM300 IBM® MicroPortable Projector.

This guide contains the product description, installation, and software instructions in the following languages:

- French
- German
- Italian
- Spanish
- Brazilian Portugese
- Simplified Chinese
- Traditional Chinese

The appendixes contain product specifications, accessories, and help and service. They also contain the product warranties and notices.

Note: The illustrations in this manual might be slightly different from your machine.

Registering your option

Thank you for purchasing this IBM product. Please take a few moments to register your product and provide us with information that will help IBM to better serve you in the future. Your feedback is valuable to us in developing products and services that are important to you, as well as in developing better ways to communicate with you. Register your option on the IBM Web site at

<http://www.ibm.com/pc/register>

IBM will send you information and updates on your registered product unless you indicate on the Web site questionnaire that you do not want to receive further information.

Chapter 1. Installing the projector

This chapter covers how to setup and use the projector.

Introduction

The IBM® iLM300 MicroPortable Projector is specifically designed for the mobile presenter. It generates crisp, clear images using Digital Light Processing (DLP) technology and features an M1-DA connector. The projector is easy to connect, use, transport, and maintain.

Image resolution

The XGA resolution of the projected image is 1024 x 768. The projector is compatible with screen resolutions up to 1280 x 1024. If your computer screen resolution is higher than 1280 x 1024, reset it to a lower resolution before you connect the projector.

Note: The image automatically expands 640 x 480 and 800 x 600 images to 1024 x 768.

Compatibility

The projector is compatible with a wide variety of computers and video devices, including:

- IBM-compatible computers, including mobile computers, up to 1280 x 1024 resolution.
- Apple Macintosh and PowerBook computers with up to 1280 x 1024 resolution.
- Most standard VCRs, DVD players, camcorders, and laser disc players.

Unpacking the projector

Attention

This product contains a Metal Arc Lamp which contains mercury. Dispose of it as required by local ordinances and regulations.

The projector comes with the items shown in the following illustration. Check to make sure that all items are included. Contact your place of purchase immediately if anything is missing.

If you are experienced in setting up presentation systems, use the *Quick Start* card that was included with this option. For complete details on connecting and operating the projector, refer to the *User's Guide* on

CD.

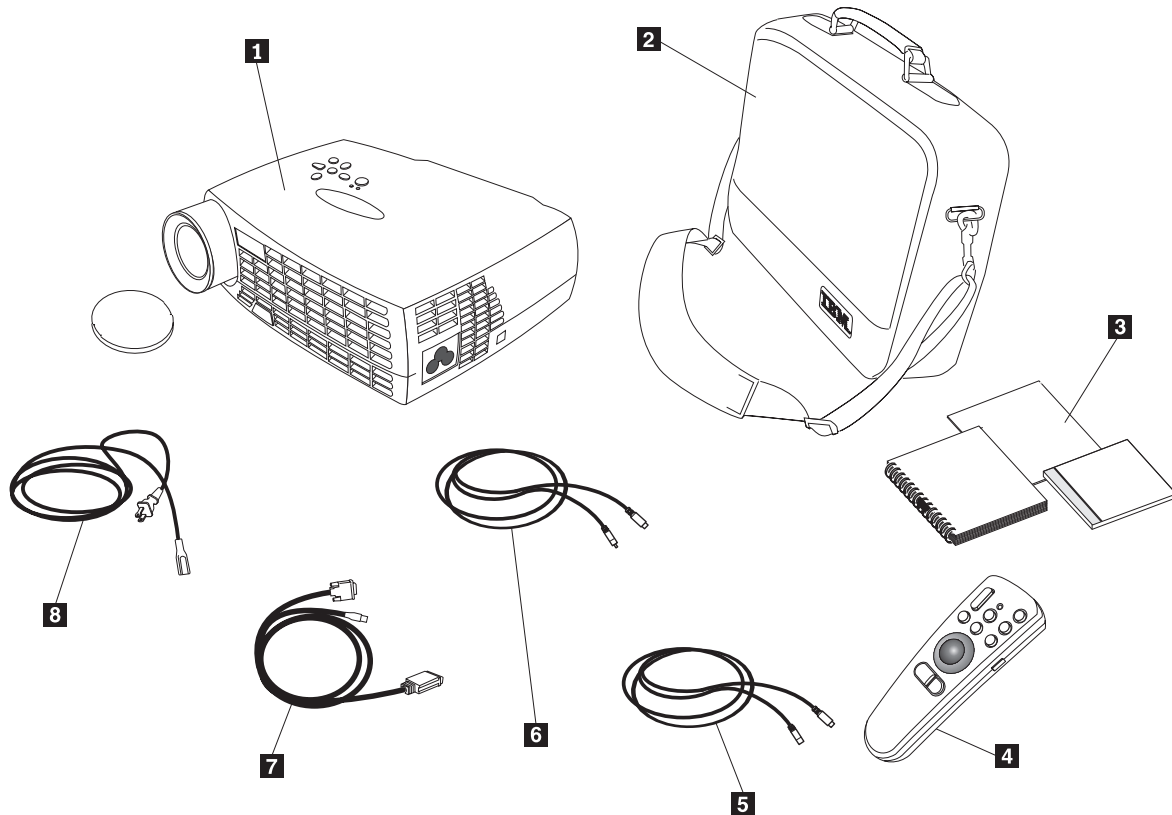

1 iLM300 IBM MicroPortable Projector and lens cap

2 Soft carrying case

3 Quick Start card and multi-language online *User's Guide* CD

4 Remote control

5 S-video cable

6 Composite video cable

7 M1-DA data cable (analog to digital), including USB mouse

8 Power cord

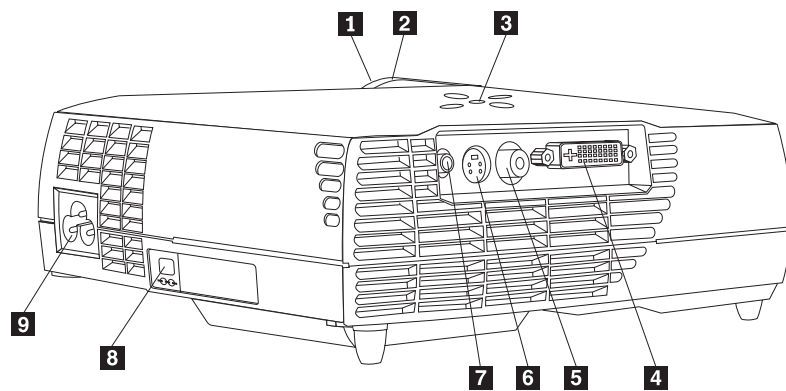

1 Zoom Ring

2 Focus Ring

3 Keypad

4 Computer connector

5 Video

6 S-Video

7 Audio in

8 Security lock

9 Power cord

Usage guidelines

Observe the following guidelines when using the projector.

Attention:

Do not look directly into the projection lens when the lamp is turned on. The bright light might harm your eyes.

Attention:

Follow these guidelines when working with the projector.

- Do not block the grills on the projector. Restricting the airflow can cause it to overheat and turn off. If this happens, you must wait one minute before attempting to start the projector again.
- Handle the projector as you would any other product with glass components. Be especially careful not to drop it.
- Avoid leaving the projector in direct sunlight or extreme cold for extended periods of time. If this happens, allow it to reach room temperature before use.
- Transport the projector in a carrying case. See “Accessories” in Appendix A for information on ordering a case and other accessories for your projector.

Setting up the projector

Before turning on your projector, make sure all connections are made. Use the following procedure to set up the projector:

1. Place the projector on a flat surface.
 - The projector must be within 3 meters (10 feet) of your power source and within 1.8 meters (6 feet) of your computer.
 - If you want to project from behind a translucent screen, set up the projector behind the screen. See the instructions for Rear projection in “System menu” on page 18 for instructions on reversing the image.
2. Position the projector the desired distance from the screen.
 - If the image is too big or too small, set the zoom ring to adjust the size or move the projector forward or backward. Once you have made all connections described in this section, you can make adjustments. The following illustration shows three projected image sizes. For more information about image size, see Appendix E, “Projected image size” on page 39.

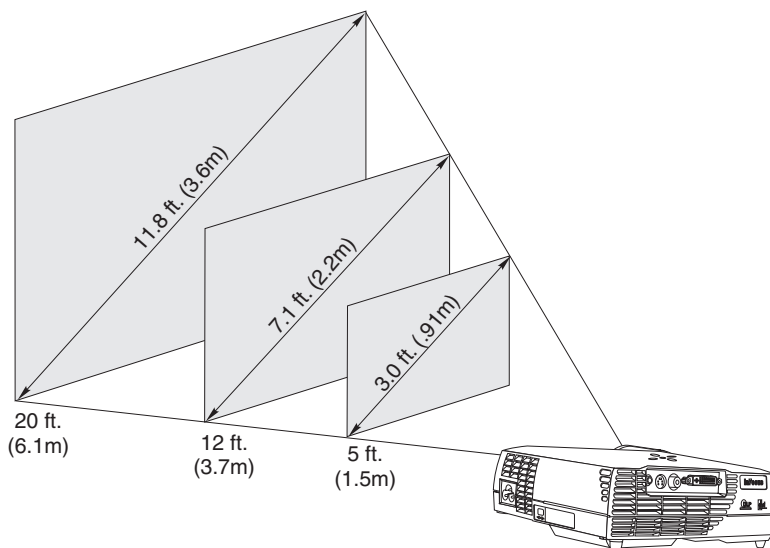

3. Make sure the projector is unplugged and your computer is turned off.



DANGER

Electrical current from power, telephone, and communication cables is hazardous.

To avoid a shock hazard:

- Do not connect or disconnect any cables or perform installation, maintenance, or reconfiguration of this product during an electrical storm.
- Connect all power cords to a properly wired outlet.
- Connect to properly wired outlets any equipment that will be attached to this product.
- When possible, use one hand only to connect or disconnect signal cables.
- Never turn on any equipment when there is evidence of fire, water, or structural damage.
- Disconnect the attached power cords, telecommunications systems, networks, and modems before you open the device covers, unless instructed otherwise in the installation and configuration procedures.
- Connect and disconnect cables as described in the following table when installing, moving, or opening covers on this product or attached devices.

To connect:

1. Turn everything OFF.
2. First attach all cables to devices.
3. Attach signal cables to connectors.
4. Attach power cords to outlet.
5. Turn device ON.

To disconnect:

1. Turn everything OFF.
2. First, remove power cords from outlet.
3. Remove signal cables from connectors.
4. Remove all cables from devices.

Note: If you are connecting the projector to a computer, make sure that the distance between the computer and the projector is 6 feet or less.

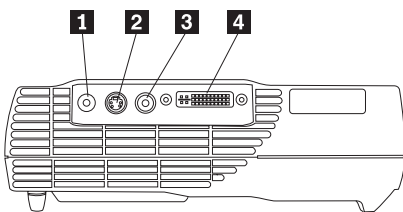

1 Audio in

2 S-Video

3 Video

4 Computer/USB mouse

Connecting a computer to the projector

The projector comes with an computer cable. If your computer has a digital output port, you can use the optional digital computer cable, which is sold separately. See “Accessories” on page 25 for ordering

information.

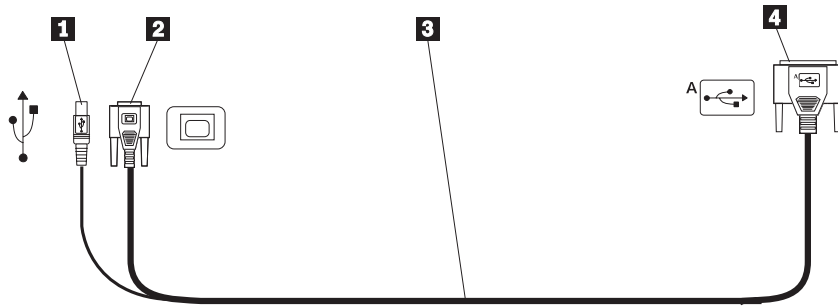

- 1** To USB mouse **2** To computer video **3** To projector **4** Analog computer cable

1. Plug the single connector end of the computer cable into the connector on the projector as shown in the illustration below.
2. Plug the blue connector on the other end of the computer cable into the video connector on your computer.
3. If you want to advance slides in a PowerPoint™ presentation using the remote control, plug the USB cable into the USB mouse connector on your computer.

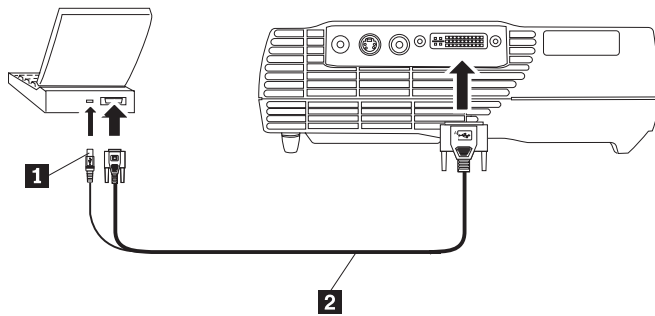

- 1** USB mouse **2** Computer cable

Notes:

1. Many mobile computers do not automatically turn on their external video port when a secondary display device such as a projector is connected. See your computer manual for the command that activates the external video port. Press Fn+F7 on your IBM ThinkPad® to activate the external display. See a chart listing activation commands for selected mobile computers in Appendix C, “Portable and mobile computer activation” on page 33.
2. If you are connecting the projector to an older Macintosh computer that does not have a 15-pin connector, you must use a Macintosh adapter between the computer and the projector.
3. The USB mouse is supported for use only with Microsoft® Windows® 98, Microsoft Windows 2000 Professional, and Apple OS 9.0 and later.
4. You do not need to restart your computer after connecting a USB mouse.

For information on starting the projector and computer, go to “Starting the projector and adjusting the image” on page 7.

Connecting a video player

Use the following procedure to connect a video player.

- If your video player uses a round, one-prong composite video connector, use the composite video cable.

- If your video player uses a round, four-prong S-video connector, use the S-video cable. S-video generates a higher quality image.
- Attention:** Your video player might also have a Video Out connector for a coaxial cable connection. DO NOT use this to connect to the projector.
1. Connect the yellow composite video cable connector into the Video Out connector on your video player. This connector might be labeled To Monitor. If you are using an S-video cable, connect the round black connector to the Video Out connector on the video player.
 2. Connect the round yellow connector into the Composite Video connector on the projector.

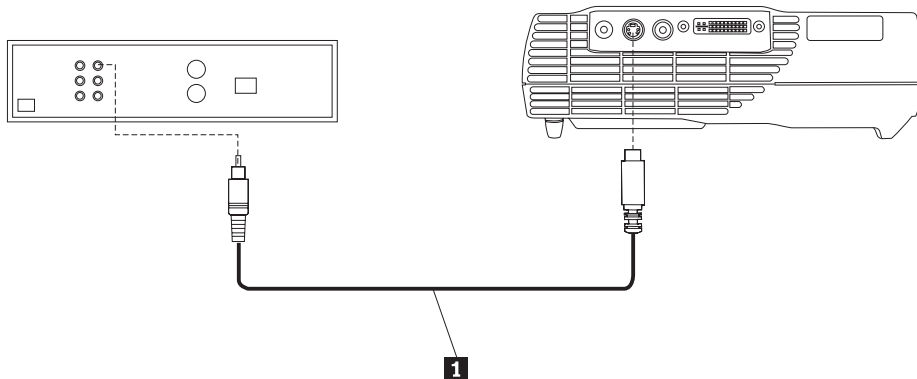

1 S-Video cable

The projector is compatible with these major broadcast video standards: NTSC, NTSC 4.43, PAL, PAL-M, PAL-N, PAL-60, and SECAM. It automatically adjusts to optimize its performance for the incoming video.



DANGER

Electrical current from power, telephone, and communication cables is hazardous.

To avoid a shock hazard:

- Do not connect or disconnect any cables or perform installation, maintenance, or reconfiguration of this product during an electrical storm.
- Connect all power cords to a properly wired electrical outlet.
- Connect to properly wired outlets any equipment that will be attached to this product.
- When possible, use one hand only to connect or disconnect signal cables.
- Never turn on any equipment when there is evidence of fire, water, or structural damage.
- Disconnect the attached power cords, telecommunications systems, networks, and modems and modems before you open the device covers, unless instructed otherwise in the installation and configuration procedures.
- Connect and disconnect cables as described in the following table when installing, moving, or opening covers on this product or attached devices.

To connect:

1. Turn everything OFF.
2. First attach all cables to devices.
3. Attach signal cables to connectors.
4. Attach power cords to outlet.

To disconnect:

1. Turn everything OFF.
2. First, remove power cords from outlet.
3. Remove signal cables from connectors.
4. Remove all cables from devices.

5. Turn device ON.

Starting the projector and adjusting the image

Use the following procedure to start the projector and adjust the image.

1. Remove the lens cap.
2. Attach the power cord to the side of the projector, and then into an electrical outlet. It is good practice to use a surge-protected power strip. Always use the power cord that was included with the projector.

Note: With some computers, the order in which you start the equipment is very important. Most computers should be turned on last, after all other peripheral devices have been turned on. Refer to the computer documentation to determine the order.

3. Press the Power button on the top of the projector. The fans start to run, and the LED on the top of the projector lights green until the startup screen displays. It takes about one minute for the image to achieve full brightness.
4. If you connected a video player, turn it on.
 - The video image is displayed on the projection screen. If it is not, press the Select button on the keypad or Video button on the remote control to display your video image.
5. Turn on your computer.

Note: The first time you connect your computer to the projector, the computer might display a message stating that new hardware was found. The Add New Hardware Wizard window might open. Use the wizard to install the correct device driver for a Plug and Play monitor.

- The computer image is displayed on the projection screen. If it is not, press the Select button on the keypad or Computer button on the remote to display your computer image.
- Make sure your mobile computer external video port is active; see Appendix C, “Portable and mobile computer activation” on page 33 for details.
- If necessary, make adjustments to the image using the projector on-screen menus. To display the menus, press the Menu button on the keypad or remote control. For more information about the menus see “Using the on-screen menus” on page 12.

Turning off the projector

To turn off the projector, press the Power button. If you want to turn the lamp back on, allow 90 seconds for the lamp to cool. The lamp will not turn on if it is too hot.

Note: To maximize lamp life, allow the projector fan to run for at least five minutes before removing the power cord.

Chapter 2. Using the projector

This chapter describes how to use and make adjustments to the projector. It also provides a reference to the keypad, remote control buttons and the options that are available from the on-screen menus.

Adjusting the image

To adjust the image, do the following:

- Make sure that you have turned on your equipment in the correct order. See “Starting the projector and adjusting the image” on page 7.
- If the image is not displayed completely, zoom the image, adjust the height of the projector, or center the image by adjusting its horizontal or vertical position. Be sure the projector is at a 90-degree angle to the screen.
- If the image does not fit the projection area, or is otherwise not square enough, use the Keystone button on the top of the projector. Also, see the keystone function under “Basic menu” on page 12.
- If the image is out of focus, rotate the focus lens as shown below.
- If the colors do not display correctly, adjust the brightness, contrast, tint or color. See “Setup menu” on page 14.

Adjusting the image focus

To focus the image, rotate the focus ring **1** in the following illustration, until the image is clear. To adjust the image size, rotate the zoom ring, **2**.

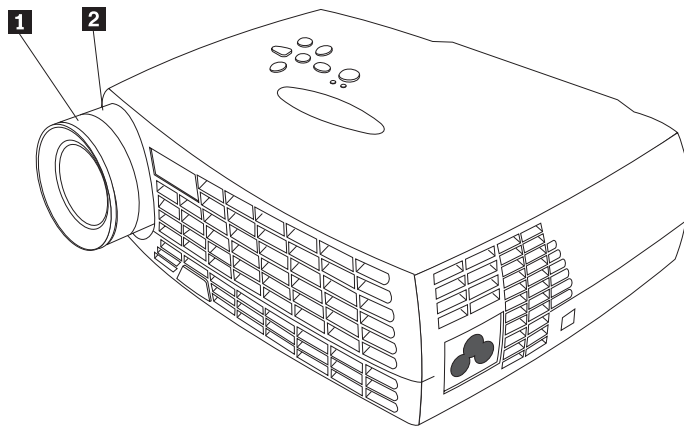

Note: To obtain the best overall focus quality, open a menu and focus the text. Focusing on the text will ensure that the best overall image quality. See “Navigating on-screen menus” on page 12 for information on opening a menu.

The projector is equipped with a self-locking, quick-release elevator foot and button. To raise the projector:

1. Press and hold the elevator button **1**.
2. Raise the projector to the height that you want, then release the button to lock the elevator foot **2** into position.

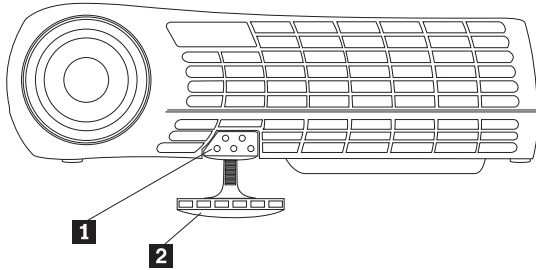

Using the projector keypad and remote control

On the projector keypad, at left below, and the remote control, at right below, use the Menu button to display the on-screen menus. Use the Select button on the projector keypad or the Computer and Video buttons on the remote, at right below, to choose between devices attached to the projector. See “Using the on-screen menus” on page 12 for details.

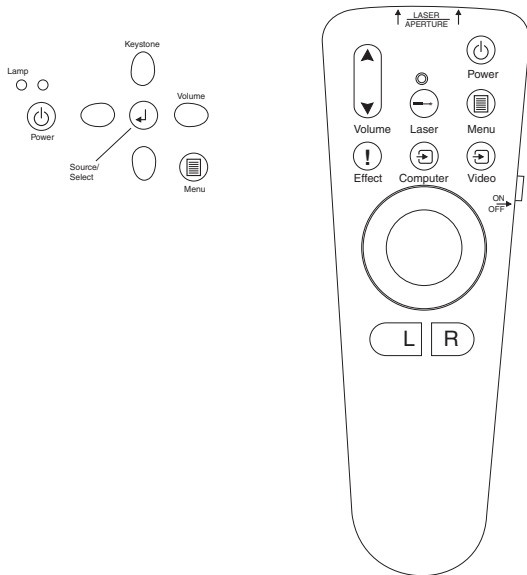

Keypad or remote control

When you have more than one image source connected to the projector, select between them by

- pressing the Select button on the keypad
- pressing the Computer or Video button on the remote control
- using the SourceSearch feature in the on-screen menus to automatically detect the kind of source attached. See “SourceSearch on page 18.

Note: If the SourceSearch feature is not activated and you have multiple devices attached to the projector, you might need to press the Select button more than once to find the active source. If you are using the Select button, sources rotate in this order: data analog, data digital, S-video, and composite video.

Using the remote control

Use the **L** and **R** buttons on the remote control to advance slides in your presentation. Connect the USB mouse connector on the projector computer cable to the computer. See “Connecting a computer to the projector” on page 4 for details.

Point the remote control at the projection screen or at the front of the projector (not at the computer). The range for optimum operation is approximately 7.6 meters (25 feet). If you point the remote control at the projection screen, the distance to the screen and back to the projector must be less than or equal to 7.6 meters (25 feet) or less. For best results, point the remote control directly at the projector.

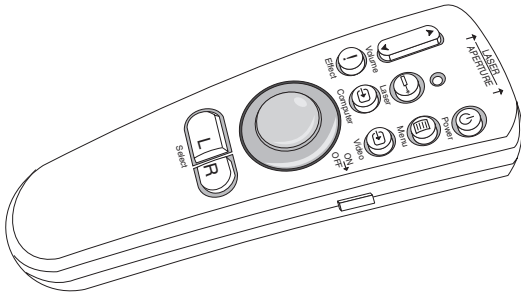

Press the red laser button to use the laser pointer on the front of the remote. Use the laser pointer to emphasize key points of your presentation.

Left (L) and Right (R) remote buttons

These buttons act like the page up and page down buttons on your computer keyboard. You can use them to advance through a slide show. To use this feature, connect the USB mouse connector on the computer cable to your computer. See “Connecting a computer to the projector” on page 4.

Up/down arrow buttons

Use these buttons to navigate through and make adjustments to the on-screen menus. See “Using the on-screen menus” on page 12.

Using the on-screen menus

The projector has on-screen menus from which you can make adjustments and change a variety of settings that are not available directly from the keypad.

Navigating on-screen menus

The following conventions apply when using on-screen menus:

- Press the **Menu** button on either the remote or the projector keypad to open the on-screen menus.
- Use the trackball on the remote and the arrow buttons on the keypad and remote to navigate menus.
- Select menu options by pressing the **L/Select** button on the remote.

Note: Some menu items might be unavailable (dimmed). This indicates that the item is not applicable, or is not enabled until another selection is made.

- Press **Menu** again to close the menus.

Note: If there is no activity, the menus automatically close after 30 seconds.

Any setting changes you have made are saved. Some changes, such as a custom logo, do not become active until you turn off and restart the projector.

To open the on-screen menus, press the Menu button on the keypad or remote. The first menu is the Basic menu. Press the down arrow button to move the cursor down and press the up arrow button to move the cursor up. The selected menu option is highlighted.



Use the arrows buttons to adjust a setting or turn it on and off. Press the **L/Select** button when you are done. Press the up and down arrows to move to another setting. When you complete your adjustments, navigate to the Exit Arrow, then press **L/Select**. You are returned to the previous menu. Press **Menu** to exit the menu system, or navigate to another submenu.

The following sections provide an overview of the menus.

Basic menu

From the Basic menu, you can make changes to the contrast, brightness, color, Keystone, reset settings. You can also access the Setup menu.

Contrast

Adjust the contrast (ratio of light to dark) from values of 0 - 100.

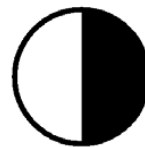

Brightness

Adjust the general brightness of the image from values of 0 - 100.

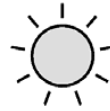

Color

Adjust the color intensity from values of 0 - 100.

Keystone

Adjust the angle of the image to achieve a square image, or to fit the image to the projection area.

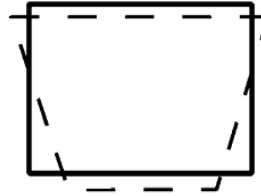

For direct access to keystone correction, just press the left and right arrows on the projector keypad, without entering the on-screen menu. Use the up and down arrows on the projector keypad to adjust the image angle from values -63 to +64.



Keystone



Press the \uparrow button to reduce the upper part of the image **1**, and press the Keystone \downarrow button to reduce the lower part **2**.

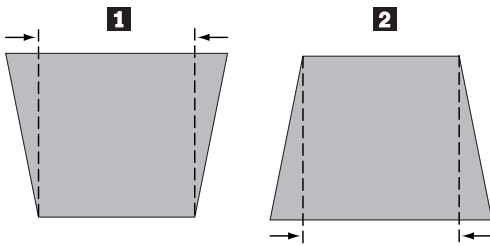

Setup

Use the Setup option to access other menus for picture quality, menu language, image effects and service. See “Setup menu”.



Reset

Use the Reset option to synchronize settings to the currently attached source device.



About

Use this option to get information about a currently used feature.



Setup menu

To access the Setup menu, press the Menu button to display the Basic menu. Press the down arrow to highlight Setup, then press Select to open the Setup menu.



Picture, System, Language, Effect and Service all have submenus. The following sections explain the Setup menu options.

Picture

Use the Picture option to display a menu of choices for Screen Aspect, Color Temp, Sharpness, Application, ARLs, Tune, Width, Position, and Tint.



For more information about the Picture menu, see “Picture menu” on page 16.

System



For more information about the System menu, see “System menu” on page 18.

Language



For more information about the Language menu, see “Language menu” on page 19.

Effect



For more information about the Effect menu, see “Effect menu” on page 19.

Service



For more information about the Service menu, see “Service menu” on page 21.

Userlogo



For more information about the Userlogo menu, see “User’s Logo menu” on page 22.

Picture menu

The following section has explanations for menu items in the Picture menu.

Screen Aspect

Select the horizontal to vertical ratio. The default setting is 4:3.

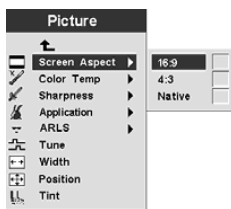

Color Temp

Change the intensity of projected colors. The default value is 7300 Kelvin.

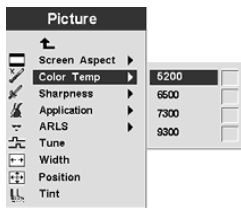

Sharpness

Set the sharpness and clarity of video images. The default is set to sharpest.

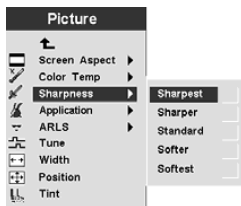

Application

Set the origin of the displayed information from Normal, Home theatre, and from a Photograph.

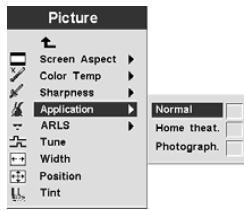

ARLS

With the Automatic Room Light Sensor (ARLS) you can adjust image settings to compensate for the level of ambient light in the room.

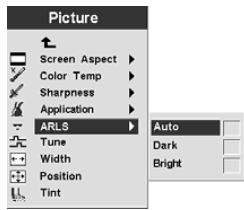

Tune

Fine tune a computer analog image.

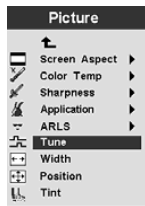

Width

Adjust a computer analog image width.



Position

Use the trackball on the remote or the arrow keys on the keypad to adjust the placement of the projected image on the screen.

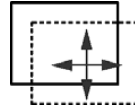

Tint

The tint adjusts the red-green color balance in the projected image.

Note: The Tint option is available for Video (NTSC) mode only.

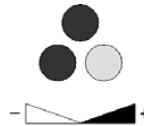

System menu

From the Basic menu, select **Setup** → **System** to display the System menu.



Rear

Select **Rear** if the image will be projected onto the back of a transparent projection screen. This setting reverses the image so that it will be legible from the front.



SourceSearch

Select SourceSearch to automatically have the projector determine the source of the current image. Selecting SourceSearch again, turns off this automatic function.

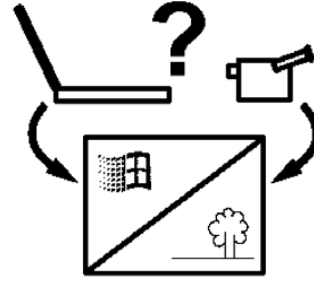

Hide OSD

Select Hide OSD to enable/disable the on-screen display.



DPMS enable

Select this feature to enable/disable displaying projector power management settings.



Language menu

From the Basic menu, select **Setup** → **Language**. Navigate to the language of your choice. The projector on-screen menus will be displayed in this language.



Effect menu

Program the Effect button on your remote with one of the items in this menu.

From the Basic menu, select **Setup** → **Effect**. Choose the function you will use most often. At any time, you can return to this menu and choose a different item for the Effect button.



Magnify

To emphasize a portion of the displayed image by enlarging it, select magnify.



Freeze

To stop the presentation at a particular point, including all animations, select Freeze.



Mask

To hide or reveal a portion of the displayed image, select Mask. Use the remote trackball to move the Mask over the image.



Mute

To use the remote Effect button to turn off the sound, select Mute.



16:9

This item is useful if you have varied screen sizings in the same presentation. Select 16:9 to activate the 16:9 ratio using the Effect button.



Service menu

Use the choices on this menu to perform maintenance functions. The Service Code is reserved for trained technicians only.

From the Basic menu, select **Setup** → **Service**.



Factory Reset

Use **Factory Reset** to automatically return all settings to the factory default values.



Info

Select **Info** to display further information about projector settings.



Reset Lamptimer

Select this option when you change the projector lamp. The Lamp timer shows how many hours a lamp has been used. See “Replacing the projection lamp” on page 27.



Service Code

This menu item is for trained service personnel only. If a numerical code is displayed, report this number to the service technician.



User's Logo menu

Use items from this menu to determine what logo the projector displays when the lamp is turned on and no source is attached. You can also chose to have the projector display your own logo.



Default

Default is the projector logo screen.

Blue and Black

Select either Blue or Black to have the projector display a plain background when no source is attached.

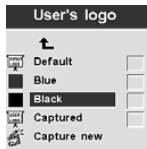

Captured

Select this item and the projector will display your own ready-made logo.



Capture new

Select this item to define a new logo. See the following instructions for capturing a new logo.



Capture New: To define a new logo, do the following:

1. While the image you wish to use is displayed, press the Menu button.
2. Select Basic → Setup → User's Logo → Capture New
3. Use the remote trackball to select the area to be captured.

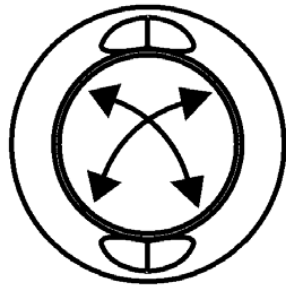

Select

- To increase or decrease the size of the capture area, use the remote or keypad **Volume** button. The up arrow, ↑, increases the capture area, the bottom down arrow, ↓, decreases the capture area.

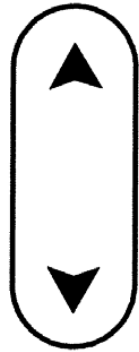

Volume

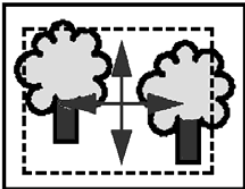
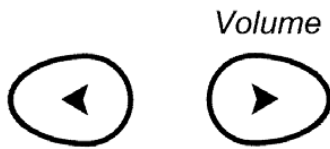

- Press **L/Select** on the remote to confirm. Check for confirmation that the image capture was successful.
- Turn off and restart the projector to use the newly-created image for your logo.

Appendix A. Product specifications and accessories

This appendix lists the specifications for the projector.

Specifications

The iL300 Projector must be operated and stored within the temperature and humidity ranges specified.

Temperature

Operating	50 to 95° F (10 to 35° C) at sea level 50 to 77° F (10 to 25° C) at 10,000 feet
Non-operating	-4 to 158° F (-20 to 70° C)

Altitude

Operating	0 to 10 000 feet (3 048 meters)
Non-operating	0 to 20 000 feet (6 096 meters)

Humidity

Operating and non-operating	10% to 95% relative humidity, non-condensing
-----------------------------	--

Dimensions

6.06 x 7.83 x 2.48 inches (15.4 x 19.9 x 6.3 cm)

Weight

2.4 lbs. (1.1 kg) unpacked

Optics

Focus range	4.9 - 32.8 feet (1.5 - 10 m)
-------------	------------------------------

Lamp

Type	120-watt UHP lamp
------	-------------------

Input power requirements

100-120VAC 2A;50/60Hz 200-240VAC 1A; 50Hz

Accessories

There are many accessories available for your projector and new ones are added frequently. Visit the IBM Web site at <http://www.pc.ibm.com/us/accessories/projectors/index.html> and select from the many accessories for your projector.

Replacement lamps

If your projector lamp is covered under the warranty, see "Telephone technical support" on page 42, for information on contacting IBM and requesting a new lamp.

For all other replacement lamps, order a new lamp from the IBM Web site at <http://www.pc.ibm.com/us/accessories/projectors/index.html>.

Appendix B. Maintenance and troubleshooting

This section describes how to:

- Clean the lens
- Replace the projection lamp
- Replace the batteries in the remote
- Use the security lock feature
- Troubleshoot the projector

Cleaning the lens

Follow these steps to clean the projection lens:

1. Apply a non-abrasive camera lens cleaner to a soft, dry cloth.
 - Avoid using an excessive amount of cleaner, and do not apply the cleaner directly to the lens.
 - Abrasive cleaners, solvents or other harsh chemicals might scratch the lens.
2. Lightly wipe the cleaning cloth over the lens in a circular motion.
3. If you do not intend to use the projector immediately, replace the lens cap.

Replacing the projection lamp

Attention:

To avoid burns, allow the projector to cool for at least 60 minutes before you open the lamp. Never extract the lamp module while the projector is operating.



Caution:

The following label indicates a hot surface nearby.



The Lamp timer in the on-screen Service menu counts the number of hours the lamp has been in use. See Lamptimer in “Service menu” on page 21. View the Lamp timer periodically to see how much time has elapsed on the lamp. Change the lamp when the Change Lamp warning appears in the lower left corner of the screen. See “Replacement lamps” on page 41 for ordering information.

To perform this procedure, set the projector bottom side up on a flat, clean surface such as a table. To replace the projection lamp, do the following:

1. Turn off the projector and remove the power cord from the projector and from the electrical outlet.
2. Wait 60 minutes to allow the projector to cool thoroughly.

3. Working on a flat, clean surface turn the projector over, with the bottom facing you. With a screwdriver, unscrew the lamp housing then gently open the lip to the lamp housing.

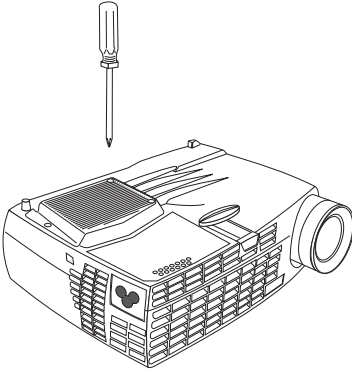

4. Carefully remove the lamp housing and dispose of it in an environmentally proper manner.

Attention:

This product contains a metal arc lamp which contains mercury, a caustic substance. Dispose of it as required by local ordinances and regulations.

Attention:

Be extremely careful when removing the lamp module. In the unlikely event that the bulb breaks, small glass fragments might be generated. The lamp module is designed to contain these fragments, but use caution when removing the lamp module.

Attention:

Do not drop the lamp module or touch the glass bulb. The glass may shatter and cause injury. Oils from your hands might shorten the life of the bulb.

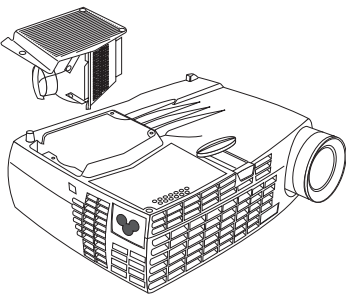

5. Insert the new lamp housing. Gently press the lamp housing back into position.
6. Tighten the screws. Return the projector to the upright position.
7. Attach the power cord to the back of the projector and an electrical outlet. Press the power button on top of the projector to turn it on.
8. To reset the lamp timer counter, see "Reset Lamp timer" on page 21 for details.

Replacing the batteries in the remote control

The life of the batteries depends on how often and how long you use the remote control. Symptoms of low battery charge include erratic responses when using the remote control and a reduced range of operation.

Follow these steps to replace the batteries:

1. Turn the remote face down in your hand.
2. Press the tab on the battery door toward the back of the remote and slide the door off.
3. Remove the old batteries and dispose of them in an environmentally proper manner.
4. Install two new AAA alkaline batteries. Make sure you install each battery in the correct direction.
5. Slide batter door into the correct, locked position.

Troubleshooting

Problem: The projector is not running.

- Make sure that the power cord is properly connected to a fully functional ac electrical outlet. Make sure that the power cord is also properly connected to the projector.
- If the projector is plugged into a power strip, make sure the power strip is turned on.
- Make sure the projector is turned on.

Problem: Projector is running, but nothing appears on projection screen.

- Make sure you have removed the lens cap on the projection lens at the front of the projector.
- Check the projector lamp to ensure that it is securely connected in the lamp module. See “Replacing the projection lamp” on page 27.

Problem: Only the start-up screen displays.

- Verify that the cables are connected correctly. See for “Connecting a computer to the projector” on page 4 for connection procedures.
- Make sure that the cables do not have any bent pins.
- Verify that the proper input source is connected. See “SourceSearch” on page 18 to set the projector to automatically detect the type of equipment you are using.
- You might need to turn off all of your equipment, then turn on everything again in the proper order. Refer to your computer documentation to determine the correct order.
- Make sure the computer external video port is active. See Appendix C, “Portable and mobile computer activation” on page 33 for some common keyboard commands, or your computer manual for details.
- Make sure your computer video adapter is installed and configured correctly.
- Make sure your computer has a compatible video adapter. This projector is not CGA or EGA compatible.

If you are using Windows 98:

1. Click **My Computer** → **Control Panel** → **Display**.
2. Click the **Settings** tab.
3. Verify that the Desktop resolution is set to **1280 x1024** or less.

Problem: Color or text not visible on the projection screen.

Try adjusting the brightness or contrast until the text is visible. To adjust the brightness or contrast, see “Basic menu” on page 12 for more information.

Problem: The screen resolution is not correct.

- Make sure the computer video adapter is set for a resolution of no greater than 1280 x 1024.

Problem: Image is not centered on the screen.

- Move the projector to reposition the image.
- Reposition the image using the menu. See “Adjusting the image” on page 9.
- Be sure the projector is at a 90-degree angle to the screen.

Problem: Image is too wide or narrow for screen.

- Adjust the zoom or projector placement.
- Adjust the resolution of your video adapter if it is greater than 1280 x 1024.
- Use the Keystone button on the projector keypad, or the Keystone option on the Basic on-screen menu to adjust the angles of the projected image.

Problem: Image is out of focus.

- Turn the focus ring to focus the image.
- Make sure the projection screen is at least 1.5 m (5 feet) from the projector.
- Check the projection lens to see if it needs cleaning.

Problem: Image and menus are reversed left to right.

- Rear projection mode might be activated. Turn off Rear projection. See “Rear” on page 18.

Problem: The image is streaked.

- Perform a factory reset. See “Service menu” on page 21.

Problem: Projected colors don’t match the computer or video player color.

Just as there are differences in the displays of different monitors, there are often differences between the computer image and the projected image. Adjust the brightness, tint, and contrast from the on-screen Picture menu. See “Picture menu” on page 16.

Problem: Lamp seems to be getting dimmer.

The lamp loses brightness when it has been in use for a long time. Check the lamp timer by using the Replace the lamp as described in “Replacing the projection lamp” on page 27.

Problem: The lamp shuts off.

- A minor power surge might cause the lamp to shut off. Disconnect the projector, wait at least a minute, then reconnect it.
- The projector has overheated. Make sure that the projector vents are not blocked. Cool the projector with the fan for five minutes, then turn on the lamp again.

Adding security

Use the security connector with a separately available loop cable. Go to <http://www.compu-lock.com> on the World Wide Web for ordering information.

See the detailed projector illustration starting with “Unpacking the projector” on page 1 for the location of the projector security connector. Refer to the information that comes with the cable for instructions on how to secure it to the projector.

Note: The lamp cannot be removed while the cable is attached.

Appendix C. Portable and mobile computer activation

Many mobile computers do not automatically turn on their external video port when a projector is connected. Activation commands for some mobile computers are listed in the following table. (If your computer is not listed or the given command does not work, refer to the computer documentation for the appropriate command.) On many mobile computers, the activation function key is labeled CRT/LCD or with an icon such as:



Note: Visit <http://www.infocus.com/> for the most current activation chart. It is located in the Service and Support link.

Note: Usually, pressing the key commands once activates the external video port, pressing it again activates both external and internal ports, and pressing it a third time activates the internal port. Refer to your computer documentation for details on your specific model.

Computer	Key command to activate port	Key command to deactivate port
Acer	Ctrl+Alt+Esc (for setup)	Ctrl+Alt+Esc (for setup)
AST* **	FN+D or Ctrl+D Ctrl+FN+D FN+F5 type from A:\IVGA\CRT FN+F12	FN+D or Ctrl+D Ctrl+FN+D FN+F5 type from A:\IVGACRT FN+F12
AMS	FN+F2	FN+F2
AMT	setup screen	setup screen
AT&T	FN+F3 FN+F6	FN+F3 F+-F6
Advanced Logic Research	Ctrl+Alt+V	Ctrl+Alt+V
Altima	Shift-Ctrl-Alt-C setup VGA/Conf.Simulscan	Shift-Ctrl-Alt-L setup VGA/Conf.Simulscan
Ambra**	FN-F12 FN-F5 F2/Choose Option/F5	FN-F12 FN-F5 F2/Choose Option/F5
Amrel* **	setup menu Shift-Ctrl-D	setup menu Shift-Ctrl-D
Apple	see Mac Portable and Mac PowerBook	
Aspen	automatic	automatic
Award	FN-F6	FN-F6
BCC*	automatic	reboot computer
Bondwell	LCD or CRT options after bootup	reboot for LCD or CRT options to appear
Chaplet**	setup screen FN-F6 FN-F4	setup screen FN-F6 FN-F4
Chembook	FN-F6	FN-F6
Commax	Ctrl-Alt-#6	Ctrl-Alt-#5
Compaq* **	Ctrl-Alt-< FN-F4 automatic mode/? (for setup option)	Ctrl-Alt-> FN-F4 automatic mode/? (for setup option)
Compuadd* **	automatic Alt-F for screen setup option	automatic Alt-F for screen setup option

Computer	Key command to activate port	Key command to deactivate port
Data General	Ctrl-Alt-Command	Ctrl-Alt-Command
Data General Walkabout	2 CRT/X at DOS prompt	restart
Datavue	Ctrl-Shift-M	Ctrl-Shift-M
DEC**	FN-F5	FN-F5
	FN-F4	FN-F4
Dell**	Ctrl-Alt-<	Ctrl-Alt->
	Ctrl-Alt-F10	Ctrl-Alt-F10
	FN-F8 (CRT/LCD)	FN-F8
	FN-D	FN-D
	FN-F12	FN-F12
Digital*	automatic	reboot
	FN-F2	FN-F2
Dolch	dip switch to CRT	dip switch to LCD
Epson	dip switch to CRT	dip switch to LCD
Everex*	setup screen option	setup screen option
For-A	Ctrl-Alt-Shift-C	Ctrl-Shift-Alt-L
Fujitsu	FN-F10	
Gateway	FN-F3 FN-F1/FN-F1 again simultaneous	FN-F3 FN-F1
Grid* **	FN-F2, select auto or simultaneous	FN-F2
	Ctrl-Alt-Tab	Ctrl-Alt-Tab
Hitachi	FN-F7	FN-F7
Honeywell	FN-F10	FN-F10
Hyundai	setup screen option	setup screen option
IBM 970*	automatic	warm restart
IBM ThinkPad**	reboot, enter setup menu	FN-F2
	FN-F7, select choice from setup menu	
	FN-F1, select choice	
	FN-F5, select choice	
	PS/2 SC select choice (such as CRT, LCD)	
Infotel	FN-F12	FN-F12
Kaypro	start up, monitor plugged in	unplug monitor
Kris Tech	FN-F8	FN-F8
Leading Edge	FN-T	FN-T
Mac Portable 100	no video port; not compatible	
Mac PowerBook		
140, 145, 150, 170	no video port; requires a third-party interface	
160, 165, 180, 520, 540, 5300	Control Panel folder, PowerBook	warm restart
	Display folder; Activate Video	
	Mirroring	
210, 230, 250, 270, 280, 2300	requires Apple Docking Station or Mini Dock	
Magitronic	FN-F4	FN-F4
Mastersport	FN-F2	FN-F1
Micro Express*	automatic	warm restart
Micron	FN-F2	FN-F2
Microslate*	automatic	warm restart
Mitsubishi	SW2 On-Off-Off-Off	SW2 Off-On-On-On
NCR	setup screen option	setup screen option
NEC* **	setup screen option	setup screen option
	CRT at the DOS prompt	LCD at the DOS prompt
	FN-F3	FN-F3
Olivetti*	automatic	automatic
	FN-O/*	FN-O/*

Computer	Key command to activate port	Key command to deactivate port
Packard Bell* **	FN-F0 Ctrl-Alt-<	FN-F0 Ctrl-Alt->
Panasonic	FN-F2	FN-F2
Prostar	Ctrl-Alt-S at startup	Ctrl-Alt-S at startup
Samsung*	setup screen option	setup screen option
Sanyo	setup screen option	setup screen option
Sharp	dip switch to CRT	dip switch to LCD
Sun SPARC-Dataview	Ctrl-Shift-M	Ctrl-Shift-M
Tandy**	Ctrl-Alt-Insert setup screen option	Ctrl-Alt-Insert setup screen option
Tangent	FN-F5	FN-F5
Texas Instruments*	setup screen option	setup screen option
Top-Link* **	setup screen option FN-F6	setup screen option FN-F6
Toshiba* **	Ctrl-Alt-End FN-End FN-F5 setup screen option	Ctrl-Alt-Home FN-Home FN-F5 setup screen option
Twinhead*	FN-F7 FN-F5 automatic	FN-F7 FN-F5 automatic
WinBook	Ctrl-Alt-F10	Ctrl-Alt-F10
Wyse	software driven	software driven
Zenith**	FN-F10 FN-F2 FN-F1	FN-F10 FN-F2 FN-F1
Zeos **	Ctrl-Shift-D FN-F1	Ctrl-Shift-D FN-F1

* These manufacturers have models that automatically send video to the external CRT port when some type of display device is attached.

** These manufacturers offer more than one key command depending on the computer model.

Appendix D. Using video mirroring

Using video mirroring with a PowerBook computer

When you turn on video mirroring (called SimulScan in newer PowerBook computers), the projector displays the same information that appears on a PowerBook built-in screen. When video mirroring is off, the projector operates like a separate display.

To turn on video mirroring for the first time:

1. Open the Monitors control panel; click **Monitor 2**.
2. Set the number of colors that you want.
3. Open the Control Strip, and then click the monitor icon.
4. Select **Turn Video Mirroring On**.

Now you can turn video mirroring on and off from the Control Strip without having to open the monitor control panel again. When using video mirroring and high-color graphics such as slide shows, the projected image occasionally might turn black and white. If this happens, perform the following steps:

1. Turn off video mirroring.
2. Open the monitor control panel.
3. Move the white menu bar to **Monitor 2** to set the projector as the primary monitor.
4. Restart the PowerBook computer.

Using Simulscan

Some newer PowerBook computers display images on an external monitor or projector differently than previous ones. When using SimulScan, the projector displays the same information that appears on your PowerBook computer. To select SimulScan:

1. Open the Control Panel, and then double-click **Monitors** and **Sound**.
2. In the Resolution list, select the SimulScan mode, and then click **OK**.
3. If this changes your display settings, a window opens. Click **OK** to confirm the change.

Appendix E. Projected image size

Use the following graph and table to help you determine projected image sizes.

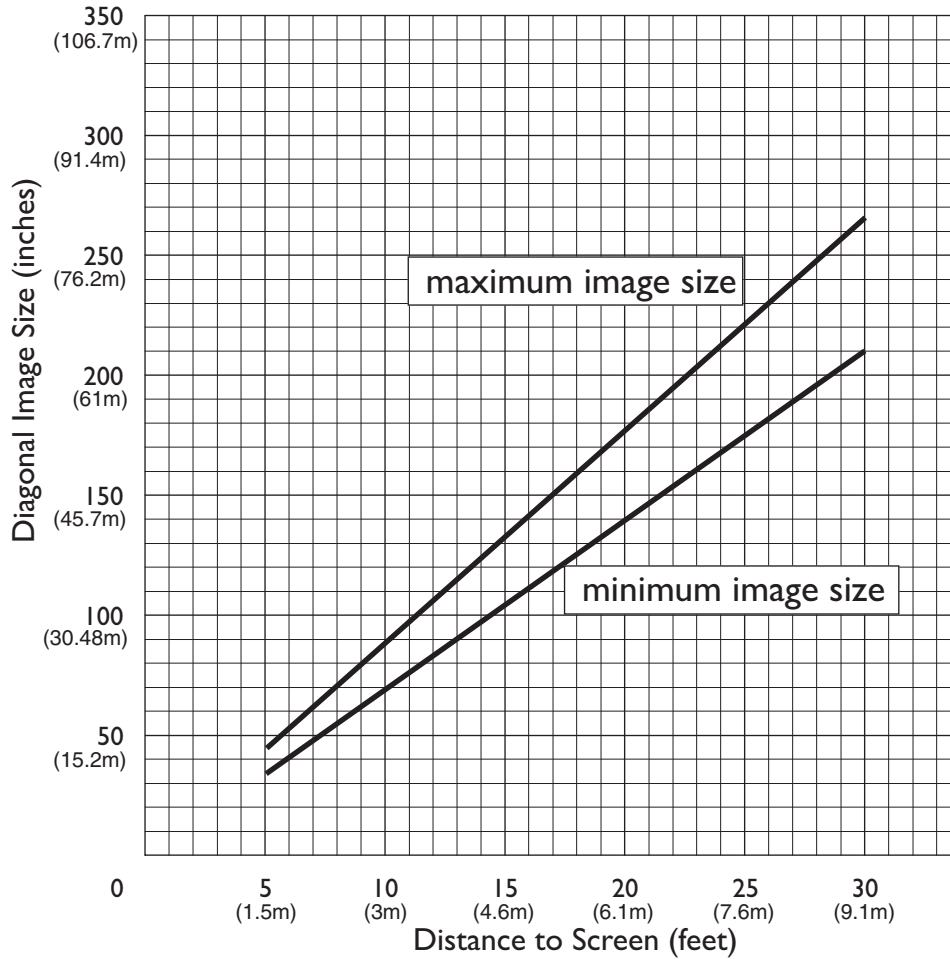

Table 1. Image size, width and height-maximum image size

Diagonal image size	Image width	Maximum distance	Minimum distance
152.4 c (60 in)	121.9 c (48 in)	2.59 m (8.5 ft.)	2.10 m (6.9 ft.)
183 c (72 in)	147.3 c (58 in)	3.1 m (10.2 ft.)	2.53 m (8.3 ft.)
213.4 c (84 in)	170 c (67 in)	3.62 m(11.9 ft.)	2.95 m (9.7 ft.)
229.6 c (90 in)	182.48 c (72 in)	3.87 m (12.7 ft.)	3.13 m (10.4 ft.)
254 c (100 in)	203.2 c (80 in)	4.29 m (14.1 ft.)	3.53 m (11.6 ft.)
304.8 c (120 in)	243.8 c (96 in)	5.18 m (17.0 ft.)	4.23 m (13.9 ft.)
381 c (150 in)	304.8 c (120 in)	6.46 m (21.2 ft.)	5.3 m (17.4 ft.)

Appendix F. Warranty information

This section contains the warranty period for your product, information about obtaining warranty service and support, and the IBM Statement of Limited Warranty.

Warranty period

Contact your place of purchase for warranty service information. Some IBM Machines are eligible for on-site warranty service depending on the country or region where service is performed.

Machine - IBM iLM300 MicroPortable Projector

Warranty period - Three years

Machine - IBM iLM300 MicroPortable Projector Lamp module

Warranty period - Three months

Replacement lamps

During the warranty period, order replacement lamps by calling the IBM HelpCenter. See “Telephone technical support” on page 42. Request Part Number 33L3456.

After the warranty period, order replacement lamps (Part Number 33L3456) from IBM using the World Wide Web. The Web site address is <http://www.pc.ibm.com/us/accessories/projectors/index.html>.

Service and support

The following information describes the technical support that is available for your product, during the warranty period or throughout the life of the product. Refer to your IBM Statement of Limited Warranty for a full explanation of IBM warranty terms.

Warranty information on the World Wide Web

The IBM Machine Warranties Web site at http://www.ibm.com/servers/support/machine_warranties/ contains a worldwide overview of the IBM Limited Warranty for IBM Machines, a glossary of terms used in the Statement of Limited Warranty, Frequently Asked Questions (FAQ), and links to Product Support Web pages. The IBM Statement of Limited Warranty is available from this Web site in 29 languages in Portable Document Format (PDF).

Online technical support

Online technical support is available during the life of your product through the Personal Computing Support Web site at <http://www.ibm.com/pc/support/>.

During the warranty period, assistance for replacement or exchange of defective components is available. In addition, if your IBM option is installed in an IBM computer, you might be entitled to service at your location. Your technical support representative can help you determine the best alternative.

Telephone technical support

Installation and configuration support through the IBM HelpCenter® will be withdrawn or made available for a fee, at IBM's discretion, 90 days after the option has been withdrawn from marketing. Additional support offerings, including step-by-step installation assistance, are available for a nominal fee.

To assist the technical support representative, have available as much of the following information as possible:

- Option name
- Option number
- Proof of purchase
- Computer manufacturer, model, serial number (if IBM), and manual
- Exact wording of the error message (if any)
- Description of the problem
- Hardware and software configuration information for your system

If possible, be at your computer. Your technical support representative might want to walk you through the problem during the call.

For the support telephone number and support hours by country, refer to the following table. If the number for your country or region is not listed, contact your IBM reseller or IBM marketing representative. Response time may vary depending on the number and nature of the calls received.

Support 24 hours a day, 7 days a week	
Canada (Toronto only)	416-383-3344
Canada (all other)	1-800-565-3344
U.S.A. and Puerto Rico	1-800-772-2227
All other countries and regions	Go to http://www.ibm.com/pc/support/ , and click Support Phone List .

IBM Statement of Limited Warranty Z125-4753-06 8/2000

Part 1 - General Terms

This Statement of Limited Warranty includes Part 1 - General Terms and Part 2 - Country-unique Terms. The terms of Part 2 replace or modify those of Part 1. The warranties provided by IBM in this Statement of Limited Warranty apply only to Machines you purchase for your use, and not for resale, from IBM or your reseller. The term "Machine" means an IBM machine, its features, conversions, upgrades, elements, or accessories, or any combination of them. The term "Machine" does not include any software programs, whether pre-loaded with the Machine, installed subsequently or otherwise. Unless IBM specifies otherwise, the following warranties apply only in the country where you acquire the Machine. Nothing in this Statement of Limited Warranty affects any statutory rights of consumers that cannot be waived or limited by contract. If you have any questions, contact IBM or your reseller.

The IBM Warranty for Machines: IBM warrants that each Machine 1) is free from defects in materials and workmanship and 2) conforms to IBM's Official Published Specifications ("Specifications"). The warranty period for a Machine is a specified, fixed period commencing on its Date of Installation. The date on your sales receipt is the Date of Installation unless IBM or your reseller informs you otherwise.

If a Machine does not function as warranted during the warranty period, and IBM or your reseller are unable to either 1) make it do so or 2) replace it with one that is at least functionally equivalent, you may return it to your place of purchase and your money will be refunded.

Extent of Warranty: The warranty does not cover the repair or exchange of a Machine resulting from misuse, accident, modification, unsuitable physical or operating environment, improper maintenance by you, or failure caused by a product for which IBM is not responsible. The warranty is voided by removal or alteration of Machine or parts identification labels.

THESE WARRANTIES ARE YOUR EXCLUSIVE WARRANTIES AND REPLACE ALL OTHER WARRANTIES OR CONDITIONS, EXPRESS OR IMPLIED, INCLUDING, BUT NOT LIMITED TO, THE IMPLIED WARRANTIES OR CONDITIONS OF MERCHANTABILITY AND FITNESS FOR A PARTICULAR PURPOSE. THESE WARRANTIES GIVE YOU SPECIFIC LEGAL RIGHTS AND YOU MAY ALSO HAVE OTHER RIGHTS WHICH VARY FROM JURISDICTION TO JURISDICTION. SOME JURISDICTIONS DO NOT ALLOW THE EXCLUSION OR LIMITATION OF EXPRESS OR IMPLIED WARRANTIES, SO THE ABOVE EXCLUSION OR LIMITATION MAY NOT APPLY TO YOU. IN THAT EVENT, SUCH WARRANTIES ARE LIMITED IN DURATION TO THE WARRANTY PERIOD. NO WARRANTIES APPLY AFTER THAT PERIOD.

Items Not Covered by Warranty: IBM does not warrant uninterrupted or error-free operation of a Machine. Any technical or other support provided for a Machine under warranty, such as assistance via telephone with "how-to" questions and those regarding Machine set-up and installation, will be provided **WITHOUT WARRANTIES OF ANY KIND.**

Warranty Service: To obtain warranty service for a Machine, contact IBM or your reseller. If you do not register your Machine with IBM, you may be required to present proof of purchase.

During the warranty period, IBM or your reseller, if approved by IBM to provide warranty service, provides without charge certain types of repair and exchange service to keep Machines in, or restore them to, conformance with their Specifications. IBM or your reseller will inform you of the available types of service for a Machine based on its country of installation. At its discretion, IBM or your reseller will 1) either repair or exchange the failing Machine and 2) provide the service either at your location or a service center. IBM or your reseller will also manage and install selected engineering changes that apply to the Machine.

Some parts of IBM Machines are designated as Customer Replaceable Units (called "CRUs"), e.g., keyboards, memory, or hard disk drives. IBM ships CRUs to you for replacement by you. You must

return all defective CRUs to IBM within 30 days of your receipt of the replacement CRU. You are responsible for downloading designated Machine Code and Licensed Internal Code updates from an IBM Internet Web site or from other electronic media, and following the instructions that IBM provides.

When warranty service involves the exchange of a Machine or part, the item IBM or your reseller replaces becomes its property and the replacement becomes yours. You represent that all removed items are genuine and unaltered. The replacement may not be new, but will be in good working order and at least functionally equivalent to the item replaced. The replacement assumes the warranty service status of the replaced item. Many features, conversions, or upgrades involve the removal of parts and their return to IBM. A part that replaces a removed part will assume the warranty service status of the removed part.

Before IBM or your reseller exchanges a Machine or part, you agree to remove all features, parts, options, alterations, and attachments not under warranty service.

You also agree to

1. ensure that the Machine is free of any legal obligations or restrictions that prevent its exchange;
2. obtain authorization from the owner to have IBM or your reseller service a Machine that you do not own; and
3. where applicable, before service is provided:
 - a. follow the problem determination, problem analysis, and service request procedures that IBM or your reseller provides;
 - b. secure all programs, data, and funds contained in a Machine;
 - c. provide IBM or your reseller with sufficient, free, and safe access to your facilities to permit them to fulfill their obligations; and
 - d. inform IBM or your reseller of changes in a Machine's location.

IBM is responsible for loss of, or damage to, your Machine while it is 1) in IBM's possession or 2) in transit in those cases where IBM is responsible for the transportation charges.

Neither IBM nor your reseller is responsible for any of your confidential, proprietary or personal information contained in a Machine which you return to IBM or your reseller for any reason. You should remove all such information from the Machine prior to its return.

Limitation of Liability: Circumstances may arise where, because of a default on IBM's part or other liability, you are entitled to recover damages from IBM. In each such instance, regardless of the basis on which you are entitled to claim damages from IBM (including fundamental breach, negligence, misrepresentation, or other contract or tort claim), except for any liability that cannot be waived or limited by applicable laws, IBM is liable for no more than

1. damages for bodily injury (including death) and damage to real property and tangible personal property; and
2. the amount of any other actual direct damages, up to the charges (if recurring, 12 months' charges apply) for the Machine that is subject of the claim. For purposes of this item, the term "Machine" includes Machine Code and Licensed Internal Code.

This limit also applies to IBM's suppliers and your reseller. It is the maximum for which IBM, its suppliers, and your reseller are collectively responsible.

UNDER NO CIRCUMSTANCES IS IBM LIABLE FOR ANY OF THE FOLLOWING: 1) THIRD-PARTY CLAIMS AGAINST YOU FOR DAMAGES (OTHER THAN THOSE UNDER THE FIRST ITEM LISTED ABOVE); 2) LOSS OF, OR DAMAGE TO, YOUR RECORDS OR DATA; OR 3) SPECIAL, INCIDENTAL, OR INDIRECT DAMAGES OR FOR ANY ECONOMIC CONSEQUENTIAL DAMAGES, LOST PROFITS OR LOST SAVINGS, EVEN IF IBM, ITS SUPPLIERS OR YOUR RESELLER IS INFORMED OF THEIR POSSIBILITY. SOME JURISDICTIONS DO NOT ALLOW THE EXCLUSION OR LIMITATION OF INCIDENTAL OR CONSEQUENTIAL DAMAGES, SO THE ABOVE LIMITATION OR EXCLUSION MAY NOT APPLY TO YOU.

Governing Law: Both you and IBM consent to the application of the laws of the country in which you acquired the Machine to govern, interpret, and enforce all of your and IBM's rights, duties, and obligations arising from, or relating in any manner to, the subject matter of this Agreement, without regard to conflict of law principles.

Part 2 - Country-unique Terms

AMERICAS

BRAZIL

Governing Law: *The following is added after the first sentence:*

Any litigation arising from this Agreement will be settled exclusively by the court of Rio de Janeiro.

NORTH AMERICA

Warranty Service: *The following is added to this Section:*

To obtain warranty service from IBM in Canada or the United States, call 1-800-IBM-SERV (426-7378).

CANADA

Governing Law: *The following replaces "laws of the country in which you acquired the Machine" in the first sentence:*

laws in the Province of Ontario.

UNITED STATES

Governing Law: *The following replaces "laws of the country in which you acquired the Machine" in the first sentence:*

laws of the State of New York.

ASIA PACIFIC

AUSTRALIA

The IBM Warranty for Machines: *The following paragraph is added to this Section:*

The warranties specified in this Section are in addition to any rights you may have under the Trade Practices Act 1974 or other similar legislation and are only limited to the extent permitted by the applicable legislation.

Limitation of Liability: *The following is added to this Section:*

Where IBM is in breach of a condition or warranty implied by the Trade Practices Act 1974 or other similar legislation, IBM's liability is limited to the repair or replacement of the goods or the supply of equivalent goods. Where that condition or warranty relates to right to sell, quiet possession or clear title, or the goods are of a kind ordinarily acquired for personal, domestic or household use or consumption, then none of the limitations in this paragraph apply.

Governing Law: *The following replaces "laws of the country in which you acquired the Machine" in the first sentence:*

laws of the State or Territory.

CAMBODIA, LAOS, AND VIETNAM

Governing Law: *The following replaces "laws of the country in which you acquired the Machine" in the first sentence:*

laws of the State of New York.

The following is added to this Section:

Disputes and differences arising out of or in connection with this Agreement shall be finally settled by arbitration which shall be held in Singapore in accordance with the rules of the International Chamber of Commerce (ICC). The arbitrator or arbitrators designated in conformity with those rules shall have the power to rule on their own competence and on the validity of the Agreement to submit to arbitration. The arbitration award shall be final and binding for the parties without appeal and the arbitral award shall be in writing and set forth the findings of fact and the conclusions of law.

All proceedings shall be conducted, including all documents presented in such proceedings, in the English language. The number of arbitrators shall be three, with each side to the dispute being entitled to appoint one arbitrator.

The two arbitrators appointed by the parties shall appoint a third arbitrator before proceeding upon the reference. The third arbitrator shall act as chairman of the proceedings. Vacancies in the post of chairman shall be filled by the president of the ICC. Other vacancies shall be filled by the respective nominating party. Proceedings shall continue from the stage they were at when the vacancy occurred.

If one of the parties refuses or otherwise fails to appoint an arbitrator within 30 days of the date the other party appoints its, the first appointed arbitrator shall be the sole arbitrator, provided that the arbitrator was validly and properly appointed.

The English language version of this Agreement prevails over any other language version.

HONG KONG AND MACAU

Governing Law: *The following replaces "laws of the country in which you acquired the Machine" in the first sentence:*

laws of Hong Kong Special Administrative Region.

INDIA

Limitation of Liability: *The following replaces items 1 and 2 of this Section:*

1. liability for bodily injury (including death) or damage to real property and tangible personal property will be limited to that caused by IBM's negligence;
2. as to any other actual damage arising in any situation involving nonperformance by IBM pursuant to, or in any way related to the subject of this Statement of Limited Warranty, IBM's liability will be limited to the charge paid by you for the individual Machine that is the subject of the claim.

JAPAN

Governing Law: *The following sentence is added to this Section:*

Any doubts concerning this Agreement will be initially resolved between us in good faith and in accordance with the principle of mutual trust.

NEW ZEALAND

The IBM Warranty for Machines: *The following paragraph is added to this Section:*

The warranties specified in this Section are in addition to any rights you may have under the Consumer Guarantees Act 1993 or other legislation which cannot be excluded or limited. The Consumer Guarantees Act 1993 will not apply in respect of any goods which IBM provides, if you require the goods for the purposes of a business as defined in that Act.

Limitation of Liability: *The following is added to this Section:*

Where Machines are not acquired for the purposes of a business as defined in the Consumer Guarantees Act 1993, the limitations in this Section are subject to the limitations in that Act.

PEOPLE'S REPUBLIC OF CHINA (PRC)

Governing Law: *The following replaces this Section:*

Both you and IBM consent to the application of the laws of the State of New York (except when local law requires otherwise) to govern, interpret, and enforce all your and IBM's rights, duties, and obligations arising from, or relating in any manner to, the subject matter of this Agreement, without regard to conflict of law principles.

Any disputes arising from or in connection with this Agreement will first be resolved by friendly negotiations, failing which either of us has the right to submit the dispute to the China International Economic and Trade Arbitration Commission in Beijing, the PRC, for arbitration in accordance with its arbitration rules in force at the time. The arbitration tribunal will consist of three arbitrators. The language to be used therein will be English and Chinese. An arbitral award will be final and binding on all the parties, and will be enforceable under the Convention on the Recognition and Enforcement of Foreign Arbitral Awards (1958).

The arbitration fee will be borne by the losing party unless otherwise determined by the arbitral award.

During the course of arbitration, this Agreement will continue to be performed except for the part which the parties are disputing and which is undergoing arbitration.

EUROPE, MIDDLE EAST, AFRICA (EMEA)

THE FOLLOWING TERMS APPLY TO ALL EMEA COUNTRIES:

The terms of this Statement of Limited Warranty apply to Machines purchased from IBM or an IBM reseller.

Warranty Service: If you purchase an IBM Machine in Austria, Belgium, Denmark, Estonia, Finland, France, Germany, Greece, Iceland, Ireland, Italy, Latvia, Lithuania, Luxembourg, Netherlands, Norway, Portugal, Spain, Sweden, Switzerland or United Kingdom, you may obtain warranty service for that Machine in any of those countries from either (1) an IBM reseller approved to perform warranty service or (2) from IBM. If you purchase an IBM Personal Computer Machine in Albania, Armenia, Belarus, Bosnia and Herzegovina, Bulgaria, Croatia, Czech Republic, Georgia, Hungary, Kazakhstan, Kirghizia, Federal Republic of Yugoslavia, Former Yugoslav Republic of Macedonia (FYROM), Moldova, Poland, Romania, Russia, Slovak Republic, Slovenia, or Ukraine, you may obtain warranty service for that Machine in any of those countries from either (1) an IBM reseller approved to perform warranty service or (2) from IBM.

If you purchase an IBM Machine in a Middle Eastern or African country, you may obtain warranty service for that Machine from the IBM entity within the country of purchase, if that IBM entity provides warranty service in that country, or from an IBM reseller, approved by IBM to perform warranty service on that Machine in that country. Warranty service in Africa is available within 50 kilometers of an IBM authorized service provider. You are responsible for transportation costs for Machines located outside 50 kilometers of an IBM authorized service provider.

Governing Law: The applicable laws that govern, interpret and enforce rights, duties, and obligations of each of us arising from, or relating in any manner to, the subject matter of this Statement, without regard to conflict of laws principles, as well as Country-unique terms and competent court for this Statement are those of the country in which the warranty service is being provided, except that in 1) Albania, Bosnia-Herzegovina, Bulgaria, Croatia, Hungary, Former Yugoslav Republic of Macedonia, Romania, Slovakia, Slovenia, Armenia, Azerbaijan, Belarus, Georgia, Kazakhstan, Kyrgyzstan, Moldova, Russia, Tajikistan, Turkmenistan, Ukraine, and Uzbekistan, the laws of Austria apply; 2) Estonia, Latvia, and Lithuania, the laws of Finland apply; 3) Algeria, Benin, Burkina Faso, Cameroon, Cape Verde, Central African Republic, Chad, Congo, Djibouti, Democratic Republic of Congo, Equatorial Guinea, France, Gabon, Gambia, Guinea, Guinea-Bissau, Ivory Coast, Lebanon, Mali, Mauritania, Morocco, Niger, Senegal, Togo, and Tunisia, this Agreement will be construed and the legal relations between the parties will be

determined in accordance with the French laws and all disputes arising out of this Agreement or related to its violation or execution, including summary proceedings, will be settled exclusively by the Commercial Court of Paris; 4) Angola, Bahrain, Botswana, Burundi, Egypt, Eritrea, Ethiopia, Ghana, Jordan, Kenya, Kuwait, Liberia, Malawi, Malta, Mozambique, Nigeria, Oman, Pakistan, Qatar, Rwanda, Sao Tome, Saudi Arabia, Sierra Leone, Somalia, Tanzania, Uganda, United Arab Emirates, United Kingdom, West Bank/Gaza, Yemen, Zambia, and Zimbabwe, this Agreement will be governed by English Law and disputes relating to it will be submitted to the exclusive jurisdiction of the English courts; and 5) in Greece, Israel, Italy, Portugal, and Spain any legal claim arising out of this Statement will be brought before, and finally settled by, the competent court of Athens, Tel Aviv, Milan, Lisbon, and Madrid, respectively.

THE FOLLOWING TERMS APPLY TO THE COUNTRY SPECIFIED:

AUSTRIA AND GERMANY

The IBM Warranty for Machines: *The following replaces the first sentence of the first paragraph of this Section:* The warranty for an IBM Machine covers the functionality of the Machine for its normal use and the Machine's conformity to its Specifications.

The following paragraphs are added to this Section:

The minimum warranty period for Machines is six months. In case IBM or your reseller is unable to repair an IBM Machine, you can alternatively ask for a partial refund as far as justified by the reduced value of the unrepaired Machine or ask for a cancellation of the respective agreement for such Machine and get your money refunded.

Extent of Warranty: *The second paragraph does not apply.*

Warranty Service: *The following is added to this Section:*

During the warranty period, transportation for delivery of the failing Machine to IBM will be at IBM's expense.

Limitation of Liability: *The following paragraph is added to this Section:*

The limitations and exclusions specified in the Statement of Limited Warranty will not apply to damages caused by IBM with fraud or gross negligence and for express warranty.

The following sentence is added to the end of item 2:

IBM's liability under this item is limited to the violation of essential contractual terms in cases of ordinary negligence.

EGYPT

Limitation of Liability: *The following replaces item 2 in this Section:*

as to any other actual direct damages, IBM's liability will be limited to the total amount you paid for the Machine that is the subject of the claim. For purposes of this item, the term "Machine" includes Machine Code and Licensed Internal Code.

Applicability of suppliers and resellers (unchanged).

FRANCE

Limitation of Liability: *The following replaces the second sentence of the first paragraph of this Section:*

In such instances, regardless of the basis on which you are entitled to claim damages from IBM, IBM is liable for no more than: *(items 1 and 2 unchanged).*

IRELAND

Extent of Warranty: *The following is added to this Section:*

Except as expressly provided in these terms and conditions, all statutory conditions, including all warranties implied, but without prejudice to the generality of the foregoing all warranties implied by the Sale of Goods Act 1893 or the Sale of Goods and Supply of Services Act 1980 are hereby excluded.

Limitation of Liability: *The following replaces items one and two of the first paragraph of this Section:*

1. death or personal injury or physical damage to your real property solely caused by IBM's negligence; and
2. the amount of any other actual direct damages, up to 125 percent of the charges (if recurring, the 12 months' charges apply) for the Machine that is the subject of the claim or which otherwise gives rise to the claim.

Applicability of suppliers and resellers (unchanged).

The following paragraph is added at the end of this Section:

IBM's entire liability and your sole remedy, whether in contract or in tort, in respect of any default shall be limited to damages.

ITALY

Limitation of Liability: *The following replaces the second sentence in the first paragraph:*

In each such instance unless otherwise provided by mandatory law, IBM is liable for no more than:

1. *(unchanged)*
2. as to any other actual damage arising in all situations involving nonperformance by IBM pursuant to, or in any way related to the subject matter of this Statement of Warranty, IBM's liability, will be limited to the total amount you paid for the Machine that is the subject of the claim.

Applicability of suppliers and resellers (unchanged).

The following replaces the third paragraph of this Section:

Unless otherwise provided by mandatory law, IBM and your reseller are not liable for any of the following: *(items 1 and 2 unchanged)* 3) indirect damages, even if IBM or your reseller is informed of their possibility.

SOUTH AFRICA, NAMIBIA, BOTSWANA, LESOTHO AND SWAZILAND

Limitation of Liability: *The following is added to this Section:*

IBM's entire liability to you for actual damages arising in all situations involving nonperformance by IBM in respect of the subject matter of this Statement of Warranty will be limited to the charge paid by you for the individual Machine that is the subject of your claim from IBM.

UNITED KINGDOM

Limitation of Liability: *The following replaces items 1 and 2 of the first paragraph of this Section:*

1. death or personal injury or physical damage to your real property solely caused by IBM's negligence;
2. the amount of any other actual direct damages or loss, up to 125 percent of the charges (if recurring, the 12 months' charges apply) for the Machine that is the subject of the claim or which otherwise gives rise to the claim;

The following item is added to this paragraph:

3. breach of IBM's obligations implied by Section 12 of the Sale of Goods Act 1979 or Section 2 of the Supply of Goods and Services Act 1982.

Applicability of suppliers and resellers (unchanged).

The following is added to the end of this Section:

IBM's entire liability and your sole remedy, whether in contract or in tort, in respect of any default shall be limited to damages.

Appendix G. Notices

IBM may not offer the products, services, or features discussed in this document in all countries. Consult your local IBM representative for information on the products and services currently available in your area. Any reference to an IBM product, program, or service is not intended to state or imply that only that IBM product, program, or service may be used. Any functionally equivalent product, program, or service that does not infringe any IBM intellectual property right may be used instead. However, it is the user's responsibility to evaluate and verify the operation of any non-IBM product, program, or service.

IBM may have patents or pending patent applications covering subject matter described in this document. The furnishing of this document does not give you any license to these patents. You can send license inquiries, in writing, to:

IBM Director of Licensing
IBM Corporation
North Castle Drive
Armonk, NY 10504-1785
U.S.A.

INTERNATIONAL BUSINESS MACHINES CORPORATION PROVIDES THIS PUBLICATION "AS IS" WITHOUT WARRANTY OF ANY KIND, EITHER EXPRESS OR IMPLIED, INCLUDING, BUT NOT LIMITED TO, THE IMPLIED WARRANTIES OF NON-INFRINGEMENT, MERCHANTABILITY OR FITNESS FOR A PARTICULAR PURPOSE. Some jurisdictions do not allow disclaimer of express or implied warranties in certain transactions, therefore, this statement may not apply to you.

This information could include technical inaccuracies or typographical errors. Changes are periodically made to the information herein; these changes will be incorporated in new editions of the publication. IBM may make improvements and/or changes in the product(s) and/or the program(s) described in this publication at any time without notice.

IBM may use or distribute any of the information you supply in any way it believes appropriate without incurring any obligation to you.

Any references in this publication to non-IBM Web sites are provided for convenience only and do not in any manner serve as an endorsement of those Web sites. The materials at those Web sites are not part of the materials for this IBM product, and use of those Web sites is at your own risk.

Any performance data contained herein was determined in a controlled environment. Therefore, the result obtained in other operating environments may vary significantly. Some measurements may have been made on development-level systems and there is no guarantee that these measurements will be the same on generally available systems. Furthermore, some measurements may have been estimated through extrapolation. Actual results may vary. Users of this document should verify the applicable data for their specific environment.

Trademarks

The following terms are trademarks of the IBM Corporation in the United States or other countries or both:

IBM
HelpCenter

Microsoft, PowerPoint and Windows are trademarks or registered trademarks of Microsoft in the United States or other countries or both.

Other company, product, and service names may be trademarks or service marks of others.

Federal Communications Commission (FCC) statement

Note: This equipment has been tested and found to comply with the limits for a Class A digital device, pursuant to Part 15 of the FCC Rules. These limits are designed to provide reasonable protection against harmful interference when the equipment is operated in a commercial environment. This equipment generates, uses, and can radiate radio frequency energy and, if not installed and used in accordance with the instruction manual, may cause harmful interference to radio communications. Operation of this equipment in a residential area is likely to cause harmful interference, in which case the user will be required to correct the interference at his own expense.

Properly shielded and grounded cables and connectors must be used in order to meet FCC emission limits. IBM is not responsible for any radio or television interference caused by using other than recommended cables and connectors or by unauthorized changes or modifications to this equipment. Unauthorized changes or modifications could void the user's authority to operate the equipment.

This device complies with Part 15 of the FCC Rules. Operation is subject to the following two conditions: (1) this device may not cause harmful interference, and (2) this device must accept any interference received, including interference that may cause undesired operation.

Industry Canada Class A emission compliance statement

This Class A digital apparatus complies with Canadian ICES-003.

Avis de conformité a la réglementation d'Industrie Canada

Cet appareil numérique de la classe A est conforme à la norme NMB-003 du Canada.

Deutsche EMV-Direktive (electromagnetische Verträglichkeit)

Dieses Gerät ist berechtigt in Übereinstimmung mit dem deutschen EMVG vom 9.Nov.92 das EG-Konformitätszeichen zu führen.

Der Aussteller der Konformitätserklärung ist die IBM UK, Greenock.

Dieses Gerät erfüllt die Bedingungen der EN 55022 Klasse A. Für diese Klasse von Geräten gilt folgende Bestimmung nach dem EMVG:

Geräte dürfen an Orten, für die sie nicht ausreichend entstört sind, nur mit besonderer Genehmigung des Bundesministers für Post und Telekommunikation oder des Bundesamtes für Post und Telekommunikation betrieben werden. Die Genehmigung wird erteilt, wenn keine elektromagnetischen Störungen zu erwarten sind.

(Auszug aus dem EMVG vom 9.Nov.92, Para.3. Abs.4)

Hinweis: Dieses Genehmigungsverfahren ist von der Deutschen Bundespost noch nicht veröffentlicht worden.

European Union - EMC directive

This product is in conformity with the protection requirements of EU Council Directive 89/366/ECC on the approximation of the laws of the Member States relating to electromagnetic compatibility.

IBM cannot accept responsibility for any failure to satisfy the protection requirements resulting from a non-recommended modification of the product, including the fitting of non-IBM option cards.

This product has been tested and found to comply with the limits for Class A Information Technology Equipment according to CISPR 22/European Standard EN 55022. The limits for Class A equipment were derived for commercial and industrial environments to provide reasonable protection against interference with licensed communication equipment.

Warning: This is a Class A product. In a domestic environment this product may cause radio interference in which case the user may be required to take adequate measures.

Union Européenne - Directive Conformité électromagnétique

Ce produit est conforme aux exigences de protection de la Directive 89/336/EEC du Conseil de l'UE sur le rapprochement des lois des États membres en matière de compatibilité électromagnétique.

IBM ne peut accepter aucune responsabilité pour le manquement aux exigences de protection résultant d'une modification non recommandée du produit, y compris l'installation de cartes autres que les cartes IBM.

Ce produit a été testé et il satisfait les conditions de l'équipement informatique de Classe A en vertu de CISPR22/Standard européen EN 55022. Les conditions pour l'équipement de Classe A ont été définies en fonction d'un contexte d'utilisation commercial et industriel afin de fournir une protection raisonnable contre l'interférence d'appareils de communication autorisés.

Avvertissement : Ceci est un produit de Classe A. Dans un contexte résidentiel, ce produit peut causer une interférence radio exigeant que l'utilisateur prenne des mesures adéquates.

Union Europea - Normativa EMC

Questo prodotto è conforme alle normative di protezione ai sensi della Direttiva del Consiglio dell'Unione Europea 89/336/CEE sull'armonizzazione legislativa degli stati membri in materia di compatibilità elettromagnetica.

IBM non accetta responsabilità alcuna per la mancata conformità alle normative di protezione dovuta a modifiche non consigliate al prodotto, compresa l'installazione di schede e componenti di marca diversa da IBM.

Le prove effettuate sul presente prodotto hanno accertato che esso rientra nei limiti stabiliti per le apparecchiature di informatica Classe A ai sensi del CISPR 22/Norma Europea EN 55022. I limiti delle apparecchiature della Classe A sono stati stabiliti al fine di fornire ragionevole protezione da interferenze mediante dispositivi di comunicazione in concessione in ambienti commerciali ed industriali.

Avvertimento: Questo è un prodotto appartenente alla Classe A. In ambiente domestico, tale prodotto può essere causa di interferenze radio, nel qual caso l'utente deve prendere misure adeguate.

Unione Europea - Directiva EMC (Conformidad electromagnética)

Este producto satisface los requisitos de protección del Consejo de la UE, Directiva 89/336/CEE en lo que a la legislación de los Estados Miembros sobre compatibilidad electromagnética se refiere.

IBM no puede aceptar responsabilidad alguna si este producto deja de satisfacer dichos requisitos de protección como resultado de una modificación no recomendada del producto, incluyendo el ajuste de tarjetas de opción que no sean IBM.

Este producto ha sido probado y satisface los límites para Equipos Informáticos Clase A de conformidad con el Estándar CISPR22 y el Estándar Europeo EN 55022. Los límites para los equipos de Clase A se han

establecido para entornos comerciales e industriales a fin de proporcionar una protección razonable contra las interferencias con dispositivos de comunicación licenciados.

Advertencia: Este es un producto de Clase A. En un entorno doméstico este producto podría causar radiointerferencias en cuyo caso el usuario deberá tomar las medidas adecuadas.

声 明

**此为 A 级产品, 在生活环境中,
该产品可能会造成无线电干扰。
在这种情况下, 可能需要用户对其
干扰采取切实可行的措施。**

警告使用者：
這是甲類的資訊產品，在
居住的環境中使用時，可
能會造成射頻干擾，在這
種情況下，使用者會被要
求採取某些適當的對策。

この装置は、情報処理装置等電波障害自主規制協議会（VCCI）の基準に
基づくクラスA情報技術装置です。この装置を家庭環境で使用すると電波妨害を
引き起こすことがあります。この場合には使用者が適切な対策を講ずるよう要求
されることがあります。



Part Number: 33L3529

Printed in U.S.A.

(1P) P/N: 33L3529

