

myprojectorlamps.com

**The most trusted, dependable name
in projector lamp sales.**



<http://www.myprojectorlamps.com>



<http://www.myprojectorlamps.ca>



<http://www.myprojectorlamps.eu>

The following projector manual has not been modified or altered in any way.

BenQ

W100 Digital Projector

Home Entertainment Series

User's Manual

Table of contents

Safety, regulatory and legal information	3
Safety instructions	3
Regulatory and legal information	6
Introduction	7
Projector features	7
Shipping contents.....	8
Projector exterior view.....	9
Controls and functions	10
Positioning your projector	12
Choosing a location	12
Safety instructions for ceiling mounting of the projector.....	13
Obtaining a preferred projected image size	13
Connection	17
Connecting Video source devices	17
Operation	23
Start up	23
Switching input signal	23
Adjusting the projected image.....	24
Operating in a high altitude environment	26
Personalizing the projector menu display	26
Optimizing the image.....	27
Shutting down the projector.....	30
Menu operation	30
Maintenance	37
Care of the projector	37
Lamp information	38
Troubleshooting	43
Specifications	44
Projector specifications	44
Dimensions	44
Timing chart	45
Warranty	46
Limited warranty	46
Notices	47
Copyright	47
Disclaimer	47

1 Safety, regulatory and legal information

Thank you for your purchase of this quality BenQ video projector! It has been designed to provide you with a home theater viewing experience. For the best result, please read this manual carefully as it is your best guide to the control menus and product operation.

Safety instructions

Your BenQ projector is designed and tested to meet the latest standards for safety of information technology equipment. However, to ensure safe use of this product, it is important that you follow the instructions mentioned in this manual and marked on the product.

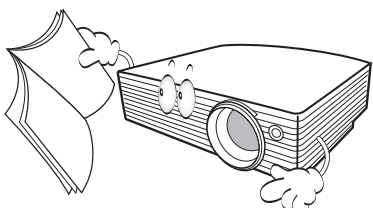
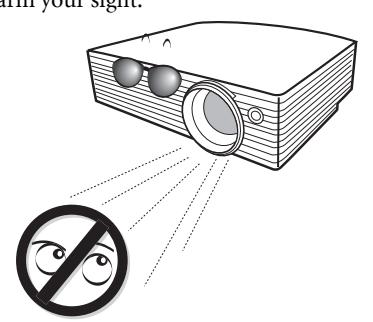
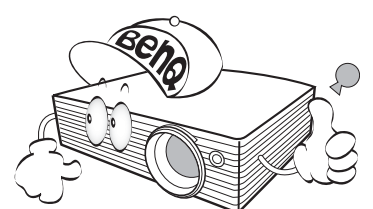
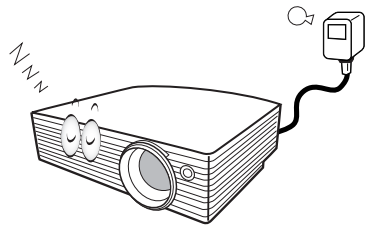
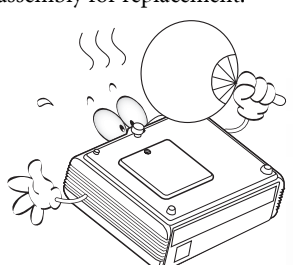
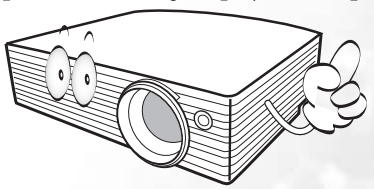
Safety instructions	
<p>1. Please read this user's manual before you operate your projector. Keep this manual in a safe place for future reference.</p>  <p>2. Do not look straight into the projector lens during operation. The intense light beam may harm your sight.</p>  <p>3. When you think service or repair is required, take the projector only to a suitably qualified technician.</p> 	<p>4. In areas where the mains voltage may fluctuate or cut out, it is recommended that you connect your projector through a power stabilizer, surge protector or uninterruptible power supply (UPS) as appropriate to your situation.</p>  <p>5. The lamp becomes extremely hot during operation. Allow the projector to cool for approximately 45 minutes prior to removing the lamp assembly for replacement.</p>  <p>6. Always open the lens shutter or remove the lens cap before switching the projector lamp on.</p> 

Safety Instructions (continued)

7. Never replace the lamp assembly until the projector has cooled down and is unplugged from the power supply.

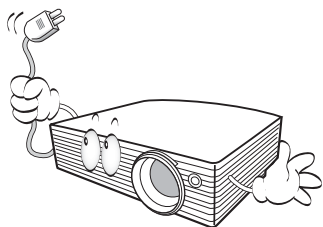

8. Do not attempt to disassemble this projector. There are dangerous high voltages inside which may cause death if you should come into contact with live parts. The only user serviceable part is the lamp which has its own cover.

Under no circumstances should you ever undo or remove any other covers. Refer servicing only to suitably qualified professional service personnel.

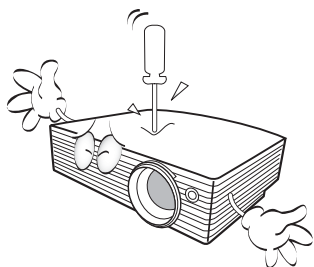

9. Do not block the ventilation holes while the projector is on (even in standby mode):
- Do not cover the projector with any item;
 - Do not place this unit on a blanket, bedding or any other soft surface;
 - Do not place inflammables near the projector.

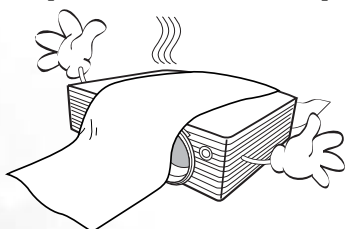

If the ventilation holes are seriously obstructed, overheating inside the unit may result in a fire.

10. Do not place this projector in any of the following environments.
- space that is poorly ventilated or confined. Allow at least 50 cm clearance from walls and free flow of air around the projector;
 - locations where temperatures may become excessively high, such as the inside of a car with all windows rolled up;
 - locations where excessive humidity, dust, or cigarette smoke may contaminate optical components, shortening the projector's lifespan and darkening the image;

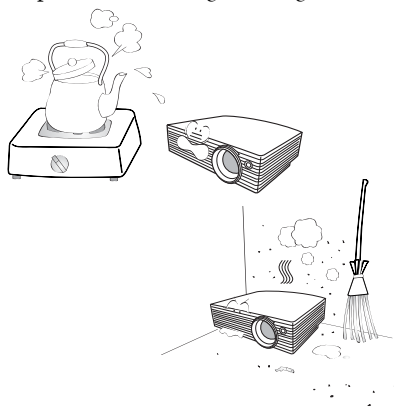

- locations near fire alarms;
- locations with an ambient temperature above 40°C / 104°F;
- locations where the altitudes are higher than 3050 meters/ 10000 feet above sea level.

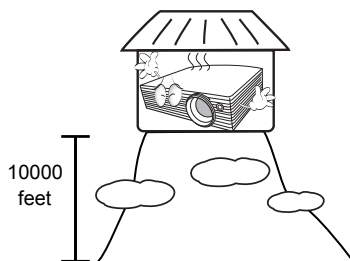

11. When the projector is under operation, you may sense some heated air and odor from its ventilation grill. It is a normal phenomenon and not a product defect.

Safety Instructions (continued)

12. Always place the unit on a level, horizontal surface during operation.
- Do not place this product on an unstable cart, stand, or table. The product may fall, sustaining serious damage.

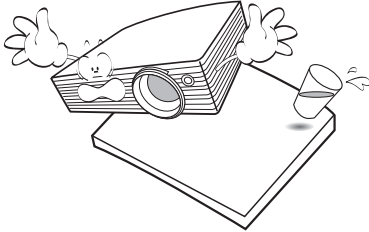

- Do not use if tilted at an angle of more than 10 degrees left to right, nor at angle of more than 15 degrees front to back. Using the unit when it is not fully horizontal may cause a malfunction of, or damage to, the lamp.

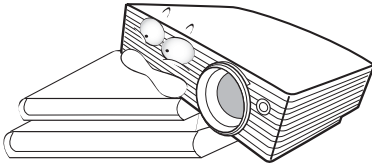

13. Do not store the projector on end vertically. Doing so may cause the unit to fall over, causing injury or resulting in damage.

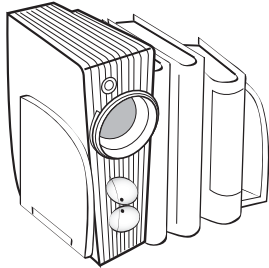

14. This product is capable of displaying inverted images for ceiling mount installation. Use only BenQ's Ceiling Mount Kit for mounting.

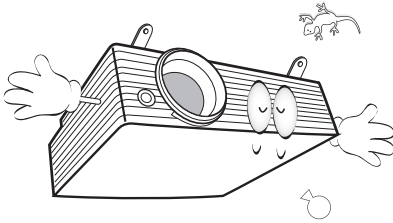

15. Do not step on the projector or place any objects upon it. Besides probable physical damage to the projector, doing so may result in accidents and possible injury.

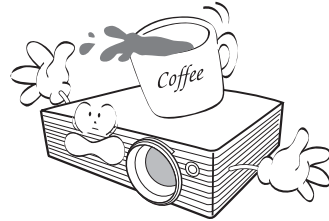

16. Do not block the projection lens with any objects when the projector is under operation as this could cause the objects to become heated and deformed or even cause a fire.
17. Do not place liquids near or on the projector. Liquids spilled into the projector will void your warranty. If the projector does become wet, disconnect it from the power supply's wall socket and call BenQ to have the projector repaired.

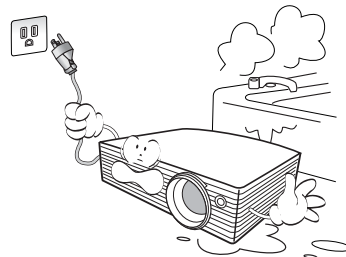

18. Do not operate the projector lamp beyond the rated lamp life. Excessive operation of lamps beyond the rated life could cause them to break on rare occasions.

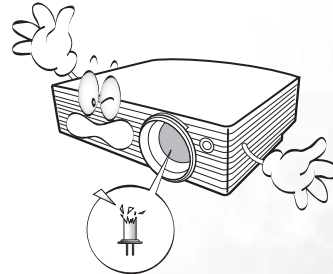

Moisture condensation

Never operate the projector immediately after moving it from a cold location to a hot location. When the projector is exposed to such a change in temperature, moisture may condense on the crucial internal parts. To prevent the projector from possible damage, do not use the projector for at least 2 hours after a sudden change in temperature.

Avoid using volatile liquids

Do not use volatile liquids, such as insecticide or some types of cleaner, near the projector. Do not leave rubber or plastic products touching the projector for a long time. They will leave marks on the finish. When cleaning, be sure to follow the cleaning product's safety instructions.

Disposal

This product contains the following materials which are harmful to humans and the environment.

- Lead, which is contained in solder.
- Mercury, which is used in the lamp.

To properly dispose of the product or used lamps, consult your local environmental authority for advice.

Regulatory and legal information

FCC statement

CLASS B: This equipment generates, uses and can radiate radio frequency energy and, if not installed and used in accordance with the instructions, may cause harmful interference to radio communications. However, there is no guarantee that interference will not occur in a particular installation. If this equipment does cause harmful interference to radio or television reception, which can be determined by turning the equipment off and on, the user is encouraged to try to correct the interference by one or more of the following measures:

- Reorient or relocate the receiving antenna.
- Increase the distance between the equipment and receiver.
- Connect the equipment into an outlet on a circuit different from that to which the receiver is connected.
- Consult the dealer or an experienced radio/TV technician for help.

EEC statement

This machine was tested against the 89/336/EEC (European Economic Community) for EMC (Electronic Magnetic Compatibility) and fulfills these requirements.

MIC statement

B class equipment (Household purpose info/telecommunications equipment)

This equipment has undergone EMC registration for household purpose, and can be used in any area including residential area.

WEEE directive

Disposal of Waste Electrical and Electronic Equipment by users in private households in the European Union.

This symbol on the product or on the packaging indicates that this can not be disposed of as household waste. You must dispose of your waste equipment by handing it over to the applicable take-back scheme for the recycling of electrical and electronic equipment. For more information about recycling of this equipment, please contact your city office, the shop where you purchased the equipment or your household waste disposal service. The recycling of materials will help to conserve natural resources and ensure that it is recycled in a manner that protects human health and environment.



2 Introduction

Projector features

The projector integrates high-performance optical engine projection and a user-friendly design bringing you an enjoyable home viewing experience.

- Compact and portable unit
 - High quality manual zoom lens
 - Ability to display 16.7 million colors
 - Multi-language on-screen menus
 - 10 sets of preset application mode
 - 7-segment color wheel
 - 25dB Noise Level in Economic Mode
 - Native 16:9 aspect ratio
 - 2 sets of Component Video sockets allowing a second Component Video device to remain connected and standing by so that it can be readily selected without swapping cables
 - A DVI connector with HDCP function making digital viewing quality possible
-  • **The apparent brightness of the projected image will vary depending on the ambient lighting conditions, selected input source contrast/brightness settings, and is directly proportional to projection distance.**
- **The lamp brightness will decline over time and may vary within the lamp manufacturers specifications. This is normal and expected behavior.**

Shipping contents

The projector is shipped with the cables required for connection to a PC and to video equipment. Carefully unpack and verify that you have all of the items shown below. If any of these items are missing, please contact your place of purchase.

Standard accessories

 The supplied accessories will be suitable for your region, and may differ from those illustrated.

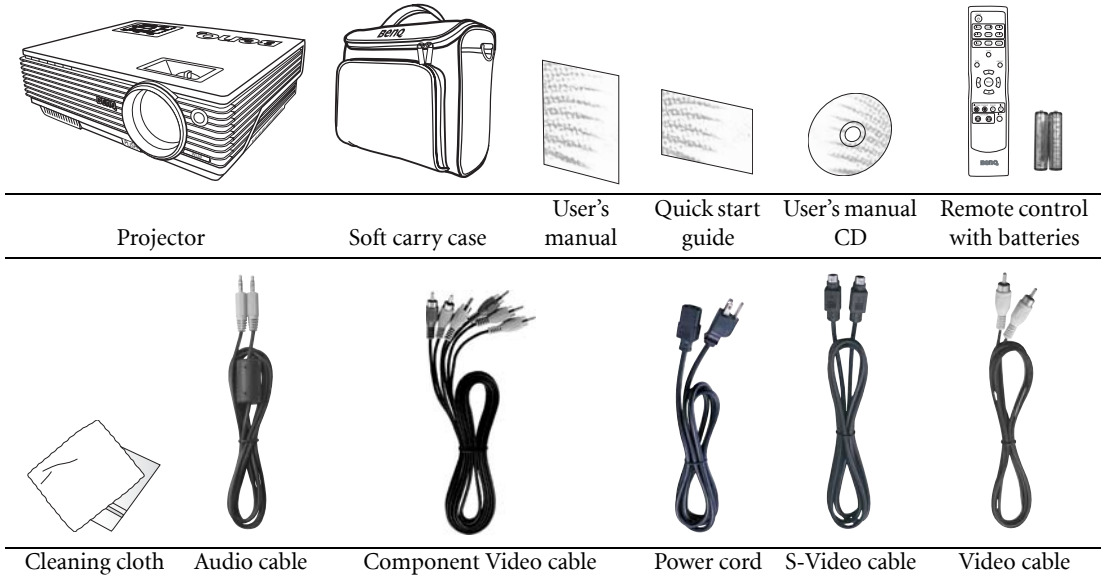

Optional accessories

1. Spare lamp kit
2. Ceiling mount kit
3. DVI cable
4. Component Video to VGA (D-sub) adaptor cable

Remote control batteries

1. To open the battery cover, turn the remote control over to view its back, push on the finger grip on the cover and slide it down in the direction of the arrow as illustrated. The cover will slide off.
2. Remove any existing batteries (if necessary) and install two new AAA batteries observing the battery polarities as indicated in the base of the battery compartment. Positive (+) goes to positive and negative(-) goes to negative.
3. Refit the cover by aligning it with the case and sliding it back up into position. Stop when it clicks into place.

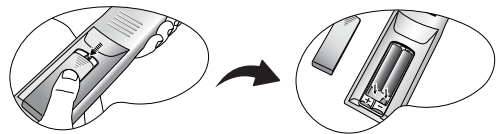

Notes on handling batteries

- Do not mix old batteries with new ones, or mix different types of batteries.
- Avoid leaving the remote control and batteries in an excessive heat or humid environment like the kitchen, bathroom, sauna, sunroom, or in a closed car.
- Dispose of used batteries according to the battery manufacturer's instructions and local environment regulations for your region.
- If the remote control will not be used for an extended period of time, remove the batteries to avoid damage to the control from possible battery leakage.

Projector exterior view

Front / upper side

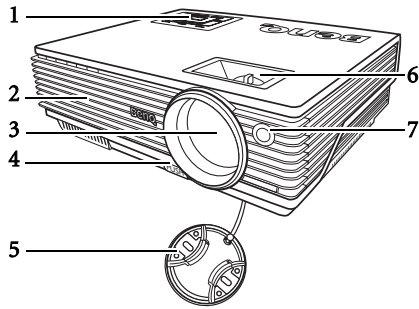

- 1. External control panel
(See "Projector" on page 10 for detailed information.)
- 2. Ventilation grill
- 3. Projection lens
- 4. Front adjuster button
- 5. Lens cap
- 6. Focus ring and Zoom ring
- 7. Front IR remote sensor

Rear side

Refer to "Connection" on page 17 for more information on making connections to various equipment.

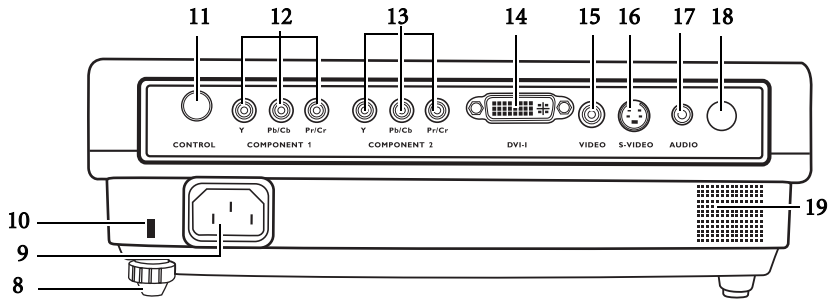

- 8. Rear adjuster foot
- 9. AC power cord inlet
- 10. Kensington anti-theft lock slot
- 11. RS232 control port
- 12. Component 1
supports YPbPr, or YCbCr video signal
- 13. Component 2
supports YPbPr, or YCbCr video signal
- 14. DVI-I socket
supports DVI-D video signal and DVI-A PC signal
- 15. Video socket
- 16. S-Video socket
- 17. Audio socket
- 18. IR remote sensor
- 19. Speaker

Lower side

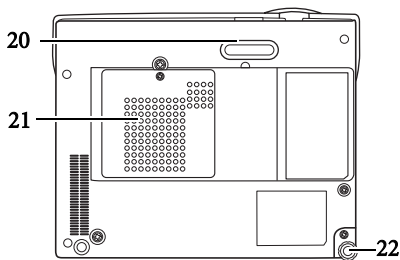





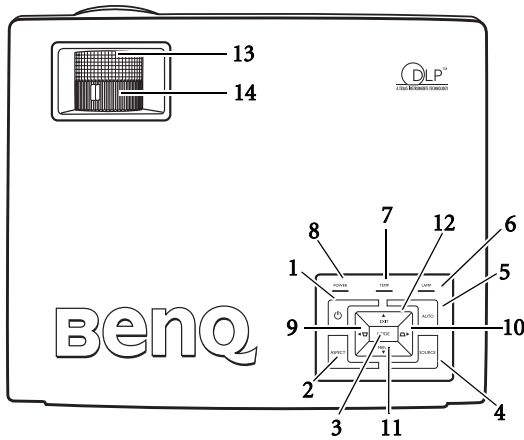

- 20. Front adjuster foot
- 21. Lamp cover
- 22. Rear adjuster foot

Controls and functions

Projector



- 1.  Power** (See ["Start up" on page 23](#) and ["1. Selecting the aspect ratio" on page 27](#) for details.)
Toggles the projector between standby mode and on. When the projector is in standby, press once to turn the projector on.
When the projector is on, press twice to turn the projector to standby.
- 2. ASPECT** (See ["1. Selecting the aspect ratio" on page 27](#) for details.)
Selects an image aspect ratio to suit the input signal.
- 3. MODE** (See ["Application Mode" on page 32](#) for details.)
Depending upon which input signal is selected, there are several picture setup options available.
- 4. SOURCE** (See ["Switching input signal" on page 23](#) for details.)
Sequentially selects the input signal Video, S-Video, DVI-A, DVI-D, Component Video 1, or Component Video 2.
- 5. AUTO** (See ["Auto-adjusting the image" on page 24](#) for details.)
Automatically determines the best picture timings for the displayed image. This function only works when a computer source is connected.
- 6. Lamp indicator light** (See ["Indicators" on page 41](#) for details.)
Indicates the status of the lamp. Lights up or flashes when the lamp has developed a problem.
- 7. Temperature warning light** (See ["Indicators" on page 41](#) for details.)
Flashes red if the projector's temperature becomes too high.
- 8. Power indicator light** (See ["Indicators" on page 41](#) for details.)
Lights up or flashes when the projector is under operation.
- 9. Keystone  /  Left**
- 10. Keystone  /  Right** (See ["Correcting keystone" on page 25](#) for details.)
When the on-screen menu is not activated, #9 and #10 function as **Keystone** correction hot keys.
- 11.  MENU** (See ["Using the menus" on page 30](#) for details.)
Turns on the on-screen display control menu.
- 12.  EXIT**
Exits and saves the menu settings.
When the on-screen menu is activated, the #9 to #12 buttons are used as directional arrows to select the desired menu items and to make adjustments.
- 13. Focus ring** (See ["Fine-tuning the image size and clarity" on page 24](#) for details.)
Adjusts the focus of the projected image.
- 14. Zoom ring** (See ["Fine-tuning the image size and clarity" on page 24](#) for details.)
Adjusts the size of the image.

Remote control

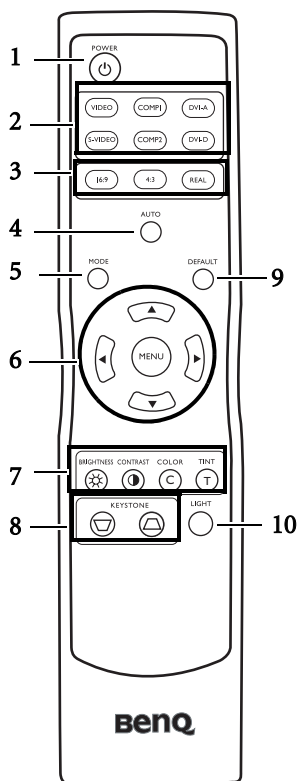

- POWER** (See ["Start up" on page 23](#) and ["Shutting down the projector" on page 30](#) for details.)

Toggles the projector between standby mode and on.

When the projector is in standby, press once to turn the projector on. When the projector is on, press twice to turn the projector to standby.
- Source buttons** (See ["Switching input signal" on page 23](#) for details.)

Selects an input signal to display on the projector.
- Aspect buttons** (See ["1. Selecting the aspect ratio" on page 27](#) for details.)

Selects an image aspect ratio to suit the input signal.
- AUTO** (See [page "Auto-adjusting the image" on page 24](#) for details.)

Automatically determines the best picture timings for the displayed image. This function only works when a computer source is connected.
- MODE** (See [page "2. Selecting an application mode" on page 28](#) for details.)

Depending upon which input signal is selected, there are several picture setup options available.
- MENU and directional buttons** (\blacktriangle / \blacktriangleleft / \blacktriangledown / \blacktriangleright) (See [page "Using the menus" on page 30](#) for details.)

Press **MENU** to turn the on-screen menu on.

Press the directional arrow buttons to select the desired menu items and make adjustments.

Exit and saves menu settings by pressing **MENU** again.
- Picture quality adjustment buttons** (See ["3. Other adjustments" on page 28](#) for details.)
- KEYSTONE buttons** (See ["Correcting keystone" on page 25](#) for details.)

Press ∇ to reduce the upper portion of the image. Press \triangle to reduce the lower portion of the image.
- DEFAULT**

Returns all settings to the factory preset values.
- LIGHT**

Turns on the remote control backlight for about 10 seconds. Pressing any other button while the backlight is on keeps the backlight on for a further 10 seconds. Press the Light button again to turn the backlight off.

Remote control operation

Make sure that there is nothing positioned between the remote control and the IR sensors on the projector that might obstruct the infra-red beam from the remote control reaching the projector. The effective range of the remote control is up to 8 meters, at an angle within 45 degrees of the IR beam.

Always aim straight at the projector, however most screens will also reflect the IR beam to the projector.

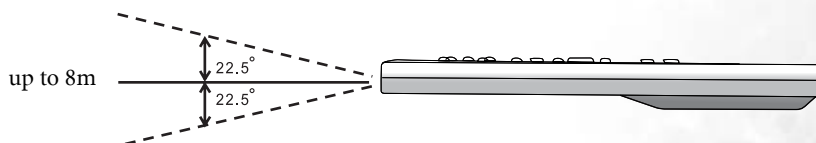

3 Positioning your projector

Choosing a location

Your projector is designed to be installed in one of four possible installation locations:

1. Floor in front of screen;
2. Ceiling in front of screen;
3. Floor at rear of screen;
4. Ceiling at rear of screen.

Your room layout or personal preference will dictate which installation location you select. Take into consideration the size and position of your screen, the location of a suitable power outlet, as well as the location and distance between the projector and the rest of your equipment.

1. Floor front

Select this location with the projector placed near the floor in front of the screen. This is the most common way to position the projector for quick setup and portability.

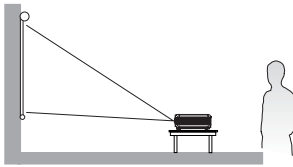

2. Ceiling front

Select this location with the projector suspended upside-down from the ceiling in front of the screen.

Purchase the BenQ Projector Ceiling Mounting Kit from your dealer to mount your projector on the ceiling.

Set  in the **Advance > Mirror** menu after you turn the projector on.

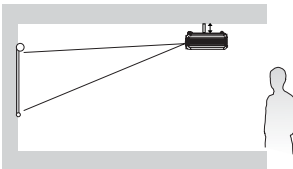

3. Floor rear

Select this location with the projector placed near the floor behind the screen.

Note that a special rear projection screen is required.

Set  in the **Advance > Mirror** menu after you turn the projector on.

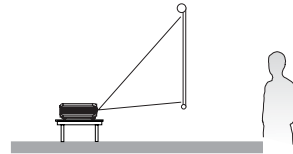

4. Ceiling rear

Select this location with the projector suspended upside-down from the ceiling behind the screen.

Note that a special rear projection screen and the BenQ Projector Ceiling Mounting Kit are required for this installation location.

Set  in the **Advance > Mirror** menu after you turn the projector on.

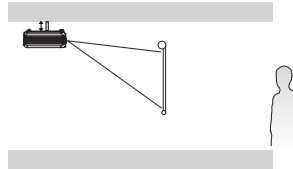

Safety instructions for ceiling mounting of the projector

We want you to have a pleasant experience using your BenQ projector, so we need to bring this safety matter to your attention to prevent damage to person and property.

If you intend to mount your projector on the ceiling, we strongly recommend that you use a proper fitting BenQ projector ceiling mount kit and that you ensure it is securely and safely installed.

If you use a non-BenQ brand projector ceiling mount kit, there is a safety risk that the projector may fall from the ceiling due to an improper attachment through the use of the wrong gauge or length screws.

You can purchase a BenQ projector ceiling mount kit from the place you purchased your BenQ projector. BenQ recommends that you also purchase a separate Kensington lock compatible security cable and attach it securely to both the Kensington lock slot on the projector and the base of the ceiling mount bracket. This will perform the secondary role of restraining the projector should its attachment to the mounting bracket become loose.

Obtaining a preferred projected image size

The distance from the projector lens to the screen, the zoom setting, and the video format each factors in the projected image size.

The maximum (native) resolution of the projector is 854 x 480 pixels, which is a 16 to 9 aspect ratio (expressed as 16:9). A 4:3 aspect image source will display in the horizontal center of the projected image, resulting in a pillarbox display (with unlit vertical areas—black bars—on either side of the projected image) as illustrated.

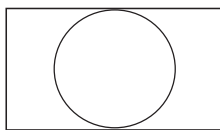

16:9 aspect image in a 16:9 aspect display area

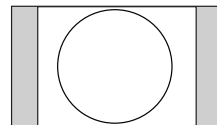

4:3 aspect image in a 16:9 aspect display area

The projector should always be placed horizontally level (like flat on a table), and positioned directly perpendicular (90° right-angle square) to the horizontal centre of the screen. This prevents image distortion caused by angled projections (or projecting onto angled surfaces).

The modern digital projector does not project directly forward (like older style reel-to-reel film projectors did). Instead, digital projectors are designed to project at a slightly upward angle above the horizontal plane of the projector. This is so that they can be readily placed on a table and will project forward and upwards onto a screen positioned so that the bottom edge of the screen is above the level of the table (and everyone in the room can see the screen).

If the projector is mounted on a ceiling, it must be mounted upside-down so that it projects at a slightly downward angle. See "[Safety instructions for ceiling mounting of the projector](#)" for details.

You can see from the diagram on page 15, that this type of projection causes the bottom edge of the projected image to be vertically offset from the horizontal plane of the projector. When ceiling mounted, this refers to the top edge of the projected image.

If the projector is positioned further away from the screen, the projected image size increases, and the vertical offset also increases proportionately.

When determining the position of the screen and projector, you will need to account for both the projected image size and the vertical offset dimension, which are directly proportional to the projection distance.

BenQ has provided separate tables of dimensions for both 16:9 and 4:3 screen ratios to assist you in determining the ideal location for your projector on pages 15 and 16. There are two dimensions to consider, the perpendicular horizontal distance from the centre of the screen (projection distance), and the vertical offset height of the projector from the horizontal edge of the screen (offset).

How to determine the position of the projector for a given screen size

1. Determine the aspect ratio of your screen, (16:9 or 4:3)? If you have a 16:9 screen, refer to ["Installation for a 16:9 ratio screen" on page 15](#). If you have a 4:3 screen, refer to ["Installation for a 4:3 ratio screen" on page 16](#).
2. Select your screen size.
3. Refer to the table and find the closest match to your screen size in the left columns labelled 'Screen Diagonal' Using this value, look across this row to the right to find the corresponding average distance from screen value in the column labelled 'Average'. This is the projection distance.
4. On that same row, look across to the right column and make note of the vertical Offset value. This will determine the final vertical offset placement of the projector in relation to the edge of the screen.
5. The recommended position for the projector is aligned perpendicular to the horizontal centre of the screen, at the distance from the screen determined in step 2 above, and offset by the value determined in step 3 above.

For example, if you are using a 120 inch screen with 16:9 aspect ratio, the average projection distance is 4829 mm and with a vertical offset of 244 mm.

If you place the projector in a different position (to that recommended), you will have to tilt it down or up to center the image on the screen. In these situations, some image distortion will occur. Use the Keystone function to correct the distortion. See ["Correcting keystone" on page 25](#) for keystone correction.

How to determine the recommended screen size for a given distance

This method can be used for situations where you have purchased this projector and would like to know what screen size will fit in your room.

The maximum screen size is limited by the physical space available in your room.

1. Determine the aspect ratio of your screen, (16:9 or 4:3)? If you have a 16:9 screen, refer to ["Installation for a 16:9 ratio screen" on page 15](#). If you have a 4:3 screen, refer to ["Installation for a 4:3 ratio screen" on page 16](#).
2. Measure the distance between the projector and where you want to position the screen. This is the projection distance.
3. Refer to the table and find the closest match to your measurement in the average distance from screen column labelled 'Average'. Check that your measured distance is between the min and max distances listed on either side of the average distance value.
4. Using this value, look across that row to the left to find the corresponding screen diagonal listed in that row. That is the projected image size of the projector at that projection distance.
5. On that same row, look across to the right column and make note of the vertical Offset value. This will determine the final placement of the screen in relation to the horizontal plane of the projector.

For example, if you have a 4:3 aspect screen and your measured projection distance was 4.8m (4800mm), the closest match in the Average column is 4851mm. Looking across this row shows that a 2500mm (2.5m) screen is required. If you can only obtain imperial sized screens, the listed screen sizes on either side of the 2.5m screen are the 8' and 9' screens.

Checking the min. and max. projection distance values for these screen sizes, indicates that the 4.8m measured projection distance will fit the 2.5m and 8' screens. The projector can be adjusted (using the zoom control) to display on these different screen sizes at that projection distance. Be aware that these different screens have different vertical offset values.

Installation for a 16:9 ratio screen

Ceiling Installation

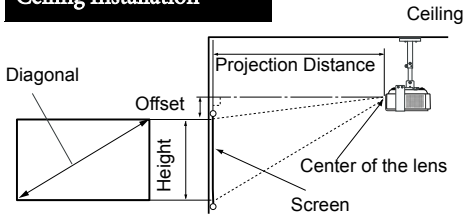

Floor Installation

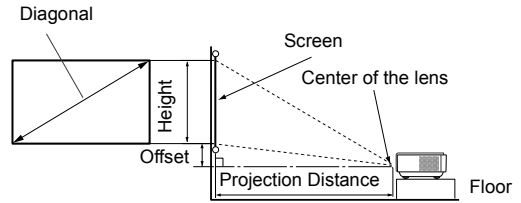

16:9 Screen Diagonal			Distance from Screen in mm			Vertical Offset in mm
Feet	Inches	mm	Min. length (with max. zoom)	Average	Max. length (with min. zoom)	
4	48	1219	1800	1931	2063	97
		1500	2215	2376	2538	120
5	60	1524	2250	2414	2578	122
6	72	1829	2700	2897	3094	146
		2000	2953	3168	3384	160
7	84	2134	3150	3380	3610	171
8	96	2438	3600	3863	4125	195
		2500	3691	3960	4230	200
9	108	2743	4050	4346	4641	219
		3000	4430	4753	5076	240
10	120	3048	4500	4829	5157	244
		3500	5168	5545	5921	280
12	144	3658	5401	5794	6188	292
		4000	5906	6337	6767	320
15	180	4572	6751	7243	7735	365
		5000	7383	7921	8459	400
18	216	5486	8101	8692	9282	438
		6000	8476	9094	9712	459
25	300	7620	11251	12072	12892	609

☞ The above numbers are approximate and may be slightly different from the actual measurements.

Installation for a 4:3 ratio screen

The illustrations and table below are provided for those users who already have 4:3 aspect ratio screens or intend to purchase 4:3 aspect ratio screens to view 16:9 ratio projected images.

Ceiling Installation

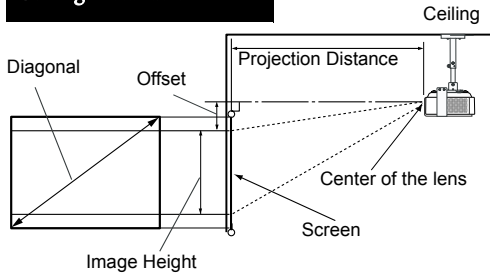

Floor Installation

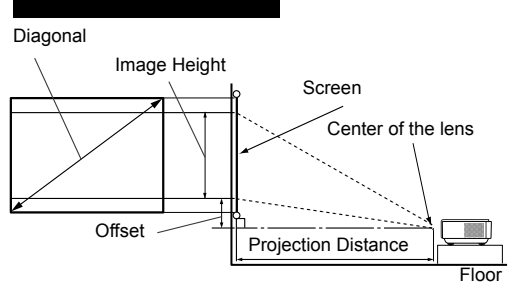

4:3 Screen Diagonal			Distance from Screen in mm			Vertical Offset in mm
Feet	Inches	mm	Min. length (with max. zoom)	Average	Max. length (with min. zoom)	
4	48	1219	2205	2366	2526	119
		1500	2713	2910	3108	147
5	60	1524	2756	2957	3158	149
		1829	3307	3548	3790	179
6	72	2000	3617	3881	4144	196
		2134	3858	4140	4421	209
7	84	2134	3858	4140	4421	209
		2438	4410	4731	5053	239
8	96	2438	4410	4731	5053	239
		2500	4521	4851	5180	245
9	108	2743	4961	5323	5684	268
		3000	5425	5821	6217	294
10	120	3048	5512	5914	6316	298
		3500	6330	6791	7253	343
12	144	3658	6615	7097	7579	358
		4000	7234	7761	8289	392
15	180	4572	8268	8871	9474	447
		5000	9042	9702	10361	489
18	216	5486	9922	10645	11369	537
		6000	10381	11138	11895	562
25	300	7620	13780	14785	15790	746

 The above numbers are approximate and may be slightly different from the actual measurements.

4 Connection

You can connect the projector to any type of video equipment, such as a VCR, DVD player, digital tuner, cable or satellite decoder, video game console or digital camera. You can also connect it to a desktop or laptop PC or Apple Macintosh system.

The projector can be connected to multiple video equipment at the same time by using different cables. All you need do is select the appropriate input for the projector to display.

When connecting a signal source to the projector, be sure to:

1. Turn all equipment off before making any connections.
2. Use the correct signal cables for each source.
3. Ensure the cables are firmly inserted.

 **Note that all cables shown in the following connection diagrams may not be supplied with the projector (see [page 8](#) for the shipping contents). Most cables are commercially available from electronics stores.**

Connecting Video source devices

You can connect your projector to various Video source devices that provide any one of the following output sockets:

- DVI
- Component Video
- S-Video
- Video (composite)

You need only connect the projector to a Video source device using just one of the above connecting methods, however each provides a different level of video quality. The method you choose will most likely depend upon the availability of matching terminals on both the projector and the Video source device as described below:

Best video quality

The best available video connection method is DVI, if your source device is equipped with a DVI socket. Based on the type of DVI connector you have, you can enjoy a digital or high-end analog video quality.

See "[Connecting a DVI source device](#)" on [page 19](#) for how to connect the projector to a DVI source device and other details.

If no DVI source is available, the next best video signal is available by connecting your device to the projector with a Component Video (not to be confused with composite Video) cable. Digital TV tuner and DVD players output Component Video natively, so if available on your devices, they should be your connection method of choice in preference to S-Video or (composite) Video.

See "[Connecting a Component Video source device](#)" on [page 20](#) for how to connect the projector to a component video device.

Better video quality

The S-Video method provides a better quality analog video than standard composite Video. If you have both composite Video and S-Video output terminals on your Video source device, you should elect to use the S-Video option.

See "[Connecting an S-Video source device](#)" on [page 21](#) for how to connect the projector to an S-Video device.

Least video quality

Composite Video is an analog video and will result in a perfectly acceptable, but less than optimal result from your projector, being the least video quality of the available methods described here.

See "[Connecting a composite Video source device](#)" on [page 22](#) for how to connect the projector to a composite Video device.

Connecting Audio

The projector has a built-in mono speaker which is designed to provide basic audio functionality. Any stereo audio input (if provided), is mixed into a common mono audio output through the projector speaker.

If you have a separate sound system, you will most likely want to connect the audio output of your Video source device to that sound system, instead of to the mono audio projector.

The audio connections illustrated in the following sections are provided for informational purposes only. You need not connect audio to the projector if there is an alternate sound system available, or if audio is not required.

Connecting a DVI source device

The projector provides a DVI-I input socket that allows you to connect it to a DVI source device like DVD player, or a VGA output device like notebook or desktop computer.

There are three types of DVI connector: DVI-A, DVI-D, and DVI-I. The DVI-I socket is an integrated connector which supports both formats: DVI-A, and DVI-D.

DVI-A format is used to carry a DVI signal to an analog (VGA) display, or vice-versa. Although some signal quality is lost from the signal conversion, it still transmits higher picture quality than standard VGA connection.

DVI-D format is used to directly carry a digital signal to a digital display without signal conversion. The pure digital connection provides faster and higher image quality than analog connection, due to the nature of the digital format.

DVI-A and DVI-D formats are non-interchangeable. You cannot connect a DVI-A format connector to a DVI-D equipment. Make sure what kind of format you need before you purchase the cable. Or you can purchase a DVI-I cable which will be more useful in any type of DVI connection situations.

Examine your source device to determine if it has an unused DVI or VGA (D-Sub) output socket available:

- If so, you can continue with this procedure.
- If not, you will need to reassess which method you can use to connect to the device.

To connect the projector to a DVI source device or a computer (either through a DVI cable or VGA to DVI-A cable):

<ul style="list-style-type: none"> • With a DVI (DVI-I or DVI-D) cable <ol style="list-style-type: none"> 1. Take the cable and connect one end to the DVI output socket of the DVI source device. 2. Connect the other end of the cable to the DVI-I signal input socket on the projector. 	<ul style="list-style-type: none"> • With a VGA to DVI-A cable <ol style="list-style-type: none"> 1. Take a VGA to DVI-A cable and connect the VGA end to the D-Sub output socket of the computer. 2. Connect the DVI end of the VGA to DVI-A cable to the DVI-I signal input socket on the projector.
<ol style="list-style-type: none"> 3. If you wish to make use the projector (mixed mono) speaker, take a suitable audio cable and connect one end of the cable to the audio output sockets of the video device, and the other end to the AUDIO socket of the projector. <p>Once connected, the audio can be controlled by the projector volume and mute settings. See "Mute" and "Volume" on page 34 for details.</p>	

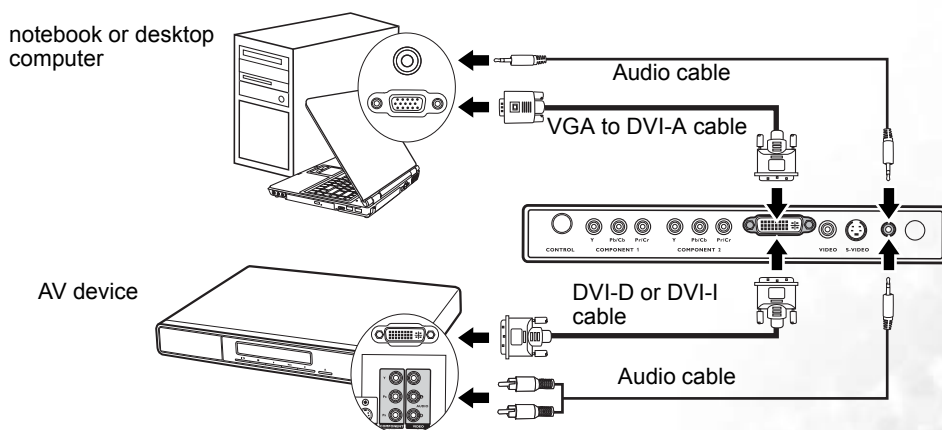

Many notebooks do not turn on their external video ports when connected to a projector. Usually a key combo like FN + F3 or CRT/LCD key turns the external display on/off. Locate a function key labeled CRT/

LCD or a function key with a monitor symbol on the notebook. Press FN and the labeled function key simultaneously. Refer to your notebook's documentation to find your notebook's key combination.

Connecting a Component Video source device

The projector is equipped with two sets of Component Video sockets in use. You can connect up to 2 different Component Video devices at the same time. Examine your Video source device to determine if it has a set of unused Component Video output sockets available:

- If so, you can continue with this procedure.
- If not, you will need to reassess which method you can use to connect to the device.

To connect the projector to a Component Video source device:

1. Take the Component Video cable and connect the end with 3 RCA type connectors to the Component Video output sockets of the Video source device. Match the color of the plugs to the color of the sockets; green to green, blue to blue; and red to red.
2. Connect the other end with 3 RCA type connectors to the YPb(Cb)Pr(Cr) sockets on the projector. Again, match the color of the plugs to the color of the sockets; green to green, blue to blue; and red to red.
3. If you wish to make use of the projector (mixed mono) speaker, take a suitable audio cable and connect one end of the cable to the audio output sockets of the video device, and the other end to the AUDIO socket of the projector.

Once connected, the audio can be controlled by the projector volume and mute settings. See "[Mute](#)" and "[Volume](#)" on page 34 for details.

The final connection path should be like that shown in the following diagram:

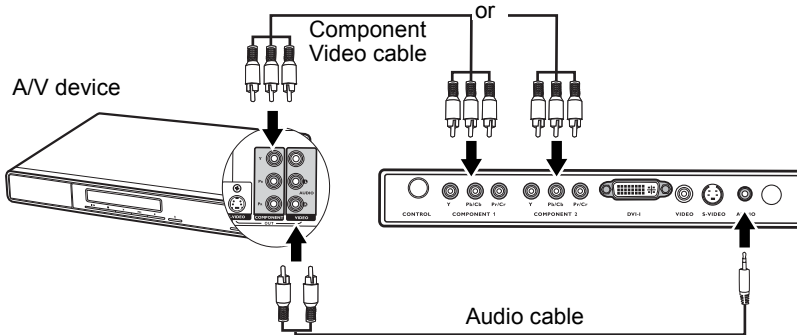

If you connect the projector to a High Definition TV (HDTV) tuner, the following standards are supported:

- 480i
- 576i
- 720p (50/ 60 Hz)
- 480p
- 576p
- 1080i (50/ 60 Hz)

 • **The projector is only capable of playing mixed mono audio, even if a stereo audio input is connected. See "[Connecting Audio](#)" on page 18 for details.**

- **If the selected video image is not displayed after the projector is turned on and the correct video source has been selected, check that the Video source device is turned on and operating correctly. Also check that the signal cables have been connected correctly.**

Connecting an S-Video source device

Examine your Video source device to determine if it has an unused S-Video output socket available:

- If so, you can continue with this procedure.
- If not, you will need to reassess which method you can use to connect to the device.

To connect the projector to an S-Video source device:

1. Take the (optional accessory) S-Video cable and connect one end to the S-Video output socket of the Video source device.
2. Connect the other end of the S-Video cable to the S-VIDEO socket on the projector.
3. If you wish to make use of the projector (mixed mono) speaker, take a suitable audio cable and connect one end of the cable to the audio output sockets of the video device, and the other end to the AUDIO socket of the projector.

Once connected, the audio can be controlled by the projector volume and mute settings. See "[Mute](#)" and "[Volume](#)" on page 34 for details.

The final connection path should be like that shown in the following diagram:

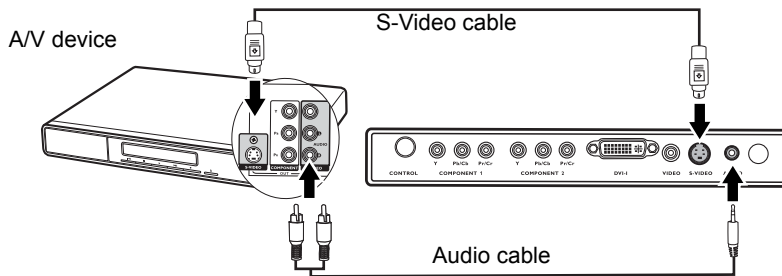

- ☞ • **The projector is only capable of playing mixed mono audio, even if a stereo audio input is connected. See "[Connecting Audio](#)" on page 18 for details.**
- **If the selected video image is not displayed after the projector is turned on and the correct video source has been selected, check that the Video source device is turned on and operating correctly. Also check that the signal cables have been connected correctly.**
- **If you have already made a Component Video connection between the projector and this S-Video source device using Component Video connections, you need not connect to this device using an S-Video connection as this makes an unnecessary second connection of poorer picture quality. See "[Connecting Video source devices](#)" on page 17 for details.**

Connecting a composite Video source device

Examine your Video source device to determine if it has an unused composite Video output socket available:

- If so, you can continue with this procedure.
- If not, you will need to reassess which method you can use to connect to the device.

To connect the projector to an composite Video source device:

1. Take the (optional accessory) Video cable and connect one end to the composite Video output socket of the Video source device.
2. Connect the other end of the Video cable to the VIDEO socket on the projector.
3. If you wish to make use of the projector (mixed mono) speaker, take a suitable audio cable and connect one end of the cable to the audio output sockets of the video device, and the other end to the AUDIO socket of the projector.

Once connected, the audio can be controlled by the projector volume and mute settings. See "[Mute](#)" and "[Volume](#)" on page 34 for details.

The final connection path should be like that shown in the following diagram:

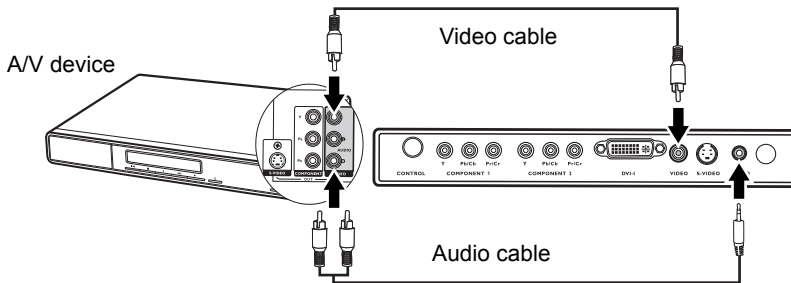

- ☞ • **The projector is only capable of playing mixed mono audio, even if a stereo audio input is connected. See "[Connecting Audio](#)" on page 18 for details.**
- **If the selected video image is not displayed after the projector is turned on and the correct video source has been selected, check that the Video source device is turned on and operating correctly. Also check that the signal cables have been connected correctly.**
- **You need only connect to this device using a composite Video connection if Component Video and S-Video inputs are unavailable for use. See "[Connecting Video source devices](#)" on page 17 for details.**

5 Operation

Start up

1. Plug the power cord into the projector and into a wall socket. Turn on the wall socket switch (where fitted). Check that the **Power indicator** on the projector lights orange after power has been applied.
2. Remove the lens cap. If it is left on, it could become deformed due to heat.

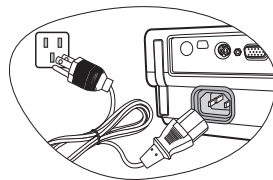

3. Press and hold (for 2 seconds) the **POWER** button on the remote control or projector to start the unit. The **Power indicator light** flashes green and stays green when the unit is on.

The start up procedure takes about 30 seconds after pressing **POWER**. In the later stage of start up, a default BenQ logo is projected.

(If necessary) Rotate the focus ring to adjust the image clearness.

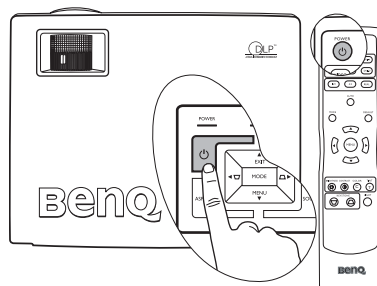

If the projector is still hot from previous activity, it will run the cooling fan for approximately 90 seconds before energising the lamp.

4. Switch all of the connected equipment on.
5. The projector will start to search for input signals. The current input source being scanned displays at the center of the screen. If the projector doesn't detect a valid signal, the searching message will continue displaying until an input source signal is found.

You can also press **SOURCE** on the projector or remote control to select your desired input signal. For more information, please refer to "[Switching input signal](#)" on page 23.

If the frequency/ resolution of the input signal exceeds the projector's operating range, you will see the message "Out of Range" displayed on a blank screen. Please change to an input signal which is compatible with the projector's resolution or set the input signal to a lower setting. See "[Timing chart](#)" on page 45 for details.

Switching input signal

The projector can be connected to multiple devices at the same time. However, it can only display one at a time. To select an individual input signal, press one of the Source buttons (Video, S-Video, DVI-A, DVI-D, Component Video 1, or Component Video 2) on the remote control, or to cycle through the available input sources, press the **SOURCE** button on the projector. The selected source name will display at the center of the screen for 3 seconds after each button press.

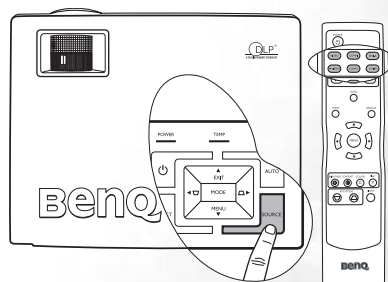

The brightness level of the projected image will change accordingly when you switch between different input signals. Data (graphic) "PC" presentations using mostly static images are generally brighter than "Video" using mostly moving images (movies). The input type affects the options available for the Application Mode. See "[2. Selecting an application mode](#)" on page 28 for details.

Adjusting the projected image

Adjusting the projection angle

The projector is equipped with 1 quick-release adjuster foot and 1 rear adjuster foot. These adjusters change the image height and projection angle.

To adjust the projector:

1. Press the front adjuster button and lift the front of the projector. Once the image is positioned where you want it, release the front adjuster button to lock the foot in position.

Do not look into the lens while the lamp is on. The strong light from the lamp may cause damage to your eyes.

Be careful when you press the adjuster button as it is close to the exhaust vent where hot air comes from.

2. Screw the rear adjuster foot to fine tune the horizontal angle.

To retract the foot, hold up the projector while pressing the front adjuster button, then slowly lower the projector. Screw the rear adjuster foot in a reverse direction.

If the screen and the projector are not perpendicular to each other, the projected image becomes vertically trapezoidal. To correct this situation, adjust the value of Keystone in the Picture menu, on the projector control panel, or on the remote control.

Auto-adjusting the image

In some cases, you may need to optimize the picture quality. To do this, press **AUTO** on the control panel of the projector or on the remote control. Within 3 seconds, the built-in Intelligent Auto Adjustment function will re-adjust the values of Frequency and Clock to provide the best picture quality.

The current source information will be displayed at the bottom right of the screen for 3 seconds.

This function only works when a computer source is connected.

The screen will be blank while Auto is functioning.

Fine-tuning the image size and clarity

1. Adjust the projected image to the size that you need using the zoom ring.
2. Then sharpen the image by rotating the focus ring.

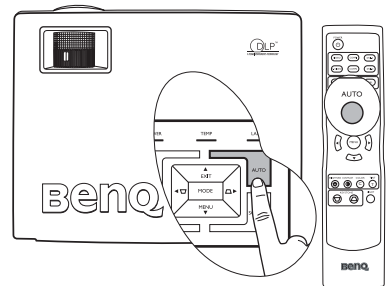
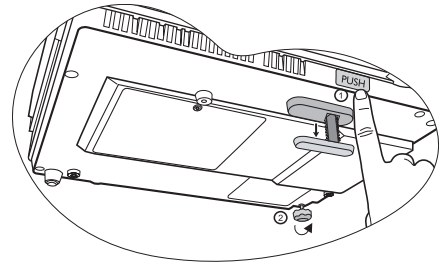
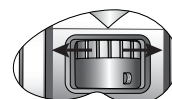
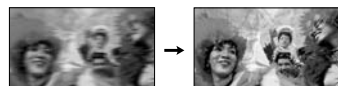
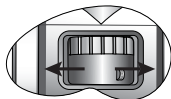

Correcting keystone

Keystoning refers to the situation where the projected image is noticeably wider at either the top or bottom. It occurs when the projector is not perpendicular to the screen.

To correct this, besides adjusting the projecting angle of the projector, you will need to manually correct it following ONE of these steps.

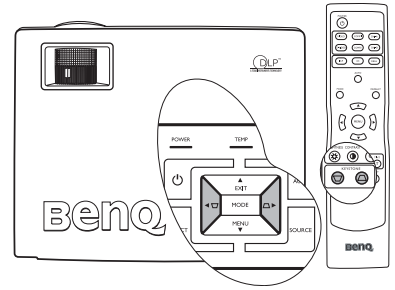

- Press ◀ / ▽ or ▴ / ▶ on the projector to display the status bar labelled Keystone. Press ◀ / ▽ to correct keystoning at the top of the image. Press ▴ / ▶ to correct keystoning at the bottom of the image.
- Press ▽ or ▴ on the remote control to display the status bar labelled Keystone, then press ▽ to correct keystoning at the top of the image or press ▴ to correct keystoning at the bottom of the image.
- Press ▼ MENU on the projector or MENU on the remote control. Go to  **Picture > Keystone** and adjust the values by pressing ◀ / ▽ / ▴ / ▶ on the projector or ◀ Left / ▶ Right on the remote control.

For example,



Keystone  0

- Press ◀ / ▽ on the projector or
- Press ▽ on the remote control or
- Press ◀ / ▽ on the projector or ◀ Left on the remote control when you are in the Picture --> Keystone menu.



Keystone  -6



Keystone  0

- Press ▴ / ▶ on the projector or
- Press ▴ on the remote control or
- Press ▴ / ▶ on the projector or ▶ Right on the remote control when you are in the Picture --> Keystone menu.



Keystone  +6

Operating in a high altitude environment

We recommend you use the High Altitude Mode when your environment is higher than 3000 feet above sea level, or is hotter than 40°C, or whenever the projector will be used for extended periods of time (>10 hours) without shutdown.

To activate the High Altitude Mode, select **On** by pressing ◀ **Left**/ ▶ **Right** on the projector or remote control. A confirmation message displays. Press **AUTO**.

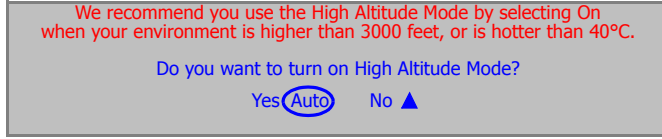

Next time you turn on the projector, it will show a message pictured below as a reminder during the start-up.

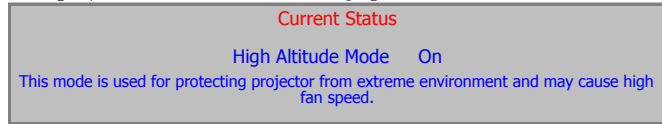

Operation under "High Altitude Mode" may cause a higher decibel operating noise level because of increased fan speed necessary to improve overall system cooling and performance.

If you use this projector under other extreme conditions excluding the above, it may display auto shut-down symptoms, which is designed to protect your projector from over-heating. In cases like this, you should switch to High Altitude mode to solve these symptoms. However, this is not to state that this projector can operate under any and all harsh or extreme conditions.

Personalizing the projector menu display

The On-Screen Display (OSD) menus can be set according to your preferences. The following settings do not affect the projection settings, operation, or performance.

- OSD Time in **Setting** menu sets the length of time the OSD will remain active after your last button press. The time length ranges from 5 to 100 seconds.
- Language in **Advance** menu sets your familiar language for the on-screen menus. Use ◀ **Left**/ ▶ **Right** on the projector or remote control to select your language.
- Splash Screen in **Advance** menu allows you to set a preferred logo screen to be displayed during projector start-up.

Optimizing the image

To optimize the image, use the buttons on the projector or remote control, or use the on-screen menus. For the operation of on-screen menus, refer to "Using the menus" on page 30.

The following instructions are optional. You do not need to follow every step. It depends on the image quality you desire.

1. Selecting the aspect ratio

The "aspect ratio" is the ratio of the image width to the image height. Digital TV is usually in 16:9 ratio, which is the default for this projector, and most analog TV are in 4:3 ratio.

You can change the projected image ratio (no matter what aspect the source is) by using the Aspect buttons on the remote control, pressing the **ASPECT** button on

the projector, or changing the ratios in the  **Pro-Picture > Aspect Ratio** menu. Select an aspect ratio to suit the format of the signal and your display requirements. There are three aspect ratios available.

 In the pictures below, the grey portions are inactive areas and the white portions are active areas.

1. 16:9 (default): Scales an image so that it is displayed in the center of the screen with a 16:9 aspect ratio. This is most suitable for images which are already in a 16:9 aspect, like high definition TV, as it displays them without aspect alteration.

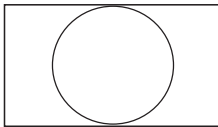

2. 4:3: Scales an image so that it is displayed in the center of the screen with a 4:3 aspect ratio. This is most suitable for 4:3 images like standard definition TV and 4:3 aspect DVD movies, as it displays them without aspect alteration.

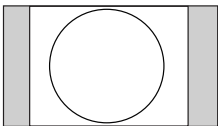

3. Real: One-to-one mapping is performed on the input signal without any scaling with the image displayed in the center of the screen.

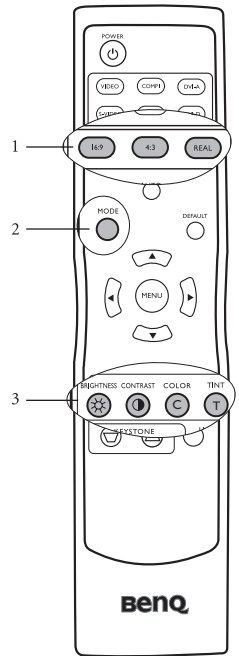
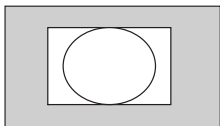

2. Selecting an application mode

The projector is preset with several predefined application modes so that you can choose one to suit your operating environment and input source picture type. To select a operation mode that suits your need, press MODE. The picture modes available for different types of signals are shown below.

PC/ DVI-A Signal Input

1. **Brightest Mode:** Maximizes the brightness of the projected image. This mode is suitable for environments where extra-high brightness is required, such as using the projector in well lit rooms.
2. **Presentation Mode (Default):** Is designed for presentations. The brightness is emphasized in this mode to match PC and notebook coloring.
3. **Photo Mode:** designed for viewing digital pictures in a living room.
4. **Gaming Mode:** Is suitable for playing PC-based games in a bright living room.
5. **Video Mode:** Is appropriate for playing movies, video clips from digital cameras or DVs through the PC input for best viewing in a blackened (little light) environment.

DVI-D/ YPbPr/ S-Video/ Video Signal Input

1. **Home Theater Mode (Default):** is slightly brighter than Cinema Mode, and suitable for use in rooms where there is a small amount of ambient light.
2. **Cinema Mode:** with well-balanced color saturation and contrast with a low brightness level. This is most suitable for enjoying movies in a totally dark environment (as you would find in a commercial cinema).
3. **Gaming Mode:** is suitable for playing video games in a bright living room.
4. **Photo Mode:** designed for viewing digital pictures in a living room.
5. **Family Room:** Brightness is emphasis in this mode and is best suited for use in rooms with normal lighting levels. It is good for watching TV programs, playing games or seeing bright movies.

3. Other adjustments

The following adjustments are accessible either on the remote control or through the OSD system.

- To use the remote control, press the button which labels the function you need.
- To use the OSD system, press the **MENU** button and go to the  **Picture** menu. Highlight the function you need by pressing **▲ Up** or **▼ Down**.

1. Adjusting brightness

To adjust the value, press **◀ Left/ ▶ Right** on remote control or projector.

The higher the value, the brighter the image. And lower the setting, darker the image. Adjust this control so the black areas of the image appear just as black and that detail in the dark areas is visible.

It is possible that you may see the center of the projected image is slightly brighter than the corners. This is a normal behavior because the projector doesn't carry brightness evenly throughout the image it projects, which causes an uneven distribution of light output on the image you see.



2. Adjusting contrast

To adjust the value, press ◀ **Left**/ ▶ **Right** on remote control or projector.

The higher the value, the greater the contrast. Use this to set the peak white level after you have previously adjusted the Brightness setting to suit your selected input and viewing environment.



3. Adjusting color

This function is only available when certain input sources are in use.

To adjust the value, press ◀ **Left**/ ▶ **Right** on remote control or projector.

The higher the value, the more vivid and brighter the color. Use this to increase or decrease the color intensity of the image.

4. Adjusting tint

This function is only available when certain input sources are in use.

To adjust the value, press ◀ **Left**/ ▶ **Right** on remote control or projector.

The higher the value, the more greenish the image becomes. The lower the value, the more reddish the image becomes. Use this to adjust the color tones of the image.

5. Selecting a color temperature

This function is only accessible through the OSD system.

To select a preferred color temperature, press ◀ **Left**/ ▶ **Right** on remote control or projector.

There are four color temperature* settings available.

1. **T1:** With the highest color temperature, T1 makes the image appear the most bluish white than other settings.
2. **T2:** Makes images appear bluish white.
3. **T3:** Maintains normal colorings for white.
4. **T4:** Makes images appear reddish white.

*About color temperatures:

There are many different shades that are considered to be “white” for various purposes. One of the common methods of representing white color is known as the “color temperature”. A white color with a low color temperature appears to be reddish white. A white color with a high color temperature appears to have more blue in it.

Shutting down the projector

1. Press **Power** and a prompt message appears. Press **Power** a second time to turn the projector off. If you don't want to turn it off, wait a few seconds for the message to disappear.
2. The **Power indicator light** flashes orange and the lamp shuts down, the fans continue to run for approximately 90 seconds to cool down the projector.

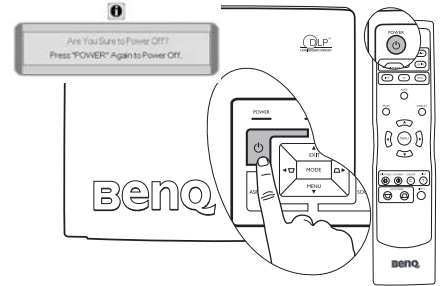

- **To protect the lamp, the projector will not respond to any commands during the cooling process.**
 - **To shorten the cooling time, you can also activate the Quick cooling function. See "Quick Cooling" on page 34 for details.**
3. Disconnect the power cord from the wall socket.
- **Do not unplug the power cord before the projector shutdown sequence is complete or during the cooling down process.**
 - **If the projector is not properly shut down, to protect the lamp, when you attempt to re-start the projector, the fans will run for a few minutes to cool down. Press **Power** again to start the projector after the fans stop.**

Menu operation

Using the menus

The projector is equipped with multilingual on screen display (OSD) menus for making various adjustments and settings. You can set your OSD language in the **Advance > Language** menu before browsing through the menus. There are 17 different menu languages for your choice. See "4. Advance menu" on page 35 for details.

The following example describes the adjustment of the keystone.

1. Press **MENU** on the projector or remote control to turn the on-screen menu on.
4. Adjust keystone values by pressing **Left/ Right** on the projector or remote control.

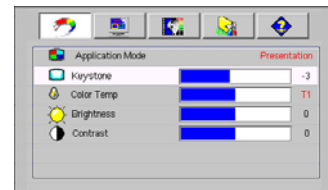
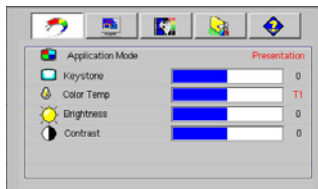



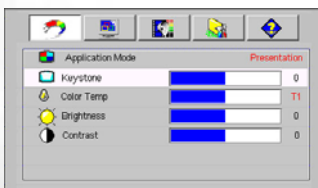

2. Use **Left/ Right** on the projector or remote control to select the **Picture** menu.
3. Press **Up/ Down** on the projector or remote control to select **Keystone**.
5. Press **Up** on the projector repeatedly or press **MENU** once on the remote control to leave and save the setting.



Menu system

Please note that the on-screen display (OSD) menus vary according to the signal type selected.

Functions available when receiving different signal types...				
Sub-Menu	PC / DVI-A	DVI-D	Video / S-Video	Component Video
 Picture	Application Mode Keystone Color Temp Brightness Contrast		Application Mode Keystone Color Temp Brightness Contrast Color Tint*	
 Pro-Picture	Aspect Ratio H Position V Position Phase H. Size	IRE Aspect Ratio	IRE Aspect Ratio Sharpness	
 Setting	Mute Volume OSD Time Quick Cooling Reset			
 Advance	Mirror Source Scan Language Splash Screen High Altitude Mode Auto Off Economic Mode			
 Information	Source Resolution Application Mode Equivalent Lamp Hour		Source System Application Mode Equivalent Lamp Hour	Source Resolution Application Mode Equivalent Lamp Hour

*When a Video or S-Video signal is connected, the function is only available with NTSC system selected.



1. Picture menu

 Some picture adjustments are available only when certain input sources are in use. Unavailable adjustments are not shown on the screen.

FUNCTION (default setting / value)	DESCRIPTION
Application Mode (PC/DVI-A: Presentation; YPbPr/ S-Video/ Video/ DVI-D: Home Theater)	Pre-defined application modes are provided so you can optimize your projector image set-up to suit your program type. You can use the remote control MODE button to select a predefined application mode as well. See " 2. Selecting an application mode " on page 28 for details.
Keystone (0)	Corrects any keystone of the image. See " Correcting keystone " on page 25 for details.
Color Temp (depends on the selected Application mode)	Sets a preferred color temperature. See " 5. Selecting a color temperature " on page 29 for details.
Brightness (depends on the selected input source)	Adjusts the brightness of the image. See " 1. Adjusting brightness " on page 28 for details.
Contrast (depends on the selected input source)	Adjusts the degree of difference between dark and light in the image. See " 2. Adjusting contrast " on page 29 for details.
Color (depends on the selected input source)	Increases or decreases the color intensity of the image. See " 3. Adjusting color " on page 29 for details.
Tint (50)	Adjusts the color tones of the image. See " 4. Adjusting tint " on page 29 for details.  When a Video or S-Video signal is connected, the function is only available with NTSC system selected.

2. Pro-Picture menu

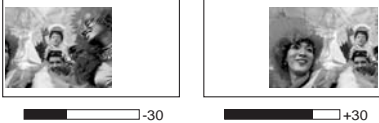
 Some picture adjustments are available only when certain input sources are in use. Unavailable adjustments are not shown on the screen.

FUNCTION (default setting / value)	DESCRIPTION
IRE (0)	The grayscale video signal is measured in IRE units. In some areas which use NTSC TV standard, the grayscale is measured from 7.5 IRE (black) to 100 IRE (white); however, in other areas which use PAL equipment or Japanese NTSC standard, the grayscale is measured from 0 IRE (black) to 100 IRE (white). We suggest that you check the input source if it is started with 0 IRE or 7.5 IRE, then select accordingly.
Aspect Ratio (16:9)	There are three aspect ratio settings. See "1. Selecting the aspect ratio" on page 27 for details. 1. 16:9 (for a wide screen) 2. Real 3. 4:3 (for a standard screen)  16:9 aspect ratio is only sourced through the Component Video input when being fed an appropriate 16:9 aspect signal. See "Connecting a Component Video source device" on page 20 and "Obtaining a preferred projected image size" on page 13 for details.
H Position (0)	Adjusts the horizontal position of the projected image. 
V Position (0)	Adjusts the vertical position of the projected image. 
Phase (depends on the selected input source)	This function allows you to adjust the clock phase to reduce image distortion. 
H Size (0)	Adjusts the horizontal width of the image.
Sharpness (15)	Adjusts the image to make it look sharper or softer.

3. Setting menu

FUNCTION (default setting / value)	DESCRIPTION
Mute (off)	Toggles projector audio between on and off.
Volume (5)	Adjusts audio volume level.
OSD Time (10)	Sets the length of time the OSD will remain active after your last button press. The range is from 5 to 100 seconds.
Quick Cooling (off)	Enables or disables the Quick Cooling function. Selecting On enables the function and projector cooling time will be shortened from a normal 90-second duration to approximately 30 seconds.
Reset	Returns all settings to the factory preset values.  The following settings will still remain: Mirror, Language, High Altitude Mode, Phase and H Position.

4. Advance menu

FUNCTION (default setting / value)	DESCRIPTION
Mirror (Floor front)	The projector can be installed on a ceiling or behind a screen, or with one or more mirrors. Contact your dealer for the ceiling mount bracket (optional accessory) if you need to install the projector on your ceiling. Refer to " Choosing a location " on page 12 and " Safety instructions for ceiling mounting of the projector " on page 13 for more information.
Source Scan (on)	Sets whether the projector searches automatically for input signals. If the source scan is On , the projector will scan for input signals until it acquires a signal. If the function is not activated, the projector selects the last used input signal. The default value is 'DVI-A'.
Language (English)	Sets the language for the OSD control menus. There are 17 languages available: English, French, German, Italian, Spanish, Russian, Traditional Chinese, Simplified Chinese, Japanese, Korean, Swedish, Dutch, Turkish, Czech, Portuguese, Thai, and Polish. Use ◀ Left/ ▶ Right on the projector or remote control to select your desired language.
Splash Screen (BenQ logo)	Allows you to select which logo screen will display during projector start-up. Three modes are available: Default (BenQ logo), black screen or blue screen.
High Altitude Mode (off)	A mode for operation in areas like high altitude or high temperature. See " Operating in a high altitude environment " on page 26 for details.
Auto Off (off)	This function allows the projector to turn off automatically if no input signal is detected after a set period of time. Press ◀ Left/ ▶ Right on the projector or remote control to set the duration before the projector is turned off. Selecting Off disables this function.
Economic Mode (off)	Use this mode to reduce system noise and reduce power consumption by 20%. If this mode is activated, the light output will be reduced and result in darker projected images.  Setting the projector in Economic mode extends the lamp timer automatic shutdown feature. For more information on how the total lamp hour is calculated, see "Calculation of lamp hour" on page 38.

5. Information menu

This menu shows you the current operating status of the projector.

 Some picture adjustments are available only when certain input sources are in use. Unavailable adjustments are not shown on the screen.

FUNCTION	DESCRIPTION
Source	Shows the current signal source.
Resolution	Shows the native resolution of the input signal.
Application Mode	Shows the selected mode in the  Picture menu.
Equivalent Lamp Hour	Displays the number of hours the lamp has been used.
System	Shows the Video input system format, NTSC, SECAM or PAL.

Maintenance

Care of the projector

Your projector needs little maintenance. The only thing you need to do on a regular basis is to keep the lens clean.

Never remove any parts of the projector except the lamp. Contact your dealer if other parts need replacing.

Cleaning the lens

Clean the lens whenever you notice dirt or dust on the surface.

- Use a canister of compressed air to remove dust.
- If there is dirt or smears, use lens-cleaning paper or moisten a soft cloth with lens cleaner and gently wipe the lens surface.

 **Never rub the lens with abrasive materials.**

Cleaning the projector case

Before you clean the case, turn the projector off using the proper shutdown procedure as described in "[Shutting down the projector](#)" on page 30 and unplug the power cord.

- To remove dirt or dust, wipe the case with the supplied cleaning cloth.
- To remove stubborn dirt or stains, moisten a soft cloth with water and a neutral pH detergent. Then wipe the case.

 **Never use wax, alcohol, benzene, thinner or other chemical detergents. These can damage the case.**

Storing the projector

If you need to store the projector for an extended time, please follow the instructions below:

- Make sure the temperature and humidity of the storage area are within the recommended range for the projector. Please refer to "[Specifications](#)" on page 44 or consult your dealer about the range.
- Retract the adjuster feet.
- Remove the batteries from the remote control.
- Pack the projector in its original packing or equivalent.

Transporting the projector

It is recommended that you ship the projector with its original packing or equivalent. When you carry the projector yourself, please use the original box or provided soft carry case.

Lamp information

Calculation of lamp hour

When the projector is in operation, the duration (by hours) of lamp usage is automatically calculated by the built-in timer. The method of calculating the equivalent lamp hour is as follows:

Total (equivalent) lamp hour = 3/4 (hours used in Economic mode) + 1 (hours used in normal mode)

See "[Economic Mode](#)" on page 35 for more information on Economic mode.

The lamp hour in Economic mode is calculated as 3/4 of that in normal mode. That is, using the projector in Economic mode helps to extend the lamp hour by 1/3.





Warning message

When the **Lamp indicator** lights up red or a message appears suggesting it is time to replace the lamp, please install a new lamp or consult your dealer. An old lamp may cause a malfunction in the projector and in some instances the lamp may explode.

For more detailed information on projector warnings, please refer to "[Indicators](#)" on page 41.

 **The Lamp indicator light and Temperature warning light will light up if the lamp becomes too hot. Turn the power off and let the projector cool for 45 minutes. If the Lamp or Temp indicator still lights up after turning the power back on, please contact your dealer.**

The following Lamp warning displays will remind you to change the lamp.

Message	Status
	The lamp has been in operation for 2800 hours. Install a new lamp for optimal performance. If the projector is normally run with "Economic Mode" selected (See " Economic Mode " on page 35), you may continue to operate the projector until the 2950 hour lamp warning appears.
	The lamp has been in operation for 2950 hour. A new lamp should be fitted to avoid the inconvenience when the projector runs out of lamp time.
	The lamp has been in operation for over 3000 hours. This message will flash in the center of the screen for about 30 seconds together with the Lamp indicator lighting up red for 40 seconds. It is strongly recommended that you replace the lamp at this age. The lamp is a consumable item. Its timer in the projector helps provide information on the calculated lamp usage time. With the usage time increase, the lamp brightness diminished gradually. This is normal lamp behaviour. You can replace the lamp whenever you notice that the brightness level has significantly diminished. If the lamp is not replaced beforehand, it must be replaced after 3000 hours usage.
	If this warning message displays, the projector will shut down in 40 seconds. The lamp MUST be replaced before the projector will operate normally.

Replacing the lamp

- ⚠ • **To reduce the risk of electrical shock, always turn the projector off and disconnect the power cord before changing the lamp.**
- **To reduce the risk of severe burns, allow the projector to cool for at least 45 minutes before replacing the lamp.**
- **To reduce the risk of injuries to fingers and damage to internal components, use caution when removing lamp glass that has shattered into sharp pieces.**
- **To reduce the risk of injuries to fingers and/or compromising image quality by touching the lens, do not touch the empty lamp compartment when the lamp is removed.**
- **This lamp contains mercury. Consult your local hazardous waste regulations to dispose of this lamp in a proper manner.**

1. Turn the power off and disconnect the projector from the wall socket. If the lamp is hot, avoid burns by waiting for approximately 45 minutes until the lamp has cooled.
2. Protect the projector's surface by clearing a flat open area on your desk and placing a soft item on the desk for padding.
3. Turn the projector over. Then loosen the screw on the lamp cover. Be careful not to lose the screw as it is needed to hold the lamp cover in place. It is strongly recommended that you use a magnetic-head screwdriver.

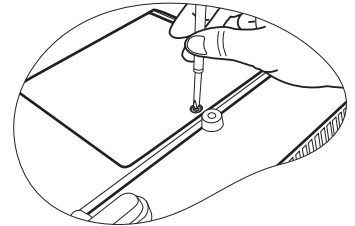

4. Remove the lamp cover from the projector.

⚠ **Do not turn the power on with the lamp cover removed.**

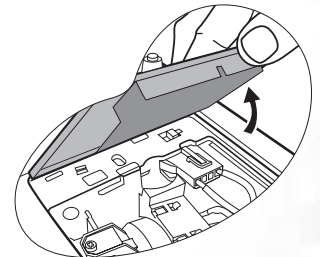

5. Disconnect the lamp connector from the projector.

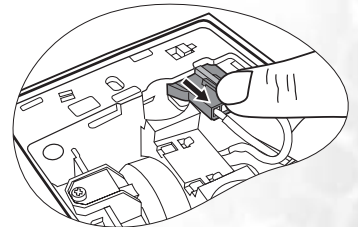

6. Loosen the screw that secures the lamp. Be careful not to lose the screw as it is needed to hold the lamp in place. It is strongly recommended that you use a magnetic-head screwdriver.

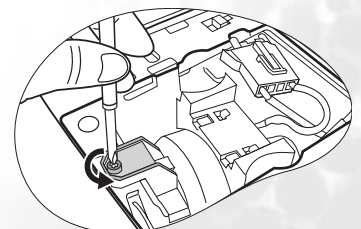

7. Pull the lamp from the projector.



- **Pulling it too quickly may cause the lamp to break and scatter broken glass in the projector.**
- **Do not place the lamp in locations where water might splash on it, children can reach it, or near flammable materials.**
- **Do not insert your hands into the projector after the lamp is removed. If you touch the optical components inside, it could cause color unevenness and distortion of the projected images.**

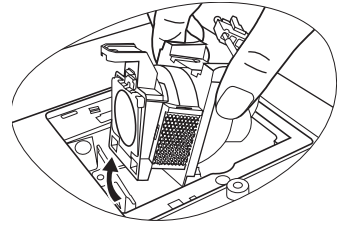

8. As shown in the figure, hold the new lamp and align the two locators on the lamp with the holes on the projector, and then insert the lamp all the way into the projector.

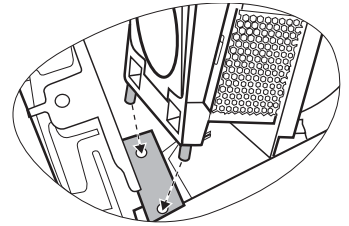

9. Connect the lamp connector to the projector.

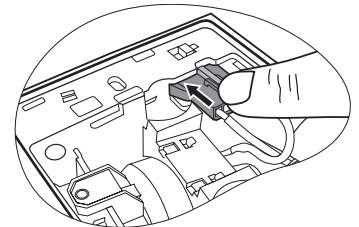

10. Tighten the screw that secures the lamp.



- **Loose screw may cause a bad connection, which could result in malfunction.**
- **Do not over tighten the screw.**

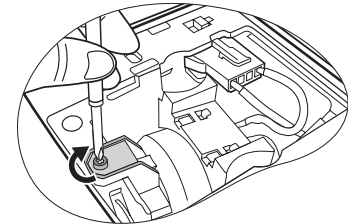

11. Replace the lamp cover on the projector.

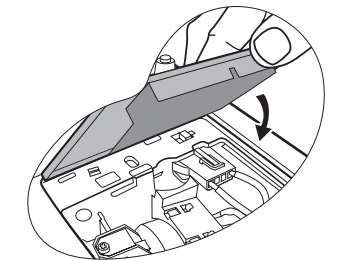

12. Tighten the screw that secures the lamp cover.



- **Loose screw may cause a bad connection, which could result in malfunction.**
- **Do not over tighten the screw.**

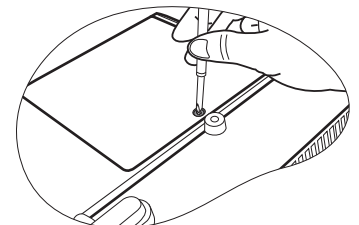

13. Restart the projector.



Do not turn the power on with the lamp cover removed.

14. Resetting the lamp counter

 **Do not reset if the lamp is not replaced as this could cause damage.**

- i. Press and hold the ▲ **EXIT** button on the projector for 5 seconds to display the total used lamp time.
- ii. Press **AUTO** on the projector or on the remote control to reset the lamp hour to “0”.
- iii. Wait about 5 seconds to let the OSD disappear.

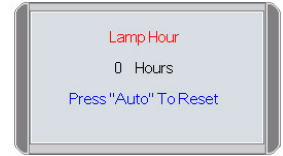

Temperature information

When the Temperature warning light is on, it is warning you of the following possible problems:





1. The internal temperature is too high.
2. The fans are not working.



Turn the projector off and contact qualified service personnel for further help. For more information, please refer to "Indicators" below.

















Indicators

Illustration

- Blank - : Light OFF
-  : Light flashing
-  : Light ON
- **O** : Orange light
- **R** : Red light
- **G** : Green light

Light			Status & Description
Power	Temp	Lamp	
Power events			
	-	-	Stand-by mode.
	-	-	The Power indicator light is flashing during powering up.
	-	-	The projector is under normal operation.
	-	-	1. The projector needs 90 seconds to cool down as it was abnormally shut down without the normal cooling down process. Or 2. The projector needs to cool for 90 seconds after the power is turned off.
	-	-	The projector has shutdown automatically. If you try to re-start the projector, it will shutdown again. Please contact your dealer for assistance.

Light			Status & Description
Power	Temp	Lamp	
Lamp events			
	-		The projector has shutdown automatically. If you try to re-start the projector, it will shutdown again. Please contact your dealer for assistance.
-	-		1. The projector needs 90 seconds to cool down. Or 2. Please contact your dealer for assistance.

Thermal events			
-		-	The projector has shutdown automatically. If you try to re-start the projector, it will shutdown again. Please contact your dealer for assistance.
-			
-			
			
			
			
-			

7 Troubleshooting

② THE PROJECTOR DOES NOT TURN ON.

Cause	Remedy
There is no power from the power cable.	Plug the power cord into the AC inlet on the projector, and plug the power cord into the power outlet. If the power outlet has a switch, make sure that it is switched on.
Attempting to turn the projector on again during the cooling process.	Wait until the cooling down process has completed.

② NO PICTURE

Cause	Remedy
The video source is not turned on or connected correctly.	Turn the video source on and check that the signal cable is connected correctly.
The projector is not correctly connected to the input source device.	Check the connection.
The input signal has not been correctly selected.	Select the correct input signal with the SOURCE button on the projector or the Source buttons on the remote control.
The lens cap is still attached to the lens.	Remove the lens cap.

② BLURRED IMAGE

Cause	Remedy
The projection lens is not correctly focused.	Adjust the focus of the lens using the focus ring.
The projector and the screen are not aligned properly.	Adjust the projection angle and direction as well as the height of the projector if necessary.
The lens cap is still attached to the lens.	Remove the lens cap.

② REMOTE CONTROL DOES NOT WORK

Cause	Remedy
The batteries are out of power.	Replace the batteries with new ones.
There is an obstacle between the remote control and the projector.	Remove the obstacle.
You are too far away from the projector.	Stand within 6 meters (19.5 feet) of the projector.

8 Specifications

Projector specifications

 All specifications are subject to change without notice.

General

Product name	Digital Projector
Model name	W100

Optical

Resolution	854 x 480 480P
Display system	1-CHIP DMD
Lens F/Number	F=2.6 to 2.77, f= 20.4 to 23.5 mm
Lamp	200W lamp

Electrical

Power supply	AC 100–240V, 1.5A–3.2A, 50/60 Hz (Automatic)
Power consumption	285W (Max)

Mechanical

Weight	6 lbs (2.724 Kg)
--------	------------------

Input terminal

Computer input	
RGB input	DVI-I x 1 (using DVI-A signal)
Video signal input	
S-VIDEO	Mini DIN 4-pin port x 1
VIDEO (composite)	RCA x 1
SD/HDTV signal input	Analog – Component x 2 Digital – DVI (HDTV only)
Audio signal input	
Audio in	Mini jack stereo port

Output

Speaker	(mixed mono) 2 watt x 1
---------	-------------------------

Environmental Requirements

Operating temperature	0°C ~ 40°C at sea level
Operating relative humidity	10% ~ 90% (without condensation)
Operating altitude	0–3000 feet at 0°C–40°C 3000–6000 feet at 0°C–30°C 6000–10000 feet at 0°C–23°C

Dimensions

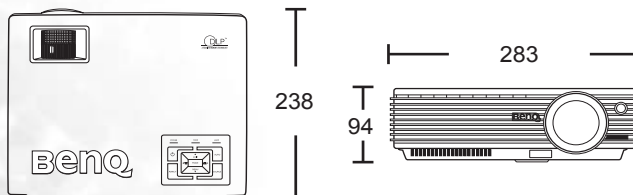

Unit: mm

Timing chart

Supported timing for PC input

Resolution	Horizontal Frequency (kHz)	Vertical Frequency (Hz)	Pixel Frequency (MHz)	Mode
640 x 400	31.47	70.089	25.176	640 x 400_70
640 x 480	31.469	59.940	25.175	VGA_60
	37.861	72.809	31.500	VGA_72
	37.500	75.000	31.500	VGA_75
	43.269	85.008	36.000	VGA_85
800 x 600	37.879	60.317	40.000	SVGA_60
	48.077	72.188	50.000	SVGA_72
	46.875	75.000	49.500	SVGA_75
	53.674	85.061	56.250	SVGA_85
1024 x 768	48.363	60.004	65.000	XGA_60
	56.476	70.069	75.000	XGA_70
	60.023	75.029	78.750	XGA_75
	68.667	84.997	94.500	XGA_85
1280 x 1024	63.981	60.020	108.000	SXGA_60

Supported timing for Component-YPbPr input

Signal Format	Horizontal Frequency (kHz)	Vertical Frequency (Hz)
480i(525i)@60Hz	15.73	59.94
480p(525p)@60Hz	31.47	59.94
576i(625i)@50Hz	15.63	50.00
576p(625p)@50Hz	31.25	50.00
720p(750p)@60Hz	45.00	60.00
720p(750p)@50Hz	37.50	50.00
1080i(1125i)@60Hz	33.75	60.00
1080i(1125i)@50Hz	28.13	50.00

Supported timing for Video and S-Video inputs

Video mode	Horizontal Frequency (kHz)	Vertical Frequency (Hz)	Color sub-carrier Frequency (MHz)
NTSC	15.73	60	3.58
PAL	15.63	50	4.43
SECAM	15.63	50	4.25 or 4.41
PAL-M	15.73	60	3.58
PAL-N	15.63	50	3.58
PAL-60	15.73	60	4.43
NTSC4.43	15.73	60	4.43

Warranty

Limited warranty

BenQ warrants this product against any defects in material and workmanship, under normal usage and storage.

Proof of purchase date will be required with any warranty claim. In the event this product is found to be defective within the warranty period, BenQ's only obligation and your exclusive remedy shall be replacement of any defective parts (labor included). To obtain warranty service, immediately notify the dealer from which you purchased the product of any defects.

Important: The above warranty shall be void if the customer fails to operate the product in accordance with BenQ's written instructions, especially the ambient humidity must be in-between 10% and 90%, temperature in-between 0°C and 40°C, altitude lower than 10000 feet, and avoiding to operate the projector in a dusty environment. This warranty gives you specific legal rights, and you may have other rights which vary from country to country.

For other information, please visit support.BenQ.com.

10 Notices

Copyright

Copyright 2006 by BenQ Corporation. All rights reserved. No part of this publication may be reproduced, transmitted, transcribed, stored in a retrieval system or translated into any language or computer language, in any form or by any means, electronic, mechanical, magnetic, optical, chemical, manual or otherwise, without the prior written permission of BenQ Corporation.

Disclaimer

BenQ Corporation makes no representations or warranties, either expressed or implied, with respect to the contents hereof and specifically disclaims any warranties, merchantability or fitness for any particular purpose. Further, BenQ Corporation reserves the right to revise this publication and to make changes from time to time in the contents hereof without obligation to notify any person of such revision or changes.

*DLP, Digital Micromirror Device and DMD are trademarks of Texas Instruments. Others are copyrights of their respective companies or organizations.