

DPX-830

Digital Cinema Projector
Projecteur Cineme Numerique

HDMITM
HIGH DEFINITION MULTIMEDIA INTERFACE

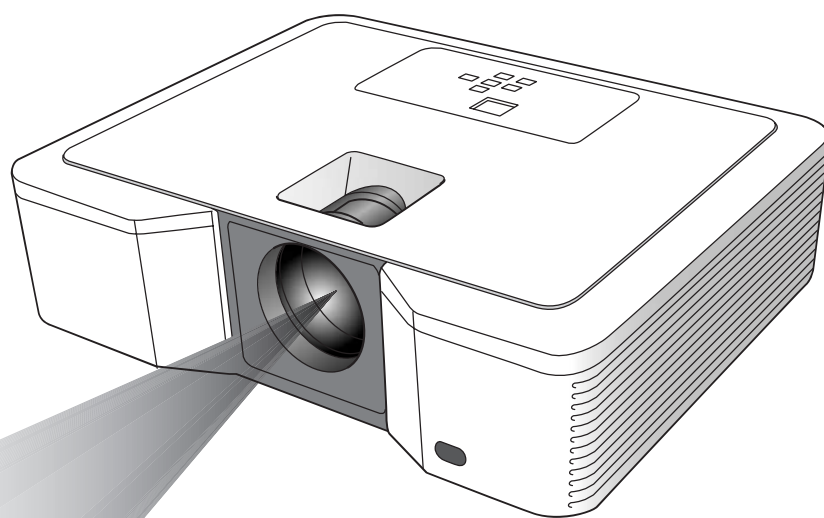

OWNER'S MANUAL
MODE D'EMPLOI
BEDIENUNGSANLEITUNG
BRUKSANVISNING
MANUALE DI ISTRUZIONI
MANUAL DE INSTRUCCIONES
GEBRUIKSAANWIJZING
ИНСТРУКЦИЯ ПО ЭКСПЛУАТАЦИИ

ENGLISH

FRANÇAIS

DEUTSCH

SVENSKA



ITALIANO

ESPAÑOL

NEDERLANDS

РУССКИЙ

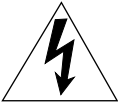
IMPORTANT SAFETY INSTRUCTIONS

	CAUTION RISK OF ELECTRIC SHOCK DO NOT OPEN	
CAUTION: TO REDUCE THE RISK OF ELECTRIC SHOCK, DO NOT REMOVE COVER (OR BACK). NO USER-SERVICEABLE PARTS INSIDE. REFER SERVICING TO QUALIFIED SERVICE PERSONNEL.		

• Explanation of Graphical Symbols

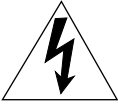

The lightning flash with arrowhead symbol, within an equilateral triangle, is intended to alert you to the presence of uninsulated “dangerous voltage” within the product’s enclosure that may be of sufficient magnitude to constitute a risk of electric shock to persons.



The exclamation point within an equilateral triangle is intended to alert you to the presence of important operating and maintenance (servicing) instructions in the literature accompanying the appliance.

WARNING

TO REDUCE THE RISK OF FIRE OR ELECTRIC SHOCK, DO NOT EXPOSE THIS UNIT TO RAIN OR MOISTURE.

For Canadian customers

To prevent electric shock, match wide blade of plug to wide slot and fully insert.
This Class B digital apparatus complies with Canadian ICES-003.

IMPORTANT!

Please record the serial number of this unit in the space below.
Model:
Serial No.:
The serial number is located on the bottom of the unit.
Retain this Owner’s Manual in a safe place for future reference.

Please read all these instructions regarding your projector and retain them for future reference. Follow all warnings and instructions marked on the projector.

- 1 Read instructions:** All the safety and operating instructions should be read before the appliance is operated.
- 2 Retain instructions:** The safety and operating instructions should be retained for future reference.
- 3 Warnings:** All warnings on the appliance and in the operating instructions should be adhered to.
- 4 Instructions:** All operating instructions must be followed.
- 5 Cleaning:** Unplug this projector from the wall outlet before cleaning it. Do not use liquid aerosol cleaners.
- 6 Attachments and equipment:** Never add any attachments and/or equipment without the approval of the manufacturer as such additions may result in the risk of fire, electric shock or other personal injury.

7 Water and moisture: Do not use this projector near water or in contact with water.

8 Accessories: Do not place this projector on an unstable cart, stand, tripod, bracket or table. Use only with a cart, stand, tripod bracket, or table recommended by the manufacturer or sold with the projector. Any mounting of the appliance should follow the manufacturer’s instructions and should use a mounting accessory recommended by the manufacturer.



An appliance and cart combination should be moved with care. Quick stops, excessive force and uneven surfaces may cause the appliance and cart combination to overturn.

9 Ventilation: Slots and openings in the cabinet are provided for ventilation, ensuring reliable operation of the projector and to protect it from overheating. Do not block these openings or allow them to be blocked by placing the projector on a bed, sofa, rug, or bookcase. Ensure that there is adequate ventilation and that the manufacturer’s instructions have been adhered to.

10 Power sources: This projector should be operated only from the type of power source indicated on the marking label. If you are not sure of the type of power, please consult your appliance dealer or local power company.

11 Power-cable protection: Power-supply cables should be routed so that they are not likely to be walked on or pinched by items placed upon or against them. Pay particular attention to cords at plugs, convenience receptacles, and points where they exit from the appliance.

12 Overloading: Do not overload wall outlets and extension cords as this can result in a fire or electric shock.

13 Objects and liquids: Never push objects of any kind through openings of this projector as they may touch dangerous voltage points or short-out parts that could result in a fire or electric shock. Never spill liquid of any kind on the projector.

14 Servicing: Do not attempt to service this projector yourself. Refer all servicing to qualified service personnel.

15 Damage requiring service: Unplug this projector from the wall outlet and refer servicing to qualified service personnel under the following conditions:

- (a) If the power-supply cable or plug is damaged.
- (b) If liquid has been spilled, or objects have fallen into the projector.
- (c) If the projector does not operate normally after you follow the operating instructions. Adjust only those controls that are covered by the operating instructions. An improper adjustment of other controls may result in damage and may often require extensive work by a qualified technician to restore the projector to its normal operation.
- (d) If the projector has been exposed to rain or water.
- (e) If the projector has been dropped or the cabinet has been damaged.
- (f) If the projector exhibits a distinct change in performance - this indicates a need for service.

16 Replacement parts: When replacement parts are required, be sure that the service technician has used replacement parts specified by the manufacturer or parts having the same characteristics as the original part. Unauthorized substitutions may result in fire, electric shock or other hazards.

17 Safety check: Upon completion of any service or repair to this projector, ask the service technician to perform safety checks determining that the projector is in a safe operating condition.

18 Connection cable: Use the supplied RS-232C and RGB cables with this equipment to keep interference within the limits of an FCC/EN55022 Class B device.

COMPLIANCE INFORMATION STATEMENT

(DECLARATION OF CONFORMITY PROCEDURE)

Responsible Party: Yamaha Electronics Corporation
Address: 6660 Orangethorpe Avenue
Buena Park, CA90620
Telephone: 714-522-9105
Fax: 714-670-0108
Type of Equipment: Projector
Model Name: DPX-830

This device complies with Part 15 of the FCC Rules.

Operation is subject to the following conditions:

- 1) this device may not cause harmful interference, and
- 2) this device must accept any interference received including interference that may cause undesired operation.

See the owner's manual instructions if interference to radio reception is suspected.

FCC INFORMATION (for US customers only)

1. IMPORTANT NOTICE: DO NOT MODIFY THIS UNIT!

This product, when installed as indicated in the instructions contained in this manual, meets FCC requirements.

Modifications not expressly approved by Yamaha may void your authority, granted by the FCC, to use the product.

- 2. IMPORTANT:** When connecting this product to accessories and/or another product use only high quality shielded cables. Cable/s supplied with this product **MUST** be used. Follow all installation instructions. Failure to follow instructions could void your FCC authorization to use this product in the USA.

- 3. NOTE:** This product has been tested and found to comply with the requirements listed in FCC Regulations, Part 15 for Class "B" digital devices. Compliance with these requirements provides a reasonable level of assurance that your use of this product in a residential environment will not result in harmful interference with other electronic devices.

This equipment generates/uses radio frequencies and, if not installed and used according to the instructions found in the users manual, may cause interference harmful to the operation of other electronic devices.

Compliance with FCC regulations does not guarantee that interference will not occur in all installations. If this product is found to be the source of interference, which can be determined by turning the unit "OFF" and "ON", please try to eliminate the problem by using one of the following measures:

Relocate either this product or the device that is being affected by the interference.

Utilize power outlets that are on different branch (circuit breaker or fuse) circuits or install AC line filter/s.

In the case of radio or TV interference, relocate/reorient the antenna. If the antenna lead-in is 300 ohm ribbon lead, change the lead-in to coaxial type cable.

If these corrective measures do not produce satisfactory results, please contact the local retailer authorized to distribute this type of product. If you can not locate the appropriate retailer, please contact Yamaha Electronics Corp., U.S.A. 6660 Orangethorpe Ave, Buena Park, CA 90620.

The above statements apply **ONLY** to those products distributed by Yamaha Corporation of America or its subsidiaries.

Caution: Read this before operating this unit.

Warning

- **This unit must be grounded**
- **Do not use this projector in a computer room**

This projector is not for use in a computer room as defined in the Standard for the Protection of Electronic Computer/Data Processing Equipment, ANIS/NFPA 75.
- **Unplug immediately if there is something wrong with your projector**

Do not operate if smoke, strange noise or odor comes out of the projector. It might cause fire or electric shock. If this happens, unplug immediately and contact your dealer.
- **Never remove the cabinet**

This projector contains high voltage circuitry. An inadvertent contact may result in an electric shock. Except as specifically explained in the owner's manual, do not attempt to service this product yourself. Contact your dealer when you want to fix, adjust or inspect the projector.
- **Do not modify this projector**

It can lead to fire or electric shock.
- **Do not continue using this projector if you drop or break it**

Unplug the projector and contact your dealer for inspection. It may lead to fire if you continue using it.
- **Do not face the projector lens towards the sun**

It can lead to fire.
- **Use correct voltage**

If you use incorrect voltage, it can lead to fire.
- **Do not place the projector on uneven or unstable surfaces**

Place the projector on a leveled and stable surface only.
- **Do not look into the lens when it is operating**

It may cause serious eye injury.
- **Do not turn off the main power abruptly or unplug the projector during operation**

It can lead to lamp breakage, fire, electric shock or other trouble. Always wait for the fan to turn off before turning the main power off.
- **Avoid all contact with the air exhaust vents and bottom plate**

The air exhaust vents and bottom plate heat up during operation and may cause personal injury or damage to other equipment. Do not touch them, place other equipment in front of the air exhaust vents, or set the projector on a desk which is easily affected by heat.
- **Do not look into the air exhaust vent when the projector is operating**

Heat, dust, etc. may blow out of it and cause injury to your eyes.
- **Do not block the air intake and exhaust vents**

If they are blocked, heat may be generated inside the projector, causing deterioration in the projector quality and/or fire.

This unit is not disconnected from the AC power source as long as it is connected to the wall outlet, even if this unit itself is turned off. This state is called the standby mode. In this state, this unit is designed to consume a very small quantity of power.

Place of installation

For safety reasons, refrain from setting the projector at any place subjected to high temperature and high humidity. Maintain an operating temperature, humidity and setting as specified below:

- Operating temperature: between 41°F (5°C) and 95°F (35°C).
- Operating humidity: between 30% and 90%
- Never put any heat-producing device under the projector. The projector may overheat.
- Do not install the projector near any equipment that produces a strong magnetic field. Also refrain from installing near the projector any cable carrying a large current.
- Do not install the projector in a place that is unstable or subject to vibration; otherwise, it may fall and cause serious injury and/or damage to the unit.
- Do not stand the projector on its side; otherwise, it may fall and cause serious injury and/or damage to the unit.
- Do not tilt the projector more than 10° right/left or 15° forward/backward; otherwise, it may cause a lamp explosion.
- Do not place the projector near an air conditioning unit or heater to avoid hot air to the vents of the projector.
- Avoid installing this unit where foreign object may fall onto this unit and/or this unit may be exposed to liquid dripping or splashing. On the top of this unit, do not place:
 - Other components, as they may cause damage and/or discoloration on the surface of this unit.
 - Burning objects (i.e. candles), as they may cause fire, damage to this unit, and/or personal injury.
 - Containers with liquid in them, as they may fall and liquid may cause electrical shock to the user and/or damage to this unit.

European compliance notice

This video projector complies with the requirements of the EC Directive 89/336/EEC "EMC Directive" as amended by Directive 92/31/EEC and 93/68/EEC, and 73/23/EEC "Low Voltage Directive" as amended by Directive 93/68/EEC.

For U.K. customers

If the socket outlets in the home are not suitable for the plug supplied with this appliance, it should be cut off and an appropriate 3-pin plug fitted. For details, refer to the instructions described below.

Note

- The plug severed from the mains lead must be destroyed, as a plug with a bared flexible cord is hazardous if engaged in a live socket outlet.

IMPORTANT

THE WIRES IN THIS MAINS LEAD ARE COLOURED IN ACCORDANCE WITH THE FOLLOWING CODE:

GREEN-AND-YELLOW:	EARTH
BLUE:	NEUTRAL
BROWN:	LIVE

As the colours of the wires in the mains lead of this apparatus may not correspond with the coloured markings identifying the terminals in your plug, proceed as follows:

The wire which is coloured GREEN-AND-YELLOW must be connected to the terminal in the plug which is marked by the letter "E" or the safety earth symbol or coloured GREEN or GREEN-AND-YELLOW.

The wire which is coloured BLUE must be connected to the terminal marked with the letter "N" or coloured BLACK.

The wire which is coloured BROWN must be connected to the terminal marked with the letter "L" or coloured RED.

Table of contents

1	Getting started	2	8	Adjusting video images	27
	Inappropriate places for installation	2		Selecting the gamma mode (GAMMA)	27
	Accessory check	3		Customizing the gamma mode (GAMMA)	27
	Inserting the batteries into the remote control	4		Adjusting brightness (CONTRAST and BRIGHTNESS).....	27
2	Controls and functions	5		CONTRAST	27
	Projector overview	5		BRIGHTNESS.....	27
	Remote control overview	6		Selecting the color temperature (COLOR TEMP.)	28
	Using the picture quality adjusting buttons	6		Customizing the color temperature (COLOR TEMP.)	28
3	Using the remote control	7		About color temperature	28
	Operational range	7		Adjusting color (SATURATION and HUE)	29
	Reception angle	7		SATURATION.....	29
4	Installation	8		HUE	29
	Setting up the screen	8		Sharpening or softening images (SHARPNESS).....	29
	Mounting the projector on the table	8		LPF (Progressive filter)	29
	Adjusting the projection angle.....	8	9	MEMORY function	30
	Mounting the projector on the ceiling	9		Saving memory settings.....	30
	Screen size and projection distance	10	10	Adjusting computer images	31
5	Connections	11		Adjusting computer images.....	31
	Basic home theater system connection	11		Simple method to adjust the image position.....	31
	Connecting to a video player, etc.....	12	11	Replacing the lamp	32
	Connecting to a DVD player or HDTV decoder	12		Interval of lamp replacement.....	32
	HDMI or DVI connections	13		Replacing the lamp	33
	D-SUB connections.....	13		Maintenance.....	33
	Connecting to a computer	14	12	Attaching a lens filter and cap	34
	TRIGGER terminal.....	15		Attaching a commercially available lens filter....	34
	Plugging in the power cable	15		Attaching the lens cap.....	34
6	Projection	16	13	Troubleshooting	35
	Viewing video images	16		Troubleshooting	35
	KEYSTONE adjustment.....	17	14	Indicators	38
	IRIS button	17		Normal conditions	38
	Examples of the aspect ratio.....	18		Abnormal conditions.....	38
	Setting the aspect ratio	18	15	Specifications	39
	Viewing computer images	19		Projector specifications	39
	AUTO / AUTO SYNC buttons	20		Dimension drawings.....	41
	Connecting to a notebook computer	20			
7	Menu	21			
	Menu overview	21			
	How to set the menus	22			
	Menu settings.....	23			

1 Getting started

◆ Inappropriate places for installation

If this unit is not correctly installed in an appropriate place, it may cause fire or failure, or damage the unit itself. Carefully choose the place to install this unit by avoiding the places listed below.

1. Places where the temperature and humidity vary greatly

- Do not install this unit in a place where the temperature and humidity become extremely high or the temperature becomes extremely low.
- This unit must be used within a temperature range of 41°F (5°C) to 95°F (35°C).
- This unit must be used within a humidity range of 30% to 90%

2. Places without adequate ventilation

- Install this unit with at least 30 cm (1 feet) of ventilation space on the top, right and left, and back.
- Do not cover the ventilation slots of this unit. Covering the slots will obstruct heat dissipation.
- Install this unit on the firm surface.
- Do not cover this unit with a tablecloth, etc.
- Make sure there is nothing to get sucked into the ventilation slots so that the temperature of this unit does not become too high.
- If you are going to install the unit in a rack, be sure to leave space for ventilation to prevent exhaust overheating the unit.

3. Places where it gets dusty

- If the filter is blocked with dust, the temperature of this unit may become too high.

4. Places with too much vibration or impact

- Vibration and impact can damage parts of this unit.

5. Places where this unit gets exposed to water or high humidity

- If this unit is exposed to water of high humidity, it may cause a fire or electrical shock.

6. Unstable places

- If this unit is installed on an unstable or an inclined tabletop, it may fall and cause damage to the unit or personal injury.

7. In close proximity to a radio or stereo

- The unit may interfere with reception if placed in close proximity to a radio or television receiver.

8. Uneven surfaces

- Slanting the projector more than 10° right and left or 15° front and rear may cause problems (such as the lamp exploding).

Warning

- To ensure vivid, high contrast images, make sure that no light other than the projector light falls directly on the screen.



*DLP™, DMD™, DarkChip2™, and DarkChip3™ are registered trademarks of the Texas Instruments corporation of America.



* HDMI, the HDMI logo and High-Definition Multimedia Interface are trademarks or registered trademark of HDMI Licensing LLC.

◆ Accessory check

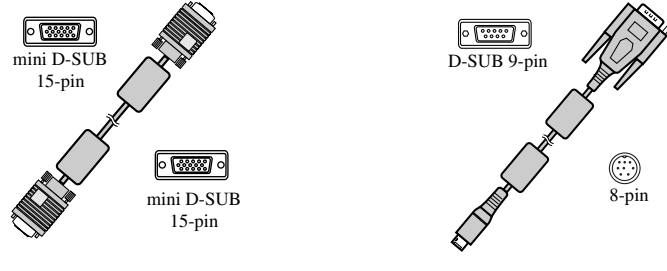
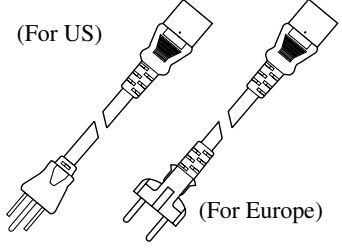
The following accessories are provided with this projector. Check to be sure that all of the accessories are packed in the package.

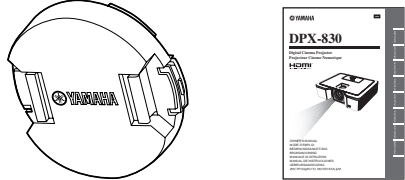
<p>■ Cables</p>  <p>mini D-SUB 15-pin</p> <p>mini D-SUB 15-pin</p> <p>D-SUB 9-pin</p> <p>8-pin</p> <p>RGB cable for PC (WF76940)</p> <p>RS-232C cable (WF76930)</p> <p>• Used for adjustment by service person.</p>	<p>■ Power supply parts</p>  <p>(For US)</p> <p>(For Europe)</p> <p>Power cable</p>
<p>■ Remote control parts</p>  <p>Remote control</p> <p>R03 (Size-AAA) battery (two)</p>	<p>■ Others</p>  <p>Lens cap</p> <p>Owner's manual</p>

Important

- The supplied power cables are to be used exclusively for this product. Never use them for other products.
- The power cables for use in the U.S. and Europe are included with this projector. Use the appropriate one for your country.
- The provided power cable for the U.S. is rated at 120 V. Never connect this cable to any outlet or power supply using other voltages or frequencies than rated. If you use a power supply using other voltage than rated, prepare an appropriate power cable separately.

◆ Inserting the batteries into the remote control

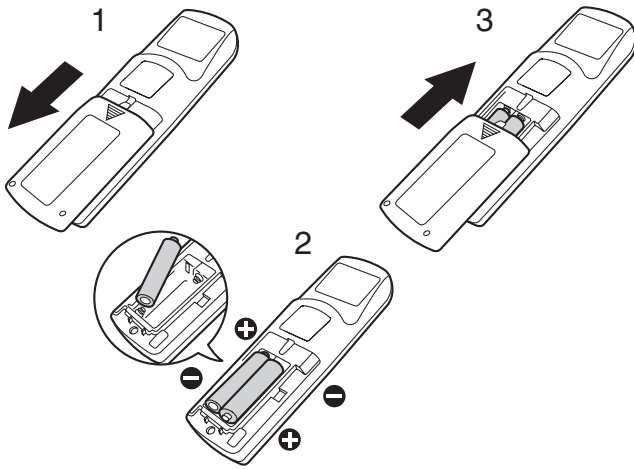

1. Remove the rear lid of the remote control.
2. Check the polarity markings (+, -) of the batteries, and set them correctly, inserting their (-) side first.
 - If the battery is inserted from the (+) side first, inserting the (-) side becomes difficult because the coil spring end hits on the battery side. If the battery is forced to insert in this way, the outer label of the battery may get ripped and cause a short-circuit and heating.
3. Attach the rear lid.

Important

- Use two size-AAA batteries (R03).
- Replace the two batteries with new ones when the remote control is slow to operate.

Caution

- Using the wrong type of battery may cause an explosion.
- Only Carbon-Zinc or Alkaline-Manganese Dioxide type batteries should be used.
- Dispose of used batteries according to your local regulations.
- Batteries may explode if misused. Do not recharge, disassemble, or dispose of in fire.
- Be sure to handle the battery according to the instructions.
- Load the battery with its positive (+) and negative (-) sides correctly oriented as indicated on the remote control.
- Keep batteries out of reach of children and pets.
- Remove the batteries, if the remote control is not used for a long time.
- Do not combine a new battery with an old one.
- If the solution of batteries comes in contact with your skin or clothes, rinse with water. If the solution comes in contact with your eyes, rinse them with water and then consult your doctor.

2 Controls and functions

◆ Projector overview

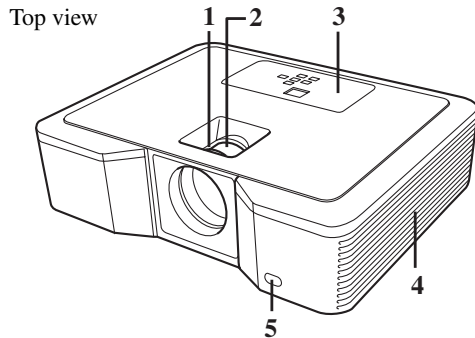

Side view

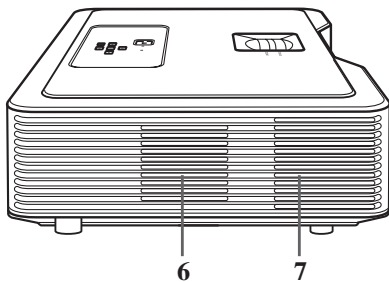

Bottom view

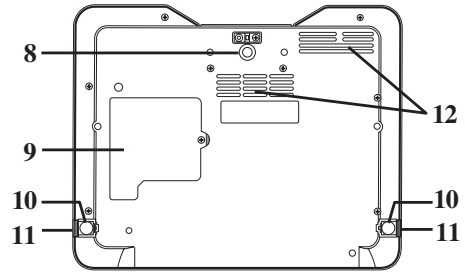

1. FOCUS ring
2. ZOOM ring
3. Control panel
4. Air intake vent
5. Remote control sensor (Front)
6. Air intake vent
7. Air exhaust vent
8. Adjustment foot (Front)
9. Lamp cover (see page 33)
10. Adjustment feet (Rear)
11. Foot adjustment buttons (Left/Right)
12. Air intake vent

Control panel

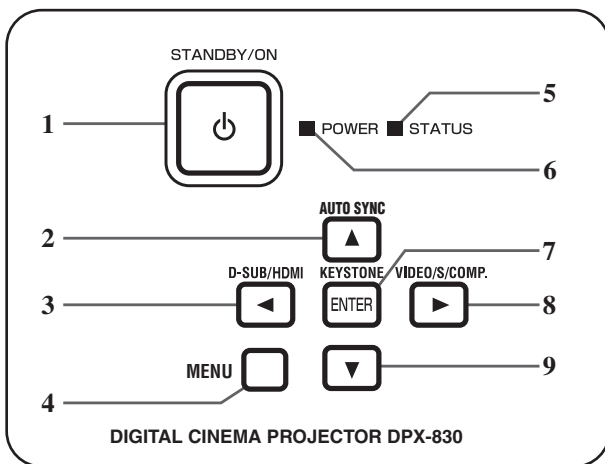

1. STANDBY/ON, button
2. AUTO SYNC, button
3. D-SUB/HDMI, button
4. MENU button
5. STATUS indicator
6. POWER indicator
7. KEYSTONE, **ENTER** button
8. VIDEO/S/COMP., button
9. button

Important

- While the menu is on the screen, the KEYSTONE button functions as the **ENTER** button and the D-SUB/HDMI, VIDEO/S/COMP., and AUTO SYNC buttons function as the , , and buttons respectively.

Rear panel

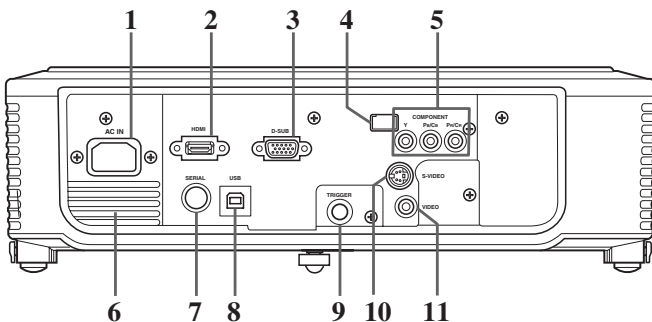

1. AC IN
2. HDMI input terminal
3. D-SUB input terminal
4. Remote control sensor (Rear)
5. COMPONENT input terminals
6. Air exhaust vent
7. SERIAL terminal
 - Used for adjustment by service person.
8. USB terminal
 - Used for adjustment by service person.
9. TRIGGER terminal
 - Used for the optional electric screen.
10. S-VIDEO input terminal
11. VIDEO input terminal

◆ Remote control overview

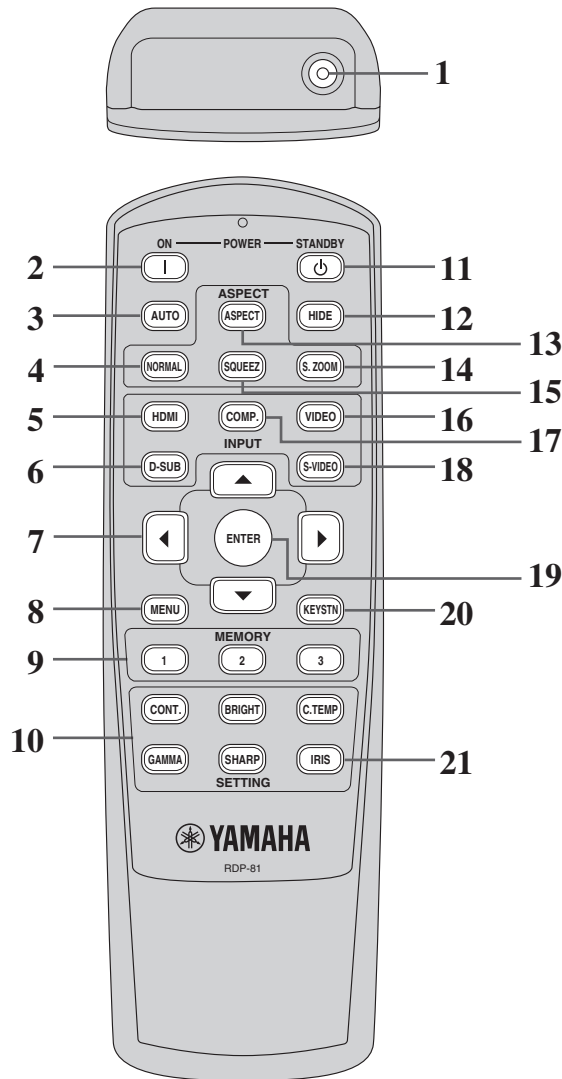

1. IR signal transmitter
2. ON (I) button
3. AUTO button
4. NORMAL button
5. HDMI button
6. D-SUB button
7. Cursor buttons (▲ / ▼ / ◀ / ▶)
8. MENU button
9. MEMORY buttons
10. The picture quality adjusting buttons*
- * See the below for the picture quality adjusting buttons.
11. STANDBY (⏻) button
12. HIDE button
13. ASPECT button
14. S. ZOOM (Smart zoom) button
15. SQUEEZ (Squeeze) button
16. VIDEO button
17. COMP. (Component) button
18. S-VIDEO button
19. ENTER button
20. KEYSTN (Keystone) button
21. IRIS button (see page 17)

Important

- When you press a button on the remote control, the buttons on the remote control will light up. Wait approximately 6 seconds after releasing the button for the lights to turn off.

Using the picture quality adjusting buttons

When you press either of the picture quality adjusting buttons, the message for adjusting the picture quality appears. Adjust the picture quality by pressing the ◀ and ▶ buttons. The picture quality adjustment can be made alternatively in the IMAGE menu (see page 23).

- CONT. (CONTRAST) Adjusts the contrast of the projected image.
- GAMMA..... Selects one of the preset gamma modes.
- BRIGHT (BRIGHTNESS) Adjusts the brightness of the projected image.
- SHARP (SHARPNESS) Adjusts the sharpness of the projected image.
- C. TEMP (COLOR TEMPERATURE) Selects one of the preset color temperatures.

3 Using the remote control

◆ Operational range

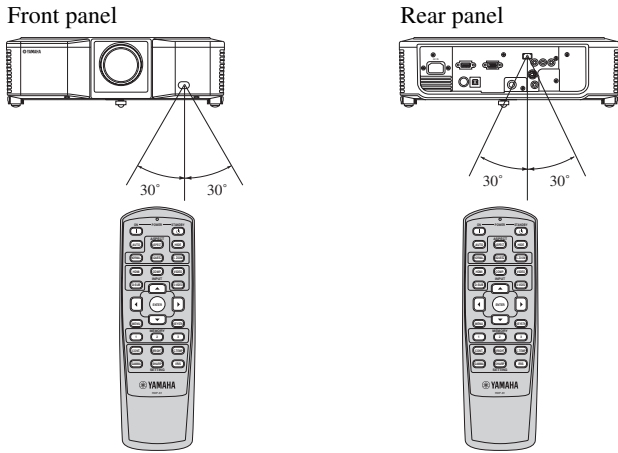

Operate the remote control within a distance of 10 m from the projector, pointing the light beam at the remote control sensor (front or rear) of the projector.

Distance to sensor	Angle to sensor
10 m (approximate value)	30° left and right (approximate value)

Caution

- Keep the remote control sensor out of direct sunlight or fluorescent lamp light.
- Keep the remote control sensor at least 2 m away from fluorescent lamps. Otherwise, the remote control may malfunction.
- If there is an inverter-operated fluorescent lamp near the remote control, the remote control operation may become unstable. On this occasion, stick a commercially available protection sticker on one of the sensors that is closer to the fluorescent lamp.

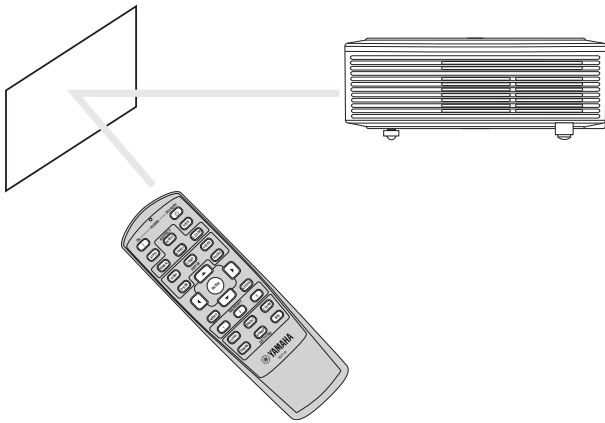

When operating the remote control, keep the distance from the remote control to the projector via the screen within about 5 m. The operable range of the remote control, however, depends on the characteristics of the screen.

◆ Reception angle

Vertical directions

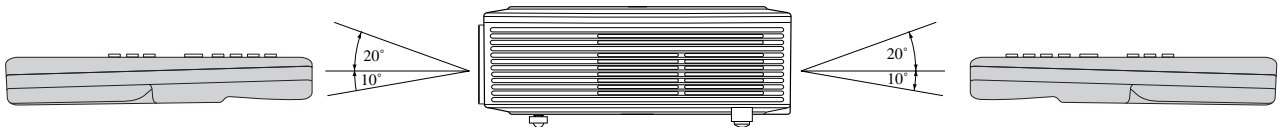

Vertical directions (ceiling mount)

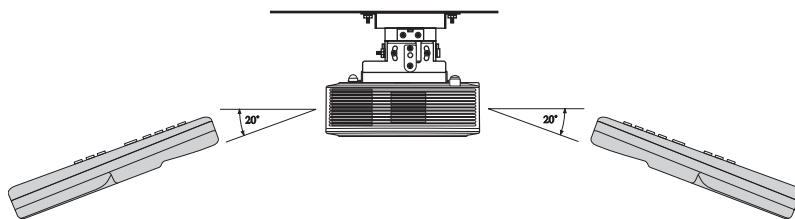

4 Installation

◆ Setting up the screen

Install the screen perpendicularly to the projector. If the screen can not be installed in such a way, adjust the projection angle of the projector as shown below.

Important

- Before setting up the screen, be sure to set SCREEN ASPECT in the SETUP menu to either 16:9 or 4:3.
- Install the screen and projector so that the projector's lens is placed at the horizontal position of the screen center.
- Do not install the screen where it is exposed to direct sunlight or lighting. Light directly reflecting on the screen makes the projected images whitish and hard to view.

◆ Mounting the projector on the table

Determine the distance from the screen to the projector according to the size of the images to be projected (see page 10).

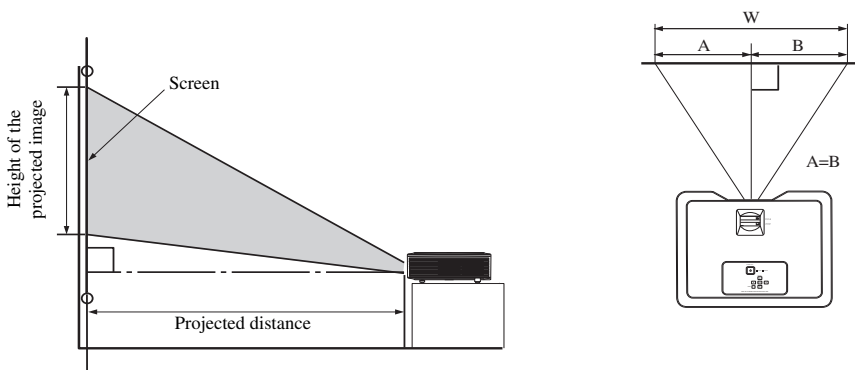

- Do not place this projector on a carpet or blanket because the intake vent on the bottom surface will be blocked and the inside of the projector will overheat, causing a breakdown or fire.
- Depending on the installation conditions, warm air that is emitted from the exhaust vents may flow into the intake vent, causing the projector to display "Over Temperature" and then stop projecting images. If this happens, clear the area around the exhaust vent.

◆ Adjusting the projection angle

This projector is provided with three feet for adjusting the projection angle on the bottom surface. Adjust the projection angle depending on the position of the projector.

For the best projection, project images on a flat screen installed at 90 degrees to the floor. If necessary, tilt the projector using the adjustment feet on the bottom of the projector.

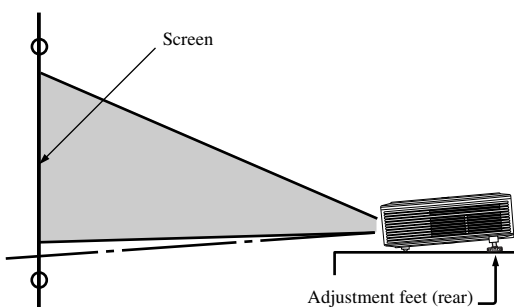

1. Tilt the projector upwards to the appropriate angle.
2. Press the foot adjustment buttons next to the adjustment feet (rear), and the adjustment feet will come out.
3. Release the buttons to lock the adjustment feet (rear) to that position.
4. Rotate the adjustment feet (rear) for fine adjustment.
 - If necessary, rotate the adjustment foot (front) for fine adjustment.

After using the projector

Put the adjustment feet (rear) back into the projector by pressing the foot adjustment buttons.

When projected images are distorted to a trapezoid

When the screen and the projector are not placed perpendicularly to each other, projected images become trapezoidal. If you cannot make the projector and the screen perpendicular to each other by mechanical adjustments, adjust keystone (see page 17).

◆ Mounting the projector on the ceiling

To view images projected by the ceiling mounted projector from the front:

When the projector is installed on the ceiling, the special ceiling mount bracket, which is commercially available, is required. Be sure to ask a certified installation specialist for installation of the projector. Contact your dealer for details.

- Yamaha assumes no responsibilities for any damage caused by use of other manufacturer's ceiling bracket and by inadequate installation conditions even within the warranty period.

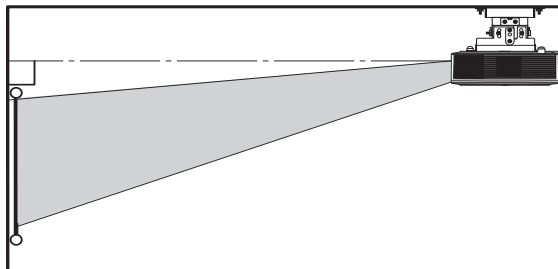

- When installing the projector on the ceiling, set **LOCATION** in the **SETUP** menu to **FRONT/CEILING**.
- Ask your installation specialist to provide a breaker. When you do not use the projector, be sure to shut down the main power by the breaker.
- When the projector is installed on the ceiling, projected images may appear darker than those projected when the projector is installed on the floor.
- Do not install the projector where the exhaust vents are exposed to air emitted by an air conditioning. Such installation may cause a breakdown.
- Do not install the projector near a fire alarm because it emits hot air from its exhaust vents.

Optional part

Ceiling mount bracket PMT-L71 (low ceilings)
 PMT-H75 (high ceilings)

To view images projected on a translucent screen from behind:

Be sure to ask a certified installation specialist for installation of the projector. Contact your dealer for details.

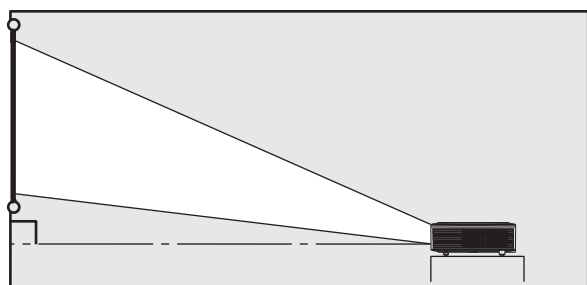

- To view images projected from behind the screen, set **LOCATION** in the **SETUP** menu to **REAR/TABLE**.

◆ Screen size and projection distance

Refer to the following diagram to determine the screen size.

When the aspect ratio of the screen is 16:9

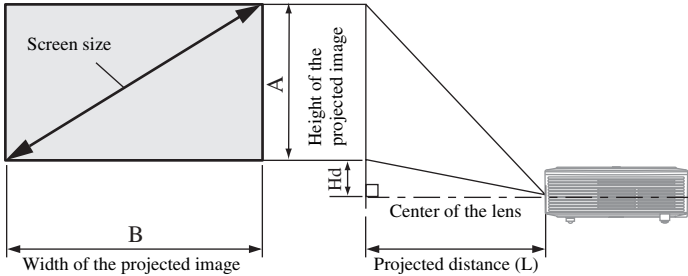

Screen size 16:9						Projected distance (L)				Hd	
Diagonal		Height A		Width B		Min.		Max.			
inch	cm	inch	cm	inch	cm	inch	m	inch	m	inch	cm
40	102	20	50	35	89	56	1.4	68	1.7	6.6	17
60	152	29	75	52	133	85	2.2	103	2.6	9.9	25
80	203	39	100	70	177	114	2.9	139	3.5	13.2	33
100	254	49	125	87	221	143	3.6	174	4.4	16.5	42
150	381	74	187	131	332	216	5.5	262	6.6	24.7	63
200	508	98	249	174	443	289	7.3	349	8.9	32.9	84
250	635	123	311	218	553	362	9.2	-	-	41.2	105
275	699	135	342	240	609	398	10.1	-	-	45.3	115

- The above figures are approximate and may be slightly different from the actual measurements.

When the aspect ratio of the screen is 4:3

When the aspect ratio of the screen is 4:3, the positional relation between the projected image and the screen is as shown below. Refer to the following table for installation.

When the aspect ratio of the image is 4:3

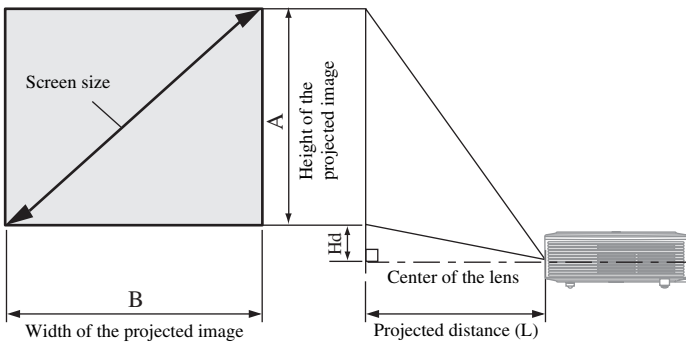

Screen size 4:3						Project distance (L)				Hd	
Diagonal		Height A		Width B		Min.		Max.			
inch	cm	inch	cm	inch	cm	inch	m	inch	m	inch	cm
40	102	24	61	32	81	65	1.6	79	2.0	6.8	17
60	152	36	91	48	122	98	2.5	119	3.0	10.2	26
80	203	48	122	64	163	132	3.3	159	4.0	13.6	35
100	254	60	152	80	203	165	4.2	200	5.1	17.0	43
150	381	90	229	120	305	248	6.3	300	7.6	25.5	65
200	508	120	305	160	406	332	8.4	-	-	34.0	86
250	635	150	381	200	508	-	-	-	-	42.5	108
275	699	165	419	220	559	-	-	-	-	46.8	119

- The above figures are approximate and may be slightly different from the actual measurements.

When the aspect ratio of the image is 16:9

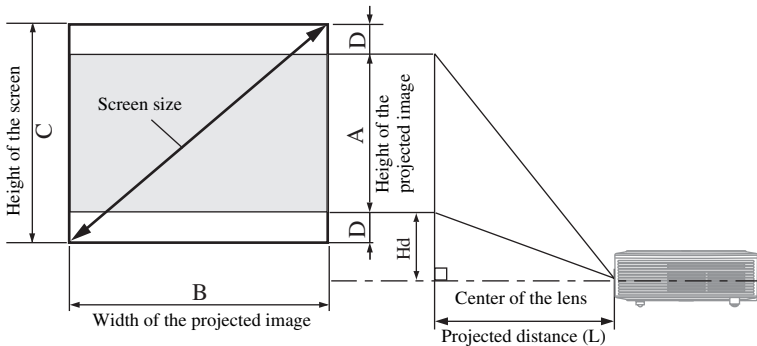

Screen size 4:3						Size of the projected image 16:9				Project distance (L)				Hd	
Diagonal		Height C		Width B		Height A		Blank space (D)		Min.		Max.			
inch	cm	inch	cm	inch	cm	inch	cm	inch	cm	inch	m	inch	m	inch	cm
40	102	24	61	32	81	18.0	46	3.0	8	51	1.3	63	1.6	6.0	15
60	152	36	91	48	122	27.0	69	4.5	11	78	2.0	95	2.4	9.1	23
80	203	48	122	64	163	36.0	91	6.0	15	105	2.7	127	3.2	12.1	31
100	254	60	152	80	203	45.0	114	7.5	19	132	3.3	159	4.0	15.1	38
150	381	90	229	120	305	67.4	171	11.3	29	198	5.0	240	6.1	22.7	58
200	508	120	305	160	406	89.9	228	15.0	38	265	6.7	320	8.1	30.2	77
250	635	150	381	200	508	112.4	286	18.8	48	332	8.4	401	10.2	37.8	96
300	762	180	457	240	610	134.9	343	22.6	57	398	10.1	-	-	45.3	115

- The above figures are approximate and may be slightly different from the actual measurements.

5 Connections

◆ Basic home theater system connection

Important

- Make sure that the power of the projector and that of the video equipment are turned off.
- Connection methods and terminal names may differ depending on the video equipment you are connecting. Refer to the instruction manual for the video equipment.
- Use of a long cable may affect the quality of the projected image.

ENGLISH

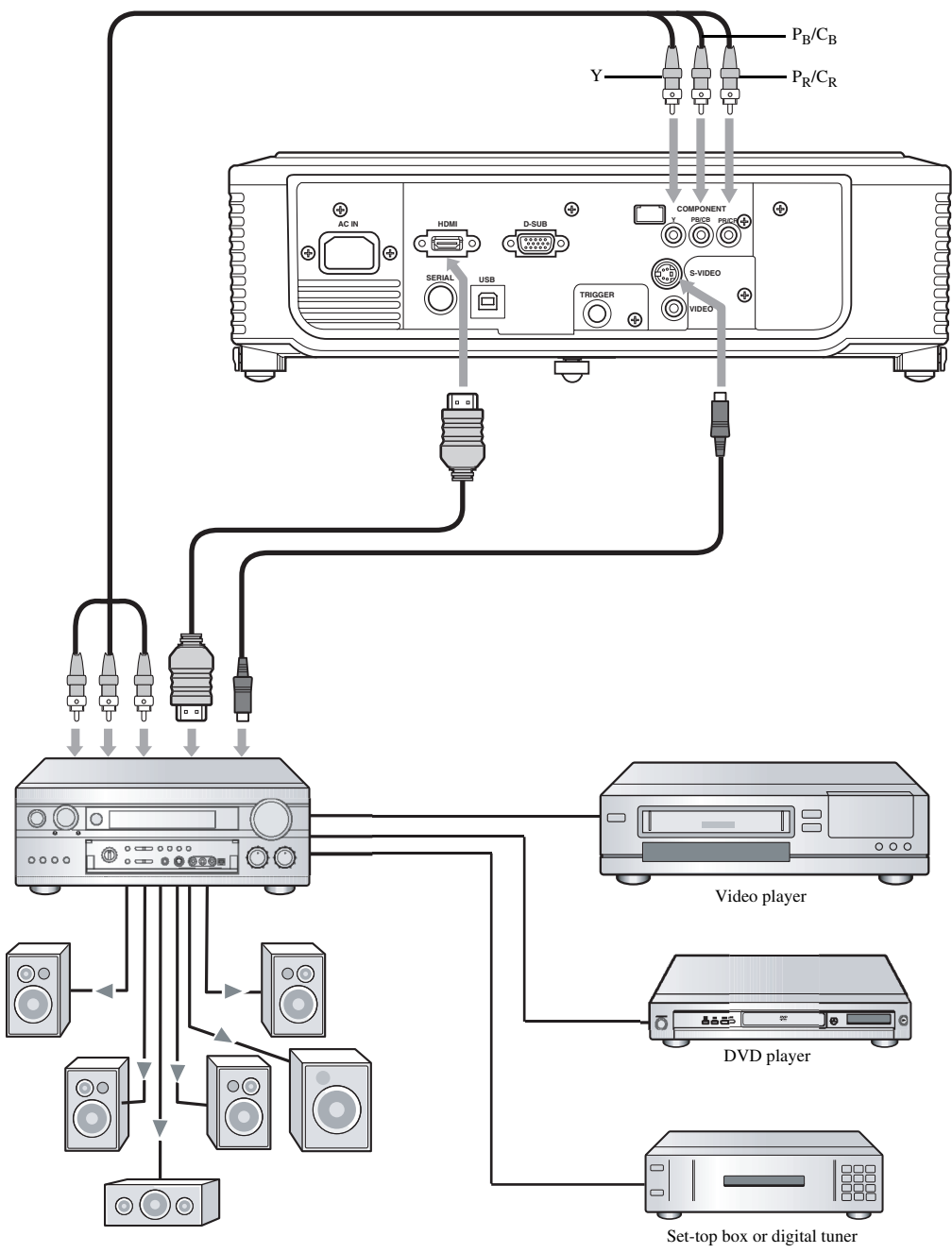

◆ Connecting to a video player, etc.

Using the VIDEO terminal

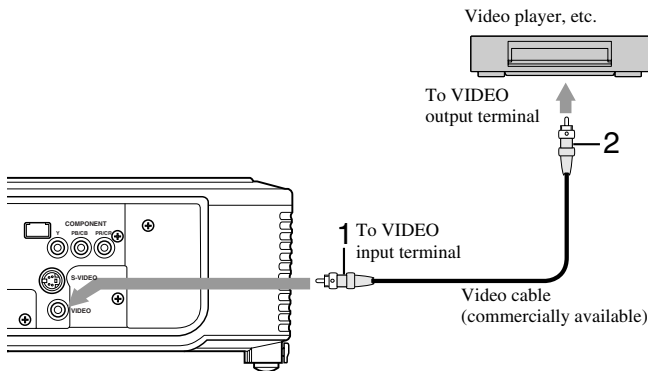

1. Connect one end (yellow) of a commercially available video cable to the VIDEO input terminal of this projector.
2. Connect the other end (yellow) of the video cable to the VIDEO output terminal of the video equipment.

Using the S-VIDEO terminal

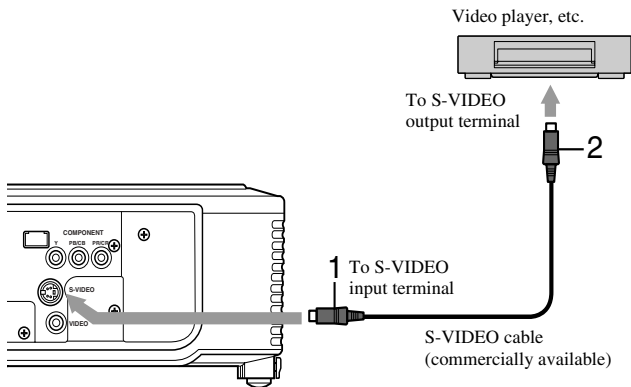

1. Connect one end of the commercially available S-video cable to the S-VIDEO input terminal of this projector.
2. Connect the other end of the S-video cable to the S-VIDEO output terminal of the video equipment.

When a TV tuner or VCR is connected:

When you use this projector with a TV tuner or VCR connected, no image may appear or a No Signal message may appear on the screen when you change to a channel that is not being received. In this case, set the channels of the TV tuner or VCR again. To avoid this problem, use the TV tuner or VCR with its channel skip function enabled. (Only channels that are being received will be displayed.)

◆ Connecting to a DVD player or HDTV decoder

This projector can be connected to a video equipment such as a DVD player or HDTV decoder. Be sure to connect component video output terminals of the video equipment to the COMPONENT input terminals of this projector.

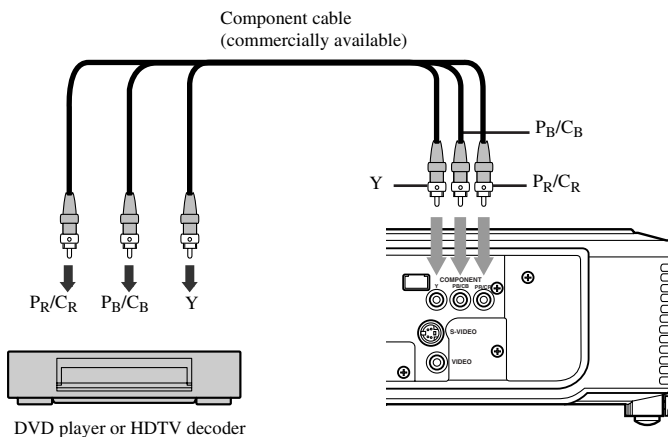

- Images may not be projected correctly depending on the type of DVD player you use.
- It may take some time before an image is displayed on the screen depending on the type of the input signal.

◆ HDMI or DVI connections

You can project high-quality images by connecting the HDMI input terminal of this projector to video equipment having a HDMI output terminal or a DVI-D output terminal. In addition, this projector supports HDCP and is able to receive encrypted digital video data that are output from DVD players.

- HDCP (High-bandwidth Digital Content Protection), developed by Intel Corporation, is a method to encrypt digital video data for the purpose of copy protection.
- HDMI (High-Definition Multimedia Interface) is fully backward compatible with computers, displays and consumer electronics equipments incorporating the DVI standards.
- Depending on the video equipment you wish to connect, this projector may not display any image or not operate correctly. In such cases, refer to the instruction manual for the connected video equipment.

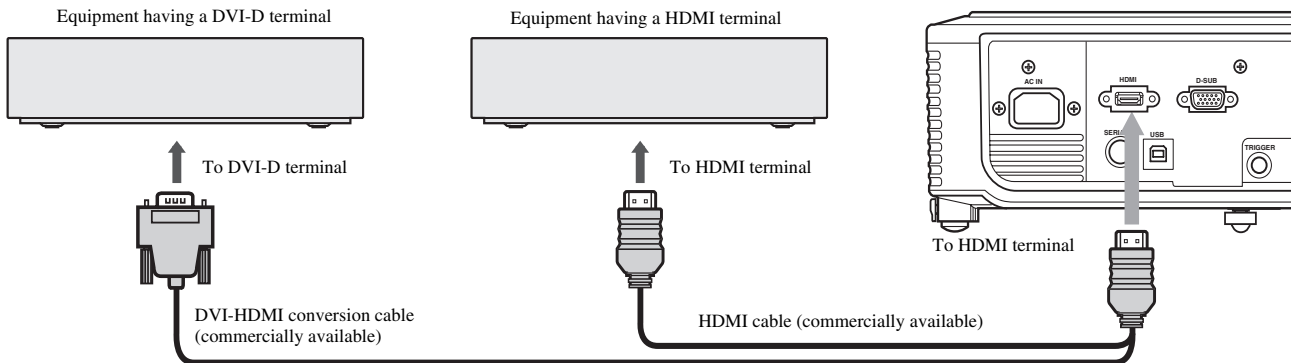

When you connect this projector and DVI-Digital equipment (such as DVD player) by using the HDMI terminal or DVI-D terminal, black color may appear light and pale depending on the type of the connected equipment.

- This depends on the black level setting of the connected equipment. There are two kinds of methods to digitally transfer image data, in which different black level settings are employed respectively. Therefore, the specifications of the signals output from DVD players differ depending on the type of the digital data transfer method they use.
- Some DVD players are provided with a function to switch the methods to output digital signals. If your DVD player has such function, set it as follows:
EXPAND or ENHANCED → NORMAL
- Refer to the instruction manual of your DVD player for details.
- When your digital equipment does not have such function, adjust the BRIGHTNESS to +16 and CONTRAST to -17 in the IMAGE menu of this projector, or adjust the black color by viewing the image.

◆ D-SUB connections

You can project high-quality images by connecting the D-SUB terminal of this projector to video equipment having a D-SUB output terminal or BNC terminal.

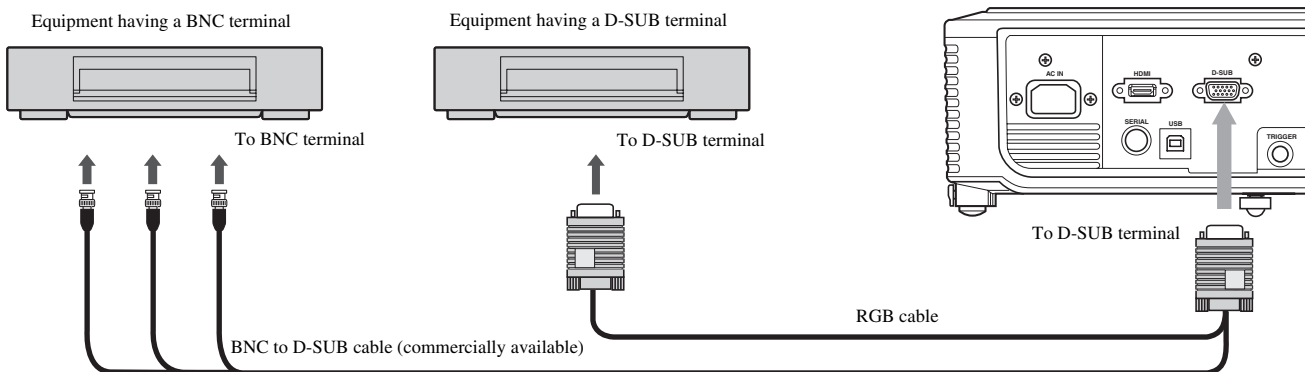

- Use the supplied RGB cable when connecting the projector and the equipment.
- For video equipment having a BNC terminal, use a commercially available BNC to D-SUB cable when connecting to this projector.

◆ Connecting to a computer

Important

- Make sure that the power of the projector and that of the computer are turned off.
- When connecting the projector to a desktop computer, disconnect the RGB cable that is connected to the monitor.
- This projector may not display any image or not operate correctly depending on the computer you wish to connect. In such cases, refer to the instruction manual of the connected computer.

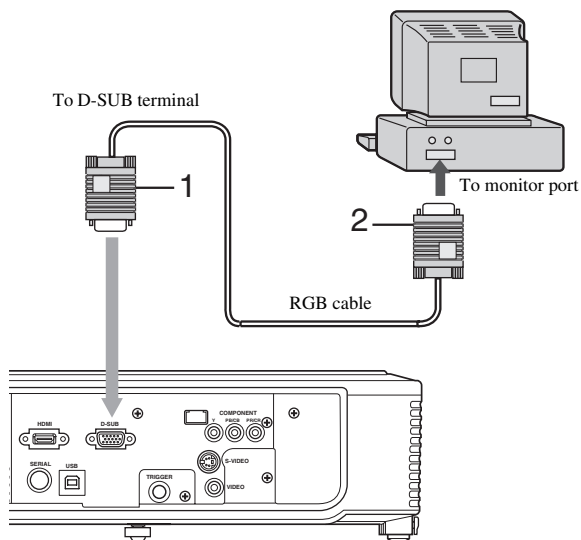

For analog connections:

1. Connect one end of the supplied RGB cable to the D-SUB terminal of this projector.
 2. Connect the other end of the RGB cable to the monitor port of the computer.
- Additional devices, such as a conversion connector and an analog RGB output adapter, are required depending on the type of the computer to be connected.
 - This projector does not support 3-line signals (SYNC-ON-GREEN signals).

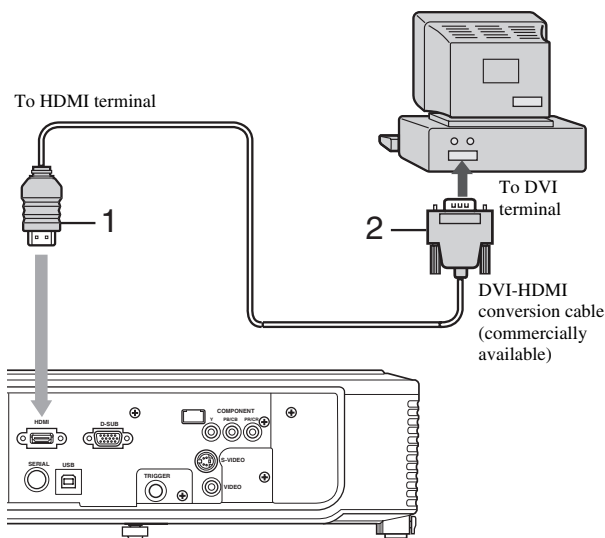

For digital connections:

1. Connect one end of a commercially available DVI-HDMI conversion cable to the HDMI terminal of this projector.
 2. Connect the other end of the DVI-HDMI conversion cable to the DVI terminal of the computer.
- Additional devices, such as a conversion connector and an analog RGB output adapter, are required depending on the type of the computer to be connected.
 - When viewing images being input from a digital-connected computer, press the HDMI button on the remote control.
 - Turn on the power of the projector before that of the computer.
 - Using a long cable may decrease the quality of projected images.
 - The signal input from the HDMI terminal does not output through the D-SUB terminal.

◆ TRIGGER terminal

The TRIGGER terminal on the rear of the projector is a terminal that outputs 12 V signal to control an externally connected equipment when images are projected.

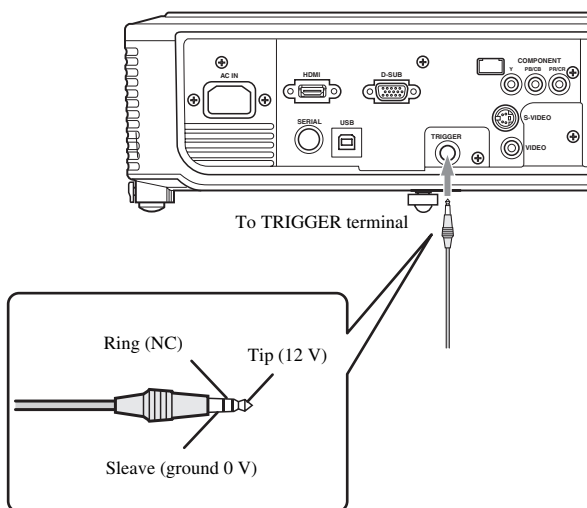

To use the TRIGGER terminal, set TRIGGER OUT to ON in the SETUP menu. (The factory default is OFF.) Use the following steps to change the setting.

With the SETUP menu:

(See page 23 for menu setting.)

1. Display the SETUP menu.
2. Select TRIGGER OUT by pressing the ▲ or ▼ button.
3. Select ON by pressing the ◀ or ▶ button.

To exit from the menu:

4. Press the MENU button several times.
 - Do not use the signal output from the TRIGGER terminal as a power for other equipment.
 - Do not link the TRIGGER terminal with an audio terminal of other equipment. This may cause a damage.
 - The rated current for the TRIGGER terminal is 200 mA. If you use a current exceeding this rating, a failure may occur.
 - For information about electric screens, please contact screen manufacturers.

◆ Plugging in the power cable

For US

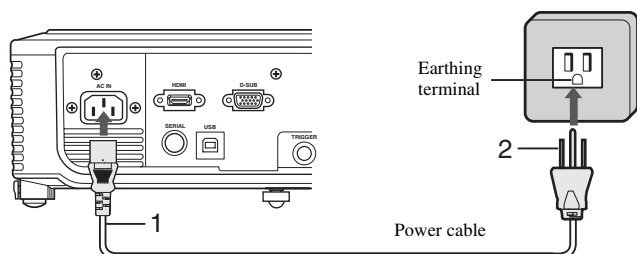

For Europe

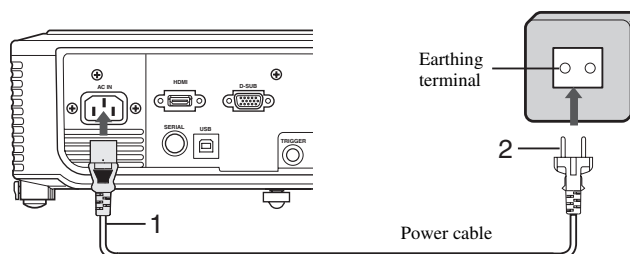

1. Plug the supplied power cable into the AC IN of this projector.
2. Plug the other end of the power cable into a power outlet.
 - The power cables for use in the U.S. and Europe are included with this projector. Use the appropriate one for your country.
 - This projector uses the power plug of three-pin grounding type. Do not take away the grounding pin from the power plug. If the power plug doesn't fit your wall outlet, ask an electrician to change the wall outlet.
 - The provided power cable for the U.S. is rated at 120 V. Never connect this cable to any outlet or power supply using other voltages or frequencies than rated. If you use a power supply using other voltage than rated, prepare an appropriate power cable separately.

6 Projection

◆ Viewing video images

Preparation:

- Always remove the lens cap before operating the projector.
- Turn on the power of the connected video equipment.

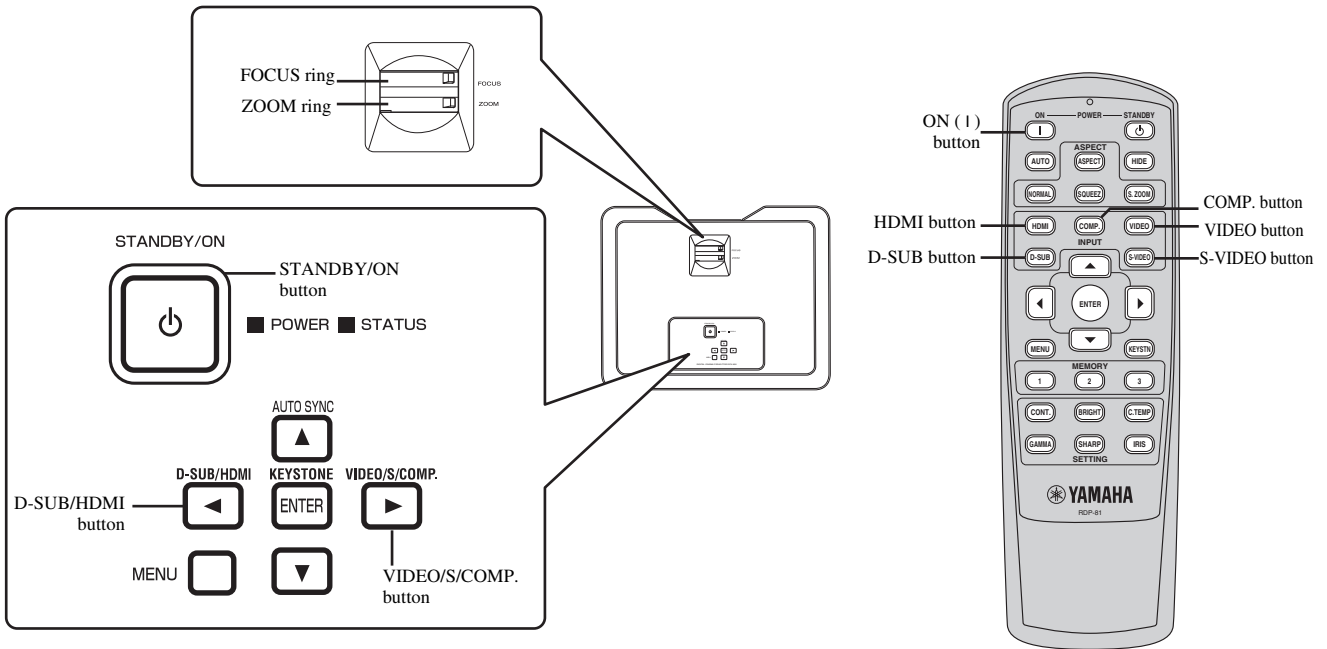

1. Confirm the POWER indicator lights up red.
 - If the projector was turned off before the lamp was cooled down sufficiently last time, the fan may start rotating and the STANDBY/ON button may not work after the power cable is plugged. (The STATUS indicator blinks green.) After the fan stops rotating, press the STANDBY/ON button to turn back on the POWER indicator.
 2. Press the STANDBY/ON (⏻) button on the projector or ON (I) button on the remote control.
 - It may take about one minute for the lamp to light up.
 - The lamp fails to light up on rare occasions. If this happens, wait for a few minutes and then try again.
 - Do not cover the lens with the lens cap while the lamp is on.
 3. Select an input source.
 - Press the VIDEO/S/COMP. or D-SUB/HDMI button on the projector, or press one of the input selector buttons (VIDEO, S-VIDEO, COMP., HDMI, or D-SUB) on the remote control to select the input you desire. Be sure to select the input source that is corresponding to the terminal in use.
 - The input source is switched to VIDEO, S-VIDEO or COMPONENT at every press of the VIDEO/S/COMP. button on the projector.
 - The input source is switched between D-SUB and HDMI at every press of the D-SUB/HDMI button on the projector.
 - There may be a delay before an image is displayed on the screen depending on the type of the input signal.
 - Some images become easier to view when the setting of aspect ratio is changed (see page 18).
 4. Adjust the position of the projector to keep an appropriate projection distance with which images are projected in their specified sizes.
 5. Adjust the position of the projector so that the projector and the screen are perpendicular to each other (see page 8).
 - When the projector cannot be positioned perpendicularly to the screen, adjust the projection angle (see page 8).
 6. Adjust the size of the projected image by turning the ZOOM ring.
 7. Adjust the focus by turning the FOCUS ring.
- Repeat steps 4 to 7, if necessary.

Important

- When a 4:3 image is continuously displayed for a long time before displaying a 16:9 image, the afterimages of the black bars on each side may appear on the 16:9 image screen. Consult your dealer in this case.
- Do not display a still picture for a long time because the afterimages may persist on the screen.

To stop projecting:

1. Press the STANDBY/ON (⏻) button on the projector or the STANDBY (⏻) button on the remote control.
 - A confirmation message is displayed.
 - To cancel the procedure, wait a while or press the MENU button.
2. Press the STANDBY/ON (⏻) button on the projector or the STANDBY (⏻) button on the remote control again.
 - The lamp goes out and the projector goes into a cooling period. In this condition, the POWER indicator turns red and the STATUS indicator blinks green.
3. Wait about one minute for the STATUS indicator to be off and the POWER indicator to be steadily lit in red.
 - During this one minute period, the intake and exhaust fans rotate to cool the lamp.
 - The fan may make loud sounds during a cooling period.

Caution

- Do not unplug the power cable while the STATUS indicator is blinking. Unplugging the power cable immediately after use may damage the lamp or reduce lamp life.

KEYSTONE adjustment

Use to correct vertical and horizontal image distortion caused by tilting the projector.

1. Press the KEYSTONE (ENTER) button on the control area of the projector or the KEYSTN button on the remote control.
2. Adjust the projection angle by pressing ▲, ▼, ◀, ▶ buttons as shown.

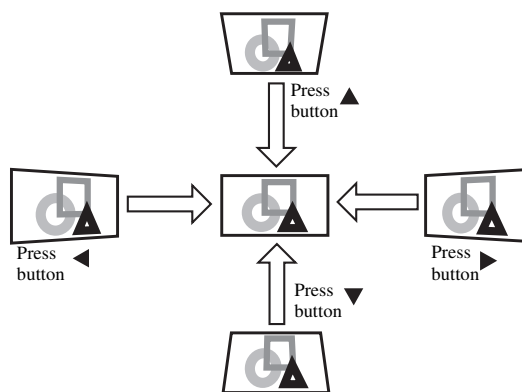

To exit from the menu:

3. Press the KEYSTONE (ENTER) button on the control area of the projector or the KEYSTN button on the remote control again.

Important

- When the keystone adjustment is applied, the correct aspect ratio may not be obtained.
- When the keystone adjustment is applied, the resolution lowers. In addition, vertical stripes appear and straight lines bend in images with complicated patterns. To prevent such symptoms, keep the screen and the projector perpendicular to each other as much as possible.
- When the keystone adjustment is applied, the distorted image may appear for a while.
- The projected image may be distorted depending on the setting value of the keystone adjustment and the type of the input signals. In such cases, adjust the setting value within the range where the projected image is not distorted.
- The setting value displayed at the time of the keystone adjustment may vary depending on the type of the input signal.

IRIS button

The IRIS function adjusts the contrast optically by opening and closing the lens aperture. Select OPEN to increase the brightness of the image. Select CLOSE to deepen the black level of the image while reducing the brightness.

1. Press the IRIS button on the remote control.
 - The current setting appears.





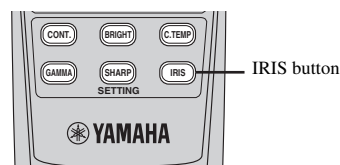







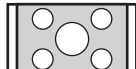
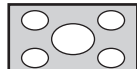



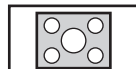

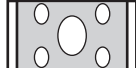



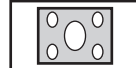





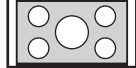

2. Change the setting by pressing the IRIS button again while the current setting is being displayed.



Examples of the aspect ratio

You can change the aspect ratio of the input video signal (or the ratio of width to height of the image). Display pattern changes according to the setting of SCREEN ASPECT in the INITIAL menu. The following table is in the case of 16:9 screen. Change the setting according to the type of the input video signal.

 : Image area

	NORMAL	SQUEEZE	SUBTITLE ZOOM* ¹	ZOOM* ¹	SMART ZOOM* ²	THROUGH
Original image size	Displays the image while keeping the input aspect ratio.	Squeezed image is expanded to 16:9.	Cinema scope image is enlarged and displayed together with subtitles.	Vista image is enlarged and displayed together with subtitles.	Image is enlarged to 16:9 while the center aspect ratio remains unchanged.	Input signal is displayed in its original size.
 4:3 image (480i, 576i, 480p, 576p, and PC)						
 4:3 Squeezed (480i, 576i, 480p, 576p)						
 4:3 LetterBox (CinemaScope with subtitles) (480i, 576i, 480p, 576p)						
 4:3 LetterBox (Vista image) (480i, 576i, 480p, 576p)						
 16:9 image (720p, 1080i)			Not available.	Not available.	Not available.	

*1: Available only when the input signal is 480p or 576p.

*1: When ASPECT is set to SUBTITLE ZOOM or ZOOM, display position can be changed with the ▲ or ▼ button on the remote control.

*2: OVER SCAN and BLACK MASK in the SIGNAL menu are not available in the SMART ZOOM mode.

- Bold frames  are recommended modes.
- This projector is equipped with a function to change the aspect ratio. If you select an aspect ratio that is inconsistent with that of the input signal, images around the screen edges may be hidden or deformed. When viewing original video works reflecting the authors' intentions, you are recommended to keep their aspect ratios unchanged.
- It may be an infringement of the rights protected by the copyright law to project images compressed or enlarged by changing the aspect ratio in public areas, such as inside and outside shops and hotels, for commercial or public viewing purposes.

Setting the aspect ratio

With the remote control:

1. ASPECT button
 - Every time you press the ASPECT button, the aspect mode changes from DEFAULT to NORMAL, SQUEEZE, SUBTITLE ZOOM, ZOOM, SMART ZOOM, THROUGH and back to DEFAULT. DEFAULT is automatically set to either NORMAL or SQUEEZE depending on the input signal.

* The available aspect mode differs depending on the input signals.

2. NORMAL, SQUEEZE, S.ZOOM button

- NORMAL, SQUEEZE, S.ZOOM (SMART ZOOM) buttons on the remote control enable you to select the aspect mode directly.

* Depending on the input signals, these buttons may not function.

With the INITIAL menu:

(See page 22 for how to set the menus.)

1. Display the INITIAL menu.
2. Select ASPECT by pressing the ▲ or ▼ button.
3. Select your desired aspect ratio by pressing the ◀ or ▶ button.

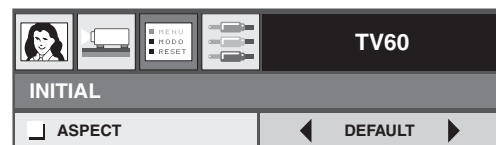

To exit from the menu:

4. Press the MENU button several times.

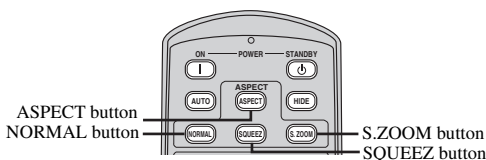

◆ Viewing computer images

Preparation:

- Always remove the lens cap before operating the projector.
- Turn on the power of the connected computer.

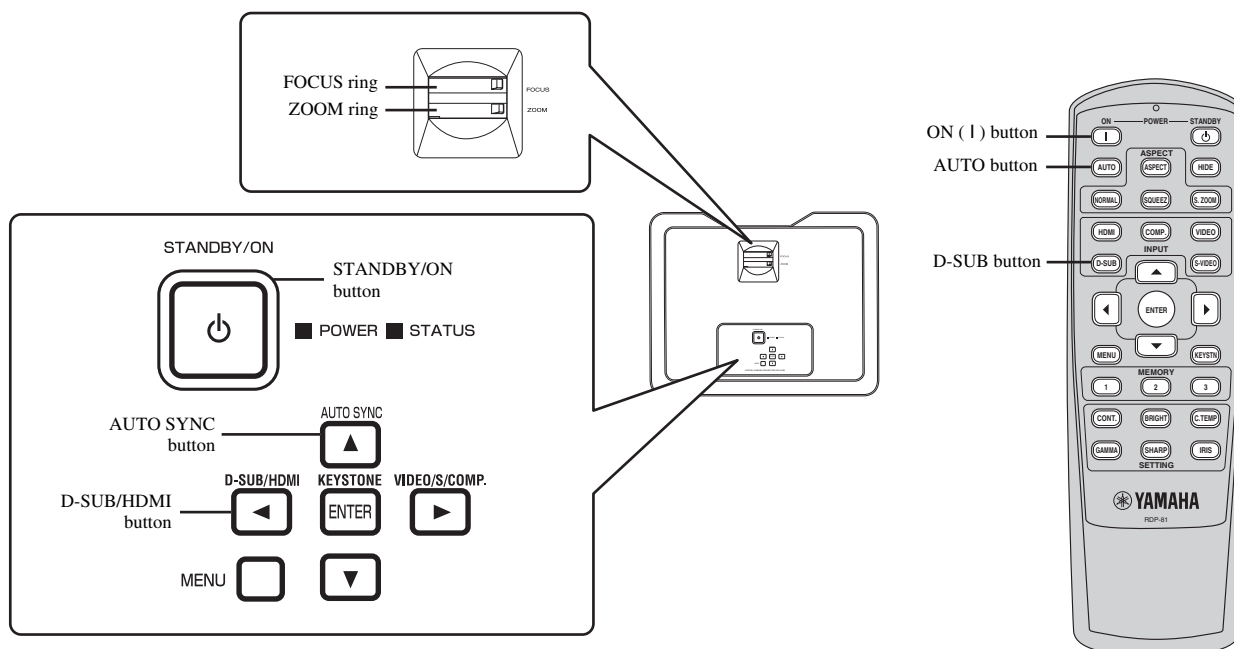

1. Confirm the POWER indicator lights up red.
 - If the projector was turned off before the lamp was cooled down sufficiently last time, the fan may start rotating and the STANDBY/ON button may not work after the power cable is plugged. (The STATUS indicator blinks green.) After the fan stops rotating, press the STANDBY/ON button to turn back on the POWER indicator.
 2. Press the STANDBY/ON (⏻) button on the projector or ON (I) button on the remote control.
 - It may take about one minute for the lamp to light up.
 - The lamp fails to light up on rare occasions. If this happens, wait for a few minutes and then try again.
 - Do not cover the lens with the lens cap while the lamp is on.
 3. Select an input source.
 - Press the D-SUB/HDMI button on the projector or the D-SUB button on the remote control that is corresponding to the terminal in use.
 - The input source is switched between D-SUB and HDMI at every press of the D-SUB/HDMI button on the projector.
 - There may be a delay before an image is displayed on the screen depending on the type of the input signal.
 - Images may not be projected in the correct position depending on the type of the input signal. If this happens, press the AUTO SYNC button on the projector or the AUTO button on the remote control (see page 20).
 4. Adjust the position of the projector to keep an appropriate projection distance with which images are projected in their specified sizes.
 5. Adjust the position of the projector so that the projector and the screen are perpendicular to each other (see page 8).
 - When the projector cannot be positioned perpendicularly to the screen, adjust the projection angle (see page 8).
 6. Adjust the size of the projected image by turning the ZOOM ring.
 7. Adjust the focus by turning the FOCUS ring.
- Repeat steps 4 to 7, if necessary.

Important

- When a 4:3 image is continuously displayed for a long time before displaying a 16:9 image, the afterimages of the black bars on each side may appear on the 16:9 image screen. Consult your dealer in this case.
- Do not display a still picture for a long time because the afterimages may persist on the screen.

To stop projecting:

1. Press the STANDBY/ON (⏻) button on the projector or the STANDBY (⏻) button on the remote control.
 - A confirmation message is displayed.
 - To cancel the procedure, wait a while or press the MENU button.
2. Press the STANDBY/ON (⏻) button on the projector or the STANDBY (⏻) button on the remote control again.
 - The lamp goes out and the projector goes into a cooling period. In this condition, the POWER indicator turns red and the STATUS indicator blinks green.
3. Wait about one minute for the STATUS indicator to be off and the POWER indicator to be steadily lit in red.
 - During this one minute period, the intake and exhaust fans rotate to cool the lamp.
 - The fans may make loud sound during the cooling period.

Caution

- Do not unplug the power cable while the STATUS indicator is blinking. Unplugging the power cable immediately after use could damage the lamp or reduce lamp life.

AUTO / AUTO SYNC buttons

When the image being input from the computer is displaced, carry out the following procedure:

1. Disable the screen saver if it has been enabled.
2. Display a bright image (such as a full-screen display of the Recycle Bin window).
3. Press the AUTO button on the remote control or the AUTO SYNC button on the projector.
The projector automatically makes optimum positional settings for the input signal.
 - If the image is not projected in the correct position even after you press the AUTO or AUTO SYNC button several times, change the settings in the SIGNAL menu to put the image in the correct position (see page 31).
 - When you carry out this procedure with a dark image, the image may be displaced.

Connecting to a notebook computer

When the projector is connected to a notebook computer, images may not be projected in some cases. If this happens, set the computer so that it can output signals externally. The setting procedure varies depending on the type of the computer. Refer to the instruction manual of your computer.

7 Menu

◆ Menu overview

Menus are not displayed when no signal is received by the projector.

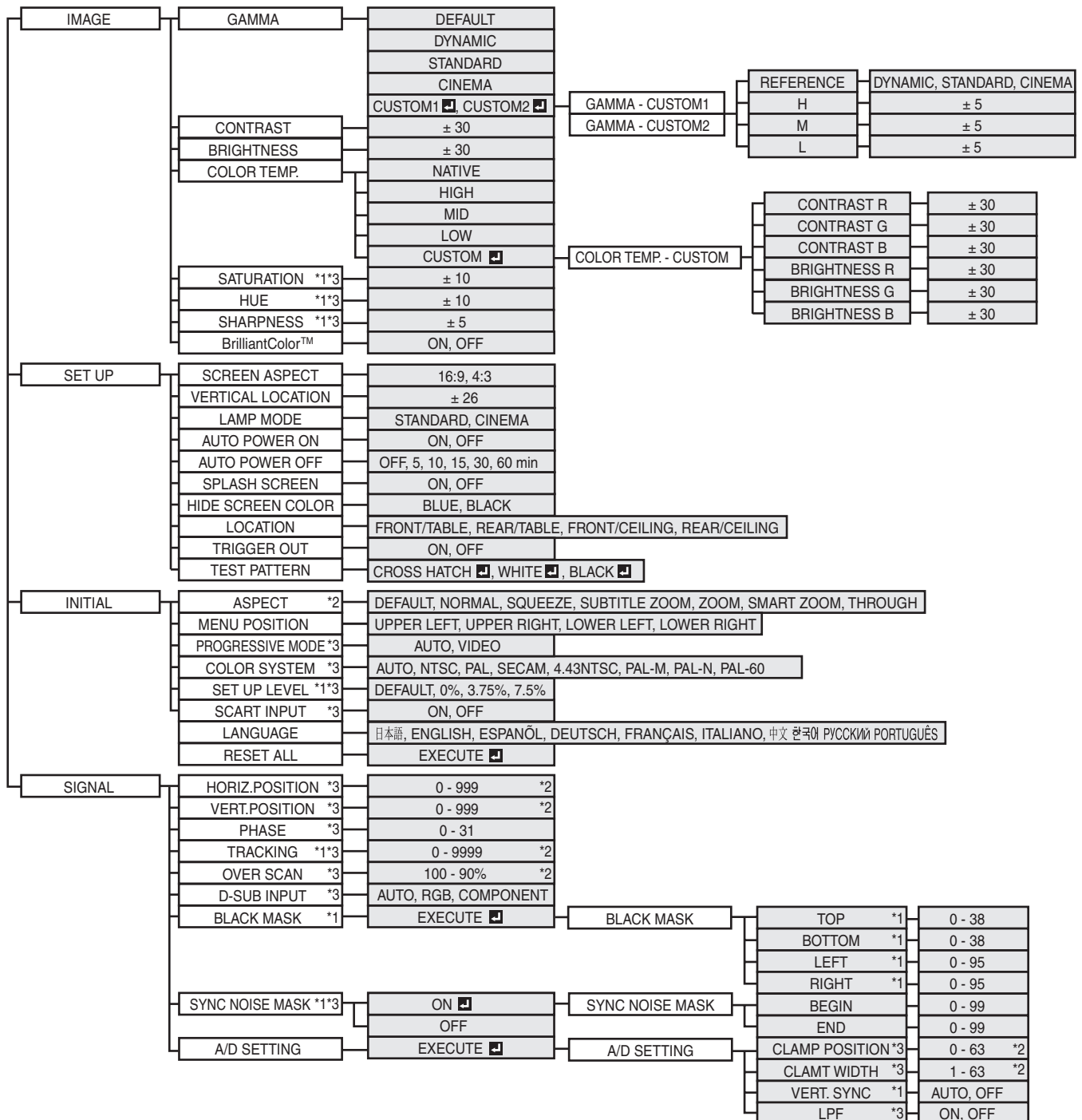

After selecting the items marked with , press the ENTER button.

*1: Not available with certain signals.

*2: The default value and the setting range differ depending on the input signal.

*3: See next page for availability and unavailability.

SATURATION	Unavailable when the input source is HDMI or D-SUB source is an RGB signal.
HUE	Available only when the VIDEO or S-VIDEO source is NTSC or 4.43NTSC signal.
SHARPNESS	Unavailable when the D-SUB or HDMI source is a computer signal.
PROGRESSIVE MODE	Available only when the input signal is TV50, TV60, 480i or 576i.
COLOR SYSTEM	Available only when the input source is VIDEO or S-VIDEO.
SET UP LEVEL	Unavailable when the input source is HDMI, and also when the D-SUB source is a computer signal.
SCART INPUT	Available only when the input source is D-SUB.
HORIZ. POSITION	Unavailable when the input source is HDMI.
VERT. POSITION	Unavailable when the input source is HDMI.
PHASE	Available when the input source is COMPONENT and D-SUB, except RGBCs (576i) signal.
TRACKING	Available only when the D-SUB source is a computer signal.
OVER SCAN	Unavailable when the VIDEO or S-VIDEO source is NTSC, 4.43NTSC, PAL-M, PAL-60 signal.
D-SUB INPUT	Available only when the input source is D-SUB except RGBCs (576i) signal.
SYNC NOISE MASK	Available when the input source is COMPONENT 720p, 1080i signal and D-SUB 720p, 1080i computer signal.
CLAMP POSITION	Available when the input source is COMPONENT and D-SUB, except RGBCs (576i) signal.
CLAMP WIDTH	Available when the input source is COMPONENT and D-SUB, except RGBCs (576i) signal.
LPF	Available only when the COMPONENT or D-SUB source is a 480i/p, 576i/p signal, except RGBCs (576i) signal.

How to set the menus

Following describe how to set AUTO POWER OFF time as an example.

1. Press the MENU button.

- If no signal is input, the menu does not appear.



2. Press the ◀ or ▶ button to select a menu to use.

- SETUP menu is selected in this example.



3. Press the ENTER button (or ▼ button).

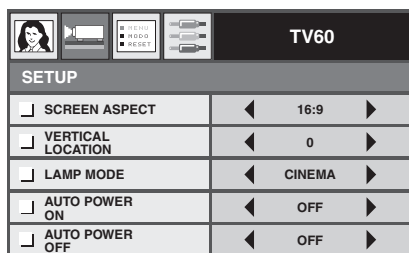

4. Press the ▲ or ▼ button to select an item to adjust.

└ AUTO POWER ON	◀ OFF ▶
└ AUTO POWER OFF	◀ OFF ▶
└ SPLASH SCREEN	◀ ON ▶

5. Set the selected item by pressing the ◀ or ▶ button.

└ AUTO POWER ON	◀ OFF ▶
└ AUTO POWER OFF	◀ 30 min ▶
└ SPLASH SCREEN	◀ ON ▶

To exit from the menu:

6. Press the MENU button several times.

Important

- If the MENU button does not function, unplug the power cable from the wall outlet. Wait about 10 minutes, plug the power cable in, and try again.

◆ Menu settings

The following items in the menus enable you to customize this projector.

1. IMAGE menu

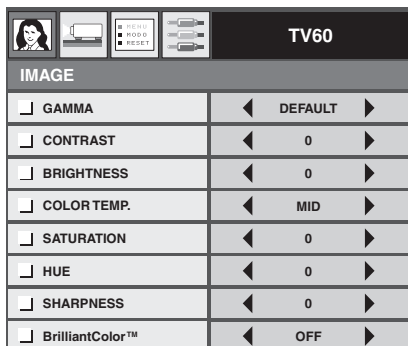



ITEM	SETTING	FUNCTION
GAMMA	DEFAULT	The appropriate gamma mode is automatically selected depending on the input signal. Select DEFAULT for normal use.
	DYNAMIC	Select to secure the contrast even when the room lighting is increased to some extent.
	STANDARD	Select to gain the halftone to make the skin color more vibrant even in a dark scene. This mode is suitable for TV viewing.
	CINEMA	Select when watching movies in dim lighting as in a theater.
	CUSTOM 1 , CUSTOM 2	Use to customize the gamma mode (see page 27).
CONTRAST	± 30	Use to adjust the contrast of the projected image (see page 27).
BRIGHTNESS	± 30	Use to adjust the brightness of the projected image (see page 27).
COLOR TEMP.	NATIVE	Select this option when projecting the image without adjusting the color temperature.
	H	Select for a high color temperature (see page 28).
	M	Select for a balanced color temperature (see page 28)
	L	Select for a low color temperature (see page 28)
	CUSTOM	Use to customize the color temperature (see page 28)
SATURATION	± 10	Use to adjust the color richness of the projected image (see page 29).
HUE	± 10	Use to adjust the color tint of the projected image (see page 29).
SHARPNESS	± 5	Use to adjust the sharpness of the projected image (see page 29).
BrilliantColor™	ON, OFF	Select ON to increase the brightness of the projected image by boosting the midtone color levels while ensuring more vibrant colors. Select OFF when viewing the scene (i.e. a live indoor concert) that is already high in contrast. In such a case, the color and contrast appears more natural with BrilliantColor deactivated.

- DEFAULT depends on the two signal types below:
 1. Video signals (TV50, TV60, 480i/p, 576i/p, 720p50/60, 1080i50/60)
 2. Computer signals (VGA, XGA, etc.)
 See page 40 for a complete listing for the signal specifications.
- Memory function saves up to 3 patterns of the IMAGE menu for each input terminal (see page 30).
- BrilliantColor™ uses BrilliantColor™ technology of Texas Instruments of USA.

2. SETUP menu

TV60	
SETUP	
SCREEN ASPECT	◀ 16:9 ▶
VERTICAL LOCATION	◀ 0 ▶
LAMP MODE	◀ CINEMA ▶
AUTO POWER ON	◀ OFF ▶
AUTO POWER OFF	◀ OFF ▶
SPLASH SCREEN	◀ ON ▶
HIDE SCREEN COLOR	◀ BLUE ▶
LOCATION	◀ FRONT/TABLE ▶
TRIGGER OUT	◀ OFF ▶
TEST PATTERN	◀ CROSS HATCH ▶

ITEM	SETTING	FUNCTION
SCREEN ASPECT	16:9, 4:3	Use to select the screen size.
VERTICAL LOCATION	± 26	Use to adjust the position (height) of the projected image.
LAMP MODE	STANDARD CINEMA	Select when using the projector in a bright environment. Select to moderate the intensity of the lamp. The operating sound is reduced and the lamp lifetime becomes longer.
AUTO POWER ON	ON, OFF	When ON is selected, the lamp is automatically lit when the power cord is plugged in the wall outlet. Select ON when using the projector mounted on the ceiling.
AUTO POWER OFF	OFF, 5 – 60min	Use to set the time elapsed before the projector enters the stand-by mode when there is no signal input from the source.
SPLASH SCREEN	ON, OFF	Select ON to display the splash screen when the power is turned on
HIDE SCREEN COLOR	BLUE, BLACK	Use to select the backround when there is no signal inputted from the selected source.
LOCATION	FRONT/TABLE REAR/TABLE FRONT/CEILING REAR/CEILING	Select when viewing images from the front with the projector installed on the floor. Select when viewing images projected from behind of the screen with the projector installed on the floor. Select when viewing images from the front with the projector installed on the ceiling. Select when viewing images projected from behind of the screen with the projector installed on the ceiling.
TRIGGER OUT	ON, OFF	Selec ON when there is a signal received at the TRIGGER OUT terminal
TEST PATTERN	CROSS HATCH  WHITE  BLACK 	Select to display the test cross hatched pattern. Select to display the maximum brightness image. Select to display the minimum brightness image.

- Do not change the setting of the LAMP MODE frequently. This could damage the lamp.
- To exit from the TEST PATTERN, press any buttons on the remote control.

3. INITIAL menu

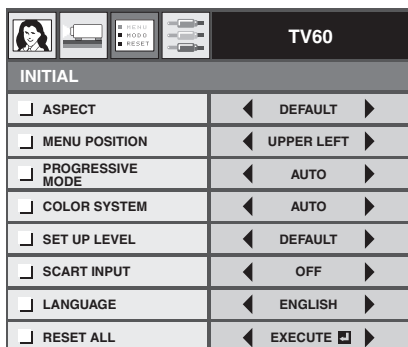

ITEM	SETTING	FUNCTION
ASPECT	DEFAULT	The appropriate aspect ratio is automatically selected depending on the input signal. Select DEFAULT for normal use.
	NORMAL	Select to project images with an aspect ratio of 4:3.
	SQUEEZE	Select to project images with an aspect ratio of 16:9.
	SUBTITLE ZOOM	Select to project subtitled letter box format software.
	ZOOM	Select to enlarge and project images of CinemaScope size or Vista size.
	SMART ZOOM	Select to stretch the left and right edges of a 4:3 image without altering the image center to project a 16:9 image that fills the screen.
	THROUGH	Select to project images in their original size as input.
MENU POSITION	4 positions	Use to change the position of the menu being displayed on the screen.
PROGRESSIVE MODE	AUTO	Detects the video and film contents and convert into optimized progressive frames automatically.
	VIDEO	Force to convert using motion-adaptive I/P conversion for video contents only.
COLOR SYSTEM	8 options	When AUTO is selected, the appropriate video format is automatically selected depending on the input signal. If the image is not displayed correctly, select the desired video format manually.
SET UP LEVEL	DEFAULT, 0%, 3.75%, 7.5%	Select the black level of the projected image. SET UP LEVEL is automatically set to 7.5% when you select any language except 日本語 (Japanese) in the LANGUAGE menu. Select DEFAULT for normal use.
SCART INPUT	ON, OFF	Select ON when connecting the projector to the equipment having a SCART terminal that can output RGB signal. SCART terminal is used mainly in Europe. Select OFF for normal use.
LANGUAGE	10 languages	Use to select the language used in the menu.
RESET ALL	EXECUTE [ENTER]	Use to reset the settings of the menu (excluding LANGUAGE) to its factory presets. It may take few seconds that the projector is reset to its factory presets.

- DEFAULT depends on the two signal types below:
 1. Video signals (TV50, TV60, 480i/p, 576i/p, 720p50/60, 1080i50/60)
 2. Computer signals (VGA, XGA, etc.)
- See page 40 for a complete listing for the signal specifications.

4. SIGNAL menu

TV60		
SIGNAL		
└─ HORIZ. POSITION	◀ 0 - 999 ▶	
└─ VERT. POSITON	◀ 0 - 999 ▶	
└─ PHASE	◀ 0 - 31 ▶	
└─ TRACKING	◀ 0 - 999 ▶	
└─ OVER SCAN	◀ 100 - 90% ▶	
└─ D-SUB INPUT	◀ AUTO ▶	
└─ BLACK MASK	◀ EXECUTE <input checked="" type="checkbox"/> ▶	
└─ SYNC NOISE MASK	◀ ON <input checked="" type="checkbox"/> ▶	
└─ A/D SETTING	◀ EXECUTE <input checked="" type="checkbox"/> ▶	

ITEM	SETTING	FUNCTION
HORIZ. POSITION	0 – 999*	Use to adjust the horizontal position of the projected image.
VERT. POSITION	0 – 999*	Use to adjust the vertical position of the projected image. The adjustable range varies depending on the type of the input signal. In some cases, the image may stay in the same position even when the setting value is changed.
PHASE	0 – 31*	Use to eliminate flickering or blur, if it appears while viewing the projected image.
TRACKING	0 – 9999*	Use to eliminate vertical wide stripes, if it appears, while viewing the projected image.
OVER SCAN	100% – 90%*	Use to adjust the over scan ratio for the video signals.
D-SUB INPUT	AUTO	When the projector detects the three-wire system (Y _C B _C R/ Y _P B _P R) or five-wire system (RGBHV), it automatically selects either COMPONENT or RGB accordingly.
	RGB	Select this option when connecting the projector to high definition video equipment having R, G, and B output terminals.
	COMPONENT	Select this option when connecting the projector to a DVD player or other equipments having Y, C _B , and C _R (or Y, P _B , and P _R) component video output terminals.
BLACK MASK	EXECUTE <input checked="" type="checkbox"/>	Use to adjust the image when the noise appears on the projected image.
	TOP	Adjust the image when the noise appears on the top part of the image.
	BOTTOM	Adjust the image when the noise appears on the bottom part of the image.
	LEFT	Adjust the image when the noise appears on the left part of the image.
	RIGHT	Adjust the image when the noise appears on the right part of the image.
SYNC NOISE MASK	ON <input checked="" type="checkbox"/> , OFF	Use to adjust the image when flagging occurs near the top of the screen.
	BEGIN	Use to adjust the start of the sync noise mask position.
	END	Use to adjust the end of the sync noise mask position.
A/D SETTING	EXECUTE <input checked="" type="checkbox"/>	Use to adjust the Analog Digital conversion parameters.
	CLAMP POSITION	Use to correct solid white or solid black in the projected image.
	CLAMP WIDTH	Use to correct solid black in the projected image.
	VERT. SYNC	Use to adjust the image when its motion does not run smoothly.
	LPF	Use to reduce the streak noise appeared on the image. (see page 29).

* The default value and the setting range differ depending on the input signals.

- Horizontal strips may appear on the enlarged projected image.
- When changing a horizontal or vertical position to a large extent, noise may appear.
- When you select COMPONENT as an input source, the setting of D-SUB INPUT will be changed to COMPONENT automatically.
- OVER SCAN and BLACK MASK are not available when the aspect ratio is set to SMART ZOOM (see page 18).
- OVER SCAN is not available when the aspect ratio is set to THROUGH (see page 18).
- If you increase the OVER SCAN setting when the projector is receiving the video signals, noise may appear on the screen. In such case, decrease the OVER SCAN setting.

8 Adjusting video images

◆ Selecting the gamma mode (GAMMA)

You can select a preset gamma mode by using the menu (see page 23).



1. Display the IMAGE menu.
2. Select GAMMA by pressing the ▲ or ▼ button.
3. Select your desired gamma mode by pressing the ◀ or ▶ button.
 - Select DEFAULT for normal use.



To exit from the menu:

4. Press the MENU button several times.

◆ Customizing the gamma mode (GAMMA)

To customize and store the gamma mode, carry out the following procedure.

1. Select GAMMA in the IMAGE menu.
2. Press the ◀ or ▶ button to select CUSTOM 1  or CUSTOM 2 .
3. Press the ENTER button.
 - The GAMMA-CUSTOM1 menu appears as shown.
7. Repeat step 5 to 6 for optimum adjustment result.

GAMMA - CUSTOM1	
<input type="checkbox"/> REFERENCE	◀ CINEMA ▶
<input type="checkbox"/>  H	◀ 0 ▶
<input type="checkbox"/>  M	◀ 0 ▶
<input type="checkbox"/>  L	◀ 0 ▶

4. Press the ◀ or ▶ button to select REFERENCE.
5. Select the desired gamma mode from DYNAMIC, STANDARD, or CINEMA.
6. Press the ▲ or ▼ button to select an item from H (High), M (Middle), or L (Low), and then adjust the level of each item by pressing the ◀ or ▶ button.

To exit from the menu:

8. Press the MENU button several times.

To activate the customized gamma mode:

1. Press GAMMA button on the remote control.
 - The current setting appears.

GAMMA : DEFAULT

2. Press the ◀ or ▶ button to select GAMMA - CUSTOM1 or GAMMA - CUSTOM2.

GAMMA : CUSTOM1 

To exit from the menu:

3. Press the GAMMA button on the remote control.

◆ Adjusting brightness (CONTRAST and BRIGHTNESS)

You can make adjustments for the brightness of the projected image using the menu (see page 23).

1. Display the IMAGE menu.
2. Select CONTRAST or BRIGHTNESS by pressing the ▲ or ▼ button.
3. Adjust the selected item by pressing the ◀ or ▶ button.

To exit from the menu:

4. Press the MENU button several times.

CONTRAST

Select to adjust the bright areas (white level) in the image. Increase this figure by pressing the ▶ button to increase the contrast clarity of the image or decrease this figure by pressing the ◀ button to reduce the contrast of the image.

BRIGHTNESS

Select to adjust the overall brightness of the image. Increase this figure by pressing the ▶ button to render a brighter image or decrease this figure by pressing the ◀ button to render a darker image.

◆ Selecting the color temperature (COLOR TEMP.)

You can select a preset color temperature (white tone) using the menu (see page 23).

1. Display the IMAGE menu.
2. Select COLOR TEMP. by pressing the ▲ or ▼ button.
3. Select your desired color temperature by pressing the ◀ or ▶ button.

To exit from the menu:

4. Press the MENU button several times.

◆ Customizing the color temperature (COLOR TEMP.)

To customize and store the color temperature, carry out the following procedure.

1. Select COLOR TEMP. in the IMAGE menu.
2. Press the ◀ or ▶ button to select CUSTOM .
3. Press the ENTER button.
 - The COLOR TEMP. - CUSTOM menu appears as shown.

COLOR TEMP. - CUSTOM	
<input type="checkbox"/> CONTRAST R	◀ 0 ▶
<input type="checkbox"/> CONTRAST G	◀ 0 ▶
<input type="checkbox"/> CONTRAST B	◀ 0 ▶
<input type="checkbox"/> BRIGHTNESS R	◀ 0 ▶
<input type="checkbox"/> BRIGHTNESS G	◀ 0 ▶
<input type="checkbox"/> BRIGHTNESS B	◀ 0 ▶

4. Press the ▲ or ▼ button to select an item from CONTRAST R (red), CONTRAST G (green), CONTRAST B (blue), BRIGHTNESS R (red), BRIGHTNESS G (green), and BRIGHTNESS B (blue).
5. Press the ◀ or ▶ button to adjust the value of each item.

6. Repeat step 4 and 5 for optimum adjustment results.

To exit from the menu:

7. Press the MENU button several times.

To activate the stored color temperature settings:

1. Press C.TEMP on the remote control.
 - The current setting appears.

COLOR TEMP. : NATIVE

2. Press the ◀ or ▶ button to select CUSTOM .

COLOR TEMP. : CUSTOM 

To exit from the menu:

3. Press the C.TEMP button on the remote control.

About color temperature

There are different kinds of white color. Color temperature is a way to show the differences in white. With the higher color temperature, white area of the image appears reddish, with the lower color temperature, white area of the image appears bluish. This projector adjusts the color temperature by changing the values of the blue and red contrasts.

To raise the color temperature:

Increase the CONTRAST B (blue) and decrease the CONTRAST R (red).

To reduce the color temperature:

Decrease the CONTRAST B (blue) and increase the CONTRAST R (red).

Important

- If you set all of CONTRAST R, G and B to negative value, the original brightness of the image can not be obtained even when you maximize CONTRAST in the IMAGE menu.

◆ Adjusting color (SATURATION and HUE)

You can adjust the color of the projected image using the menu (see page 23).

1. Display the IMAGE menu.
2. Select SATURATION or HUE by pressing the ▲ or ▼ button.
3. Adjust the selected item by pressing the ◀ or ▶ button.

To exit from the menu:

4. Press the MENU button several times.

SATURATION

Use to adjust the richness of the color in the projected image. Increase this figure by pressing the ▶ button to render a richer color or decrease this figure by pressing the ◀ button to render a lighter color.

- Unavailable when the input source is HDMI or D-SUB source is an RGB signal.

HUE

Use to adjust the tint of the projected image. Increase this figure by pressing the ▶ button to render a greenish image or decrease this figure by pressing the ◀ button to render a reddish image.

- Available only when the VIDEO or S-VIDEO source is NTSC or 4.43NTSC signal.

◆ Sharpening or softening images (SHARPNESS)

You can adjust the sharpness of the projected image using the menu (see page 23).

1. Display the IMAGE menu.
2. Select SHARPNESS by pressing the ▲ or ▼ button.
3. Adjust the selected item by pressing the ◀ or ▶ button.

- Increase this figure by pressing the ▶ button to render a sharper image, or reduce it by pressing the ◀ button to give a softer image with less image noise.

To exit from the menu:

4. Press the MENU button several times.

◆ LPF (Progressive filter)

You can select whether or not to enable the LPF. This item is normally set to OFF.

Vertical or horizontal streak noise may appear on the projected image depending on the type of the DVD player you use. In such cases, you can reduce such streak noise by enabling the LPF. However, projected images become softened slightly.

1. Select A/D SETTING in the SIGNAL menu.
2. Press the ▲ or ▼ button to select EXECUTE .
3. Press the ENTER button.
4. Press the ▲ or ▼ button to select LPF.
5. Press the ◀ or ▶ button to choose ON or OFF.

To exit from the menu:

6. Press the MENU button several times.

EXECUTE	
<input type="checkbox"/> CLAMP POSITION	◀ 0 ▶
<input type="checkbox"/> CLAMP WIDTH	◀ 1 ▶
<input type="checkbox"/> VERT. SYNC	◀ OFF ▶
<input type="checkbox"/> LPF	◀ OFF ▶

9 MEMORY function

◆ Saving memory settings

The memory function saves up to 3 patterns of the image quality settings for each input source. Following is the list of items that can be saved.

- GAMMA*
- CONTRAST
- BRIGHTNESS
- COLOR TEMP.*
- SATURATION
- HUE
- SHARPNESS
- BrilliantColor™

* You can not change the customized setting in GAMMA and COLOR TEMP. for each memory number.

1. Press one of the MEMORY buttons on the remote controll where you wish to store the settings.
2. Adjust the each item listed above in the IMAGE menu.
 - The settings are automatically stored.
 - You can also use the picture quality adjusting buttons on the remote control (see page 6).

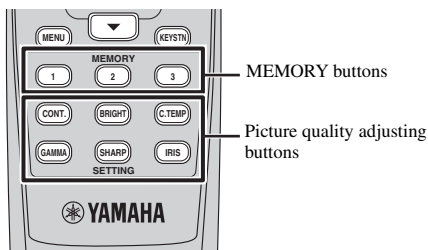

To exit from the menu:

3. Press the MENU button several times.

To activate the stored memory settings:

1. Press one of the MEMORY buttons on the remote control.
 - The image quality settings that are stored in the selected memory is activated.

MEMORY 1

To exit from the menu:

2. Press the same MEMORY button that you selected in step 1.

Important

- When the input source is changed, the projector automatically reverts to the previously selected memory setting.
- When RESET ALL in the INITIAL menu is selected, all the settings that are stored in the memory will be cleared (see page 25).

10 Adjusting computer images

This projector automatically and properly projects video signals supplied from the computer. However, some video signals may not be projected depending on the type of the computer. In such cases, press the AUTO SYNC button on the projector or the AUTO button on the remote control (see page 20). When the signal is still not projected properly, adjust the projected image using the SIGNAL menu.

◆ Adjusting computer images

Carry out the following procedures according to the symptoms.
(See page 22 for how to set the menus)

- Wide strips appear..... Adjust TRACKING in the SIGNAL menu.
- The projected image flickers or the projected image is blurred
..... Adjust PHASE in the SIGNAL menu.
- The projected image is displaced horizontally Adjust HORIZ. POSITION in the SIGNAL menu. Every time the ◀ button is pressed, the image moves to the right. Every time the ▶ button is pressed, the image moves to the left.
- The projected image is displaced vertically..... Adjust VERT. POSITION in the SIGNAL menu. Every time the ◀ button is pressed, the image moves down. Every time the ▶ button is pressed, the image moves up.
- The top part of the image flags Change the setting of SYNC NOISE MASK in the SIGNAL menu. Select ON , press the ENTER button, and adjust BEGIN or END to minimize the flagging.
- Wide strips appear..... Adjust CLAMP POSITION or CLAMP WIDTH in the A/D SETTING.
- The motion does not run smoothly Adjust VERT. SYNC. in the A/D SETTING. Select AUTO for normal use.
- Noise appears on the right or left half of the image
..... Adjust LEFT or RIGHT in the BLACK MASK.
- Noise appears on the top or bottom part of the image
..... Adjust TOP or BOTTOM in the BLACK MASK.
1. Display the SIGNAL menu.
 2. Press the ▲ or ▼ button to select an item to adjust.
 3. Adjust the selected item by pressing the ◀ or ▶ button.

To exit from the menu:

4. Press the MENU button several times.

Simple method to adjust the image position

To adjust the horizontal position:

1. Align the left edge of the image with the left side of the screen by adjusting HORIZ. POSITION. Then, align the right edge of the image with the right side of the screen by adjusting TRACKING.
2. Repeat the previous step to complete the adjustment of the horizontal position.

To adjust the vertical position:

3. Align the upper edge of the image with the upper side of the screen by adjusting VERT. POSITION.

11 Replacing the lamp

This projector is equipped with a lamp to project images. This lamp is a consumable, so it may burn out or its brightness may decrease during use. If this happens, replace the lamp with a new one as soon as possible. Be sure to replace the lamp with a new, commercially available lamp that is exclusive to this projector. Contact your dealer for purchase of the lamp.

Warning

- This product contains a high intensity lamp that contains a small amount of mercury. Disposal of this material may be regulated due to environmental considerations. For disposal information in the United States, refer to the Electronic Industries Alliance web site: www.eiae.org
- Be careful not to drop the lamp screws into the projector. Do not put a metal piece or flammable object into the projector. Using the projector with any foreign object present inside may result in electric shock or fire. If you can't remove the foreign object from the inside, contact your dealer for removal.
- Be sure to install the lamp securely. If the lamp is not installed properly, it will not illuminate. Improper installation may also result in fire.
- Do not shake the removed lamp or lift it above your face. You may injure your eye by flying or falling glass fragments.
- Do not replace the lamp immediately after use because the lamp cover is very hot. You may get burned. Turn off the power using the STANDBY/ON button. After the lamp goes out, wait about two minutes until the intake and exhaust fans for cooling the lamp stop rotating. Then unplug the power cable, and wait at least one hour to allow the lamp to cool down enough to the touch.

◆ Interval of lamp replacement

The recommended interval of lamp replacement is about 3000 hours* of consecutive use when the LAMP MODE in the SETUP menu is set to CINEMA. Such interval differs depending on the operating environment and may be shorter than 3000 hours*. Decrease in luminescence and/or color brightness indicates that the lamp needs to be replaced. When the lamp operation time exceeds 2250 hours, the indicator will blink alternately between green and red (while the lamp is lit; when the lamp is not lit, the indicator will be lit red only) and the lamp replacement message will appear on the screen for one minute everytime the lamp is turned on. When the lamp has been used for about 2850 hours, the replacement message (LAMP EXCHANGE) will appear on the screen for one minute every 15 hours thereafter.

When the lamp operation time exceeds 3000 hours*, the projector automatically shuts off and can not be used until the lamp is replaced and the lamp operation time is reset.

*When the LAMP MODE is set to STANDARD, this duration will be decreased to 2000 hours.

Caution

- Be sure to use the replacement lamp cartridge PJL-725. Other lamp cartridges are not suitable for use in this projector.
- Do not remove the lamp for any purpose other than replacement. Unnecessary removal of the lamp may result in a breakdown.
- This projector uses a high-pressure mercury lamp as the light source. The high-pressure mercury lamp may explode or fail to illuminate permanently because of an impact, scratch, or deterioration through use. The period of time until explosion or permanent failure to illuminate varies considerably from lamp to lamp, depending on operation conditions. Therefore, the lamp may explode soon after the start of use.
- The possibility of explosion of the lamp increases if you use it beyond its replacement period. When the lamp replacement warning appears, replace it with a new one immediately, even if the lamp is still lighting normally.
- When the high-pressure mercury lamp explodes, glass fragments will scatter inside or outside the lamp box and the gas charged inside the lamp will diffuse inside or outside the projector. The gas inside the lamp contains mercury. Be careful not to breathe it and avoid it from entering your eye or mouth. If you should breathe it or if it should enter your eye or mouth, see a doctor immediately.
- In the event that the high-pressure mercury lamp has exploded, glass fragments may have been scattered inside the projector. Ask your dealer to replace the lamp and to inspect the inside of the projector. When you clean or replace the lamp by yourself, be sure to hold the handle of the lamp. You may get injured by glass fragments.
- Do not replace the lamp with the projector installed on the ceiling. Glass fragments may fall from the projector, entering your eye or mouth and causing injury.
- When placing the projector upside down to replace the lamp or conduct maintenance, be sure that the projector is securely placed before working with it.

◆ Replacement lamp cartridge (Option)

Spare lamp PJL-725

◆ Replacing the lamp

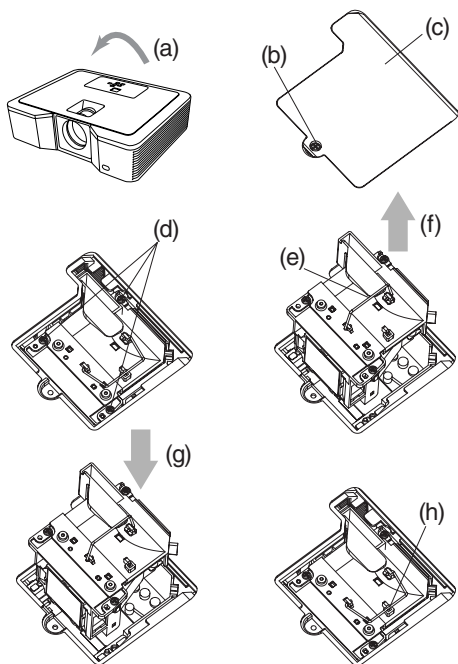

Warning

- Do not replace the lamp immediately after using the projector because the lamp would be extremely hot and it may cause burns.

1. Carefully turn the projector upside-down (a).
2. Loosen the screw (b) using a Phillips screwdriver (+), and remove the lamp cover (c).
3. Loosen the lamp screws (d) using a Phillips screwdriver (+).
4. Pull up the handle (e).
5. Pull out the lamp box by the handle while holding the projector (f).
 - Pull the lamp box out of the projector slowly. If it is pulled out quickly, the lamp may break scattering glass fragments.
 - Do not spill liquid on the removed lamp box or place it near any flammable object or where children can reach to prevent fire and injury.
6. Load a new lamp box securely into the projector in the right orientation (g).
7. Put the handle back to the original position (h).
 - Make sure that the handle is locked.
8. Tighten the screws (d) using a Phillips screwdriver (+).
9. Tighten the screw (b) using a Phillips screwdriver (+) to secure the lamp cover.

Reset of the lamp operation time

Plug in the power cable and reset the lamp operation time by pressing and holding the ◀, ▶, and STANDBY/ON buttons on the control panel at the same time.

Important

- Unless these three buttons are pressed at the same time, the lamp operation time is not reset.
- Make sure that the STATUS indicator is lit twice and the lamp operation time is reset successfully.
- The projector does not turn on if the lamp cover is not attached securely.
- Be sure to reset the lamp operation time whenever you replace the lamp, otherwise the lamp may not be turned on.
- Do not reset the lamp operation time unless you replace the lamp.
- This projector uses a lamp that contains mercury. Disposal of the lamp or the projector with the lamp may be regulated due to environmental considerations.

◆ Maintenance

Caution

- Be sure to turn off the lamp and unplug the power cable from the wall outlet before you perform any maintenance on the projector.

Cleaning the projector and the ventilation grilles

Use a soft cloth to clean the projector and the ventilation grilles. When the grilles become dirty, wipe them with a soft cloth dampened with diluted mild detergent, and then wipe them with a dry cloth.

To protect the surface of the projector from fading or deteriorating:

- Do not spray insecticide on or inside the projector.
- Do not use benzine or thinner to clean it.
- Do not let rubber or plastic materials contact with projector.

Cleaning the lens

Use a standard lens-cleaning brush or a piece of lens tissue dampened with lens cleaning fluid. The lens surface is fragile. Use only recommended, nonabrasive lens-cleaning materials. Do not touch the lens with your fingers.

12 Attaching a lens filter and cap

◆ Attaching a commercially available lens filter

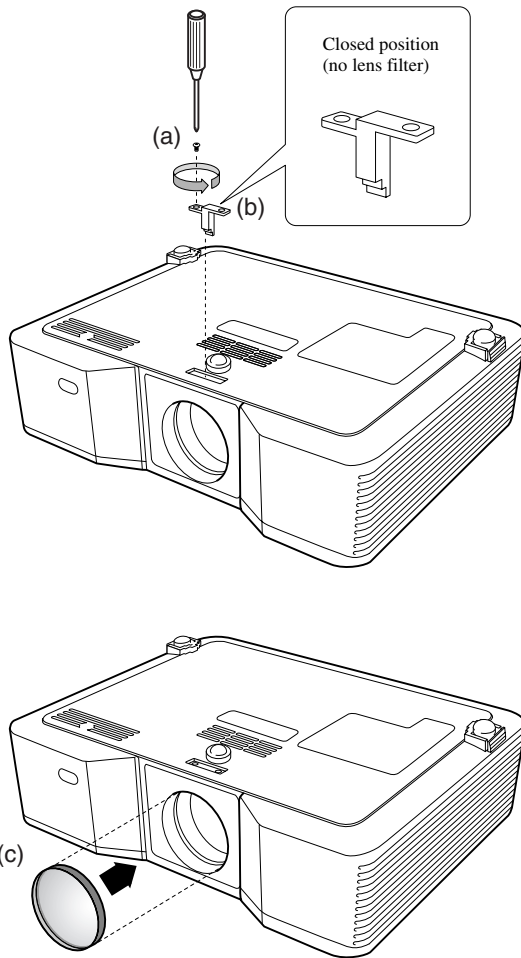

1. Carefully turn the projector upside-down.
2. Loosen the screw (a) using a Phillips screwdriver (+), and remove the stopper (b).
3. Place a lens filter (c).
4. Rotate the stopper 180° and reinsert it into its original location (d).
5. Tighten up the screw (e) using a Phillips screwdriver (+).

Important

- Be sure to use a 67 mm lens filter for this projector.
- Not all 67 mm lens filters are compatible with this projector.

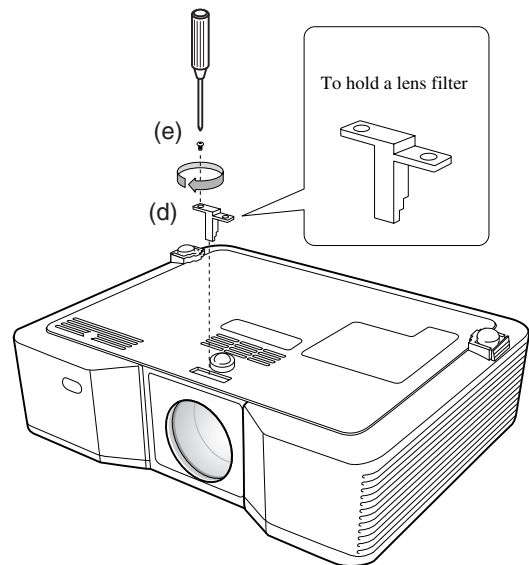

◆ Attaching the lens cap

Attach the supplied lens cap when not using the projector to prevent the lens from becoming dirty or damaged. Insert the lens cap until it is securely placed. (It should make a clicking sound.)

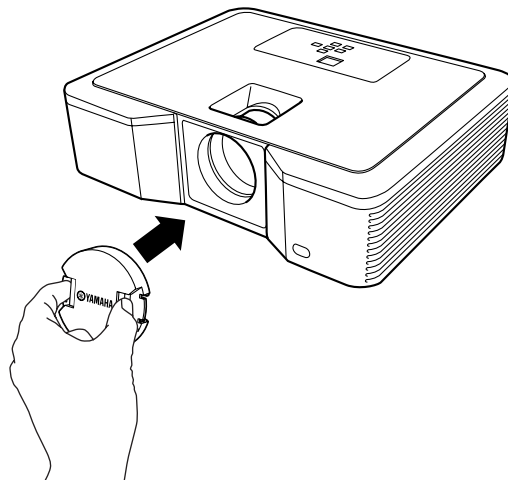

Important































- Do not force the lens cap onto the projector.
- Make sure that the YAMAHA name on the lens cap is aligned parallel to the top and bottom edges of the projector.
- The lens cap can be placed over the lens filter if a lens filter has been installed.

13 Troubleshooting

◆ Troubleshooting

Refer to the chart below when this projector does not function properly. If the problem you are experiencing is not listed below or if the instructions do not help, stop using the projector and contact your dealer.

No image appears on the screen.

Problem	Solution																				
Power can not be turned on.	<ul style="list-style-type: none"> Check whether the indicators are on or off and how they are lightning. <table border="1"> <thead> <tr> <th>POWER</th> <th>STATUS</th> <th>Solution</th> </tr> </thead> <tbody> <tr> <td> Off</td> <td> Off</td> <td> <ul style="list-style-type: none"> Connect the power cable to the projector. Plug the power cable into a wall outlet. </td> </tr> <tr> <td rowspan="4"> Steady red</td> <td> Off</td> <td> <ul style="list-style-type: none"> If any objects are blocking the air intake or exhaust vent, remove them and carry out the following. <ol style="list-style-type: none"> Unplug the power cable from the wall outlet. Make sure that the projector has cooled off. Plug the power cable into the wall outlet. Press the STANDBY/ON button. </td> </tr> <tr> <td> Blinking orange</td> <td> <ul style="list-style-type: none"> If any objects are blocking the air intake or exhaust vent, remove them. Don't expose the air exhaust vents to hot air emitted from a heating appliance. Clean the ventilation grilles. Relocate the projector to a cooler place. </td> </tr> <tr> <td> Blinking green</td> <td> <ul style="list-style-type: none"> After the STATUS indicator stops blinking, press the STANDBY/ON button. If you unplug the power cable while the fan is rotating, the lamp may not turn on about one minute when you plug the power cable next time. The lamp can't turn on again for one minute after it goes out. Press the STANDBY/ON button several times. </td> </tr> <tr> <td> Steady red</td> <td> <ul style="list-style-type: none"> Replace the lamp. (The lamp is at the end of its life.) </td> </tr> <tr> <td rowspan="2"> Blinking red/green</td> <td> Off</td> <td> <ul style="list-style-type: none"> Attach the lamp cover on the bottom. </td> </tr> <tr> <td> Steady or Blinking</td> <td> <ul style="list-style-type: none"> Unplug the power cable from the wall outlet and contact your dealer. </td> </tr> </tbody> </table>	POWER	STATUS	Solution	 Off	 Off	<ul style="list-style-type: none"> Connect the power cable to the projector. Plug the power cable into a wall outlet. 	 Steady red	 Off	<ul style="list-style-type: none"> If any objects are blocking the air intake or exhaust vent, remove them and carry out the following. <ol style="list-style-type: none"> Unplug the power cable from the wall outlet. Make sure that the projector has cooled off. Plug the power cable into the wall outlet. Press the STANDBY/ON button. 	 Blinking orange	<ul style="list-style-type: none"> If any objects are blocking the air intake or exhaust vent, remove them. Don't expose the air exhaust vents to hot air emitted from a heating appliance. Clean the ventilation grilles. Relocate the projector to a cooler place. 	 Blinking green	<ul style="list-style-type: none"> After the STATUS indicator stops blinking, press the STANDBY/ON button. If you unplug the power cable while the fan is rotating, the lamp may not turn on about one minute when you plug the power cable next time. The lamp can't turn on again for one minute after it goes out. Press the STANDBY/ON button several times. 	 Steady red	<ul style="list-style-type: none"> Replace the lamp. (The lamp is at the end of its life.) 	 Blinking red/green	 Off	<ul style="list-style-type: none"> Attach the lamp cover on the bottom. 	 Steady or Blinking	<ul style="list-style-type: none"> Unplug the power cable from the wall outlet and contact your dealer.
POWER	STATUS	Solution																			
 Off	 Off	<ul style="list-style-type: none"> Connect the power cable to the projector. Plug the power cable into a wall outlet. 																			
 Steady red	 Off	<ul style="list-style-type: none"> If any objects are blocking the air intake or exhaust vent, remove them and carry out the following. <ol style="list-style-type: none"> Unplug the power cable from the wall outlet. Make sure that the projector has cooled off. Plug the power cable into the wall outlet. Press the STANDBY/ON button. 																			
	 Blinking orange	<ul style="list-style-type: none"> If any objects are blocking the air intake or exhaust vent, remove them. Don't expose the air exhaust vents to hot air emitted from a heating appliance. Clean the ventilation grilles. Relocate the projector to a cooler place. 																			
	 Blinking green	<ul style="list-style-type: none"> After the STATUS indicator stops blinking, press the STANDBY/ON button. If you unplug the power cable while the fan is rotating, the lamp may not turn on about one minute when you plug the power cable next time. The lamp can't turn on again for one minute after it goes out. Press the STANDBY/ON button several times. 																			
	 Steady red	<ul style="list-style-type: none"> Replace the lamp. (The lamp is at the end of its life.) 																			
 Blinking red/green	 Off	<ul style="list-style-type: none"> Attach the lamp cover on the bottom. 																			
	 Steady or Blinking	<ul style="list-style-type: none"> Unplug the power cable from the wall outlet and contact your dealer. 																			
No image appears on the screen.	<ul style="list-style-type: none"> Check that the lens cap is removed. It may take about one minute for the lamp to light up. The lamp fails to light up on rare occasions. In such cases, wait for a few minutes and then try again. If the projector was turned off before the lamp cooled down completely, the fans may start rotating and the STANDBY/ON button may not function when you plug the power cable into the wall outlet next time. Wait for the fans to stop and press the STANDBY/ON button to turn on the lamp again. Check that the intake vent is clean. Check that the lamp cover is closed (see page 33). Check that the cables connected to the external equipments are not broken. If an extension cable is being used, replace it with the supplied cable for troubleshooting purposes. If images are now displayed correctly, add an RGB signal amplifier to the extension cable. 																				
Projected images suddenly disappear.	<ul style="list-style-type: none"> The air intake or exhaust vent may be blocked. In such cases, the STATUS indicator blinks orange. After removing the objects blocking the intake vent and/or exhaust vents and then carry out the following procedure: <ol style="list-style-type: none"> Wait for the air intake or exhaust fan to stop (or wait for the STATUS indicator to go out.) Unplug the power cable from the wall outlet. Wait about 10 minutes. Plug the power cable into the wall outlet. Press the STANDBY/ON button. When the STATUS indicator is steady red, it is indicating that the lamp should be replaced. Replace the lamp with a new, commercially available lamp. 																				

Problem	Solution
“NO SIGNAL” is displayed.	<ul style="list-style-type: none"> • Turn on the power of the connected equipment, or check whether there is something wrong with the connected equipment. • Check whether the external equipment outputs signals. (Check this especially when the external equipment is a notebook computer.) • Check that the cable connected to the external equipment is not defective. • Check that the projector is connected to the external equipment using the correct terminals. • Check that the connected equipment is correctly selected as the input source. • If an extension cord is being used, replace it with the supplied cable and check whether images are projected correctly. If images are now projected correctly, add an RGB signal amplifier to the extension cord.

Images are not displayed correctly.

Problem	Solution
Projected images are shaking. Projected images are displaced.	<ul style="list-style-type: none"> • Check that the signal being output by the external equipment is not intermittent. • Connect the cable plug firmly. • Press the AUTO button on the remote control or AUTO SYNC button on the projector (see page 20). • Some computers output out-of-spec signals on rare occasion. Adjust the SIGNAL menu (see page 31).
Projected images are distorted.	<ul style="list-style-type: none"> • Adjust the projector and the screen so that they are perpendicular to each other (see page 8).
Projected images are dark.	<ul style="list-style-type: none"> • Adjust BRIGHTNESS and CONTRAST in the IMAGE menu (see page 27). • Replace the lamp (see page 32).
Projected images are blurred.	<ul style="list-style-type: none"> • Adjust the focus (see page 16 and 19). • Clean the lens. • Press the ◀ or ▶ button on the remote control to eliminate flicker. • Adjust TRACKING and PHASE in the SIGNAL menu (see page 31). • Adjust BRIGHTNESS and CONTRAST in the IMAGE menu (see page 27). • Adjust the projector and the screen so that they are perpendicular to each other (see page 8).
White dots are seen on projected images. Black dots are seen on projected images.	<ul style="list-style-type: none"> • This symptom is normal for a DLP™ projector and is not a malfunction. (A very small number of pixels may stay lit or out, but it is not a malfunction. Pixels of 99.99% or more are effective.)
Rainbow effect is seen on projected images.	<ul style="list-style-type: none"> • This is due to color breaking noise that occurs in a DLP™ system and is not a malfunction.
Fine streaks are seen on projected images.	<ul style="list-style-type: none"> • This is due to interference with the screen surface and is not a malfunction. Replace the screen or displace the focus a little.
Projected images become wavy.	<ul style="list-style-type: none"> • Connect the cable plugs to external equipments securely. • Keep the projector away from equipments that emit interfering radio waves. • When the keystone adjustment is carried out, the image may not be displayed correctly because of the type of input signal. This isn't a product malfunction. In this case, readjust the keystone so that the amount of keystone correction is as small as possible.
Hue is not appropriate.	<ul style="list-style-type: none"> • Check that the cable connected to the external equipment is not defective.
Tint in projected images is incorrect.	<ul style="list-style-type: none"> • Check that D-SUB INPUT in the SIGNAL menu is correctly set (see page 26). • Check that the cable connected to the external equipment is not defective.
Only the motion areas in the images supplied from the computer are not displayed.	<ul style="list-style-type: none"> • This is caused by the computer being used. Contact the manufacturer of your computer.
Projected images are obscured.	<ul style="list-style-type: none"> • Match the output resolution of your computer with the resolution of the projector. For the method to change the output resolution of the computer, contact the manufacturer of your computer (see page 40). • Some images and texts appear obscured during the keystone adjustment. In such cases, use the projector without applying the keystone adjustment (see page 17).

Others

Problem	Solution
The exhaust vents emit warm air.	<ul style="list-style-type: none"> This air comes out after cooling the inside of the projector. It may feel hot, but this is not a malfunction.
The menu can not be used.	<ul style="list-style-type: none"> The microcomputers inside the projector may be wrongly operating because of noise. <ul style="list-style-type: none"> → Press the STANDBY/ON button to turn off the lamp and unplug the power cable from the wall outlet. Wait about 10 minutes, plug the power cable in, and try again.
“TEMPERATURE!!” is displayed.	<ul style="list-style-type: none"> This indication appears when the ambient temperature rises high. When the ambient temperature stays high, the lamp goes out. <ul style="list-style-type: none"> → Eliminate any causes of the rise in the ambient temperature. This indication appears when the air intake or exhaust vent is blocked. When they are kept blocked, the lamp goes out. <ul style="list-style-type: none"> → Remove the objects blocking the air intake or exhaust vent.
The ☉ mark appears.	<ul style="list-style-type: none"> This mark appears when ineffective operation is carried out. This is not a product malfunction.
The remote control does not function easily or at all.	<ul style="list-style-type: none"> Check that the battery is loaded in the remote control or the battery is not weak (see page 4). Check that the remote control sensor is not exposed to direct sunlight or fluorescent light. Use the remote control within its operation range (see page 7). Use the remote control at least 10 cm away from the projector.
Abnormal sound is heard.	<ul style="list-style-type: none"> Because the color wheel spins at a high speed, metallic sounds may be heard in rare occasions.

If the following problem occurs after the lamp is replaced, check the following first.

Problem	Solution
The projector does not turn on.	<ul style="list-style-type: none"> Fit the lamp cover securely (see page 33). Reset the lamp operating time (see page 33).
The STATUS indicator blinks.	<ul style="list-style-type: none"> Reset the lamp operating time (see page 33).

14 Indicators

This projector has two indicators, each of which shows the operation condition of the projector. Refer to Troubleshooting for additional indication signals.

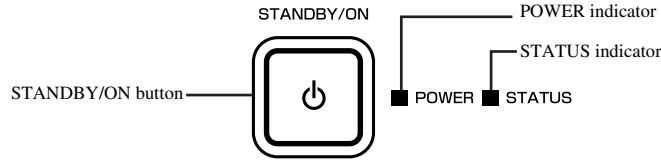

◆ Normal conditions

POWER	STATUS	CONDITION	NOTE
 Steady red	 Off	Stand-by.	
 Steady green	 Blinking green	Warming up period (about 1 minute).	The STANDBY/ON button cannot be used until the STATUS indicator is steady green.
 Steady green	 Steady green	The projector is ready.	
 Steady red	 Blinking green	Cooling down period (lasts under 2 minutes; normal when shutting down).	Do not unplug the projector until the STATUS indicator is off.

◆ Abnormal conditions

POWER	STATUS	CONDITION	SOLUTION
 Steady green or Steady red	 Blinking orange	Abnormal temperature <ul style="list-style-type: none"> The ventilation grilles are clogged with dust or dirt. The room temperature is high. 	<ul style="list-style-type: none"> Clean the ventilation grilles. Relocate the projector to a cooler place. Remove any objects blocking the ventilation grilles.
 Steady red	 Blinking green	Abnormal when it occurs except while shutting down. The protection circuit is working or the lamp is in an abnormal condition.	<ul style="list-style-type: none"> Wait until the STATUS indicator goes out, then press the STANDBY/ON button. If the above solution is not effective, replace the lamp.
 Steady green	 Blinking green/red	Lamp operation time warning. (Total lamp operation time reached 2250 hours ^{*1} while the power was on.)	Replace the lamp. Change with a new lamp if this problem recurs.
 Steady red	 Blinking red	Lamp operation time warning. (Total lamp operation time reached 2250 hours ^{*1} while the power was off.)	
 Steady red	 Steady red	Lamp operation time warning. (Total lamp operation time reached 3000 hours ^{*1, *2} while the power was off.)	
 Blinking green/red	 Off	The lamp cover isn't closed.	Close the cover correctly.
 Blinking green/red	 Steady or Blinking	Abnormal.	Contact your dealer.

*1: When LAMP MODE of the SETUP menu is set to CINEMA.

*2: When LAMP MODE is set to STANDARD, this duration will be decreased to 2000 hours.

◆ Projector specifications

The specifications and outside appearance of the projector are subject to change without prior notice.

Type	DLP™ projector		
Model	DPX-830		
Display Technology	0.65-inch Single chip DMD Pixel 1280 × 768 = 983040 pixels		
Projection lens	F 2.4 – 2.6 f= 23 – 27.6 mm		
Light-source lamp	200 W		
Image size (Projection distance)	40" min. to 275" max. (Projection distance 1.4 to 10.1 m (16:9 screen))		
Maximum resolution	Computer signal	Maximum resolution: 1280 x 1024 dots (Analog) / compressed Panel resolution: 1280 × 768 dots	
	Video signal	NTSC / PAL / SECAM / 4.43NTSC / PAL-M / PAL-N / PAL-60	
	Component signal	480i, 480p, 576i, 576p, 720p, 1080i Panel resolution: 1280 × 768 dots	
Input terminal	[Signal type]	[Terminal type]	[Line]
	Analog RGB	D-SUB 15P	1
	Digital RGB	HDMI	1
	Video input	RCA × 1	1
	S-Video input	S	1
	Component video input	RCA × 3, D-SUB 15P	2
Control terminal/ Others	USB	For service person	
	SERIAL	RS-232C (8P): For service person	
	TRIGGER	DC 12 V, Max.200 mA (Stereo mini jack)	
Operating temperatures	+41°F (+5°C) to +95°F (+35°C)		
Rated voltage	AC100 - 240 V, 50/60 Hz		
Power consumption	280 W / 2.9 A		
Power consumption (standby)	8 W		
Dimensions	360 mm (W) × 102 mm (H) × 290 mm (D) *Not including protrusions.		
Weight	3.9 kg		
Others	S-video input	Luminance signal: V _{p-p} =1.0 V 75 Ω (negative sync) Chrominance signals: V _{p-p} =0.286 V 75 Ω (burst signal)	
	Video input	V _{p-p} =1.0 V 75 Ω (negative sync)	
	Component video input	Y _{C_BC_R} : V _{p-p} =1.0 V 75 Ω (Y) (negative sync) V _{p-p} =0.7 V 75 Ω (C _B , C _R)	
	Analog RGB input	RGB: V _{p-p} =0.7 V 75 Ω (negative sync) HD: TTL-level (negative or positive polarity) VD: TTL-level (negative or positive polarity)	
	Digital input (HDMI)	HDMI interface (TMDS single link)	

◆ **Composite / S-video signal specifications**

Signal mode	Resolution (H × V)	Horizontal frequency (kHz)	Vertical frequency (Hz)	Default mode for 16:9 screen (H × V) ^{*1}	Default mode for 4:3 screen (H × V) ^{*2}	Through mode (H × V)
TV60 (525i)	–	15.73	59.94	1280 × 720	1024 × 576	–
TV50 (625i)	–	15.63	50.00	1280 × 720	1024 × 576	–

◆ **Component signal specifications**

Signal mode	Resolution (H × V)	Horizontal frequency (kHz)	Vertical frequency (Hz)	Default mode for 16:9 screen (H × V) ^{*1}	Default mode for 4:3 screen (H × V) ^{*2}	Through mode (H × V)
480i (525i)	–	15.73	59.94	1280 × 720	1024 × 576	–
576i (625i)	–	15.63	50.00	1280 × 720	1024 × 576	–
480p (525p)	–	31.47	59.94	1280 × 720	1024 × 576	–
576p (625p)	–	31.25	50.00	1280 × 720	1024 × 576	–
720p 60 (750p 60)	–	45.00	60.00	1280 × 720	1024 × 576	–
720p 50 (750p 50)	–	37.50	50.00	1280 × 720	1024 × 576	–
1080i 60 (1125i 60)	–	33.75	60.00	1280 × 720	1024 × 576	–
1080i 50 (1125i 50)	–	28.13	50.00	1280 × 720	1024 × 576	–

◆ **Digital RGB / Component signal specifications**

Signal mode	Resolution (H × V)	Horizontal frequency (kHz)	Vertical frequency (Hz)	Default mode for 16:9 screen (H × V) ^{*1}	Default mode for 4:3 screen (H × V) ^{*2}	Through mode (H × V)
480p (525p)	–	31.47	59.94	1280 × 720	1024 × 576	–
576p (625p)	–	31.25	50.00	1280 × 720	1024 × 576	–
720p 60 (750p 60)	–	45.00	60.00	1280 × 720	1024 × 576	–
720p 50 (750p 50)	–	37.50	50.00	1280 × 720	1024 × 576	–
1080i 60 (1125i 60)	–	33.75	60.00	1280 × 720	1024 × 576	–
1080i 50 (1125i 50)	–	28.13	50.00	1280 × 720	1024 × 576	–
VGA 60	640 × 480	31.47	59.94	960 × 720	1024 × 768	–

◆ **Analog RGB signal specifications**

Signal mode	Resolution (H × V)	Horizontal frequency (kHz)	Vertical frequency (Hz)	Default mode for 16:9 screen (H × V) ^{*1}	Default mode for 4:3 screen (H × V) ^{*2}	Through mode (H × V)
576i (625i) ^{*3}	–	15.63	50.00	1280 × 720	1024 × 576	–
720p 60 (750p 60)	–	45.00	60.00	1280 × 720	1024 × 576	–
720p 50 (750p 50)	–	37.50	50.00	1280 × 720	1024 × 576	–
1080i 60 (1125i 60)	–	33.75	60.00	1280 × 720	1024 × 576	–
1080i 50 (1125i 50)	–	28.13	50.00	1280 × 720	1024 × 576	–
PC98	640 × 400	24.82	56.42	1152 × 720	1024 × 640	640 × 400
CGA70	640 × 400	31.47	70.09	1152 × 720	1024 × 640	640 × 400
CGA84	640 × 400	37.86	84.13	1152 × 720	1024 × 640	640 × 400
VGA60	640 × 480	31.47	59.94	960 × 720	1024 × 768	640 × 480
VGA72	640 × 480	37.86	72.81	960 × 720	1024 × 768	640 × 480
VGA75	640 × 480	37.50	75.00	960 × 720	1024 × 768	640 × 480
VGA85	640 × 480	43.27	85.01	960 × 720	1024 × 768	640 × 480
SVGA56	800 × 600	35.16	56.25	960 × 720	1024 × 768	800 × 600
SVGA60	800 × 600	37.88	60.32	960 × 720	1024 × 768	800 × 600
SVGA72	800 × 600	48.08	72.19	960 × 720	1024 × 768	800 × 600
SVGA75	800 × 600	46.88	75.00	960 × 720	1024 × 768	800 × 600
SVGA85	800 × 600	53.67	85.06	960 × 720	1024 × 768	800 × 600
XGA60	1024 × 768	48.36	60.00	960 × 720	1024 × 768	*4
XGA70	1024 × 768	56.48	70.07	960 × 720	1024 × 768	*4
XGA75	1024 × 768	60.02	75.03	960 × 720	1024 × 768	*4
XGA85	1024 × 768	68.68	85.00	960 × 720	1024 × 768	*4
MAC13	640 × 480	35.00	66.67	960 × 720	1024 × 768	640 × 480
MAC16	832 × 624	49.72	74.55	960 × 720	1024 × 768	832 × 624
MAC19	1024 × 768	60.24	75.02	960 × 720	1024 × 768	*4
SXGA60	1280 × 1024	60.02	63.98	900 × 720	960 × 768	*4

- *1: When ASPECT in the INITIAL menu is set to DEFAULT, and SCREEN ASPECT in the SETUP menu is set to 16:9.
- *2: When ASPECT in the INITIAL menu is set to DEFAULT, and SCREEN ASPECT in the SETUP menu is set to 4:3.
- *3: Available with RGB-CS (4 line) sources from SCART terminal.
- *4: Same resolution as the DEFAUL mode depending on the each SCREEN ASPECT.

Important

- This projector can recognize 1280 × 768 pixels as the maximum resolution, however, it is programmed to recognize 1280 × 720 or 1024 × 768 pixels as the normal resolution depending on the screen aspect.
- If the resolution and frequency of your computer are not shown on the table, find the compatible resolution and frequency by changing the resolution of your computer.
- In the case of XGA, the right side of the image may not appear. In this case, adjust TRACKING in the SIGNAL menu.
- TV60 and TV50 are equivalent to 480i and 576i respectively. When these signals are input to the VIDEO or S-VIDEO signal, the signal mode is indicated as TV60 or TV50. When they are input to the COMPONENT terminal, the signal mode is indicated as 480i or 576i.
- This projector cannot be connected to other equipment via an RGB-CS (4 line) connection.

Connectors

SERIAL (8-pin)

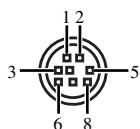

Pin No.	Name	I / O
1	TXD	IN
2	-	-
3	-	-
4	GND	-
5	-	-
6	-	-
7	RXD	OUT
8	-	-

D-SUB (Mini D-SUB 15-pin)

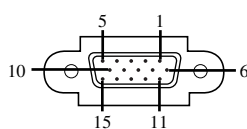

Pin No.	Spec.	Pin No.	Spec.
1	R(REDF) / CR	9	-
2	G(GREEN) / Y	10	GND
3	B(BLUE) / CB	11	GND
4	GND	12	DDC Data
5	GND	13	HD/CS
6	GND	14	VD
7	GND	15	DDC Clock
8	GND		

HDMI (HDMI - 19 pin)

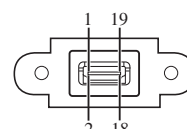

Pin No.	Spec.	Pin No.	Spec.
1	TMDS Data2+	11	TMDS Clock Shield
2	TMDS Data2 Shield	12	TMDS Clock-
3	TMDS Data-	13	-
4	TMDS Data1+	14	-
5	TMDS Data1 Shield	15	SCL
6	TMDS Data1-	16	SDA
7	TMDS Data0+	17	DDCGround
8	TMDS Data02 Shield	18	+5 V Power
9	TMDS Data0-	19	Hot Plug Detect
10	TMDS Clock+		

◆ Dimension drawings

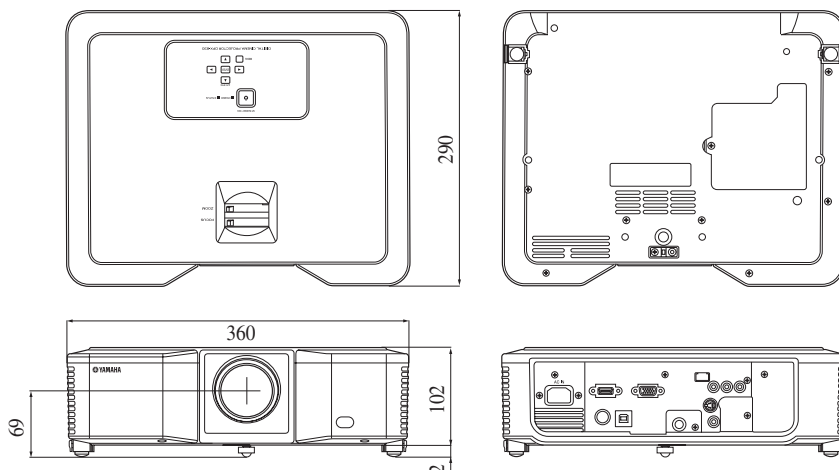

(Unit: mm)



© 2006 YAMAHA CORPORATION All rights reserved.

YAMAHA ELECTRONICS CORPORATION, USA 6660 ORANGETHORPE AVE., BUENA PARK, CALIF. 90620, U.S.A.
YAMAHA CANADA MUSIC LTD. 135 MILNER AVE., SCARBOROUGH, ONTARIO M1S 3R1, CANADA
YAMAHA ELECTRONIK EUROPA G.m.b.H. SIEMENSSTR. 22-34, 25462 RELLINGEN BEI HAMBURG, GERMANY
YAMAHA ELECTRONIQUE FRANCE S.A. RUE AMBROISE CROIZAT BP70 CROISSY-BEAUBOURG 77312 MARNE-LA-VALLEE CEDEX02, FRANCE
YAMAHA ELECTRONICS (UK) LTD. YAMAHA HOUSE, 200 RICKMANSWORTH ROAD WATFORD, HERTS WD18 7GQ, ENGLAND
YAMAHA SCANDINAVIA A.B. J A WETTERGRENS GATA 1, BOX 30053, 400 43 VÄSTRA FRÖLUNDA, SWEDEN
YAMAHA MUSIC AUSTRALIA PTY, LTD. 17-33 MARKET ST., SOUTH MELBOURNE, 3205 VIC., AUSTRALIA

YAMAHA CORPORATION
Printed in Japan ◁ 871D460A20