

myprojectorlamps.com

**The most trusted, dependable name
in projector lamp sales.**



<http://www.myprojectorlamps.com>



<http://www.myprojectorlamps.ca>



<http://www.myprojectorlamps.eu>

The following projector manual has not been modified or altered in any way.

ViewSonic®

PJ751

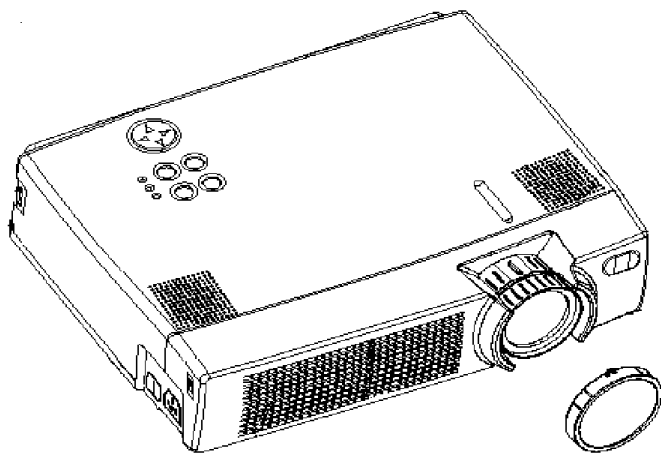

Image Size 31" – 300"
LCD Projector

User Guide

Guide de l'utilisateur

Bedienungsanleitung

Guía del usuario

Guida Dell'utente

Användarhandbok

Käyttöopas

使用者指南

使用者指南

Руководство пользователя

Contents

For Your Records	1
------------------------	---

FEATURES

BEFORE USE

Package Contents	3
Component Names	4
Inserting the Batteries	6
Attaching the Strap Handle	6

INSTALLATION

Installation of the Projector and Screen	7
Angle Adjustment	7
Ports and Cables	8
Power Connection	9
Connecting Your Devices	9
Plug & Play	9

OPERATION

Power ON	13
Power OFF	13
Selecting an Input Signal	14
Adjusting Image Size and Focus	14
Adjusting the Volume	15
Temporarily Muting the Sound	15
Adjusting the Image Position	16
Using the Automatic Adjustment Feature	17
Correcting Keystroke Distortions	18
Using the Magnify Feature	19
Freezing the Screen	19
Signal Searching	20
Selecting the Aspect Ratio	20
Temporarily Blanking the Screen	20
Using the Menu Functions	21
Operating the PC Screen	22

OSD MENU FUNCTION DESCRIPTION

Main Menu	23
Picture 1 Menu	24
Picture 2 Menu	24
Input Menu	25
Screen Menu	26
Option Menu	28

Contents

MAINTENANCE

Lamp	29
Lamp Life	29
Replacing the Lamp	30
Caring for the Air Filter	31
Caring for the Inside of the Projector	32
Caring for the Lens	32
Caring for the Cabinet and Remote Control Transmitter	32

TROUBLESHOOTING

On-Screen Messages	33
Problem Diagnostics	34

SPECIFICATIONS

Outline Dimensions	35
Customer Support	36

LIMITED WARRANTY

ViewSonic Projector	37
---------------------------	----

Appendix

Power Cord Safety Guidelines	38
Compliance Information for U.S.A.	40
Compliance Information for Canada	40
Compliance Information for European Countries	40
User Information for All Countries	40

Copyright © ViewSonic Corporation, 2003. All rights reserved.

Apple, Mac and ADB registered trademarks of Apple Computer, Inc.

Microsoft, Windows, Windows NT, and the Windows logo are registered trademarks of Microsoft Corporation in the United States and other countries.

ViewSonic, the three birds logo, *airsync*, and OnView are registered trademarks of ViewSonic Corporation.

VESA and SVGA are registered trademarks of the Video Electronics Standards Association.

DPMS and DDC are trademarks of VESA.

PS/2, VGA and XGA are registered trademarks of International Business Machines Corporation.

As an ENERGY STAR® partner, ViewSonic Corporation has determined that this product meets the ENERGY STAR® guidelines for energy efficiency. Disclaimer: ViewSonic Corporation shall not be liable for technical or editorial errors or omissions contained herein; nor for incidental or consequential damages resulting from furnishing this material, or the performance or use of this product.

In the interest of continuing product improvement, ViewSonic Corporation reserves the right to change product specifications without notice. Information in this document may change without notice.

No part of this document may be copied, reproduced, or transmitted by any means, for any purpose without prior written permission from ViewSonic Corporation.

To meet your future needs, and to receive any additional product information as it becomes available, please register your projector's warranty on the Internet at: <http://www.viewsonic.com>

For Your Records

Product Name:	ViewSonic PJ751
Model Number:	VPROJ27104-1W
Document Number	A-CD-PJ751
Serial Number:	_____
Purchase Date:	_____

FEATURES

- 1 High brightness for clear images in any settings
- 2 Whisper mode for quiet operation and extended lamp life
- 3 Magnification feature allows selected parts of the screen to be magnified for closer viewing
- 4 “My Screen” feature creates a customized start-up screen

BEFORE USE

Package Contents

Make sure all of the following items are included in the package. If anything is missing, please contact ViewSonic Corp.

NOTE: Keep the original packing material for future shipment.

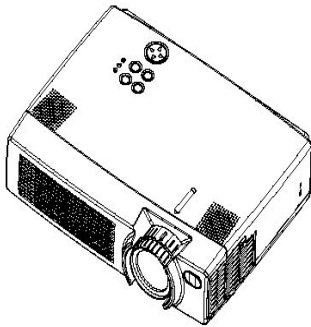

Projector

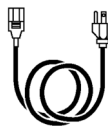

Power Cord (US)



Power Cord (UK)



Power Cord (EURO)

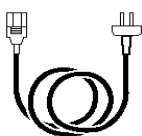

Power Cord (China)

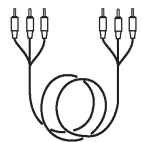

Video/Audio Cable

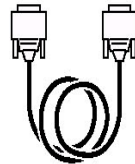

RGB Cable

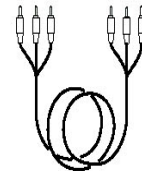

Component Video Cable

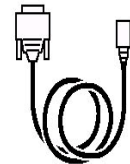

Mouse cable (PS/2)



Quick Start Guide



Handle

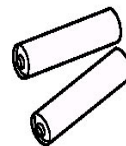

Batteries for Remote Control



Remote Control



Carrying Case



CD-Wizard

NOTE:

Applicable power cord is shipped with the projector to the point of destination.

WARNING: Before using this equipment, read this manual thoroughly. Always ensure that the equipment is used safely.

Component Names

Projector

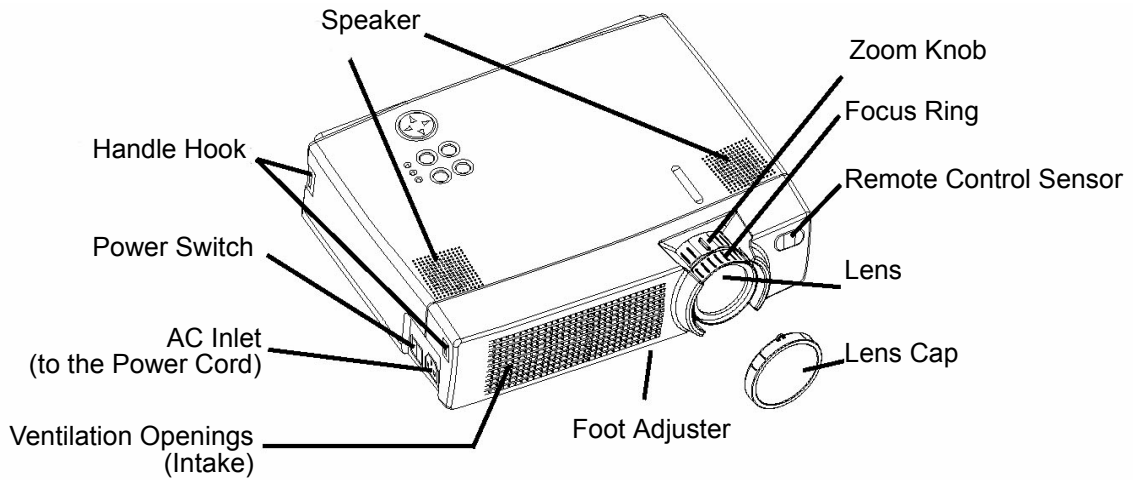

FRONT/LEFT VIEW OF THE PROJECTOR

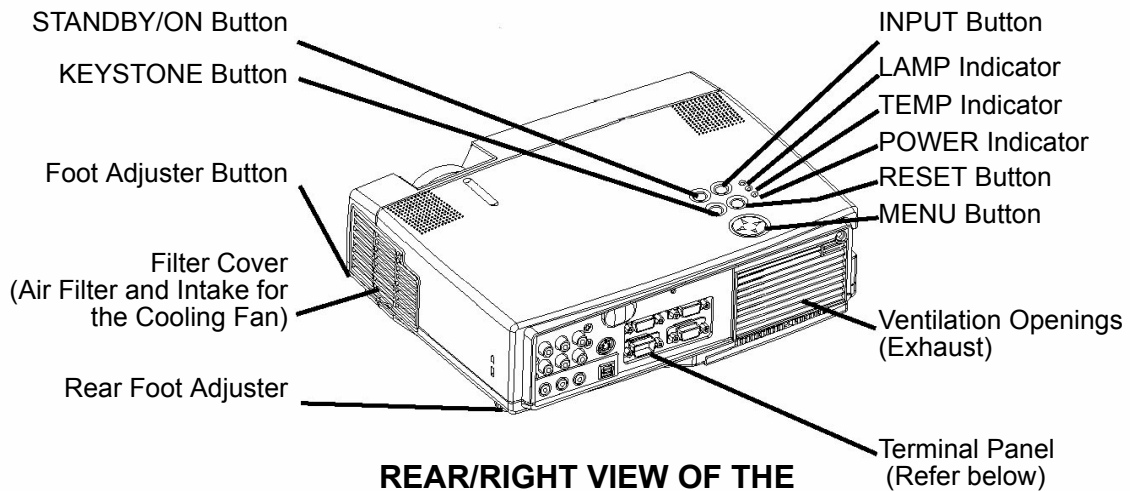

REAR/RIGHT VIEW OF THE PROJECTOR

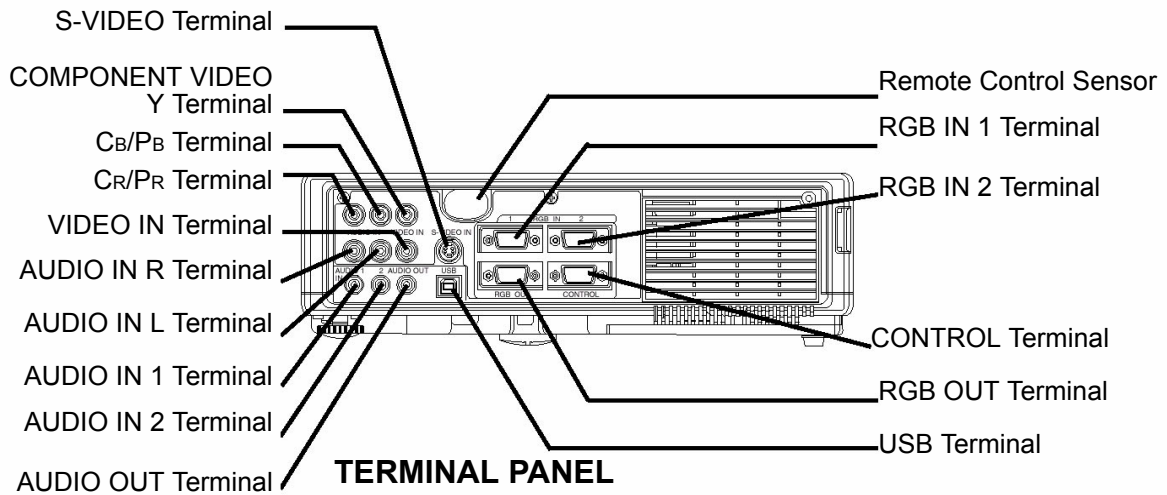

TERMINAL PANEL

Remote Control

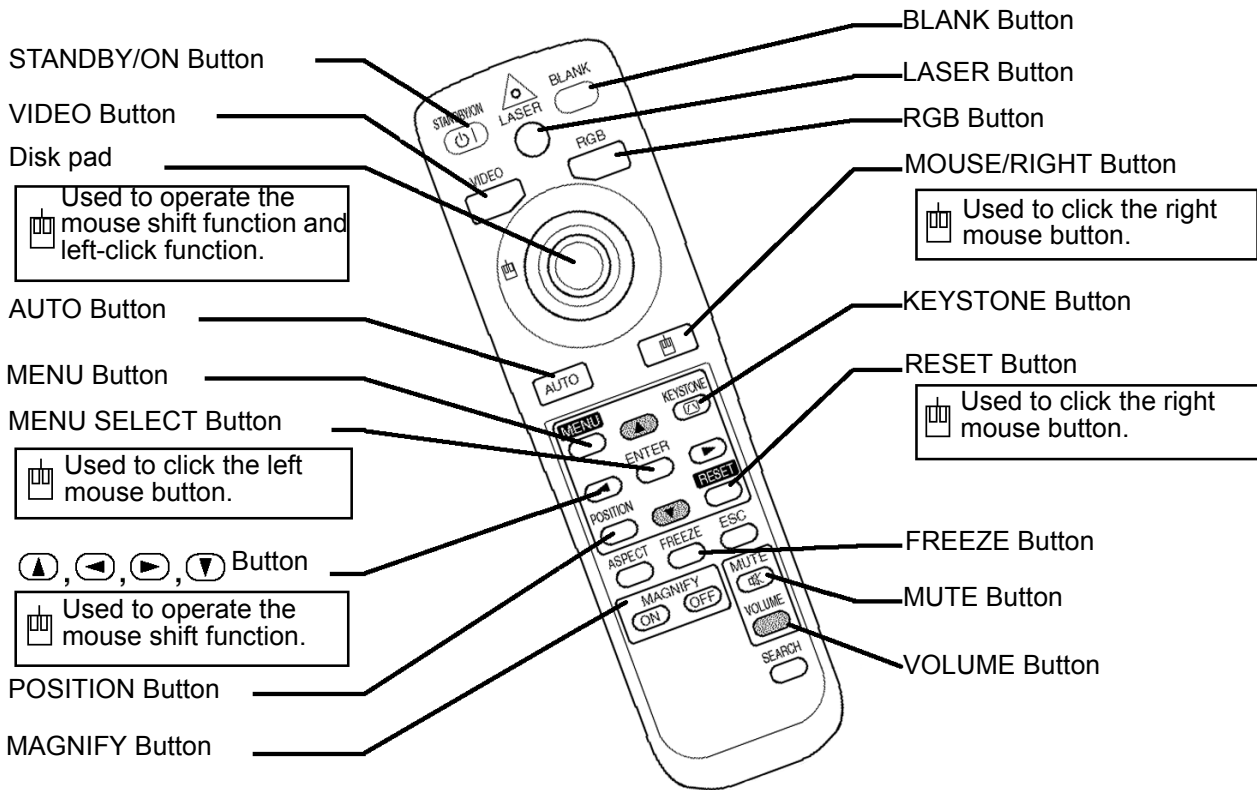

REMOTE CONTROL DEVICE

These functions work when the function for controlling the mouse has been activated. The mouse-controlling function will be disabled if POSITION, BLANK ON and MENU ON are selected.

WARNING The laser pointer of the remote control device is used instead of a finger or rod. Be sure to never look directly into the laser beam outlet or point the laser beam at other persons. The laser beam may cause serious eye injuries.

AVOID EXPOSURE- LASER RADIATIONS ARE EMITTED FROM THIS APERTURE

CAUTION
LASER RADIATION- DO NOT STARE INTO BEAM
MAX. OUTPUT: 1mW
WAVE LENGTH: 650nm
CLASS2 LASER PRODUCT

LASER RADIATION DO NOT STARE INTO BEAM CLASS2 LASER PRODUCT
MAX. OUTPUT: 1mW
WAVE LENGTH: 650nm
IEC00825-1:1993+A1:1997

Complies with 21 CFR 1040.10 and 1040.11 except for deviations pursuant to Laser Notice No.50, dated 2001.7.26
SMK CORPORATION
6-5-5 Togoshi Shinagawa-ku, Tokyo, JAPAN 142-8511
MANUFACTURED November 2001
PLACE OF MANUFACTURER: A

NOTE:

- Always keep the remote control device out of reach of children and pets.
- Be sure to protect the remote control device against any physical impact and dropping.
- Do not place any heavy object on top of the remote control device.
- Be sure to protect the remote control device against humidity or contact with wet surfaces.
- Do not leave the remote control device near the projector's cooling fan outlet.
- Do not attempt to disassemble the remote control device.

Inserting the Batteries

Insert the AA batteries into the remote control device.

- 1 Remove the battery cover. Push the knob while lifting the battery compartment cover.
- 2 Insert the batteries according to their plus and minus poles.
- 3 Replace the battery compartment cover.

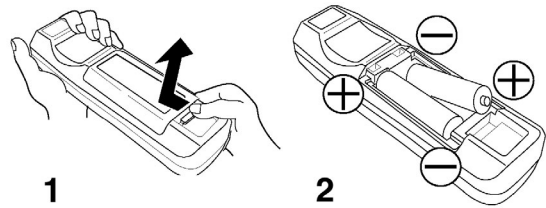

CAUTION

- Be sure to only use the specified batteries with this remote control device. Do not mix new and old batteries, since this may result in a cracking or leakage of batteries posing a risk of fire or leading to personal injury.
- Insert the batteries into the remote control device according to the indicated plus and minus poles. An incorrect insertion may result in a cracking or leakage of batteries posing a risk of fire or leading to environmental pollution.
- Before disposing of the batteries, please be sure to observe the respective regulations concerning the protection of environment in your country or area.
- Always be sure to keep the batteries out of reach of children or pets.
- If the remote control device will not be used for an extended period of time, remove the batteries from its battery compartment.

NOTE:

Replace the batteries if the operation of the remote control device becomes irregular or weak.

Attaching the Strap Handle

Attach the enclosed handle, if necessary.

- 1 Lift up the hook and pass one end of the strap through the hole of the handle hook.
- 2 Buckle the end of the strap as shown on the right.
- 3 Fix the other end of the strap to the other handle hook in the same way.

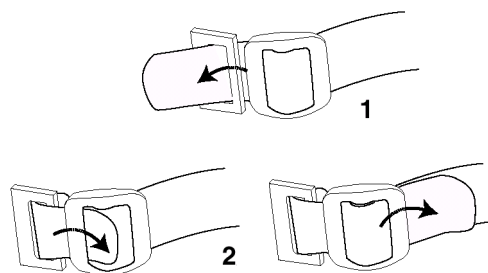

CAUTION

Be sure that the strap is secure before attempting to lift the projector by its handle. Dropping the projector may result in damage to the unit or electrical shock.

INSTALLATION

Installation of the Projector and Screen

To set the screen size and projection distance, see the illustration and table below.

The projection distance shown in the table below represents the full displayable resolution (1024 x 768).

a: Distance from the projector to the screen ($\pm 10\%$).

Reference for Installation

Screen size [inches (m)]	a [inches (m)]	
	Min.	Max.
40 (1.0)	62 (1.6)	82 (2.1)
60 (1.5)	94 (2.4)	123 (3.1)
80 (2.0)	127 (3.2)	164 (4.2)
100 (2.5)	160 (4.1)	205 (5.2)
120 (3.0)	192 (4.9)	246 (6.3)
150 (3.8)	241 (6.1)	308 (7.8)
200 (5.0)	323 (8.2)	411 (10.4)

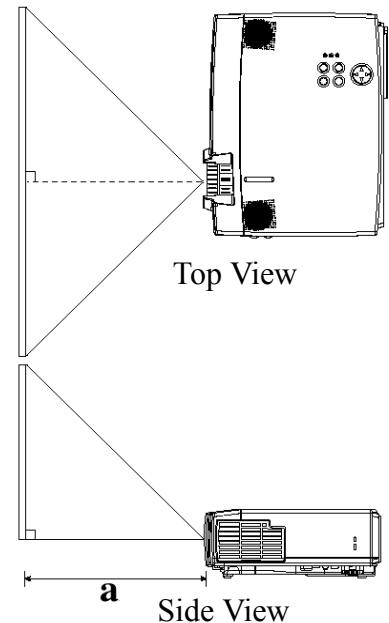

CAUTION

- Install the projector in a suitable environment as indicated in this manual.
- If you use a metallic hardware support to mount this unit, be sure to ground it to avoid a risk of fire or electrical shock.
Connect the ground terminal of the AC inlet of this unit to the ground terminal provided in the building using an optional three-core power supply cord.
- Always use the projector in a horizontal position. If you operate the projector with its lens upwards, its lens downwards or to the side, the heat generated inside the projector may build up and cause malfunctions or damage. Never block the ventilation holes.
- Do not install the projector in a smoky environment, since smoke residue may accumulate on critical parts (i.e. LCD panel, lens, etc.).

Angle Adjustment

Use the foot adjusters located on the bottom of the projector to adjust the projection angle. This angle can be adjusted within approximately 0° to 9° .

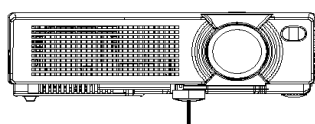

Foot Adjusters

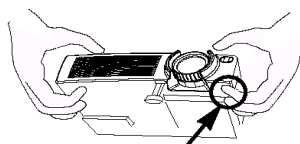

Press the foot adjuster button

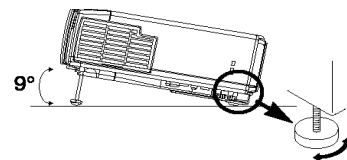

Rear Foot Adjuster

- Lift up the front side of the projector, then press the button of the foot adjuster to adjust the angle of projection.
- To lock the foot adjuster at the desired angle, release the button.
- Rotate the screw of the foot adjuster to precisely adjust it. Do not use force, since this could damage the adjuster or result in a failure of the lock.

CAUTION

- Do not release the foot adjuster button unless you are holding the projector securely.

Ports and Cables

Refer to this table to determine which projector port and cable to use for connecting to a given device. Use this table for determining which cables to prepare.

Function	Terminal	Cable
RGB input	RGB IN 1	Accessory or optional RGB cable with D-sub 15-pin shrink jack and inch thread screws.
	RGB IN 2	
RGB output	RGB OUT	
Audio input (from the computer)	AUDIO IN 1 (interlocked with RGB IN 1)	Optional audio cable with stereo mini-jack
	AUDIO IN 2 (interlocked with RGB IN 2)	
USB mouse control	USB	Optional USB cable
PS/2 mouse control	CONTROL	Accessory PS/2 mouse cable
ADB mouse control		Optional ADB mouse cable
Serial mouse control		Optional serial mouse cable
RS/232C communication		Optional RS-232C mouse cable
S-video input		S-VIDEO IN
Video input	VIDEO IN	Accessory audio/video cable
Component video input	COMPONENT VIDEO Y	Accessory component video cable
	COMPONENT VIDEO Cb/Pb	
	COMPONENT VIDEO Cr/Pr	
Audio input (from video equipment)	AUDIO IN L	Accessory audio/video cable or optional audio cable with RCA jack
	AUDIO IN R	
Audio output	AUDIO OUT	Optional audio cable with stereo mini-jack

Power Connection

If the power cord is not compatible with the local AC outlet standard, contact your local dealer or ViewSonic Corp to obtain the correct power cord..

Connect the AC inlet of the projector firmly to the power outlet with the power cord.

CAUTION

- Be alert when handling the power cord. Do not bend the cord at a sharp angle or lay it under sharp heavy objects that could cut the insulation.
- Plug the power connector securely to an AC wall outlet.

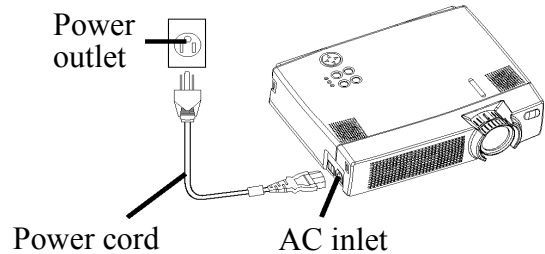

Connecting Your Devices

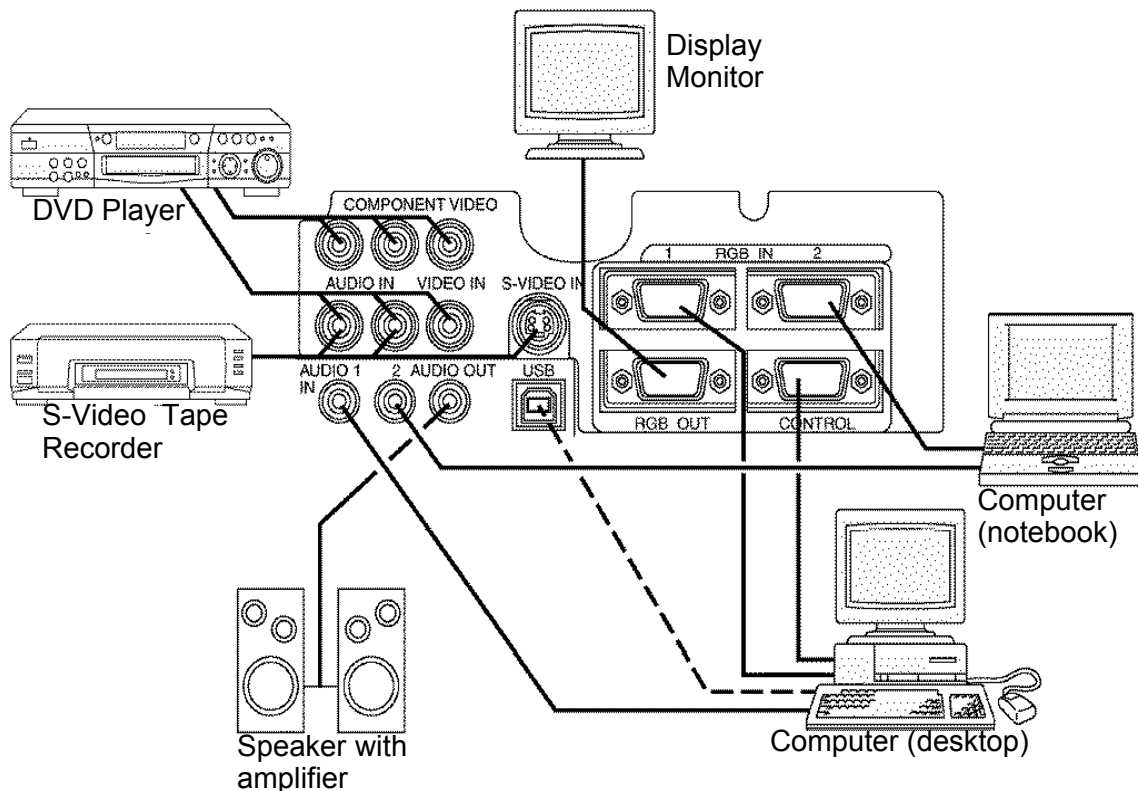

NOTE: When connecting the projector to a notebook computer, set it so as to activate the RGB external image output (setting it to CRT display or to simultaneous LCD and CRT display). For more information, refer to the instruction manual of the notebook computer.

Plug & Play

This projector is compatible with VESA DDC 1/2B. Plug & Play is possible by connecting to a computer that is compatible with VESA DDC (Display Data Channel).

Use this function by connecting the accessory RGB cable with RGB IN 1 terminal (DDC 1/2B compatible). Plug & Play may not operate by any other connection.

NOTE:

- Plug & Play is a system configured with peripheral equipment which includes a computer, display and an operating system.
- This projector is recognized as a Plug & Play monitor. Load the driver contained in the CD Wizard included with the unit.

Connecting to a Computer

ATTENTION: Whenever attempting to connect a laptop computer to the projector, be sure to activate the laptop's RGB external image output (set the laptop to CRT display or to simultaneous LCD and CRT display). For details on how this is done, please refer to the laptop computer's instruction manual of the corresponding laptop computer.

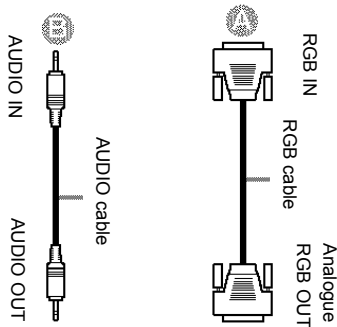
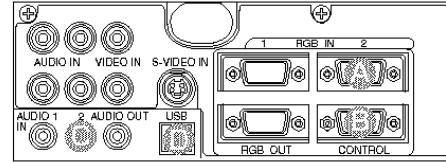
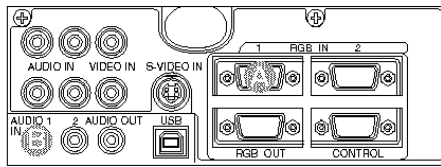

Laptop computer

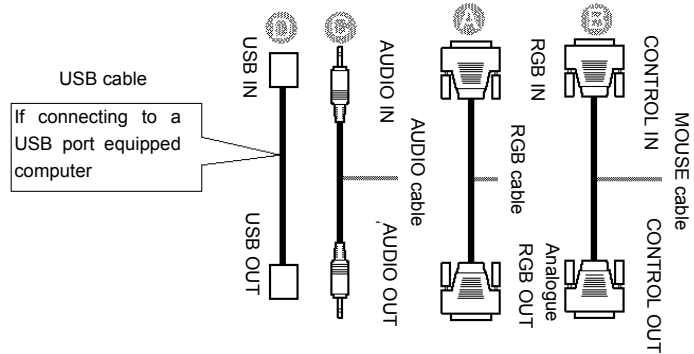

Desktop computer

NOTE:

- Some computers may have multiple display screen modes. The use of some of these modes may not be possible with this projector.
- For some RGB input modes, the optional Mac adapter is necessary.

Connecting to a DVD Player or VCR

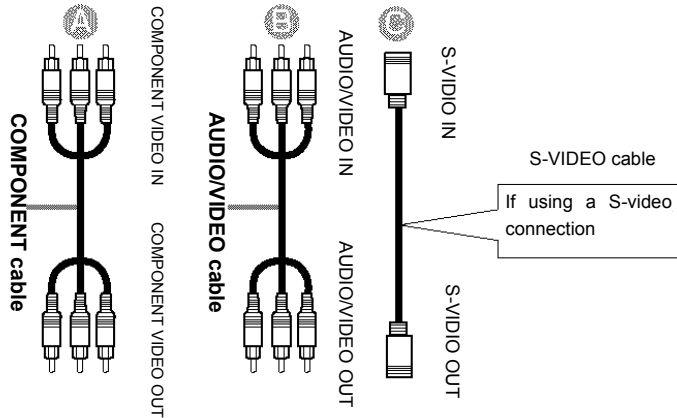
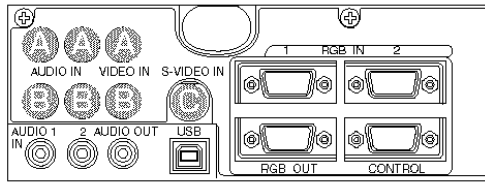

If using a component video connection If using an audio/video connection

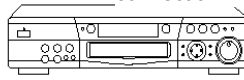

DVD player

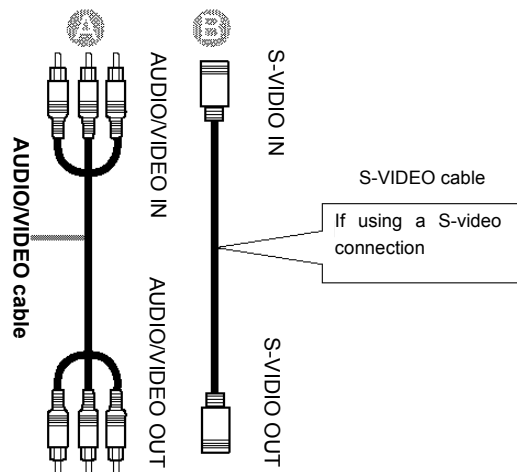
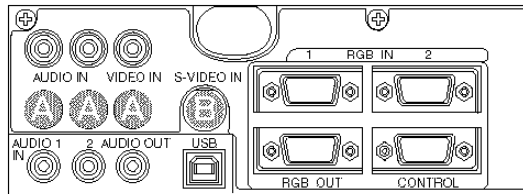

VCR

Connecting to a Display Monitor

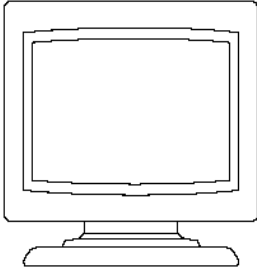
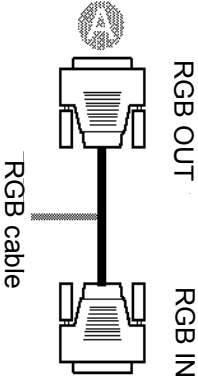
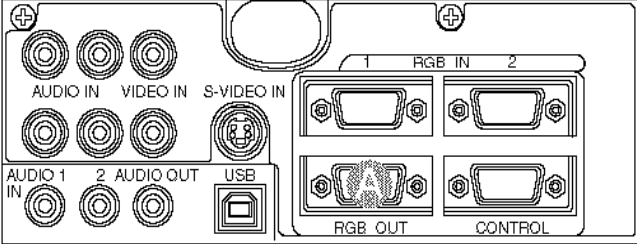

Display monitor

OPERATION

POWER Indicator

STANDBY/ON Button

STANDBY/ON Button

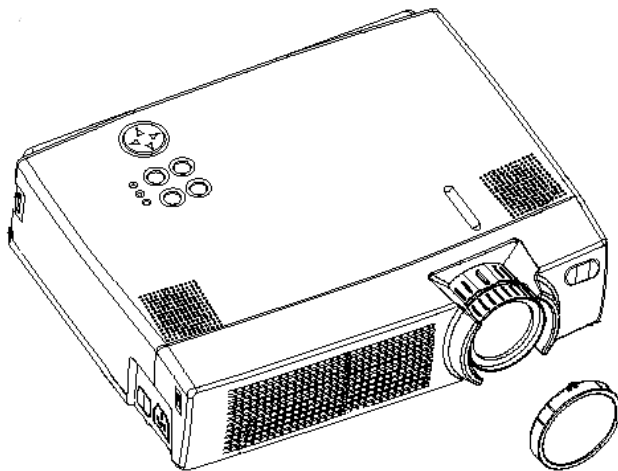

Power Switch

Lens cap

ZOOM Knob

FOCUS Ring

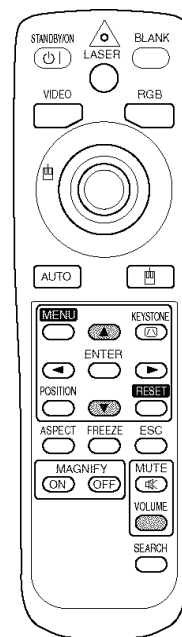

Power ON

- 1 Check to be sure the power cord is connected correctly.
- 2 Set the power switch to [I]. When the standby mode is selected, the POWER indicator is orange.
- 3 Press the STANDBY/ON button on the control panel or the remote control device. The warm-up starts and the POWER indicator blinks green.
- 4 The POWER indicator stops blinking and turns green when the power is on.
- 5 Remove the lens cap.
- 6 Adjust picture size using the ZOOM Knob.
- 7 Adjust focus with the FOCUS Ring.

Power OFF

- 1 Press the STANDBY/ON button on the control panel or the remote control device. The message "Power off?" will appear on the screen. The message will disappear by any operation or if no operation is carried out for 5 seconds. During this message indication, press the STANDBY/ON button again. The projector lamp is turned off and the lamp will cool down. The POWER indicator blinks orange when the lamp cools down. Pressing the STANDBY/ON button has no effect while the POWER indicator is blinking.
- 2 The system goes into the Standby mode after cooling, then the POWER indicator stops blinking and changes to orange. Check to be sure the indicator is orange then set the power switch to [0].
- 3 The POWER indicator is extinguished when power is off. Be sure to replace the lens cap.

NOTE:

- Except in emergencies, follow the above-mentioned procedure for turning the power off. Incorrect procedure will shorten the life of the projector lamp and LCD panel.
- To prevent any trouble, turn the projector on/off when the computer or video tape recorder is OFF. Providing a RS-232C cable is connected, turn on the computer before switching on the projector.

Selecting an Input Signal

Using the remote control

If selecting RGB input Press the RGB button

Press this button to toggle between the devices connected to RGB IN 1 and 2. As illustrated below, each time you press the RGB button, the projector switches between RGB IN 1 and 2. Select the signal you wish to project.

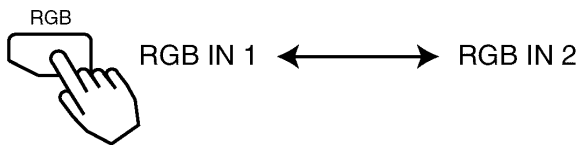

If selecting video input Press the VIDEO button

Press this button to toggle between the devices connected to VIDEO IN, SVIDEO IN and COMPONENT VIDEO. As illustrated below, each time you press the VIDEO button, the projector switches between VIDEO IN, S-VIDEO IN and COMPONENT VIDEO. Select the signal you wish to project.

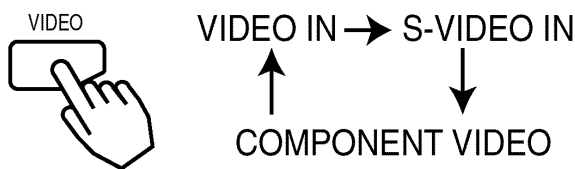

Using the projector's control panel

Press the INPUT button

As illustrated below, each time you press the INPUT button, the projector switches between its input signal ports. Select the signal you wish to project.

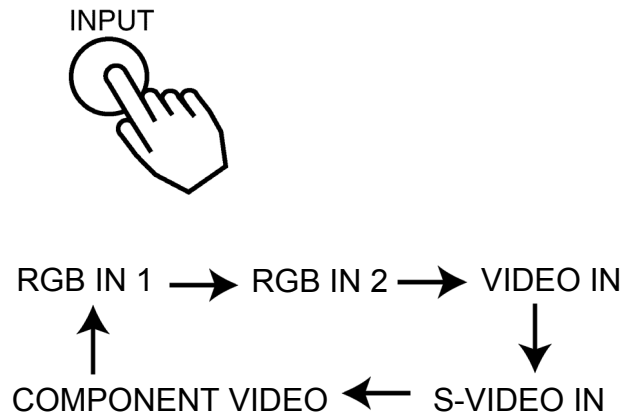

Adjusting Image Size and Focus

Use the zoom ring to adjust the screen size

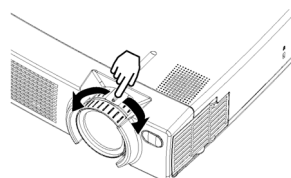

Use the focus ring to focus the picture

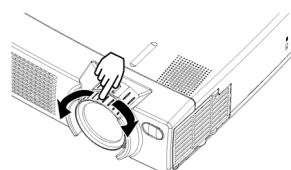

Adjusting the Volume

1 Press the VOLUME button

As illustrated on the right, a dialog box will appear on the screen to aid you in adjusting the volume.

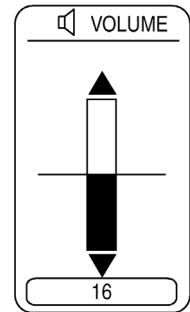
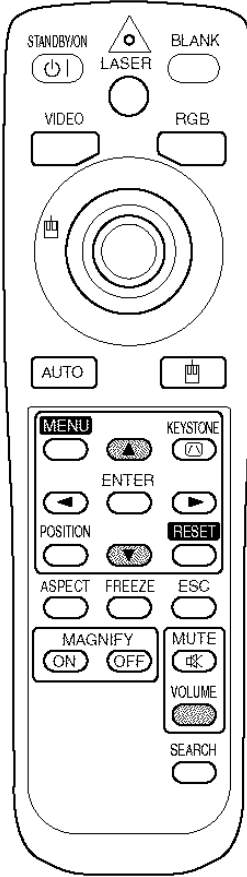

2 Press the ▲, ▼ buttons to adjust the volume

Press the VOLUME button again to close the dialog box and complete this operation. (Even if you don't do anything, the dialog box will automatically disappear after a few seconds.)

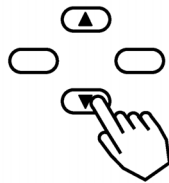

- ▲ Press this to increase the volume
- ▼ Press this to decrease the volume

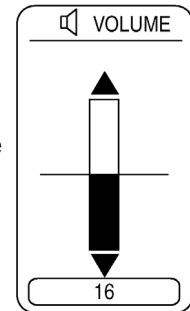

Temporarily Muting the Sound

1 Press the MUTE button

As illustrated on the right, a dialog will appear on the screen indicating that you have muted the sound. Press the VOLUME button to close the dialog box. (Even if you don't do anything, the dialog box will automatically disappear after a few seconds.)

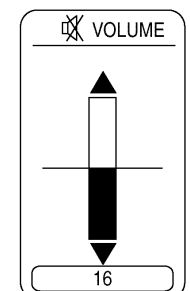
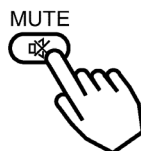
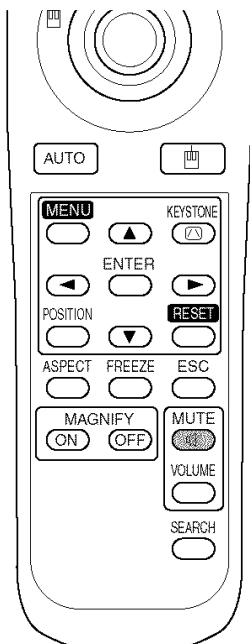

2 Press the MUTE button once again to restore the sound.

Adjusting the Image Position

1 Press the POSITION button

As illustrated on the right, a dialog box will appear on the screen to aid you in adjusting the position.

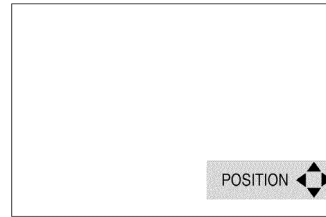
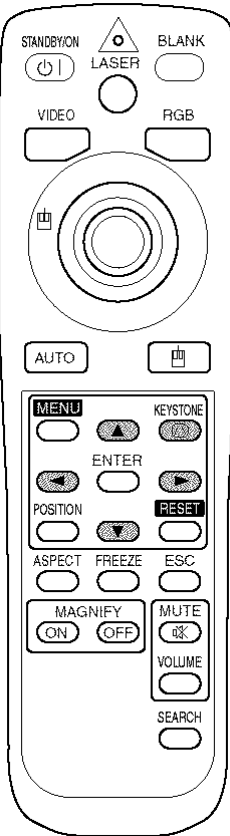

2 Use the ◀, ▶, ▲, ▼ buttons to adjust the position

When you want to initialize the position, press the RESET button during adjustment.

Press the POSITION button again to close the dialog box and complete this operation. (If no activity is detected, the dialog will automatically disappear after a few seconds.)

This function is only available for RGB IN 1/2 input.

Control Panel

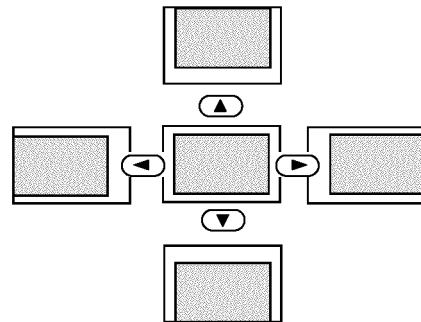
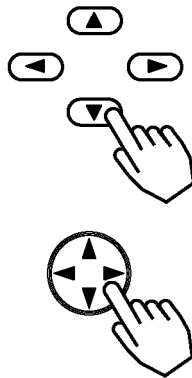
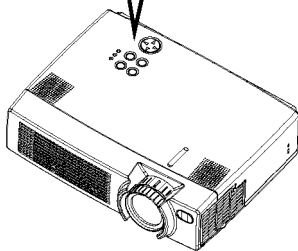
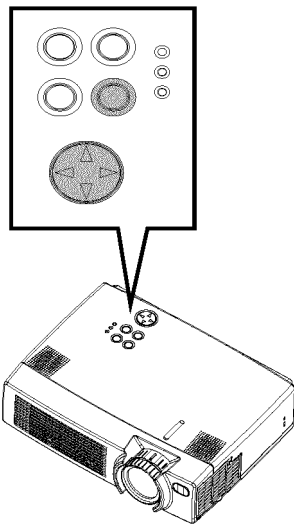

Using the Automatic Adjustment Feature

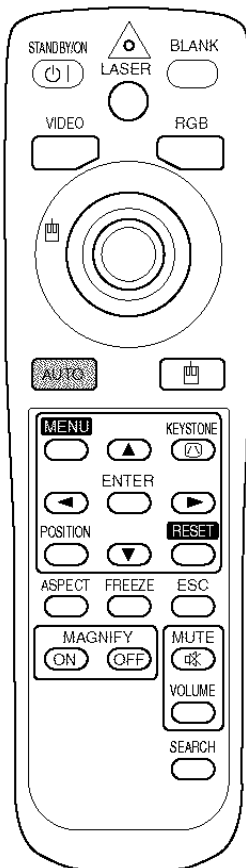

Press the AUTO button

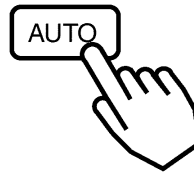

Automatic Adjustment for RGB Input

Horizontal position (H. POSIT), vertical position (V. POSIT), clock phase (H. PHASE) and horizontal size (H. SIZE) are automatically adjusted. Make sure that the application window is set to its maximum size prior to attempting to use this feature. Dark pictures may still be incorrectly adjusted. Use a bright screen when adjusting.

Automatic Adjustment for Video Input

The input signal with best quality will be selected automatically.

This feature is available only if VIDEO is set to AUTO in the INPUT menu.

NOTE:

- The automatic adjustment operation requires approximately 10 seconds. Certain input signals may not function properly during this adjustment.

Correcting Keystone Distortions

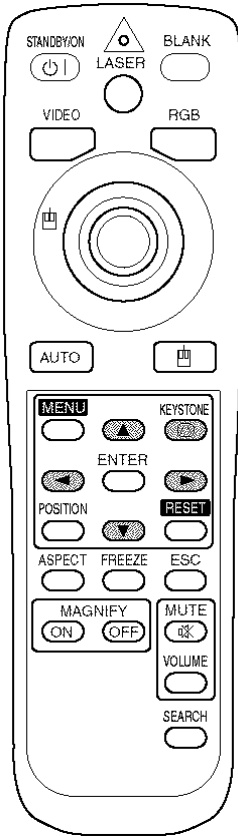

1 Press the KEYSTONE button

As illustrated on the right, a dialog box will appear on the screen to aid you in correcting the distortion.

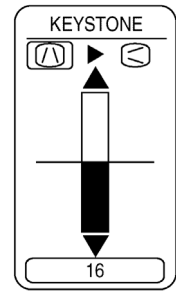

2 Use the ◀, ▶ buttons to select the direction of distortion to correct (⤴ / ⤵)

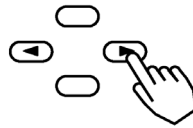

3 Use the ▲, ▼ buttons to correct the distortion

Press the KEYSTONE button again to close the dialog box and complete this operation. (If no activity is detected, the dialog box will automatically disappear after a few seconds.)

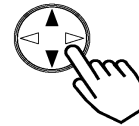
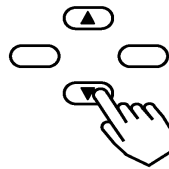

Control Panel

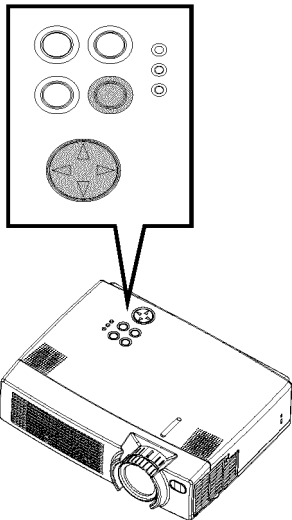

NOTE:

- This function may not work well with some input signal types.
- The adjustment range for keystone distortion correction varies with input signal type.

Using the Magnify Feature

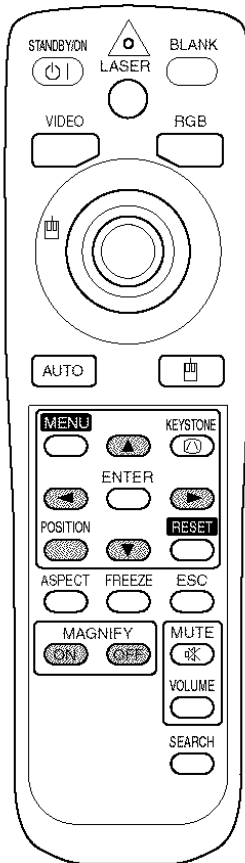

1 Press the MAGNIFY (ON) button
The projector enters MAGNIFY mode.



2 Press the POSITION button, then use the ◀, ▶, ▲, ▼ buttons to select the area to enlarge and then press the POSITION button again to confirm your selection.

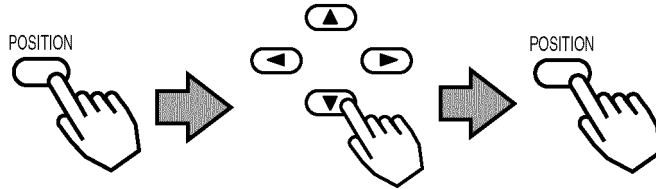

3 Press the ▲, ▼ buttons to zoom in and out of the selected area.

Press the MAGNIFY (OFF) button to exit MAGNIFY mode and restore the screen to normal. (The projector will also automatically exit MAGNIFY mode if there is a change in the input signal's state.)

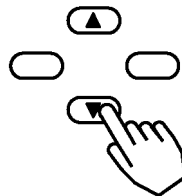

NOTE:

The projector will automatically exit from MAGNIFY mode if either the INPUT SELECT, AUTO, ASPECT or VIDEO feature is used, or if there is a change in the input signal's state.

Freezing the Screen

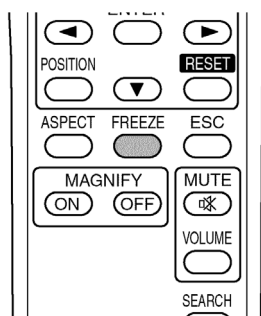

1 Press the FREEZE button

The [||] icon appears and the screen will freeze at the current image. Press the FREEZE button again and the [▶] appears as the projector exits FREEZE MODE.



NOTE:

- The projector will automatically exit FREEZE mode if either the POSITION, VOLUME, MUTE, AUTO, BLANK ON/OFF, or MENU ON/OFF feature is used, or if there is a change in the input signal's state.
- If the projector continues projecting the same image for a long time (i.e. you forget to exit FREEZE mode), the image may remain as an afterimage. Do not leave the projector in FREEZE mode for too long.

Signal Searching

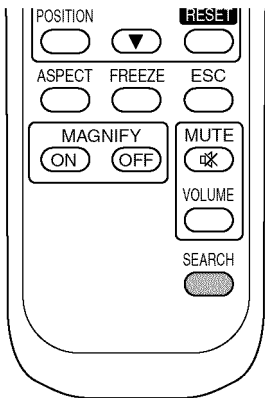

1 Press the SEARCH button

When you press the SEARCH button, the projector begins searching for input signals. If it detects an input signal, the search will cease and the projector will project the detected signal. If the projector is unable to find an input signal at any of its ports, it will return to the state it was in prior to the search.

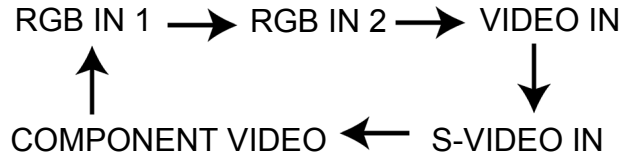

Selecting the Aspect Ratio

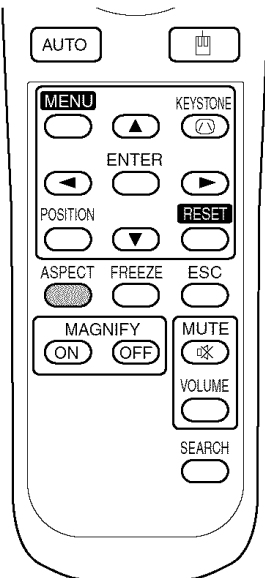

1 Press the ASPECT button

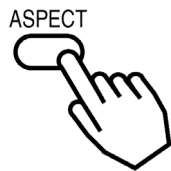

RGB IN 1, RGB IN 2, COMPONENT VIDEO

(HDTV signals : 1125i (1035i/1080i), 720p)

4:3 ↔ 16:9

VIDEO IN, S-VIDEO IN, COMPONENT VIDEO

(Non-HDTV signals : 525i, 525p, 625i)

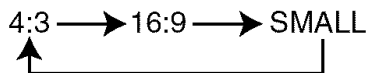

Temporarily Blanking the Screen

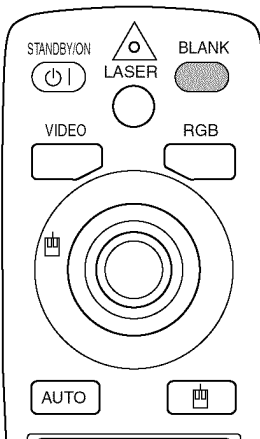

1 Press the BLANK button

The input signal screen is shut off, and a blank screen appears. You can set the blank screen using the menu (from the SCREEN menu, select BLANK). Press the BLANK button again to remove the blank screen, and return to the input signal screen.

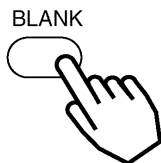

Using the Menu Functions

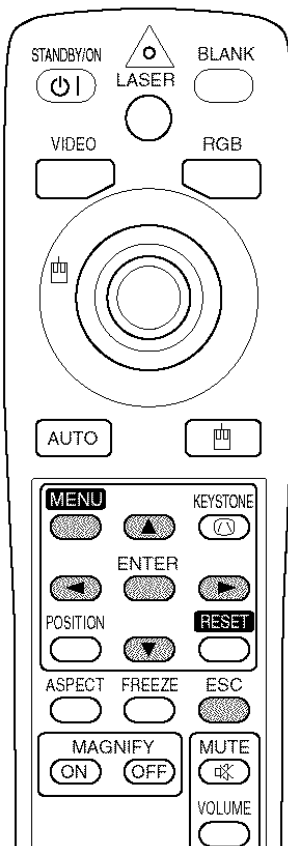

1 Press the MENU button

The menu display appears on the screen. The projector has the following menus: MAIN, PICTURE-1, PICTURE-2, INPUT, SCREEN, and OPTION. Select a menu using the / buttons. The current settings of the items that can be manipulated via the selected menu appear.

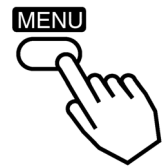

2 Select a menu using the / buttons, then press the or ENTER button. The display for the selected menu appears. [ex. Adjusting SHARPNESS] Use the / buttons to select PICTURE-1, then press the or ENTER button.

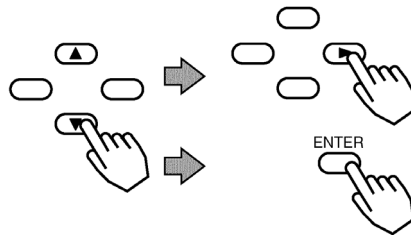

MENU	
MAIN	
PICTURE-1	COLOR BAL R -1
PICTURE-2	COLOR BAL B +1
INPUT	SHARPNESS -1
SCREEN	COLOR +1
OPTION	TINT -1

: SELECT

3 Select an item using the / buttons, then press or the ENTER button. The operation display of the selected item appears. To adjust a numerical value, press or ENTER button again to switch to the single menu (small display showing only the operation display area).

[ex. Adjusting SHARPNESS]

Use the / buttons to select SHARPNESS, then press or the ENTER button.

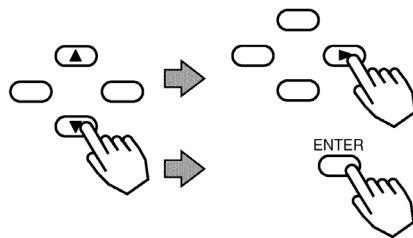

MENU	
MAIN	COLOR BAL R
PICTURE-1	COLOR BAL B
PICTURE-2	SHARPNESS
INPUT	COLOR
SCREEN	TINT
OPTION	

: SELECT

4 Press the / buttons to adjust the level.

Press the MENU button to hide the menu and finish your operation. Alternatively, press or the ESC button to return to the previous display.

[ex. Adjusting SHARPNESS]

Use the / buttons to adjust the SHARPNESS.

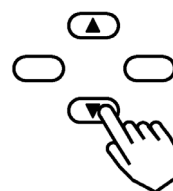

Operating the PC Screen

Caution: Mistaken use of the mouse/keyboard control could damage your equipment.

- Only connect to a PC.
- Before connecting, read the manual of the device you will connect.
- Do not plug or unplug the connector cables while the computer is operating.

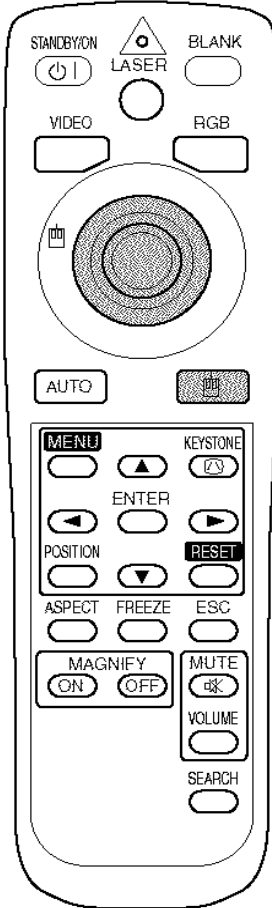

PS/2, ADB, Serial Mouse Control

Turn off the projector and PC power, then connect the projector's CONTROL terminal to the computer via the mouse cable.

If a USB cable is connected, disconnect it. If a USB cable is connected, the USB control function is given priority and mouse control from the CONTROL terminal will not function.

Turn on the projector power, then the computer. The functions in the table below can be controlled. If you have difficulty with control, restart the computer (either from the software or by pressing the restart button).

Available Functions	Remote Control Operation
Move Pointer	Use button
Left click with mouse	Press button
Right click with mouse	Press button

USB Mouse Control

Connect the projector's USB terminal to the computer using a USB cable. The functions listed below can be controlled.









Available Functions	Remote Control Operation
Move Pointer	Use button
Left click with mouse	Press button
Right click with mouse	Press button

NOTES:

- Using the remote control, it may not be possible to control notebook PCs, and other computers with built-in pointing devices (e.g. track balls). In this case, before connecting go into BIOS (system setup), select external mouse, and disable the pointing devices. In addition, the mouse may not function if the computer does not have the needed utility program. See your computer's hardware manual for details.
- The USB control can be used with Windows 95 OSR 2.1 or higher.
- The USB control can only be used for the functions listed above. You cannot do things such as press two buttons at once (for instance, pressing two buttons at the same time to move the mouse pointer diagonally).
- This function is not available while the lamp is warming up (the POWER indicator flashes green), while adjusting the volume and display, correcting for trapezoidal distortion, zooming in on the screen, using the BLANK function, or for displaying the menu.

OSD MENU FUNCTION DESCRIPTION

This projector has 6 separate menus: MAIN, PICTURE 1, PICTURE 2, INPUT, SCREEN, and OPTION. Each of these menus is operated using the same methods. The basic operations of these menus are:

- Menu screen display:** Press the "MENU" button.
- Menu selection:** Choose a menu name using the  /  button, and press the  button or the ENTER button.
- Item selection:** Choose an item using the  /  button, and press the  button or the ENTER button.
- Return menu to last previous screen:** Press the  button or the ESC button.
- Execution of settings and/or adjustments:** Operate by using the  /  button. (For further details, read the explanation for each separate menu.)
- Initialization of settings and/or adjustments:** During operation, press the RESET button. (Note that items whose functions are performed simultaneously with the operation of clock phase, language selection, automatic adjustment, etc., cannot be initialized.)
- End menu operations:** Press the MENU button, or do not perform any operation for several seconds.







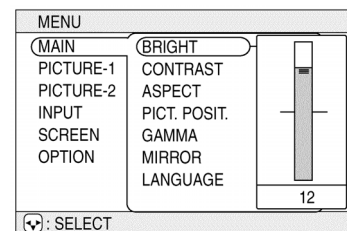































Main Menu

With the MAIN menu, the seven items shown in the Table below can be performed.

Perform each operation in accordance with the instructions in the Table.



Example: MAIN Menu (BRIGHT)

Item	Description
BRIGHT	Adjust Brightness: Light  ⇌  Dark
CONTRAST	Adjust Contrast: Strong  ⇌  Weak
ASPECT	Select Aspect Ratio: At RGB Input or Hi-Vision 1125i(1035i/1080i)/720p of COMPONENT VIDEO Input: 4:3  ⇌  16:9 At VIDEO Input, S-VIDEO Input or 525i/525p/625i of COMPONENT VIDEO Input: 4:3  ⇌  16:9  ⇌  SMALL The SMALL picture may not be displayed correctly with certain input signals.
PICT. POSIT.	Select Picture Position (for 16:9/SMALL Picture): TOP  ⇌  CENTER  ⇌  BOTTOM
GAMMA	Select Gamma Mode: NORMAL  ⇌  CINEMA  ⇌  DYNAMIC
LANGUAGE	Select Menu Language: ENGLISH  ⇌  FRANÇAIS  ⇌  DEUTSCH  ⇌  ESPAÑOL  ⇌  ITALIANO  ⇌  NORSK  ⇌  NED-ERLANDS  ⇌  JAPANESE  ⇌  POTUGUÊS  ⇌  CHINESE  ⇌  KOREAN

Picture 1 Menu

Using the PICTURE 1 menu, the five items shown in the Table below can be performed.

Perform each operation according to the instructions in the Table.

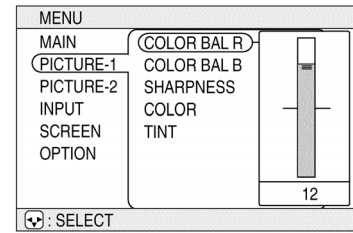

Example: PICTURE1 Menu (COLOR BAL R)

Item	Description
COLOR BAL R	Adjust Red Color Balance: Dark Light
COLOR BAL B	Adjust Blue Color Balance: Dark Light
SHARPNESS	Adjust Sharpness (for VIDEO/S-VIDEO): Clear Soft
COLOR	Adjust COLOR (for VIDEO/S-VIDEO/COMPONENT VIDEO): Dark Light
TINT	Adjust Tint (for VIDEO/S-VIDEO): Green Red

Picture 2 Menu

Using the PICTURE 2 menu, the five items shown in the Table below can be performed.

Perform each operation according to the instructions in the Table.

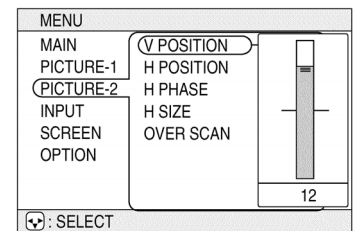

Example: PICTURE2 Menu (V POSITION)

Item	Description
V POSITION	Adjust Vertical Position (for RGB): Up Down
H POSITION	Adjust Horizontal Position (for RGB): Left Right
H PHASE	Adjust Horizontal Phase (for RGB/COMPONENT VIDEO): Right Left Adjust to eliminate flicker.
H SIZE	Adjust Horizontal Size (for RGB): Large Small If the horizontal size adjustment is excessive, the image may not be displayed correctly. In such a case, initialize H SIZE with the RESET button.
OVER SCAN	Select Over-scan Ratio (for VIDEO/S-VIDEO/COMPONENT VIDEO): LARGE MIDDLE SMALL It is recommended to select SMALL to avoid flicker at the lower part of the picture.

Input Menu

With the INPUT menu, the four items shown in the Table below can be performed. With inputting of RGB IN 1 and RGB IN 2 signals, the horizontal and vertical frequencies of the signals will be displayed on the initial screen of the INPUT menu.

Perform each operation according to the instructions in the Table.

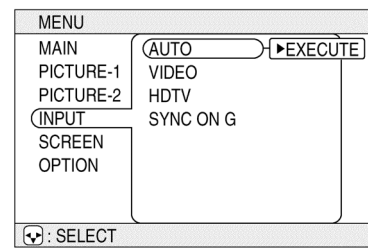

Example: INPUT Menu (AUTO)

Item	Description
AUTO	<p>Auto Adjust (for RGB): Automatically adjusts H POSITION, V POSITION, H PHASE, and H SIZE. Use this function with the maximum window size.</p> <p>Auto Adjust (for VIDEO/S-VIDEO): Automatically selects the proper VIDEO mode for the current input signal. This function is active only when the AUTO mode is selected for the item VIDEO. Refer to the description for the item VIDEO below.</p> <p>This function may not be available with a PAL60 signal and certain other signals.</p> <p>The AUTO mode operation requires approximately 10 seconds.</p> <p>For COMPONENT VIDEO, the signal type is identified automatically even if this function is inactive. For a HDTV signal, refer to the item HDTV below.</p>
VIDEO	<p>Select Mode of Signal Type (for VIDEO/S-VIDEO):</p> <p>AUTO ⇌ NTSC ⇌ PAL ⇌ SECAM ⇌ NTSC4.43 ⇌ M-PAL ⇌ N-PAL</p> <p>Selecting AUTO mode activates and performs the AUTO function for VIDEO/SVIDEO. It automatically selects the proper mode from among those above. Use this function if the image becomes unstable with VIDEO/S-VIDEO. (e.g. The image becomes irregular, or lacks color.)</p> <p>AUTO mode may not function correctly with a PAL60 signal and certain other signals.</p> <p>The AUTO mode operation requires approximately 10 seconds.</p> <p>For COMPONENT VIDEO, the signal type is identified automatically even if this function is inactive. For a HDTV signal, refer to the item HDTV below.</p>
HDTV	<p>Select HDTV Signal Mode:</p> <p>1080i ⇌ 1035i</p> <p>If the selected HDTV mode is incompatible with the input signal, the picture may be distorted.</p>
SYNC ON G	<p>On/Off SYNC ON G Mode:</p> <p>TURN ON ⇌ TURN OFF</p> <p>Selecting TURN ON turns on the SYNC ON G mode. The SYNC ON G mode allows reception of SYNC on G.</p> <p>In the SYNC ON G mode, the picture may be distorted with certain input signals. In such cases, remove the signal connector so that no signal is received and turn SYNC ON G off, and then reconnect the signal.</p>

Screen Menu

Using the SCREEN menu, the five items shown in the Table below can be performed. Please perform each operation according to the instructions in the Table.

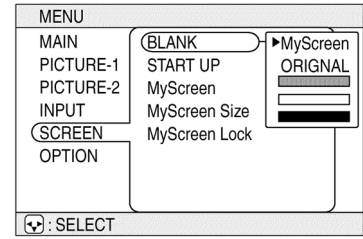

Example: SCREEN Menu (BLANK)

Item	Description
<p>BLANK</p>	<p>Selection of BLANK Screen:</p> <p>MyScreen (▼) ⇔ (▲) ORIGINAL (▼) ⇔ (▲) [Screen Icon] (▼) ⇔ (▲) [Black Screen Icon]</p> <p>The BLANK Screen may be voluntarily selected. The BLANK Screen is displayed when the screen has been erased (i.e., made to vanish) by manipulating the BLANK button (please refer to the “Temporarily Blanking the Screen” section of the separate booklet, Vol. 1 (Basic)).</p> <p>MyScreen: Using the MyScreen category (see this Table, below), one can register a desired screen (or screens). At the time of factory shipment, this is set as a non-patterned (plain) blue color screen.</p> <p>ORIGINAL: Existing standard screens. Please make confirmation using the actual screen(s).</p> <p>Option screens: Various colored non-patterned (plain) screens displayed within the Menus.</p> <p>The MyScreen and the ORIGINAL Screen will each change to a non-patterned (plain) black color screen several minutes after being displayed.</p>
<p>START UP</p>	<p>Selection of START UP Screen:</p> <p>MyScreen (▼) ⇔ (▲) ORIGINAL (▼) ⇔ (▲) TURN OFF</p> <p>The START UP Screen may be voluntarily selected. The START UP Screen is displayed when no signal has been inputted, or when spec signals are being inputted.</p> <p>MyScreen: Using the MyScreen category (see this Table, below), one can register a desired screen (or screens). At the time of factory shipment, this is set as a non-patterned (plain) blue color screen.</p> <p>ORIGINAL: Existing standard screens. Please make confirmation using the actual screen(s).</p> <p>TURN OFF: A non-patterned (plain) blue color screen.</p> <p>The MyScreen and the ORIGINAL Screen will each change to the BLANK Screen several minutes after being displayed.</p>

MyScreen	<p>Registration of MyScreen:</p> <p>When this item is executed, the MyScreen Menu for registration of MyScreen for the BLANK Screen and the START UP Screen is displayed. When operations are performed in accordance with this Menu, one can “cut” and register desired screens from among the received images within the display.</p> <p>After the “Do you start capturing this picture?” message has been displayed, pressing the ESC (or RESET) button interrupts execution of the MyScreen. When the ENTER button is pressed, the picture becomes static (no longer moves), and a frame for picture cutting, as well as the message that follows below, appear. Please press the button when the screen you want to register is currently being displayed.</p> <p>When the “Move the capture area as you want.” message has been displayed, pressing the ESC (or RESET) button will eliminate the static state of the picture, and operations can be performed again from operation 1. The frame can be moved using the ◀, ▶, ▲, ▼ buttons. After designating the screen you want to register, pressing the ENTER button will initiate screen registration. The registration process takes approximately 1 minute to complete.</p> <p>When the registration has been completed, the screen of the registered MyScreen, and the message, “MyScreen registration is finished,” will be displayed for several seconds, after which the operation is terminated.</p>
MyScreen Size	<p>Selection of MyScreen display size:</p> <p>x1 ▼ ↔ ▲ FULL</p>
MyScreen Lock	<p>Invalidation of MyScreen registration function:</p> <p>TURN ON ▼ ↔ ▲ TURN OFF</p> <p>When TURN ON is selected, the MyScreen category (see this Table, above) cannot be executed. In this way, one can prohibit rewrites (“writeovers”) of the MyScreen.</p>

Option Menu

Using the OPTION menu, the five items shown in the Table below can be performed.

Please perform each operation according to the instructions in the Table.

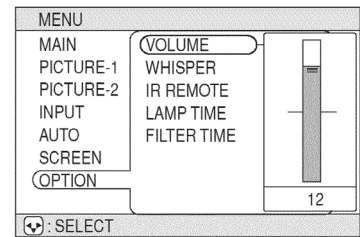

Example: OPTION Menu (VOLUME)

Item	Description
VOLUME	Adjust Volume: High Low
AUTO OFF	Adjust AUTO OFF Time: Long (MAX. 99 min.) Short (Min. 1 min.) (DISABLE: 0 min.) The system automatically enters the standby mode if no signal is received within the set time. This function is inactive when DISABLE (0 min.) is selected.
WHISPER	Select WHISPER Mode: NORMAL WHISPER When WHISPER is selected the WHISPER mode is activated. In the WHISPER mode, acoustic noise and screen brightness are reduced.
LAMP TIME	Refer to LAMP TIME: When set, this function displays the total time the projector lamp has been used since new. Reset LAMP TIME [Use this function only when the lamp has been replaced!]: Depress the RESET button for at least 3 seconds while lamp time is being displayed. The reset menu will then appear. After you replace the lamp with a new lamp, select RESET on the menu with the button. <ul style="list-style-type: none"> Do not reset the lamp time unless you have replaced the lamp. And, always reset the lamp time when replacing the lamp. Before replacing the lamp, carefully read the lamp maintenance section.
FILTER TIME	Refer to FILTER TIME: This function displays the total time the air-filter has been used since it was installed. Reset FILTER TIME [Use this function only when the filter is cleaned or replaced!]: Depress the RESET button for at least 3 seconds while lamp time is being displayed. The reset menu will then appear. After you replace the filter, select RESET on the menu with the button. DEFAULT CANCEL <ul style="list-style-type: none"> Do not reset the filter time unless you have cleaned or replaced the filter. And, always reset the filter time when cleaning or replacing the filter. The message functions will not operate properly if the filter time is not reset correctly. Before cleaning or replacing the filter, carefully read the descriptions titled "THE AIR FILTER".

MAINTENANCE

Lamp

To order a new lamp unit (Lamp Part # PRJ-RLC-001), contact ViewSonic or your dealer. For the lamp part number, see the Optional Parts in the Specifications in this guide. For contact information, see the Customer Support table in this guide. Before replacing the lamp, turn the Power Switch OFF, remove the power cord from the power outlet, then wait approximately 45 minutes until the lamp has cooled.

CAUTION: The lamp may explode if handled at high temperatures.



**HIGH VOLTAGE
HIGH TEMPERATURE
HIGH PRESSURE**

WARNINGS:

- Dispose of the used lamp according to local regulations.
- Since the lamp is made of glass, do not drop the unit and do not scratch the glass.
- Do not reuse the old lamp. This could cause the lamp to explode.
- If it is probable that the lamp has exploded (you have heard an explosive sound), disconnect the power plug from the power outlet and ask your dealer to replace the lamp. The lamp is protected by a cover glass, but in rare cases the reflector and the inside of the projector could be damaged by broken or shattered glass. Broken pieces of glass could cause injury.
- Do not use the projector with the lamp's front glass covering removed.

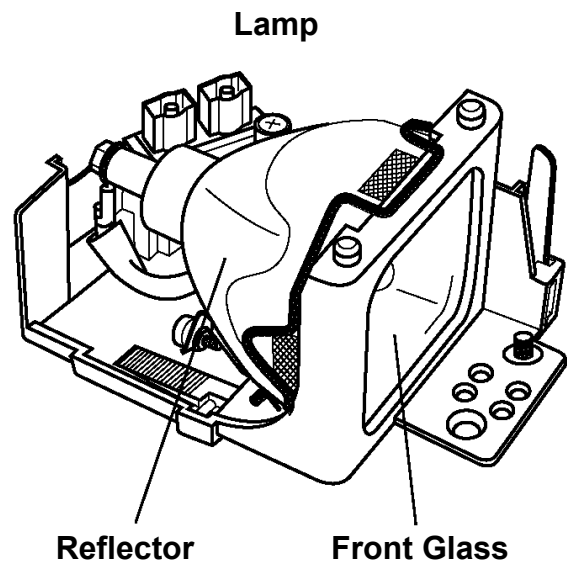

Lamp Life

Projector lamps have a finite life. The projected images will become darker and hues will become weaker after a lamp has been used for a long period of time.

The LAMP indicator also becomes red when the lamp unit reaches a high temperature. Before replacing the lamp, switch the POWER OFF, wait approximately 20 minutes, then switch the POWER ON again. If the LAMP indicator still displays red, replace the lamp.

Replacing the Lamp

All projector lamps will burn out eventually. If used for long periods of time, the image could become darkened, and the color and contrast could be impacted as well. We recommend that you replace your lamps early. If the LAMP indicator turns red, it is a caution signal that the lamp needs to be replaced.

NOTE:

The LAMP indicator is also red when the lamp unit reaches high temperature. Before replacing the lamp, switch power OFF, wait approximately 20 minutes, then switch the power ON again. If the LAMP indicator is still red, replace the lamp.

- 1 Switch the projector OFF, remove the power cord from the power outlet, then wait at least 45 minutes for the unit to cool.
- 2 Prepare a new lamp.
- 3 Check that the projector has cooled sufficiently, then gently turn it upside down.
- 4 Loosen the screw as shown in the diagram, then remove the lamp cover
- 6 Install the new lamp then tighten the two screws firmly. Also steadily push the opposite side of the screwed lamp assembly into the cavity.

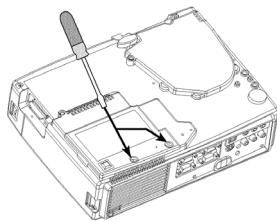

- 5 Loosen the two screws, then gently remove the lamp while holding the grips. Touching the inside of the lamp case cavity may result in uneven coloring.

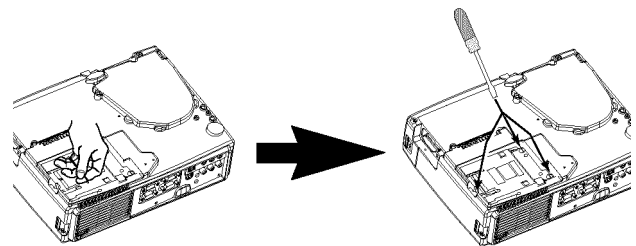
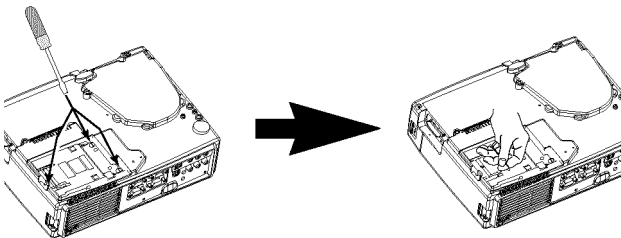

- 7 Replace the lamp cover in position then tighten the screw firmly.

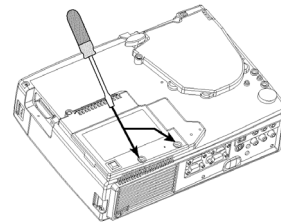

- 8 Gently turn the projector right-side up.

ATTENTION

- Ensure that the screws are screwed in firmly. Loose screws could result in damage or injury.
- Do not turn on with lamp cover removed.
- Do not reset the lamp timer without replacing the lamp. Always reset the lamp timer when the lamp is replaced.

Caring for the Air Filter

The air filter should be cleaned about every 100 hours. Clean the filter if the LAMP indicator and TEMP indicator blink red simultaneously, or if a message prompts you to clean the air filter when you turn on the unit, the filter needs to be cleaned. (Refer to “On-Screen Messages” in the Troubleshooting section.)

- 1 Turn off the projector, then unplug the power cord
- 2 To clean a reusable filter, carefully vacuum both sides of the filter area.

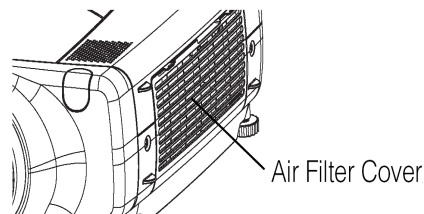

- 3 If the filter is damaged and needs to be replaced, contact your dealer or ViewSonic Corp. Replace the old filter then put the grill back in place.
- 4 To reset the Filter Timer, turn on the projector power, go to the Option menu then select filter timer. Reset the filter timer.

CAUTION:

- Switch power OFF and remove the power cord from the power outlet before beginning maintenance work.
- Replace the air filter if contamination cannot be removed or if it is damaged.
- Do not use the equipment with the air filter removed.
- When the air filter becomes clogged with dust etc., the power supply may switch OFF automatically to prevent the temperature from rising inside the projector.
- Make sure the lens is cool before cleaning.
- Do not use detergents or solvents such as benzene or thinners.
- Do not use chemical sprays.
- Use a soft cloth or lens paper only.

Caring for the Inside of the Projector

In order to ensure the safe use of your projector, please have it cleaned and inspected by an authorized Service Provider approximately once every 2 years. Never try to care for the inside of the unit yourself. Doing so is dangerous.

Caring for the Lens

Lightly wipe the lens with a commercially available lens-cleaning wipe. Do not touch the lens directly with your hand.

Caring for the Cabinet and Remote Control Transmitter

Wipe lightly with gauze or a soft cloth. If soiling is severe, dip a soft cloth in water or a neutral cleanser diluted in water, and wipe lightly after wringing well. Then, wipe lightly with a soft, dry cloth.

CAUTION:

- Make sure to turn off the power and unplug the power cord before caring for the unit. Please carefully read all the safety instructions in this manual, in order to care for your projector correctly.
- Do not use cleaners or chemicals other than those listed above, including benzene and paint thinner.
- Do not use aerosols or sprays.
- Do not polish or wipe with coarse material.
- Gently wipe with a soft cloth. If dirt and stains etc. are not easily removed, use a soft cloth dampened with water, or water and a neutral detergent, and wipe dry with a soft, dry cloth.

TROUBLESHOOTING

On-Screen Messages

When the unit's power is ON, messages such as those shown below may be displayed. When any such message is displayed on the screen, please respond as described below.

Message	Contents
CHANGE THE LAMP AFTER REPLACING LAMP, RESET THE LAMP TIME.	The unit does not display a warning message on the screen when the lamp expires or fails. When the lamp does not light, this indicates that the lamp is no longer functional and should be replaced. Replace the lamp and do not forget to reset the timer.
CLEAN THE AIR FILTER AFTER CLEANING AIR FILTER, RESET THE FILTER TIMER.	A note of precaution when cleaning the air filter. After cleaning the filter, operate FILTER TIME of the OPTION Menu, then perform reset of the filter timer.
NO INPUT IS DETECTED ON ***	There is no input signal. Check the signal input connection and the status of the signal source.
SYNC IS OUT OF RANGE ON ***	The horizontal or vertical frequencies of the inputted signal is outside of the operating range limits of this unit. Please confirm the specs for this unit or the signal source specs.
CHECK THE AIR FLOW	The internal temperature is rising. Please turn the power OFF, then allow the unit to cool down for approximately 20 minutes. After having confirmed the following items, then please reset the power to ON. <ul style="list-style-type: none">• Is there blockage of the air filter?• Is the air filter dirty?• Does the ambient temperature exceeds 35°C?

Problem Diagnostics

Before requesting repair, please check the following chart. If the situation cannot be corrected, then contact your dealer.

Phenomenon	Cases not involving a machine defect	Items to be confirmed
The power does not come ON.	The main power source is not ON.	Turn on the main power.
	The electrical power cord is not plugged in.	Correctly connect the power cord.
	The main power source has been interrupted during operation, such as by a power outage (blackout), etc.	Be sure to press the "O" (power OFF) side of the main power switch, and leave it OFF for approximately 20 minutes. After the unit has sufficiently cooled, turn ON the power source.
No sound or pictures are displayed	The input changeover settings are mismatched.	Select the input signal then correct the settings.
	The input changeover settings are mismatched.	Correctly re-connect the connection cord.
	No signal is being inputted.	Correctly re-connect the connection cord.
Pictures are displayed, but no sounds are heard	The electrical wiring to this unit is not correctly connected..	Correctly re-connect the connection cord.
	The volume setting has been set at (or adjusted to) an extremely low level.	Adjust the VOLUME setting to a higher level.
	Mute is turned on.	Press the MUTE button to toggle the MUTE mode setting.
Sounds are heard, but no pictures are displayed	The electrical wiring to this unit is not correctly connected.	Correctly re-connect the connection cord.
	The brightness setting has been set at (or adjusted to) an extremely low level.	Adjust the BRIGHT setting to a brighter level.
	The lens cap has not been removed.	Remove the lens cap.
Colors have a faded-out appearance. Color tone is poor	Color depth setting or color tone setting	Perform picture adjustments by changing the COLOR BAL R, the COLOR BAL B, and/or the TINT settings, etc.
Pictures appear dark	The brightness setting and/or contrast setting has not been properly adjusted.	Perform picture adjustments by changing the BRIGHT and/or CONTRAST settings, etc.
	The WHISPER mode is the current setting.	Toggle from the WHISPER mode.
	Lamp is approaching the end of its product lifetime.	Replace the Lamp Assembly.
Pictures appear blurry	Either the FOCUS setting or the H PHASE is not properly adjusted.	Adjust the focus and H PHASE settings.

NOTE:

When the interior becomes overheated, power to the unit automatically shuts down. Press the main switch on the side of the unit to the off position then wait 20 minutes to allow the unit to cool down before any work is done to the unit.

SPECIFICATIONS

Specifications are subject to change without notice.

Item	Specification										
Product Name	PJ751										
Liquid crystal projector	Panel size	2.3 cm (0.9 type)									
	Drive system	TFT active matrix									
	Pixels	786,432 pixels (1024 horizontal x 768 vertical)									
Lens	Zoom lens F = 1.7 ~ 2.1; f = 36.8 ~ 47.8 mm										
Lamp	200 W UHB										
Speaker	1.0 W + 1.0 W (stereo)										
Power supply	AC 100 ~ 120 V, 3.3 A / AC 220 ~ 240 V, 1.4 A										
Power consumption	310 W (typ.)										
Temperature range	0 ~ 35°C (32 ~ 95°F) (Operating)										
Size	298 (W) x 76 (H) x 228 (D) mm 11.7(W) x 3.73(H) x 9.00(D) inches										
Weight (mass)	3.25 kg (7.15lbs)										
Port	<table border="0"> <tr> <td>RGB port</td> <td>COMPONENT VIDEO</td> </tr> <tr> <td>RGB IN(1, 2)</td> <td>(Y, CB/PB,CR/PR)</td> </tr> <tr> <td>VIDEO port</td> <td></td> </tr> <tr> <td>VIDEO IN</td> <td></td> </tr> <tr> <td>S-VIDEO IN</td> <td>AUDIO port</td> </tr> </table>	RGB port	COMPONENT VIDEO	RGB IN(1, 2)	(Y, CB/PB,CR/PR)	VIDEO port		VIDEO IN		S-VIDEO IN	AUDIO port
RGB port	COMPONENT VIDEO										
RGB IN(1, 2)	(Y, CB/PB,CR/PR)										
VIDEO port											
VIDEO IN											
S-VIDEO IN	AUDIO port										
Optional parts	Lamp: PRJ-RLC-001 ViewSonic offers other accesories including items such as air filters, remote controls, ceiling mounting brackets, manuals, soft cases, etc. Please contact your dealer or ViewSonic for information.										

Outline Dimensions

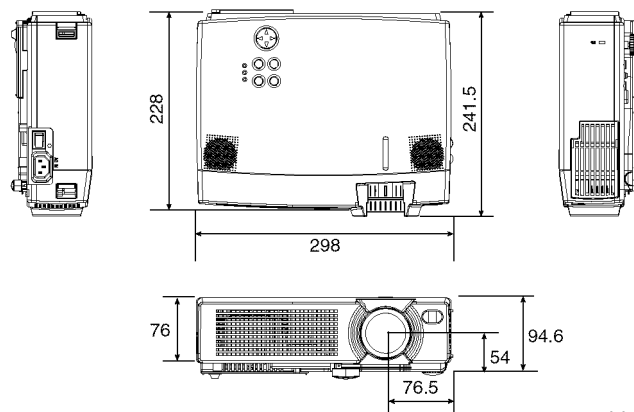

Customer Support

For technical support or product service, see the table below or contact your reseller.

When calling ViewSonic Customer Support please have the product's model name and serial number on hand.

Country/Region	Web site	T = Telephone F = FAX	Email
United States	viewsonic.com/support	T: (800) 688-6688 F: (909) 468-1202	service.us@viewsonic.com
Canada	viewsonic.com/support	T: (800) 688-6688 F: (909) 468-1202	service.ca@viewsonic.com
United Kingdom	viewsoniceurope.com	T: 0800 833 648 F: (01293) 643910	service.eu@viewsoniceurope.com
Europe, Middle East, Baltic countries, and North Africa	viewsoniceurope.com	Contact your reseller	service.eu@viewsoniceurope.com
Australia and New Zealand	viewsonic.com.au	T: +61 2 9929 3955 F: +61 2 9929 8393	service.au@viewsonic.com
Singapore/India and South-east Asia	viewsonic.com.sg	T: 65 273 4018 F: 65 273 1566	service.sg@viewsonic.com
Other Asia/Pacific countries	viewsonic.com.tw	T: 886 2 2246 3456 F: 886 2 8242 3668	service.ap@viewsonic.com
South Africa	viewsonic.com/asia	T: 886 2 2246 3456 F: 886 2 8242 3668	service.ap@viewsonic.com

LIMITED WARRANTY

ViewSonic Projector

What the warranty covers:

ViewSonic® warrants its products to be free from defects in material and workmanship during the warranty period. If a product proves to be defective in material or workmanship during the warranty period, ViewSonic will at its sole option repair or replace the product with a like product. Replacement product or parts may include remanufactured or refurbished parts or components.

How long the warranty is effective:

ViewSonic projectors are warranted for two (2) years for all parts excluding the lamp, two (2) years for all labor, and ninety (90) days for the lamp from the date of the first consumer purchase.

Who the warranty protects:

This warranty is valid only for the first consumer purchaser.

What the warranty does not cover:

- Any product on which the serial number has been defaced, modified or removed.
- Damage, deterioration or malfunction resulting from:
 - Accident, misuse, neglect, fire, water, lightning, or other acts of nature, unauthorized product modification, or failure to follow instructions supplied with the product.
 - Repair or attempted repair by anyone not authorized by ViewSonic.
- Any damage of the product due to shipment.
- Removal or installation of the product.
- Causes external to the product, such as electric power fluctuations or failure.
- Use of supplies or parts not meeting ViewSonic's specifications.
- Normal wear and tear.
- Any other cause which does not relate to a product defect.
- Removal, installation, and set-up service charges.

How to get service:

For information about receiving service under warranty, contact ViewSonic Customer Support. You will need to provide your product's serial number.

To obtain warranted service, you will be required to provide (a) the original dated sales slip, (b) your name, (c) your address, (d) a description of the problem, and (e) the serial number of the product.

Take or ship the product freight prepaid in the original container to an authorized ViewSonic service center or ViewSonic.

For additional information or the name of the nearest ViewSonic service center, contact ViewSonic.

Limitation of implied warranties:

THERE ARE NO WARRANTIES, EXPRESS OR IMPLIED, WHICH EXTEND BEYOND THE DESCRIPTION CONTAINED HEREIN INCLUDING THE IMPLIED WARRANTY OF MERCHANTABILITY AND FITNESS FOR A PARTICULAR PURPOSE.

Exclusion of damages:

VIEWSONIC'S LIABILITY IS LIMITED TO THE COST OF REPAIR OR REPLACEMENT OF THE PRODUCT. VIEWSONIC SHALL NOT BE LIABLE FOR:

DAMAGE TO OTHER PROPERTY CAUSED BY ANY DEFECTS IN THE PRODUCT, DAMAGES BASED UPON INCONVENIENCE, LOSS OF USE OF THE PRODUCT, LOSS OF TIME, LOSS OF PROFITS, LOSS OF BUSINESS OPPORTUNITY, LOSS OF GOODWILL, INTERFERENCE WITH BUSINESS RELATIONSHIPS, OR OTHER COMMERCIAL LOSS, EVEN IF ADVISED OF THE POSSIBILITY OF SUCH DAMAGES.

ANY OTHER DAMAGES, WHETHER INCIDENTAL, CONSEQUENTIAL OR OTHERWISE.

ANY CLAIM AGAINST THE CUSTOMER BY ANY OTHER PARTY.

Effect of state law:

This warranty gives you specific legal rights, and you may also have other rights which vary from state to state. Some states do not allow limitations on implied warranties and/or do not allow the exclusion of incidental or consequential damages, so the above limitations and exclusions may not apply to you.

Sales outside the U.S.A. and Canada:

For warranty information and service on ViewSonic products sold outside of the U.S.A. and Canada, contact ViewSonic or your local ViewSonic dealer.

Projector Warranty (V2.1) Release Date: 04-18-2001

APPENDIX

Power Cord Safety Guidelines

Use a power cable that is properly grounded. Always use an AC power cord that meets your country's safety standard.

USA	UL	Switzerland	SEV
Canada	CSA	Britain	BASE/BS
Germany	VDE	Japan	Electric Appliance Control Act

AC PLUG CORD PRECAUTIONS FOR THE UNITED KINGDOM

FOR YOUR SAFETY PLEASE READ THE FOLLOWING TEXT CAREFULLY.

IF THE FITTED MOULDED PLUG IS UNSUITABLE FOR THE SOCKET OUTLET THEN THE PLUG SHOULD BE CUT OFF AND DISPOSED OF SAFELY.

THERE IS A DANGER OF SEVERE ELECTRICAL SHOCK IF THE CUT OFF PLUG IS INSERTED INTO AN APPROPRIATE SOCKET.

If a new plug is to be fitted, please observe the wiring code as shown below.

If in any doubt, please consult a qualified electrician.

WARNING: THIS APPLIANCE MUST BE EARTHED.

IMPORTANT: The wires in this mains lead are coloured in accordance with the following code:

Green-and-Yellow:	Earth
Blue:	Neutral
Brown:	Live

If the coloured wires of the mains lead of this appliance do not correspond with the coloured markings identifying the terminals in your plug, proceed as follows:

The wire which is coloured GREEN-AND-YELLOW must be connected to the terminal in the plug which is marked by the letter E or by the Earth symbol or coloured GREEN or GREEN-AND-YELLOW.

The wire which is coloured BLUE must be connected to the terminal in the plug which is marked with the letter N or coloured BLACK. The wire which is coloured BROWN must be connected to the terminal in the plug which is marked with the letter L or coloured RED.

IMPORTANT NOTICE CONCERNING POWER CORD SELECTION

The power cord set for this unit has been enclosed and has been selected according to the country of destination and must be used to prevent electric shock. Use the following guidelines if it is necessary to replace the original cord set, or if the cord set is not enclosed.

The female receptacle of the cord set must meet CEE-22 requirements and may look like (Figure A1 below):

Figure A1 

For the United States and Canada

In the United States and Canada the male plug is a NEMA5-15 style (Figure A2), UL Listed, and CSA Labeled. For units which are mounted on a desk or table, type SVT or SJT cord sets may be used. For units which sit on the floor, only SJT type cord sets may be used. The cord set must be

selected according to the current rating for your unit. Please consult the table below for the selection criteria for power cords used in the United States and Canada.



For customers in Canada:

Notice: This Class B digital apparatus complies with Canadian ICES-003.

Cord Type	Size of Conductors in Cord	Maximum Current Rating of Unit
SJT	18 AWG	10 Amps
	16 AWG	12 Amps
	14 AWG	12 Amps
SVT	18 AWG	10 Amps
	17 AWG	12 Amps

For European Countries

In Europe you must use a cord set which is appropriate for the receptacles in your country. The cord set is HAR-Certified, and a special mark that will appear on the outer sheath, or on the insulation of one of the inner conductors. If you have any questions concerning which proper power cord to use, please consult with the dealer from whom you have purchased the product.

Compliance Information for U.S.A.

This equipment has been tested and found to comply with the limits for a Class B digital device, pursuant to part 15 of the FCC Rules. These limits are designed to provide reasonable protection against harmful interference in a residential installation. This equipment generates, uses, and can radiate radio frequency energy, and if not installed and used in accordance with the instructions, may cause harmful interference to radio communications. However, there is no guarantee that interference will not occur in a particular installation. If this equipment does cause harmful interference to radio or television reception, which can be determined by turning the equipment off and on, the user is encouraged to try to correct the interference by one or more of the following measures:

Reorient or relocate the receiving antenna.

Increase the separation between the equipment and receiver.

Connect the equipment into an outlet on a circuit different from that to which the receiver is connected.

Consult the dealer or an experienced radio/TV technician for help.

FCC Warning

To assure continued FCC compliance, the user must use grounded power supply cord and the provided shielded video interface cable with bonded ferrite cores. If a BNC cable is going to be used, use only a shielded BNC(5) cable. Also, any unauthorized changes or modifications not expressly approved by the party responsible for compliance could void the user's authority to operate this device.

Instructions to Users

This equipment complies with the requirements of FCC (Federal Communication Commission) equipment provided that the following condition is met. Use the cables which are included with the projector or specified.

Compliance Information for Canada

Notice: This class B digital apparatus complies with Canadian ICES-003.

AVIS: Cet appareil numérique de la Classe B conforme a la norme NMB-003 du Canada.

Compliance Information for European Countries

CE Conformity



The device complies with the requirements of the EEC directive 89/336/EEC as amended by 92/31/EEC and 93/68/EEC Art.5 with regard to "Electromagnetic compatibility," and 73/23/EEC as amended by 93/68/EEC Art.13 with regard to "Safety."

User Information for All Countries

NOTICE: Use the cables which are included with the projector or specified.

ViewSonic Corporation