

myprojectorlamps.com

**The most trusted, dependable name
in projector lamp sales.**



<http://www.myprojectorlamps.com>



<http://www.myprojectorlamps.ca>



<http://www.myprojectorlamps.eu>

The following projector manual has not been modified or altered in any way.

ViewSonic®

PJ510

User Guide

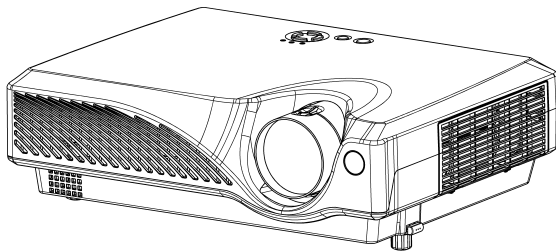

Contents

For Your Records	1
Features	2
Projector Features	2
Part Names	3
The Projector	3
The Remote Control	5
Setting Up	6
Arrangement	6
Adjusting The Projector's Elevator	7
Connecting Your Devices	8
Connecting Power Supply	10
Remote Control	11
Putting Batteries	11
Operating The Remote Control	12
Power ON/OFF	13
Turning On The Power	13
Selecting An Input Signal	14
Turning Off The Power	15
Operating	16
Adjusting The Volume	16
Temporarily Muting The Sound	16
Adjusting The Position	17
Using The Automatic Adjustment Feature	18
Correcting Keystone Distortions	18
Using The Magnify Feature	19
Freezing The Screen	19
Signal Searching	20
Selecting The Aspect Ratio	20
Temporarily Blanking The Screen	20
Multifunctional Settings	21
Using The Menu Functions	21
MAIN Menu	22
PICTURE-1 Menu	23
PICTURE-2 Menu	24
INPUT Menu	25
AUTO Menu	27
SCREEN Menu	28

OPTION Menu	29
Lamp	30
Replacing The Lamp	31
Air Filter	32
Caring For The Air Filter	32
Replacing The Air Filter	33
Other Care	34
Caring For The Inside Of The Projector	34
Caring For The Lens	34
Caring For The Cabinet And Remote Control	34
Troubleshooting	35
Related Messages	35
Regarding The Indicator Lamps	37
Phenomena That May Easily Be Mistaken For Machine Defects	39
Warranty And After-Service	40
Specifications	41
Customer Support	42
LIMITED WARRANTY	43
VIEWSONIC Projector	43
Appendix	44
Power Cord Safety Guidelines	44
Compliance Information for U.S.A.	45
Compliance Information for Canada	45
Compliance Information for European Countries	45
User Information for all Countries	45

Copyright © ViewSonic Corporation, 2003. All rights reserved.

Apple, Mac and ADB registered trademarks of Apple Computer, Inc.

Microsoft, Windows, Windows NT, and the Windows logo are registered trademarks of Microsoft Corporation in the United States and other countries.

ViewSonic, the three birds logo A-CD-PJ510 and OnView are registered trademarks of ViewSonic Corporation.

VESA and SVGA are registered trademarks of the Video Electronics Standards Association.

DPMS and DDC are trademarks of VESA.

PS/2, VGA and XGA are registered trademarks of International Business Machines Corporation.

Disclaimer: ViewSonic Corporation shall not be liable for technical or editorial errors or omissions contained herein; nor for incidental or consequential damages resulting from furnishing this material, or the performance or use of this product.

In the interest of continuing product improvement, ViewSonic Corporation reserves the right to change product specifications without notice. Information in this document may change without notice.

No part of this document may be copied, reproduced, or transmitted by any means, for any purpose without prior written permission from ViewSonic Corporation.

Electronic Warranty Registration

To meet your future needs, and to receive any additional product information as it becomes available, please register your projector's warranty on the Internet at: <http://www.viewsonic.com>

For Your Records

Product Name:	ViewSonic PJ510
Model Number:	VPROJ27995-1W
Document Number:	A-CD-PJ510-1-UG
Serial Number:	_____
Purchase Date:	_____

Features

Projector Features

This multimedia projector is used to project various computer signals as well as NTSC/PAL/SECAM video signals onto a screen. Little space is required for installation and large images can easily be realized.

Ultra High Brightness

Crisp, ultra-bright presentations is achieved by using a UHB (ultra high brightness) lamp and highly efficient optical system.

Partial Magnification Function

Interesting parts of images can be magnified for closer viewing.

Keystone Distortion Correction

Quick correction of distorted images electrically.

Whisper Mode Equipped

Special mode is available for reducing projector noise to achieve quieter operation.

NOTE:

Keep the original packing material for future reshipment.

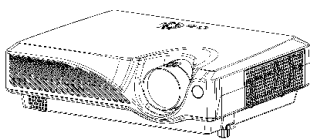

Projector
with Lens Cap

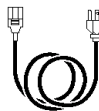

Power Cord

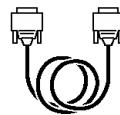

RGB Cable

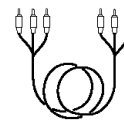

Video/Audio
cable

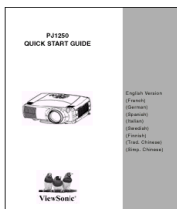

Quick Start Guide



ViewSonic
Wizard CD

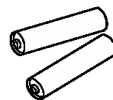

Two AA batteries
(for the remote control)



Remote Control



Soft case

NOTE:

Applicable power cord is shipped with the projector to the point of destination.

To avoid penetration of foreign objects, do not put the projector in a case or a bag together with any things except the accessories of the projector, signal cables and connectors.

WARNING:

Before using this equipment, read this manual thoroughly. Always ensure that the equipment is used safely.

Part Names

The Projector

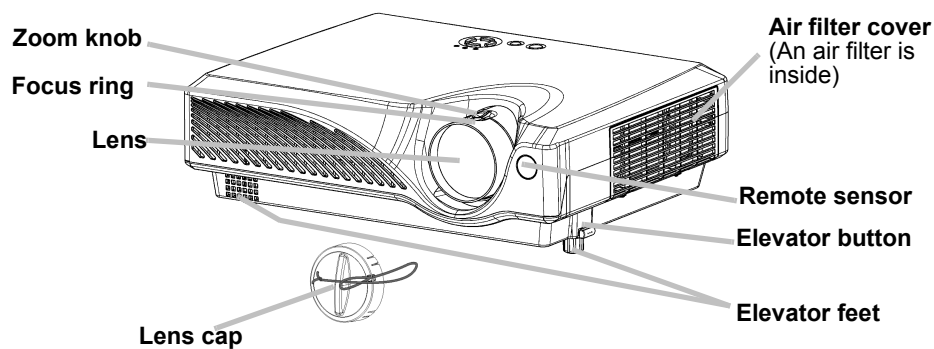

Projector (Front/Right)

Fastening The Lens Cap

To avoid losing, please fasten the lens cap to the projector using the strap.

- 1 Fix the strap to the strap ring of lens cap, as the right drawing.

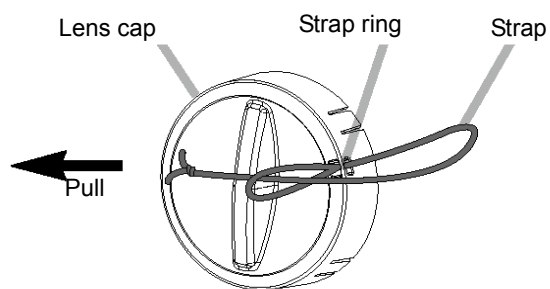

- 2 Put one piece of the strap into the groove on rivet, as the right drawing.

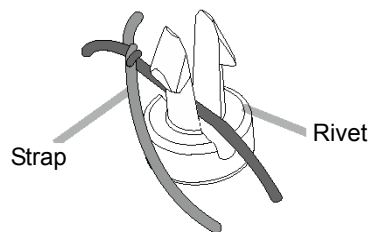

- 3 Push the rivet into the strap hole.

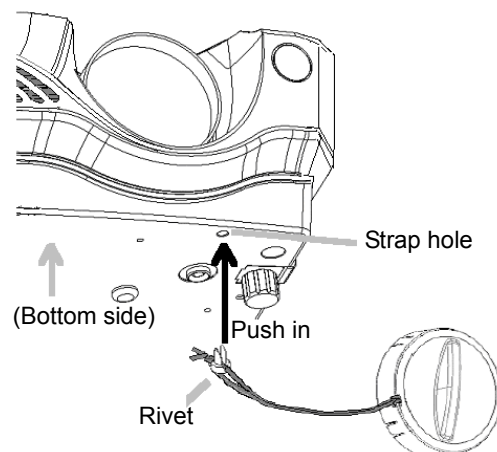

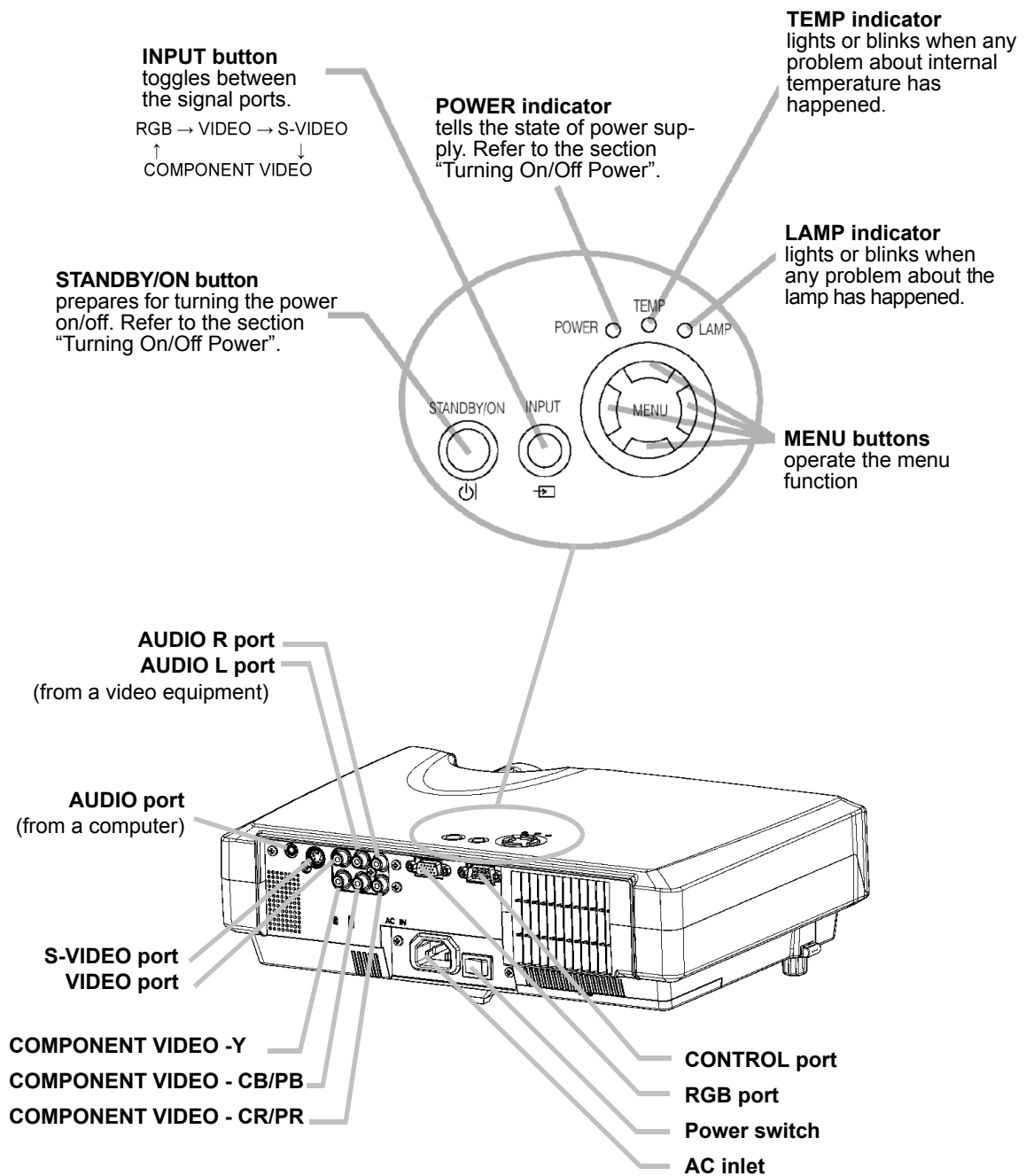

Projector (Rear/Left)

The Remote Control

RGB button

selects the input signal of RGB port.

VIDEO button

toggles between the signal ports of VIDEO, S-VIDEO and COMPONENT VIDEO.

ASPECT button

toggles between the modes for aspect ratio.

MAGNIFY ON/OFF buttons

turns on/off the MAGNIFY mode. In the MAGNIFY mode,

To move the magnified area,

(1) Press the POSITION button.

(2) Use the cursor buttons to move the picture.

(3) Press the POSITION button again to finish.

To shift the magnify level, use the cursor (▲)/(▼) buttons.

FREEZE button

freezes/reactivates the picture.

POSITION button

turns on/off the POSITION mode.

In the POSITION mode,

To move the picture, use the cursor buttons.

ESC button

returns to the previous display at the menu functions.

SEARCH button

searches for an input signal between the following signal ports of RGB, VIDEO, S-VIDEO and COMPONENT VIDEO.

AUTO button

executes automatic adjustment

(STANDBY/ON) button

prepares for turning the power on/off.

BLANK button

blanks the screen temporarily.

VOLUME button

turns on/off the VOLUME mode.

In the VOLUME mode,
To adjust the volume, use the cursor (▲)/(▼) buttons.

MUTE button

mutes/restores the sound.

KEYSTONE button

turns on/off the KEYSTONE mode.

In the KEYSTONE mode,
To adjust the keystone, use the cursor (▲)/(▼) buttons.

MENU button

opens/closes the menu.

RESET button

cancels the adjustment in progress.

• The adjustments of the volume etc. are not reset.

ENTER button

proceeds to the next operation at the menu functions.

(▲),(▼),(▶),(◀)
(Cursor) buttons
works for adjusting or menu controlling.



Setting Up

Arrangement

WARNING

- Install the projector in a suitable environment according to instructions of the “PJ510 QUICK START GUIDE” and this manual.
- The power outlet should be close to the projector and easily accessible.

Refer to the illustrations and tables below to determine the screen size and projection distance.

The values shown in the table are calculated for a full size screen: 800x600

a Distance from the projector to the screen ($\pm 10\%$)

b Distance from the lens center to the bottom of the screen ($\pm 10\%$)

c Distance from the lens center to the top of the screen ($\pm 10\%$)

Reference for the 4:3 aspect ratio

Screen Size Inches (m)	a Inches (m)		b Inches (cm)	C Inches (cm)
	Minimum	Maximum		
30 (0.8)	35(0.9)	42(1.1)	2(5)	16(41)
40 (1.0)	47(1.2)	56(1.4)	2(6)	22(55)
50 (1.3)	59(1.5)	71(1.8)	3(8)	27(69)
60 (1.5)	71(1.8)	85(2.2)	4(9)	32(82)
70 (1.8)	83(2.1)	99(2.5)	4(11)	38(96)
80 (2.0)	95(2.4)	114(2.9)	5(12)	43(110)
90 (2.3)	107(2.7)	128(3.3)	5(14)	49(123)
100 (2.5)	119(3.0)	143(3.6)	6(15)	54(137)
120 (3.0)	143(3.6)	171(4.4)	7(18)	65(165)
150 (3.8)	179(4.6)	215(5.5)	9(23)	81(206)
200 (5.0)	240(6.1)	287(7.3)	12(30)	108(274)
250 (6.3)	300(7.6)	359(9.1)	15(38)	135(343)
300 (7.5)	360(9.2)	431(10.9)	18(46)	162(411)

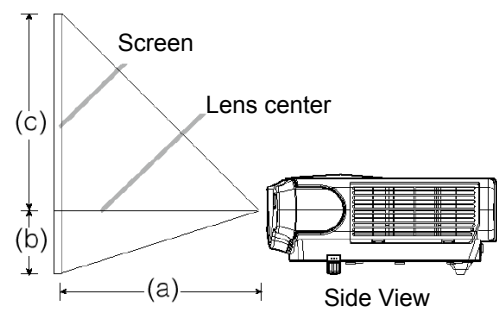

Reference for the 16:9 aspect ratio

Screen Size Inches (m)	a Inches (m)		b Inches (cm)	C Inches (cm)
	Minimum	Maximum		
30 (0.8)	38(1.0)	46(1.2)	0(1)	15(39)
40 (1.0)	51(1.3)	61(1.6)	1(2)	20(51)
50 (1.3)	64(1.6)	77(2.0)	1(2)	25(64)
60 (1.5)	77(2.0)	93(2.4)	1(2)	30(77)
70 (1.8)	90(2.3)	108(2.8)	1(3)	35(90)
80 (2.0)	104(2.6)	124(3.2)	1(3)	41(103)
90 (2.3)	117(3.0)	140(3.6)	1(4)	46(116)
100 (2.5)	130(3.3)	155(3.9)	2(4)	51(129)
120 (3.0)	156(4.0)	187(4.7)	2(5)	61(154)
150 (3.8)	196(5.0)	234(5.9)	2(6)	76(193)
200 (5.0)	216(6.6)	312(7.9)	3(8)	101(257)
250 (6.3)	327(8.3)	391(9.9)	4(10)	127(322)
300 (7.5)	393(10.0)	469(11.9)	5(12)	152(386)

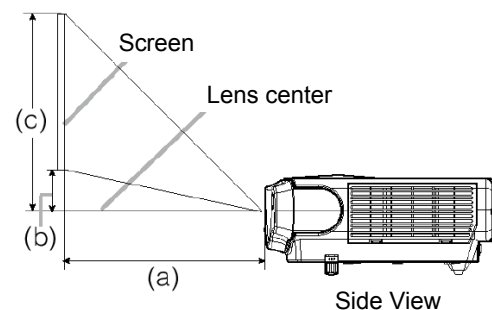

Adjusting The Projector's Elevator



CAUTION

If you press the elevator buttons without holding the projector, the projector might crash down, overturn, smash your fingers and possibly result in malfunction. To prevent damaging the projector and injuring yourself, ALWAYS HOLD THE PROJECTOR whenever using the elevator buttons to adjust the elevator feet.

You can use the elevator feet to make adjustments if the surface on which you need to set the projector is uneven or if you otherwise need to adjust the angle of projection. The adjustment range of the elevator feet is 0 to 9 degrees.

1 Press and hold in the elevator buttons.

2 **Raise or lower the projector to the desired height and then release the elevator buttons.** When you release the elevator buttons, the elevator feet will lock position.

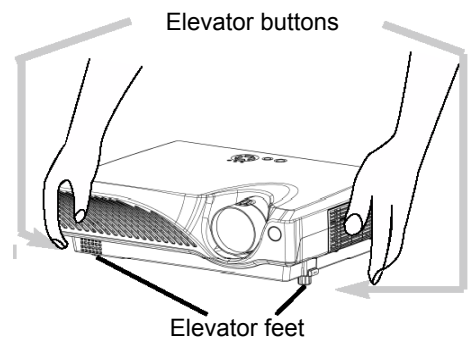

3 As necessary, you can also adjust the height of the projector by twisting the elevator feet by hand.

Connecting Your Devices



WARNING

Incorrect connecting could result in fire or electrical shock. Whenever attempting to connect other devices to the projector, please thoroughly read the "PJ510 QUICK START GUIDE", this manual and the manual of each device to be connected.



CAUTION

TURN OFF ALL DEVICES prior to connecting them to the projector. Attempting to connect a live device to the projector may generate extremely loud noises or other abnormalities that may result in malfunction and/or damage to the device and/or projector.



ATTENTION

- Make sure that you connect devices to the correct port. Incorrect connection may result in malfunction and/or damage to the device and/or projector. Refer to the section "Technical" of this manual for the pin assignment of connectors and RS-232C communication data.
- Some cables have to be used with core set. Use the accessory cable or a designated-type cable for the connection. For cables that have a core only at one end, connect the core to the projector.
- Secure the screws on the connectors and tighten.
- Whenever attempting to connect a laptop computer to the projector, be sure to activate the laptop's RGB external image output (set the laptop to CRT display or to simultaneous LCD and CRT display). For details on how this is done, please refer to the instruction manual of the corresponding laptop computer.

NOTE:

About Plug-and-Play Capability

- This projector is compatible with VESA DDC 1/2B. Plug-and-Play can be achieved by connecting this projector to computers that are VESA DDC (display data channel) compatible. Please take advantage of this function by connecting the accessory RGB cable to the RGB port (DDC 1/2B compatible). Plug-and-Play may not work properly if any other type of connection is attempted.
- Plug-and-Play is a system composed of the computer, its operating system and peripheral equipment (i.e. display devices).
- Please use the standard drivers in your computer, as this projector is a Plug-and-Play monitor.

NOTE:

- Some computers may have multiple display screen modes. Use of some of these modes will not be possible with this projector.
- For some RGB input modes, the optional Mac adapter is necessary.

Please refer to the following for connecting your devices.
See the rear of the projector. You can see the ports.

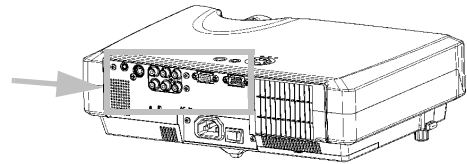

Connecting to a computer

- RGB out ← **RGB cable (D-sub 15 pin)** → ①
- Audio out ← **Audio cable (Stereo mini)** → ②
- RS-232C port ← **RS-232C Cable** → ③

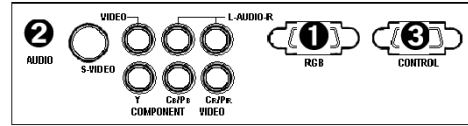

If using a SCART RGB input,

- Video → SCART out port ← **SCART cable** → ④
- Audio out (L) → SCART out port ← **SCART cable** → ⑤
- Audio out (R) → SCART out port ← **SCART cable** → ⑥
- G out → SCART out port ← **SCART cable** → ⑦
- B out → SCART out port ← **SCART cable** → ⑧
- R out → SCART out port ← **SCART cable** → ⑨
- RS-232C port ← **RS-232C Cable** → ③

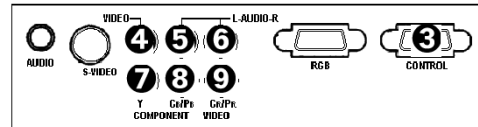

Connecting to a DVD/VCR player

- Video out ← **Audio/Video Cable** → ④
- Audio out (L) ← **Audio/Video Cable** → ⑤
- Audio out (R) ← **Audio/Video Cable** → ⑥

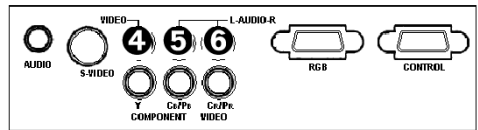

If using a S-video input,

- S-video out port ← **S-video cable** → ⑩
- Audio out (L) ← **Audio cable** → ⑤
- Audio out (R) ← **Audio cable** → ⑥

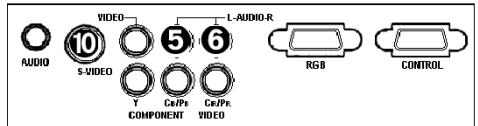

If using a component input,

- Component (Y) out ← **Component cable** → ⑦
- Component (C_B/P_B) out ← **Component cable** → ⑧
- Component (C_R/P_R) out ← **Component cable** → ⑨
- Audio out (L) ← **Audio cable** → ⑤
- Audio out (R) ← **Audio cable** → ⑥

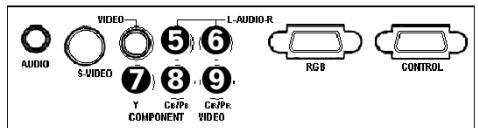

If using a component input from RGB port,

- Component (Y) out ← **Component cable (with D-sub 15 pin)** → ①
- Component (C_B/P_B) out ← **Component cable (with D-sub 15 pin)** → ①
- Component (C_R/P_R) out ← **Component cable (with D-sub 15 pin)** → ①
- Audio out ← **Audio cable (Stereo mini)** → ②

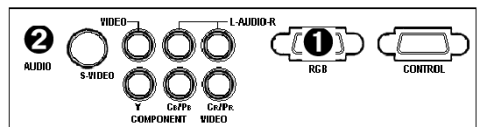

Connecting Power Supply

WARNING

- Please use extra caution when connecting the power cord as incorrect or faulty connections may result in FIRE and/or ELECTRICAL SHOCK. Please adhere to the “PJ510 UG – Safety Guide” and the following.
- Only plug the power cord into outlets rated for use with the power cord’s specified voltage range.
- Only use the power cord that came with the projector. If it is damaged, contact your dealer to newly get correct one.
- Never modify the power cord. Never attempt to defeat the ground connection of the three-pronged plug.
- Make sure that you firmly connect the power cord to the projector and wall outlet.

1 Connect the connector of the power cord to the AC inlet of the projector.

2 Firmly plug the power cord’s plug into the outlet.

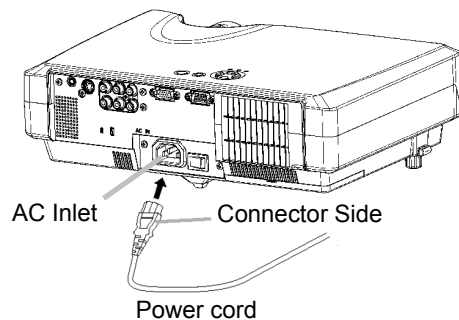

Remote Control

Putting Batteries



CAUTION

Always handle the batteries with care and use them only as directed. Improper use may result in battery cracking or leakage, which could result in fire, injury and/or pollution of the surrounding environment.

- Keep the battery away from children and pets.
- Be sure to use only the batteries specified for use with the remote control. Do not mix new batteries with used ones.
- When inserting batteries, verify that the plus and minus terminals are aligned correctly (as indicated in the remote control).
- When you dispose the battery, you should obey the law in the relative area or country.

1 Remove the battery cover.

Slide back and remove the cover in the direction of the arrow.

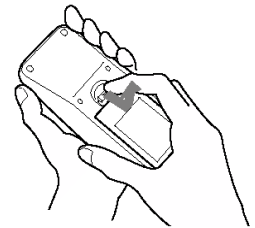

2 Insert the batteries.

Align and insert the two AA batteries according to their plus and minus terminals (as indicated in the remote control).

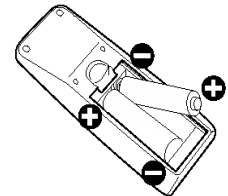

3 Close the battery cover.

Replace the cover in the direction of the arrow and snap it back into place.

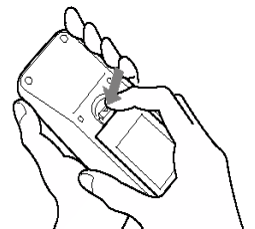

Operating The Remote Control



ATTENTION

- Do not drop or otherwise expose the remote control to physical impact.
- Do not get the remote control wet or place it on wet objects. Doing so may result in malfunction.
- Remove the batteries from the remote control and store them in a safe place if you won't be using the remote control for an extended period.
- Replace the batteries whenever the remote control starts to malfunction.
- When strong lights, such as direct sunlight or light from an extremely close range (such as from an inverter fluorescent lamp), hit the projector's remote sensor, the remote control may cause to function. Adjust the direction of the projector to keep light from directly hitting the projector's remote sensor.

- The remote control works with the projector's remote sensor.
- The range of the remote sensor is 3 meters with a 60-degree range (30 degrees to the left and right of the remote sensor). Also a remote signal reflected in the screen etc. may be available. If it is difficult to send a remote signal to the sensor directly, please try.
- Since the remote control uses infrared light to send signals to the projector (Class1 LED), be sure to use the remote control in an area free from obstacles that could block the remote control's output signal to the projector.

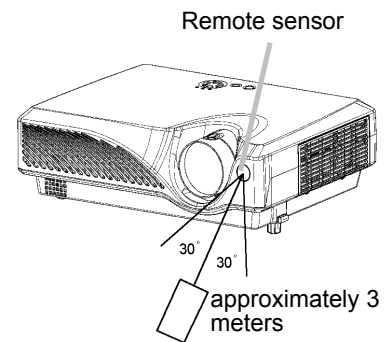

Power ON/OFF

Turning On The Power



WARNING

When the power is ON, a strong light is emitted. Do not look into the lens or vents of the projector.

NOTE:

Turn the power on/off in right order. Please power on the projector before the connected devices. Power off the projector after the connected devices.

- 1 Make sure that the power cord is firmly and correctly connected to the projector and outlet.
- 2 When the lens cap is attached, remove the lens cap.
- 3 Set the power switch to [|] (ON).



Power switch (ON position)
The POWER indicator will light orange.

- 4 Press the STANDBY/ON button of the projector or the remote control.
The projector lamp will light up and the POWER indicator will begin blinking green.
According to a setup, the projector lamp may light up and the POWER indicator may begin blinking green, without pressing this button.
When the power is completely on, the indicator will stop blinking and light green.

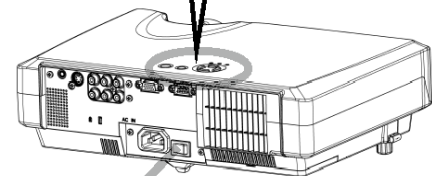
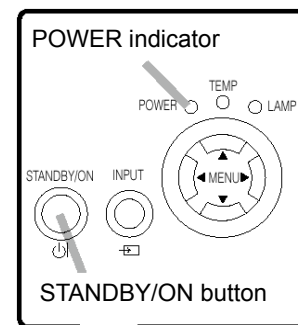

Power switch

 STANDBY/ON button

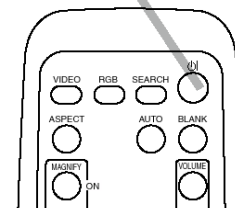

Selecting An Input Signal

1 Using the projector's control button

Press the INPUT button.

As illustrated below, each time you press the INPUT button, the projector switches between its input signal ports. Select the signal you wish to project.

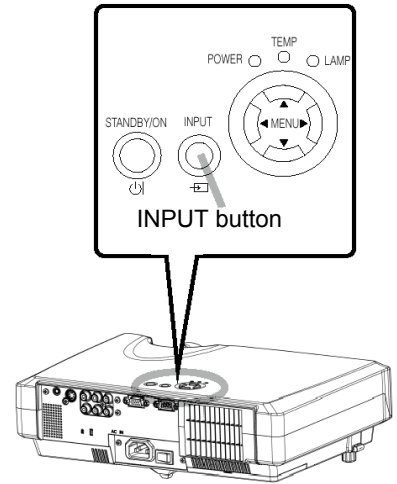

Selecting a RGB signal, using the remote control

Press the RGB button.

When this button is pressed, the projector switches to the RGB port.

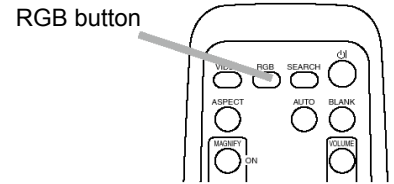

Selecting a video signal, using the remote control

Press the VIDEO button.

As illustrated below, each time you press the VIDEO button, the projector switches between its input signal ports. Select the signal you wish to project.

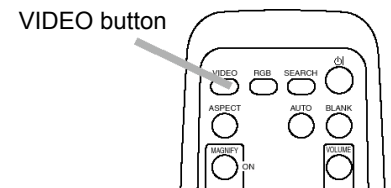
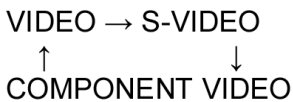

2 Use the zoom ring to adjust the screen size.

Zoom knob

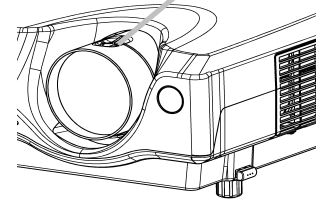

3 Use the focus ring to focus the picture.

Focus ring

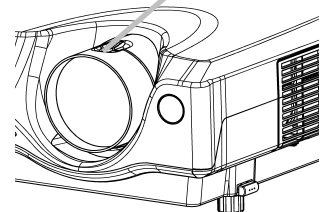

Turning Off The Power

NOTE:

Turn the power on/off in right order. Please power on the projector before the connected devices. Power off the projector after the connected devices.

- 1 Press the STANDBY/ON button of the projector or the remote control.
The message “Power off?” will appear on the screen for approximately 5 seconds.
- 2 Press the STANDBY/ON button again while “Power off?” the message is visible.
The projector lamp will go off, and the POWER indicator will begin blinking orange.
Then the POWER indicator will stop blinking and light to solid orange when the lamp cooling is complete.
- 3 Switch the power switch to [O] (OFF).
 Power switch (ON position)
The POWER indicator will go off.

- 4 Attach the lens cap.

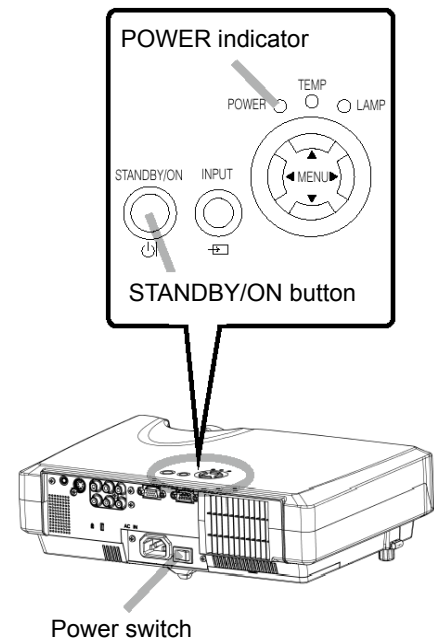

 STANDBY/ON button

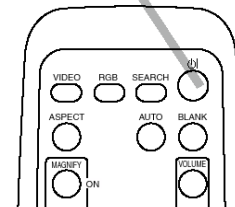

Operating

Adjusting The Volume

- 1 Press the VOLUME button.

As illustrated on the right, a dialog box will appear on the screen to aid you in adjusting the volume.

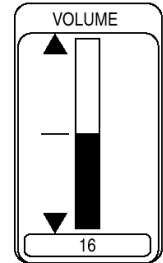

- 2 Use the (▲), (▼) buttons to adjust the volume. Press the VOLUME button again to close the dialog box and complete this operation.

(Even if you don't do anything, the dialog box will automatically disappear after a few seconds.)

(▲) Press this to increase the volume

(▼) Press this to decrease the volume

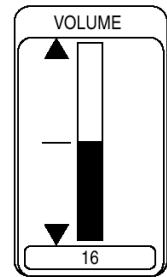
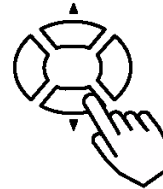

Temporarily Muting The Sound

- 1 Press the MUTE button.

As illustrated on the right, a dialog box will appear on the screen indicating that you have muted the sound. Press the VOLUME button to close the dialog box.

(Even if you don't do anything, the dialog box will automatically disappear after a few seconds.)

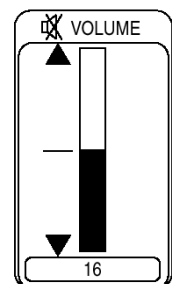
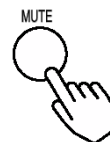

Adjusting The Position

- 1 Press the POSITION button.

As illustrated on the right, a dialog box will appear on the screen to aid you in adjusting the position.

POSITION



- 2 Use the (◀), (▶), (▲), (▼) buttons to adjust the position.

When you want to initialize the position, press the RESET button during adjustment.

Press the POSITION button again to close the dialog box and complete this operation. (Even if you don't do anything, the dialog box will automatically disappear after a few seconds.)

This function is only available for RGB input.

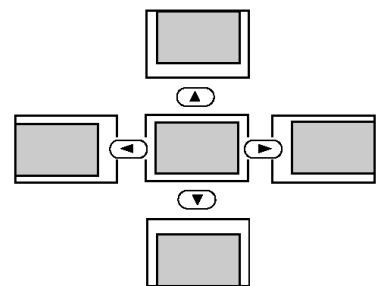
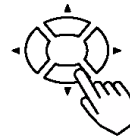

NOTE:

Position adjustment applies to OSD menu and not the position of the picture.

Using The Automatic Adjustment Feature

- 1 Press the AUTO button.

Automatic Adjustment for RGB Input

Horizontal position (H.POSIT), vertical position (V.POSIT), clock phase (H.PHASE) and horizontal size (H.SIZE) are automatically adjusted.



Make sure that the application window is set to its maximum size prior to attempting to use this feature. Dark pictures may still be incorrectly adjusted. Use a bright screen when adjusting.

Automatic Adjustment for Video Input

The signal type best suited for the respective input signal is selected automatically.

This feature is available only if VIDEO is set to AUTO in the INPUT menu.

NOTE:

The automatic adjustment operation requires approximately 10 seconds. Also, please note that it may not function correctly with some input.

Correcting Keystone Distortions

- 1 Press the KEYSTONE button.

As illustrated on the right, a dialog will appear on the screen to aid you in correcting the distortion.

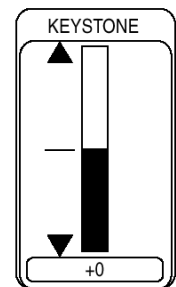

- 2 Use the (▲), (▼) buttons to correct distortion

Press the KEYSTONE button again to close the dialog and complete this operation. (Even if you don't do anything, the dialog will automatically disappear after a few seconds.)

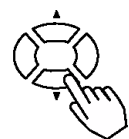

NOTE:

- When the WIDE is selected under the ASPECT item of the MAIN menu, this adjustment is ignored.
- The correcting keystone distortions function may not work with some types of input signals.
- The adjustable range for correcting keystone distortion will vary under all input signals.

Using The Magnify Feature

- 1 Press the MAGNIFY (ON) button
The projector enters MAGNIFY mode.



- 2 Press the POSITION button, then use the (◀), (▶), (▲), (▼) buttons to select the area to zoom.
Press the POSITION button again to finalize the zoom area.

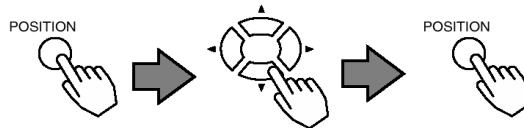

- 3 Use the (▲), (▼) buttons to adjust the zoom level
Press the MAGNIFY (OFF) button to exit MAGNIFY mode and restore the screen to normal.
(The projector will also automatically exit MAGNIFY mode if there is a change in the input signal's state.)

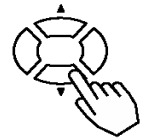

NOTE:

The projector will automatically exit from MAGNIFY mode if either the INPUT SELECT, AUTO, ASPECT or VIDEO feature is used, or, if there is a change in the input signal's state.

Freezing The Screen

- 1 Press the FREEZE button
The [II] icon appears and the screen will freeze at the current image. Press the FREEZE button again and the [▶] appears as the projector exits FREEZE mode.



NOTE:

- The freeze function will automatically finish if any button of the projector is pressed, if there is a change in the input signal's state and or if the following functions are pressed on the remote control. (STANBY/ON, SEARCH, RGB, VIDEO, BLANK, AUTO, VOLUME, MUTE, POSITION OR MENU button.)
- If the projector continues projecting the same image for a long time (i.e. you forget to exit FREEZE mode), the image might possibly remain as an afterimage. Do not leave the projector in FREEZE mode for too long.

Signal Searching

1 Press the SEARCH button

Cycles through input signals, displaying the images of retrieved signals. If no signal is found, it returns to the signal that was selected before the search was initialized.

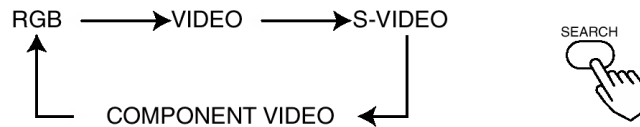

NOTE:

- May not function properly with some input signals.
- The signal searching function takes about 10 seconds to display an image.

Selecting The Aspect Ratio

1 Press the ASPECT button



RGB input

4:3 → 16:9 → 15:9 → 32:15

- At RGB input, selecting an aspect ratio may display the message “SYNC IS OUT OF RANGE”. In this case, please select one of other aspect ratios.

VIDEO, S-VIDEO, COMPONENT VIDEO input

4:3 → 16:9 → WIDE → ZOOM

- At a COMPONENT VIDEO input of 16:9 Hi-Vision of 1125i (1035i/1080i)/750p. only 16:9 can be selected.
- When the 4:3 is selected under the SCREEN TYPE item of the OPTION menu, WIDE and ZOOM cannot be selected.

Temporarily Blanking The Screen

1 Press the BLANK button

The input signal screen is shut off, and a blank screen appears. You can set the blank screen using the menu (from the SCREEN menu, select BLANK).

Press the BLANK button again to remove the blank screen, and return to the input signal screen.



NOTE:

The temporary blank function will automatically finish if any button of the projector is pressed, if there is a change in the input signal's state and or if the following functions are pressed on the remote control. (STANBY/ON, SEARCH, RGB, VIDEO, BLANK, AUTO, VOLUME, MUTE, POSITION OR MENU button.)

Multifunctional Settings

Using The Menu Functions

This projector has the following menus: MAIN, PICTURE-1, PICTURE-2, INPUT, AUTO, SCREEN and OPTION. Each of these menus is operated using the same methods. The basic operations of these menus are as follows.

- 1 Press the MENU button.
The menu display appears on the screen.
- 2 Use the (▲), (▼) buttons to select a menu, then press the (▶) or ENTER button.
The display of the selected menu appears.
- 3 Use the (▲), (▼) buttons to select an item, then press the (▶) or ENTER button.
The operation display of the selected item appears.

When you adjust a numerical value, you can use the single menu (small display showing only the operation display area). Press the (▶) or ENTER button again to switch to the single menu.

- 4 Use the (▲), (▼) buttons to operate the item.
When you want to reset the adjustment, press the RESET button during the operation. Note that the items whose functions are performed simultaneously with operating (ex. LANGUAGE, WHISPER, H PHASE etc.) are not reset.

When you want to return to the previous display, press the (◀) or ESC button.

[ex. Adjusting VOLUME]

1. Press the MENU button
2. Use the (▲), (▼) buttons to select the OPTION, then press the (▶) or ENTER button.
3. Use the (▲), (▼) buttons to select the VOLUME, then press the (▶) or ENTER button.
4. Use the (▲), (▼) buttons to adjust the VOLUME.
5. Press the MENU button to exit.

MAIN Menu

With the MAIN menu, the items shown in the Table below can be performed. Perform each operation in accordance with the instructions in the table below.

MENU		
MAIN	KEYSTONE	+ 0
PICTURE-1	BRIGHT	+ 0
PICTURE-2	CONTRAST	+ 0
INPUT	ASPECT	4:3
AUTO	WHISPER	NORMAL
SCREEN	MIRROR	NORMAL
OPTION	LANGUAGE	ENGLISH
[EXEC] SELECT [Language]		

Item	Description
KEYSTONE	<p>Adjust the Keystone (Vertical) Distortion: Upper in the data (▲)↔(▼) Lower in the data</p> <ul style="list-style-type: none"> The adjustable range of this function will vary with the type of input signal. At some signals, this function may not work well. When the V:INVERT or the H&V:INVERT is selected under the MIRROR item, if the projector screen is inclined or if the projector is angled downward, this function may not work correctly. When the WIDE is selected under the ASPECT item of the MAIN menu, this adjustment is ignored. When the zoom adjustment is set to the TELE side, this correction may be excessive. This function should be used with zoom set to WIDE whenever possible.
BRIGHT	<p>Adjust the Brightness: Light (▲)↔(▼) Dark</p>
CONTRAST	<p>Adjust the Contrast: Strong (▲)↔(▼) Weak</p>
ASPECT	<p>Select an Aspect Ratio At a RGB input: 4:3 (▲)↔(▼) 16:9 (▲)↔(▼) 15:9 (▲)↔(▼) 32:15</p> <ul style="list-style-type: none"> At a RGB input, selecting an aspect ratio may display the message "SYNC IS OUT OF RANGE". In this case, please select one of other aspect ratios. <p>At a VIDEO input, a S-VIDEO input or a COMPONENT VIDEO input: 4:3 (▲)↔(▼) 16:9 (▲)↔(▼) WIDE (▲)↔(▼) ZOOM</p> <ul style="list-style-type: none"> At a COMPONENT VIDEO input of 16:9 Hi-Vision of 1125i(1035i/1080i)/750p, only 16:9 can be selected. When the 4:3 is selected under the SCREEN TYPE item of the OPTION menu, WIDE and ZOOM cannot be selected.
WHISPER	<p>Select the Whisper Mode: NORMAL (▲)↔(▼) WHISPER</p> <ul style="list-style-type: none"> When the WHISPER is selected, acoustic noise and screen brightness are reduced.
MIRROR	<p>Select a Mirror Status: NORMAL(▲)↔(▼)H:INVERT (▲)↔(▼) V:INVERT (▲)↔(▼) H&V:INVERT</p>
LANGUAGE	<p>Select a Menu Language: ENGLISH(▲)↔(▼)FRANÇAIS(▲)↔(▼)DETSCH(▲)↔(▼)ESPAÑOL(▲)↔(▼)ITALIANO(▲)↔(▼)NORSK(▲)↔(▼)NEDERLANDS(▲)↔(▼)日本語(▲)↔(▼)PORTUGUÊS(▲)↔(▼)中文(▲)↔(▼)한글(▲)↔(▼)SVENSKA(▲)↔(▼)PYCCKИЙ(▲)↔(▼)SUOMI(▲)↔(▼) POLSKI</p>
RESET	<p>Reset the MAIN Menu Items: Selecting the EXECUTE performs this function. EXECUTE (▲)← CANCEL</p> <ul style="list-style-type: none"> The items of the MAIN menu are collectively returned to the initial setting. Note that the items WHISPER and LANGUAGE are not reset

PICTURE-1 Menu

With the PICTURE-1 menu, the items shown in the Table below can be performed. Perform each operation in accordance with the instructions in the table below.

MENU		
MAIN	GAMMA	NORMAL
PICTURE-1	COLOR BAL R	+0
PICTURE-2	COLOR BAL G	+0
INPUT	COLOR BAL B	+0
AUTO	SHARPNESS	+0
SCREEN	COLOR	+0
OPTION	TINT	+0
	MY MEMORY	SAVE1
SELECT		

Item	Description
GAMMA	<p>Select a Gamma Mode: NORMAL(▲)↔(▼)CINEMA(▲)↔(▼)DYNAMIC(▲)↔(▼)CUSTOM</p> <ul style="list-style-type: none"> Selecting the CUSTOM and then pressing the (▶) or the ENTER button calls the CUSTOM menu. <p>CUSTOM Menu Selecting one from the following and then pressing the (▶) or the ENTER button performs each function. GAMMA(▲)↔(▼)COLOR TEMP(▲)↔(▼)R(▲)↔(▼)G(▲)↔(▼)B</p> <ul style="list-style-type: none"> The R, G and B can be selected only when the USER is selected under the COLOR TEMP.
CUSTOM GAMMA	<p>Adjust the Gamma Data: Up (▲) ↔ (▼) Down</p>
CUSTOM COLOR TEMP	<p>Select a Color Temperature Mode: HIGH(▲)↔(▼)MIDDLE (▲)↔(▼)LOW(▲)↔(▼)USER</p>
CUSTOM R	<p>Adjust the Red Color Level for the USER mode of the COLOR TEMP: Strong (▲) ↔ (▼) Weak</p>
CUSTOM G	<p>Adjust the Green Color Level for the USER mode of the COLOR TEMP: Strong (▲) ↔ (▼) Weak</p>
CUSTOM B	<p>Adjust the Blue Color Level for the USER mode of the COLOR TEMP: Strong (▲) ↔ (▼) Weak</p>
COLOR BAL R	<p>Adjust the Red Color Balance: Strong (▲) ↔ (▼) Weak</p>
COLOR BAL G	<p>Adjust the Green Color Balance: Strong (▲) ↔ (▼) Weak</p>
COLOR BAL B	<p>Adjust the Blue Color Balance: Strong (▲) ↔ (▼) Weak</p>
SHARPNESS	<p>Adjust the Sharpness: Clear (▲) ↔ (▼) Soft</p> <ul style="list-style-type: none"> This is a function for video inputs. This item can't be selected only at RGB inputs.
COLOR	<p>Adjust the Whole Color: Strong (▲) ↔ (▼) Weak</p> <ul style="list-style-type: none"> This is a function for video inputs. This item can't be selected only at RGB inputs and SCART RGB inputs.
TINT	<p>Adjust the Tint: Green (▲) ↔ (▼) Red</p> <ul style="list-style-type: none"> This is a function for video inputs. This item can't be selected only at RGB inputs and SCART RGB inputs.

PICTURE-1 Menu (Continued)

Item	Description
MY MEMORY	<p>Load/Save a Setting: Selecting one from the following and then pressing the (▶) or the ENTER button performs each function. LOAD1(▲)↔(▼)LOAD2(▲)↔(▼)LOAD3(▲)↔(▼)LOAD4(▲)← (▼)SAVE1(▲)↔(▼)SAVE2(▲)↔(▼)SAVE3(▲)↔(▼)SAVE4</p> <ul style="list-style-type: none"> • This projector has 4 memories called M1, M2, M3 and M4 for settings. Performing the SAVE1, SAVE2, SAVE3 or SAVE4 puts the current setting data on the memory whose number corresponds. Performing the LOAD1, LOAD2, LOAD3 or LOAD4 calls the data of memory whose number corresponds, and adjusts the picture automatically depending on the data. • The LOAD1, LOAD2, LOAD3 or LOAD4 cannot be selected cannot be selected when there is no memory whose number corresponds. • At a different signal input from the signal that was being inputted when the setting was memorized, the picture may not be adjusted correctly.
RESET	<p>Reset the PICTURE-1 Menu Items: Selecting the EXECUTE performs this function. EXECUTE (▲) ← CANCEL</p> <ul style="list-style-type: none"> • The items of the PICTURE-1 menu are collectively returned to the initial setting. Note that the items MY MEMORY and CUSTOM-GAMMA are not reset.

PICTURE-2 Menu

MENU		
MAIN	V POSITION	20
PICTURE-1	H POSITION	142
PICTURE-2	H PHASE	31
INPUT	H SIZE	1344
AUTO	OVER SCAN	95
SCREEN	RESET	
OPTION		

With the PICTURE-2 menu, the items shown in the Table below can be performed. Perform each operation in accordance with the instructions in the table below.

Item	Description
V POSITION	<p>Adjust the Vertical Position: Up (▲) ↔ (▼) Down</p> <ul style="list-style-type: none"> • This item can be selected only at a RGB input
H POSITION	<p>Adjust the Horizontal Position: Left (▲) ↔ (▼) Right</p> <ul style="list-style-type: none"> • This item can be selected only at a RGB input
H PHASE	<p>Adjust the Horizontal Phase (to eliminate flicker): Right (▲) ↔ (▼) Left</p> <ul style="list-style-type: none"> • This item can be selected only at a RGB input or a COMPONENT VIDEO input.
H SIZE	<p>Adjust the Horizontal Size: Large (▲) ↔ (▼) Small</p> <ul style="list-style-type: none"> • When this adjustment is excessive, the picture may not be displayed correctly. In such a case, please press the RESET button during selection of this item to reset the H SIZE. • This item can be selected only at a RGB input
OVER SCAN	<p>Adjust the Over-scan Ratio: Large (▲) ↔ (▼) Small</p> <ul style="list-style-type: none"> • This item can be selected only at a VIDEO input, a S-VIDEO input or a COMPONENT VIDEO input • When this adjustment is too large, a certain degradation may appear at the frame area of the picture. In such a case, please adjust small.
RESET	<p>Reset the PICTURE-2 Menu Items: Selecting the EXECUTE performs this function. EXECUTE (▲) ← CANCEL</p> <ul style="list-style-type: none"> • The items of the PICTURE-2 menu are collectively returned to the initial setting. Note that the H PHASE item is not reset.

INPUT Menu

With the INPUT menu, the items shown in the Table below can be performed. Perform each operation in accordance with the instructions in the table below.



Item	Description
COLOR SPACE	<p>Select a Color Space Mode: AUTO(▲)⇄(▼)RGB(▲)⇄(▼)SMPTE240(▲)⇄(▼)REC709(▲)⇄(▼)REC601</p> <ul style="list-style-type: none"> • This item can be selected only at a RGB input or a COMPONENT VIDEO input. • When the AUTO is selected, the optimum mode is automatically selected. However, it may not work well at some signals. In such a case, select the SMPTE240 or REC709 for HDTV signal.
COMPONENT	<p>Select a Function of COMPONENT VIDEO Jacks: COMPONENT (▲) ⇄ (▼) SCART RGB</p> <ul style="list-style-type: none"> • When the SCART RGB is selected, the COMPONENT VIDEO jacks function as ports for a RGB input with a SCART cable. Refer to the section “Signal Connector Pin Assignment” of “TECHNICAL”.
VIDEO	<p>Select a Signal Type Mode: AUTO (▲) ⇄ (▼) NTSC (▲) ⇄ (▼) PAL (▲) ⇄ (▼) SECAM (▲) ← (▼) NTSC 4.43 (▲) ⇄ (▼) M-PAL (▲) ⇄ (▼) N-PAL</p> <ul style="list-style-type: none"> • This item performs only at a VIDEO input or a S-VIDEO input. For a COMPONENT VIDEO input, although this item is ineffective, the signal type is identified automatically even if the AUTO is not selected. For HDTV signals, refer to the HDTV item below • Selecting the AUTO automatically selects the optimum mode. However, it may not work well at a PAL60 signal and some other signals. If the picture becomes unstable (ex. a irregular picture, color lack), please select the mode depending on the input signal. • The AUTO operation requires approximately 10 seconds.
FRAME LOCK	<p>Select the Frame Lock Mode: TURN ON (▲) ⇄ (▼) TURN OFF</p> <ul style="list-style-type: none"> • This function performs only at a RGB input with vertical frequency of 48 to 72 Hz. • When the TURN ON is selected, a moving picture is displayed more smoothly. • This function may cause a certain degradation of the picture. In such a case, please select the TURN OFF.
3D-YCS	<p>Select a 3D-YCS mode: STILL IMAGE (▲) ⇄ (▼) NORMAL (▲) ⇄ (▼) TURN OFF</p> <ul style="list-style-type: none"> • This function performs only at a VIDEO input of NTSC 3.58. • NORMAL is the mode for images with a lot of motions like movies, and STILL IMAGE is the mode for images with few motions or completely still ones like slides. • When this function performs, the VIDEO NR function is ineffective

INPUT Menu(Continued)

Item	Description
VIDEO NR	<p>Select a Noise Reduction Mode: HIGH (▲) ⇄ (▼) MIDDLE (▲) ⇄ (▼) LOW</p> <ul style="list-style-type: none"> • This function performs only at a VIDEO input or a S-VIDEO input. At a VIDEO input of NTSC 3.58, this function performs only when the TURN OFF is selected under the 3D-YCS. • When the HIGH, the MIDDLE or the LOW is selected, the noise on screen is reduced according to each mode. • When this function is excessive, it may cause a certain degradation of the picture.
PROGRESSIVE	<p>Select the Progressive Mode: TV (▲) ⇄ (▼) FILM (▲) ⇄ (▼) TURN OFF</p> <ul style="list-style-type: none"> • This function performs only at an interlaced signal of a VIDEO input, a S-VIDEO input or a COMPONENT VIDEO input of 525i or 625i signal. The FILM mode is adaptable to the 3-2 Pull-Down system to the conversion. • When the TV or FILM is selected, the resolution is raised. • This function may cause a certain degradation of the picture. In such a case, please select TURN OFF.
INFORMATION	<p>Display the Information: Pressing the (▶) or the ENTER button performs this function.</p> <ul style="list-style-type: none"> • Use this function when you want the information about the current input (ex. the resolution and the vertical frequency at a RGB input, the signal type of a video input) and setting states of the COMPONENT, the VIDEO and the FLAME LOCK.
S2-ASPECT	<p>Select the S2-ASPECT Mode: TURN ON (▲) ⇄ (▼) TURN OFF</p> <ul style="list-style-type: none"> • This function performs only at a S-VIDEO input. • When the TURN ON is selected, an S2-Video signal can be identified and the optimum aspect ratio is automatically selected. • When the ASPECT button of the remote control is used or the ASPECT item of the MAIN menu is operated, the S2-ASPECT mode will be switched to the TURN OFF automatically.
RESET	<p>Reset the INPUT Menu Items: Selecting the EXECUTE performs this function. EXECUTE (▲) ← CANCEL</p> <ul style="list-style-type: none"> • The items of the INPUT menu are collectively returned to the initial setting. Note that the INFORMATION item is not reset.

AUTO Menu

With the AUTO menu, the items shown in the Table below can be performed. Perform each operation in accordance with the instructions in the table below.

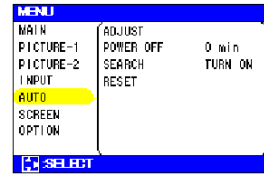

Item	Description
ADJUST	<p>Automatically Adjust the Picture: Pressing the (▶) or the ENTER button performs this function</p> <p>At a RGB input:</p> <ul style="list-style-type: none"> • V POSITION, H POSITION, H PHASE and HSIZE are automatically adjusted. Please use this function with the maximum window size. <p>At a VIDEO input or S-VIDEO input:</p> <ul style="list-style-type: none"> • This function performs only when the AUTO is selected under the VIDEO item of the INPUT menu. For a COMPONENT VIDEO input, although this function is ineffective, the signal type is identified automatically even if the AUTO is not selected. For HDTV signals, refer to the HDTV item below. • This function automatically selects the optimum mode for the input signal. However, it may not work well at a PAL60 signal and some other signals. If the picture becomes unstable (ex. irregular picture, color lack), please use the function of VIDEO of the INPUT menu. • The operation of this function requires approximately 10 seconds.
POWER OFF	<p>Set the Automatically Power Off Timer: Long (Max. 99 minutes.) (▲) ⇔ (▼) Short (Min. 0 minute =DISABLE)</p> <ul style="list-style-type: none"> • This function performs only when the time is set to 1 to 99. • When the set time passes without a valid signal (there is no signal, or the signal is out of specifications), the projector lamp automatically goes off, and the POWER indicator begins blinking. Please refer to the section “Turning OFF The Projector” of “Power ON/OFF” about the turning off.
SEARCH	<p>Automatically Signal Search: TURN ON (▲) ⇔ (▼) TURN OFF</p> <ul style="list-style-type: none"> • If the TURN ON is selected under this item when no signal input is detected, the projector begins searching for an input signal. When an input signal is detected the projector will cease searching and the picture will appear. • The priority of a search is as follows: RGB → VIDEO → S-VIDEO → COMPONENT VIDEO ↑ └──────────────────────────────────┘ • If the projector is unstable to find an input signal at any of its ports, it will return to the state it was in prior to the search.
RESET	<p>Reset the AUTO Menu Items: Selecting the EXECUTE performs this function. EXECUTE (▲) ← CANCEL</p> <ul style="list-style-type: none"> • The items of the AUTO menu are collectively returned to the initial setting. Note that the item ADJUST is not reset.

SCREEN Menu

With the SCREEN menu, the items shown in the Table below can be performed. Perform each operation in accordance with the instructions in the table below.

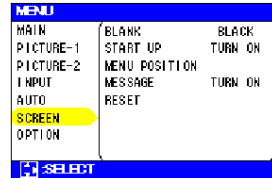

Item	Description
BLANK	<p>Select a Blank Screen Color: BLUE (▲) ⇔ (▼) WHITE (▲) ⇔ (▼) BLACK</p> <ul style="list-style-type: none"> The blank screen of selected color is displayed by pressing the BLANK button. Please refer to the section “Temporarily Blanking The Screen” of “Operation” about the screen blanking.
START UP	<p>Select the Start Up Screen: TURN ON (▲) ⇔ (▼) TURN OFF</p> <ul style="list-style-type: none"> If the TURN OFF is selected when there is no signal or the detected signal is out of specifications, the blank screen is displayed.
MENU POSITION	<p>Adjust a Menu Position: Pressing the (▶) or ENTER button start adjusting,</p> <p style="text-align: center;">Up (▲) ↑</p> <p style="text-align: center;">Left (◀) ← → (▶) Right</p> <p style="text-align: center;">↓ (▼) Down</p> <ul style="list-style-type: none"> The (◀) button does not finish this item. When you want to return to the previous display, please press the ESC button.
MESSAGE	<p>Select the Message Mode: TURN ON (▲) ⇔ (▼) TURN OFF</p> <ul style="list-style-type: none"> When the TURN OFF is selected, the following message functions are disabled: <ul style="list-style-type: none"> The message of “AUTO IN PROGRES” The message of “NO INPUT IS DETECTED” The message of “SYNC IS OUT OF RANGE” The message while being searched for an input signal, “Searching” The message when an input signal is detected, “Detecting” The indication of the input signal by input change.
RESET	<p>Reset the SCREEN Menu Items: Selecting the EXECUTE performs this function. EXECUTE (▲) ← CANCEL</p> <ul style="list-style-type: none"> The items of the SCREEN menu are collectively returned to the initial setting..

OPTION Menu

With the OPTION menu, the items shown in the Table below can be performed. Perform each operation in accordance with the instructions in the table below.

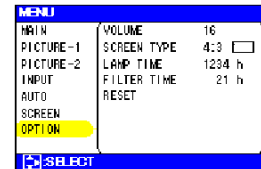

Item	Description
VOLUME	Adjust the Volume: High (▲) ⇄ (▼) Low
SCREEN TYPE	<p>Select the Screen Type: 4:3(▲)⇄(▼)16:9-TOP(▲)⇄(▼)16:9-CENTER(▲)⇄(▼)16:9-BOTTOM</p> <ul style="list-style-type: none"> Please select the screen type used and the picture position in case of 16:9. This selection is used as basic information for a suitable display. This function should be performed before other picture adjustment.
LAMP TIME	<p>To begin the operation of this item, please press the (▶) button of the projector or the RESET button of the remote control for 3 seconds.</p> <p>Reset the Lamp Timer: Selecting the RESET performs this function RESET (▲) ← CANCEL</p> <ul style="list-style-type: none"> The numerical value of four digits shown on this menu is the projector use time since the last RESET operation of this item. The value is reset to 0 at the same time the RESET is selected. The value of this function is used to display the message of "CHANGE THE LAMP". So this function must be performed only immediately after replacing the lamp. Do not perform this function unless you have replaced the lamp. Perform this function every time the lamp is replaced. Incorrect performing of this function causes incorrect operation of the message function. After the lamp running reaches 2000 hours, a warning message is displayed: "To maximize performance, lamp replacement is recommended.", but won't shut the unit off. The message display for 30 seconds when the PJ is turned on. If we push any button while displaying the message, the message disappears. Please see to the section "Lamp" about replacing the lamp.
FILTER TIME	<p>To begin the operation of this item, please press the (▶) button of the projector or the RESET button of the remote control for 3 seconds.</p> <p>Reset the Filter Timer: Selecting the RESET performs this function RESET (▲) ← CANCEL</p> <ul style="list-style-type: none"> The numerical value of four digits shown on this menu is the projector use time since the last RESET operation of this item. The value is reset to 0 at the same time the RESET is selected. The value of this function is used to display the message of "CLEAN THE AIR FILTER". So this function must be performed only immediately after cleaning or replacing the air filter. Do not perform this function unless you have cleaned or replaced the air filter. Perform this function every time the air filter is cleaned or replaced. Incorrect performing of this function causes incorrect operation of the message function. Please see to the section "Air Filter" about cleaning and replacing the air filter.
RESET	<p>Reset the OPTION Menu Items: Selecting the EXECUTE performs this function. EXECUTE (▲) ← CANCEL</p> <ul style="list-style-type: none"> The SCREEN TYPE item is returned to the initial setting. Note that the items VOLUME, LAMP TIMER and FILTER TIMER are not reset.

Lamp



HIGH VOLTAGE

HIGH TEMPERATURE

HIGH PRESSURE

WARNING

The projector uses a high-pressure mercury glass lamp made of glass. The lamp can **break with a loud bang, or burn out**, if jolted or scratched, handled while hot, or worn over time. Note that each lamp has a different lifetime, and some may burst or burn out soon after you start using them. In addition, when the bulb bursts, it is possible for **shards of glass** to fly into the lamp housing, and for **gas containing mercury** to escape from the projector's vent holes

- If the lamp should break (it will make a loud bang when it does), unplug the power cord from the outlet, and make sure to request a replacement lamp from your local dealer. Note that shards of glass could damage the projector's internals, or cause injury during handling, so please do not try to clean the projector or replace the lamp yourself.
- If the lamp should break (it will make a loud bang when it does), ventilate the room well, and make sure not to breathe the gas that comes out of the projector vents, or get it in your eyes or mouth.
- Do not open the lamp cover while the projector is suspended from above. This is dangerous, since if the lamp's bulb has broken, the shards will fall out when the cover is opened. In addition, working in high places is dangerous, so ask your local dealer to have the lamp replaced even if the bulb is not broken.
- If the indicators or a message prompts you to replace the lamp (see the section "Related Messages" and "Regarding the indicator Lamps"), replace the lamp as soon as possible. Using the lamp for long periods of time, or past the replacement date, could cause it to burst. Do not use old (used) lamps; this is a cause of breakage.
- If the lamp breaks soon after the first time it is used, it is possible that there are electrical problems elsewhere besides the lamp. If this happens, contact your local dealer or a service representative.
- Use the lamp of the specified type only. (sold separately)
- Handle with care: jolting or scratching could cause the lamp bulb to burst during use.
- Before replacing the lamp, make sure the power switch is off and the power cable is not plugged in, then wait at least 45 minutes for the lamp to cool sufficiently. Handling the lamp while hot can cause burns, as well as damaging the lamp.
- Do not use the projector with the lamp cover removed. At the lamp replacing, make sure that the screws are screwed in firmly. Loose screws could result in damage or injury.
- Obey local ordinances when disposing of used lamps. In most cases, it is possible to dispose of used bulbs in the same manner as used glass bottles, but in some cases, bulbs are sorted separately.

Replacing The Lamp

CAUTION

- Do not reset the lamp timer without replacing the lamp.
- When you replace the lamp, please replace also the air filter. The air filter may be attached when you buy a replacement lamp for this projector. Please ask your dealer.

If the indicators or a message prompts you to replace the lamp, replace the lamp as soon as possible. Using the lamp for long periods of time, or past the replacement date, could cause it to burst. If the projector is mounted on the ceiling, or if the lamp has broken, do not try to clean the projector or replace the lamp yourself.

- 1 Turn off the projector, and unplug the power cord. Allow the lamp bulb to cool for at least 45 minutes.
- 2 Contact your local dealer to prepare a new lamp. Tell the dealer your lamp type number. If the projector is mounted on the ceiling, or if the lamp has broken, also ask the dealer to replace the lamp.

In the case of replacement by yourself,

- 3 After making sure that the projector has cooled adequately, slowly flip over the projector, so that the bottom is facing up.

- 4 Hold the release button while sliding out the lamp cover.

- 5 Unscrew the 2 screws, and slowly pick up the lamp by the handles.

- 6 Insert the new lamp, and tighten the 2 screws firmly to lock it in place.

- 7 Slide the lamp cover into place until it locks into position.

- 8 Slowly turn the projector so that the top is facing up.

- 9 Turn on the projector, and reset the lamp timer.

- (1) While the projector running, press the MENU button to open the menu.
- (2) Choose the “OPTION” on the menu using the (▲)/(▼) button, then press the (▶) button or ENTER button
- (3) Choose the “LAMP TIME” using the (▲)/(▼) button, then press and hold the (▶) button of projector or the RESET button of remote control for 3 seconds.
- (4) Choose the “RESET” using the (▲) button.

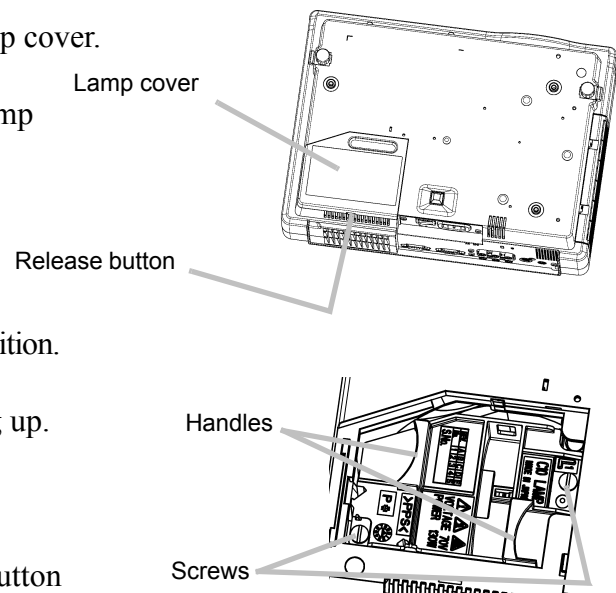

Air Filter



WARNING

- Please carefully read the “PJ510 QUICK START GUIDE”.
- Before replacing the air filter, make sure the power switch is off and the power cable is not plugged in.
- Use the air filter of the specified type only. (sold separately)
- Do not use the projector with the air filter and filter cover removed. The use without the air filter could result in damage.



CAUTION

- Do not reset the filter timer without cleaning or replacing the air filter.
- If the air filter becomes clogged by dust or the like, internal temperature rises and could cause malfunction. The power is automatically turned off in order to prevent the projector from overheating internally.
- When you replace the lamp, please replace also the air filter. The air filter may be attached when you buy a replacement lamp for this projector. Please ask your dealer.

Caring For The Air Filter

The air filter should be cleaned about every 100 hours. If the indicators or a message prompts you to clean the air filter, clean the air filter as soon as possible. If the air filter becomes clogged by dust or the like, internal temperature rises and could cause malfunction.

- 1 Turn off the projector, and unplug the power cord.
- 2 Apply a vacuum cleaner to the top of the filter cover to clean the air filter.
- 3 Reset the filter timer, according to following “Reset The Filter Timer”.

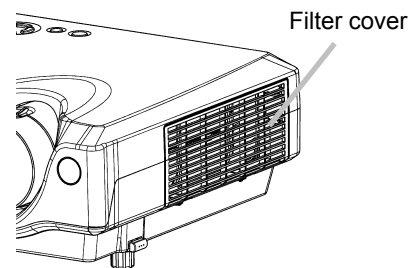

- (1) Turn on the projector. While the projector running, press the MENU button to open the menu.
- (2) Choose the “OPTION” on the menu using the (▲)/(▼) button, then press the (▶) button or ENTER button.
- (3) Choose the “FILTER TIME” using the (▲)/(▼) button, then press and hold the (▶) button of projector or the RESET button of remote control for 3 seconds.
- (4) Choose the “RESET” using the (▲) button.

Replacing The Air Filter

If the soiling will not come off the air filter, or it becomes damaged, then it needs to be replaced. Please replace the air filter as soon as possible.

- 1 Turn off the projector, and unplug the power cord.
- 2 Contact your local dealer to prepare a new air filter. Tell the dealer your air filter type number.
- 3 After making sure that the projector has cooled adequately, remove the filter cover. Hold the release buttons of the filter cover, while pulling it up.

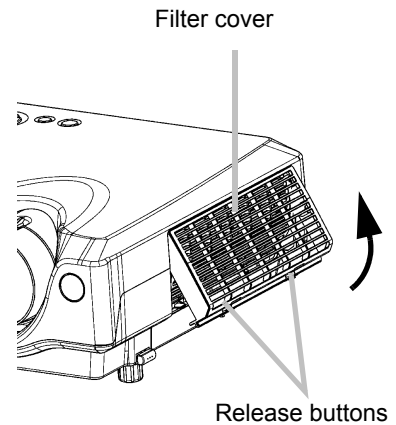

- 4 Hold the release buttons of the air filter, while pulling down on it.

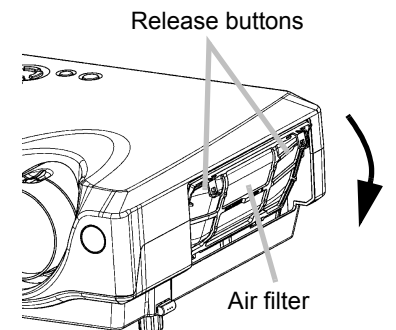

- 5 Insert a new air filter, and replace the filter cover.
- 6 Reset the filter timer, according to following “Reset The Filter Timer”.
 - (1) Turn on the projector. While the projector running, press the MENU button to open the menu.
 - (2) Choose the “OPTION”.
 - (3) Choose the “FILTER TIME” using the (▲)/(▼) button, then press and hold the (▶) button of projector or the RESET button of remote control for 3 seconds.
 - (4) Choose the “RESET” using the (▲) button.

Other Care



WARNING

- Please carefully read the “PJ510 QUICK START GUIDE”.
- Before replacing the air filter, make sure the power switch is off and the power cable is not plugged in.



ATTENTION

- Do not use cleaners or chemicals other than those listed above, including benzene and paint thinner.
- Do not use aerosols or sprays.
- Do not polish or wipe with hard objects.

Caring For The Inside Of The Projector

In order to ensure the safe use of your projector, please have it cleaned and inspected by your local dealer about once every 2 years. Never try to care for the inside of the unit yourself. Doing so is dangerous.

Caring For The Lens

- 1 Turn off the projector, and unplug the power cord.
- 2 Lightly wipe the lens with a commercially available lens-cleaning wipe.
Do not touch the lens directly with your hand.

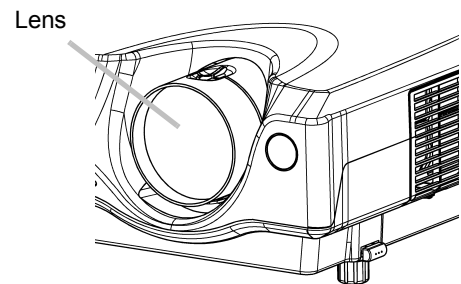

Caring For The Cabinet And Remote Control

- 1 Turn off the projector, and unplug the power cord.
- 2 Wipe lightly with gauze or a soft cloth.
If soiling is severe, dip a soft cloth in water or a neutral cleaner dilute in water, and wipe lightly after wringing well. Then, wipe lightly with a soft, dry cloth.

Troubleshooting

Related Messages

When the unit's power is ON, messages such as those shown below may be displayed. When any such message is displayed on the screen, please respond as described below. If the same message is displayed after the treatment, or if a message other than the following appears, please contact your dealer or service company.

Message	Description
TO MAXIMIZE PERFORMANCE, LAMP REPLACEMENT IS RECOM- MENDED.	The unit does not display a warning message on the screen when the lamp expires or fails. When the lamp does not light, this indicates that the lamp is no longer functional and should be replaced. Replace the lamp and do not forget to reset the timer.
CLEAN THE AIR FILTER AFTER CLEANING AIR FILTER, RESET THE FILTER TIMER.	A note of precaution when cleaning the air filter. After cleaning the filter, operate FILTER TIME of the OPTION Menu, then perform reset of the filter timer.
NO INPUT IS DETECTED ON ***	There is no input signal. Check the signal input connection and the status of the signal source.
SYNC IS OUT OF RANGE ON ***	The horizontal or vertical frequencies of the inputted signal is outside of the operating range limits of this unit. Please confirm the specs for this unit or the signal source specs.
CHECK THE AIR FLOW	The internal temperature is rising. Please turn the power OFF, then allow the unit to cool down for approximately 20 minutes. After having confirmed the following items, then please reset the power to ON. <ul style="list-style-type: none">• Is there blockage of the air filter?• Is the air filter dirty?• Does the ambient temperature exceeds 35°C?
CLEAN THE AIR FILTER POWER OFF FIRST, THEN CLEAN THE AIR FILTER. AFTER CLEANING THE AIR FIL- TER, RESET THE FILTER TIMER.	A note of precaution when cleaning the air filter. Please immediately turn the power off, and clean or change the air filter by referring to the "Air Filter" section of this manual. After you have cleaned or changed the air filter, please be sure to reset the filter timer. If the same message is displayed after the treatment, please clean the transparent area of filter cover and the dust-detecting window, according to the following.

Note:

* Although this message will be automatically disappeared after around 3 minutes, it will be reappeared every time the power is turned ON.



ATTENTION

The transparent area of filter cover and the dust-detecting window should be cleaned for normal operation of the optical dust detecting system. Please pay attention not to remain fiber or fragment of cloth inside the duct.

- 1 Turn off the projector, and unplug the power cord.
- 2 After making sure that the projector has cooled adequately, remove the filter cover.
Hold the release buttons of the filter cover, while pulling it up.

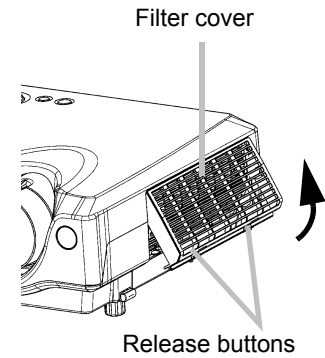

- 3 Wipe the transparent area of the filter cover by using a swab or a soft cloth.

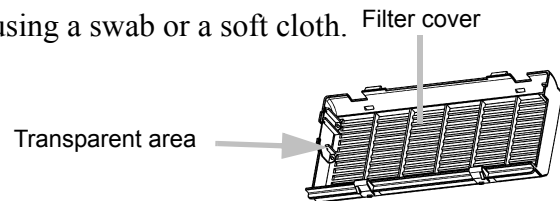

- 4 Remove the air filter.
Hold the release buttons of the air filter, while pulling it down.

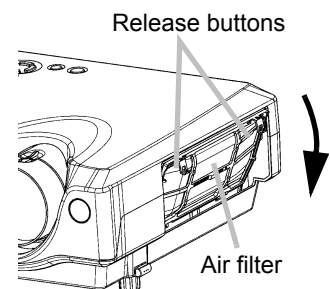

- 5 Wipe the dust-detecting window by using a soft cloth.

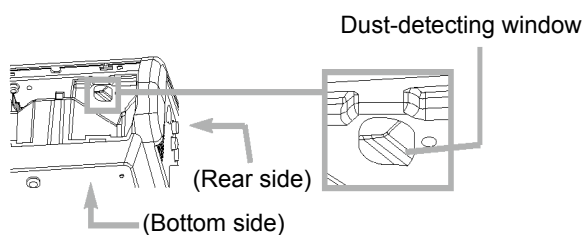

- 6 Replace the air filter and filter cover.

Regarding The Indicator Lamps



ATTENTION

When the interior portion has become overheated, for safety purposes, the power source may be automatically turned off, and the indicator lamps may also be turned off. In such a case, press the “○” (OFF) side of the power switch, and wait at least 45 minutes. After the unit has sufficiently cooled down, please make confirmation of the attachment state of the lamp and lamp cover, and then turn the power on again.

Lighting and flashing of the POWER indicator, the LAMP indicator, and the TEMP indicator have the meanings as described in the Table below. Please respond in accordance with the instructions within the Table. If the same indication is displayed after the treatment, or if an indication other than the following is displayed, please contact your dealer or service company.

POWER indicator	LAMP indicator	TEMP indicator	Description
Lighting in orange	Turned off	Turned off	The unit is in a standby state. Please refer to the “Power ON/OFF” section of this manual.
Flashing in green	Turned off	Turned off	The unit is warming up. Please wait.
Lighting in green	Turned off	Turned off	The unit is in an ON state. Ordinary operations may be performed.
Flashing in orange	Turned off	Turned off	The unit is cooling down. Please wait.
Blinking in red	-	-	The unit is cooling down. A certain error has been detected. Wait until the POWER indicator has finished flashing, and then perform the proper response measure using the item descriptions below as reference.
Lighting or blinking in red	Lighting in red	Turned off	The projector lamp has not been properly fixed (attached), the projector lamp does not light, and/or there is a possibility that the interior portion has become heated. Turn the power OFF and wait at least 20 minutes. After the unit has sufficiently cooled down, please make confirmation of the following items, and then turn the power ON again. If the same indication is displayed, please change the lamp. <ul style="list-style-type: none"> • Is there blockage of the air passage aperture? • Is the air filter is dirty? • Does the peripheral temperature exceed 35°C?
Lighting or blinking in red	Blinking in red	Turned off	The lamp cover has not been properly fixed (attached). Turn the power OFF and wait at least 45 minutes. After the unit has sufficiently cooled down, please make confirmation of the attachment state of the lamp and lamp cover, and then turn the power ON again.

POWER indicator	LAMP indicator	TEMP indicator	Description
Lighting or blanking in red	Turned off	Blinking in red	The cooling fan is not operating. Turn the power OFF and wait at least 20 minutes. After the unit has sufficiently cooled down, please make confirmation of the following item, and then resent the power to ON. • Is there no foreign matter caught in the cooling fan?
Lighting or blinking in red	Turned off	Lighting in red	There is a possibility that the interior portion has become heated. Turn the power OFF and wait at least 20 minutes. After the unit has sufficiently cooled down, please make confirmation of the following item, and then resent the power to ON. • Is there blockage of the air passage aperture? • Is the air filter is dirty? • Does the peripheral temperature exceed 35°C?
Lighting in green	Alternative blinking in the red		There is a possibility that the interior portion has become overcooled. Please use the unit within the usage temperature parameters (0°C to 35°C). After the treatment, resent the power to ON.
Lighting in green	Simultaneous blinking in red		It is time to clean the air filter, or there is no air filter. Please immediately turn the power off, and clean or change the air filter by referring to the "Air Filter" section of this manual. After you have cleaned or changed the lamp, please be sure to reset the filter timer. After the treatment, resent the power to ON.

Phenomena That May Easily Be Mistaken For Machine Defects



WARNING

Please carefully read the “PJ510 QUICK START GUIDE”. Never use the projector if abnormal operations such as smoke, strange odor, excessive sound, damaged casing or elements or cables, penetration of liquids or foreign matter, etc. should occur.

NOTE:

Although bright spots or dark spots may appear on the screen, this is a unique characteristic of liquid crystal displays, and such do not constitute or imply a machine defect.

Before requesting repair, please check in accordance with the following chart. If the situation cannot be corrected, then contact your dealer.

Phenomenon	Cases not involving a machine defect, and Items to be confirmed
Power does not come ON.	The main power source is not ON. Turn on the main power.
	The electrical power cord is not plugged in. Correctly connect the power cord.
	The main power source has been interrupted during operation, such as by a power outage (blackout), etc. Be sure to press the “○” (power OFF) side of the main power switch, and leave this OFF for at least 20 minutes. After the unit has sufficiently cooled down, turn ON the power source.
Neither sounds nor pictures are outputted.	The input changeover settings are mismatched. Select the input signal, and correct the settings.
	No signal is being inputted. Correctly connect the connection cables.
Pictures are displayed, but no sounds are heard.	The electrical wiring to this unit is not correctly connected. Correctly connect the connection cables.
	The volume setting has been set at (or adjusted to) an extremely low level. Adjust the VOLUME setting to a higher level.
	The MUTE mode is the current setting. Press the MUTE button to release (change) the MUTE mode setting.
Sounds are heard, but no pictures are displayed.	The electrical wiring to this unit is not correctly connected. Correctly connect the connection cables.
	The brightness setting has been set at (or adjusted to) an extremely low level. Adjust the BRIGHT setting to a brighter level.
	The lens cap has not been removed. Remove the lens cap.

Phenomenon	Cases not involving a machine defect, and Items to be confirmed
Colors have a faded-out appearance, or Color tone is poor.	Color settings are not correctly adjusted. Perform picture adjustments by changing the COLOR BAL R, COLOR BAL G, COLOR BAL B, COLOR, and/or the TINT settings, etc.
Pictures appear dark.	The brightness setting and/or contrast setting has not been properly adjusted. Perform picture adjustments by changing the BRIGHT and/or CONTRAST settings, etc.
	The WHISPER mode is the current setting. Change (by releasing) from the WHISPER mode.
	Lamp is approaching the end of its product lifetime. Exchange the old lamp with a new lamp.
Pictures appear blurry.	Either the FOCUS setting or the H PHASE is not properly adjusted.
	Adjust the focus and the H PHASE setting.

Warranty And After-Service

If a problem occurs with the equipment, first refer to the “Troubleshooting” section of this manual, and run through the suggested checks. If this does not resolve the problem contact your dealer or service company. They will tell you what warranty condition is applied.

Specifications

Item		Specification
Product name		Liquid crystal projector
Liquid crystal panel	Panel size	1.4 cm (0.55 type)
	Drive system	TFT active matrix
	Pixels	480,000 pixels (800 horizontal x 600 vertical)
Lens		Zoom lens F=1.6 ~ 1.8 f=16.8 ~ 20.2 mm
Lamp		130 W UHB
Speaker		1.0 W
Power supply		AC100 ~ 120V, 2.4A / AC220 ~ 240V, 1.1A
Power consumption		220 W
Temperature range		0 ~ 35°C (Operating)
Size		332 (W) x 92 (H) x 254 (D) mm (Not including protruding parts)
Weight (mass)		2.98 kg (6.57lbs)
Ports	RGB Input Ports RGB1 VIDEO Input Ports VIDEO 1 S-VIDEO..... 1 COMPONENT VIDEO (Y, CB/PB, CR/PR) 1	AUDIO Input Ports AUDIO..... 1 AUDIO R, L..... 1 CONTROL Ports CONTROL 1
Optional Parts		Lamp: PRJ-RLC-008 For others, consult your dealer.

NOTE:

This specifications are subject to change without notice.

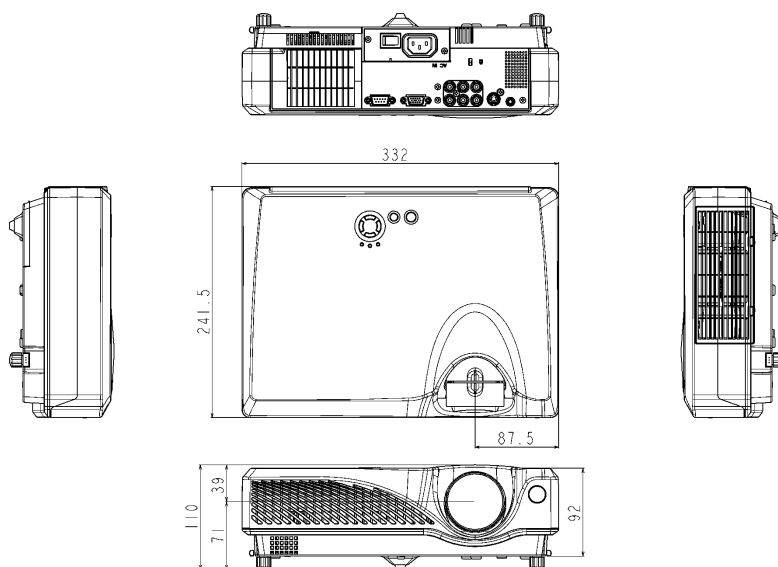

(unit: mm)

Customer Support

For technical support or product service, please contact ViewSonic.

NOTE: You will need the product serial number.

Country/Region	Web site	T = Telephone F = FAX	Email
United States	viewsonic.com/support	T: (800) 688-6688 F: (909) 468-1202	service.us@viewsonic.com
Canada	viewsonic.com/support	T: (800) 688-6688 F: (909) 468-1202	service.ca@viewsonic.com
United Kingdom	viewsoniceurope.com	T: 0800 833 648 F: (01293) 643910	service.eu@viewsoniceurope.com
Europe, Middle East, Baltic countries, and North Africa	viewsoniceurope.com	Contact your reseller	service.eu@viewsoniceurope.com
Australia and New Zealand	viewsonic.com.au	T: +61 2 9929 3955 F: +61 2 9929 8393	service@au.viewsonic.com
Singapore/India and Southeast Asia	viewsonic.com.sg	T: 65 6273 4018 F: 65 6273 1566	service@sg.viewsonic.com
Other Asia/Pacific countries	viewsonic.com.tw	T: 886 2 2246 3456 F: 886 2 8242 3668	service@tw.viewsonic.com
South Africa	viewsonic.com/asia	T: 886 2 2246 3456 F: 886 2 8242 3668	service.ap@viewsonic.com

LIMITED WARRANTY

VIEWSONIC PROJECTOR

What the warranty covers:

ViewSonic® warrants its products to be free from defects in material and workmanship during the warranty period. If a product proves to be defective in material or workmanship during the warranty period, ViewSonic will at its sole option repair or replace the product with a like product. Replacement product or parts may include remanufactured or refurbished parts or components.

How long the warranty is effective:

ViewSonic projectors are warranted for three (3) years for all parts excluding the lamp and three (3) years for all labor from the date of the first consumer purchase. Projector lamps are warranted separately.

Who the warranty protects:

This warranty is valid only for the first consumer purchaser.

What the warranty does not cover:

1. Any product on which the serial number has been defaced, modified or removed.
2. Damage, deterioration or malfunction resulting from:
 - a. Accident, misuse, neglect, fire, water, lightning, or other acts of nature, unauthorized product modification, or failure to follow instructions supplied with the product.
 - b. Repair or attempted repair by anyone not authorized by ViewSonic.
 - c. Any damage of the product due to shipment.
 - d. Removal or installation of the product.
 - e. Causes external to the product, such as electric power fluctuations or failure.
 - f. Use of supplies or parts not meeting ViewSonic's specifications.
 - g. Normal wear and tear.
 - h. Any other cause which does not relate to a product defect.
3. Removal, installation, and set-up service charges.

How to get service:

1. For information about receiving service under warranty, contact ViewSonic Customer Support. You will need to provide your product's serial number.
2. To obtain warranted service, you will be required to provide (a) the original dated sales slip, (b) your name, (c) your address, (d) a description of the problem, and (e) the serial number of the product.
3. Take or ship the product freight prepaid in the original container to an authorized ViewSonic service center or ViewSonic.
4. For additional information or the name of the nearest ViewSonic service center, contact ViewSonic.

Limitation of implied warranties:

THERE ARE NO WARRANTIES, EXPRESS OR IMPLIED, WHICH EXTEND BEYOND THE DESCRIPTION CONTAINED HEREIN INCLUDING THE IMPLIED WARRANTY OF MERCHANTABILITY AND FITNESS FOR A PARTICULAR PURPOSE.

Exclusion of damages:

VIEWSONIC LIABILITY IS LIMITED TO THE COST OF REPAIR OR REPLACEMENT OF THE PRODUCT. VIEWSONIC SHALL NOT BE LIABLE FOR:

1. DAMAGE TO OTHER PROPERTY CAUSED BY ANY DEFECTS IN THE PRODUCT, DAMAGES BASED UPON INCONVENIENCE, LOSS OF USE OF THE PRODUCT, LOSS OF TIME, LOSS OF PROFITS, LOSS OF BUSINESS OPPORTUNITY, LOSS OF GOODWILL, INTERFERENCE WITH BUSINESS RELATIONSHIPS, OR OTHER COMMERCIAL LOSS, EVEN IF ADVISED OF THE POSSIBILITY OF SUCH DAMAGES.
2. ANY OTHER DAMAGES, WHETHER INCIDENTAL, CONSEQUENTIAL OR OTHERWISE.
3. ANY CLAIM AGAINST THE CUSTOMER BY ANY OTHER PARTY.

Effect of state law:

This warranty gives you specific legal rights, and you may also have other rights which vary from state to state. Some states do not allow limitations on implied warranties and/or do not allow the exclusion of incidental or consequential damages, so the above limitations and exclusions may not apply to you.

Sales outside the U.S.A. and Canada:

For warranty information and service on ViewSonic products sold outside of the U.S.A. and Canada, contact ViewSonic or your local ViewSonic dealer.

Appendix

Power Cord Safety Guidelines

Caution: Use a power cable that is properly grounded. Always use an AC power cord that meets your country's safety standard.

USA.....	UL	Switzerland	SEV
Canada.....	CSA	Britain.....	BASE/BS
Germany.....	VDE	Japan	Electric Appliance Control Act

AC PLUG CORD PRECAUTIONS FOR THE UNITED KINGDOM

FOR YOUR SAFETY PLEASE READ THE FOLLOWING TEXT CAREFULLY.

IF THE FITTED MOULDED PLUG IS UNSUITABLE FOR THE SOCKET OUTLET THEN THE PLUG SHOULD BE CUT OFF AND DISPOSED OF SAFELY.

THERE IS A DANGER OF SEVERE ELECTRICAL SHOCK IF THE CUT OFF PLUG IS INSERTED INTO AN APPROPRIATE SOCKET.

If a new plug is to be fitted, please observe the wiring code as shown below.

If in any doubt, please consult a qualified electrician.

WARNING: THIS APPLIANCE MUST BE EARTHED.

IMPORTANT: The wires in this mains lead are coloured in accordance with the following code:

Green-and-Yellow:	Earth
Blue:	Neutral
Brown:	Live

If the coloured wires of the mains lead of this appliance do not correspond with the coloured markings identifying the terminals in your plug, proceed as follows:

The wire which is coloured GREEN-AND-YELLOW must be connected to the terminal in the plug which is marked by the letter E or by the Earth symbol or coloured GREEN or GREEN-AND-YELLOW.

The wire which is coloured BLUE must be connected to the terminal in the plug which is marked with the letter N or coloured BLACK. The wire which is coloured BROWN must be connected to the terminal in the plug which is marked with the letter L or coloured RED.

IMPORTANT NOTICE CONCERNING POWER CORD SELECTION

The power cord set for this unit has been enclosed and has been selected according to the country of destination and must be used to prevent electric shock. Use the following guidelines if it is necessary to replace the original cord set, or if the cord set is not enclosed.

The female receptacle of the cord set must meet CEE-22 requirements and may look like (Figure A1 below):

Figure 1 

For the United States and Canada

In the United States and Canada the male plug is a NEMA5-15 style (Figure A2), UL Listed, and CSA Labeled. For units which are mounted on a desk or table, type SVT cord sets may be used. The cord set must be selected according to the current rating for your unit. Please consult the table below for the selection criteria for power cords used in the United States and Canada.

Figure 2 

Cord Type	Size of Conductors in Cord	Maximum Current Rating of Unit
SJT	18 AWG 16 AWG 14 AWG	10 Amps 12 Amps 12 Amps
SVT	18 AWG 17 AWG	10 Amps 12 Amps

For European Countries

In Europe you must use a cord set which is appropriate for the receptacles in your country. The cord set is HAR-Certified, and a special mark that will appear on the outer sheath, or on the insulation of one of the inner conductors.

If you have any questions concerning which proper power cord to use, please consult with the dealer from whom you have purchased the product.

Compliance Information for U.S.A.

This equipment has been tested and found to comply with the limits for a Class B digital device, pursuant to part 15 of the FCC Rules. These limits are designed to provide reasonable protection against harmful interference in a residential installation. This equipment generates, uses, and can radiate radio frequency energy, and if not installed and used in accordance with the instructions, may cause harmful interference to radio communications. However, there is no guarantee that interference will not occur in a particular installation. If this equipment does cause harmful interference to radio or television reception, which can be determined by turning the equipment off and on, the user is encouraged to try to correct the interference by one or more of the following measures:

- Reorient or relocate the receiving antenna.
- Increase the separation between the equipment and receiver.
- Connect the equipment into an outlet on a circuit different from that to which the receiver is connected.
- Consult the dealer or an experienced radio/TV technician for help.

FCC Warning

To assure continued FCC compliance, the user must use grounded power supply cord and the provided shielded video interface cable with bonded ferrite cores. If a BNC cable is going to be used, use only a shielded BNC(5) cable. Also, any unauthorized changes or modifications not expressly approved by the party responsible for compliance could void the user's authority to operate this device.

Instructions to Users

This equipment complies with the requirements of FCC (Federal Communication Commission) equipment provided that the following condition is met. **Use the cables which are included with the projector or specified.**

Compliance Information for Canada

Notice: This class B digital apparatus complies with Canada ICES-003.

AVIS: Cet appareil numérique de la Classe B conforme a la norme NMB-003 du Canada.

Compliance Information for European Countries

CE Conformity



The device complies with the requirements of the EEC directive 89/336/EEC as amended by 92/31/EEC and 93/68/EEC Art.5 with regard to "Electromagnetic compatibility," and 73/23/EEC as amended by 93/68/EEC Art.13 with regard to "Safety."

User Information for all Countries

NOTICE: Use the cables which are included with the projector or specified.

