

myprojectorlamps.com

**The most trusted, dependable name
in projector lamp sales.**



<http://www.myprojectorlamps.com>



<http://www.myprojectorlamps.ca>



<http://www.myprojectorlamps.eu>

The following projector manual has not been modified or altered in any way.

ViewSonic®

PJ458D DLP Projector



ViewSonic®

- User Guide
- Guide de l'utilisateur
- Bedienungsanleitung
- Guía del usuario
- Guia do usuário
- Руководство пользователя
- 使用手冊 (繁體)
- 使用手冊 (简体)
- 사용자 안내서

Model No. : VS10872

Compliance Information

FCC Statement

This device complies with part 15 of FCC Rules. Operation is subject to the following two conditions: (1) this device may not cause harmful interference, and (2) this device must accept any interference received, including interference that may cause undesired operation. This equipment has been tested and found to comply with the limits for a Class B digital device, pursuant to part 15 of the FCC Rules. These limits are designed to provide reasonable protection against harmful interference in a residential installation. This equipment generates, uses, and can radiate radio frequency energy, and if not installed and used in accordance with the instructions, may cause harmful interference to radio communications. However, there is no guarantee that interference will not occur in a particular installation. If this equipment does cause harmful interference to radio or television reception, which can be determined by turning the equipment off and on, the user is encouraged to try to correct the interference by one or more of the following measures:

- Reorient or relocate the receiving antenna.
- Increase the separation between the equipment and receiver.
- Connect the equipment into an outlet on a circuit different from that to which the receiver is connected.
- Consult the dealer or an experienced radio/TV technician for help.

Warning: You are cautioned that changes or modifications not expressly approved by the party responsible for compliance could void your authority to operate the equipment.

For Canada

- This Class B digital apparatus complies with Canadian ICES-003.
- Cet appareil numérique de la classe B est conforme à la norme NMB-003 du Canada.

CE Conformity for European Countries



The device complies with the requirements of the EEC directive 89/336/EEC as amended by 92/31/EEC and 93/68/EEC Art.5 with regard to “Electromagnetic compatibility”, and 73/23/EEC as amended by 93/68/EEC Art.13 with regard to “Safety.”

Following information is only for EU-member states:

The mark shown to the right is in compliance with the Waste Electrical and Electronic Equipment Directive 2002/96/EC (WEEE).

The mark indicates the requirement NOT to dispose the equipment as unsorted municipal waste, but use the return and collection systems according to local law.



Important Safety Instructions

1. Read these instructions.
2. Keep these instructions.
3. Heed all warnings.
4. Follow all instructions.
5. Do not use this unit near water.
6. Clean with a soft, dry cloth. If still not clean, see “Cleaning the Display” in this guide for further instructions.
7. Do not block any ventilation openings. Install the unit in accordance with the manufacturer’s instructions.
8. Do not install near any heat sources such as radiators, heat registers, stoves, or other devices (including amplifiers) that produce heat.
9. Do not defeat the safety purpose of the polarized or grounding-type plug. A polarized plug has two blades with one wider than the other. A grounding type plug has two blades and a third grounding prong. The wide blade and the third prong are provided for your safety. If the provided plug does not fit into your outlet, consult an electrician for replacement of the obsolete outlet.
10. Protect the power cord from being walked on or pinched particularly at plugs. Convenience receptacles and the point where they exit from the unit. Be sure that the power outlet is located near the unit so that it is easily accessible.
11. Only use attachments/accessories specified by the manufacturer.
12.  Use only with the cart, stand, tripod, bracket, or table specified by the manufacturer, or sold with the unit. When a cart is used, use caution when moving the cart/unit combination to avoid injury from tipping over.
13. Unplug this unit when unused for long periods of time.
14. Refer all servicing to qualified service personnel. Servicing is required when the unit has been damaged in any way, such as: if the power-supply cord or plug is damaged, if liquid is spilled onto or objects fall into the unit, if the unit is exposed to rain or moisture, or if the unit does not operate normally or has been dropped.

Declaration of RoHS Compliance

This product has been designed and manufactured in compliance with Directive 2002/95/EC of the European Parliament and the Council on restriction of the use of certain hazardous substances in electrical and electronic equipment (RoHS Directive) and is deemed to comply with the maximum concentration values issued by the European Technical Adaptation Committee (TAC) as shown below:

Substance	Proposed Maximum Concentration	Actual Concentration
Lead (Pb)	0.1%	< 0.1%
Mercury (Hg)	0.1%	< 0.1%
Cadmium (Cd)	0.01%	< 0.01%
Hexavalent Chromium (Cr ⁶⁺)	0.1%	< 0.1%
Polybrominated biphenyls (PBB)	0.1%	< 0.1%
Polybrominated diphenyl ethers (PBDE)	0.1%	< 0.1%

Certain components of products as stated above are exempted under the Annex of the RoHS Directives as noted below:

Examples of exempted components are:

1. Mercury in compact fluorescent lamps not exceeding 5 mg per lamp and in other lamps not specifically mentioned in the Annex of RoHS Directive.
2. Lead in glass of cathode ray tubes, electronic components, fluorescent tubes, and electronic ceramic parts (e.g. piezoelectric devices).
3. Lead in high temperature type solders (i.e. lead-based alloys containing 85% by weight or more lead).
4. Lead as an allotting element in steel containing up to 0.35% lead by weight, aluminium containing up to 0.4% lead by weight and as a cooper alloy containing up to 4% lead by weight.

Copyright Information

Copyright © ViewSonic® Corporation, 2007. All rights reserved.

Macintosh and Power Macintosh are registered trademarks of Apple Computer, Inc.

Microsoft, Windows, Windows NT, and the Windows logo are registered trademarks of Microsoft Corporation in the United States and other countries.

ViewSonic, the three birds' logo, OnView, ViewMatch, and ViewMeter are registered trademarks of ViewSonic Corporation.

VESA is a registered trademark of the Video Electronics Standards Association. DPMS and DDC are trademarks of VESA.

PS/2, VGA and XGA are registered trademarks of International Business Machines Corporation.

Disclaimer: ViewSonic Corporation shall not be liable for technical or editorial errors or omissions contained herein; nor for incidental or consequential damages resulting from furnishing this material, or the performance or use of this product.

In the interest of continuing product improvement, ViewSonic Corporation reserves the right to change product specifications without notice. Information in this document may change without notice.

No part of this document may be copied, reproduced, or transmitted by any means, for any purpose without prior written permission from ViewSonic Corporation.

Product Registration

To meet your future needs, and to receive any additional product information as it becomes available, please register your product on the Internet at: www.viewsonic.com. The ViewSonic® Wizard CD-ROM also provides an opportunity for you to print the registration form, which you may mail or fax to ViewSonic.

For Your Records

Product Name:	PJ458D ViewSonic DLP Projector
Model Number:	VS10872
Document Number:	PJ458D-1_UG_ENG Rev.1C 02-26-07
Serial Number:	_____
Purchase Date:	_____



The lamp in this product contains mercury.

Please dispose of in accordance with local, state or federal laws.

Notes on AC Power Cord

AC Power Cord must meet requirement of country where you use a projector. Confirm an AC plug type with graphics below and proper AC Power Cord must be used. If supplied AC Power Cord does not match your AC outlet, contact your sales dealer.

This projector is equipped with a grounding type AC line plug. Make sure that your outlet fits the plug. Do not defeat the safety purpose of this grounding type plug. We highly recommend using a video source device also equipped with a grounding type AC line plug to prevent from signal interference due to voltage fluctuation.

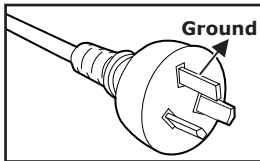

For Australia and
Mainland China □

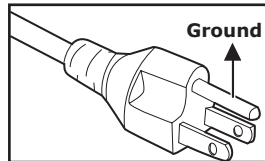

For the U.S.A. and Canada

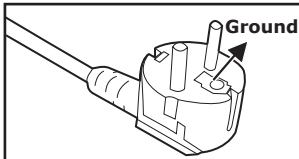

For Continental Europe

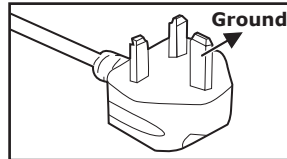

For the U.K.

CONTENTS

Product Introduction	6
Projector Features.....	6
Package Contents.....	7
Getting to Know the Projector.....	8
Projector Components.....	8
Remote Control Components.....	11
Installation	12
Connecting the Projector.....	12
Powering On/Off the Projector	16
Adjusting the Projected Image	17
Adjusting the Projector Zoom and Focus	18
Adjusting Projection Image Size.....	18
Using the Projector.....	20
Control Panel.....	20
Remote Control.....	21
Menu Options	24
Image	25
Video	28
Display.....	29
Language	30
Advanced	31
Audio	32
Maintenance	33
Cleaning the Lens	33
Cleaning the Projector Housing.....	33
Replacing the Lamp	34
Technical Specifications	36
Appendix.....	37
Indicator Messages	37
Preset Signals	38

Product Introduction

Projector Features

The projector integrates high-performance optical engine projection and a user-friendly design to deliver high reliability and ease of use.

The projector offers the following features:

- Single chip 0.55" Texas Instruments DLP™ technology
- XGA (1024 x 768 pixels)
- Compact size, light weight for portability
- 1.2x manual zoom lens
- Auto image re-sizing (Auto-Sync.) to 1024 x 768 full screen with scaling compression compatibility for VGA, SVGA, XGA and SXGA*.
- State-of-the-art motion adaptive hardware deinterlacing with 3:2 pull down
- 200-watt, user-replaceable lamp
- Compatibility with Macintosh® computers
- Compatibility with NTSC, PAL, SECAM, and HDTV
- Multi-function remote control
- D-Sub 15-pin cable for analog video connectivity
- User-friendly, multi-language on-screen display (OSD)
- Advanced electronic keystone correction



* means compressed.

Package Contents

When you unpack the projector, make sure you have all these components:

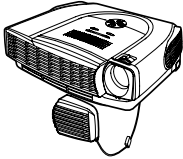

Projector with Lens Cap



AC Power Cord

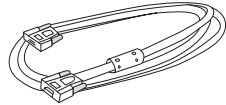

VGA Cable (D-SUB to D-SUB)



S-Video Cable

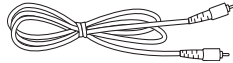

Composite Video Cable



Audio Cable



Battery for Remote Control



Remote Control (IR)



Projector Soft Case



Quick Start Guide

Optional Accessory:



Wizard CD

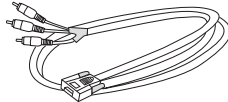

VGA (D-SUB) to HDTV (RCA) Cable

NOTE

- Save the original shipping carton and packing material; they will come in handy if you ever to ship your unit. For maximum protection, repack your unit as it was originally packed at the factory.
- Accessories and components may vary by retailer and region.

Getting to Know the Projector

Projector Components

Front View

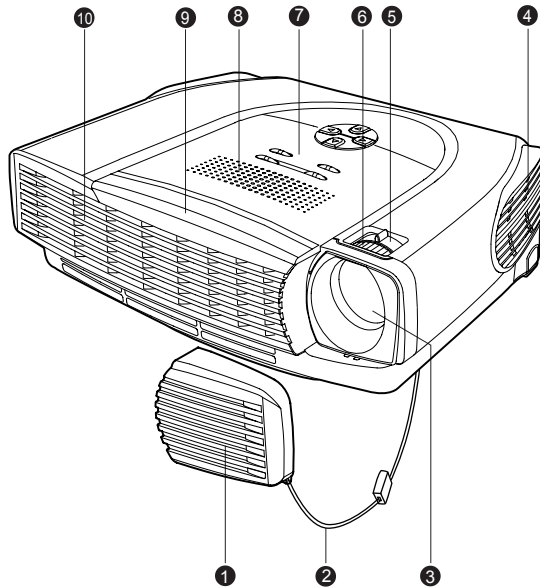

- 1. Lens cap _____
- 2. Lens cap strap _____
- 3. Lens _____
- 4. Ventilation holes (intake) _____
- 5. Zoom ring _____

- 6. Focus ring _____
- 7. Control panel _____
- 8. Speaker _____
- 9. Front IR remote control sensor _____
- 10. Ventilation holes (exhaust) _____

Rear View

1. Interface connector
2. Rear IR remote control sensor
3. Security lock receptacle
4. AC power socket
5. Ventilation holes (intake)
6. Foot adjuster
7. Foot adjuster button

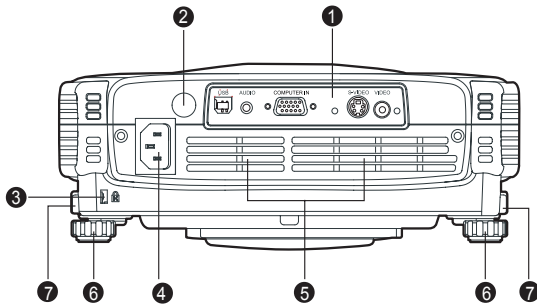

Bottom View

1. Lamp cover

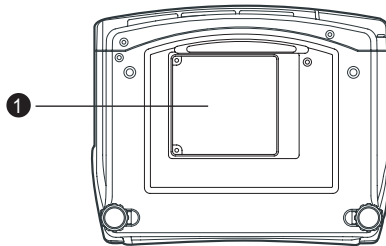





Control Panel

LED

1. POWER (Power LED indicator)
2. LAMP (Lamp LED indicator)

Button

1. 
2. MENU/ENTER
3. KEYSTONE (/)
4. AUTO ()
5. Four direction buttons
6. SOURCE ()

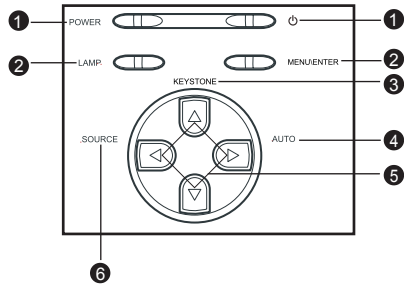

Interface Connector

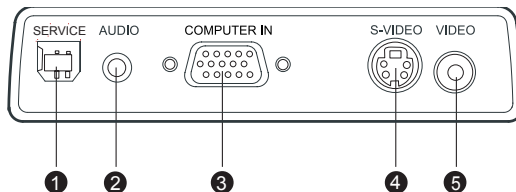

1. Service connector
This connector is used for engineering purpose.
2. AUDIO input connector
Connect an audio output from video equipment to this jack.
3. COMPUTER IN (D-SUB) connector
Connect image input signal (analog) to this connector.
4. S-VIDEO connector
Connect S-Video output from video equipment to this jack.
5. VIDEO connector
Connect composite video output from video equipment to this jack.

Remote Control Components

1. ① Power button
2. Four direction buttons
3. Menu button
4. Enter button
5. Keystone ▲/▼ buttons
6. Volume ▲/▼ buttons
7. Source button
8. Mute button
9. Blank button
10. 4:3/16:9 button
11. Auto button

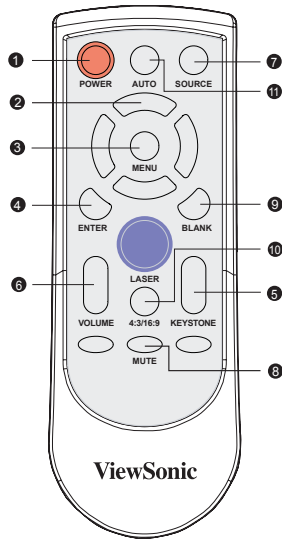

Installation

Connecting the Projector

A. Connecting to a computer

- ① AC Power Cord
- ② VGA Cable (D-SUB to D-SUB)

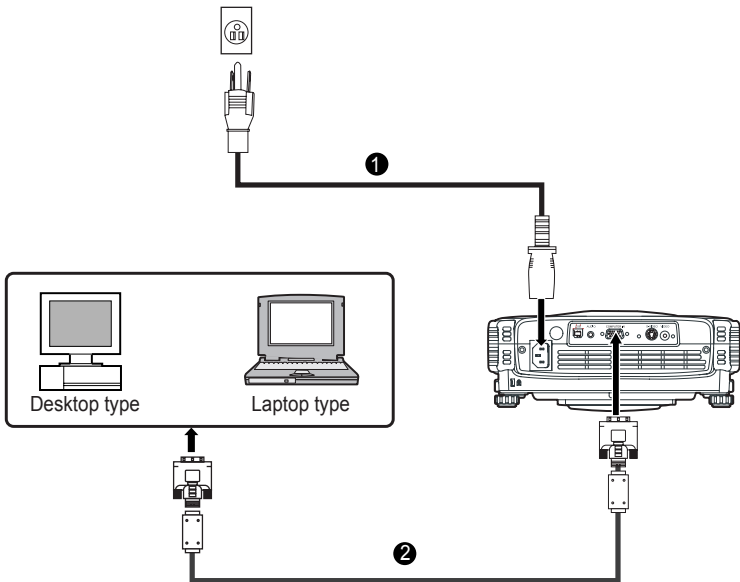

B. Connecting to a Video Source

1. Connecting with S-Video Cable

- ① AC Power Cord
- ② S-Video Cable
- ③ Audio Cable

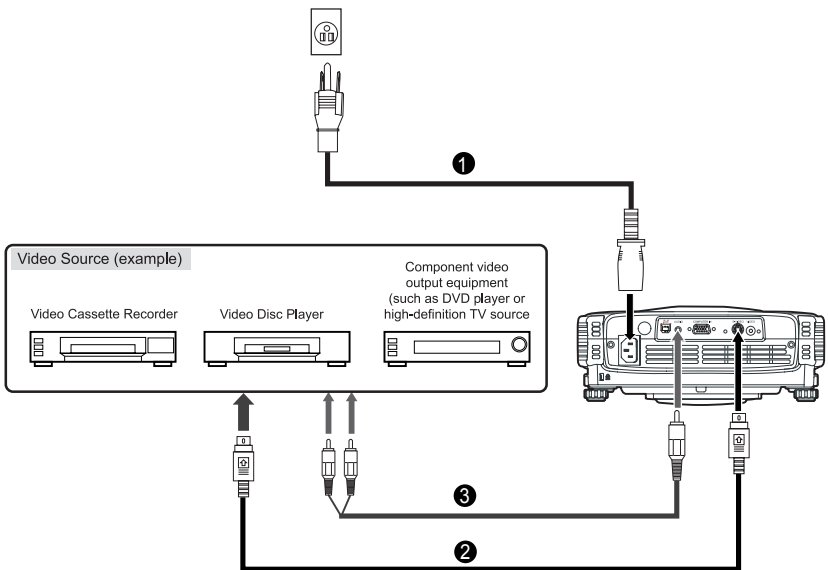

2. Connecting with Composite Video Cable

- ① AC Power Cord
- ② Composite Video Cable
- ③ Audio Cable

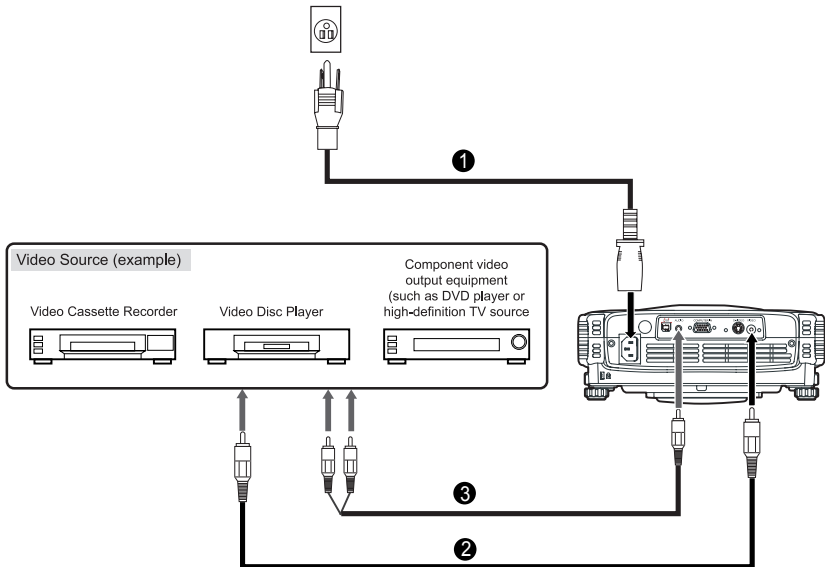

3. Connecting with HDTV Cable

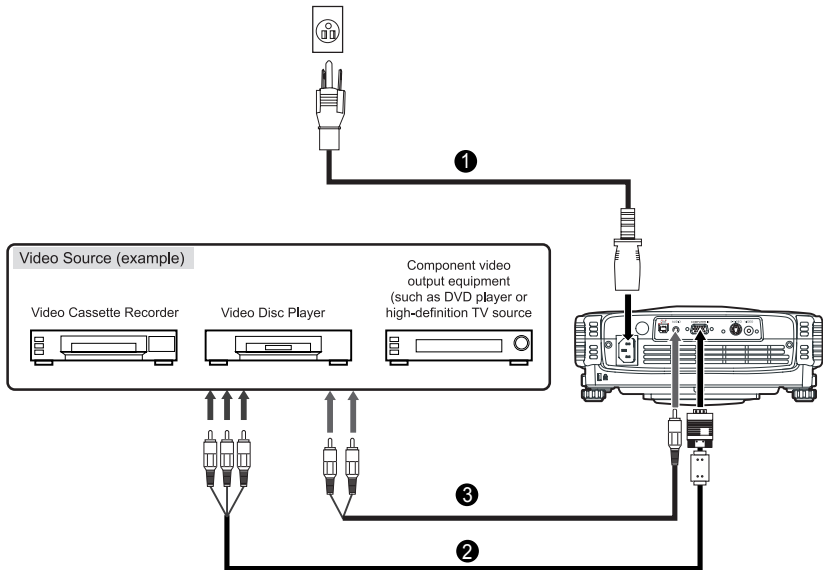

- ① AC Power Cord
- ② D-SUB to HDTV Cable
- ③ Audio Cable



When connecting cable, power cords of both a projector and external equipment should be disconnected from AC outlet.

Powering On/Off the Projector



Powering On the Projector:

1. Remove the projector lens cap.
2. Complete the AC power cord and peripheral signal cable(s) connections.
3. Press the  button on the Projector Control Panel or the  Power button on the Remote Control to turn on the power.
4. Turn on your source (computer, notebook, DVD, etc.). The projector automatically detects your source.
 - If the “Searching for source” message appears on the screen, ensure that the appropriate signal cable(s) are securely connected.
 - If you are connecting multiple sources to the projector simultaneously, press the SOURCE button on the Projector Control Panel or the Source button on the Remote Control to select the desired source.



Warning:

- Never look into the lens when the lamp is on. This can damage your eyes. It is especially important that children are not allowed to look into the lens.

Powering Off the Projector:

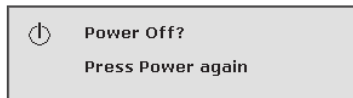
1. Press the  button on the Projector Control Panel or the  Power button on the Remote Control. A message will appear on the screen:



2. Press the  button on the Projector Control Panel or the  Power button on the Remote Control again to turn off the power. Wait until the lamp LED indicator turns off.



Please wait until the fan motor and the lamp LED turn off before removing the AC power cord from the projector.

Adjusting the Projected Image

Adjusting the Projector Height

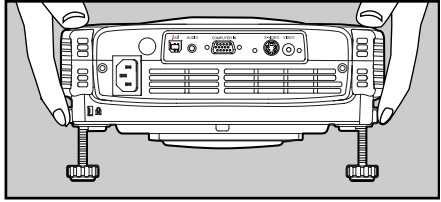
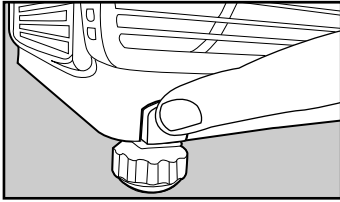

To raise the projector:

1. Lift up the rear side of the projector, and press the foot adjuster buttons on the two sides.
2. Raise the projector to the desired display height, and then release the buttons to lock the foot adjusters into position.

To lower the projector:

1. Lift up the rear side of the projector, and press the foot adjuster buttons on the two sides.
2. Lower the projector, and then release the buttons to lock the foot adjusters into position.



- You may turn the foot adjuster to make fine adjustment of the height.
- To avoid damaging the projector, make sure that the foot adjuster is fully retracted before placing the projector in its carrying case.

Adjusting the Projector Zoom and Focus

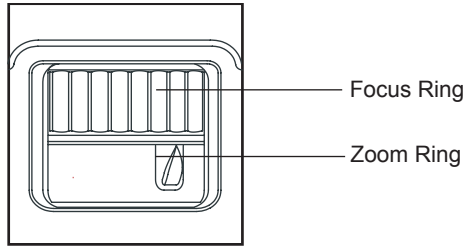

1. Adjust the image size by rotating the zoom ring.
Rotate to the right to reduce the image.
Rotate to the left to enlarge the image.
2. Focus the image by rotating the focus ring.
A still image is recommended for focusing.

Adjusting Projection Image Size

Refer to the graphic and table below to determine the screen size and projection distance.

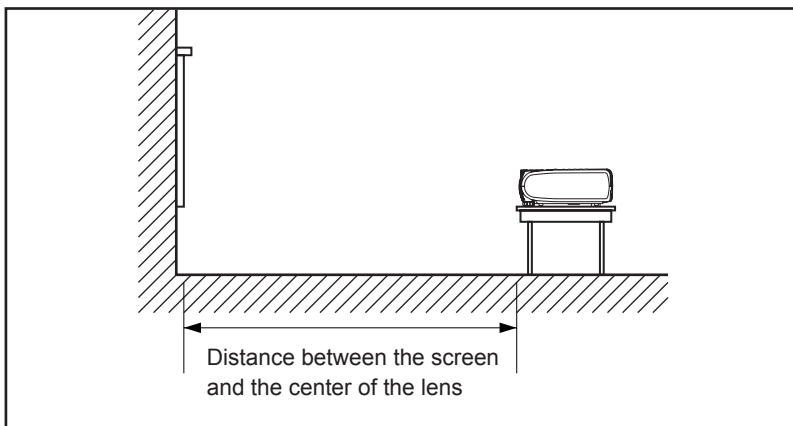

Projection Distance (m)	4 : 3 Screen Size –Diagonal (inch)		16 : 9 Screen Size-Diagonal (inch)	
	Wide	Tele	Wide	Tele
1.2	33.0	27.5	30.2	25.2
1.5	41.2	34.3	37.8	31.5
2	55.0	45.8	50.4	42.0
2.2	60.5	50.4	55.5	46.2
3	82.5	68.7	75.7	63.1
4	110.0	91.6	100.9	84.1
5	137.5	114.5	126.2	105.1
6	165.0	137.5	151.4	126.2
7	192.5	160.4	176.6	147.2
8	220.0	183.3	201.9	168.2
9	247.5	206.2	227.1	189.3
10	275.0	229.1	252.4	210.3

* This table is for user reference only.



- *Position the projector in a horizontal position; other positions can cause heat build-up and damage to the projector.*
- *Make sure the heat ventilation holes are not blocked.*
- *Do not use the projector in a smoky environment. Smoke residue may cause buildup on critical parts (i.e. DMD, lens assembly, etc.)*

Using the Projector



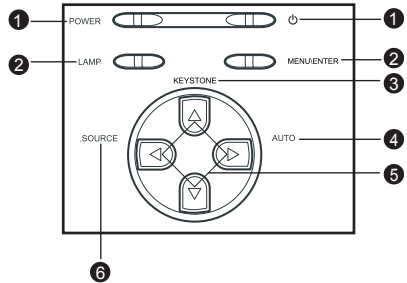





Control Panel



LED

1. POWER (Power LED indicator)
Refer to “Indicator Messages”.
2. LAMP (Lamp LED indicator)
Refer to “Indicator Messages”.

Button Function

1. 
Refer to “Powering On/Off the Projector”.
2. MENU \ ENTER
Press the MENU\ENTER button to activate the OSD (On-Screen Display) menu. Use the directional buttons and MENU\ENTER button to navigate through the OSD (On-Screen Display) menu and select choices.
3. KEYSTONE (/)
Adjusts image distortion caused by tilting the projector.
4. AUTO ()
Automatically adjusts frequency and phase.
5. Four direction buttons
The four direction buttons /// can be used to scroll through OSD (On-Screen Display) menus and make adjustments.
6. SOURCE ()
Manually selects an input source.

Remote Control

1. **Power**
Refer to "Powering On/Off the Projector".
2. **Four direction buttons**
The four direction buttons ▲/▼/◀/▶ can be used to scroll through OSD (On-Screen Display) menus and make adjustments.
3. **Menu**
Press the Menu button to activate the OSD (On-Screen Display) menu. Use the directional buttons and Menu button to navigate through the OSD (On-Screen Display) menu.
4. **Enter**
Confirms the selection
5. **Keystone ▲ /▼**
Adjusts image distortion caused by tilting the projector.
6. **Volume ▲ /▼**
Press the Volume ▲ button to increase the volume; press the Volume ▼ button to reduce the volume.
7. **Source**
Manually selects an input source.
8. **Mute**
Cuts off the sound temporarily.
9. **Blank**
Cuts off the screen temporarily.
10. **4:3/16:9**
Press the 4:3/16:9 to switch the image aspect ratio from 4:3 to 16:9.
11. **Auto**
Automatically adjusts frequency and phase.

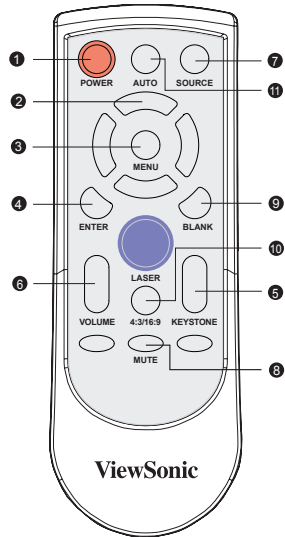

Battery Replacement

- Keep the battery out of the reach of children. There is a danger of death by accidentally swallowing the battery.
- Do not recharge the used battery or expose the battery to fire or water.
- Do not dispose of the used battery along with household waste. Dispose of used batteries according to local regulations.
- Avoid excessive heat and humidity. Danger of explosion may happen if a battery is incorrectly replaced. Replace only with the same type recommended by the manufacturer.

Remote Control Operation

Point the remote control at the infrared remote sensor and press a button.

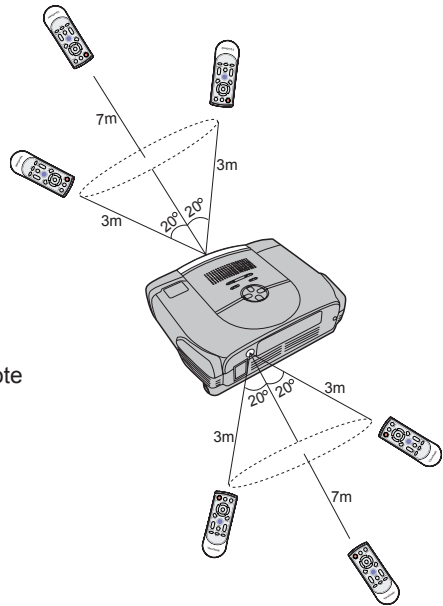

- A. Straight Distance: within about 7 meters from the front of the remote sensor.
- B. Direction:
Angle: within about 20 degrees of the remote sensor in every direction.
Distance: within about 3 meters from the front of the remote sensor.



- *The remote control may not operate when there is sunlight or other strong light such as a fluorescent lamp shining on the remote sensor.*
- *Operate the remote control from a position where the remote sensor is visible.*
- *Do not drop the remote control or jolt it.*
- *Keep the remote control out of locations with excessively high temperature or humidity.*
- *Do not get water on the remote control or place wet objects on it.*
- *Do not disassemble the remote control.*

Menu Options

The projector has multi-language OSD (On-Screen Display) menus that can only be displayed when an input source is present. The menus can be accessed using either the Projector Control Panel or the Remote Control.

The OSD (On-Screen Display) menus allow you to make image adjustments and change a variety of settings. If source is a computer, the OSD (On-Screen Display) allows changes to the Display tab. When using a video source, the OSD (On-Screen Display) allows changes to the Video tab. The projector automatically detects the source.



1. Press the MENU/ENTER button on the Projector Control Panel or the Menu button on the Remote Control.
2. Select the menu tab with the ◀/▶ buttons either on the Projector Control Panel or the Remote Control.
3. Select the desired menu option item with the ▲/▼ buttons either on the Projector Control Panel or the Remote Control.
 - To enter its respective sub-menu, refer to each menu option section for more details.
4. To exit from the menu:
 - On the Projector Control Panel: Go back to main menu tab with the ▲ /▼ buttons, and press the MENU/ENTER button.
 - On the Remote Control: press the Menu button.

NOTE

The illustrations in this manual are for the purpose of explanation and may differ from the actual setting of your projector.

Image

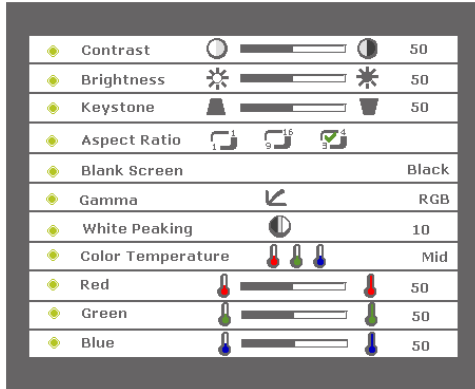

Option	Actions/Descriptions
Contrast	<p>Controls the degree of difference between the lightest and darkest parts of the picture. Adjusting the contrast changes the amount of black and white in the image.</p> <p>Select the desired setting with the ◀/▶ buttons:</p> <ul style="list-style-type: none"> ■ Press the ◀ button to decrease the contrast. ■ Press the ▶ button to increase the contrast.
Brightness	<p>Adjusts the brightness of the image.</p> <p>Select the desired setting with the ◀/▶ buttons:</p> <ul style="list-style-type: none"> ■ Press the ◀ button to darken the image. ■ Press the ▶ button to lighten the image.
Keystone	<p>Adjusts image distortion caused by tilting the projector.</p> <p>Select the desired setting with the ◀/▶ buttons:</p> <ul style="list-style-type: none"> ■ Press the ◀ button to reduce the upper width. ■ Press the ▶ button to reduce the lower width.
Aspect Ratio	<p>Selects this function to fit 1:1, 16:9, 4:3 aspect ratio. In order to use the 1:1 aspect ratio, the input must be a computer signal (through VGA cable) of resolution less than SVGA (800 x 600). If the input signal is a computer signal greater than SVGA or component 1080i / 720p, only 16:9 or 4:3 aspect ratio will be available.</p>

	<p>Select the desired setting with the ◀ / ▶ buttons:</p> <ul style="list-style-type: none"> ■ 1:1: The input source will be displayed without scaling ■ 16:9: The input source will be displayed in wide screen mode (16:9) without scaling. The source will be scaled to fit the width of the screen. ■ 4:3: The input source will be scaled to fit the screen.
Blank Screen	<p>Blanks the screen temporarily, and selects the screen color when Blank Screen is active.</p> <p>Select the desired setting with the ◀ / ▶ buttons:</p> <ul style="list-style-type: none"> ■ White ■ Black ■ Blue ■ Gray ■ Red ■ Green ■ Yellow ■ Cyan ■ Magenta
Gamma	<p>Selects Gamma Mode.</p> <p>Select the desired setting with the ◀ / ▶ buttons:</p> <ul style="list-style-type: none"> ■ Film : Dark video image mode ■ Photographic: Computer photo mode ■ RGB: Computer text mode ■ Video : Common video mode
White Peaking	<p>White Peaking can be adjusted between 0 and 10.</p> <p>Select the desired setting with the ◀ / ▶ buttons:</p> <ul style="list-style-type: none"> ■ Setting 10 will maximize the brightness. ■ Setting 0 will maximize color reproduction quality.
Color Temperature	<p>Adjusts the color temperature. With the higher temperature, the screen looks colder; with the lower temperature, the screen looks warmer. Red, Green and Blue mode activate only if the Color Temperature is set to "User".</p>

	<p>Select the desired setting with the ◀ / ▶ buttons:</p> <ul style="list-style-type: none"> ■ Hi ■ Mid ■ Low ■ User
Red	<p>Manually adjusts red.</p> <p>Select the desired setting with the ◀ / ▶ buttons:</p> <ul style="list-style-type: none"> ■ Press the ◀ button to decrease the color temperature. ■ Press the ▶ button to increase the color temperature.
Green	<p>Manually adjusts green.</p> <p>Select the desired setting with the ◀ / ▶ buttons:</p> <ul style="list-style-type: none"> ■ Press the ◀ button to decrease the color temperature. ■ Press the ▶ button to increase the color temperature.
Blue	<p>Manually adjusts blue.</p> <p>Select the desired setting with the ◀ / ▶ buttons:</p> <ul style="list-style-type: none"> ■ Press the ◀ button to decrease the color temperature. ■ Press the ▶ button to increase the color temperature.

Video

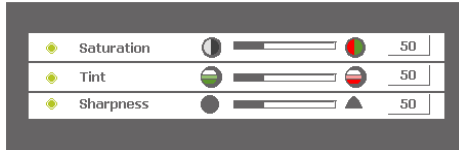

Option	Actions/Descriptions
Saturation	<p>Adjusts a video image from black and white to fully saturated color.</p> <p>Select the desired setting with the ◀ / ▶ buttons:</p> <ul style="list-style-type: none"> ■ Press the ◀ button to decrease the amount of color in the image. ■ Press the ▶ button to increase the amount of color in the image.
Tint	<p>Adjusts the color balance of red and green.</p> <p>Select the desired setting with the ◀ / ▶ buttons:</p> <ul style="list-style-type: none"> ■ Press the ◀ button to increase the amount of green in the image. ■ Press the ▶ button to increase the amount of red in the image.
Sharpness	<p>Adjusts the sharpness of the image.</p> <p>Select the desired setting with the ◀ / ▶ buttons:</p> <ul style="list-style-type: none"> ■ Press the ◀ button to decrease the sharpness. ■ Press the ▶ button to increase the sharpness.

Display

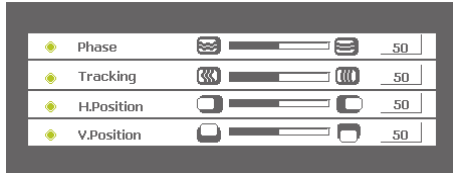

Option	Actions/Descriptions
Phase	<p>Synchronizes the signal timing of the display with that of the graphic card. If you experience an unstable or flickering image, use the phase function to correct it.</p> <p>Select the desired setting with the ◀ / ▶ buttons:</p> <ul style="list-style-type: none"> ■ Press the ◀ button to decrease the value. ■ Press the ▶ button to increase the value.
Tracking	<p>Changes the display data frequency to match the frequency of your computer graphic card. If you experience a vertical flickering bar, use the tracking function to make an adjustment.</p> <p>Select the desired setting with the ◀ / ▶ buttons:</p> <ul style="list-style-type: none"> ■ Press the ◀ button to decrease the value. ■ Press the ▶ button to increase the value.
H.Position	<p>Adjusts the horizontal position.</p> <p>Select the desired setting with the ◀ / ▶ buttons:</p> <ul style="list-style-type: none"> ■ Press the ◀ button to move the image left. ■ Press the ▶ button to move the image right.
V.Position	<p>Adjusts the vertical position.</p> <p>Select the desired setting with the ◀ / ▶ buttons:</p> <ul style="list-style-type: none"> ■ Press the ◀ button to move the image up. ■ Press the ▶ button to move the image down.

Language



Option	Actions/Descriptions
Language	<p>Selects the language for menu and message displayed.</p> <p>Select the language you prefer with the ▲ / ▼ buttons, and confirm the selection with the MENU/ENTER button on the Projector Control Panel or the Enter button on the Remote Control.</p> <ul style="list-style-type: none"> ■ English ■ Deutsch ■ 简体中文 ■ 日本語 ■ Français ■ Español ■ Português ■ Italiano ■ Русский ■ 繁體中文 ■ 한국어

Advanced

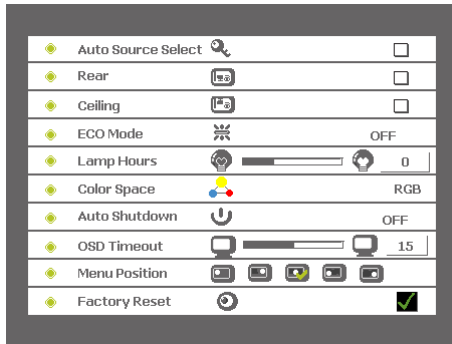

Option	Actions/Descriptions
Auto Source Select	Automatically scans the input source. Press the MENU/ENTER button on the Projector Control Panel or the Enter button on the Remote Control to activate this function.
Rear	The image is reversed horizontally. Press the MENU/ENTER button on the Projector Control Panel or the Enter button on the Remote Control to activate this function.
Ceiling	The image is inverted vertically. Press the MENU/ENTER button on the Projector Control Panel or the Enter button on the Remote Control to activate this function.
ECO Mode	Uses this function to dim the projector lamp light output which will lower power consumption and increase lamp life. Select the desired setting with the ◀/▶ buttons: <ul style="list-style-type: none"> ■ ON ■ OFF
Lamp Hours	Displays operating hours since lamp timer reset. Lamp hour counter is displayed in read-only format, and this setting cannot be manually adjusted.
Color Space	Manually selects signal type. Select the input signal type with the ◀/▶ buttons: <ul style="list-style-type: none"> ■ RGB ■ YCbCr ■ YPbPr

Auto Shutdown	<p>Uses this function to automatically turn off the lamp if the projector does not detect an input signal for specified time period (30 minutes).</p> <p>Select the desired setting with the ◀ / ▶ buttons:</p> <ul style="list-style-type: none"> ■ ON ■ OFF
OSD Timeout	<p>Duration OSD (On-Screen Display) menu stays active (at idle state by second).</p> <p>Select the desired setting with the ◀ / ▶ buttons.</p>
Menu Position	<p>Selects the position of the OSD (On-Screen Display) menu on the screen.</p> <p>Select the desired setting with the ◀ / ▶ buttons.</p>
Factory Reset	<p>Resets the projector to its factory default settings.</p> <p>Press the MENU/ENTER button on the Projector Control Panel or the Enter button on the Remote Control to enter its sub-menu, select the desired setting with the ◀ / ▶ buttons, and confirm the selection with the MENU/ENTER button on the Projector Control Panel or the Enter button on the Remote Control again.</p>

Audio



Option	Actions/Descriptions
Volume	<p>Adjusts the volume.</p> <p>Select the desired setting with the ◀ / ▶ buttons:</p> <ul style="list-style-type: none"> ■ Press the ◀ button to decrease the volume. ■ Press the ▶ button to increase the volume.
Mute	<p>Cuts off the sound temporarily.</p> <p>Select the desired setting with the ◀ / ▶ buttons:</p> <ul style="list-style-type: none"> ■ ON ■ OFF

Maintenance

The projector needs proper maintenance. You should keep the lens clean as dust, dirt or spots will project on the screen and diminish image quality. The only part you could replace yourself is the lamp. If any other parts need replacing, contact your dealer or qualified service personnel. When cleaning any part of the projector, always switch off and unplug the projector first.

Warning:

- Never open any of the covers on the projector except the lamp cover. Dangerous electrical voltages inside the projector can cause severe injury. Except as specifically indicated in this User's Manual, do not attempt to service this product yourself. Refer all servicing to qualified service personnel.

Cleaning the Lens

Gently wipe the lens with lens cleaning paper. Do not touch the lens with your hands.

Cleaning the Projector Housing

Gently wipe with a soft cloth. If dirt and stains are not easily removed, use a soft cloth dampened with water, or water and neutral detergent, and wipe dry with a soft, dry cloth.



- *Turn off the projector and remove the AC power cord from the power outlet before beginning maintenance work.*
- *Make sure the lens is cool before cleaning.*
- *Do not use detergents or chemicals other than those noted above. Do not use benzene or thinners.*
- *Do not use chemical sprays.*
- *Use a soft cloth or lens paper only.*

Replacing the Lamp

Projector lamps have a finite life. Replace the lamp when:

- The image becomes darker and hues become weaker after a lamp has been for a long period of time.
- The projector lamp LED indicator turns into red. Refer to section titled "Indicator Messages" for further details.



- *The lamp becomes high temperature after turning off the projector with the power button. If you touch the lamp, you may scald your finger. When you replace the lamp, wait for at least 45 minutes for the lamp to cool down.*
- *Do not touch the lamp glass at any time. The lamp may explode due to improper handling, including the touching of the lamp glass.*
- *Lamp lifetime may differ from lamp to lamp and according to the environment of use. There is no guarantee of the same lifetime for each lamp. Some lamps may fail or terminate their lifetime in a shorter period of time than other similar lamps.*
- *A lamp may explode as a result of vibration, shock or degradation as a result of hours of use as its lifetime draws to an end. Risk of explosion may differ according to the environment or conditions in which the projector and lamp are being used.*
- *Wear protective gloves and eyeglasses when fixing or detaching the lamp.*
- *Faster on-off-cycles will damage the lamp and reduce lamp life. Wait at least for 5 minutes to turn off the projector after powering on.*
- *Do not operate the lamp in proximity to paper, cloth, or other combustible material nor cover it with such materials. Otherwise it could cause a fire.*
- *Do not operate the lamp in an atmosphere containing an inflammable substance, such as thinner. Otherwise it could cause a fire or explosion.*
- *Thoroughly ventilate the area or the room when operating the lamp in an oxygen atmosphere (in the air). If ozone is inhaled, it could cause headaches, nausea, dizziness, etc.*
- *The inorganic mercury is involved in the lamp. If the lamp bursts, the mercury inside the lamp will go out of the projector. Leave the area immediately if the lamp shatters while being operated and ventilate the area for at least 30 minutes in order to avoid the inhalation of mercury fumes. Otherwise it could be harmful to user's health.*

1. Turn off the projector and unplug the AC power cord.
2. Place a protective sheet (cloth) beneath the projector. Turn the projector over so you can access the lamp cover.
3. Remove the access panel screws and open the panel.
4. Remove the screws on the bottom of the lamp assembly.
5. Grasp the lamp handle and pull the lamp assembly directly out of the projector.
6. Replace with the new lamp.
7. Place back the screws on the bottom of lamp assembly.
8. Place the panel and screw back the screws on the lamp cover.

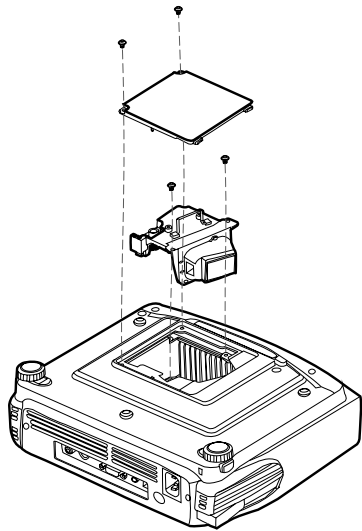

NOTE

- *Dispose of the used lamp according to local regulations.*
- *Ensure that screws are tightened properly. Screws not tightened fully may result in injury or accidents.*
- *Since the lamp is made of glass, do not drop the unit and do not scratch the glass.*
- *Do not reuse the old lamp. This could cause the lamp to explode.*
- *Be sure to turn off the projector and unplug the AC power cord before replacing the lamp.*
- *Do not use the projector with the lamp cover removed.*

Technical Specifications

Projection System	Single panel 0.55" DLP projector
Native resolution	786,432 dot x1 (1024 x 768 x1)
Lens	Manual Zoom (1.2X)
Focal Length	20.2 - 24.2 mm
Aspect Ratio	1:1, 16:9, 4:3
Screen Size	30 – 200 inches
Lamp	200W
Projection Type	Front, Rear, Ceiling
Video Input	PAL, NTSC, SECAM
Input Source	Computer, HDTV, S-Video, Video
Scanning Frequency	
Horizontal Freq.	31 / 79 KHz
Vertical Freq.	56 / 85 Hz
Pixel Rate	135 MHz
Digital Keystone Correction	Vertical: +/- 15 degrees
Analog RGB (input signal)	D-Sub connector
HDTV Display	720p(60 Hz), 1080i(60 Hz)
Integrated Speaker	2W x 1
Remote Control	Multifunctional
OSD Language	Multilanguage
Operational Avmvient	Temperature: +5 - +35°C Humidity: 10 - 85%
Certification	UL, CE, FCC Class B, CCC, TUV-GS,NOM, GOST-R, MIC, PSB
Power Supply	AC 100 - 240 V, 50 - 60 Hz
Power Consumption	250 Watts
Dimension (W x D x H)	254 x 202 x 98 mm
Weight	2.2 kg (4.9 lb)

Note: Design and Specifications are subject to change without prior notice.

Appendix

Indicator Messages

LED Type	Color	Status	Meaning
Power LED	Green	Flashing	The projector is powered and ready.
Power LED	Amber	Solid	The projector system has some problems with its fan, so the projector cannot start up.
Power LED	Green	Solid	The projector is in good condition on working.
Lamp LED	Green	Solid	The lamp is in good condition and is projecting at maximum brightness.
Lamp LED	Amber	Solid	The lamp has reached its end of life and must be changed soon. The lamp will continue to operate until it fails. Change the lamp. If the lamp is off, then the ballast will become malfunction.
Lamp LED	Green	Flashing	The projector is shutting down. The fan motor is cooling the lamp for shutdown. Do not unplug the power cable or turn the power switch off before the lamp LED turns off. The fan motor will turn off when the lamp has cooled.
Lamp LED	Amber	Flashing	Temperature is too high. The lamp will turn off.

Preset Signals

Preset signal		fH (kHz)	fV (Hz)	Sync	Size
640 x 480	VGA mode 3	31.469	59.940	H(-), V(-)	800
	VGA VESA 72 Hz	37.861	72.809	H(-), V(-)	832
	VGA VESA 75 Hz	37.500	75.000	H(-), V(-)	840
	VGA VESA 85 Hz	43.269	85.008	H(-), V(-)	832
800 x 600	SVGA VESA 56 Hz	35.156	56.250	H(+), V(+)	1024
	SVGA VESA 60 Hz	37.879	60.317	H(+), V(+)	1056
	SVGA VESA 72 Hz	48.077	72.188	H(+), V(+)	1040
	SVGA VESA 75 Hz	46.875	75.000	H(+), V(+)	1056
	SVGA VESA 85 Hz	53.674	85.061	H(+), V(+)	1048
1024 x 768	XGA VESA 60 Hz	48.363	60.004	H(-), V(-)	1344
	XGA VESA 70 Hz	56.476	70.069	H(-), V(-)	1328
	XGA VESA 75 Hz	60.023	75.029	H(+), V(+)	1312
	XGA VESA 85 Hz	68.677	84.997	H(+), V(+)	1376
1152 x 864	SXGA VESA 70 Hz	63.995	70.016	H(+), V(+)	1472
	SXGA VESA 75 Hz	67.500	75.000	H(+), V(+)	1600
	SXGA VESA 85 Hz	77.487	85.057	H(+), V(+)	1568
1280 x 960	SXGA VESA 60 Hz	60.000	60.000	H(+), V(+)	1800
	SXGA VESA 75 Hz	75.000	75.000	H(+), V(+)	1680
1280 x 1024	SXGA VESA 60 Hz	63.981	60.020	H(+), V(+)	1688

HDTV Preset Signals

Preset Signals	Horizontal Frequency (kHz)	Vertical Frequency (Hz)
480i	15.8 kHz	60 Hz
480p	31.5 kHz	60 Hz
720p	45.0 kHz	60 Hz
1080i	33.8 kHz	60 Hz

Note: Specifications are subject to change without notice.

Other Information

Customer Support

For technical support or product service, see the table below or contact your reseller.

Note : You will need the product serial number.

Country/ Region	Web Site	T=Telephone F=Fax	E-mail
United States	www.viewsonic.com	T= 800 688 6688 F= 909 468 1202	service.us@viewsonic.com
Canada	www.viewsonic.com	T= 866 463 4775 F= 909 468 5814	service.ca@viewsonic.com
Latin America (Mexico/Chile)	www.viewsonic.com/la/	T= 866 323 8056 F= 909 444 5655	soporte@viewsonic.com
United Kingdom	www.viewsoniceurope.com/uk	www.viewsoniceurope.com/uk/Support/Calldesk.htm	
Europe/Middle East/ Baltic countries/ North Africa	www.viewsoniceurope.com	Contact your reseller	
Australia and New Zealand	www.viewsonic.com.au	AUS=1800 880 818 NZ=0800 008 822	service@au.viewsonic.com
Singapore/Malaysia/ Thailand	www.ap.viewsonic.com	T= 65 64616044	service@sg.viewsonic.com
South Africa/ Other countries	www.ap.viewsonic.com	T= 886 2 2246 3456 F= 886 2 2249 1751	service@sd.viewsonic.com
Hong Kong	www.hk.viewsonic.com	T= 852 3102 2900	service@hk.viewsonic.com
Macau	www.hk.viewsonic.com	T= 853 700 303	service@hk.viewsonic.com
Korea	www.kr.viewsonic.com	T= 080 265 9080	service@kr.viewsonic.com

Limited Warranty

ViewSonic® Projector

What the warranty covers:

ViewSonic warrants its products to be free from defects in material and workmanship during the warranty period. If a product proves to be defective in material or workmanship during the warranty period, ViewSonic will at its sole option repair or replace the product with a like product. Replacement product or parts may include remanufactured or refurbished parts or components.

How long the warranty is effective:

North and South America: Three (3) years warranty for all parts excluding the lamp, three (3) years for labor, and one (1) year for the original lamp from the date of the first consumer purchase. Europe except Poland: Three (3) years warranty for all parts excluding the lamp, three (3) years for labor, and ninety (90) days for the original lamp from the date of the first consumer purchase. Poland: Two (2) years warranty for all parts excluding the lamp, two (2) years for labor, and ninety (90) days for the original lamp from the date of the first consumer purchase. Other regions or countries: Please check with your local dealer or local ViewSonic office for the warranty information.

Lamp warranty subject to terms and conditions, verification and approval. Applies to manufacturer's installed lamp only. All accessory lamps purchased separately are warranted for 90 days.

Who the warranty protects:

This warranty is valid only for the first consumer purchaser.

What the warranty does not cover:

1. Any product on which the serial number has been defaced, modified or removed.
2. Damage, deterioration or malfunction resulting from:
 - a. Accident, misuse, neglect, fire, water, lightning, or other acts of nature, unauthorized product modification, or failure to follow instructions supplied with the product.
 - b. Repair or attempted repair by anyone not authorized by ViewSonic.
 - c. Any damage of the product due to shipment.
 - d. Removal or installation of the product.
 - e. Causes external to the product, such as electric power fluctuations or failure.
 - f. Use of supplies or parts not meeting ViewSonic's specifications.
 - g. Normal wear and tear.
 - h. Any other cause which does not relate to a product defect.
3. Any product exhibiting a condition commonly known as "image built-in" which results when a static image is displayed on the product for an extended period of time.
4. Removal, installation, and set-up service charges.

How to get service:

1. For information about receiving service under warranty, contact ViewSonic Customer Support. You will need to provide your product's serial number.
2. To obtain warranted service, you will be required to provide (a) the original dated sales slip, (b) your name, (c) your address, (d) a description of the problem, and (e) the serial number of the product.
3. Take or ship the product freight prepaid in the original container to an authorized ViewSonic service center or ViewSonic.
4. For additional information or the name of the nearest ViewSonic service center, contact ViewSonic.

Limitation of implied warranties:

There are no warranties, express or implied, which extend beyond the description contained herein including the implied warranty of merchantability and fitness for a particular purpose.

Exclusion of damages:

ViewSonic's liability is limited to the cost of repair or replacement of the product. ViewSonic shall not be liable for:

1. Damage to other property caused by any defects in the product, damaged based upon inconvenience, loss of use of the product, loss of time, loss of profits, loss of business opportunity, loss of goodwill, interference with business relationships, or other commercial loss, even if advised of the possibility of such damages.
2. Any other damages, whether incidental, consequential or otherwise.
3. Any claim against the customer by other party.

Effect of state law:

This warranty gives you specific legal rights, and you may also have other rights which vary from state to state. Some states do not allow limitations on implied warranties and/or do not allow the exclusion of incidental or consequential damages, so the above limitations and exclusions may not apply to you.

Sales outside the U.S.A. and Canada:

For warranty information and service on ViewSonic products sold outside of the U.S.A. and Canada, contact ViewSonic or your local ViewSonic dealer.

Warranty_Projectors Rev. Id

4.3: Projector Warranty

1 of 1

Release Date: 03-31-05



ViewSonic®