

myprojectorlamps.com

**The most trusted, dependable name
in projector lamp sales.**



<http://www.myprojectorlamps.com>



<http://www.myprojectorlamps.ca>



<http://www.myprojectorlamps.eu>

The following projector manual has not been modified or altered in any way.

ViewSonic®

PJ406D DLP Projector



- User Guide
- Guide de l'utilisateur
- Bedienungsanleitung
- Guía del usuario
- Guida dell'utente
- Guia do usuário
- Användarhandbok
- Käyttöopas
- Руководство пользователя
- 使用手冊
- 使用手冊

Compliance Information

For U.S.A.

This device complies with part 15 of the FCC Rules. Operation is subject to the following two conditions: (1) The device may not cause harmful interference, and (2) this device must accept any interference received, including interference that may cause undesired operation

This equipment has been tested and found to comply with the limits for a Class B digital device, pursuant to part 15 of the FCC Rules. These limits are designed to provide reasonable protection against harmful interference in a residential installation. This equipment generates, uses, and can radiate radio frequency energy, and if not installed and used in accordance with the instructions, may cause harmful interference to radio communications. However, there is no guarantee that interference will not occur in a particular installation. If this equipment does cause harmful interference to radio or television reception, which can be determined by turning the equipment off and on, the user is encouraged to try to correct the interference by one or more of the following measures:

- Reorient or relocate the receiving antenna.
- Increase the separation between the equipment and receiver.
- Connect the equipment into an outlet on a circuit different from that to which the receiver is connected.
- Consult the dealer or an experienced radio/TV technician for help.

FCC Warning

To assure continued FCC compliance, the user must use grounded power supply cord and the cables which are included with the equipment or specified. Also, any unauthorized changes or modifications not expressly approved by the party responsible for compliance could void the user's authority to operate this device.

For Canada

This Class B digital apparatus meets all requirements of the Canadian Interference-Causing Equipment Regulations.

Cet appareil numérique de la Classe B respecte toutes les exigences du Règlement sur le matériel brouilleur du Canada.

- This Class B digital apparatus complies with Canadian ICES-003.
- Cet appareil numérique de la classe B est conforme à la norme NMB-003 du Canada.

For European Countries

CE Conformity



The device complies with the requirements of the EEC directive 89/336/EEC as amended by 92/31/EEC and 93/68/EEC Art.5 with regard to “Electromagnetic compatibility,” and 73/23/EEC as amended by 93/68/EEC Art.13 with regard to “Safety.”

User Information for all Countries

Notice: Use the cables which are included with the unit or specified.

Important Safety Instructions

1. Read these instructions completely before using the equipment.
2. Keep these instructions in a safe place.
3. Heed all warnings.
4. Follow all instructions.
5. Do not use this equipment near water.
6. Clean with a soft, dry cloth.
7. Do not block any ventilation openings. Install the equipment in accordance with the manufacturer's instructions.
8. Do not install near any heat sources such as radiators, heat registers, stoves, or other devices (including amplifiers) that produce heat.
9. Do not attempt to circumvent the safety provisions of the polarized or grounding-type plug. A polarized plug has two blades with one wider than the other. A grounding type plug has two blades and a third grounding prong. The wide blade and the third prong are provided for your safety. If the plug does not fit into your outlet, consult an electrician for replacement of the outlet.
10. Protect the power cord from being tread upon or pinched, particularly at the plug, and the point where it emerges from the equipment. Be sure that the power outlet is located near the equipment so that it is easily accessible.
11. Only use attachments/accessories specified by the manufacturer.
12. Use only with the cart, stand, tripod, bracket, or table specified by the manufacturer, or sold with the equipment. When a cart is used, use caution when moving the cart/equipment combination to avoid injury from tipping over.
13. Unplug this equipment when it will be unused for long periods of time.
14. Refer all servicing to qualified service personnel. Service is required when the unit has been damaged in any way, such as: if the power-supply cord or plug is damaged, if liquid is spilled onto or objects fall into the unit, if the unit is exposed to rain or moisture, or if the unit does not operate normally or has been dropped.

Copyright Information

Copyright © 2005 ViewSonic® Corporation. All rights reserved.

Apple, Mac and ADB registered trademarks of Apple Computer, Inc.

Microsoft, Windows, Windows NT, and the Windows logo are registered trademarks of Microsoft Corporation in the United States and other countries.

ViewSonic, the three birds logo and OnView are registered trademarks of ViewSonic Corporation.

VESA and SVGA are registered trademarks of the Video Electronics Standards Association.

DPMS and DDC are trademarks of VESA.

PS/2, VGA and XGA are registered trademarks of International Business Machines Corporation.

Disclaimer: ViewSonic Corporation shall not be liable for technical or editorial errors or omissions contained herein; nor for incidental or consequential damages resulting from furnishing this material, or the performance or use of this product.

In the interest of continuing product improvement, ViewSonic Corporation reserves the right to change product specifications without notice. Information in this document may change without notice.

No part of this document may be copied, reproduced, or transmitted by any means, for any purpose without prior written permission from ViewSonic Corporation.

Product Registration

To meet your future needs, and to receive any additional product information as it becomes available, please register your product on the Internet at: www.viewsonic.com. The ViewSonic Wizard CD-ROM also provides an opportunity for you to print the registration form, which you may mail or fax to ViewSonic.

For Your Records

Product Name:	PJ406D ViewSonic DLP Projector
Model Number:	VS10873
Document Number:	PJ406D-1_UG_ENG Rev. 1A 08-01-05
Serial Number:	_____
Purchase Date:	_____



The lamp in this product contains mercury.











Please dispose of in accordance with local, state or federal laws.

Table of Contents

Precautions	2
Product Features	4
Package Overview	5
Product Overview	6
<i>Main Unit</i>	6
<i>Control Panel</i>	7
<i>Connection Ports</i>	8
<i>Remote Control</i>	9
Connecting the Projector	10
Powering On/Off the Projector	11
<i>Powering On the Projector</i>	11
<i>Powering Off the projector</i>	12
<i>Warning Indicator</i>	12
Adjusting the Projected Image	13
<i>Adjusting the Projector Image Height</i>	13
<i>Adjusting the Projector Zoom / Focus</i>	14
<i>Adjusting Projected Image Size</i>	14
Control Panel & Remote Control	15
On-Screen Display Menus	17
<i>How to operate</i>	17
<i>Menu Tree</i>	18
<i>Language</i>	19
<i>Colour Setting</i>	19
<i>Image-I</i>	20
<i>Image-II</i>	22
<i>Management</i>	23
<i>Lamp Setting</i>	25
Troubleshooting	26
Replacing the lamp	30
Compatibility Modes	31
Customer Support	32
Limited Warranty	33

Precautions

Follow all warnings, precautions and maintenance as recommended in this user's guide to maximize the life of your unit.

-  **Warning-** Do not look into the projector's lens when the lamp is on. The bright light may hurt your eyes.
-  **Warning-** To reduce the risk of fire or electric shock, do not expose this product to rain or moisture.
-  **Warning-** Please do not open or disassemble the product as this may cause electric shock.
-  **Warning-** When changing the lamp, please allow unit to cool down, and follow all changing instructions.
-  **Warning-** This product will detect the life of the lamp itself. Please be sure to change the lamp when it shows warning messages.
-  **Warning-** Reset the "Lamp Reset" function from the On Screen Display "Lamp Setting" menu after replacing the lamp module (refer to page 25).
-  **Warning-** When switching the projector off, please ensure the projector completes its cooling cycle before disconnecting power.
-  **Warning-** Turn on the projector first and then the signal sources.
-  **Warning-** Do not use lens cap when projector is in operation.
-  **Warning-** When the lamp reaches the end of its life, it will burn out and may make a loud popping sound. If this happens, the projector will not turn back on until the lamp module has been replaced. To replace the lamp, follow the procedures listed under "Replacing the Lamp".

Do:

- ❖ Turn off the product before cleaning.
- ❖ Use a soft cloth moistened with mild detergent to clean the display housing.
- ❖ Disconnect the power plug from AC outlet if the product is not being used for a long period of time.

Don't:

- ❖ Block the slots and openings on the unit provided for ventilation.
- ❖ Use abrasive cleaners, waxes or solvents to clean the unit.
- ❖ Use under the following conditions:
 - In extremely hot, cold or humid environments.
 - In areas susceptible to excessive dust and dirt.
 - Near any appliance that generates a strong magnetic field.
 - Place in direct sunlight.

Product Features

This product is an SVGA single chip 0.55" DLP™ projector. Outstanding features include:

- ◆ True SVGA, 800x 600 addressable pixels
- ◆ Single chip Dark Chip2™ DLP™ technology
- ◆ NTSC/NTSC4.43/PAL/PAL-M/PAL-N/SECAM and HDTV compatible (480i/p, 576i/p, 720p, 1080i)
- ◆ Multi-Auto functions: Auto detection, Auto image and Auto saving the adjustments
- ◆ Full function remote
- ◆ User friendly multilingual on screen display menu
- ◆ Advanced digital keystone correction and high quality full screen image re-scaling
- ◆ User friendly control panel
- ◆ Built-in speaker with 2Watt
- ◆ SXGA, XGA compression and VGA re-sizing
- ◆ Mac compatible

Package Overview

This projector comes with all the items shown below. Check to make sure your unit is complete. Contact your dealer immediately if anything is missing.

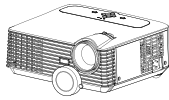

Projector with lens cap



Power Cord



VGA Cable 1.8m



Composite Video Cable

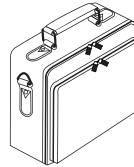

Soft Case

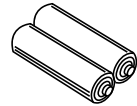

2 x Batteries



❖ Due to the difference in applications for each country, some regions may have different accessories.



Quick Start Guide



ViewSonic Wizard CD



Remote Control

Product Overview

Main Unit

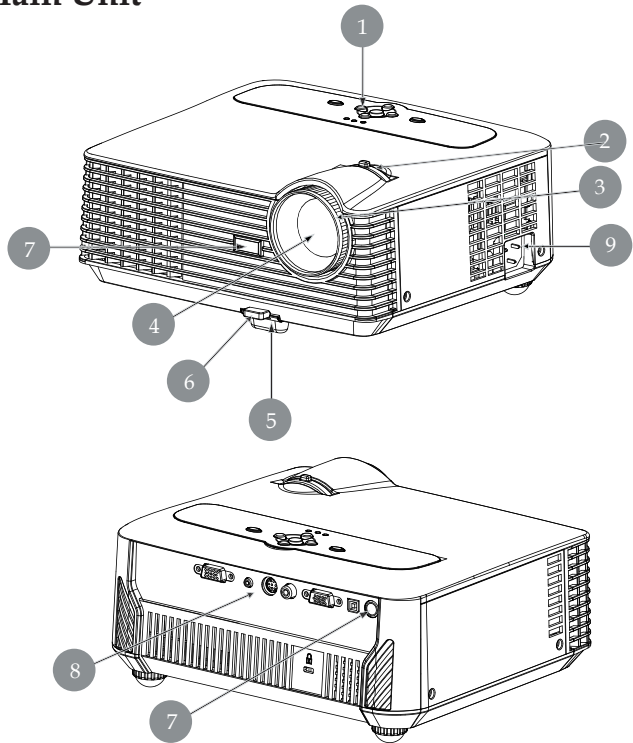

-
1. Control Panel
 2. Zoom Lever
 3. Focus Ring
 4. Zoom Lens
 5. Elevator Foot
 6. Elevator Button
 7. IR Receivers
 8. Connection Ports
 9. Power Socket
-

Control Panel

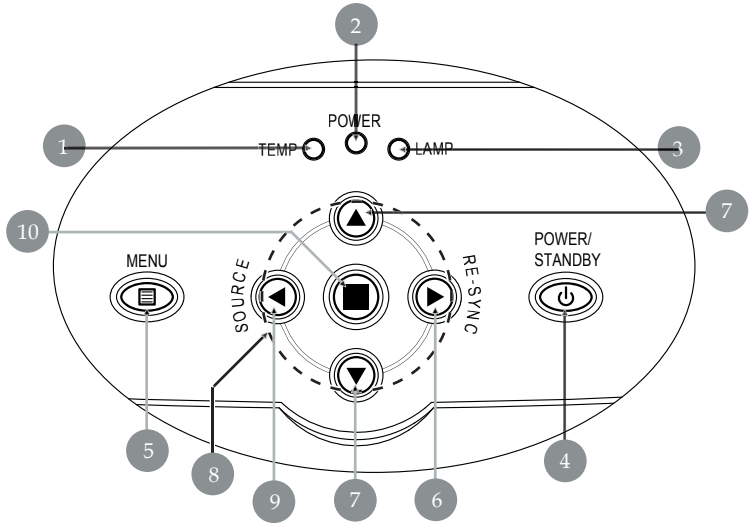

1. Temp Indicator LED
2. Power Indicator LED
3. Lamp Indicator LED
4. Power/Standby
5. Menu (On/Off)
6. Re-Sync
7. Keystone Correction
8. Four Directional Select Keys
9. Source
10. Enter

Connection Ports

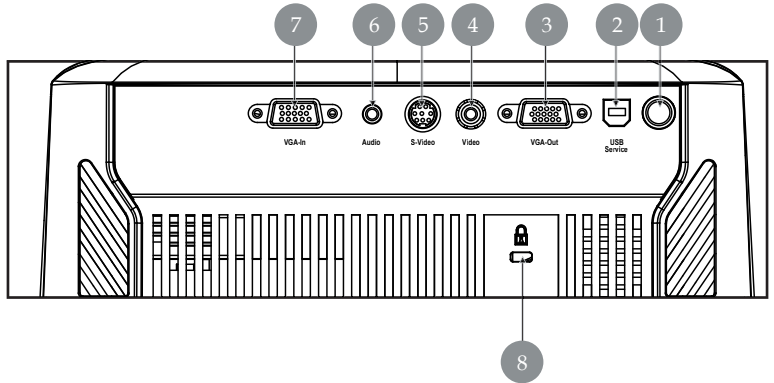

1. IR Receiver
2. USB Connector (service only)
3. Monitor Loop-through Output Connector
4. Composite Video Input Connector
5. S-Video Input Connector
6. Audio Input Connector
7. PC Analog signal/SCART RGB/HDTV/Component Video Input Connector
8. Kensington™ Lock Port

Remote Control

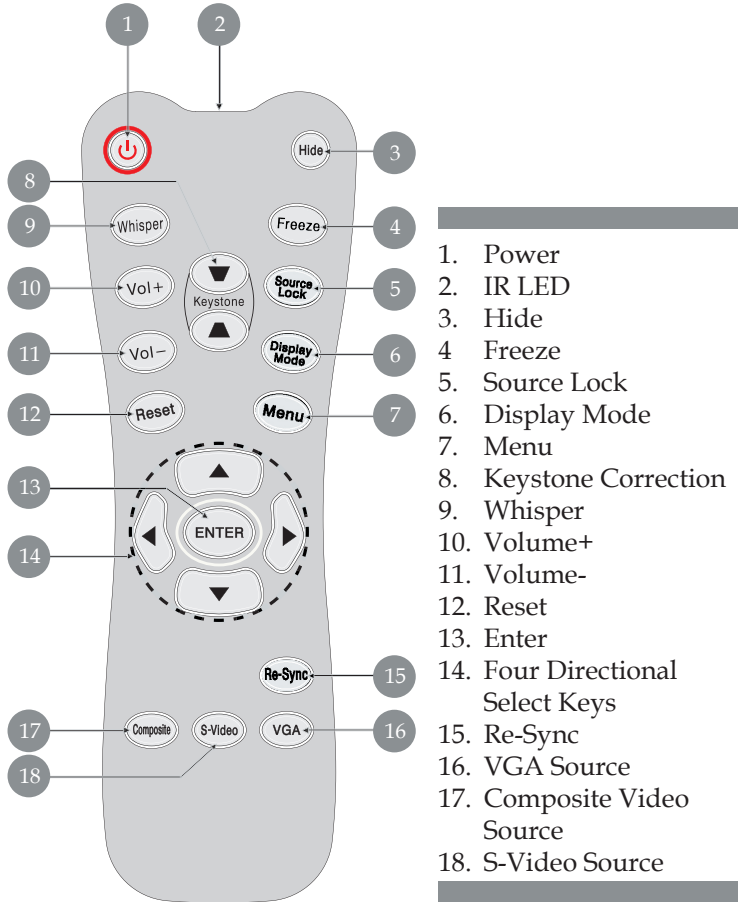

1. Power
2. IR LED
3. Hide
4. Freeze
5. Source Lock
6. Display Mode
7. Menu
8. Keystone Correction
9. Whisper
10. Volume+
11. Volume-
12. Reset
13. Enter
14. Four Directional Select Keys
15. Re-Sync
16. VGA Source
17. Composite Video Source
18. S-Video Source

Connecting the Projector

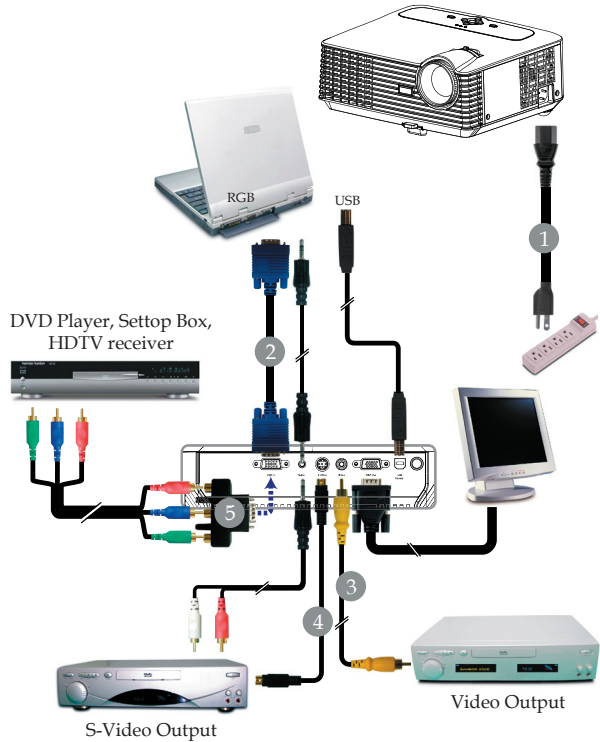

❖ Due to the difference in applications for each country, some regions may have different accessories.

- | | |
|---------|--|
| 1. | Power Cord |
| 2. | VGA Cable |
| 3. | Composite Video Cable |
| 4. | S-Video Cable (Optional Accessory) |
| 5. | D-15 to RCA Adapter for YPbPr (Optional Accessory) |

❖ *To ensure the projector works well with your computer, please set the display mode of your graphic card less than or equal to 1280 X 1024 resolution. Make sure the timing of the display mode is compatible with the projector. Refer to the "Compatibility Modes" section in User Guide.*

Powering On/Off the Projector

Powering On the Projector

1. Remove the lens cap. ❶
 2. Ensure that the power cord and signal cable are securely connected. The Power LED will turn Orange.
 3. Turn on the lamp by pressing “Power/Standby” button on the control panel. ❷
The startup screen will display for 10 seconds and the Power LED will turn green.
 4. Turn on your source (computer, notebook, video player, etc.). The projector will detect your source automatically.
- ❖ *If you connect multiple sources at the same time, use the “Source” button on the control panel or remote control to switch.*



❖ Turn on the projector first and then the signal sources.

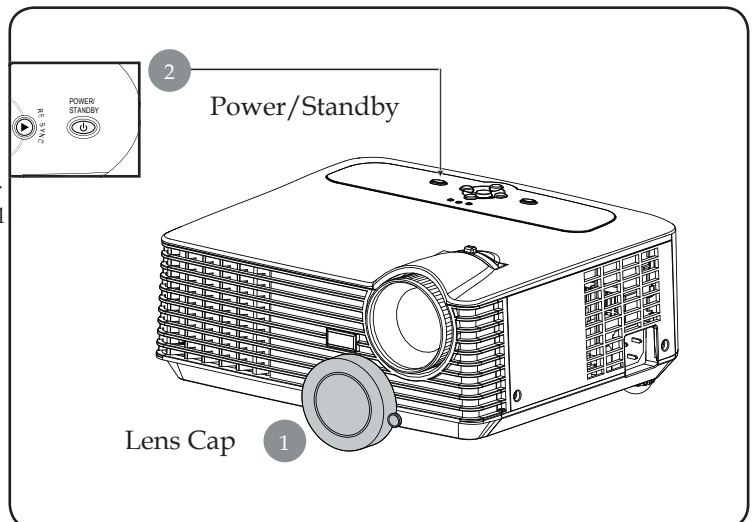

Powering Off the Projector

1. Press the “Power/Standby” button to turn off the projector lamp, you will see a message as below on the on-screen display.

Wait 1 minutes before you can switch on again.

Press Power key again to confirm.

Press "Enter" key to remove this warning.

2. Press the “Power/Standby” button again to confirm.
3. The cooling fans continue to operate for about 30 seconds for cooling cycle and the Power LED will flash orange. When the light stops flashing, the projector has entered standby mode.

If you wish to turn the projector back on, you must wait until the projector has completed the cooling cycle and has entered standby mode. Once in standby mode, simply press “Power/Standby” button to restart the projector.

4. Disconnect the power cord from the electrical outlet and the projector.
5. Do not turn on the projector immediately following a power off procedure.

Warning Indicator

- ❖ *When the “TEMP” indicator turns red, it indicates the projector has overheated. The projector will automatically shut itself down.*
- ❖ *When the “LAMP” indicator turns **red**, it indicates a problem with the lamp. Turn off the projector and disconnect the power cord from the electrical outlet, then contact your local dealer or our service center.*
- ❖ *When the “LAMP” indicator flashes **red (1 second intervals)**, it indicates the fan failed. Stop using the projector and disconnect the power cord from the electrical outlet, then contact your local dealer or our service center.*

Adjusting the Projected Image

Adjusting the Projector Image Height

The projector is equipped with an elevator foot for adjusting the image height.

To raise the image:

1. Press the elevator button **1**.
2. Raise the image to the desired height angle **2**, then release the button to lock the elevator foot into position.
3. Use **3** to fine-tune the display angle.

To lower the image:

1. Press the elevator button.
2. Lower the image, then release the button to lock the elevator foot into position.
3. Use **3** to fine-tune the display angle.

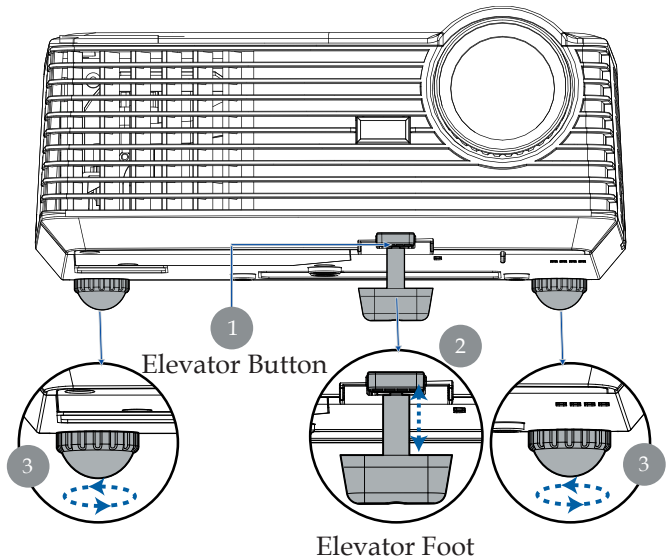

Adjusting the Projector Zoom / Focus

You may turn the zoom lever to zoom in or out. To focus the image, rotate the focus ring until the image is clear. The projector will focus at distances from 4.9 to 32.8 feet (1.5 to 10.0 meters).

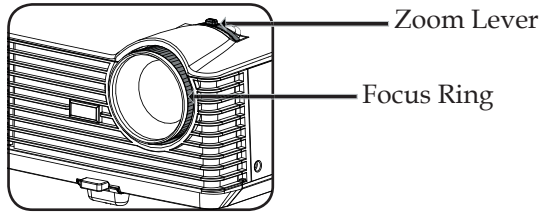

Adjusting Projection Image Size

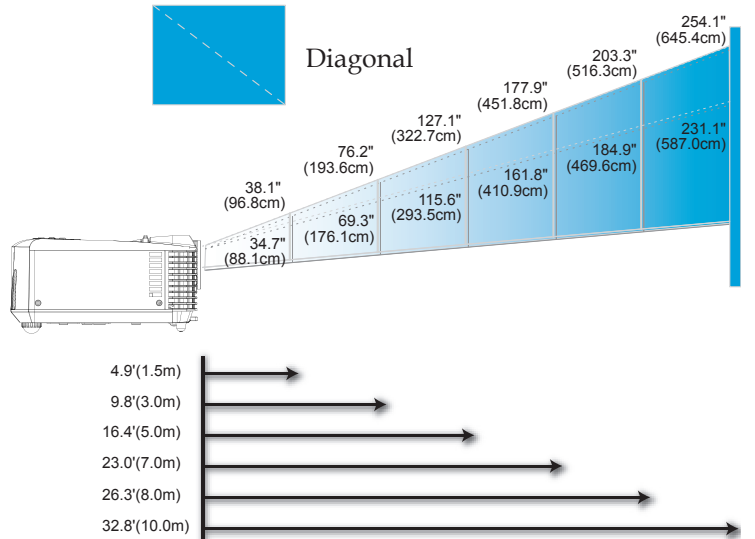

Screen (Diagonal)	Max.	38.1" (96.8cm)	76.2" (193.6cm)	127.1" (322.7cm)	177.9" (451.8cm)	203.3" (516.3cm)	254.1" (645.4cm)
	Min.	34.7" (88.1cm)	69.3" (176.1cm)	115.6" (293.5cm)	161.8" (410.9cm)	184.9" (469.6cm)	231.1" (587.0cm)
Screen Size	Max. (WxH)	30.5" x 22.9" (77.4 x 58.1cm)	61.0" x 45.7" (154.9 x 116.2cm)	101.7" x 76.3" (258.2 x 193.6cm)	142.3" x 106.7" (361.4 x 271.1cm)	162.6" x 122.0" (413.0 x 309.8cm)	203.3" x 152.5" (516.3 x 387.2cm)
	Min. (WxH)	27.8" x 20.8" (70.5 x 52.9cm)	55.4" x 41.6" (140.9 x 105.7cm)	92.5" x 69.4" (234.8 x 176.1cm)	129.4" x 97.1" (328.7 x 246.5cm)	147.9" x 110.9" (375.7 x 281.8cm)	184.9" x 138.7" (469.6 x 352.2cm)
Distance		4.9'(1.5m)	9.8'(3.0m)	16.4'(5.0m)	23.0'(7.0m)	26.3'(8.0m)	32.8'(10.0m)

❖ This graph is for user's reference only.

Control Panel & Remote Control

There are two ways for you to control the functions: Remote Control and Control Panel.

Control Panel

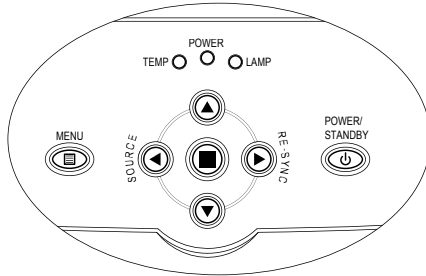

Remote Control



Using the Control Panel

Power/Standby

- ▶ Refer to the “Power On/Off the Projector” section on pages 11-12.

Source

- ▶ Press “Source” to choose RGB, Component-p, Component-i, S-Video, Composite Video and HDTV sources.





Menu

- ▶ Press “Menu” to launch the on screen display (OSD) menu. To exit OSD, press “Menu” again.

Keystone

- ▶ Adjusts image distortion caused by tilting the projector (± 15 degrees).

Four Directional Select Keys

- ▶ Use     to select items or make adjustments to your selection.

Enter

- ▶ Confirm your selection of items.

Re-Sync

- ▶ Automatically synchronizes the projector to the input source.

Using the Remote Control

Power

- Refer to the “Power On/Off the Projector” section on pages 11-12.

Whisper

- Using the button to turn on/off the whisper mode when whisper mode is on, acoustic noise and screen brightness are reduced.

Volume +/- (Vol+/Vol-)

- Increase/decrease speaker volume.

Reset

- Changes the adjustments and settings to the factory default value.

Keystone ▼ / ▲

- Adjusts image distortion caused by tilting the projector (±15 degrees).

Hide

- “Hide” immediately turns the screen black. Press “Hide” again to restore the displayed image.

Freeze

- Press “Freeze” to pause the screen image.

Source Lock

- Select auto detection all connector ports or lock current connector port.

Display Mode

- Select the Display mode from PC, Movie, Game, sRGB and User.

Menu

- Press “Menu” to launch the on screen display menu. To exit OSD, press “Menu” again.

Four Directional Select Keys

- Use ▲ ▼ ◀ ▶ to select items or make adjustments to your selection.

Enter

- Confirm your selection of items.

Re-Sync

- Automatically synchronizes the projector to the input source.

Composite

- Press “Composite” to choose Composite video source.

S-Video

- Press “S-video” to choose S-video source.

VGA

- Press “VGA” to choose VGA connector.

On Screen Display Menus

The Projector has multilingual On Screen Display menus that allow you to make image adjustments and change a variety of settings. The projector will automatically detect the source.

How to operate

1. To open the OSD menu, press “Menu (≡)” on the Remote Control or Control Panel.
2. When OSD is displayed, use ◀ ▶ keys to select any item in the main menu. While making a selection on a particular page, press ▼ or “Enter” key to enter sub menu.
3. Use ▲ ▼ keys to select the desired item and adjust the settings by ◀ ▶ key.
4. Select the next item to be adjusted in the sub menu and adjust as described above.
5. Press “Menu (≡)” to confirm, and the screen will return to the main menu.
6. To exit, press “Menu (≡)” again. The OSD menu will close and the projector will automatically save the new settings.

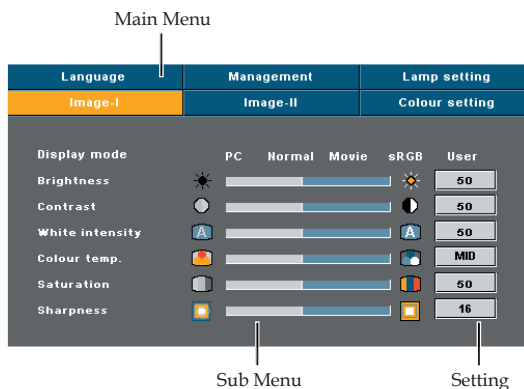

Menu Tree

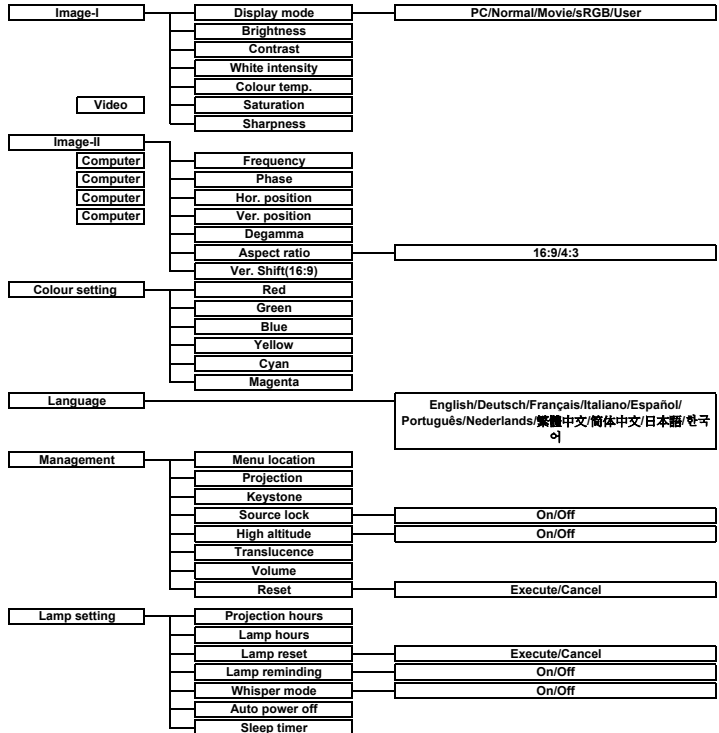

Image-I	Image-II	Colour setting
Language	Management	Lamp setting
English	Nederlands	
Français	简体中文	
Deutsch	繁體中文	
Italiano	日本語	
Español	한국어	
Português		

Language

Language

Choose the multilingual OSD menu . Use the ▲ or ▼ key to select your preferred language.

Press “Enter” to finalize the selection.

Language	Management	Lamp setting
Image-I	Image-II	Colour setting
Red	→	50
Green	→	50
Blue	→	50
Yellow	→	50
Cyan	→	50
Magenta	→	50

Colour Setting

Colour Setting

Adjust the Red, Green, Blue, Yellow, Cyan and Magenta colors for advanced adjustment of the individual colors.

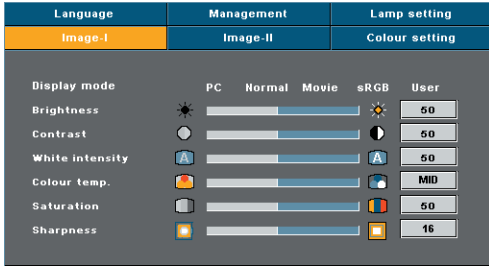

Image-I

Display Mode

There are many factory presets optimized for various types of images.

- ▶ PC: For computer or notebook.
- ▶ Movie: For home theater.
- ▶ Normal: For normal viewing condition.
- ▶ sRGB: For standard color.
- ▶ User: Memorize user's settings.

Brightness

Adjust the brightness of the image.

- ▶ Press the ◀ to darken image.
- ▶ Press the ▶ to lighten the image.

Contrast

The contrast controls the degree of difference between the lightest and darkest parts of the picture. Adjusting the contrast changes the amount of black and white in the image.

- ▶ Press the ◀ to decrease the contrast.
- ▶ Press the ▶ to increase the contrast.

White Intensity

Use the white peaking control to set the white peaking level of DMD chip. 0 stands for minimal peaking, and 10 stands for maximum peaking. If you prefer a stronger image, adjust towards the maximum setting. For a smooth and more natural image, adjust towards the minimum setting.

Color Temp.

Adjust the color temperature. At higher temperature, the screen looks colder; at lower temperature, the screen looks warmer.



❖ “Saturation” function is not supported under computer mode.

Saturation

Adjusts a video image from black and white to fully saturated color.

- ▶ Press the ◀ to decrease the amount of color in the image.
- ▶ Press the ▶ to increase the amount of color in the image.

Sharpness

Adjusts the sharpness of the image.

- ▶ Press the ◀ to decrease the sharpness.
- ▶ Press the ▶ to increase the sharpness.



Image-II

Frequency

“Frequency” changes the display data frequency to match the frequency of your computer’s graphic card. If you experience a vertical flickering bar, use this function to make an adjustment.

Phase

“Phase” synchronizes the signal timing of the display with the graphic card. If you experience an unstable or flickering image, use this function to correct it.

Hor. Position (Horizontal Position)

- ▶ Press the ◀ to move the image left.
- ▶ Press the ▶ to move the image right.

Ver. Position (Vertical Position)

- ▶ Press the ◀ to move the image down.
- ▶ Press the ▶ to move the image up.

Degamma

This allows you to choose a degamma table that has been fine-tuned to bring out the best image quality for the input.

Aspect Ratio

Use this function to choose your desired aspect ratio.

- ▶ 4:3 : The input source will be scaled to fit the projection screen.
- ▶ 16:9 : The input source will be scaled to fit the screen width.

Ver. Shift (16:9)

Adjust the image position to up or down, when you select the aspect ratio to 16:9.

- ▶ Press the ◀ to move the image down.
- ▶ Press the ▶ to move the image up.



❖ “Frequency/Phase/ Hor. Position/Ver. position” function is not supported under video mode.

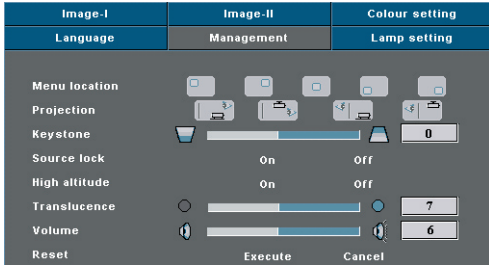

Management

Menu Location

Choose the menu location on the display screen.

Projection

- ▶  Front-Desktop

The factory default setting.

- ▶  Rear-Desktop

When you select this function, the projector reverses the image so you can project behind a translucent screen.

- ▶  Front-Ceiling

When you select this function, the projector turns the image upside down for ceiling-mounted projection.

- ▶  Rear-Ceiling

When you select this function, the projector reverses and turns the image upside down at same time. You can project from behind a translucent screen with ceiling mounted projection.

Keystone

Correct image distortion caused by tilting the projector vertically.

Source Lock

When this function is turned off, the projector will search for other signals if the current input signal is lost. When this function is turned on, it will search specified connection port.

High Altitude

Choose "On" to turn on High Altitude mode. Operates the fans at full speed continuously to allow for proper high altitude cooling of the projector.

Translucence

Choose the menu transparency on the display screen.

Volume

- ▶ Press the ◀ to decrease the volume.
- ▶ Press the ▶ to increase the volume.

Reset

Return the adjustments and settings to the factory default values.

- ▶ Execute: Returns the settings for all menus to factory default values.
- ▶ Cancel: Cancel the revised settings

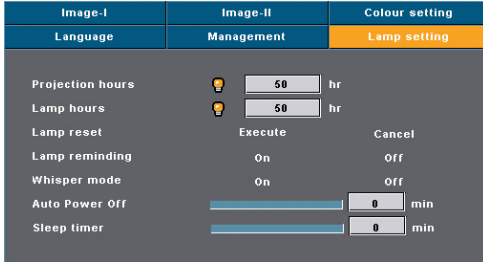

Lamp Setting

Projection Hours

Display the projection time.

Lamp Hours

Display the cumulative lamp operating time.

Lamp Reset

Reset the lamp life hour after replacing a new lamp.

Lamp Reminding

Choose this function to show or to hide the warning message when the changing lamp message is displayed. The message will show up 30 hours before end of life.

Whisper Mode

Choose "On" to dim the projector lamp which will lower power consumption and extend the lamp life by up to 130%. Choose "Off" to return to normal mode.

Auto Power Off

Sets the interval of power-off of the system, if there is no signal input. (In minutes)

Sleep Timer

Sets the interval of power-off of the system, if there is no signal input. (In minutes)

Troubleshooting

If you experience trouble with the projector, refer to the following information. If the problem persists, please contact your local reseller or service center.

Problem: No image appears on screen.

- ▶ Ensure all the cables and power connections are correctly and securely connected as described in the “Installation” section.
- ▶ Ensure the pins of connectors are not crooked or broken.
- ▶ Check if the projection lamp has been securely installed. Please refer to the “Replacing the lamp” section.
- ▶ Make sure you have removed the lens cap and the projector is switched on.
- ▶ Ensure that the “Hide” feature is not turned on.

Problem: Partial, scrolling or incorrectly displayed image.

- ▶ Press “Re- sync” on the Remote Control or on the Control Panel.
- ▶ If you are using a PC:

For Windows 3.x:

1. In the Windows Program Manager, double click the “Windows Setup” icon in the Main group.
2. Verify that your display resolution setting is less than or equal to 1280 x 1024.

For Windows 95, 98, 2000, XP:

1. From the “My Computer” icon, open the “Control Panel” folder, and double click the “Display” icon.
2. Select the “Settings” tab
3. Click on the “Advanced Properties” button.

If the projector is still not projecting the whole image, you will also need to change the monitor display you are using. Refer to the following steps.

4. Verify the resolution setting is less than or equal to 1280 x 1024 resolution.
 5. Select the "Change" button under the "Monitor" tab .
 6. Click on "Show all devices." Next, select "Standard monitor types" under the SP box; choose the resolution mode you need under the "Models" box.
- ▶ If you are using a Notebook:
1. First, follow the steps above to adjust resolution of the computer.
 2. Press the toggle output settings. example:[Fn]+[F4]

Compaq=>	[Fn]+[F4]	Hewlett	=>	[Fn]+[F4]
Dell =>	[Fn]+[F8]	Packard	=>	[Fn]+[F4]
Gateway=>	[Fn]+[F4]	NEC=>	[Fn]+[F3]	
IBM=>	[Fn]+[F7]	Toshiba =>	[Fn]+[F5]	
<hr/>				
Mac Apple: System Preference-->Display-->Arrangement-->Mirror display				

- ▶ If you experience difficulty changing resolutions or your monitor freezes, restart all equipment including the projector.

Problem: The screen of the Notebook or PowerBook computer is not displaying a presentation.

- ▶ If you are using a Notebook PC:
Some Notebook PCs may deactivate their own screens when a second display device is in use. Each has a different way to be reactivated. Refer to your computer's documentation for detailed information.

Problem: Image is unstable or flickering

- ▶ Use "Phase" to correct it. Refer to page 22.
▶ Change the monitor color setting from your computer.

Problem: Image has vertical flickering bar

- ▶ Use "Frequency" to make an adjustment. Refer to page 22.
▶ Check and reconfigure the display mode of your graphic card to make it compatible with the product.

Problem: Image is out of focus

- ▶ Adjusts the Focus Ring on the projector lens. Refer to page 14.
- ▶ Make sure the projection screen is between the required distance 4.9 to 32.8 feet (1.5 to 10.0 meters) from the projector.

Problem: The image is stretched when displaying 16:9 DVD.

The projector automatically detects 16:9 DVD and adjusts the aspect ratio by digitizing to full screen with 4:3 default setting.

If the image is still stretched, you will also need to adjust the aspect ratio by referring to the following:

- ▶ Please select 4:3 aspect ratio type on your DVD player if you are playing a 16:9 DVD.
- ▶ If you can't select 4:3 aspect ratio type on your DVD player, please select 4:3 aspect ratio in the on screen menu.

Problem: Image is reversed.

- ▶ Select "Management-->Projection" from the OSD and adjust the projection direction. See page 23.

Problem: Lamp burns out or makes a popping sound

- ▶ When the lamp reaches its end of life, it will burn out and may make a loud popping sound. If this happens, the projector will not turn on until the lamp module has been replaced. To replace the lamp, follow the procedures in the "Replacing the Lamp". See page 30.

Problem: LED lighting message

Message	Power LED		Temp LED	Lamp LED
	Green	Orange		
Standby State (Input power cord)	○	☀	○	○
Normal Mode	☀	○	○	○
Warming	Flashing	○	○	○
Cooling	○	Flashing	○	○
Error (Lamp failed)	○	○	○	Flashing
Error (Fan failed)	○	○	○	Flashing
Error (Over Temp.)	○	○	☀	○
Error (Lamp cover failed)	○	○	○	☀



Steady light => ☀
No light => ○

Problem: Message Reminders

▶ Standby :

Wait 1 minutes before you can switch on again.

Press Power key again to confirm.

Press "Enter" key to remove this warning.

▶ Replacing the lamp :

Lamp life exceeded.

▶ Fan failed :



▶ Over temperature :

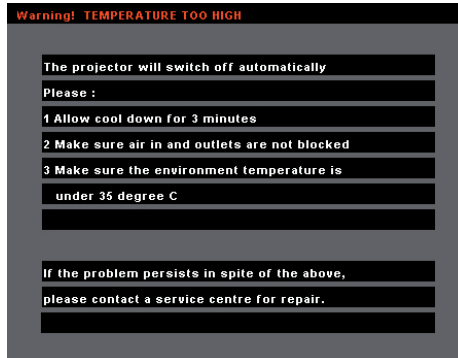

▶ Lamp life exceeded :



Replacing the lamp

The projector will detect the lamp life itself. It will show you a warning message “Lamp life exceeded” When you see this message, change the lamp as soon as possible.

Make sure the projector has been cooled down for at least 30 minutes before changing the lamp.



Warning: Lamp compartment is hot! Allow it to cool down before changing lamp!

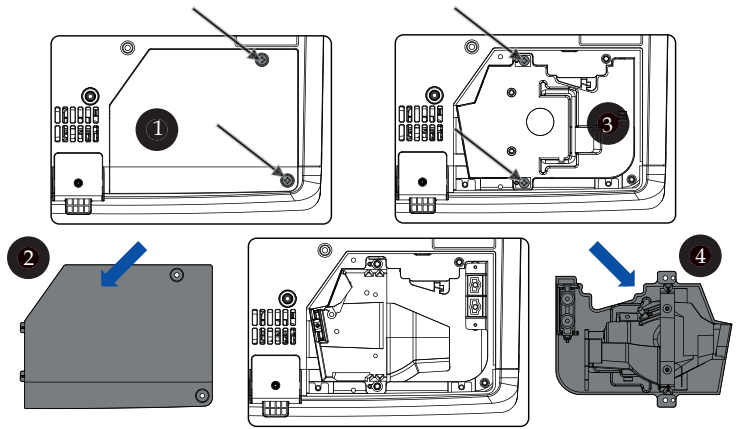

Warning: To reduce the risk of personal injury, do not drop the lamp module or touch the lamp bulb. The bulb may shatter and cause injury if it is dropped.

Lamp Replacing Procedure:

1. Switch off the power to the projector by pressing the Power button.
2. Allow the projector to cool down at least 30 minutes.
3. Disconnect the power cord.
4. Use a screwdriver to remove the screw from the cover. ❶
5. Push up and remove the cover. ❷
6. Remove the 2 screws from the lamp module. ❸
7. Pull out the lamp module. ❹

To replace the lamp module, reverse the previous steps.

Compatibility Modes

Mode	Resolution	(ANALOG)	
		V.Frequency (Hz)	H.Frequency (kHz)
VESA VGA	640 x 350	70	31.5
VESA VGA	640 x 350	85	37.9
VESA VGA	640 x 480	60	31.5
VESA VGA	640 x 480	75	37.5
VESA VGA	640 x 480	85	43.3
VESA VGA	720 x 400	70	31.5
VESA VGA	720 x 400	85	37.9
VESA SVGA	800 x 600	60	37.9
VESA SVGA	800 x 600	72	48.1
VESA SVGA	800 x 600	75	46.9
VESA SVGA	800 x 600	85	53.7
VESA XGA	1024 x 768	60	48.4
VESA XGA	1024 x 768	70	56.5
VESA XGA	1024 x 768	75	60.0
VESA XGA	1024 x 768	85	68.7
VESA SXGA	1152 x 864	70	63.8
VESA SXGA	1152 x 864	75	67.5
VESA SXGA	1280 x 1024	60	63.98
VESA SXGA	1280 x 1024	75	80
MAC II 13"	640 x 480	66.68	35
MAC 16"	832 x 624	74.55	49.725
MAC 19"	1024 x 768	75	60.24
Other	1152 x 864	85	77.1
Other	1152 x 870	75	68.49



Remark :

- 1.> “*”compressed computer image.
- 2.> The interlaced analog signals are not supported.

Customer Support

For technical support or product service, see the table below or contact your reseller.

NOTE: You will need the product serial number.

Country/Region	Web site	T = Telephone F = FAX	Email
United States	www.viewsonic.com/support/	T= (800) 688-6688 F= (909) 468 1202	service.us@ viewsonic.com
Canada	www.viewsonic.com/support/	T= (866) 463 4775	service.ca@ viewsonic.com
United Kingdom	www.viewsoniceurope.com/uk	T= 0207 949 0307	service.eu@ viewsoniceurope.com
Europe/Middle East/Baltic countries/North Africa	www.viewsoniceurope.com	Contact your reseller	service.eu@ viewsoniceurope.com
Australia and New Zealand (VSAU)	www.viewsonic.com.au/support/	AUS= 1800 880 818 NZ= 0800 008 822	service@au. viewsonic.com
Singapore/Malaysia/Thailand (VSSG)	www.viewsonic.com.sg/support/	T= (65) 6273 4018 F= (65) 6273 1566	service@sg. viewsonic.com
South Africa/Other countries	www.viewsonic.com	T= +886 (2) 2246-3456 F= +886 (2) 2249 1751	service@sd. viewsonic.com
Taiwan (VSTW)	www.viewsonic.com.tw/support/	T= +886 (2) 2246 3456 F= +886 (2) 2249 1751 Toll Free= 0800 061 198	service@tw. viewsonic.com
China (VSCN)	www.viewsonic.com.cn/	T= 800 820 3870	service.cn@cn. viewsonic.com
Japan (VSJP)	www.viewsonicjapan.co.jp/support/	T= +81 0120 341 329 F= +81 025 521 5107	service@jp. viewsonic.com
Hong Kong (VSHK)	www.hk.viewsonic.com/support/	T= +852 310 22 900	service@hk. viewsonic.com
Macau		T= +853 700 303	
Korea	www.viewsonic.com	Toll Free= 080 333 2131	service@kr. viewsonic.com
Other Asia Pacific (VSSD)	www.viewsonic.com	T= +886 (2) 2246 3456 F= +886 (2) 2249 1751	service@sd. viewsonic.com

LIMITED WARRANTY

VIEWSONIC® PROJECTOR

What the warranty covers:

ViewSonic warrants its products to be free from defects in material and workmanship during the warranty period. If a product proves to be defective in material or workmanship during the warranty period, ViewSonic will at its sole option repair or replace the product with a like product. Replacement product or parts may include remanufactured or refurbished parts or components.

How long the warranty is effective:

North and South America: Three (3) years warranty for all parts excluding the lamp, three (3) years for labor, and one (1) year for the original lamp from the date of the first consumer purchase. Europe except Poland: Three (3) years warranty for all parts excluding the lamp, three (3) years for labor, and ninety (90) days for the original lamp from the date of the first consumer purchase. Poland: Two (2) years warranty for all parts excluding the lamp, two (2) years for labor, and ninety (90) days for the original lamp from the date of the first consumer purchase. Other regions or countries: Please check with your local dealer or local ViewSonic office for the warranty information.

Lamp warranty subject to terms and conditions, verification and approval. Applies to manufacturer's installed lamp only. All accessory lamps purchased separately are warranted for 90 days.

Who the warranty protects:

This warranty is valid only for the first consumer purchaser.

What the warranty does not cover:

1. Any product on which the serial number has been defaced, modified or removed.
2. Damage, deterioration or malfunction resulting from:
 - a. Accident, misuse, neglect, fire, water, lightning, or other acts of nature, unauthorized product modification, or failure to follow instructions supplied with the product.
 - b. Repair or attempted repair by anyone not authorized by ViewSonic.
 - c. Any damage of the product due to shipment.
 - d. Removal or installation of the product.
 - e. Causes external to the product, such as electric power fluctuations or failure.
 - f. Use of supplies or parts not meeting ViewSonic's specifications.
 - g. Normal wear and tear.
 - h. Any other cause which does not relate to a product defect.
3. Any product exhibiting a condition commonly known as "image built-in" which results when a static image is displayed on the product for an extended period of time.
4. Removal, installation, and set-up service charges.

How to get service:

1. For information about receiving service under warranty, contact ViewSonic Customer Support. You will need to provide your product's serial number.
2. To obtain warranted service, you will be required to provide (a) the original dated sales slip, (b) your name, (c) your address, (d) a description of the problem, and (e) the serial number of the product.
3. Take or ship the product freight prepaid in the original container to an authorized ViewSonic service center or ViewSonic.
4. For additional information or the name of the nearest ViewSonic service center, contact ViewSonic.

Limitation of implied warranties:

There are no warranties, express or implied, which extend beyond the description contained herein including the implied warranty of merchantability and fitness for a particular purpose.

Exclusion of damages:

ViewSonic's liability is limited to the cost of repair or replacement of the product. ViewSonic shall not be liable for:

1. Damage to other property caused by any defects in the product, damaged based upon inconvenience, loss of use of the product, loss of time, loss of profits, loss of business opportunity, loss of goodwill, interference with business relationships, or other commercial loss, even if advised of the possibility of such damages.
2. Any other damages, whether incidental, consequential or otherwise.
3. Any claim against the customer by other party.

Effect of state law:

This warranty gives you specific legal rights, and you may also have other rights which vary from state to state. Some states do not allow limitations on implied warranties and/or do not allow the exclusion of incidental or consequential damages, so the above limitations and exclusions may not apply to you.

Sales outside the U.S.A. and Canada:

For warranty information and service on ViewSonic products sold outside of the U.S.A. and Canada, contact ViewSonic or your local ViewSonic dealer.

