

myprojectorlamps.com

**The most trusted, dependable name
in projector lamp sales.**



<http://www.myprojectorlamps.com>



<http://www.myprojectorlamps.ca>



<http://www.myprojectorlamps.eu>

The following projector manual has not been modified or altered in any way.

ViewSonic®

PJ358 LCD Projector



ViewSonic®

- User Guide
- Guide de l'utilisateur
- Bedienungsanleitung
- Guía del usuario
- Guida dell'utente
- Guia do usuário
- Användarhandbok
- Käyttöopas
- Руководство пользователя
- 使用手冊 (繁體)
- 使用手冊 (简体)

Model No. : VS11611

Compliance Information

For U.S.A.

This device complies with part 15 of FCC Rules. Operation is subject to the following two conditions: (1) this device may not cause harmful interference, and (2) this device must accept any interference received, including interference that may cause undesired operation. This equipment has been tested and found to comply with the limits for a Class B digital device, pursuant to part 15 of the FCC Rules. These limits are designed to provide reasonable protection against harmful interference in a residential installation. This equipment generates, uses, and can radiate radio frequency energy, and if not installed and used in accordance with the instructions, may cause harmful interference to radio communications. However, there is no guarantee that interference will not occur in a particular installation. If this equipment does cause harmful interference to radio or television reception, which can be determined by turning the equipment off and on, the user is encouraged to try to correct the interference by one or more of the following measures:

- Reorient or relocate the receiving antenna.
- Increase the separation between the equipment and receiver.
- Connect the equipment into an outlet on a circuit different from that to which the receiver is connected.
- Consult the dealer or an experienced radio/TV technician for help.

Warning: You are cautioned that changes or modifications not expressly approved by the party responsible for compliance could void your authority to operate the equipment.

For Canada

- This Class B digital apparatus complies with Canadian ICES-003.
- Cet appareil numérique de la classe B est conforme à la norme NMB-003 du Canada.

CE Conformity for European Countries

 The device complies with the requirements of the EEC directive 89/336/EEC as amended by 92/31/EEC and 93/68/EEC Art.5 with regard to “Electromagnetic compatibility”, and 73/23/EEC as amended by 93/68/EEC Art.13 with regard to “Safety.”

Following information is only for EU-member states:

The mark shown to the right is in compliance with the Waste Electrical and Electronic Equipment Directive 2002/96/EC (WEEE).

The mark indicates the requirement NOT to dispose the equipment as unsorted municipal waste, but use the return and collection systems according to local law.



Important Safety Instructions

1. Read these instructions completely before using the equipment.
2. Keep these instructions in a safe place.
3. Heed all warnings.
4. Follow all instructions.
5. Do not use this equipment near water. Warning: To reduce the risk of fire or electric shock, do not expose this apparatus to rain or moisture.
6. Clean with a soft, dry cloth. If further cleaning is required, see “Cleaning the Display” in this guide for further instructions.
7. Do not block any ventilation openings. Install the equipment in accordance with the manufacturer’s instructions.
8. Do not install near any heat sources such as radiators, heat registers, stoves, or other devices (including amplifiers) that produce heat.
9. Do not attempt to circumvent the safety provisions of the polarized or grounding-type plug. A polarized plug has two blades with one wider than the other. A grounding type plug has two blades and a third grounding prong. The wide blade and the third prong are provided for your safety. If the plug does not fit into your outlet, consult an electrician for replacement of the outlet.
10. Protect the power cord from being tread upon or pinched, particularly at the plug, and the point where it emerges from the equipment. Be sure that the power outlet is located near the equipment so that it is easily accessible.
11. Only use attachments/accessories specified by the manufacturer.
12. Use only with the cart, stand, tripod, bracket, or table specified by the manufacturer, or sold with the equipment. When a cart is used, use caution when moving the cart/equipment combination to avoid injury from tipping over.
13. Unplug this equipment when it will be unused for long periods of time.
14. Refer all servicing to qualified service personnel. Service is required when the unit has been damaged in any way, such as: if the power-supply cord or plug is damaged, if liquid is spilled onto or objects fall into the unit, if the unit is exposed to rain or moisture, or if the unit does not operate normally or has been dropped.



Declaration of RoHS Compliance

This product has been designed and manufactured in compliance with Directive 2002/95/EC of the European Parliament and the Council on restriction of the use of certain hazardous substances in electrical and electronic equipment (RoHS Directive) and is deemed to comply with the maximum concentration values issued by the European Technical Adaptation Committee (TAC) as shown below:

Substance	Proposed Maximum Concentration	Actual Concentration
Lead (Pb)	0.1%	< 0.1%
Mercury (Hg)	0.1%	< 0.1%
Cadmium (Cd)	0.01%	< 0.01%
Hexavalent Chromium (Cr ⁶⁺)	0.1%	< 0.1%
Polybrominated biphenyls (PBB)	0.1%	< 0.1%
Polybrominated diphenyl ethers (PBDE)	0.1%	< 0.1%

Certain components of products as stated above are exempted under the Annex of the RoHS Directives as noted below:

Examples of exempted components are:

1. Mercury in compact fluorescent lamps not exceeding 5 mg per lamp and in other lamps not specifically mentioned in the Annex of RoHS Directive.
2. Lead in glass of cathode ray tubes, electronic components, fluorescent tubes, and electronic ceramic parts (e.g. piezoelectronic devices).
3. Lead in high temperature type solders (i.e. lead-based alloys containing 85% by weight or more lead).
4. Lead as an allotting element in steel containing up to 0.35% lead by weight, aluminium containing up to 0.4% lead by weight and as a cooper alloy containing up to 4% lead by weight.

Copyright Information

Copyright © ViewSonic® Corporation, 2006. All rights reserved.

Macintosh and Power Macintosh are registered trademarks of Apple Computer, Inc.

Microsoft, Windows, Windows NT, and the Windows logo are registered trademarks of Microsoft Corporation in the United States and other countries.

ViewSonic, the three birds' logo, OnView, ViewMatch, and ViewMeter are registered trademarks of ViewSonic Corporation.

VESA is a registered trademark of the Video Electronics Standards Association. DPMS and DDC are trademarks of VESA.

PS/2, VGA and XGA are registered trademarks of International Business Machines Corporation.

Disclaimer: ViewSonic Corporation shall not be liable for technical or editorial errors or omissions contained herein; nor for incidental or consequential damages resulting from furnishing this material, or the performance or use of this product.

In the interest of continuing product improvement, ViewSonic Corporation reserves the right to change product specifications without notice. Information in this document may change without notice.

No part of this document may be copied, reproduced, or transmitted by any means, for any purpose without prior written permission from ViewSonic Corporation.

Product Registration

To meet your future needs, and to receive any additional product information as it becomes available, please register your product on the Internet at: www.viewsonic.com. The ViewSonic Wizard CD-ROM also provides an opportunity for you to print the registration form, which you may mail or fax to ViewSonic.

For Your Records

Product Name:	PJ358 ViewSonic LCD Projector
Model Number:	VS11611
Document Number:	PJ358-1_UG_ENG Rev. 1B 10-25-06
Serial Number:	_____
Purchase Date:	_____



Personal Identification Number (PIN):

The lamp in this product contains mercury.

Please dispose of in accordance with local, state or federal laws.

Projector

PJ358 User's Manual – Operating Guide

Contents of package

- (1) Projector
- (2) Remote control
with two AA batteries
- (3) Power cord
- (4) RGB cable
- (5) Soft case
- (6) Quick Start Guide
and ViewSonic Wizard CD
- (7) Lens cover, Rivet and Strap

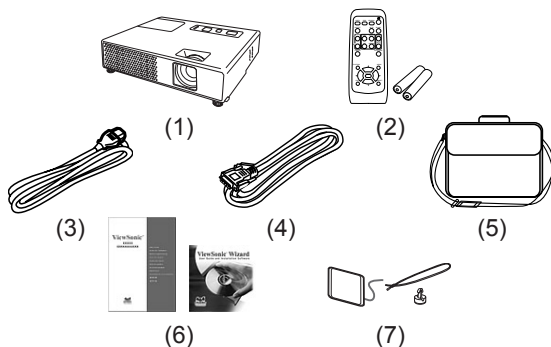

NOTE • Keep the original packing materials for future reshipment. For moving the projector, be sure to use the original packing materials. Use special caution for the lens part.

▲WARNING ► Before using this product, please read all manuals for this product. Be sure to read “Safety Guide” first. After reading them, store them in a safe place for future reference.

About this manual

Various symbols are used in this manual. The meanings of these symbols are described below.

▲WARNING This symbol indicates information that, if ignored, could possibly result in personal injury or even death due to incorrect handling.

▲CAUTION This symbol indicates information that, if ignored, could possibly result in personal injury or physical damage due to incorrect handling.
Please refer to the pages written following this symbol.

NOTE • The information in this manual is subject to change without notice.
• The manufacturer assumes no responsibility for any errors that may appear in this manual.
• The reproduction, transfer or copy of all or any part of this document is not permitted without express written consent.

Trademark acknowledgment

- Mac is registered trademarks of Apple Computer, Inc.
- VESA and SVGA are trademarks of the Video Electronics Standard Association.
- Windows is a registered trademark of Microsoft Corporation.

All other trademarks are the properties of their respective owners.

Content

About this manual	1	EASY MENU	21
Content	2	ASPECT, AUTO KEYSTONE  EXECUTE,	
Projector features	3	KEYSTONE  , PICTURE MODE, BRIGHTNESS,	
Preparations	3	CONTRAST, COLOR, TINT, SHARPNESS,	
Contents of package	3	WHISPER, MIRROR, RESET, FILTER TIME,	
Fastening the lens cover	3	LANGUAGE, Go to Advanced Menu...	
Replacing the filter cover for bottom-up use	3	PICTURE menu	23
Part names	4	BRIGHTNESS, CONTRAST, GAMMA, COLOR TEMP,	
Projector	4	COLOR, TINT, SHARPNESS, MY MEMORY	
Control panel	5	IMAGE menu	26
Remote control	5	ASPECT, OVER SCAN, V POSITION, H POSITION,	
Setting up	6	H PHASE, H SIZE, AUTO ADJUST EXECUTE	
Arrangement	6	INPUT menu	28
Connecting your devices	8	PROGRESSIVE, VIDEO NR, COLOR SPACE,	
Using a USB storage	10	VIDEO FORMAT, FRAME LOCK, COMPUTER IN,	
Connecting power supply	10	RESOLUTION	
Using the security slot	10	SETUP menu	31
Remote control	11	AUTO KEYSTONE  EXECUTE, KEYSTONE  ,	
Putting batteries	11	WHISPER, MIRROR, VOLUME, AUDIO	
About the remote control signal	11	SCREEN menu	33
Changing the frequency of remote control signal	12	LANGUAGE, MENU POSITION, BLANK,	
Using as a simple PC mouse & keyboard	12	START UP, MyScreen, MyScreen Lock,	
Power on/off	13	MESSAGE, SOURCE NAME	
Turning on the power	13	OPTION menu	37
Turning off the power	13	AUTO SEARCH, AUTO KEYSTONE  ,	
Operating	14	AUTO ON, AUTO OFF, LAMP TIME,	
Adjusting the volume	14	FILTER TIME, MY BUTTON, SERVICE,	
Temporarily muting the sound	14	SECURITY, USB STORAGE	
Selecting an input signal	14	USB STORAGE	48
Searching an input signal	15	Maintenance	57
Selecting an aspect ratio	15	Lamp	57
Adjusting the projector's elevator	16	Air filter	59
Adjusting the zoom and focus	16	Other care	60
Using the automatic adjustment feature	17	Troubleshooting	61
Adjusting the position	17	Related messages	61
Correcting the keystone distortions	18	Regarding the indicator lamps	62
Using the magnify feature	18	Phenomena that may be easy to be mistaken for machine defects	64
Freezing the screen	19	Specifications	66
Temporarily blanking the screen	19		
Using the menu function	20		

Projector features

This projector has a capability to project various picture signals onto a screen. This projector requires only a minimal amount of space for installation and can produce a large projected image from even a short distance. This projector also can give a benefit to mobile users and others by offering a special function named “PC less presentation”. Even without PC, this projector realizes the display on screen, getting JPEG, MPEG and Motion-JPEG pictures from USB storage media.

Preparations

Contents of package

Please see the “Contents of package” in the “User’s Manual (concise)” which is a book. Your projector should come with the items shown there. Contact immediately your dealer if anything is missing.

NOTE • Keep the original packing materials, for future reshipment. Be sure to use the original packing materials when moving the projector. Use special caution for the lens.

Fastening the lens cover

To avoid losing the lens cover, please fasten the lens cover to the projector using the enclosed strap.

1. Fix the strap to the strap hole of the lens cover.

 - Thread one end of the strap through the strap hole of the lens cover and make the loop at the end, and let the other end of the strap through the loop. Not have a knot in the strap at either end.
2. Fix the strap to the strap hole of the projector.

 - Thread the other end of the strap through the strap hole of the projector and make the loop there. Let the lens cover with the one end of strap through the loop.

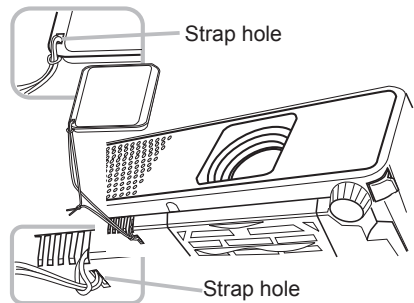

Replacing the filter cover for bottom-up use

For the projector installed bottom-up, please replace the filter cover with the enclosed filter cover for bottom-up use, to keep necessary ventilation space.

Please refer to the “Air filter” for how to detach and attach a filter cover.

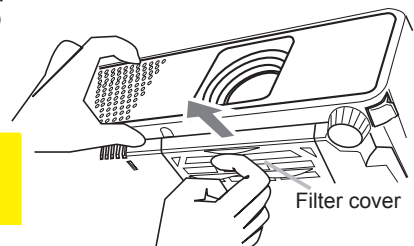

⚠ WARNING ▶ Consult with your dealer before a special installation such as suspending from a ceiling.

Part names

Projector

- (1) Lamp cover
The lamp unit is inside.
- (2) Focus ring
- (3) Zoom ring
- (4) Control panel
- (5) Speaker
- (6) Elevator knobs (x 2)
- (7) Elevator feet (x 2)
- (8) Lens
- (9) Lens cover
- (10) Intake vents
(11) Filter cover
The air filter and intake vent are inside.
- (12) Exhaust vents
- (13) AC inlet
- (14) VIDEO port
- (15) S-VIDEO port
- (16) Security slot
- (17) COMPUTER IN1 port
- (18) Shutdown switch
- (19) COMPUTER IN2 port
- (20) USB port
- (21) USB STORAGE port
- (22) AUDIO OUT port
- (23) AUDIO IN port

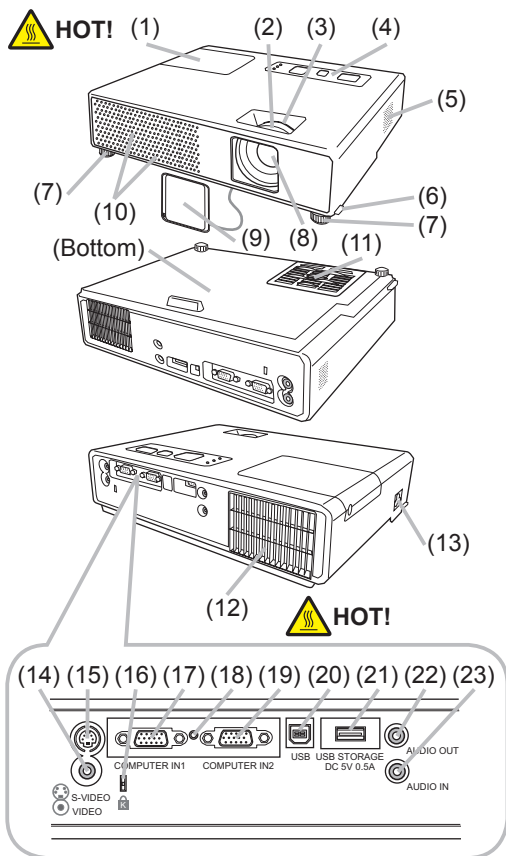

⚠ WARNING ► HOT! : Do not touch around the lamp cover and the exhaust vents during use or just after use, since it is too hot.

► Do not look into the lens or vents while the lamp is on, since the strong light is not good for your eyes.

► Do not handle the elevator knobs without holding the projector, since the projector may drop down.

⚠ CAUTION ► Maintain normal ventilation to prevent the projector from heating up. Do not cover, block or plug up the vents. Do not place anything that can stick or be sucked to the vents, around the intake vents. Clean the air filter periodically.

► Do not use the security slot to prevent the projector from falling down, since it is not designed for it.

► Use the shutdown switch only when the projector is not turned off by normal procedure, since pushing this switch stops operation of the projector without cooling it down.

Control panel

- (1) STANDBY/ON button
- (2) INPUT/ENTER button
- (3) MENU button
It consists of four cursor buttons.
- (4) POWER indicator
- (5) TEMP indicator
- (6) LAMP indicator

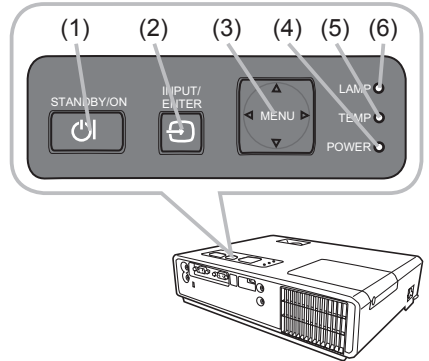

Remote control

- (1) VIDEO button
- (2) COMPUTER/STORAGE button
- (3) SEARCH button
- (4) STANDBY/ON button
- (5) ASPECT button
- (6) AUTO button
- (7) BLANK button
- (8) MAGNIFY - ON button
- (9) MAGNIFY - OFF button
- (10) HOME button
- (11) END button
- (12) PAGE UP button
- (13) PAGE DOWN button
- (14) VOLUME button
- (15) MUTE button
- (16) FREEZE button
- (17) MY BUTTON - 1 button
- (18) MY BUTTON - 2 button
- (19) KEYSTONE button
- (20) POSITION button
- (21) MENU button
- (22) ▲/▼/◀/▶ cursor buttons
- (23) ENTER button
- (24) ESC button
- (25) RESET button
- (26) Battery cover

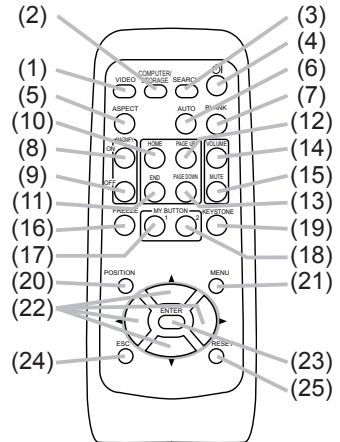

Back of the remote control

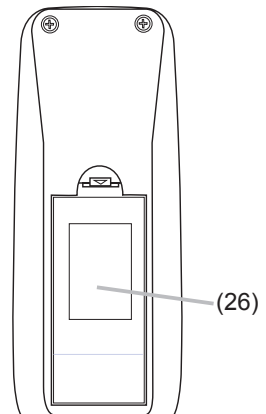

Setting up

Install the projector according to the environment and manner the projector will be used in.

Arrangement

Refer to the illustrations and tables below to determine screen size and projection distance.

The values shown in the table are calculated for a full size screen: 1024×768.

- (a) Screen size (diagonal)
- (b) Projection distance (±10%)
- (c) Screen height (±10%)

On a horizontal surface

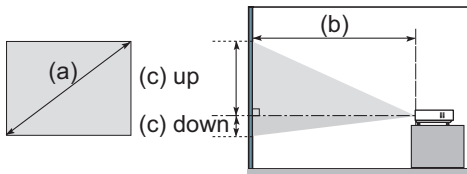

Suspended from the ceiling

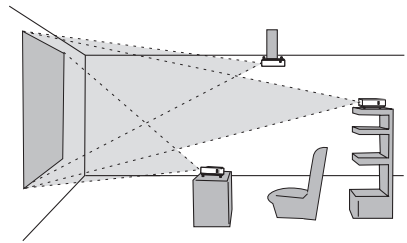
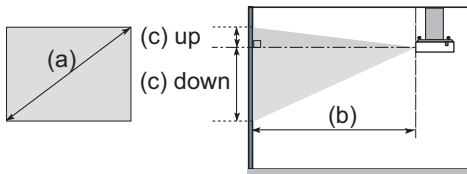

- Keep a space of 30 cm or more between the sides of the projector and other objects such as walls.
- Consult with your dealer before a special installation such as suspending from a ceiling.

(a) Screen size (diagonal)	4 : 3 screen								16 : 9 screen								
	(b) Projection distance				(c) Screen height				(b) Projection distance				(c) Screen height				
	min.		max.		down		up		min.		max.		down		up		
inch	m	m	inch	m	inch	cm	inch	cm	inch	m	inch	m	inch	cm	inch	cm	inch
30	0.8	0.8	30	0.9	36	7	3	39	15	0.8	33	1.0	39	1	0	37	14
40	1.0	1.0	40	1.2	48	9	3	52	21	1.1	44	1.3	53	1	0	49	19
50	1.3	1.3	50	1.5	61	11	4	65	26	1.4	55	1.7	66	1	1	61	24
60	1.5	1.5	61	1.9	73	13	5	78	31	1.7	66	2.0	79	2	1	73	29
70	1.8	1.8	71	2.2	85	15	6	91	36	2.0	77	2.4	93	2	1	85	34
80	2.0	2.1	81	2.5	97	17	7	105	41	2.2	88	2.7	106	2	1	97	38
90	2.3	2.3	91	2.8	110	20	8	118	46	2.5	100	3.0	120	2	1	110	43
100	2.5	2.6	102	3.1	122	22	9	131	51	2.8	111	3.4	133	3	1	122	48
120	3.0	3.1	122	3.7	147	26	10	157	62	3.4	133	4.1	160	3	1	146	58
150	3.8	3.9	153	4.7	183	33	13	196	77	4.2	166	5.1	200	4	2	183	72
200	5.1	5.2	204	6.2	245	44	17	261	103	5.6	222	6.8	267	5	2	243	96
250	6.4	6.5	255	7.8	306	54	21	327	129	7.1	278	8.5	334	7	3	304	120
300	7.6	7.8	306	9.3	368	65	26	392	154	8.5	334	10.2	400	8	3	365	144

⚠WARNING ► Place the projector in a stable horizontal position. If the projector falls or is knocked over it could cause injury and/or damage to the projector. Using a damaged projector could then result in fire and/or electric shock.

- Do not place the projector on an unstable, slanted or vibrational surface such as a wobbly or inclined stand.
- Do not place the projector on its side, front or rear position.
- Consult with your dealer before a special installation such as suspending from a ceiling.

► Place the projector in a cool place, and ensure that there is sufficient ventilation. The high temperature of the projector could cause fire, burns and/or malfunction of the projector.

- Do not stop-up, block or otherwise cover the projector's vents.
- Keep a space of 30 cm or more between the sides of the projector and other objects such as walls.
- Do not place the projector on metallic thing or anything weak in heat.
- Do not place the projector on carpet, cushions or bedding.
- Do not place the projector in direct sunlight or near hot objects such as heaters.
- Do not anything near the projector lens or vents, or on top of the projector.
- Do not place anything that may be sucked into or stick to the vents on the bottom of the projector. This projector has some intake vents also on the bottom.

► Do not place the projector anyplace where it may get wet. Getting the projector wet or inserting liquid into the projector could cause fire, electric shock and/or malfunction of the projector.

- Do not place the projector in a bathroom or the outdoors.
- Do not place anything containing liquid near the projector.

⚠CAUTION ► Avoid placing the projector in smoky, humid or dusty place. Placing the projector in such places could cause fire, electric shock and/or malfunction of the projector.

- Do not place the projector near humidifiers, smoking spaces or a kitchen.
- Position the projector to prevent light from directly hitting the projector's remote sensor.

Connecting your devices

Be sure to read the manuals for devices before connecting them to the projector. Make sure that all the devices are suitable to be connected with this product, and prepare the cables required to connect.

Please refer to the following illustrations to connect them.

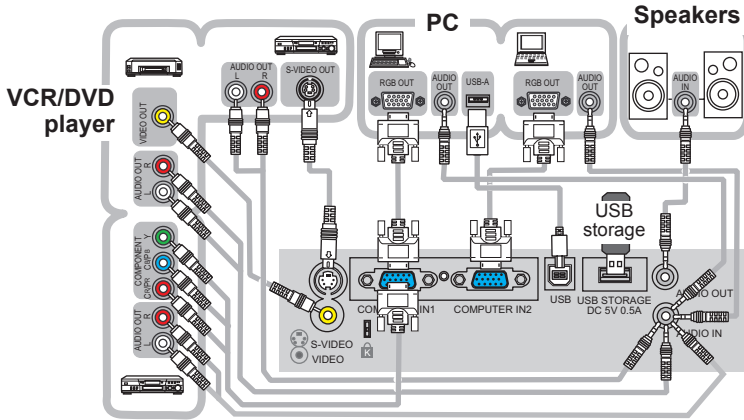

NOTE • The COMPUTER IN1 port can support a component signal also. For more information, please see the description of the COMPUTER IN item of the INPUT menu.

⚠ WARNING ▶ Do not disassemble or modify the projector and accessories.

▶ Be careful not to damage the cables, and do not use damaged cables.

⚠ CAUTION ▶ Turn off all devices and unplug their power cords prior to connecting them to projector. Connecting a live device to the projector may generate extremely loud noises or other abnormalities that may result in malfunction or damage to the device and the projector.

▶ Use appropriate accessory or otherwise designed cables. Ask your dealer about non-accessory cables which may have to be of a specific length or equipped with a core. For cables with a core only at one end, connect the end with the core to the projector.

▶ Make sure that devices are connected to the correct ports. An incorrect connection may result in malfunction or damage to the device and the projector.

Connecting your devices (continued)

NOTE • Be sure to read the manuals for devices before connecting them to the projector, and make sure that all the devices are suitable to be connected with this product. Before connecting to a PC, check the signal level, the signal timing, and the resolution.

- Some signal may need an adapter to input this projector.
- Some PCs have multiple screen display modes that may include some signals which are not supported by this projector.
- Although the projector can display signals with resolution up to UXGA (1600X1200), the signal will be converted to the projector's panel resolution before being displayed. The best display performance will be achieved if the resolutions of the input signal and the projector panel are identical.
- While connecting, make sure that the shape of the cable's connector fits the port to connect with. And be sure to tighten the screws on connectors with screws.
- When connecting a laptop PC to the projector, be sure to activate the PC's external RGB output. (Set the laptop PC to CRT display or to simultaneous LCD and CRT display.) For details on how this is done, please refer to the instruction manual of the corresponding laptop PC.
- When the picture resolution is changed on a pc depending on an input, automatic adjustment function may take some time and may not be completed. In this case, you may not be able to see a check box to select "Yes/No" for the new resolution on Windows. Then the resolution will go back to the original. It might be recommended to use other CRT or LCD monitors to change the resolution.
- In some cases, this projector may not display a proper picture or display any picture on screen. For example, automatic adjustment may not function correctly with some input signals. An input signal of composite sync or sync on G may confuse this projector, so the projector may not display a proper picture.

About Plug-and-Play capability

Plug-and-Play is a system composed of a PC, its operating system and peripheral equipment (i.e. display devices). This projector is VESA DDC 2B compatible. Plug-and-Play can be used by connecting this projector to a pc that is VESA DDC (display data channel) compatible.

- Take advantage of this feature by connecting an RGB cable to the COMPUTER IN1 port (DDC 2B compatible). Plug-and-Play may not work properly if any other type of connection is attempted.
- Please use the standard drivers in your pc as this projector is a Plug-and-Play monitor.

Using a USB storage

In order to view images stored in a USB storage, such as a USB memory stick, insert the device into the USB STORAGE port.

For more information, please see the “USB STORAGE”.

Turn the projector off prior to removing the USB storage from the USB STORAGE port, to prevent some troubles.

Connecting power supply

1. Put the connector of the power cord into the AC inlet of the projector.
2. Firmly plug the power cord's plug into the outlet. In a couple of seconds after the power supply connection, the POWER indicator will light up in steady orange.

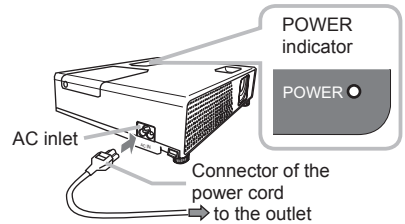

Please remember that when the AUTO ON function activated, the connection of the power supply make the projector turn on.

⚠WARNING ▶ Please use extra caution when connecting the power cord, as incorrect or faulty connections may result in fire and/or electrical shock.

- Only use the power cord that came with the projector. If it is damaged, contact your dealer to newly get correct one.
- Only plug the power cord into an outlet rated for use with the power cord's specified voltage range. The power outlet should be close to the projector and easily accessible. Remove the power cord for complete separation.
- Never modify the power cord.

Using the security slot

This product has the security slot for the Kensington lock. For details, see the manual of the security tool.

⚠WARNING ▶ Do not use the security slot to prevent the projector from falling down, since it is not designed for it.

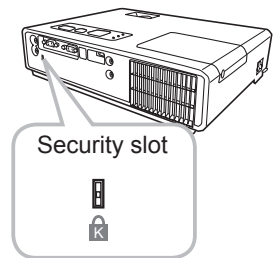

NOTE • The security slot is not comprehensive theft prevention measures. It is intended to be used as supplemental theft prevention measure.

Remote control

Putting batteries

Please set the batteries to the remote control before using it. If the remote control starts to malfunction, try to replace the batteries. If you will not use the remote control for long period, remove the batteries from the remote control and store them in a safe place.

1. Holding the hook part of the battery cover, remove it.
2. Align and insert the two AA batteries according to their plus and minus terminals as indicated in the remote control.
3. Replace the battery cover in the direction of the arrow and snap it back into place.

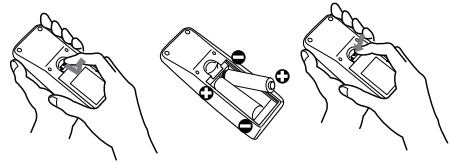

⚠ WARNING ▶ Always handle the batteries with care and use them only as directed. Improper use may result in battery explosion, cracking or leakage, which could result in fire, injury and/or pollution of the surrounding environment.

- Be sure to use only the batteries specified. Do not use batteries of different types at the same time. Do not mix a new battery with used one.
- Make sure the plus and minus terminals are correctly aligned when loading a battery.
- Keep a battery away from children and pets.
- Do not recharge, short circuit, solder or disassemble a battery.
- Do not allow a battery in a fire or water. Keep batteries in a dark, cool and dry place.
- If you observe a leakage of a battery, wipe out the flower and then replace a battery. If the flower adheres your body or clothes, rinse well with water immediately.
- Obey the local laws on disposing the battery.

About the remote control signal

The remote control works with the projector's remote sensor. This projector has a remote sensor on the front.

The sensor senses the signal within the following range when the sensor is active:

60 degrees (30 degrees to the left and right of the sensor) within 3 meters about.

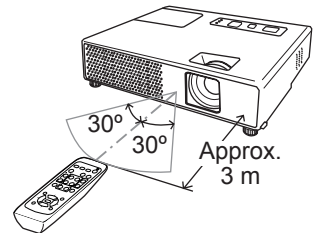

NOTE • The remote control signal reflected in the screen or the like may be available. If it is difficult to send the signal to the sensor directly, attempt to make the signal reflect.

- The remote control uses infrared light to send signals to the projector (Class 1 LED), so be sure to use the remote control in an area free from obstacles that could block the remote control's signal to the projector.
- The remote control may not work correctly if strong light (such as direct sun light) or light from an extremely close range (such as from an inverter fluorescent lamp) shines on the remote sensor of the projector. Adjust the position of projector avoiding those lights.

Changing the frequency of remote control signal

The accessory remote control has the two choices on signal frequency Mode 1 and Mode 2. If the remote control does not function properly, attempt to change the signal frequency. In order to set the Mode, please keep pressing the combination of two buttons listed below simultaneously for about 3 seconds.

- (1) Set to Mode 1: MUTE and RESET buttons
 - (2) Set to Mode 2: MAGNIFY OFF and ESC buttons
- Please remember that the REMOTE FREQ. in the SERVICE item of the OPTION menu of the projector to be controlled should be set to the same mode as the remote control.

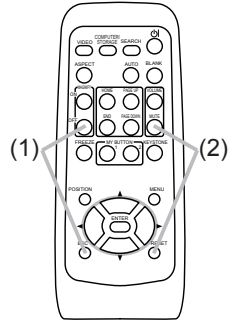

Using as a simple PC mouse & keyboard

The enclosed remote control works as a simple mouse and keyboard of the PC, when the projector's USB port (B type) connects with the PC's mouse port via a mouse cable.

- (1) **HOME key:** Press the HOME button.
- (2) **END key:** Press the END button.
- (3) **PAGE UP key:** Press the PAGE UP button.
- (4) **PAGE DOWN key:** Press the PAGE DOWN button.
- (5) **Mouse left button:** Press the ENTER button.
- (6) **Move pointer:** Use the cursor buttons ▲, ▼, ◀ and ▶.
- (7) **ESC key:** Press the ESC button.
- (8) **Mouse right button:** Press the RESET button.

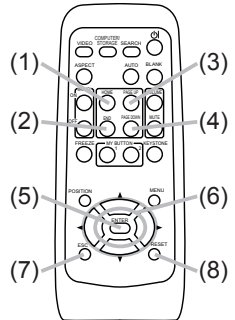
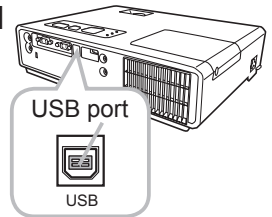

⚠ CAUTION ▶ Improper use of the simple mouse & keyboard function could damage your equipment. While using this function, please connect this product only to a PC. Be sure to check your PC's manuals before connecting this product to the PC.

NOTE • When the simple mouse & keyboard function of this product does not work correctly, please check the following.

- When the mouse cable connects this projector with a PC having a built-in pointing device (e.g. track ball) like a notebook PC, open BIOS setup menu, then select the external mouse and disable the built-in pointing device, because the built-in pointing device may have priority to this function.
- Windows 95 OSR 2.1 or higher is required for this function. And also this function may not work depending on the PC's configurations and mouse drivers.
- You cannot do things like press two buttons at once (for instance, pressing two buttons at the same time to move the mouse pointer diagonally).
- This function is activated only when the projector is working properly. This function is not available while the lamp is warming up (the POWER indicator flashes green), and while adjusting the volume and display, correcting for keystone, zooming in on the screen, using the BLANK function, or displaying the menu screen.

Power on/off

Turning on the power

1. Make sure that the POWER indicator turns in steady orange and the lens cover is removed.
2. Press the STANDBY/ON button on the projector or the remote control.

The projection lamp will light up and the POWER indicator will begin blinking in green. When the power is completely on, the indicator will stop blinking and light in steady green.

To display the picture, select an input signal according to the section "Selecting an input signal".

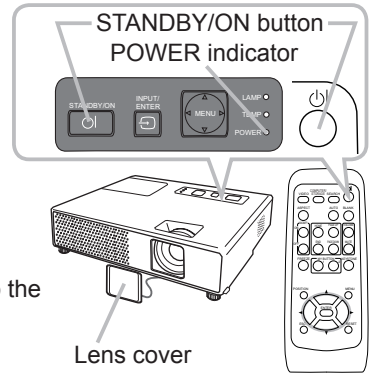
**Turning off the power**

1. Press the STANDBY/ON button on the projector or the remote control. The message "Power off?" will appear on the screen for about 5 seconds.
2. Press the STANDBY/ON button again while the message appears. The projector lamp will go off, and the POWER indicator will begin blinking in orange. Then the POWER indicator will stop blinking and light in steady orange when the lamp cooling is complete.
3. Attach the lens cover, after the POWER indicator turns in steady orange. Do not turn the projector on for about 10 minutes after turning it off. Turning the projector on again too soon could shorten the lifetime of some consumable parts of the projector.

⚠ WARNING ▶ A strong light is emitted when the projector's power is on. Do not look into the lens of the projector or look inside of the projector through any of the projector's openings.

▶ Do not touch around the lamp cover and the exhaust vents during use or just after use, since it is too hot.

▶ Remove the power cord for complete separation.

NOTE • Please power on the projector prior to the connected devices. Power off the projector, after all of connected devices are powered off.

- This projector has the function that can make the projector automatically turn on/off. Please refer to the AUTO ON and AUTO OFF items of the OPTION menu.
- Use the shutdown switch only when the projector is not turned off by normal procedure.

Operating

Adjusting the volume

1. Press the VOLUME button on the remote control.
A dialog will appear on the screen to aid you in adjusting the volume.
2. Use the ▲/▼ cursor buttons to adjust the volume.
To close the dialog and complete the operation, press the VOLUME button again. Even if you do not do anything, the dialog will automatically disappear after a few seconds.
 - When \times is selected for the AUDIO item of the SETUP menu, the volume adjustment is disable.

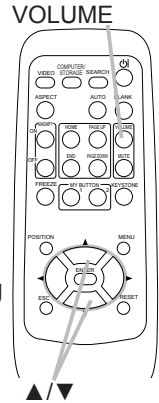

Temporarily muting the sound

1. Press the MUTE button on the remote control.
A dialog will appear on the screen indicating that you have muted the sound.
To restore the sound, press the MUTE or VOLUME button. Even if you do not do anything, the dialog will automatically disappear after a few seconds.
 - When \times is selected for the AUDIO item of the SETUP menu, the volume adjustment is disable.

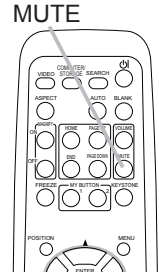

Selecting an input signal

1. Press the INPUT/ENTER button on the projector.
Each time you press the button, the projector switches its input port as below.

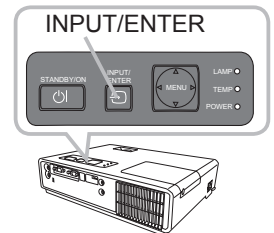
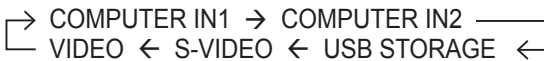

1. Press the COMPUTER/STORAGE button on the remote control.
Each time you press the button, the projector switches its input port as below.

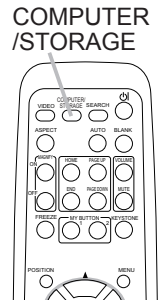

- If the COMPUTER/STORAGE button is pushed to switch from a signal from the VIDEO or S-VIDEO port, when TURN ON is selected for the AUTO SEARCH item in the OPTION menu, the projector will check the COMPUTER IN1 port first. If no input is detected at the port, the projector will check other port in above order.
- Selecting the USB STORAGE port displays the THUMBNAIL menu. For more information, please see the “USB STORAGE”.

(continued on next page)

Selecting an input signal (continued)

1. Press the VIDEO button on the remote control.
 - Each time you press the button, the projector switches its input port as below.
S-VIDEO ↔ VIDEO
 - If the VIDEO button is pushed to switch from a signal from the COMPUTER IN1, COMPUTER IN2 or USB STORAGE port, when TURN ON is selected for the AUTO SEARCH item in the OPTION menu, the projector will check the S-VIDEO port first. If no input is detected at the port, the projector will check the VIDEO port.

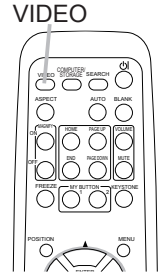

Searching an input signal

1. Press the SEARCH button on the remote control.
 - The projector will start to check its input ports in order to find any input signals. When an input is found, the projector will stop searching and display the image. If no signal is found, the projector will return to the state selected before the operation.

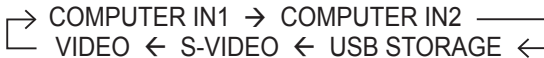

- Selecting the USB STORAGE port displays the THUMBNAIL menu. For more information, please see the “USB STORAGE”.

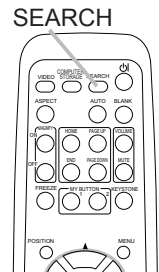

Selecting an aspect ratio

1. Press the ASPECT button on the remote control.
 - Each time you press the button, the projector switches the mode for aspect ratio in turn.
 - For a PC signal or a signal from the USB STORAGE
NORMAL → 4:3 → 16:9 → SMALL
 - For a video signal, s-video signal or component video signal
4:3 → 16:9 → 14:9 → SMALL
 - For no signal
4:3 (fixed)

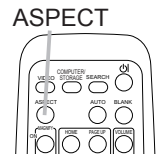

- The ASPECT button does not work when no proper signal is inputted.
- The NORMAL mode keeps the original aspect ratio setting.
- Performing the automatic adjustment initializes the aspect ratio setting.

Adjusting the projector's elevator

When the place to put the projector is slightly uneven to the left or right, use the elevator feet to place the projector horizontally.

Using the feet can also tilt the projector in order to project at a suitable angle to the screen, elevating the front side of the projector within 12 degrees.

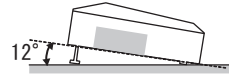

This projector has 2 elevator feet and 2 elevator knobs. An elevator foot is adjustable while pulling up the elevator knob on the same side as it.

1. Holding the projector, pull the elevator knobs up to loose the elevator feet.
2. Position the front side of the projector to the desired height.
3. Release the elevator knobs in order to lock the elevator feet.
4. After making sure that the elevator feet are locked, put the projector gently.
5. If necessary, the elevator feet can be manually twisted to make more precise adjustments. Hold the projector when twisting the feet.

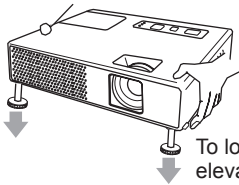

To loose an elevator foot, pull up the elevator knob on the same side as it.

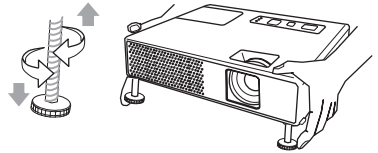

To finely adjust, twist the foot.

⚠ CAUTION ► Do not handle the elevator knobs without holding the projector, since the projector may drop down.

► Do not tilt the projector other than it elevating its front within 12 degrees using the adjuster feet. A tilt of the projector exceeding the restriction could cause malfunction or shortening the lifetime of consumables, or the projector itself.

Adjusting the zoom and focus

1. Use the zoom ring to adjust the screen size.
2. Use the focus ring to focus the picture.

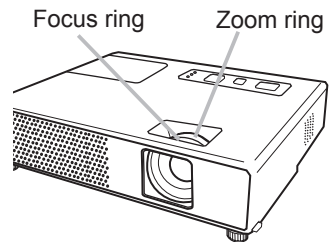

Using the automatic adjustment feature

1. Press the AUTO button on the remote control.

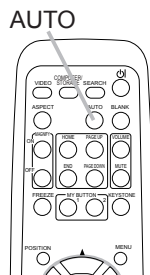

- Pressing this button performs the following.
 - **For a PC signal**

The vertical position, the horizontal position, the horizontal phase and the horizontal size will be automatically adjusted. And the aspect ratio will be automatically set to default. Make sure that the application window is set to its maximum size prior to attempting to use this feature. A dark picture may still be incorrectly adjusted. Use a bright picture when adjusting.

- **For a signal from the USB STORAGE**

The aspect ratio will be automatically set to the default.

- **For a video signal, s-video signal or component video signal**

The video format best suited for the respective input signal will be selected automatically. This function is available only when the AUTO is selected for the VIDEO FORMAT item in the INPUT menu.

The vertical position, horizontal position and aspect ratio will be automatically set to the default. For a component video signal, also the horizontal phase will be automatically set to the default.

- The automatic adjustment operation requires about 10 seconds. Also please note that it may not function correctly with some input. When this function is performed for a video signal, a certain extra such as a line may appear outside a picture.

Adjusting the position

1. Press the POSITION button on the remote control.
2. Use the ▲/▼/◀/▶ cursor buttons to adjust the picture position.

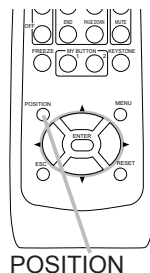

When you want to reset the operation, press the RESET button on the remote control during the operation.

To complete this operation, press the POSITION button again.

Even if you do not do anything, the dialog will automatically disappear after a few seconds.

- The POSITION button does not work for a signal from the USB STORAGE port.
- When this function is performed on a video signal, s-video signal or component video signal, some image such as an extra-line may appear at outside of the picture.
- When this function is performed on a video signal, s-video signal, or component video signal, the range of this adjustment depends on the OVER SCAN in the IMAGE menu setting. It is not possible to adjust when the OVER SCAN is set to 10.

Correcting the keystone distortions

1. Press the KEYSTONE button on the remote control. A dialog will appear on the screen to aid you in correcting the distortion.
2. Use the ▲/▼ cursor buttons to select the AUTO or MANUAL operation, and press the ► button to perform the following.
 - (1) The AUTO executes automatic vertical keystone correction.
 - (2) The MANUAL displays a dialog for keystone correction. Use the ▲/▼ buttons for adjustment.

KEYSTONE

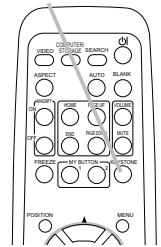

To close the dialog and complete this operation, press the KEYSTONE button again. Even if you do not do anything, the dialog will automatically disappear after a few seconds.

- The adjustable range of this correction will vary among inputs. For some input, this function may not work well.
- When V:INVERT or H&V:INVERT is selected to the MIRROR item in the SETUP menu, if the projector screen is inclined or angled downward, this function may not work correctly.
- When the zoom adjustment is set to the TELE (telephoto focus), the automatic keystone distortion correction may be excessive. This function should be used when the zoom adjustment is set to the full WIDE (wide-angle focus) whenever possible.
- When the projector is placed on the level (about $\pm 0^\circ$), the automatic keystone distortion correction may not work.
- When the projector is inclined to near ± 30 degree or over, this function may not work well.
- This function will be unavailable when Transition Detector is on.

Using the magnify feature

1. Press the ON button of MAGNIFY on the remote control. The “MAGNIFY” indication will appear on the screen (although the indication will disappear in several seconds with no operation), and the projector will go into the MAGNIFY mode.
2. Use the ▲/▼ cursor buttons to adjust the zoom level. To move the zoom area, press the POSITION button in the MAGNIFY mode, then use the ▲/▼/◀/▶ cursor buttons to move the area. And to finalize the zoom area, press the POSITION button again. To exit from the MAGNIFY mode and restore the screen to normal, press the OFF button of MAGNIFY on the remote control.

MAGNIFY ON/OFF

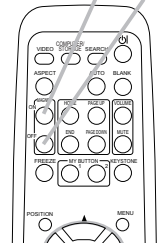

- The projector automatically exits from the MAGNIFY mode when the input signal is changed, or when the display condition is changed.
- Although in the MAGNIFY mode, the keystone distortion condition may vary, it will be restored when the projector exits from the MAGNIFY mode.

NOTE • The zoom level can be finely adjusted. Closely watch the screen to find the level you want.

Freezing the screen

- 1 Press the FREEZE button on the remote control.
 - The “FREEZE” indication will appear on the screen, and the projector will go into the FREEZE mode.

To exit the FREEZE mode and restore the screen to normal, press the FREEZE button again.

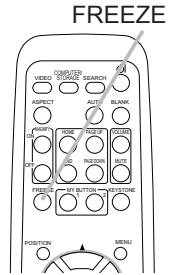

- The projector automatically exits from the FREEZE mode when one of the projector's buttons or remote control buttons of STANDBY/ON, SEARCH, COMPUTER/STORAGE, VIDEO, BLANK, AUTO, VOLUME, MUTE, KEYSTONE, MENU, MAGNIFY and MY BUTTON1/2(except MyMemory or PICTURE MODE is assigned to) is pressed.
- If the projector continues projecting a still image for a long time, the LCD panel might possibly be burned in. Do not leave the projector in the FREEZE mode for too long.

Temporarily blanking the screen

- 1 Press the BLANK button on the remote control.
 - The blank screen will be displayed instead of the screen of input signal. Please refer to the BLANK item in the SCREEN menu.

To exit from the blank screen and return to the input signal screen, press the BLANK button again.

- The projector automatically returns to the input signal screen when one of the projector's buttons or the remote control buttons (except ASPECT, POSITION or FREEZE button, also except MY BUTTON1/2 if AUTO KEYSTONE or MyMemory or PICTURE MODE is assigned on these buttons) is pressed.

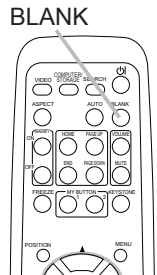

NOTE • The sound is not connected with the blank screen function. If necessary, set the volume or mute first.

Using the menu function

This projector has the following menus: PICTURE, IMAGE, INPUT, SETUP, SCREEN, OPTION and EASY MENU. EASY MENU consists of functions often used, and the other menus are classified into each purpose. Each of these menus is operated using the same methods. The basic operations of these menus are as follows.

1. Press the MENU button on the remote control or the projector. The Advanced MENU, or EASY MENU that has priority just after powered on, will appear. While the projector is displaying any menu, the INPUT/ENTER button on the projector works as the ENTER button and the MENU button on the projector works as the cursor buttons.

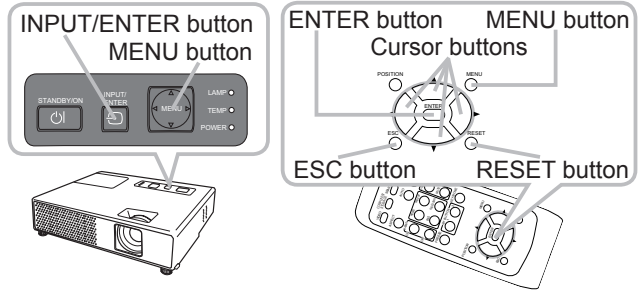

In the EASY MENU

2. If you want to change it to the Advanced Menu, select the “Go to Advanced Menu...”
3. Use the ▲/▼ cursor buttons to select an item to operate.
4. Use the ◀/▶ cursor buttons to operate the item.

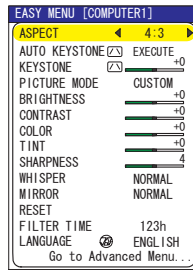

EASY MENU

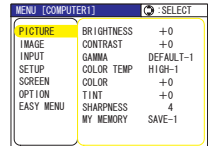

Advanced MENU

In the Advanced MENU

2. Use the ▲/▼ cursor buttons to select a menu. If you want to change it to the EASY MENU, select the EASY MENU. Then press the ▶ cursor button, or the ENTER button to select an item. The lower layer menu of the selected item will appear.
3. Use the ▲/▼ cursor buttons to select an item to operate. Then press the ▶ cursor button, or the ENTER button to progress. The operation menu of the selected item will appear.
4. Use the ▲/▼ cursor buttons to operate the item. Some functions cannot be performed when a certain input port is selected, or when a certain input signal is displayed. When you want to reset the operation, press the RESET button on the remote control during the operation. Note that some items (ex. LANGUAGE, H PHASE, VOLUME) cannot be reset. In the Advanced Menu, when you want to return to the previous display, press the ◀ cursor button, or the ESC button on the remote control.
5. Press the MENU button on the remote control again to close the menu and complete this operation. Even if you do not do anything, the dialog will automatically disappear after about 10 seconds.

EASY MENU

From the EASY MENU, items shown in the table below can be performed.

Select an item using the ▲/▼ cursor buttons. Then perform it according to the following table.

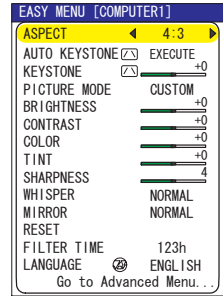

Item	Description																				
ASPECT	Using the ◀/▶ buttons switches the mode for aspect ratio. See the ASPECT item in IMAGE menu.																				
AUTO KEYSTONE EXECUTE [↘]	Using the ▶ button executes the auto keystone function. See the AUTO KEYSTONE [↘] EXECUTE item in SETUP menu.																				
KEYSTONE [↘]	Using the ◀/▶ buttons corrects the vertical keystone distortion. See the KEYSTONE [↘] item in SETUP menu.																				
PICTURE MODE	Using the ◀/▶ buttons switches the picture mode. The picture modes are combinations of GAMMA and COLOR TEMP settings. Choose a suitable mode according to the projected source.																				
	<p style="text-align: center;"> → NORMAL ↔ CINEMA ↔ DYNAMIC ← ↙ WHITEBOARD ↔ DAYLIGHT MODE ↔ BOARD(BLACK) ↘ </p> <table border="1" style="width: 100%; border-collapse: collapse;"> <thead> <tr> <th></th> <th>COLOR TEMP</th> <th>GAMMA</th> </tr> </thead> <tbody> <tr> <td>NORMAL</td> <td>MID DEFAULT</td> <td>#1 DEFAULT</td> </tr> <tr> <td>CINEMA</td> <td>LOW DEFAULT</td> <td>#2 DEFAULT</td> </tr> <tr> <td>DYNAMIC</td> <td>HIGH DEFAULT</td> <td>#3 DEFAULT</td> </tr> <tr> <td>BOARD(BLACK)</td> <td>Hi-BRIGHT-1 DEFAULT</td> <td>#4 DEFAULT</td> </tr> <tr> <td>DAYLIGHT MODE</td> <td>Hi-BRIGHT-2 DEFAULT</td> <td>#3 DEFAULT</td> </tr> <tr> <td>WHITEBOARD</td> <td>MID DEFAULT</td> <td>#5 DEFAULT</td> </tr> </tbody> </table> <ul style="list-style-type: none"> • When the combination of GAMMA and COLOR TEMP differs from pre-assigned modes above, the display on the menu for the PICTURE MODE is “CUSTOM”. Please refer to the GAMMA and COLOR TEMP items in PICTURE menu. • When this function is performed, a certain extra such as a line may appear. 		COLOR TEMP	GAMMA	NORMAL	MID DEFAULT	#1 DEFAULT	CINEMA	LOW DEFAULT	#2 DEFAULT	DYNAMIC	HIGH DEFAULT	#3 DEFAULT	BOARD(BLACK)	Hi-BRIGHT-1 DEFAULT	#4 DEFAULT	DAYLIGHT MODE	Hi-BRIGHT-2 DEFAULT	#3 DEFAULT	WHITEBOARD	MID DEFAULT
	COLOR TEMP	GAMMA																			
NORMAL	MID DEFAULT	#1 DEFAULT																			
CINEMA	LOW DEFAULT	#2 DEFAULT																			
DYNAMIC	HIGH DEFAULT	#3 DEFAULT																			
BOARD(BLACK)	Hi-BRIGHT-1 DEFAULT	#4 DEFAULT																			
DAYLIGHT MODE	Hi-BRIGHT-2 DEFAULT	#3 DEFAULT																			
WHITEBOARD	MID DEFAULT	#5 DEFAULT																			

(continued on next page)

EASY MENU (continued)

Item	Description
BRIGHTNESS	Using the ◀/▶ buttons adjusts the brightness. See the BRIGHTNESS item in PICTURE menu.
CONTRAST	Using the ◀/▶ buttons adjusts the contrast. See the CONTRAST item in PICTURE menu.
COLOR	Using the ◀/▶ buttons adjusts the strength of whole color. See the COLOR item in PICTURE menu.
TINT	Using the ◀/▶ buttons adjusts the tint. See the TINT item in PICTURE menu.
SHARPNESS	Using the ◀/▶ buttons adjusts the sharpness. See the SHARPNESS item in PICTURE menu.
WHISPER	Using the ◀/▶ buttons turns off/on the whisper mode. See the WHISPER item in SETUP menu.
MIRROR	Using the ◀/▶ buttons switches the mode for mirror status. See the MIRROR item in SETUP menu.
RESET	Performing this item resets all of the EASY MENU items except the FILTER TIME and LANGUAGE. A dialog is displayed for confirmation. Selecting the RESET using the ▲ button performs resetting.
FILTER TIME	Performing this item resets the filter time which counts usage time of the air filter. A dialog is displayed for confirmation. Selecting the RESET using the ▲ button performs resetting. See the FILTER TIME item in OPTION menu.
LANGUAGE	Using the ◀/▶ buttons changes the display language. See the LANGUAGE item in SCREEN menu.
Go to Advanced Menu...	Select "Go to Advanced Menu..." on the menu, and press the ▶ or ENTER button to use the menu of PICTURE, IMAGE, INPUT, SETUP, SCREEN or OPTION.

PICTURE Menu

From the PICTURE menu, items shown in the table below can be performed.

Select an item using the ▲/▼ cursor buttons, and press the ► cursor button or ENTER button to execute the item. Then perform it according to the following table.

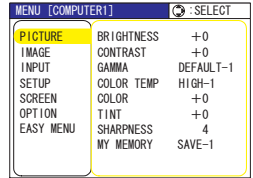

Item	Description
BRIGHTNESS	Using the ▲/▼ buttons adjusts the brightness. Light ⇄ Dark
CONTRAST	Using the ▲/▼ buttons adjusts the contrast. Strong ⇄ Weak
GAMMA	<p>Using the ▲/▼ buttons switches the gamma mode. #1 DEFAULT ⇄ #1 CUSTOM ⇄ #2 DEFAULT ⇄ #2 CUSTOM ⇄ #3 DEFAULT ⇕ ⇕ #5 CUSTOM ⇄ #5 DEFAULT ⇄ #4 CUSTOM ⇄ #4 DEFAULT ⇄ #3 CUSTOM</p> <p>To adjust CUSTOM</p> <p>Selecting a mode whose name includes CUSTOM and then pressing the ► button or the ENTER button displays a dialog to aid you in adjusting the mode. This function is useful when you want to change the brightness of particular tones.</p> <p>Choose an item using the ◀/▶ buttons, and adjust the level using the ▲/▼ buttons.</p> <p>You can display a test pattern for checking the effect of your adjustment by pressing the ENTER button. Each time you press the ENTER button, the pattern changes as below.</p> <p>No pattern ⇄ Gray scale of 9 steps ⇄ ⇕ ⇕ Ramp ⇄ Gray scale of 15 steps</p> <p>The eight equalizing bars correspond to eight tone levels of the test pattern except the darkest in the left end. If you want to adjust the 2nd tone from left end on the test pattern, use the equalizing adjustment bar "1". The darkest tone at the left end of the test pattern cannot be controlled with any of equalizing adjustment bar.</p> <ul style="list-style-type: none"> • When this function is performed, lines or other distortion may appear.

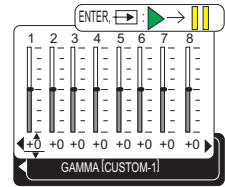

(continued on next page)

PICTURE Menu (continued)

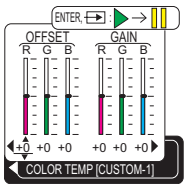
Item	Description
<p>COLOR TEMP</p>	<p>Using the ▲/▼ buttons switches the color temperature mode.</p> <p>→ HIGH DEFAULT ⇔ HIGH CUSTOM ⇔ MID DEFAULT ⇔ MID CUSTOM ← ↳ LOW DEFAULT ⇔ LOW CUSTOM ⇔ HI-BRIGHT-1 DEFAULT ⇔ HI-BRIGHT-1 CUSTOM ← ↳ HI-BRIGHT-2 DEFAULT ⇔ HI-BRIGHT-2 CUSTOM ←</p> <p>To adjust CUSTOM</p> <p>Selecting a mode whose name includes CUSTOM and then pressing the ► button or the ENTER button displays a dialog to aid you in adjusting the OFFSET and GAIN of the selected mode.</p> <p>OFFSET adjustments change the color intensity on the whole tones of the test pattern.</p> <p>GAIN adjustments mainly affect color intensity on the brighter tones of the test pattern.</p> <p>Choose an item using the ◀/▶ buttons, and adjust the level using the ▲/▼ buttons.</p> <p>You can display a test pattern for checking the effect of your adjustment by pressing the ENTER button. Each time you press the ENTER button, the pattern changes as below.</p> <p>No pattern ⇔ Gray scale of 9 steps ⇐ ↳ Ramp ⇔ Gray scale of 15 steps</p> <ul style="list-style-type: none"> • When this function is performed, lines or other distortion may appear. 
<p>COLOR</p>	<p>Using the ▲/▼ buttons adjusts the strength of whole color.</p> <p>Strong ⇔ Weak</p> <ul style="list-style-type: none"> • This item can be selected only for a video signal, s-video or component video signal.
<p>TINT</p>	<p>Using the ▲/▼ buttons adjusts the tint.</p> <p>Greenish ⇔ Reddish</p> <ul style="list-style-type: none"> • This item can be selected only for a video signal, s-video or component video signal.
<p>SHARPNESS</p>	<p>Using the ▲/▼ buttons adjusts the sharpness.</p> <p>Strong ⇔ Weak</p> <ul style="list-style-type: none"> • There may be some noise and/or the screen may flicker for a moment when an adjustment is made. This is not a malfunction.

(continued on next page)

PICTURE Menu (continued)



Item	Description
<p>MY MEMORY</p>	<p>This projector has 4 memories for adjustment data (for all the items of the PICTURE menu). Selecting a function using the ▲/▼ buttons and pressing the ► or ENTER button performs each function.</p> <div style="text-align: center;">  <pre> ↪ LOAD1 ↔ LOAD2 ↔ LOAD3 ↔ LOAD4 ↪ ↩ SAVE4 ↔ SAVE3 ↔ SAVE2 ↔ SAVE1 ↩ </pre> </div> <p><u>LOAD1, LOAD2, LOAD3, LOAD4</u></p> <p>Performing a LOAD function loads the data from the memory linked in the number included in the function's name, and adjusts the picture automatically depending on the data.</p> <ul style="list-style-type: none"> • The LOAD functions whose linked memory has no data are skipped. • Remember that the current adjusted condition will be lost by loading data. If you want to keep the current adjustment, please save it before performing a LOAD function. • There may be some noise and the screen may flicker for a moment when loading data. This is not malfunction. • The LOAD functions can be also performed by the MY MEMORY button which can be set by the MY BUTTON item in OPTION menu. <p><u>SAVE1, SAVE2, SAVE3, SAVE4</u></p> <p>Performing a SAVE function saves the current adjustment data into the memory linked in the number included in the function's name.</p> <ul style="list-style-type: none"> • Remember that the current data being stored of a memory will be lost by saving a new data into the memory.

IMAGE Menu

From the IMAGE menu, items shown in the table below can be performed.

Select an item using the ▲/▼ cursor buttons, and press the ► cursor button or ENTER button to execute the item. Then perform it according to the following table.

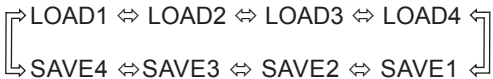
MENU [COMPUTER]		SELECT
PICTURE	ASPECT	4:3
IMAGE	OVER SCAN	5
INPUT	V POSITION	25
SETUP	H POSITION	142
SCREEN	H PHASE	16
OPTION	H SIZE	1344
EASY MENU	AUTO ADJUST	EXECUTE

Item	Description
ASPECT	<p>Using the ▲/▼ buttons switches the mode for aspect ratio. For a PC signal or a signal from the USB STORAGE NORMAL ⇔ 4:3 ⇔ 16:9 ⇔ SMALL </p> <p>For a Video signal, s-video signal or component video signal 4:3 ⇔ 16:9 ⇔ 14:9 ⇔ SMALL </p> <p>For no signal 4:3 (fixed)</p> <ul style="list-style-type: none"> • This item can be selected only for a proper signal. • The NORMAL mode keeps the original aspect ratio setting. • Performing the automatic adjustment initializes the aspect ratio setting.
OVER SCAN	<p>Using the ▲/▼ buttons adjusts the over-scan ratio. Large (It reduces picture) ⇔ Small (It magnifies picture)</p> <ul style="list-style-type: none"> • This item can be selected only for a video, s-video and component video signal. • When this adjustment is too large, certain degradation may appear at the frame area of the picture. In such a case, please adjust small.
V POSITION	<p>Using the ▲/▼ buttons adjusts the vertical position. Up ⇔ Down</p> <ul style="list-style-type: none"> • This item cannot be selected for a signal from the USB STORAGE port. • Over-adjusting the vertical position may cause noise to appear on the screen. If this occurs please reset the vertical position to the default setting. Pressing the RESET button when the V POSITION is selected will reset the V POSITION to the default setting. • When this function is performed on a video signal, s-video signal, or component video signal of 525i (480i) or 625i (576i), the range of this adjustment depends on the OVER SCAN setting. It is not possible to adjust when the OVER SCAN is set to 10.
H POSITION	<p>Using the ▲/▼ buttons adjusts the horizontal position. Left ⇔ Right</p> <ul style="list-style-type: none"> • This item cannot be selected for a signal from the USB STORAGE port. • Over-adjusting the horizontal position may cause noise to appear on the screen. If this occurs please reset the horizontal position to the default setting. Pressing the RESET button when the H POSITION is selected will reset the H POSITION to the default setting. • When this function is performed on a video signal, s-video signal, or component video signal, the range of this adjustment depends on the OVER SCAN setting. It is not possible to adjust when the OVER SCAN is set to 10.

(continued on next page)

IMAGE Menu (continued)



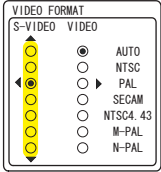

Item	Description
H PHASE	Using the ▲/▼ buttons adjusts the horizontal phase to eliminate flicker. Right ⇄ Left <ul style="list-style-type: none"> • This item can be selected only for a computer signal or component video signal.
H SIZE	Using the ▲/▼ buttons adjusts the horizontal size. Large ⇄ Small <ul style="list-style-type: none"> • This item can be selected only for a computer signal. • When this adjustment is excessive, the picture may not be displayed correctly. In such a case, please reset the adjustment by pressing the RESET button during this operation.
AUTO ADJUST EXECUTE	Selecting this item performs the automatic adjustment feature. <p>For a PC signal The vertical position, the horizontal position, the horizontal phase and the horizontal size will be automatically adjusted. And the aspect ratio will be automatically set to the default. Make sure that the application window is set to its maximum size prior to attempting to use this feature. A dark picture may still be incorrectly adjusted. Use a bright picture when adjusting.</p> <p>For a signal from the USB STORAGE The aspect ratio will be automatically set to the default.</p> <p>For a video signal, s-video signal or component video signal The video format best suited for the respective input signal will be selected automatically. This function is available only when the AUTO mode is selected to the VIDEO FORMAT item in INPUT menu. The vertical position, horizontal position and aspect ratio will be automatically set to the the default.</p> <p>For a component video signal, also the horizontal phase will be automatically set to the default.</p> <ul style="list-style-type: none"> • The automatic adjustment operation requires about 10 seconds. Also please note that it may not function correctly with some input.

INPUT Menu (continued)

Item	Description
<p>VIDEO FORMAT</p>	<p>Set the video format for the s-video port and video port.</p> <p>(1) Use the ◀/▶ buttons to select the input port.</p> <p>(2) Using the ▲/▼ buttons switches the mode for video format.</p> <p style="text-align: center;"> AUTO ⇄ NTSC ⇄ PAL ⇄ SECAM ⇄ N-PAL ⇄ M-PAL ⇄ NTSC4.43 ⇄ </p> <ul style="list-style-type: none"> • This item is performed only for a video signal from the VIDEO port or the S-VIDEO port. • The AUTO mode automatically selects the optimum mode. • The AUTO operation may not work well for some signals. If the picture becomes unstable (e.g. an irregular picture, lack of color), please select the mode according to the input signal. 
<p>FRAME LOCK</p>	<p>Using the ▲/▼ buttons turns the frame lock function on/off.</p> <p style="text-align: center;">TURN ON ⇄ TURN OFF</p> <ul style="list-style-type: none"> • This item can be performed only on a computer signal with a vertical frequency of 50 to 60 Hz. • When the TURN ON is selected, a moving pictures are displayed more smoothly. • This function may cause a certain degradation of the picture. In such a case, please select the TURN OFF.
<p>COMPUTER IN</p>	<p>Set the computer input signal type for the ports of COMPUTER.</p> <p>(1) Use the ◀/▶ buttons to select a COMPUTER port to be set.</p> <p style="text-align: center;">COMPUTER IN1 ⇄ COMPUTER IN2</p> <p>(2) Use the ▲/▼ buttons to select the computer input signal type.</p> <p style="text-align: center;">AUTO ⇄ SYNC ON G OFF</p> <p>Sync on Green signal can be supported, if AUTO is selected.</p> <ul style="list-style-type: none"> • When the AUTO is selected, the picture may be distorted with certain input signals. In such a case, remove the signal connector first and select SYNC ON G OFF on the menu, and then reconnect the signal. • Component signal can be supported through COMPUTER IN1 port, if AUTO is selected for the COMPUTER IN1 port.

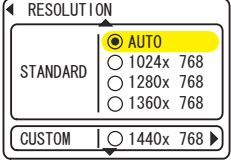
(continued on next page)

INPUT Menu (continued)

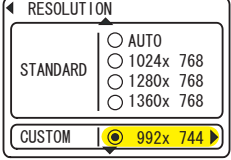
Item	Description
<p>RESOLUTION</p>	<p>The resolution for the COMPUTER IN1 and COMPUTER IN2 input signals can be set on this projector.</p> <p>(1) In the INPUT menu select the RESOLUTION using the ▲/▼ buttons and press the ► button. The RESOLUTION menu will be displayed.</p>  <p>(2) In the RESOLUTION menu, select the resolution you wish to display using the ▲/▼ buttons. Selecting AUTO will set a resolution appropriate to the input signal.</p> <p>(3) Pressing the ► or ENTER button when selecting a STANDARD resolution will automatically adjust the horizontal and vertical positions, clock phase and horizontal size and automatically select an aspect ratio. The INFORMATION dialog will be displayed.</p>  <p>(4) To set a custom resolution use the ▲/▼ buttons to select the CUSTOM and the CUSTOM RESOLUTION box will be displayed. Set the horizontal (HORZ) and vertical (VERT) resolutions using the ▲/▼/◀/► buttons.</p>  <p>Although not all resolutions are guaranteed.</p> <p>(5) To save the setting place the cursor on the right-most digit and press the ► button. The horizontal and vertical positions, clock phase and horizontal size will be automatically adjusted and an aspect ratio will be automatically selected. After the INFORMATION dialog has displayed for about 10 seconds the screen will return to the RESOLUTION menu displaying the changed resolution.</p>  <p>(6) To revert back to the previous resolution without saving changes place the cursor on the left-most digit and press the ◀ button. The screen will then return to the RESOLUTION menu displaying the previous resolution.</p>  <ul style="list-style-type: none"> • For some pictures, this function may not work well.

SETUP Menu

From the SETUP menu, items shown in the table below can be performed.



Select an item using the ▲/▼ cursor buttons, and press the ► cursor button on the ENTER button to execute the item. Then perform it according to the following table.

MENU [COMPUTER]		SELECT
PICTURE	AUTO KEYSTONE [Z] EXECUTE	
IMAGE	KEYSTONE [Z] +0	
INPUT	WHISPER NORMAL	
SETUP	MIRROR NORMAL	
SCREEN	VOLUME 16	
OPTION	AUDIO	
EASY MENU		

Item	Description
AUTO KEYSTONE [Z] EXECUTE	<p>Selecting this item performs the automatic keystone distortion correction. Projector automatically corrects vertical keystone distortion due to the (forward/backward) setup angle by itself.</p> <p>This function will be executed only once when selected in the menu. When the slant of the projector is changed, execute this function again.</p> <ul style="list-style-type: none"> • The adjustable range for correction will vary among inputs. For some input, this function may not work well. • When V:INVERT or H&V:INVERT is selected to the MIRROR item in the SETUP menu, if the projector screen is inclined or angled downward, this function may not work correctly. • When the zoom adjustment is set to the TELE (telephoto focus), this function may be excessive. This function should be used when the zoom adjustment is set to the full WIDE (wide-angle focus) whenever possible. • When the projector is placed on the level (about $\pm 0^\circ$), this function may not work. • When the projector is inclined to near ± 30 degree or over, this function may not work well. • This function will be unavailable when the Transition Detector is on.
KEYSTONE [Z]	<p>Using the ▲/▼ buttons corrects the vertical keystone distortion.</p> <p>Shrink the top of the image ⇔ Shrink the bottom of the image</p> <ul style="list-style-type: none"> • The adjustable range of this function will vary with the type of input signal. For some input, this function may not work well. • This function will be unavailable when the Transition Detector is on.

(continued on next page)

SETUP Menu (continued)

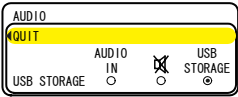
Item	Description
WHISPER	Using the ▲/▼ buttons turns off/on the whisper mode. NORMAL ⇄ WHISPER • When the WHISPER is selected, acoustic noise and screen brightness are reduced.
MIRROR	Using the ▲/▼ buttons switches the mode for mirror status.  NORMAL ⇄ H:INVERT ⇄ V:INVERT ⇄ H&V:INVERT  If the Transition Detector is TURN ON and MIRROR status is changed, Transition Detector Alarm will be displayed when projector is restarted after the power switch is turned off.
VOLUME	Using the ▲/▼ buttons adjusts the volume. High ⇄ Low
AUDIO	Allocates an audio port for USB STORAGE port. (1) Press the ▼ button to begin to select. (2) Use the ◀/▶ buttons to select an Audio port for the USB STORAGE port. AUDIO IN ⇄ ⓧ ⇄ USB STORAGE  • This setting is effective only when a signal from the USB STORAGE port is selected.

SCREEN Menu

From the SCREEN menu, items shown in the table below can be performed.

Select an item using the ▲/▼ cursor buttons, and press the ► cursor button or ENTER button to execute the item. Then perform it according to the following table.

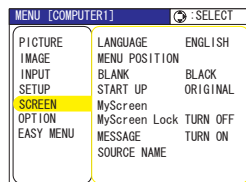

Item	Description								
LANGUAGE	<p>Using the ▲/▼ buttons switches the OSD (On Screen Display) language.</p> <p>ENGLISH ⇄ FRANÇAIS ⇄ DEUTSCH ⇄ ESPAÑOL ⇄ ITALIANO</p> <p>NORSK ⇄ NEDERLANDS ⇄ PORTUGUÊS ⇄ 日本語</p> <p>简体中文 ⇄ 繁體中文 ⇄ 한글 ⇄ SVENSKA ⇄ РУССКИЙ</p> <p>SUOMI ⇄ POLSKI ⇄ TÜRKÇE</p>								
MENU POSITION	<p>Using the ▲/▼/◀/▶ buttons adjusts the menu position.</p> <p>To quit the operation, press the MENU button on the remote control or keep no operation for about 10 seconds.</p>								
BLANK	<p>Using the ▲/▼ buttons switches the mode for the blank screen. The blank screen is a screen for the temporarily blanking feature. It is displayed by pressing the BLANK button.</p> <p>MyScreen ⇄ ORIGINAL ⇄ BLUE ⇄ WHITE ⇄ BLACK</p> <table border="1" style="width: 100%; border-collapse: collapse;"> <thead> <tr> <th style="width: 50%;"></th> <th style="width: 50%;">Feature</th> </tr> </thead> <tbody> <tr> <td>MyScreen</td> <td>Screen can be registered by the MyScreen item.</td> </tr> <tr> <td>ORIGINAL</td> <td>Screen preset as the standard screen.</td> </tr> <tr> <td>BLUE, WHITE, BLACK</td> <td>Plain screens in each color.</td> </tr> </tbody> </table> <ul style="list-style-type: none"> • To avoid remaining as an afterimage, the MyScreen or ORIGINAL screen will change to the plain black screen after several minutes. 		Feature	MyScreen	Screen can be registered by the MyScreen item.	ORIGINAL	Screen preset as the standard screen.	BLUE, WHITE, BLACK	Plain screens in each color.
	Feature								
MyScreen	Screen can be registered by the MyScreen item.								
ORIGINAL	Screen preset as the standard screen.								
BLUE, WHITE, BLACK	Plain screens in each color.								

(continued on next page)

SCREEN Menu (continued)

Item	Description								
START UP	Using the ▲/▼ buttons switches the mode for the start-up screen. The start-up screen is a screen displayed when no signal or an unsuitable signal is detected.								
	MyScreen ⇄ ORIGINAL ⇄ TURN OFF 								
	<table border="1" style="width: 100%; border-collapse: collapse;"> <thead> <tr> <th style="width: 50%;"></th> <th style="width: 50%;">Feature</th> </tr> </thead> <tbody> <tr> <td>MyScreen</td> <td>Screen can be registered by the MyScreen item.</td> </tr> <tr> <td>ORIGINAL</td> <td>Screen preset as the standard screen.</td> </tr> <tr> <td>TURN OFF</td> <td>Plain black screen.</td> </tr> </tbody> </table>		Feature	MyScreen	Screen can be registered by the MyScreen item.	ORIGINAL	Screen preset as the standard screen.	TURN OFF	Plain black screen.
		Feature							
	MyScreen	Screen can be registered by the MyScreen item.							
ORIGINAL	Screen preset as the standard screen.								
TURN OFF	Plain black screen.								
<ul style="list-style-type: none"> • To avoid remaining as an afterimage, the MyScreen or ORIGINAL screen will change to the BLANK screen after several minutes. If also the BLANK screen is the MyScreen or ORIGINAL, the plain black screen is instead used. 									
<ul style="list-style-type: none"> • When the TURN ON is selected to the MyScreen PASSWORD of SECURITY item in OPTION menu, the START UP is fixed to MyScreen. 									

(continued on next page)

SCREEN Menu (continued)

Item	Description
<p>MyScreen</p>	<p>This item allows you to capture an image for use as a MyScreen image which can be used as the BLANK screen and START UP screen. Display the image you want to capture before executing the following procedure.</p> <ol style="list-style-type: none"> <p>Selecting this item displays a dialog titled "MyScreen". It will ask you if you start capturing an image from the current screen.</p>  <p>Please wait for the target image to be displayed, and press the ENTER button when the image is displayed. The image will freeze and the frame for capturing will appear.</p> <p>To stop performing, press the RESET or ESC button.</p> <p>Using the ▲/▼/◀/▶ buttons adjusts the frame position.</p> <p>Please move the frame to the position of the image which you want to use. The frame may not be able to be moved for some input signals.</p> <p>To start registration, press the ENTER button.</p> <p>To restore the screen and return to the previous dialog, press the RESET or ESC button.</p> <p>Registration takes several minutes.</p> <p>When the registration is completed, the registered screen and the following message is displayed for several seconds:</p> <p>"MyScreen registration is finished."</p> <p>If the registration failed, the following message is displayed:</p> <p>"A capturing error has occurred. Please try again."</p> <ul style="list-style-type: none"> • This function cannot be selected when the TURN ON is selected to the MyScreen Lock item. • This function cannot be selected when the TURN ON is selected to the MyScreen PASSWORD of SECURITY item in OPTION menu.
<p>MyScreen Lock</p>	<p>Using the ▲/▼ buttons turns on/off the MyScreen lock function.</p> <p>TURN ON ⇔ TURN OFF</p> <p>When the TURN ON is selected, the MyScreen item is locked. Use this function for protecting the current MyScreen.</p> <ul style="list-style-type: none"> • This function cannot be selected when the TURN ON is selected to the MyScreen PASSWORD of SECURITY item in OPTION menu.

(continued on next page)

SCREEN Menu (continued)

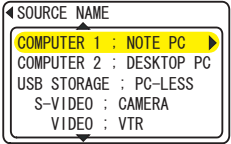
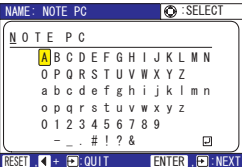
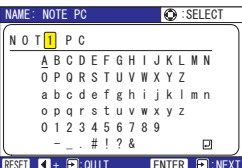
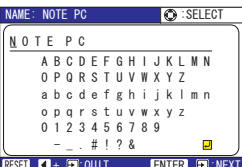

Item	Description
<p>MESSAGE</p>	<p>Using the ▲/▼ buttons turns on/off the message function. TURN ON ⇔ TURN OFF</p> <p>When the TURN ON is selected, the following message function works. “AUTO IN PROGRESS” while automatically adjusting “NO INPUT IS DETECTED” “SYNC IS OUT OF RANGE” “Searching....” while searching for the input “Detecting....” while an input signal is detected The indication of the input signal displayed by changing The indication of the aspect ratio displayed by changing The indication of the PICTURE MODE displayed by changing The indication of the MY MEMORY displayed by changing The indication of “FREEZE” and “II” while freezing the screen by pressing the FREEZE button.</p> <ul style="list-style-type: none"> • When the TURN OFF is selected, please remember if the picture is freezing. Do not mistake freezing for a malfunction.
<p>SOURCE NAME</p>	<p>Each input port for this projector can have a name applied to it.</p> <p>(1) Use the ▲/▼ buttons on the SCREEN menu to select SOURCE NAME and press the ► button. The SOURCE NAME menu will be displayed.</p>  <p>(2) Use the ▲/▼ buttons on the SOURCE NAME menu to select the port to be named and press the ► button. Right side of the menu is blank until a name is specified. The SOURCE NAME dialog will be displayed.</p>  <p>(3) The current name will be displayed on the first line. Use the ▲/▼/◀/▶ buttons and the ENTER or INPUT button to select and enter characters. The RESET button can be used to erase 1 character at a time. The name can be a maximum of 16 characters.</p>  <p>(4) To change an already inserted character, press the ▲ button while the cursor is on the [A-N] row to move the cursor to the name displayed on the first line and use the ◀/▶ buttons to select character to be changed. Once a character in the name is selected use the ▼ button to move the cursor back down to the character entry area to select and enter characters as described above.</p>  <p>(5) Select <input checked="" type="checkbox"/> and press the ENTER or INPUT buttons when finished entering text. To revert to the previous name without saving changes press the ESC or ◀ button and the INPUT button simultaneously.</p>

OPTION Menu

From the OPTION menu, items shown in the table below can be performed.

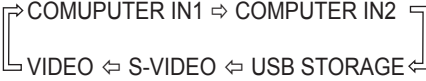

Select an item using the ▲/▼ cursor buttons, and press the ► cursor button or ENTER button to execute the item, except for the items LAMP TIME and FILTER TIME. Then perform it according to the following table.

MENU [COMPUTER]		SELECT
PICTURE	AUTO SEARCH	TURN ON
IMAGE	AUTO KEYSTONE	TURN ON
INPUT	AUTO ON	TURN ON
SETUP	AUTO OFF	0 min
SCREEN	LAMP TIME	1234 h
	FILTER TIME	123 h
OPTION	MY BUTTON	
EASY MENU	SERVICE	
	SECURITY	
	USB STORAGE	2

Item	Description
AUTO SEARCH	<p>Using the ▲/▼ buttons turns on/off the automatic signal search function. TURN ON ⇔ TURN OFF</p> <p>When the TURN ON is selected, detecting no signal automatically cycles through input ports in the following order. The search is started from the current port. Then when an input is found, the projector will stop searching and display the image.</p> <p style="text-align: center;">  </p>
AUTO KEYSTONE 	<p>Using the ▲/▼ buttons turns on/off the automatic keystone function. TURN ON ⇔ TURN OFF</p> <p>TURN ON : Automatic keystone distortion correction will be executed whenever changing the slant of the projector.</p> <p>TURN OFF : This function is disabled. Please execute the AUTO KEYSTONE  EXECUTE in the SETUP Menu for automatic keystone distortion correction.</p> <ul style="list-style-type: none"> • When the projector is suspended from the ceiling this feature will not function properly so select the TURN OFF. • This function will be unavailable when the Transition Detector is on.
AUTO ON	<p>Using the ▲/▼ buttons turns on/off the AUTO ON function. TURN ON ⇔ TURN OFF</p> <p>When set to the TURN ON, the lamp in projector will be automatically turned on without the usual procedure, only when the projector is supplied with the power after the power was cut while the lamp was on.</p> <ul style="list-style-type: none"> • This function does not work as long as the power has been supplied to the projector while the lamp is off. • After turning the lamp on by the AUTO ON function, if neither input nor operation is detected for about 30 minutes, the projector is turned off, even though the AUTO OFF function is disabled.

(continued on next page)

OPTION Menu (continued)

Item	Description
<p>AUTO OFF</p>	<p>Using the ▲/▼ buttons adjusts the time to count down to automatically turn the projector off. Long (max. 99 minutes) ⇔ Short (min. 0 minute = DISABLE)</p> <div style="display: flex; justify-content: space-around; align-items: center;">   </div> <p>When the time is set to 0, the projector is not turned off automatically. When the time is set to 1 to 99, and when the passed time with no-signal or an unsuitable signal reaches at the set time, the projector lamp will be turned off. If one of the projector's buttons or the remote control buttons is pressed or one of the commands (except get commands) is transmitted to the control port during the corresponding time, projector will not be turned off. Please refer to the section "Turning off the power".</p>
<p>LAMP TIME</p>	<p>The lamp time is the time counted after the last resetting. It is shown in the OPTION menu as the usage time of the lamp. Pressing the RESET button or the ► button displays a dialog. To reset the lamp time, select the RESET using the ▲ button. RESET ⇔ CANCEL</p> <ul style="list-style-type: none"> • Please reset the lamp time only when you have replaced the lamp, for a suitable indication about the lamp. • For the lamp replacement, see the section "Lamp".
<p>FILTER TIME</p>	<p>The filter time is the time counted after the last resetting. It is shown in the OPTION menu as the usage time of the air filter. Pressing the RESET button or the ► button displays a dialog. To reset the filter time, select the RESET using the ▲ button. RESET ⇔ CANCEL</p> <ul style="list-style-type: none"> • Please reset the filter time only when you have cleaned or replaced the air filter, for a suitable indication about the air filter. • For the air filter cleaning, see the section "Air filter".

(continued on next page)

OPTION Menu (continued)

Item	Description
<p>MY BUTTON</p>	<p>This item is to assign one of the following function to MY BUTTON 1 and 2 on the remote control. Choose 1 or 2 on the MY BUTTON menu using the ◀/▶ button first. Then using the ▲/▼ buttons sets one of the following functions to the chosen button.</p> <ul style="list-style-type: none"> • COMPUTER1: Sets port to COMPUTER IN1. • COMPUTER2: Sets port to COMPUTER IN2. • USB STORAGE: Sets port to USB STORAGE. • S-VIDEO: Sets port to S-VIDEO. • VIDEO: Sets port to VIDEO. • INFORMATION: Displays a dialog of INPUT INFORMATION. • AUTO KEYSTONE [] EXECUTE: Performs automatic keystone distortion correction. • MY MEMORY: Loads one of adjustment data stored. <p>When the current adjustment is not saved to memory a dialog is displayed.</p> <p>When no data is saved in memory, a dialog is displayed.</p> <div style="display: flex; justify-content: space-around; align-items: center;"> <div style="border: 1px solid black; background-color: #000080; color: white; padding: 5px;"> <p>Temporary condition</p> <p>MEMORY : Recall saved parameters</p> <p>◀ : Quit</p> </div> <div style="border: 1px solid black; background-color: #000080; color: white; padding: 5px;"> <p>No saved data</p> </div> </div> <p>If you want to keep the current adjustment, please press the ◀ button to quit. Otherwise the current adjusted condition will be lost by loading a data.</p> <ul style="list-style-type: none"> • PICTURE MODE: Changes the PICTURE MODE. • FILTER RESET: Displays the filter time reset confirmation dialogue. • VOLUME+: Set the volume up. • VOLUME-: Set the volume down.
<p>SERVICE</p>	<p>Selecting this item displays the SERVICE menu. Select an item using the ▲/▼ buttons, and press the ▶ button or the ENTER button to execute the item.</p> <p style="text-align: center;"> FAN SPEED ⇄ AUTO ADJUST ⇄ GHOST ⇄ FILTER MESSAGE ⇄ KEY LOCK ↕ ↙ FACTORY RESET ⇄ INFORMATION ⇄ REMOTE FREQ. ↘ </p> <p>FAN SPEED</p> <p>Using the ▲/▼ buttons switches the rotation speed of the cooling fans. The HIGH is the mode for use at highlands etc. Note that the projector is noisier when the HIGH is selected.</p> <p>HIGH ⇄ NORMAL</p> <div style="text-align: right;">  </div>

(continued on next page)

OPTION Menu (continued)

Item	Description
<p>SERVICE (continued)</p>	<p>AUTO ADJUST Using the ▲/▼ buttons enables/disables the automatic adjustment. When DISABLE is selected, the automatic adjustment feature is disabled, although rough adjustment is automatically performed depending on the basic setting.</p> <p>FINE ⇄ FAST ⇄ DISABLE </p> <p>FINE: Finer tuning including H.SIZE adjustment. FAST: Faster tuning, setting H.SIZE to prearranged data for the input signal</p> <ul style="list-style-type: none"> Depending on conditions, such as input image, signal cable to the projector, environment around the projector, etc., the automatic adjustment may not work correctly. In such a case, please choose DISABLE to disable the automatic adjustment, and make adjustment manually.
	<p>GHOST</p> <ol style="list-style-type: none"> Select a color element of ghost using the ◀/▶ buttons. Adjust the selected element using the ▲/▼ buttons to disappear ghost.
	<p>FILTER MESSAGE Use the ▲/▼ button to set the timer for the interval to show the message for cleaning up the air filter.</p> <p>50h ⇄ 100h ⇄ 200h ⇄ 300h ⇄ TURN OFF</p> <p>After selecting “50h”, “100h”, “200h”, or “300h”, the message “REMINDER *** HRS PASSED AFTER THE LAST FILTER CHECK” will appear after the timer reaches the interval time set by the menu. When the “TURN OFF” is chosen, the air filter cleaning message will not appear.</p> <ul style="list-style-type: none"> Please check and clean the air filter periodically, even if there is no message. If the air filter becomes to be blocked by dust or others, the internal temperature will rise, which could cause malfunction, or reduce the lifetime of the projector. It is recommended to choose “100h” in general. Please be careful with the operating environment of the projector and the condition of the air filter, especially when the “200h”, “300h” or “TURN OFF” is chosen.

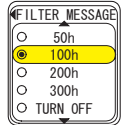
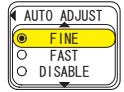



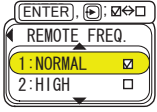
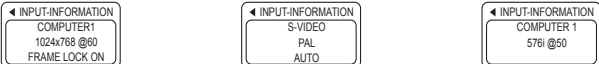

(continued on next page)

OPTION Menu (continued)

Item	Description
<p>SERVICE (continued)</p>	<p>KEY LOCK Using the ▲/▼ buttons turns on/off the key lock feature. When TURN ON is selected, the buttons on the projector except the STANDBY/ON button are locked. TURN ON ⇔ TURN OFF</p> <ul style="list-style-type: none"> • Please use to avoid a mischief and touching accidentally. This function does not have any effect on the remote control. <p>REMOTE FREQ. Use the ▲/▼ button to change the Projector's remote sensor setting. 1:NORMAL ⇔ 2:HIGH</p> <p>Items with a checkmark are on. The factory default setting is for both 1:NORMAL and 2: HIGH to be on. If the remote control does not function correctly set this to either only 1 or only 2. Neither can be turned off at the same time.</p>  <p>INFORMATION Selecting this item displays a dialog titled "INPUT INFORMATION". It shows the information about the current input.</p>  <ul style="list-style-type: none"> • The "FRAME LOCK" message on the dialog means the frame lock function is working. • This item can't be selected for no signal and sync out. <p>FACTORY RESET Selecting RESET using the button ▲ performs this function. By this function, all the items in all of menus will collectively return to the initial setting. Note that the items LAMP TIME, FILTER TIME, LANGUAGE and SECURITY are not reset. RESET ⇔ CANCEL</p>

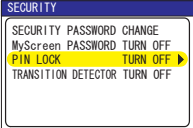
(continued on next page)

OPTION Menu (continued)

Item	Description	
<p style="text-align: center;">SECURITY</p>	<p>This projector is equipped with security functions. User registration is required before using the security functions. Please contact your local dealer.</p>	
	<p>1. Using Security Features</p>	
	<p>1.1 Inputting the PASSWORD</p>	
	<p>1.1-1 Use the ▲/▼ buttons on the OPTION menu to select SECURITY and press the ► button. The ENTER PASSWORD box will be displayed.</p> <p>The factory default PASSWORD is 5606. This PASSWORD can be changed (1.2 Changing the PASSWORD).</p> <ul style="list-style-type: none"> It is strongly recommended the factory default PASSWORD to be changed as soon as possible. 	
	<p>1.1-2 Use the ▲/▼/◀/▶ buttons to enter the registered PASSWORD. Move the cursor to the right side of the ENTER PASSWORD BOX and press the ► button to display the SECURITY menu.</p> <p>If an incorrect PASSWORD is input the ENTER PASSWORD BOX will be displayed again. If incorrect PASSWORD is input 3 times the projector will turn off. Afterwards the projector will turn off every time an incorrect PASSWORD is input.</p>	
<p>1.2 Changing the PASSWORD</p>		
<p>1.2-1 Use the ▲/▼ buttons on the SECURITY menu to select SECURITY PASSWORD CHANGE and press the ► button to display the ENTER NEW PASSWORD BOX.</p>		
<p>1.2-2 Use the ▲/▼/◀/▶ buttons to enter the new PASSWORD.</p>		
<p>1.2-3 Move the cursor to the right side of the ENTER NEW PASSWORD BOX and press the ► button to display the NEW PASSWORD AGAIN BOX, enter the same PASSWORD again.</p>		
<p>1.2-4 Move the cursor to the right side of the NEW PASSWORD AGAIN BOX and press the ► button and the NOTE NEW PASSWORD BOX will be displayed for about 20 seconds, please make note of the PASSWORD during this time.</p>		
<p>Pressing the ENTER button will close the NOTE NEW PASSWORD BOX.</p>		
<p>• Please do not forget your PASSWORD.</p>		

(continued on next page)

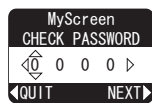
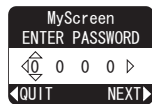
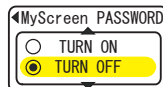

OPTION Menu (continued)

Item	Description
<p>SECURITY (continued)</p>	<p>1.3 If you have forgotten your PASSWORD</p> <p>1.3-1 Follow the procedure in 1.1-1 to display the ENTER PASSWORD BOX.</p> <p>1.3-2 While the ENTER PASSWORD BOX is displayed, press and hold the RESET button for about 3 seconds or press and hold the INPUT and ► buttons on the projector for about 3 seconds</p> <p>The 10 digit Inquiring Code will be displayed.</p> <ul style="list-style-type: none"> • If there is no key input for about 55 seconds while the Inquiring Code is displayed the menu will close. If necessary repeat the process from 1.3-1. <p>1.3-3 Contact your dealer with the 10 digit Inquiring Code. Your PASSWORD will be sent after your user registration information is confirmed.</p>
	<p>2. Using the MyScreen PASSWORD Function</p> <p>The MyScreen PASSWORD function can be used to prohibit access to the MyScreen function and prevent the currently registered MyScreen image from being overwritten.</p> <p>2.1 Turning on the MyScreen PASSWORD Function</p> <p>2.1-1 Use the ▲/▼ buttons on the SECURITY menu to select MyScreen PASSWORD and press the ► button to display the MyScreen PASSWORD on/off menu.</p>
	<p>2.2 Setting the PASSWORD</p> <p>2.2-1 Display the MyScreen on/off menu using the procedure in 2.1-1.</p> <p>2.2-2 Use the ▲/▼ buttons on the MyScreen PASSWORD on/off menu to select TURN ON. The ENTER PASSWORD BOX (small) will be displayed.</p>
	<p>2.2-3 Use the ▲/▼/◀/▶ buttons to enter the PASSWORD. Move the cursor to the right side of the ENTER PASSWORD BOX (small) and press the ► button to display the CHECK PASSWORD BOX, enter the same PASSWORD again.</p>



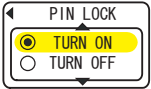

(continued on next page)

OPTION Menu (continued)

Item	Description
<p>SECURITY (continued)</p>	<p>2.2-4 Move the cursor to the right side of the CHECK PASSWORD BOX and press the ► button to display the PASSWORD for about 20 seconds, please make note of the PASSWORD during this time.</p>  <p>Pressing the ENTER button will return to MyScreen PASS WORD on/off menu.</p> <p>When a PASSWORD is set for MyScreen:</p> <ul style="list-style-type: none"> • The MyScreen registration function (and menu) will be unavailable. • The MyScreen Lock function (and menu) will be unavailable. • The START UP setting will be locked on MyScreen (and the menu will be unavailable). <p>Turning the MyScreen PASSWORD off will allow normal operation of both functions.</p> <ul style="list-style-type: none"> • Please do not forget your MyScreen PASSWORD.
	<p>2.3 Turning the PASSWORD off</p> <p>2.3-1 Follow the procedure in 2.1-1 to display the MyScreen PASSWORD on/off menu.</p> <p>2.3-2 Select TURN OFF to display the ENTER PASSWORD BOX (large). Enter the registered PASSWORD and the screen will return to the MyScreen on/off menu.</p> <p>If an incorrect PASSWORD is input the menu will close. If necessary repeat the process from 2.3-1.</p>
	<p>2.4 If you have forgotten your PASSWORD</p> <p>2.4-1 Follow the procedure in 2.1-1 to display the MyScreen PASSWORD on/off menu.</p> <p>2.4-2 Select TURN OFF to display the ENTER PASSWORD BOX (large). The 10 digit Inquiring Code will be displayed inside the BOX.</p>  <p>2.4-3 Contact your dealer with the 10 digit Inquiring Code. Your PASSWORD will be sent after your user registration information is confirmed.</p>
	<p>3. Using the PIN LOCK Function</p> <p>PIN LOCK is a function which prevents the projector from being used unless a registered Code is input.</p> <p>3.1 Registering the PIN Code</p> <p>3.1-1 Use the ▲/▼ buttons on the SECURITY menu to select PIN LOCK and press the ► button or the ENTER button to display the PIN LOCK on/off menu.</p> 



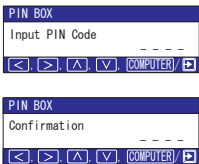

(continued on next page)

OPTION Menu (continued)

Item	Description
<p>SECURITY (continued)</p>	<p>3.1-2 Use the ▲/▼ buttons on the PIN LOCK on/off menu to select TURN ON and the PIN BOX will be displayed.</p> <p>3.1-3 Input a 4 part PIN Code using the ▲, ▼, ◀, ▶, COMPUTER/STORAGE and INPUT buttons.</p> <p>A CONFIRMATION BOX will appear. Reenter the same PIN Code. This will complete the PIN Code registration.</p> <ul style="list-style-type: none"> • If there is no key input for about 55 seconds while the PIN BOX or the CONFIRMATION BOX are displayed the menu will close. If necessary repeat the process from 3.1-1. <p>Afterwards, anytime the projector is restarted after the power switch is turned off the PIN BOX will be displayed. Enter the registered PIN Code. The projector can be used after entering the registered PIN Code. If an incorrect PIN Code is input the PIN BOX will be displayed again. If an incorrect PIN Code is input 3 times the projector will turn off. Afterwards the projector will turn off every time an incorrect PIN Code is input. The projector will also turn off if there is no key input for about 5 minutes while the PIN BOX is displayed.</p> <p>This function will activate only when the projector is started after the power switch was turned off.</p> <ul style="list-style-type: none"> • Please do not forget your PIN Code. <p>3.2 Turning Off the PIN LOCK Function</p> <p>3.2-1 Follow the procedure in 3.1-1 to display the PIN LOCK on/off menu. Use the ▲/▼ buttons to select TURN OFF and the PIN BOX will be displayed.</p> <p>Enter the registered PIN Code to turn the PIN LOCK function off. If an incorrect PASSWORD is entered the menu will close.</p> <p>3.3 If you have forgotten your PIN Code</p> <p>3.3-1 While the PIN BOX is displayed, press and hold the RESET button for three seconds or press and hold the INPUT and ▶ buttons for three seconds. The 10 digit Inquiring Code will be displayed.</p> <ul style="list-style-type: none"> • If there is no key input for about 5 minutes while the Inquiring Code is displayed the projector will turn off. <p>3.3-2 Contact your dealer with the 10 digit Inquiring Code. Your PASSWORD will be sent after your user registration information is confirmed.</p>
	
	

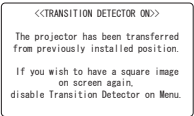
(continued on next page)

OPTION Menu (continued)

Item	Description
<p>SECURITY (continued)</p>	<p>4. Using the Transition Detector Function While the Transition Detector function is ON, when power switch is started to supply to the projector, it might react as below.</p> <ul style="list-style-type: none"> • Transition Detector alarm shown below might appear on screen, if the projector has been moved or re-installed. • Transition Detector alarm might appear on screen, if the MIRROR setting has been changed. • Keystone adjustment feature has been prohibited as long as the Transition Detector function is ON. <p>4.1 Turning On the Transition Detector Function</p> <p>4.1-1 Use the ▲/▼ buttons on the SECURITY menu to select Transition Detector and press the ► or the ENTER button to display the Transition Detector on/off menu.</p>  <p>Select TURN ON and the current angle and mirror setting will be recorded.</p> <ul style="list-style-type: none"> • This feature may not function properly if the projector is not in a stable position when TURN ON is selected. <p>4.1-2 If this function is set to TURN ON when the vertical angle of the projector or mirror setting at which the projector is turned on is different than the previously recorded the Transition Detector Alarm will be displayed and the projector will not display the input signal.</p>  <p>Set the Transition Detector off in the SECURITY menu to display the input signal. If the Transition Detector ALARM is displayed for about 5 minutes the lamp will turn off. This function will activate only when the projector is started after the power switch was turned off.</p> <p>4.2 Setting the Transition Detector PASSWORD</p> <p>4.2-1 Use the ▲/▼ buttons on the SECURITY menu to select Transition Detector and press the ► or the ENTER button to display the Transition Detector on/off menu.</p> <p>4.2-2 Use the ▲/▼ buttons on the Transition Detector on/off menu to select TURN ON. The ENTER PASSWORD BOX (small) will be displayed.</p>  <p>4.2-3 Use the ▲/▼/◀/▶ buttons to enter a PASSWORD. Move the cursor to the right side of the ENTER PASSWORD BOX (small) and press the ► button to display the CHECK PASSWORD BOX, enter the same PASSWORD again.</p>  <p>4.2-4 Move the cursor to the right side of the CHECK PASSWORD BOX and press the ► button to display the PASSWORD for about 20 seconds, please make note of the PASSWORD during this time.</p>  <p>Pressing the ENTER button will return to the Transition Detector on/off menu.</p> <ul style="list-style-type: none"> • Please do not forget your Transition Detector PASSWORD.

(continued on next page)

OPTION Menu (continued)

Item	Description
<p>SECURITY (continued)</p>	<p>4.3 Setting the Transition Detector off</p> <p>4.3-1 Follow the procedure in 4.1-1 to display the Transition Detector on/off menu.</p> <p>4.3-2 Select TURN OFF to display the ENTER PASSWORD BOX (large). Enter the registered PASSWORD and the screen will return to the Transition Detector on/off menu. If an incorrect PASSWORD is input the menu will close. If necessary repeat the process from 4.3-1.</p> <p>4.4 If you have forgotten your PASSWORD</p> <p>4.4-1 Follow the procedure in 4.1-1 to display the Transition Detector on/off menu.</p> <p>4.4-2 Select TURN OFF to display the ENTER PASSWORD BOX (large). The 10 digit Inquiring Code will be displayed inside the BOX.</p> <p>4.4-3 Contact your dealer with the 10 digit Inquiring Code. Your PASSWORD will be sent after your user registration information is confirmed.</p>
<p>USB STORAGE</p>	<p>Pressing the ► button displays the USB STORAGE KEY CONFIG. Menu.</p> <p>For more information, please see the “1) Button operation for still image” of the “Displaying an image in full screen” under the “USB STORAGE”.</p>

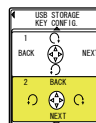
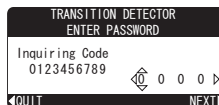

USB STORAGE

This projector has “PC Less presentation” feature that can display following files stored in USB storage or display as thumbnail without connecting PC.

NOTE 1

- Compliant file format

File Format	Maximum pixel size
JPEG	8176 x 8176
M-JPEG (Motion-JPEG)	640 x 480
MPEG4	352 x 288

Progressive JPEG file cannot be reproduced.

Some JPEG files may not possible to display the image clearly.

- Compliant Audio format

Audio Format	Container format (file extension)
8bit or 16bit linear PCM	AVI, MP4
μ-law	AVI, MP4
IMA-ADPCM	AVI
4bit G.726 ADPCM	ASF
MPEG1 Layer II Audio	

MPEG1 Layer III Audio and AAC(Advanced Audio Coding) can not be reproduced.

In combinations of file format and audio format described in the above lists, some files can not be reproduced.

- USB STORAGE

- USB1.1 compliant USB storage media (Mass Storage class) can be used.
- Some USB memories may not work correctly.
- Security USB memory is not supported.
- It is strongly recommended to use AC Power Adaptor with USB Hard Disc.
- It may be happened that movie files or sound files cannot be reproduced properly if USB storage does not have enough access speed.
- The following formats are recommended for USB storage
 - USB memory FAT12/FAT16/FAT32 (NTFS format is not supported.)
 - USB hard disk FAT12/FAT16/FAT32 (NTFS format is not supported.)

Displaying Thumbnail Menu

- 1) Save image files in a USB storage. Insert the USB storage into USB STORAGE port on the projector.
- 2) Change input port for the projector to USB STORAGE using COMPUTER/STORAGE button on the remote control or INPUT/ENTER button on the projector so that Thumbnail menu below is appeared on screen.
- 3) On Thumbnail menu, the following features are supported.
 - Projector Control: Have Easy/Advanced Menu on screen to control the projector, or change the input port to S-VIDEO.
 - Thumbnail display: Display many stored images in USB storage at once.
 - Slide show: Switch images with set intervals.
 - Display in full screen: Display one still picture or moving picture in full screen. (It is not in Thumbnail menu.)

Displaying Thumbnail Menu (continued)

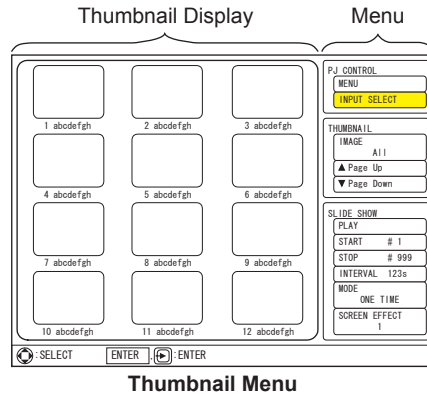

Displaying Thumbnail Menu (continued.)

The “PC-LESS Presentation” can be controlled via control panel on the projector or the remote control.

Following button operations can be valid while Thumbnail menu is displayed.

Item	Description
▲/▼/◀/▶ on Remote control /Control panel	Move cursor
“ENTER” on Remote control “INPUT/ENTER” on Control panel	Works as ENTER function - Display selected image in full screen, when the cursor is pointed one of the image on Thumbnail Display in Thumbnail menu. - Select Thumbnail Menu item, when the cursor is at the menu in Thumbnail menu.

NOTE 2

- Do not connect any apparatus other than USB storage devices and other equipments for battery charge through USB. It causes malfunction.
- Insert only one memory card even though USB card reader having multiple slots for memory card is used. Pictures in multiple memories cannot be seen at the same time.
- The OSD message “No Media” is displayed, if there is no memory card with USB card reader.
- During blinking LED on USB card reader, which indicates the access to the reader, or displaying “Media loading...”, do not turn the projector into the power off/standby mode nor remove/insert USB cable and memory card.
- Following message might appear when projector input port is changed to [USB STORAGE].

Displaying Thumbnail Menu (continued)

Message	Description
No Media	USB storage is not inserted into USB STORAGE slot on the projector.
Broken Media	This is an alarm message that USB storage inserted into USB STORAGE slot on the projector is broken.
Bad format	This is an alarm message that USB storage inserted into USB STORAGE slot on the projector has a noncompliant format.
Media loading	Loading files in the USB storage inserted into USB STORAGE slot on the projector. Please wait for a while.
Ready	Preparation of thumbnail display for the USB storage inserted into USB STORAGE slot on the projector has been completed. Please wait for a while more.

- Do not use this function other than private purposes. It might infringe copyright laws.
- Back up all of the data in the memory card, in case any data are lost due to unexpected accident. Any liability for the loss by mistake or malfunction shall not be assumed.
- Depends on USB Storage Devices, Thumbnail display might disappears once at the beginning of connection and comes again.

Controlling the projector

While Thumbnail menu is on screen, some buttons on the projector and remote control are assigned some designated functions to support the menu operation. If normal EASY or Advanced MENU on screen, or INPUT SELECT function is required, select PJ CONTROL item on the Thumbnail menu.

Use ▲, ▼, ◀ and ▶ buttons to move a cursor to the PJ CONTROL item in Thumbnail menu. Push ENTER button on the remote control or INPUT/ENTER button on the projector to decide the selected item. Following items can be controlled.

PJ CONTROL items

Item	Description
MENU	Display EASY/Advanced MENU of the projector. Select [MENU] using ▲, ▼, ◀ and ▶ buttons, then push ENTER button on the remote control or INPUT/ENTER button on the projector.
INPUT SELECT	Change input port of the projector. Select [INPUT SELECT] using ▲, ▼, ◀ and ▶ buttons, then push ENTER button on the remote control or INPUT/ENTER button on the projector, so the input port will be changed from USB STORAGE to S-VIDEO. Then, Thumbnail menu will be disappeared.

Displaying Thumbnail image

Image files in USB storage can be seen as thumbnail display. Use ▲, ▼, ◀ and ▶ buttons to move a cursor to THUMBNAIL item in Thumbnail menu. Push ENTER button on the remote control or INPUT/ENTER button on the projector to decide it.

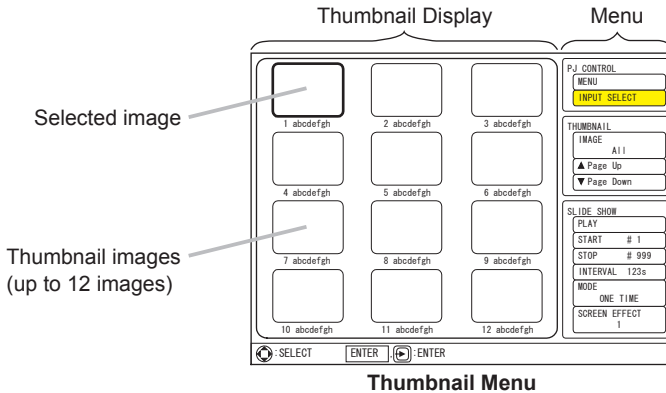

THUMBNAIL items

Item	Description
IMAGE	<p>Select image files to display as thumbnail.</p> <ol style="list-style-type: none"> Select [IMAGE] using ▲, ▼, ◀ and ▶ buttons, then push ENTER button on the remote control or INPUT/ENTER button on the projector so that [IMAGE] setting can be selected. Change [IMAGE] setting using ▲ and ▼ buttons. ALL (Display all) ↔ STILL PICTURE (Display still picture only) ⇕ ⇕ MOTION PICTURE (Display motion picture only) Get out from the status that [IMAGE] setting is selectable, by pushing ENTER button on the remote control or INPUT/ENTER button on the projector.
Page Up	<p>Move to previous thumbnail display page. (When current thumbnail display shows image files between 13th and 24th, it shows image files between 1st and 12th after move.)</p> <p>Select [Page Up] using ▲, ▼, ◀ and ▶ buttons, then push ENTER button on the remote control or INPUT/ENTER button on the projector. [Page Up] key on remote also can be used.</p>
Page Down	<p>Move to following thumbnail display page. (When current thumbnail display shows image files between 1st and 12th, it shows image files between 13th and 24th after move.)</p> <p>Select [Page Down] using ▲, ▼, ◀ and ▶ buttons, then push ENTER button on the remote control or INPUT/ENTER button on the projector. [Page Down] button on remote also can be used.</p>

Displaying Thumbnail image (continued)

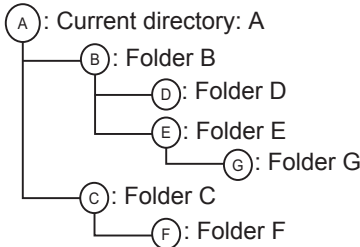

NOTE 3

- Up to 999 files can be displayed
- Files are sorted in the following order. 1) Symbols, 2) Numbers, 3) Characters
- File name can be displayed up to 16 characters including file extension.
- The characters of following languages can be used for file name. If other languages are used, the file name is not displayed properly, but the content can be displayed.
English, French, German, Spanish, Italian, Norwegian, Dutch, Portuguese, Swedish, Russian, Finnish, Polish and Turkish.
- Folders in USB storage can be recognized up to 3 layers. The priority of thumbnail display for image files is as follows.



File display priority in folder : A > B > C > D > E > F
Folder G: Cannot be displayed because it is 4th layer.

- Picture may not be displayed correctly, depending on the connecting device in case that an extended USB cable is used.
- Response time might vary depending on each image contents when switching pages, loading files and playing each movie.
- When there are following icons on thumbnail display, it might be non-compliant file. Check the saved file in USB storage.

Icon	Description
	This is un-displayable file. Check the format of saved file. Refer to NOTE1
	This motion picture file does not contain audio clip or cannot be reproduced sound. Refer to NOTE 1

Playing Slide show

SLIDE SHOW can displays a full screen image and change it to the next one in desired interval time.

Use ▲, ▼, ◀ and ▶ buttons to move a cursor to SLIDE SHOW item in Thumbnail menu. push ENTER button on the remote control or INPUT/ENTER button on the projector to decide it.

SLIDE SHOW items

Item	Description
PLAY	Starts "SLIDE SHOW". Select [PLAY] using ▲, ▼, ◀ and ▶ buttons, then push ENTER button on the remote control or INPUT/ENTER button on the projector.
START	Specify and select image file number in thumbnail display as starting number for "SLIDE SHOW". 1. Select [START] using ▲, ▼, ◀ and ▶ buttons, then push ENTER button on the remote control or INPUT/ENTER button on the projector, so that [START] setting can be selected. 2. Change [START] setting (range from 1 to 999) using ▲ and ▼ buttons. 3. Get out from the status that [START] setting is selectable, by pushing ENTER button on the remote control or INPUT/ENTER button on the projector.
STOP	Specify and select image file number in thumbnail display as finishing number for "SLIDE SHOW". 1. Select [STOP] using ▲, ▼, ◀ and ▶ buttons, then push ENTER button on the remote control or INPUT/ENTER button on the projector, so that [STOP] setting can be selected. 2. Change [STOP] setting (range from 1 to 999) using ▲ and ▼ buttons. 3. Get out from the status that [STOP] setting is selectable, by pushing ENTER button on the remote control or INPUT/ENTER button on the projector.
INTERVAL	Specify and select page forwarding interval for "SLIDE SHOW". 1. Select [INTERVAL] using ▲, ▼, ◀ and ▶ buttons, then push ENTER button on the remote control or INPUT/ENTER button on the projector so that [INTERVAL] setting can be selected. 2. Change [INTERVAL] setting (range from 1 to 999 seconds) using ▲ and ▼ buttons. 3. Get out from the status that [INTERVAL] setting is selectable, by pushing ENTER button on the remote control or INPUT/ENTER button on the projector.

(continued on next page)

Playing Slide show (continued)

SLIDE SHOW items (continued)

Item	Description
MODE	<p>Select SLIDE SHOW playing at ONE TIME or ENDLESS.</p> <ol style="list-style-type: none"> Select [MODE] using ▲, ▼, ◀ and ▶ buttons, then push ENTER button on the remote control or INPUT/ENTER button on the projector, so that [MODE] setting can be selected. Change [MODE] setting using ▲ and ▼ buttons. <div style="text-align: center;"> ONE TIME ⇔ ENDLESS (Playing Slide Show only one time) (Playing Slide Show endless) </div> Get out from the status that [MODE] setting is selectable, by pushing ENTER button on the remote control or INPUT/ENTER button on the projector.
SCREEN EFFECT	<p>Select SCREEN EFFECT for slide change in SLIDE SHOW.</p> <ol style="list-style-type: none"> Select [SCREEN EFFECT] using ▲, ▼, ◀ and ▶ buttons, then push ENTER button on the remote control or INPUT/ENTER button on the projector so that [SCREEN EFFECT] setting can be selected. Change [SCREEN EFFECT] setting using ▲ and ▼ buttons. <div style="text-align: center;"> OFF ⇔ 1 ⇔ 2 (no effect) (Sliced IN) (Minced IN) </div> Get out from the status that [SCREEN EFFECT] setting is selectable, by pushing ENTER button on the remote control or INPUT/ENTER button on the projector.

NOTE 4

- If the number specified for [START] is bigger than the number specified for [STOP], slide show is not executed.
- When the file size selected for SLIDE SHOW is big, the actual interval time may be longer than the set time at [INTERVAL] menu.
- When a motion image is selected for SLIDE SHOW, the next slide will be displayed after the play of the motion image is ended, regardless of whatever is set at [INTERVAL] menu.
- When [MODE] is set to “ONE TIME”, the last slide of the presentation will be hold on screen till either of ENTER button on the remote control or INPUT/ENTER button on the projector is pushed.

Displaying an image in full screen

One selected image file on Thumbnail menu can be displayed in full screen.

Use ▲, ▼, ◀ and ▶ buttons to move a cursor to select an image on Thumbnail menu.

Then, push ENTER button on the remote control or INPUT/ENTER button on the projector to display the selected image in full screen.

While in full screen mode, if one of these buttons is pushed one more time, the projector is back to Thumbnail display.

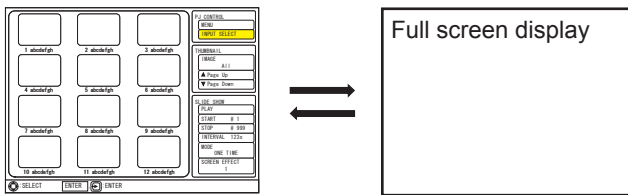

1) Button operation for still image

While still image is shown in full screen, the following operation can be made from the control panel on the projector or the remote control.



There are two type of KEY configurations for ▲/▼/◀/▶ button available. (USB STORAGE of the OPTION menu)

Button	Key CONFIG. 1	Key CONFIG. 2
UP	Turn around the image 90 degree clockwise.	Display previous image.
DOWN	Turn around the image 90 degree anticlockwise.	Display following image.
RIGHT	Display following image.	Turn around the image 90 degree clockwise.
LEFT	Display previous image.	Turn around the image 90 degree anticlockwise.
“ENTER” on Remote control “INPUT/ENTER” on Control panel	Displays thumbnail.	Displays thumbnail.

Displaying an image in full screen (continued)

2) Button operation for motion picture

While motion picture is shown in full screen, the following operation can be made from the control panel on the projector or the remote control.

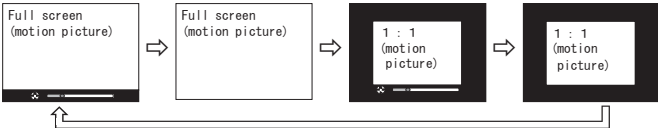
Button	Operation
UP	Pause and play motion picture. Play ⇄ Pause
DOWN	Play motion picture slowly. (half speed) Play ⇄ Play slowly (half speed)
RIGHT	Fast-forward motion picture. 
LEFT	Fast-rewind motion picture. 
UP (push for a while)	<p>While UP button is being pushed, the display mode is changed in every 2 seconds automatically.</p>  <p>You can choose one in 4 display modes of Display in full screen with the progress bar, Display in full screen without progress bar, 1:1 display with the progress bar or 1:1 display without progress bar.</p> <p>Note: The motion picture is paused or restored whenever UP button is pushed.</p>
“ENTER” on Remote control “INPUT/ENTER” on Control panel	Display thumbnails.

Maintenance

Lamp

A lamp has finite product life. Using the lamp for long periods of time could cause the pictures darker or the color tone poor. Note that each lamp has a different lifetime, and some may burst or burn out soon after you start using them.

Preparation of a new lamp and early replacement are recommended. To prepare a new lamp, contact your dealer and tell the lamp type number.

Type number : RLC-027

Replacing the lamp

1. Turn the projector off, and unplug the power cord. Allow the projector to cool for at least 45 minutes.
2. Prepare a new lamp. If the projector is mounted on a ceiling, or if the lamp has broken, also ask the dealer to replace the lamp.

In case of replacement by yourself,

3. Loosen the screw (marked by arrow) of the lamp cover and then slide the lamp cover to the side to remove it.
4. Loosen the 2 screws (marked by arrow) of the lamp, and slowly pick up the lamp by the handle. It may make it easy to take the lamp out slightly toward the control panel of the projector.
5. Insert the new lamp, and retighten firmly the 2 screws of the lamp that are loosened in the previous process to lock it in place. Tighten the screw ① first, then screw ②.
6. Slide the lamp cover back in place and firmly fasten the screw of the lamp cover.
7. Turn the projector on and reset the lamp time using the LAMP TIME item in the OPTION menu.
 - (1) Press the MENU button to display a menu.
 - (2) Point at the "Go to Advanced Menu ..." in the menu using the ▼/▲ button, then press the ► button.
 - (3) Point at the "OPTION" in the left column of the menu using the ▼/▲ button, then press the ► button.
 - (4) Point at the "LAMP TIME" using the ▼/▲ button, then press the ► button. A dialog will appear.
 - (5) Press the ▲ button to select "RESET" on the dialog. It performs resetting the lamp time.

The lamp cover

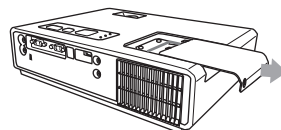
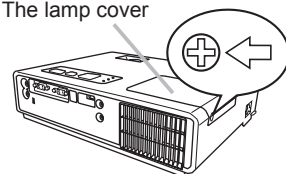

The handle

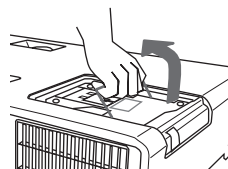
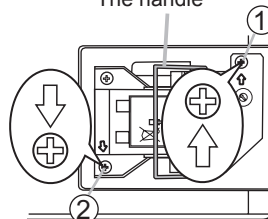

⚠ CAUTION ► Do not touch any inner space of the projector, while the lamp is taken out.

NOTE • Please reset the lamp time only when you have replaced the lamp, for a suitable indication about the lamp.

Lamp (continued)

Lamp warning

 **HIGH VOLTAGE**  **HIGH TEMPERATURE**  **HIGH PRESSURE**

⚠ WARNING ► The projector uses a high-pressure mercury glass lamp. The lamp can break with a loud bang, or burn out, if jolted or scratched, handled while hot, or worn over time. Note that each lamp has a different lifetime, and some may burst or burn out soon after you start using them. In addition, when the bulb bursts, it is possible for shards of glass to fly into the lamp housing, and for gas containing mercury to escape from the projector's vent holes.

► **About disposal of a lamp:** This product contains a mercury lamp; do not put it in a trash. Dispose of it in accordance with environmental laws.

- For lamp recycling, go to www.lamprecycle.org. (in the US).
- For product disposal, contact your local government agency or www.eiae.org (in the US) or www.epsc.ca (in Canada).

For more information, call your dealer.



Disconnect the plug from the power outlet

- If the lamp should break (it will make a loud bang when it does), unplug the power cord from the outlet, and make sure to request a replacement lamp from your local dealer. Note that shards of glass could damage the projector's internals, or cause injury during handling, so please do not try to clean the projector or replace the lamp yourself.
- If the lamp should break (it will make a loud bang when it does), ventilate the room well, and make sure not to breathe the gas that comes out of the projector vents, or get it in your eyes or mouth.
- Before replacing the lamp, turn the projector off and unplug the power cord, then wait at least 45 minutes for the lamp to cool sufficiently. Handling the lamp while hot can cause burns, as well as damaging the lamp.



- Never unscrew except the appointed (marked by an arrow) screws.
- Do not open the lamp cover while the projector is suspended from above. This is dangerous, since if the lamp's bulb has broken, the shards will fall out when the cover is opened. In addition, working in high places is dangerous, so ask your local dealer to have the lamp replaced even if the bulb is not broken.
- Do not use the projector with the lamp cover removed. At the lamp replacing, make sure that the screws are screwed in firmly. Loose screws could result in damage or injury.



- Use only the lamp of the specified type.
- If the lamp breaks soon after the first time it is used, it is possible that there are electrical problems elsewhere besides the lamp. If this happens, contact your local dealer or a service representative.
- Handle with care: jolting or scratching could cause the lamp bulb to burst during use.
- Using the lamp for long periods of time, could cause it dark, not to light up or to burst. When the pictures appear dark, or when the color tone is poor, please replace the lamp as soon as possible. Do not use old (used) lamps; this is a cause of breakage.

Air filter

Please check and clean the air filter periodically. When the indicators or a message prompts you to clean the air filter, comply with it as soon as possible. Replace the air filter when it is damaged or too soiled. To prepare a new air filter, contact ViewSonic and tell the air filter type number.

When you replace the lamp, please replace the air filter. An air filter of specified type will come together with a replacement lamp for this projector.

Cleaning the air filter

1. Turn the projector off, and unplug the power cord. Allow the projector to sufficiently cool down.
2. Use a vacuum cleaner on and around the filter cover.
3. While supporting the projector with one hand, use your other hand to pull the filter cover forward in the direction of the arrow.
4. Use a vacuum cleaner for the filter ventilation of the projector. And clean the air filter that is set at one side of the filter cover by using a vacuum cleaner over the other side of the filter cover. Please replace the air filter when it is damaged or too soiled. When the air filter is set, take its half moon shape cut part to the swelled part of the filter cover.
5. Put the filter unit back into the projector.
6. Turn the projector on and reset the filter time using the FILTER TIME item in the EASY MENU.
 - (1) Press the MENU button to display a menu.
 - (2) Point at the "FILTER TIME" using the ▼/▲ button, then press the ► button. A dialog will appear.
 - (3) Press the ▲ button to select "RESET" on the dialog. It performs resetting the filter time.



The filter cover



The air filter is set in the reverse side

Swelled part

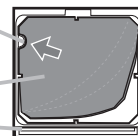

Air filter

Filter cover

⚠ WARNING ► Before taking care of the air filter, make sure the power cable is not plugged in, then allow the projector to cool sufficiently.

► Use only the air filter of the specified type. Do not use the projector without the air filter or the filter cover. It could result in a fire or malfunction to the projector.

► Clean the air filter periodically. If the air filter becomes clogged by dust or the like, internal temperatures rise and could cause a fire, a burn or malfunction to the projector.

NOTE • Please reset the filter time only when you have cleaned or replaced the air filter, for a suitable indication about the air filter.

• The projector may display the message such as "CHECK THE AIR FLOW" or turn off the projector, to prevent the internal heat level rising.

Other care

Inside of the projector

In order to ensure the safe use of your projector, please have it cleaned and inspected by your dealer about once every year.

Caring for the lens

If the lens is flawed, soiled or fogged, it could cause deterioration of display quality. Please take care of the lens, being cautious of handling.

1. Turn the projector off, and unplug the power cord. Allow the projector to cool sufficiently.
2. After making sure that the projector is cool adequately, lightly wipe the lens with a commercially available lens-cleaning wipe. Do not touch the lens directly with your hand.

Caring for the cabinet and remote control

Incorrect care could have adverse influence such as discoloration, peeling paint, etc.

1. Turn the projector off, and unplug the power cord. Allow the projector to cool sufficiently.
2. After making sure that the projector is cool adequately, lightly wipe with gauze or a soft cloth.

If the projector is extremely dirty, dip soft cloth in water or a neutral cleaner diluted in water, and wipe lightly after wringing well. Then, wipe lightly with a soft, dry cloth.

⚠WARNING ► Before caring, make sure the power cable is not plugged in, and then allow the projector to cool sufficiently. The care in a high temperature state of the projector could cause a burn and/or malfunction to the projector.

► Never try to care for the inside of the projector personally. Doing is so dangerous.

► Avoid wetting the projector or inserting liquids in the projector. It could result in a fire, an electric shock, and/or malfunction to the projector.

- Do not put anything containing water, cleaners or chemicals near the projector.

- Do not use aerosols or sprays.

⚠CAUTION ► Please take right care of the projector according to the following. Incorrect care could cause not only an injury but adverse influence such as discoloration, peeling paint, etc.

► Do not use cleaners or chemicals other than those specified in this manual.

► Do not polish or wipe with hard objects.

Troubleshooting

If an abnormal operation should occur, stop using the projector immediately.

⚠ WARNING ▶ Never use the projector if abnormal operations such as smoke, strange odor, excessive sound, damaged casing or elements or cables, penetration of liquids or foreign matter, etc. should occur. In such cases, immediately disconnect the power plug from the power outlet. After making sure that the smoke or odor has stopped, contact your dealer or service company.

Otherwise if a problem occurs with the projector, the following checks and measures are recommended before requesting repair.

If this does not resolve the problem, please contact your dealer or service company. They will tell you what warranty condition is applied.

Related messages

When some message appears, check and cope with it according to the following table. Although these messages will be automatically disappeared around several minutes, it will be reappeared every time the power is turned on.

Message	Description
<p>NO INPUT IS DETECTED ***</p>	<p>There is no input signal. Please confirm the signal input connection, and the status of the signal source.</p>
<p>SYNCHRO HORS PORTEE *** [fH] **kHz [fV] **Hz</p>	<p>The horizontal or vertical frequency of the input signal is not within the specified range. Please confirm the specs for your projector or the signal source specs.</p>
<p>CHECK THE AIR FLOW</p>	<p>The internal temperature is rising. Please turn the power off, and allow the projector to cool down at least 20 minutes. After having confirmed the following items, please turn the power ON again.</p> <ul style="list-style-type: none"> • Is there blockage of the air passage aperture? • Is the air filter dirty? • Does the peripheral temperature exceed 35°C? <p>If the same indication is displayed after the remedy, please set FAN SPEED of the SERVICE item in the OPTION menu to HIGH.</p>
<p>REMINDER *** HRS PASSED AFTER THE LAST FILTER CHECK. FILTER MAINTENANCE IS ESSENTIAL TO REMOVE WARNING MESSAGE. RESET FILTER TIMER. SEE MANUAL FURTHER INFO.</p>	<p>A note of precaution when cleaning the air filter. Please immediately turn the power off, and clean or change the air filter referring to the “Air Filter” section of this manual. After you have cleaned or changed the air filter, please be sure to reset the filter timer.</p>

Regarding the indicator lamps

When operation of the LAMP, TEMP and POWER indicators differs from usual, check and cope with it according to the following table.

POWER indicator	LAMP indicator	TEMP indicator	Description
Lighting In Orange	Turned off	Turned off	The projector is in a standby state. Please refer to the section "Power on/off".
<i>Blinking</i> In Green	Turned off	Turned off	The projector is warming up. Please wait.
Lighting In Green	Turned off	Turned off	The projector is in an on state. Ordinary operations may be performed.
<i>Blinking</i> In Orange	Turned off	Turned off	The projector is cooling down. Please wait.
<i>Blinking</i> In Red	(discre- tionary)	(discre- tionary)	The projector is cooling down. A certain error has been detected. Please wait until the POWER indicator finishes blinking, and then perform the proper measure using the item descriptions below.
<i>Blinking</i> In Red or Lighting In Red	Lighting In Red	Turned off	The lamp does not light, and there is a possibility that interior portion has become heated. Please turn the power off, and allow the projector to cool down at least 20 minutes. After the projector has sufficiently cooled down, please make confirmation of the following items, and then turn the power on again. • Is there blockage of the air passage aperture? • Is the air filter dirty? • Does the peripheral temperature exceed 35°C? If the same indication is displayed after the remedy, please change the lamp referring to the section "Lamp".
<i>Blinking</i> In Red or Lighting In Red	<i>Blinking</i> In Red	Turned off	The lamp cover has not been properly fixed. Please turn the power off, and allow the projector to cool down at least 45 minutes. After the projector has sufficiently cooled down, please make confirmation of the attachment state of the lamp cover. After performing any needed maintenance, turn the power on again. If the same indication is displayed after the remedy, please contact your dealer or service company.
<i>Blinking</i> In Red or Lighting In Red	Turned off	<i>Blinking</i> In Red	The cooling fan is not operating. Please turn the power off, and allow the projector to cool down at least 20 minutes. After the projector has sufficiently cooled down, please make confirmation that no foreign matter has become caught in the fan, etc., and then turn the power on again. If the same indication is displayed after the remedy, please contact your dealer or service company.

(continued on next page)

Regarding the indicator lamps (continued)

POWER indicator	LAMP indicator	TEMP indicator	Description
Blinking In Red or Lighting In Red	Turned off	Lighting In Red	<p>There is a possibility that the interior portion has become heated.</p> <p>Please turn the power off, and allow the projector to cool down at least 20 minutes. After the projector has sufficiently cooled down, please make confirmation of the following items, and then turn the power on again.</p> <ul style="list-style-type: none"> • Is there blockage of the air passage aperture? • Is the air filter dirty? • Does the peripheral temperature exceed 35°C? <p>If the same indication is displayed after the remedy, please set FAN SPEED of the SERVICE item in the OPTION menu to HIGH.</p>
Lighting In Green	Simultaneous blinking in Red		<p>It is time to clean the air filter.</p> <p>Please immediately turn the power off, and clean or change the air filter referring to the section “Air Filter”. After cleaning or changing the air filter, please be sure to reset the filter timer. After the remedy, reset the power to ON.</p>
Lighting In Green	Alternative blinking in Red		<p>There is a possibility that the interior portion has become overcooled.</p> <p>Please use the unit within the usage temperature parameters (5°C to 35°C). After the treatment, reset the power to ON.</p>

NOTE • When the interior portion has become overheated, for safety purposes, the projector is automatically shut down, and the indicator lamps may also be turned off. In such a case, disconnect the power cord, and wait at least 45 minutes. After the projector has sufficiently cooled down, please make confirmation of the attachment state of the lamp and lamp cover, and then turn the power on again.

Shutting the projector down

Only when the projector can not be turned off by usual procedure, please push the shutdown switch using a pin or similar, and disconnect the power plug from the power outlet. Before turning it on again, wait at least 10 minutes to make the projector cool down enough.

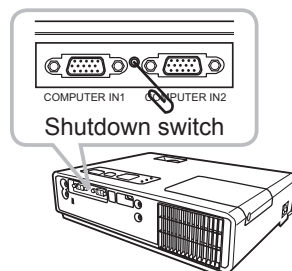

Resetting all settings

When it is hard to correct some wrong settings, the FACTORY RESET function of the SERVICE item in the OPTION menu can reset all settings(except LANGUAGE, FILTER TIME, LAMP TIME, FILTER MESSAGE and etc.) to the factory default.

Phenomena that may be easy to be mistaken for machine defects

About the phenomenon confused with a machine defect, check and cope with it according to the following table.

Phenomenon	Cases not involving a machine defect	Reference page
Power does not come on.	The electrical power cord is not plugged in. Correctly connect the power cord.	10
	The main power source has been interrupted during operation such as by a power outage (blackout), etc. Please disconnect the power plug from the power outlet, and allow the projector to cool down at least 10 minutes, then turn the power on again.	10, 13
	Either there is no lamp and/or lamp cover, or either of these has not been properly fixed. Please turn the power off and disconnect the power plug from the power outlet, and allow the projector to cool down at least 45 minutes. After the projector has sufficiently cooled down, please make confirmation of the attachment state of the lamp and lamp cover, and then turn the power on again.	57
Neither sounds nor pictures are outputted.	The signal cables are not correctly connected. Correctly connect the connection cables.	8
	Signal source does not correctly work. Correctly set up the signal source device by referring to the manual of the source device.	–
	The input changeover settings are mismatched. Select the input signal, and correct the settings.	14, 15
Sound does not come out.	The signal cables are not correctly connected. Correctly connect the audio cables.	8
	The MUTE function is working. Restore the sound pressing the MUTE or VOLUME button on the remote control.	14
	The volume is adjusted to an extremely low level. Adjust the volume to a higher level using the menu function or the remote control.	14
	The AUDIO setting is not correct. Correctly set the AUDIO in the SETUP menu.	32
No pictures are displayed.	The lens cover is attached. Remove the lens cover.	13
	The signal cables are not correctly connected. Correctly connect the connection cables.	8

(continued on next page)

Phenomena that may be easy to be mistaken for machine defects (continued)

Phenomenon	Cases not involving a machine defect	Reference page
No pictures are displayed. (continued)	The brightness is adjusted to an extremely low level. Adjust BRIGHTNESS to a higher level using the menu function or the remote control.	21, 23
	The computer cannot detect the projector as a plug and play monitor. Make sure that the computer can detect a plug and play monitor using another plug and play monitor.	9
	The BLANK screen is displayed. Press the BLANK button on the remote control.	19
Video screen display freezes.	The FREEZE function is working. Press the FREEZE button to restore the screen to normal.	19
Colors have a faded- out appearance, or Color tone is poor.	Color settings are not correctly adjusted. Perform picture adjustments by changing the COLOR TEMP, COLOR, TINT and/or COLOR SPACE settings, using the menu functions.	21, 24, 28
	COLOR SPACE setting is not suitable. Change the COLOR SPACE setting to AUTO, RGB, SMPTE240, REC709 or REC601.	28
Pictures appear dark.	The brightness and/or contrast are adjusted to an extremely low level. Adjust BRIGHTNESS and/or CONTRAST settings to a higher level using the menu function.	21, 23
	The WHISPER function is working. Select NORMAL for the WHISPER item in the SETUP menu.	22, 32
	The lamp is approaching the end of its product lifetime. Replace the lamp.	57
Pictures appear blurry.	Either the focus and/or horizontal phase settings are not properly adjusted. Adjust the focus using the focus ring, and/or H PHASE using the menu function.	16, 27
	The lens is dirty or misty. Clean the lens referring to the section "Caring for the lens".	60

NOTE • Although bright spots or dark spots may appear on the screen, this is a unique characteristic of liquid crystal displays, and it does not constitute or imply a machine defect.

Specifications

Specifications

Item		Specification
Product name		Liquid crystal projector
Liquid Crystal Panel	Panel size	1.6 cm (0.63 type)
	Drive system	TFT active matrix
	Pixels	786,432 pixels (1024 horizontal x 768 vertical)
Lens		Zoom lens F=1.8 ~ 1.9 f = 16.4~ 19.7 mm
Lamp		160W UHB
Speaker		1 W x1
Power supply		AC100-120V/2.8A, AC220-240V/1.4A
Power consumption		250 W
Temperature range		5 ~ 35°C (Operating)
Size		274 (W) x 59 (H) x 205 (D) mm * Not including protruding parts. Please refer to the following figure.
Weight (mass)		1.784 kg
Ports		<p>Computer input port COMPUTER IN1D-sub 15 pin mini x1 COMPUTER IN2D-sub 15 pin mini x1</p> <p>Video input port S-VIDEO.....S-video x1 VIDEO video x1</p> <p>Audio input/output port AUDIO INStereo mini x1 AUDIO OUTStereo mini x1</p> <p>Others USB STORAGEUSB-A x1 USBUSB-B x1</p>
Optional parts		<p>Lamp: RLC-027 Air filter: * Please consult your dealer.</p>

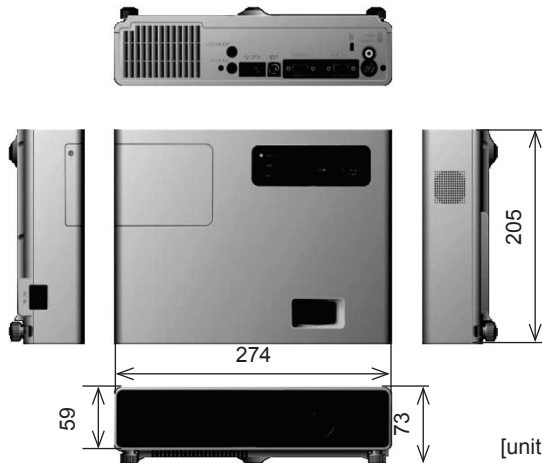

[unit: mm]

Customer Support

For technical support or product service, see the table below or contact your reseller.

Note : You will need the product serial number.

Country/Region	Web Site	T=Telephone F=Fax	E-mail
United States	www.viewsonic.com/support/	T= 800 688 6688 F= 909 468 1202	service.us@viewsonic.com
Canada	www.viewsonic.com/support	T= 866 463 4775	service.ca@viewsonic.com
United Kingdom	www.viewsoniceurope.com/uk	T= 0207 949 0307	service.eu@viewsoniceurope.com
Europe, Middle East, Baltic countries, and North Africa	www.viewsoniceurope.com	Contact your reseller	service.eu@viewsoniceurope.com
Australia and New Zealand	www.viewsonic.com.au/support/	AUS= 1800 880 818 NZ= 0800 008 822	service@au.viewsonic.com
Singapore/Malaysia/Thailand	www.viewsonic.com.sg/support/	T= 65 64616044	service@sg.viewsonic.com
South Africa/Other countries	www.viewsonic.com	T= 886 2 2246-3456 F= 886 2 2249-1751	service@sd.viewsonic.com
Hong Kong	www.hk.viewsonic.com/support/	T= 852 3102 2900	service@hk.viewsonic.com
Macau	www.hk.viewsonic.com/support/	T= 853 700 303	service@hk.viewsonic.com
Korea	www.viewsonic.com	T= 080 265 9080	service@kr.viewsonic.com

Limited Warranty

VIEWSONIC® PROJECTOR

What the warranty covers:

ViewSonic warrants its products to be free from defects in material and workmanship, under normal use, during the warranty period. If a product proves to be defective in material or workmanship during the warranty period, ViewSonic will, at its sole option, repair or replace the product with a like product. Replacement product or parts may include remanufactured or refurbished parts or components.

How long the warranty is effective:

North and South America: 3 years for all parts excluding the lamp, 3 years for labor, 1 year for the original lamp from the date of the first consumer purchase.

Europe: 3 years for all parts excluding the lamp, 3 years for labor, 1 year for the original lamp from the date of the first consumer purchase.

Other regions or countries: Please check with your local dealer or local ViewSonic office for the warranty information.

Lamp warranty subject to terms and conditions, verification and approval. Applies to manufacturer's installed lamp only.

All accessory lamps purchased separately are warranted for 90 days.

Who the warranty protects:

This warranty is valid only for the first consumer purchaser.

What the warranty does not cover:

1. Any product on which the serial number has been defaced, modified or removed.
2. Damage, deterioration or malfunction resulting from:
 - a. Accident, misuse, neglect, fire, water, lightning, or other acts of nature, unauthorized product modification, or failure to follow instructions supplied with the product.
 - b. Repair or attempted repair by anyone not authorized by ViewSonic.
 - c. Any damage of the product due to shipment.
 - d. Removal or installation of the product.
 - e. Causes external to the product, such as electric power fluctuations or failure.
 - f. Use of supplies or parts not meeting ViewSonic's specifications.
 - g. Normal wear and tear.
 - h. Any other cause which does not relate to a product defect.
3. Any product exhibiting a condition commonly known as "image built-in" which results when a static image is displayed on the product for an extended period of time.
4. Removal, installation, and set-up service charges.

How to get service:

1. For information about receiving service under warranty, contact ViewSonic Customer Support (Please refer to Customer Support page). You will need to provide your product's serial number.

2. To obtain warranted service, you will be required to provide (a) the original dated sales slip, (b) your name, (c) your address, (d) a description of the problem, and (e) the serial number of the product.
3. Take or ship the product freight prepaid in the original container to an authorized ViewSonic service center or ViewSonic.
4. For additional information or the name of the nearest ViewSonic service center, contact ViewSonic.
5. For applicable models with the PIN code security feature only. This projector contains a personal identification number (PIN) that restricts access to authorized users. If you forget to record the PIN code in the User Guide with your Serial Number, you will have to send in the unit for service so the code can be reset. However, if you register your product serial number with ViewSonic, along with your PIN code, it will be retained on file with your registration should you need it in the future.”

Limitation of implied warranties:

There are no warranties, express or implied, which extend beyond the description contained herein including the implied warranty of merchantability and fitness for a particular purpose.

Exclusion of damages:

ViewSonic's liability is limited to the cost of repair or replacement of the product. ViewSonic shall not be liable for:

1. Damage to other property caused by any defects in the product, damaged based upon inconvenience, loss of use of the product, loss of time, loss of profits, loss of business opportunity, loss of goodwill, interference with business relationships, or other commercial loss, even if advised of the possibility of such damages.
2. Any other damages, whether incidental, consequential or otherwise.
3. Any claim against the customer by other party.

Effect of state law:

This warranty gives you specific legal rights, and you may also have other rights which vary from state to state. Some states do not allow limitations on implied warranties and/or do not allow the exclusion of incidental or consequential damages, so the above limitations and exclusions may not apply to you.

Sales outside the U.S.A. and Canada:

For warranty information and service on ViewSonic products sold outside of the U.S.A. and Canada, contact ViewSonic or your local ViewSonic dealer.

The warranty period for this product in mainland China (Hong Kong, Macao and Taiwan Excluded) is subject to the terms and conditions of the Maintenance Guarantee Card.

