

ViewSonic®

Pro8500 DLP Projector

IMPORTANT: Please read this User Guide to obtain important information on installing and using your product in a safe manner, as well as registering your product for future service. Warranty information contained in this User Guide will describe your limited coverage from ViewSonic Corporation, which is also found on our web site at <http://www.viewsonic.com> in English, or in specific languages using the Regional selection box in the upper right corner of our website.
"Antes de operar su equipo lea cuidadosamente las instrucciones en este manual"



- User Guide
- Guide de l'utilisateur
- Bedienungsanleitung
- Guía del usuario
- Guida dell'utente
- Guia do usuário
- Användarhandbok
- Käyttöopas
- Руководство пользователя
- 使用手冊 (繁體)
- 使用手冊 (简体)
- 사용자 안내서
- คู่มือการใช้งาน
- Podręcznik użytkownika
- Kullanıcı kılavuzu

Model No. : VS13645

Compliance Information

FCC Statement

This device complies with part 15 of FCC Rules. Operation is subject to the following two conditions: (1) this device may not cause harmful interference, and (2) this device must accept any interference received, including interference that may cause undesired operation.

This equipment has been tested and found to comply with the limits for a Class B digital device, pursuant to part 15 of the FCC Rules. These limits are designed to provide reasonable protection against harmful interference in a residential installation. This equipment generates, uses, and can radiate radio frequency energy, and if not installed and used in accordance with the instructions, may cause harmful interference to radio communications. However, there is no guarantee that interference will not occur in a particular installation. If this equipment does cause harmful interference to radio or television reception, which can be determined by turning the equipment off and on, the user is encouraged to try to correct the interference by one or more of the following measures:

- Reorient or relocate the receiving antenna.
- Increase the separation between the equipment and receiver.
- Connect the equipment into an outlet on a circuit different from that to which the receiver is connected.
- Consult the dealer or an experienced radio/TV technician for help.

Warning: You are cautioned that changes or modifications not expressly approved by the party responsible for compliance could void your authority to operate the equipment.

For Canada

- This Class B digital apparatus complies with Canadian ICES-003.
- Cet appareil numérique de la classe B est conforme à la norme NMB-003 du Canada.

CE Conformity for European Countries

 The device complies with the EMC Directive 2004/108/EC and Low Voltage Directive 2006/95/EC.

Following information is only for EU-member states:

The mark is in compliance with the Waste Electrical and Electronic Equipment Directive 2002/96/EC (WEEE).

The mark indicates the requirement NOT to dispose the equipment including any spent or discarded batteries or accumulators as unsorted municipal waste, but use the return and collection systems available.

If the batteries, accumulators and button cells included with this equipment, display the chemical symbol Hg, Cd, or Pb, then it means that the battery has a heavy metal content of more than 0.0005% Mercury or more than, 0.002% Cadmium, or more than 0.004% Lead.



Important Safety Instructions

1. Read these instructions.
2. Keep these instructions.
3. Heed all warnings.
4. Follow all instructions.
5. Do not use this unit near water.
6. Clean with a soft, dry cloth.
7. Do not block any ventilation openings. Install the unit in accordance with the manufacturer's instructions.
8. Do not install near any heat sources such as radiators, heat registers, stoves, or other devices (including amplifiers) that produce heat.
9. Do not defeat the safety purpose of the polarized or grounding-type plug. A polarized plug has two blades with one wider than the other. A grounding type plug has two blades and a third grounding prong. The wide blade and the third prong are provided for your safety. If the provided plug does not fit into your outlet, consult an electrician for replacement of the obsolete outlet.
10. Protect the power cord from being walked on or pinched particularly at plugs. Convenience receptacles and the point where they exit from the unit. Be sure that the power outlet is located near the unit so that it is easily accessible.
11. Only use attachments/accessories specified by the manufacturer.
12.  Use only with the cart, stand, tripod, bracket, or table specified by the manufacturer, or sold with the unit. When a cart is used, use caution when moving the cart/unit combination to avoid injury from tipping over.
13. Unplug this unit when unused for long periods of time.
14. Refer all servicing to qualified service personnel. Servicing is required when the unit has been damaged in any way, such as: if the power-supply cord or plug is damaged, if liquid is spilled onto or objects fall into the unit, if the unit is exposed to rain or moisture, or if the unit does not operate normally or has been dropped.

Declaration of RoHS Compliance

This product has been designed and manufactured in compliance with Directive 2002/95/EC of the European Parliament and the Council on restriction of the use of certain hazardous substances in electrical and electronic equipment (RoHS Directive) and is deemed to comply with the maximum concentration values issued by the European Technical Adaptation Committee (TAC) as shown below:

Substance	Proposed Maximum Concentration	Actual Concentration
Lead (Pb)	0.1%	< 0.1%
Mercury (Hg)	0.1%	< 0.1%
Cadmium (Cd)	0.01%	< 0.01%
Hexavalent Chromium (Cr ⁶⁺)	0.1%	< 0.1%
Polybrominated biphenyls (PBB)	0.1%	< 0.1%
Polybrominated diphenyl ethers (PBDE)	0.1%	< 0.1%

Certain components of products as stated above are exempted under the Annex of the RoHS Directives as noted below:

Examples of exempted components are:

1. Mercury in compact fluorescent lamps not exceeding 5 mg per lamp and in other lamps not specifically mentioned in the Annex of RoHS Directive.
2. Lead in glass of cathode ray tubes, electronic components, fluorescent tubes, and electronic ceramic parts (e.g. piezoelectronic devices).
3. Lead in high temperature type solders (i.e. lead-based alloys containing 85% by weight or more lead).
4. Lead as an alloying element in steel containing up to 0.35% lead by weight, aluminium containing up to 0.4% lead by weight and as a copper alloy containing up to 4% lead by weight.

Copyright Information

Copyright © ViewSonic® Corporation, 2010. All rights reserved.

Macintosh and Power Macintosh are registered trademarks of Apple Inc.

Microsoft, Windows, Windows NT, and the Windows logo are registered trademarks of Microsoft Corporation in the United States and other countries.

ViewSonic, the three birds logo, OnView, ViewMatch, and ViewMeter are registered trademarks of ViewSonic Corporation.

VESA is a registered trademark of the Video Electronics Standards Association. DPMS and DDC are trademarks of VESA.

PS/2, VGA and XGA are registered trademarks of International Business Machines Corporation.

Disclaimer: ViewSonic Corporation shall not be liable for technical or editorial errors or omissions contained herein; nor for incidental or consequential damages resulting from furnishing this material, or the performance or use of this product.

In the interest of continuing product improvement, ViewSonic Corporation reserves the right to change product specifications without notice. Information in this document may change without notice.

No part of this document may be copied, reproduced, or transmitted by any means, for any purpose without prior written permission from ViewSonic Corporation.

Product Registration

To meet your future needs, and to receive any additional product information as it becomes available, please register your product on the Internet at: www.viewsonic.com. The ViewSonic® Wizard CD-ROM also provides an opportunity for you to print the registration form, which you may mail or fax to ViewSonic.

For Your Records

Product Name:	Pro8500 ViewSonic DLP Projector
Model Number:	VS13645
Document Number:	Pro8500_UG_ENG Rev. 1A 09-01-10
Serial Number:	_____
Purchase Date:	_____

Product disposal at end of product life

The lamp in this product contains mercury which can be dangerous to you and the environment. Please use care and dispose of in accordance with local, state or federal laws.

ViewSonic respects the environment and is committed to working and living green. Thank you for being part of Smarter, Greener Computing. Please visit ViewSonic website to learn more.

1. USA: www.viewsonic.com/company/green/
2. Europe: www.viewsoniceurope.com/uk/support/recycling-information/
3. Taiwan: recycle.epa.gov.tw/recycle/index2.aspx

CONTENTS

Introduction5

Projector Features	5
Package Contents	6
Projector Overview	8

Using the Product10

Control Panel	10
Connection Ports	11
Remote Control	13
Installing the Batteries	15
Remote Control Operation	16

Connection17

Connecting a computer or monitor ..	18
Connecting Video source devices ..	19

Operation22

Powering On/Off the Projector	22
Adjusting the Projector Height	23
Adjusting the Projector Zoom and Focus	23
Adjusting Projection Image Size	24
Locking control keys	25
Creating your own startup screen ..	25
Setting the presentation timer	26
Menu Operation	28
Controlling the projector through a LAN environment	38
Controlling the projector through a web browser	41
Displaying images through pwPresenter	47
Displaying pictures with a USB storage device	53

Maintenance55

Cleaning the Lens	55
Cleaning the Projector Housing	55
Cleaning the Filter Cover	55
Replacing the Lamp	56

Specifications58

Dimensions	59
------------------	----

Ceiling mount installation	59
----------------------------------	----

Appendix 60

LED Indicator Messages	60
Compatibility Modes	61
Troubleshooting	63
IR Control Code	66

Introduction

Projector Features

The projector integrates high-performance optical engine projection and a user - friendly design to deliver high reliability and ease of use.

The projector offers the following features:

- Single chip 0.7" Texas Instruments DLP® technology
- XGA (1024 x 768 pixels)
- Auto image re-sizing (Auto-Sync.) up to 1600 x 1200 full screen with scaling compression compatibility for VGA, SVGA, XGA and SXGA
- Compatibility with Macintosh® computers
- Compatibility with NTSC, PAL, SECAM and HDTV
- D-Sub 15-pin terminal for analog video connectivity
- User-friendly, multi-language on-screen display
- Advanced electronic keystone correction
- RS-232 connector for serial control
- HDMI compatibility
- PJLink™ compatible
- LAN display for network control and web server
- LAN display 4-1 (maximum 4PC/ NB display to 1 projector)
- Remote desktop feature for LAN and USB display 1-M (maximum 1PC/ NB can display to 8 projectors at the same time)
- USB display supports computer connection via USB mini-B type to A type cable
- USB Reader supports USB flash drive via USB A type connector
- Less than 1 W power consumption in standby mode



- *The information in this manual is subject to change without notices.*
- *The reproduction, transfer or copy of all or any part of this document is not permitted without express written consent.*

Package Contents

When you unpack the projector, make sure you have all these components:

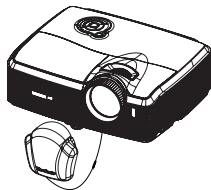

Projector with Lens Cap

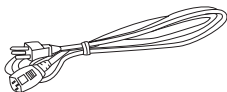

AC Power Cord



Remote Control (IR) & batteries

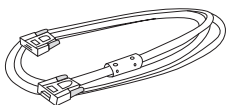

VGA Cable (D-SUB to D-SUB)

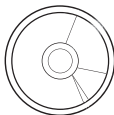

ViewSonic CD Wizard

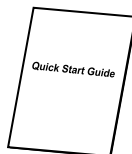

Quick Start Guide

Optional accessories



Filter cover
P/N: P4R34-4600-00

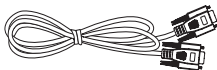

RS232 cable
P/N: J2552-0208-00

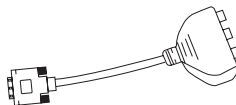

RGB to component adapter
P/N: J2552-0212-00

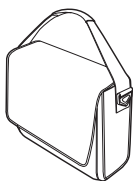

Projector Carrying Case



- *Contact your dealer immediately if any items are missing, appear damaged, or if the unit does not work.*
- *Save the original shipping carton and Packing material; they will come-in handy if you ever to ship your unit. for maximum protection, repack your unit as it was originally packed at the factory.*

Projector Overview

Front View

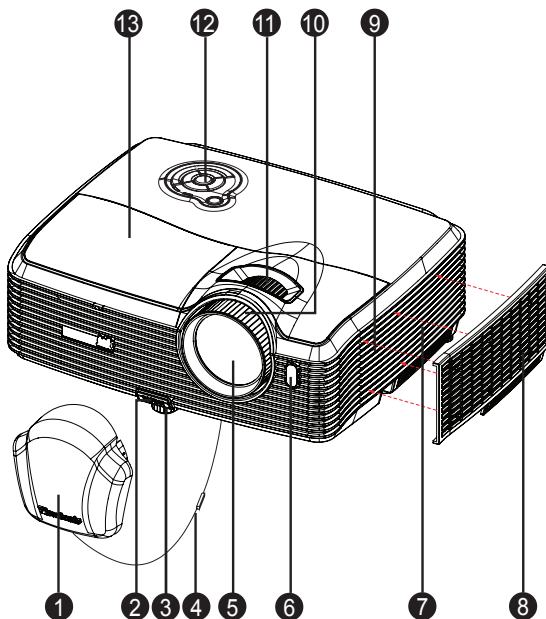

- | | |
|----------------------------------|-----------------|
| ❶ Lens cap | ❸ Filter cover |
| ❷ Elevator button | ❹ Speaker |
| ❸ Elevator foot | ❺ Focus ring |
| ❹ Lens cap strap | ❻ Zoom ring |
| ❺ Projection lens | ❼ Control panel |
| ❻ Front IR remote control sensor | ❽ Lamp cover |
| ❼ Ventilation holes (intake) | |

Rear View

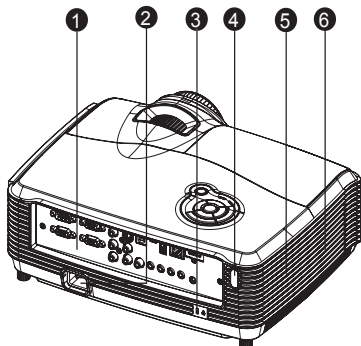

- 1 Connection ports
- 2 AC power socket
- 3 Kensington lock
- 4 Rear IR remote control sensor
- 5 Speaker
- 6 Ventilation holes (exhaust)

Bottom View

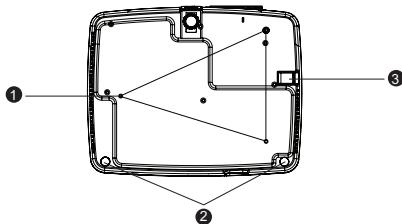

- 1 Ceiling mount holes (M4*8)
- 2 Tilt-adjustment feet
- 3 Security bar

NOTE

- This projector can be used with a ceiling mount for support. The ceiling mount is not included in the package.
- Contact your dealer for information to mount the projector on a ceiling.

Using the Product

Control Panel

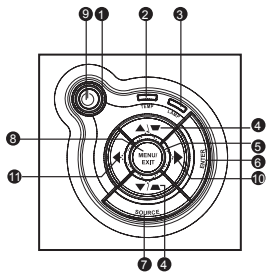

- 1** **Power** (Power LED indicator)
Refer to “LED Indicator Messages”.
- 2** **TEMP** (Temperature LED indicator)
Refer to “LED Indicator Messages”.
- 3** **LAMP** (Lamp LED indicator)
Refer to “LED Indicator Messages”.
- 4** **Keystone/Arrow keys (▲/Up, ▼/Down)**
Manually correct distorted images resulting from an angled projection.
- 5** **Four directional buttons**
Use four directional buttons to select items or make adjustments to your selection.
- 6** **ENTER**
Enter to sub-menu and confirm the menu selection.
- 7** **SOURCE**
Display the source selection bar.
- 8** **MENU/EXIT**
Display or exit the on-screen display menus.
- 9** **Power**
Turn the projector on or off.
- 10** **▶Right/Panel key**
Activate panel key lock.
- 11** **◀Left/Blank**
Hide the screen picture.

Connection Ports

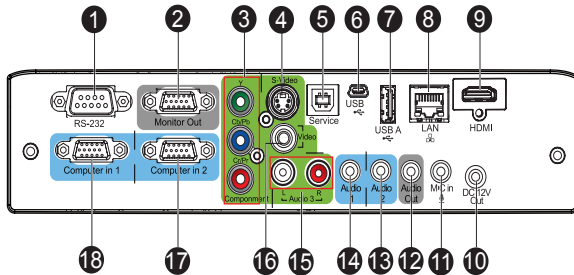

- 1 **RS-232**
When operating the projector via a computer, connect this to the controlling computer's RS-232C port.
- 2 **Monitor Out**
Connect to a computer display, etc.
- 3 **Component (Y Cb/Pb Cr/Pr)**
Connect Y Cb/Pb Cr/Pr output from video equipment to this jack.
- 4 **S-Video**
Connect S-Video output from video equipment to this jack.
- 5 **Service**
This connector is for firmware update and mouse function support.
- 6 **USB B**
USB display supports computer connection via USB mini-B type to A type cable.
- 7 **USB A**
This connector supports USB flash drive display and wireless dongle for USB display.
- 8 **LAN**
For LAN display/network control and web server.
- 9 **HDMI**
Connect HDMI output from video equipment to this jack.
- 10 **DC 12V Out**
12V DC out
- 11 **MIC in**
Microphone input jack.



- ⑫ **Audio Out**
Connect to a speaker or other audio input equipment.
- ⑬ **Audio 2**
Connect an audio output from video equipment or computer to this jack.
- ⑭ **Audio 1**
Connect an audio output from video equipment or computer to this jack.
- ⑮ **Audio 3 (L/R)**
Connect an audio output from video equipment to this jack.
- ⑯ **Video**
Connect composite video output from video equipment to this jack.
- ⑰ **Computer in 2**
Connect image input signal (analog RGB or component) to this jack.
- ⑱ **Computer in 1**
Connect image input signal (analog RGB or component) to this jack.

Remote Control

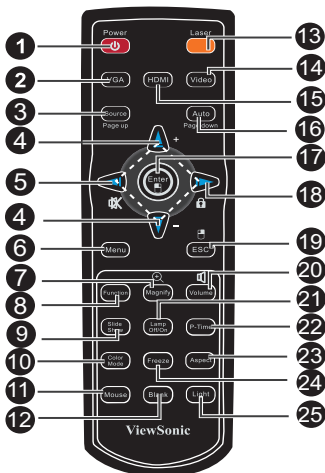
- 1 **Power**
Turn the projector on or off.
- 2 **VGA**
Switch input source to Computer in 1 (analog RGB or component)/ Computer in 2 (analog RGB or component) by sequence.
- 3 **Source/Page up**
Display the source selection bar. Perform page up function when mouse mode is activated.
- 4 **▲ Up/+, ▼ Down/-**
When Magnify or Volume button is activated, use them to adjust the values.
- 5 **◀ Left/Mute**
When the On-Screen Display (OSD) menu is not activated, this button is used as mute function.
- 6 **Menu**
Display on-screen display menus.
- 7 **Magnify**
Zoom in and out the images.
- 8 **Function**
User definable key for customized function.
- 9 **Slide show**
Activate the slide show function when the input source is USB reader.
- 10 **Color Mode**
Change the color setting by sequence.
- 11 **Mouse**
Switch between the normal and mouse modes.
- 12 **Blank**
Cut off the screen temporarily. Press again to cancel the Blank Screen function.





- 13 **Laser**
Aim the remote at the viewing screen, press and hold this button to activate the laser pointer.
- 14 **Video**
Switch input source to Composite/S-Video/component by sequence.
- 15 **HDMI**
Display HDMI signal.
- 16 **Auto/Page down**
Resynchronize the projector to the input signal from a computer. This function is available for computer mode only. Perform page down function when mouse mode is activated.

- 17 **Enter/  Left mouse**
Confirmed selections.
Perform the left button of the mouse when mouse mode is activated.
- 18 **▶ Right/  Lock**
When the On-Screen Display (OSD) menu is activated, the #4, #5, and #18 keys are used as directional arrows to select the desired menu items and to make adjustments.
Activate panel key lock.
- 19 **ESC/  Right mouse**
Leave current page or items or to close OSD.
Perform the right button of the mouse when mouse mode is activated.
- 20 **Volume**
Adjust the volume level.
- 21 **Lamp Off/On**
Turn off or on the lamp power.
- 22 **P-Timer**
Activate P-Timer OSD menu.
- 23 **Aspect**
Select the display aspect ratio.
- 24 **Freeze**
Press "Freeze" to pause the screen image. Press again to cancel the freeze function.
- 25 **Light**
Enable backlight functions of the remote control's buttons.

Using the remote mouse control

The capability of operating your computer with the remote control gives you more flexibility when delivering presentations.

1. Connect the projector to your PC or notebook with a USB cable prior to using the remote control in place of your computer's mouse. See ["Connecting a computer" on page 18](#) for details.
2. Set the input signal to **Computer in 1** or **Computer in 2**.
3. Press **Mouse** on the remote control to switch from the normal mode to the mouse mode. An icon appears on the screen to indicate the activation of the mouse mode.
4. Perform the desired mouse controls on your remote control.
 - To move the cursor on the screen, press **▲ / ▼ / ◀ / ▶** .
 - To left-click, press  .
 - To right-click, press  .
 - To drag-and-drop, press and hold **Enter**, press **▲ / ▼ / ◀ / ▶** to drag. When it is where you want it, press **Enter** again.
 - To operate your display software program (on a connected PC) which responds to page up/down commands (like Microsoft PowerPoint), press **Page Up/Page Down**.
 - To return to the normal mode, press **Mouse** again or other keys except for the mouse related multi-function keys.

Installing the Batteries

5. Open the battery cover in the direction shown.

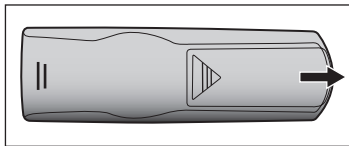

6. Install batteries as indicated by the diagram inside the compartment.

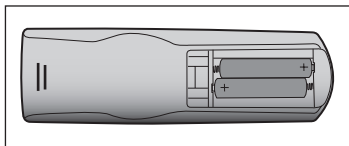

7. Close the battery cover into position.

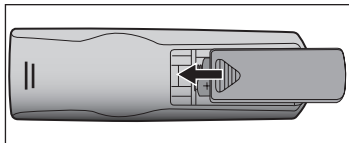

Caution

- Risk of explosion if battery is replaced by an incorrect type.
- Dispose of used batteries according to the instructions.
- Make sure the plus and minus terminals are correctly aligned when loading a battery.



- *Keep the batteries out of the reach of children. There is a danger of death by accidentally swallowing the batteries.*
- *Remove batteries from remote control when not using for extended periods.*
- *Do not dispose of the used batteries along with household waste. Dispose of used batteries according to local regulations.*
- *Danger of explosion may happen if batteries are incorrectly replaced. Replace all the batteries with new ones.*
- *Batteries should not be in or near to fire or water, keep batteries in a dark, cool and dry place.*
- *If suspect battery leakage, wipe out the leakage and then replace new batteries. If the leakage adheres to your body or clothes, rinse well with water immediately.*

Remote Control Operation

Point the remote control at the infrared remote sensor and press a button.

- Operating the projector from the front

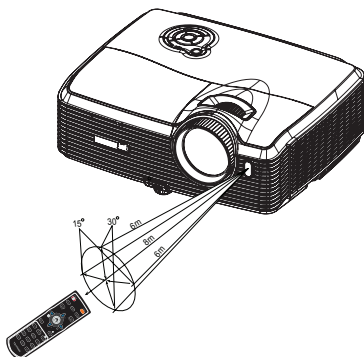

- Operating the projector from the rear

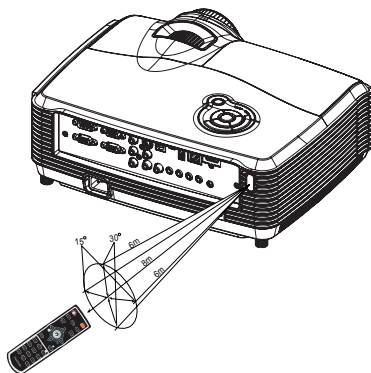

NOTE

- Do not point the laser directly to the people's eyes (especially small children). There is a danger of injury to the eyes.
- The remote control may not operate when there is sunlight or other strong light such as a fluorescent lamp shining on the remote sensor.
- Operate the remote control from a position where the remote sensor is visible.
- Do not drop the remote control or jolt it.
- Keep the remote control out of locations with excessively high temperature or humidity.
- Do not get water on the remote control or place wet objects on it.
- Do not disassemble the remote control.

Connection

When connecting a signal source to the projector, be sure to:

1. Turn all equipment off before making any connections.
2. Use the correct signal cables for each source.
3. Ensure the cables are firmly inserted.

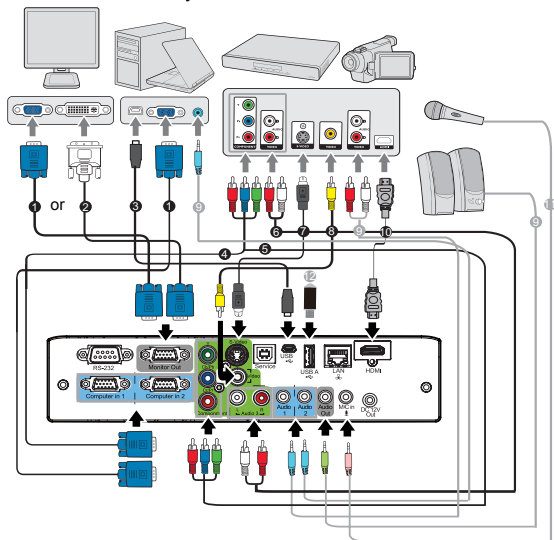

1	VGA cable (D-Sub to D-Sub)	7	S-Video cable
2	VGA to DVI-A cable	8	Composite Video cable
3	USB cable (mini-B type to A type)	9	Audio cable
4	VGA (D-Sub) to HDTV (RCA) cable	10	HDMI cable
5	Component Video cable	11	Microphone 3.5 mini jack cable
6	Audio L/R cable	12	USB flash drive



Important

- In the connections shown above, some cables may not be included with the projector (see [“Package Contents” on page 6](#)). They are commercially available from electronics stores.
- The connection illustrations above are for reference only. The rear connecting jacks available on the projector vary with each projector model.
- For detailed connection methods, see pages [18-21](#).

Connecting a computer or monitor

Connecting a computer

The projector provides two VGA input sockets that allow you to connect them to both IBM® compatibles and Macintosh® computers. A Mac adapter is needed if you are connecting legacy version Macintosh computers.

To connect the projector to a notebook or desktop computer:

1. Take the supplied VGA cable and connect one end to the D-Sub output socket of the computer.
2. Connect the other end of the VGA cable to the **Computer in 1** or **Computer in 2** signal input socket on the projector.
3. If you wish to use the remote paging function, take a USB cable and connect the A type end to the USB port of the computer, and the other end to the **Service** socket on the projector. See [“Using the remote mouse control” on page 14](#) for details.



Important

■ Many notebooks do not turn on their external video ports when connected to a projector. Usually a key combo like FN + F3 or CRT/LCD key turns the external display on/off. Locate a function key labeled CRT/LCD or a function key with a monitor symbol on the notebook. Press FN and the labeled function key simultaneously. Refer to your notebook's documentation to find your notebook's key combination.

Connecting a monitor

If you want to view your presentation close-up on a monitor as well as on the screen, you can connect the **Monitor Out** signal output socket on the projector to an external monitor with a VGA cable following the instructions below:

To connect the projector to a monitor:

1. Connect the projector to a computer as described in [“Connecting a computer” on page 18](#).
2. Take a suitable VGA cable (only one supplied) and connect one end of the cable to the D-Sub input socket of the video monitor.
Or if your monitor is equipped with a DVI input socket, take a VGA to DVI-A cable and connect the DVI end of the cable to the DVI input socket of the video monitor.
3. Connect the other end of the cable to the **Monitor Out** socket on the projector.



Important

■ The **Monitor Out** output only works when **Computer in 1** or **Computer in 2** is made to the projector.

Connecting Video source devices

You can connect your projector to various Video source devices that provide any one of the following output sockets:

- Component Video
- S-Video
- Video (composite)

You need only connect the projector to a Video source device using just one of the above connecting methods, however each provides a different level of video quality. The method you choose will most likely depend upon the availability of matching terminals on both the projector and the Video source device as described below:

Best video quality

The best available video connection method is Component Video (not to be confused with composite Video). Digital TV tuner and DVD players output Component Video natively, so if available on your devices, this should be your connection method of choice in preference to (composite) Video.

See [“Connecting a Component Video source device” on page 20](#) for how to connect the projector to a component video device.

Better video quality

The S-Video method provides a better quality analog video than standard composite Video. If you have both composite Video and S-Video output terminals on your Video source device, you should elect to use the S-Video option.

See [“Connecting an S-Video source device” on page 20](#) for how to connect the projector to an S-Video device.

Least video quality

Composite Video is an analog video and will result in a perfectly acceptable, but less than optimal result from your projector, being the least video quality of the available methods described here.

See [“Connecting a composite Video source device” on page 21](#) for how to connect the projector to a composite Video device.

Connecting a Component Video source device

Examine your Video source device to determine if it has a set of unused Component Video output sockets available:

- If so, you can continue with this procedure.
- If not, you will need to reassess which method you can use to connect to the device.

To connect the projector to a Component Video source device:

1. Take a VGA (D-Sub) to HDTV (RCA) cable, Component Video cable or a Component Video to VGA (D-Sub) adaptor and connect the end with 3 RCA type connectors to the Component Video output sockets of the Video source device. Match the color of the plugs to the color of the sockets; green to green, blue to blue, and red to red.
2. If you are using the VGA (D-Sub) to HDTV (RCA) cable and the Component Video to VGA (D-Sub) adaptor, connect the other end of the cable (with a D-Sub type connector) to the **Computer in 1** or **Computer in 2** socket on the projector. If you are using the Component Video Cable, connect the other end of 3RCA type connectors to the **Y Cb/Pb Cr/Pr** sockets on the projector.



Important

- If the selected video image is not displayed after the projector is turned on and the correct video source has been selected, check that the Video source device is turned on and operating correctly. Also check that the signal cables have been connected correctly.



RGB to component adaptor (ViewSonic P/N: J2552-0212-00)

Connecting an S-Video source device

Examine your Video source device to determine if it has an unused S-Video output socket available:

- If so, you can continue with this procedure.
- If not, you will need to reassess which method you can use to connect to the device.

To connect the projector to an S-Video source device:

1. Take an S-Video cable and connect one end to the S-Video output socket of the Video source device.
2. Connect the other end of the S-Video cable to the **S-Video** socket on the projector.



Important

- If the selected video image is not displayed after the projector is turned on and the correct video source has been selected, check that the Video source device is turned on and operating correctly. Also check that the signal cables have been connected correctly.
- If you have already made a Component Video connection between the projector and this S-Video source device using Component Video connections, you need not connect to this device using an S-Video connection as this makes an unnecessary second connection of poorer picture quality. See [“Connecting Video source devices” on page 19](#) for details.

Connecting a composite Video source device

Examine your Video source device to determine if it has a set of unused composite Video output sockets available:

- If so, you can continue with this procedure.
- If not, you will need to reassess which method you can use to connect to the device.

To connect the projector to a composite Video source device:

1. Take a Video cable and connect one end to the composite Video output socket of the Video source device.
2. Connect the other end of the Video cable to the **Video** socket on the projector.



Important

- If the selected video image is not displayed after the projector is turned on and the correct video source has been selected, check that the Video source device is turned on and operating correctly. Also check that the signal cables have been connected correctly.
- You need only connect to this device using a composite Video connection if Component Video and S-Video inputs are unavailable for use. See [“Connecting Video source devices” on page 19](#) for details.

Operation

Powering On/Off the Projector

Powering On the Projector:

1. Remove the projector lens cap.
2. Complete the AC power cord and peripheral signal cable(s) connections.
3. Press  to turn on the projector.
The projector takes a minute or so to warm up.
4. Turn on your source (computer, notebook, DVD, etc.). The projector automatically detects your source.



- If you are connecting multiple sources to the projector simultaneously, press **SOURCE** on the projector to select your desired signal or press your desired signal key on the remote control.



Warning

- Remove the lens cap first before powering on.
- Never look into the lens when the lamp is on. This can damage your eyes.
- This focal point concentrates high temperature. Do not place any object near it to avoid possible fire hazard.

Powering Off the Projector:

1. Press  to turn off the projector lamp. You will see a message "Power off? Press Power again" appear on the screen.
2. Press  again to confirm.
 - The cooling fans continue to operate for cooling cycle.
 - When the Power LED begins flashing, the projector has entered stand-by mode.
 - If you want to turn the projector back on, you must wait until the projector has completed the cooling cycle and has entered stand-by mode. Once in stand-by mode, simply press  to restart the projector.
3. Disconnect the AC power cord from the electrical outlet and the projector.
4. Do not turn on the projector right after power off.

Adjusting the Projector Height

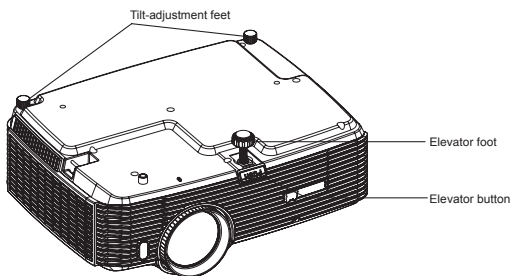

The projector is equipped with an elevator foot to adjust the image height.

To raise or lower the image:

1. To raise or lower the image, press the elevator button and raise or lower the front of the projector. Release the button to lock the adjustment.
2. To level the image on the screen, turn the tilt-adjustment feet to fine-tune the height.

NOTE

- To avoid damaging the projector, make sure that the elevator foot and tilt-adjustment feet are fully retracted before placing the projector in its carrying case.

Adjusting the Projector Zoom and Focus

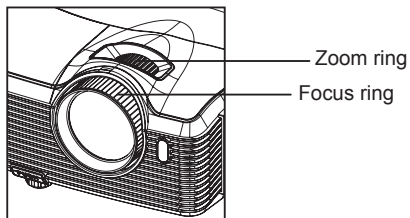

1. Focus the image by rotating the focus ring. A still image is recommended for focusing.
2. Adjust the image size by sliding the zoom ring.

Adjusting Projection Image Size

Refer to the graphic and table below to determine the screen size and projection distance.

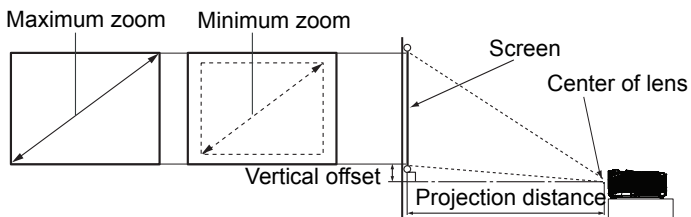

Screen size Diagonal [inch (cm)]	4 : 3 Screen			
	Projection distance [inch (m)]		Image height [inch (cm)]	Vertical offset [inch (cm)]
	(min. zoom)	(max. zoom)		
30 (76)	33 (0.85)	52 (1.32)	18 (46)	2.7 (6.9)
40 (102)	45 (1.14)	70 (1.78)	24 (61)	3.6 (9.2)
50 (127)	57 (1.44)	88 (2.23)	30 (76)	4.5 (11.5)
60 (152)	69 (1.74)	106 (2.69)	36 (91)	5.4 (13.8)
80 (203)	92 (2.34)	142 (3.60)	48 (122)	7.2 (18.4)
100 (254)	116 (2.94)	178 (4.51)	60 (152)	9.1 (23.0)
120 (305)	139 (3.54)	214 (5.43)	72 (183)	10.9 (27.6)
150 (381)	175 (4.44)	268 (6.80)	90 (229)	13.6 (34.5)
200 (508)	234 (5.93)	357 (9.08)	120 (305)	18.1 (46.0)
220 (559)	257 (6.53)	393 (9.99)	132 (335)	19.9 (50.6)
250 (635)	292 (7.43)	447 (11.36)	150 (381)	22.6 (57.5)
300 (762)	351 (8.93)	537 (13.64)	180 (457)	27.2 (69.0)



- Position the projector in a horizontal position; other positions can cause heat build-up and damage to the projector.
- Keep a space of 30 cm or more between the sides of the projector.
- Do not use the projector in a smoky environment. Smoke residue may build-up on critical parts and damage the projector or its performance.
- Consult with your dealer for special installation such as suspending from a ceiling.

Locking control keys

With the control keys on the projector locked, you can prevent your projector settings from being changed accidentally (by children, for example). When the **Panel Key Lock** is on, no control keys on the projector will operate except **Power**.

1. Press **▶** on the projector or remote control.
2. A confirmation message is displayed. Select **Yes** to confirm.

To release panel key lock, press and hold **▶** for 3 seconds on the projector.

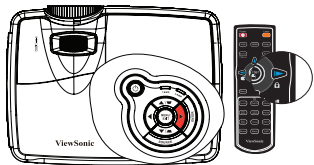

Important

- Keys on the remote control are still functional when panel key lock is enabled.
- If you press **Power** to turn off the projector without disabling panel key lock, the projector will still be in locked status the next time it is turned on.

Creating your own startup screen

In addition to selecting the projector preset startup screen from ViewSonic logo or User screen, you can make your own startup screen that is an image projected from your computer or video source.

1. Press **MENU/EXIT** on the projector or **Menu** on the remote control and then press **◀/▶** until the **Option** menu is highlighted.
2. Press **▼** to highlight **Start up Screen** and press **MODE/ENTER** on the projector or **Enter** on the remote control.
3. A confirmation message is displayed. Press **MODE/ENTER** on the projector or **Enter** on the remote control again.
4. The message **'Screen Capturing...'** is displayed while the projector is processing the picture. Please wait.
5. If the action is successful, you see the message **'Capture Succeeded'** on the screen. The captured picture is saved as **User**.
6. To view the captured picture displayed as the startup screen, set **User** in the **Option > Start up Screen > User** menu and restart the projector.

In the unlikely event that the capturing action fails, change your target picture.

Setting the presentation timer

The presentation timer can indicate the presentation time on the screen to help you achieve better time management when giving presentations. Follow these steps to utilize this function:

1. Go to the **Setting > Presentation Timer** menu and press **MODE/ENTER** to display the **Presentation Timer** page.
2. Highlight **Timer Period** and decide the timer period by pressing **◀/▶**. The length of time can be set from 1 to 5 minutes in 1-minute increments and 5 to 240 minutes in 5-minute increments.



Important

- If the timer is already on, the timer will restart whenever the Timer Period is reset.
3. Press **▼** to highlight **Timer Display** and choose if you want the timer to show up on the screen by pressing **◀/▶**.

Selection	Description
Always	Displays the timer on screen throughout the presentation time.
1 Min/2 Min/3 Min	Displays the timer on screen in the last 1/2/3 minute(s).
Never	Hides the timer throughout the presentation time.

4. Press **▼** to highlight **Timer Position** and set the timer position by pressing **◀/▶**.
Top-Left → Bottom-Left → Top-Right → Bottom-Right
5. Press **▼** to highlight **Timer Counting Direction** and select your desired counting direction by pressing **◀/▶**.

Selection	Description
Count Up	Increases from 0 to the preset time.
Count Down	Decrease from the preset time to 0.

6. To activate the presentation timer, press **▼** and press **◀/▶** to select **On** and press **MODE/ENTER**.
7. A confirmation message displays. Highlight **Yes** and press **MODE/ENTER** to confirm. You will see the message “**Timer is On**” displaying on the screen. The timer starts counting at the time when the timer is on.

To cancel the timer, perform the following steps:

1. Go to the **Setting > Presentation Timer** menu and highlight **Off**.
2. Press **MODE/ENTER**. A confirmation message displays.
3. Highlight **Yes** and press **MODE/ENTER** to confirm. You will see the message **“Timer is Off!”** displaying on the screen.

Menu Operation

The projector has multilingual on-screen display menus that allow you to make image adjustments and change a variety of settings.

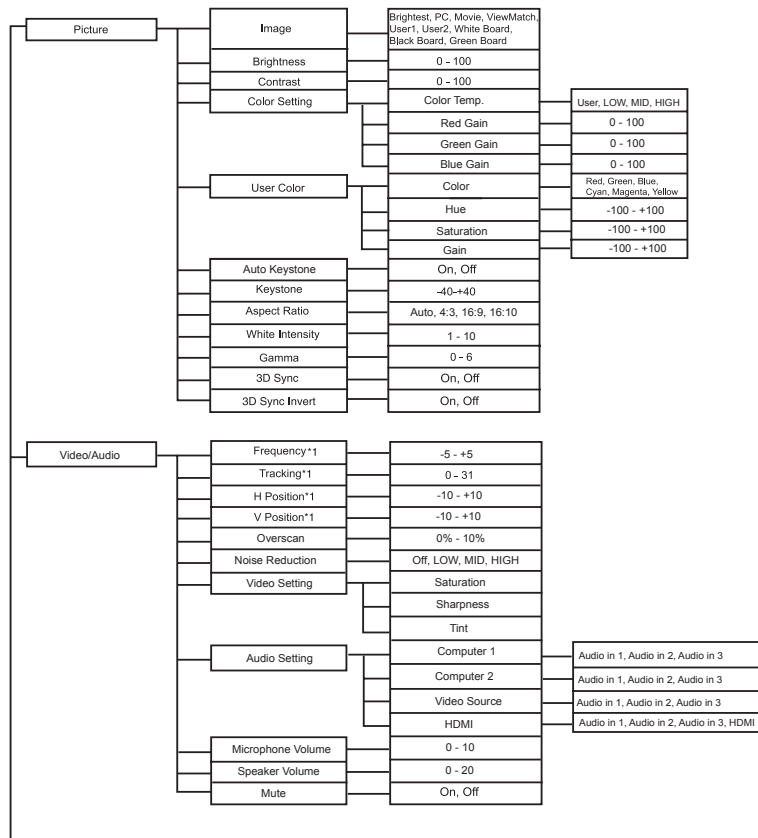

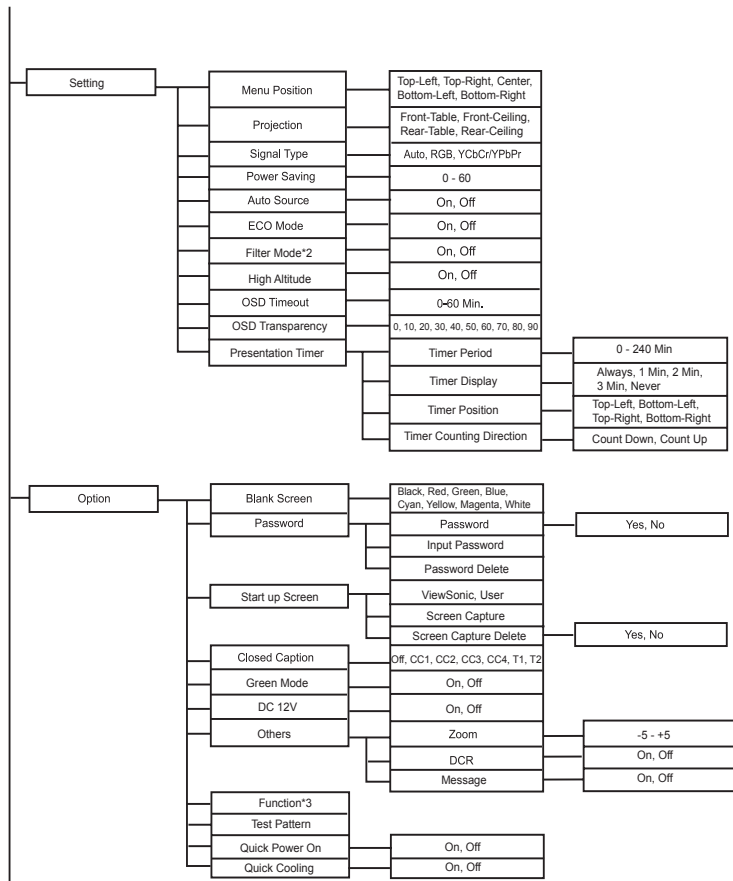

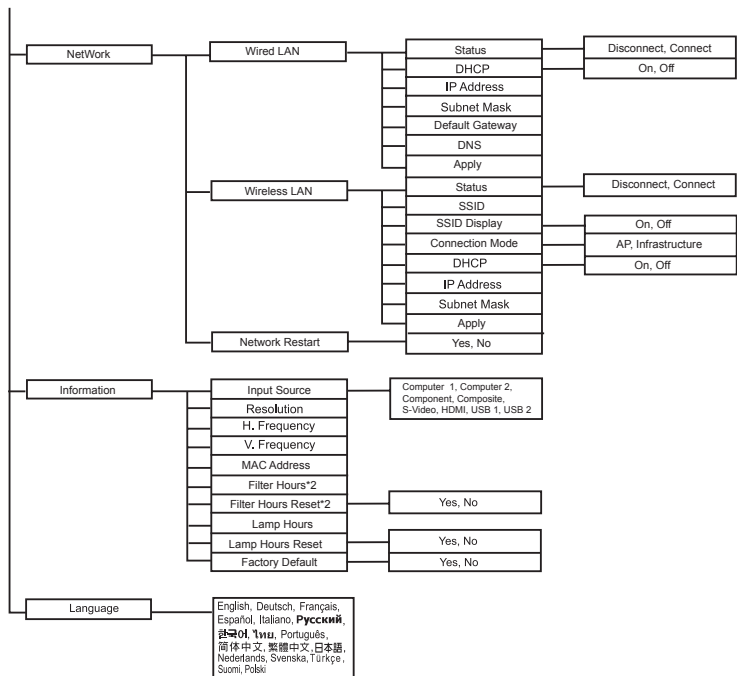

*1 Adjustable range and default setting vary depending on signal type.

*2 This function is only available when the projector is installed an optional filter cover.

*3 The selectable Function list includes Brightness, Contrast, Saturation, Color Setting > Color Temperature, Gamma, Overscan, Noise Reduction, Audio Setting, Microphone Volume, Speaker Volume, Mute, Keystone, Aspect Ratio, Projection, Power Saving, ECO Mode, Filter Mode, OSD Position, OSD Transparency, Closed Caption, Message, Zoom, DCR and Test Pattern.

How to operate

1. Press **MENU** on the projector or **Menu** on the remote control to open the OSD menu.
2. When OSD is displayed, use **▲/▼** to select any feature in the main menu.
3. After selecting the desired main menu item, press **▶** to enter sub-menu for feature setting.
4. Use **▲/▼** to select the desired item and adjust the settings with **◀/▶**.
5. Press **MENU** on the projector or **Menu** on the remote control, the screen will return to the main menu.
6. To exit OSD, Press **MENU** on the projector or **Menu** on the remote control again. The OSD menu will close and the projector will automatically save the new settings.

Picture

Image

There are many factory presets optimized for various types of images.

- Brightest : For the brightest environment.
- PC : For computer or notebook.
- Movie : For home theater.
- ViewMatch : For accuracy color performance.
- User 1 : Memorize user 1 defined settings.
- User 2 : Memorize user 2 defined settings.
- White Board : For white projection screen type.
- Black Board : For black projection screen type.
- Green Board : For green projection screen type.

Brightness

Brighten or darken the image.

Contrast

Set the difference between light and dark areas.

Color Setting

Adjust the color temperature. At higher temperature the screen looks colder; at lower temperature, the screen looks warmer. If you select "User", then you can change the intensity of each of 3 color (Red, Green, Blue) to customize user color temperature.

User Color

User Color provides six sets (RGBCMY) of colors to be adjusted. When you select each color, you can independently adjust its range and saturation according to your preference.

Auto Keystone

Automatically correct distorted images resulting from an angled projection.

Keystone

Manually correct distorted images resulting from an angled projection.

- When adjusting the Keystone, Auto Keystone will be set at "Off" automatically.

Aspect Ratio

Select how the picture fits on the screen:

- Auto : Scales an image proportionally to fit the projector's native resolution in its horizontal or vertical width.
- 4:3 : Scales an image so that it is displayed in the center of the screen with a 4:3 aspect ratio.
- 16:9 : Scales an image so that it is displayed in the center of the screen with a 16:9 aspect ratio.
- 16:10: Scale an image so that it is displayed in the center of the screen with a 16:10 aspect ratio.

White Intensity

Increase the brightness of white areas.

Gamma

Effect the represent of dark scenery. With greater gamma value, dark scenery will look brighter.

3D Sync

- On: Enable 3D function.
- Off: Disable 3D function

3D Sync Invert (for TI 3D DLP-LINK only)

- On: Invert left and right frame contents.
- Off: Default frame contents.

Video/Audio

Frequency

Adjust the timing of the projector relative to the computer.

Tracking

Adjust the phase of the projector relative to the computer.

H Position (Horizontal Position)

Adjust the image left or right within the projection area.

V Position (Vertical Position)

Adjust the image up or down within the projection area.

Overscan

Remove noise around the image.

Noise Reduction

Reduce temporal and/or spatial noise in the image.

Video Setting

Allow you to enter the Video Setting menu.

- Saturation: Adjust a video image from black and white to fully saturated color.

- Sharpness: Sharpen or soften the image.
- Tint: Shift colors toward red or green.

Audio Setting

Allow you to enter the Audio Setting menu.

- Computer 1: Select the audio input for Computer in 1 signal.
 - When Audio in 1 is turned on, Audio in 2 and Audio in 3 will turn off automatically.
- Computer 2: Select the audio input for Computer in 2 signal.
 - When Audio in 2 is turned on, Audio in 1 and Audio in 3 will turn off automatically.
- Video Source: Select the audio input for video source.
 - When Audio in 3 is turned on, Audio in 1 and Audio in 2 will turn off automatically.
- HDMI: Select the audio input for HDMI signal.
 - When HDMI is turned on, Audio in 1, Audio in 2 and Audio in 3 will turn off automatically.

Microphone Volume

Adjust the microphone's volume level.

Speaker Volume

Adjust the projector's volume level.

Mute

Cut off the sound temporarily.

Setting

Menu Position

Choose the menu location on the display screen.

Projection

Adjust the picture to match the orientation of the projector: upright or upside-down, in front of or behind the screen. Invert or reverse the image accordingly.

Signal Type

Specify the source to the Computer in 1/Computer in 2 terminal that you wish to project.

- Auto : Automatically detect the input signal type from Computer in 1 and Computer in 2 terminals.
- RGB : For VGA signal
- YCbCr/YPbPr: For component signal

Power Saving

If the input source is not detected and no operation is performed for a specific period of time, projector will automatically turn off.

Auto Source

Automatically scan through all the input sources.

ECO Mode

Use this function to dim the projector lamp light output which will lower power consumption and increase lamp life.

- This function will be unavailable when the DCR function is on.

Filter Mode

Use this function to activate filter mode after the projector is installed an optional filter cover.

High Altitude

Use this function to allow the fans operates at full speed continuously to achieve proper high altitude cooling of the projector.

OSD Timeout

Duration of OSD menu display countly starts (at idle state by second).

OSD Transparency

Select to change the transparency level of the OSD background.

Presentation Timer

Remind the presenter to finish the presentation within a certain time frame.

- Timer Period: Set a preferred length of time for presentation.
- Timer Display: Set whether to display the timer on screen.
- Timer Position: Set the position where the timer displays on screen.
- Timer Counting Direction: Set the timer counting direction.

Option

Blank Screen

Blank the screen temporarily, and select the screen color when this function is active.

Password

Set or delete the password. When the password function is added, image projection will require to input the preset password when turning on the projector.

Start up Screen

Allow you to enter the Start up Screen menu.

- Start up Screen: Select start up screen when the projector is powered on or when no signal is input. "User" is the screen that you captured.
- Screen Capture: Capture the current projection screen as a start up screen.
- Screen Capture Delete: Delete the captured projection screen.

Closed Caption

Enable or disable closed captions by selecting CC1 (closed caption1, the most common channel), CC2, CC3, CC4, T1, T2 or OFF.

Green Mode

Enable this function when power consumption is under 1W.

DC 12V

Enable or disable to trigger external devices such as anelectric screen.

Others

Allow you to enter the Others menu.

- Zoom: Zoom in and out the images.
- DCR (Dynamic Contrast Ratio): Enable DCR will further enhance contrast ratio by darkening the black scenes. Disable DCR will resume to normal contrast performance. DCR will impact lamp life and system noise performance.
- Message: Enable or disable the message box at the right bottom of the screen.

Function

Allow user to define a short cut key on the remote control, and the function item is selected in OSD menu.

Test Pattern

Display embedded test pattern.

Quick Power On

The projector will turn on automatically after the power cord has been connected and power has been applied.

Quick Cooling

Enable to cool the lamp quickly when the projector is shutting down.

Network

Wired LAN

Allow you to configure the wired LAN settings.

- Status: Display the projector's status.
- DHCP: Abbreviation for Dynamic Host Configuration Protocol. This protocol automatically assigns IP Address to networked devices.
 - When the "DHCP" sets to "Yes", it takes some time to obtain IP address from DHCP server.
 - When the "DHCP" sets to "No", that means user will set IP address by manually.
- IP Address: Numerical address to identify networked computers. This function can only be used when DHCP is set to No.
 - The IP Address is the number that identifies this projector on the network. You cannot have two devices with the same IP Address on the same network.
 - The IP Address "0.0.0.0" is prohibited.
- Subnet Mask: A numeric value to define the number of bits used for a network address of a divided network (or subnet) in an IP Address. This function can only

be used when DHCP is set to No.

- The Subnet Mask "0.0.0.0" is prohibited.
- **Default Gateway:** A server (or router) to communicate across networks (subnets) that are divided by Subnet Mask. This function can only be used when DHCP is set to No.
- **DNS:** Setup DNS server address when DHCP is disable.
- **Apply:** Save and execute the wired LAN settings.

Wireless LAN

Allow you to configure the wireless LAN settings.

- **Status:** Display the projector's status.
- **SSID:** Display the projector's SSID information.
- **SSID Display:** Select if you want to display the projector's SSID.
- **Connection Mode:** Methods for connecting to wireless networks with Wi-Fi enabled devices.
 - **AP:** The projector is cabled to the wired network to allow other wireless clients access to. The projector also supports a network control or web server.
 - **Infrastructure:** A wireless networking bridges (joins) a wireless network to a wired Ethernet network.
- **DHCP:** Abbreviation for Dynamic Host Configuration Protocol. This protocol automatically assigns IP Address to networked devices.
 - When the "DHCP" sets to "Yes", it takes some time to obtain IP address from DHCP server.
 - When the "DHCP" sets to "No", that means user will set IP address by manually.
- **IP Address:** Numerical address to identify networked computers. This function can only be used when DHCP is set to No.
 - The IP Address is the number that identifies this projector on the network. You cannot have two devices with the same IP Address on the same network.
 - The IP Address "0.0.0.0" is prohibited.
- **Subnet Mask:** A numeric value to define the number of bits used for a network address of a divided network (or subnet) in an IP Address. This function can only be used when DHCP is set to No.
 - The Subnet Mask "0.0.0.0" is prohibited.
- **Apply:** Save and execute the wireless LAN settings.

Information

Input Source

Display the current input source.

Resolution

Display current input source resolution.

H. Frequency

Display current image horizontal frequency.

V. Frequency

Display current image vertical frequency.

MAC Address

Abbreviation for Media Access Control Address. MAC Address is a unique ID number assigned to each network adapter.

Filter Hours

Display the filter's elapsed operating time (in hours).

- When Filter Mode is turned on, the Filter Hours also turns on automatically.

Filter Hours Reset

Reset the filter Hour to 0 hours.

Lamp Hours

Display the lamp's elapsed operating time (in hours).

Lamp Hours Reset

Reset the lamp Hour to 0 hours.

Factory Default

Restore settings to factory default.

Language

Select the language used by the on-screen menu.

Controlling the projector through a LAN environment

You can manage and control the projector from one or more remote computers when they are properly connected to the same local area network.

Wired connection

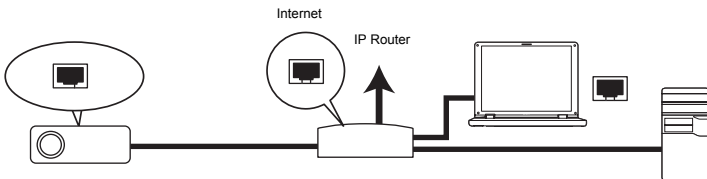

If you are in a DHCP environment:

1. Take a RJ45 cable and connect one end to the RJ45 LAN input jack of the projector and the other end to the RJ45 port on your Ethernet or router.
2. Press **MENU/EXIT** on the projector or **Menu** on the remote control and then press **◀/▶** until the **NetWork** menu is highlighted.
3. Highlight **Wired LAN** and press **ENTER** on the projector or **Enter** on the remote control.
4. Make sure the **Status** is **Connect**.
5. Press **▼** to highlight **DHCP** and press **◀/▶** to select **On**.
6. Press **▼** to highlight **Apply** and press **ENTER** on the projector or **Enter** on the remote control.
7. Please wait for around 15 - 20 seconds, and then re-enter the Wired LAN page. The **IP Address**, **Subnet Mask**, **Default Gateway**, and **DNS** settings will be displayed. Note down the IP address displayed in the **IP Address** row.



Important

- If the Projector IP Address still does not appear, contact your network administrator.
- If the RJ45 cables are not properly connected, the IP Address, Subnet Mask, Default Gateway, and DNS settings will display 0.0.0.0. Make sure the cables are properly connected and perform the procedures above again.
- If you wish to connect to the projector in its standby mode, be sure you have selected RJ45 and obtained the IP Address, Subnet Mask, Default Gateway, and DNS information when the projector is on.

If you are in a non-DHCP environment:

1. Repeat steps 1-4 above.
2. Press **▼** to highlight **DHCP** and press **◀/▶** to select **Off**.
3. Contact your ITS administrator for information on the IP Address, Subnet Mask, Default Gateway, and DNS settings.

4. Press **▼** to select the item you want to modify and press **ENTER** on the projector or **Enter** on the remote control.
5. Press **◀/▶** to move the cursor and the enter the value.
6. To save the settings, press **ENTER** on the projector or **Enter** on the remote control. If you do not want to save the settings, press **MENU/EXIT** on the projector or **Menu** on the remote control.
7. Press **▼** to highlight **Apply** and press **ENTER** on the projector or **Enter** on the remote control.



Important

- If the RJ45 cables are not properly connected, the IP Address, Subnet Mask, Default Gateway, and DNS settings will display 0.0.0.0. Make sure the cables are properly connected and perform the procedures above again.
- If you wish to connect to the projector in its standby mode, be sure you have selected RJ45 and obtained the IP Address, Subnet Mask, Default Gateway, and DNS information when the projector is on.

Wireless connection

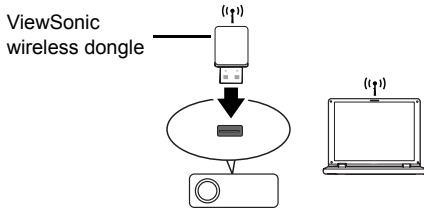

To connect to the projector wirelessly, you have to plug a ViewSonic wireless dongle (optional) to the USB Type A connector on the projector, and then only a few OSD configuration steps are required.

1. Make sure the projector is turned on.
2. Press **MENU/EXIT** on the projector or **Menu** on the remote control and then press **◀ / ▶** until the **NetWork** menu is highlighted.
3. Highlight **Wireless LAN** and press **ENTER** on the projector or **Enter** on the remote control.
4. Make sure the **Status** is **Connect**.
5. Make sure the **SSID** information is displayed.
6. Press **▼** to highlight **Connection Mode** and press **◀ / ▶** to select **AP** or **Infrastructure**. In **AP** mode, you need to use your computer's wireless connection utility to search the projector's SSID and connect to it. Then you can search the projector with pwPresenter. To use **Infrastructure** mode, you should connect both your computer and projector to the same AP router and make connections with the IP address.



Important

- If you need more information about AP and Infrastructure modes, please refer to user documentations for Wireless Routers which are usually available on 3C stores.

Controlling the projector through a web browser

Once you have the correct IP address for the projector and the projector is on or in standby mode, you can use any computer that is on the same local area network to control the projector.



Important

- If you are using Microsoft Internet Explorer, make sure it is version 7.0 or higher.
 - The screenshots in this manual are for reference only, and may differ from the actual design.
1. Enter the address of the projector in the address bar of your browser and press Enter.



2. The main page of the ViewSonic webpage control system appears.

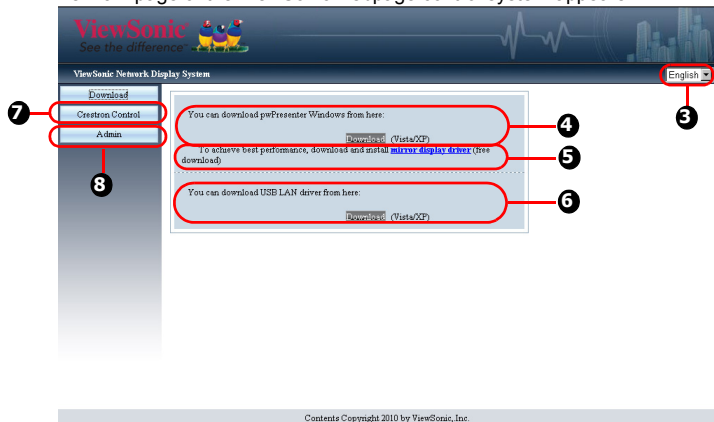

3. To change the language for the web pages, click the down arrow to reveal a drop down list and select a desired language.
4. To download pwPresenter, click Download. See [“Displaying images through pwPresenter” on page 47](#) for details.
5. To achieve best performance, download the install mirror display driver.
6. To download USB LAN driver, click Download.

7. To have access to the Admin page, you need to enter a password. The default password is “0000”.

ViewSonic Network Display System > System Status Logout

System Status	Model Name	ViewSonic Network Display
General Setup	Version	
Picture Setup	Firmware Version	PWNDSS 1.1_PWC807
Image Setup	LAN Status	
Alert Setup	IP Address	10.33.96.131
SMTP Mail Setup	Subnet Mask	255.255.255.0
Network Setup	Default Gateway	10.33.96.1
Presenter Setup	Wire MAC Address	00:16:44:AD:76:6A
Reset to Default	Wireless Status	
Reboot System	Mode	
	ESSID	
	Channel	
	IP address	
	Subnet mask	
	Default gateway	
	Wireless MAC Address	

Contents Copyright 2010 by ViewSonic, Inc.

- System Status: Displays the system information.
- General Setup: Allows you to change the password for the Admin page.
- Picture Setup/Image Setup: Provides some OSD menu items for adjusting the projected pictures.
- Alert Setup/SMTP Mail Setup: Allows you to setup the mail server and send system error messages to your ITS administrator.
- Network Setup: Provides wired and wireless network settings.
- Presenter Setup: Allows you to change Admin and User passwords for web control.
- Reset to Default: Allows you to restore the device to the factory default settings.
- Reboot System: Allows you to reboot the device immediately.

8. The Crestron (eControl) page displays the Crestron eControl user interface. The eControl page provides a variety of virtual keys to control the projector or adjust the projected pictures.

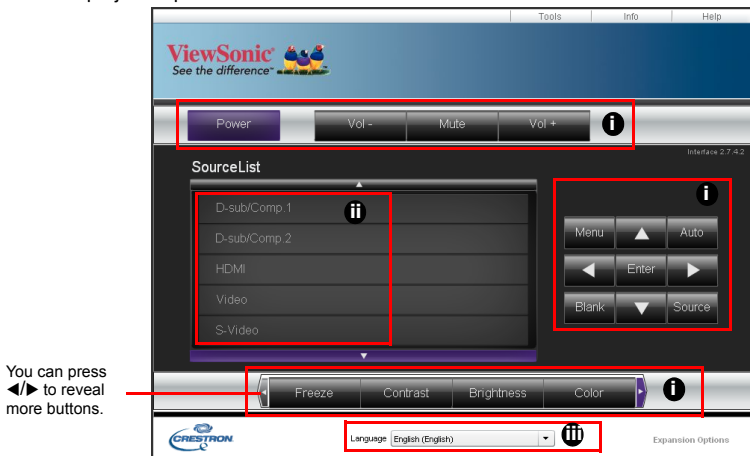

You can press  to reveal more buttons.

- i. These buttons function the same as the ones on the OSD menus or remote control.
- ii. To switch between input signals, click on your desired signal.
- iii. To change the language for the Crestron page, click the down arrow to reveal a drop down list and select a desired language.



Important

- The Menu button can also be used to go back to previous OSD menus, exit and save menu settings.
- The source list varies according to the connectors available on the projector.
- When you use the projector control panel or remote control to change the OSD menu settings, it may take a while for the web browser to synchronize these changes with the projector.

The tools page allows you to manage the projector, configure the LAN control settings and secure access of remote network operation on this projector.

- iv. This section is only used with the Crestron Control System. Please contact Creston or refer to its user manual for setup information.
- v. Click the down arrow to reveal a drop down list and select a default language.
- vi. You can name the projector, keep track of its location and the person in charge of it.
- vii. You can adjust the LAN Control Settings.
- viii. Once set, access to the remote network operation on this projector has been password-protected.
- ix. Once set, access to the tools page has been password-protected.



Important

- To prevent errors, only input the English alphabet and digits on the tools page.
 - After making the adjustments, press the Send button and the data will be saved for the projector.
- x. Press **Exit** to go back to the remote network operation page.

Please pay attention to the limitation of input length (including space and other punctuation keys) in the list blow:

Category Item	Input Length	Maximum Number of Characters
Crestron Control	IP Address	15
	IP ID	2
	Port	5
Projector	Projector Name	10
	Location	9
	Assigned To	9
Network Configuration	DHCP (Enabled)	(N/A)
	IP Address	15
	Subnet Mask	15
	Default Gateway	15
	DNS Server	15
User Password	Enabled	(N/A)
	New Password	20
	Confirm	2
Admin Password	Enabled	(N/A)
	New Password	20
	Confirm	20

The info page displays the information and status of this projector.

Projector Information		Projector Status	
ProjectorName		PowerStatus	On
Location	Room	Source	USB Reader
Firmware		PresetMode	Presentation
MacAddress	00:01:02:03:04:05	ProjectorPosition	Front Table
Resolution	0 x 0 0Hz	LampMode	Normal
LampHours	0	ErrorStatus	
AssignedTo	Bir		

exit

Language: English (English)

Expansion Options

Press **Exit** to go back to the remote network operation page.

After pressing the button "Contact IT Help", the HELP DESK window will appear in the upper right corner of the screen. You will be able to deliver messages to RoomView software administrators/users who connect to the same local area network.

For more information, visit <http://www.crestron.com> & www.crestron.com/getroomview.

Displaying images through pwPresenter

Downloading and installing pwPresenter

The pwPresenter is an application running on the host PC. It helps connect your computer to an available network projector and transfer the desktop content to the network projector via local network connection.

1. Enter the main page of Network Control. See steps 1-2 on page 41 for details.
2. Download pwPresenter.
3. When the download is complete, install the software to your computer by clicking the exe file. Follow the on-screen instructions to complete the installation.
4. Launch pwPresenter.

Using pwPresenter

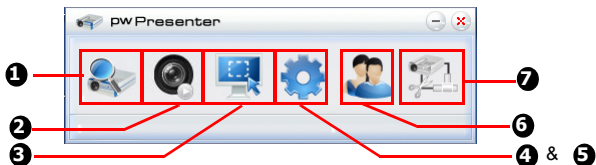

1. The Search page allows you to search and connect to a projector.

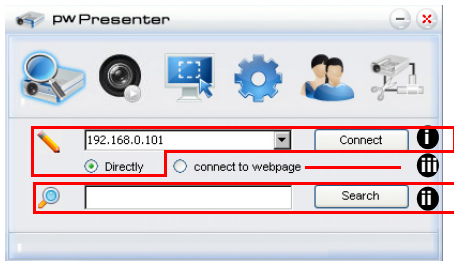

- i. To connect to a projector, select Directly then type the projector IP address and click Connect.
- ii. To search for projectors, simply click Search to list all the projectors on the same local area network. Click the desired projectors in the Search result list, and click Connect directly. You can also type a desired projector name and click Search.
- iii. You can link to the ViewSonic webpage control system on [page 41](#).

2. The Capture screen allows you to start or pause capture screen.

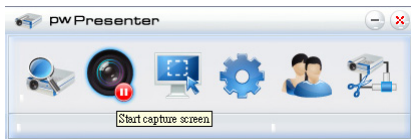

3. You can choose a capture mode from here.

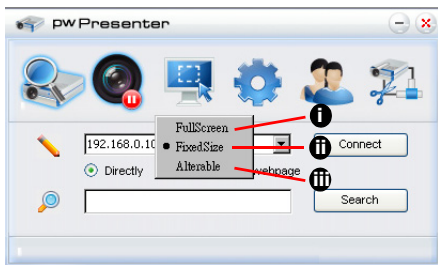

- i. To display a full screen, click FullScreen.
- ii. To display a partial screen, click FixedSize. A square appears on your screen. You can place it where you want to project.
- iii. If you wish to change the square, click Alterable.

4. The Basic Setting page allows you to configure pwPresenter.

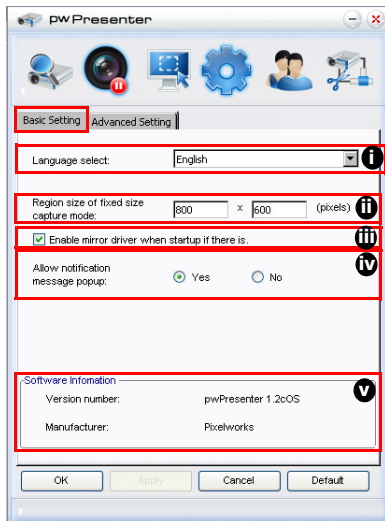

- i. To change the pwPresenter interface language, click the down arrow to reveal a drop-down list and select a desired language. Click Apply.
- ii. Users can change the size parameters of the frame in FixedSize capture mode by modifying width and height on this page and click Apply to make changes take effect.
- iii. User can use the mirror driver for presenter capture image, if the system has installed the mirror driver.
- iv. To allow notification messages to appear, click Yes. Click Apply.
- v. The Software Information is available on this page.

5. The Advanced Setting page allows you to configure pwPresenter.

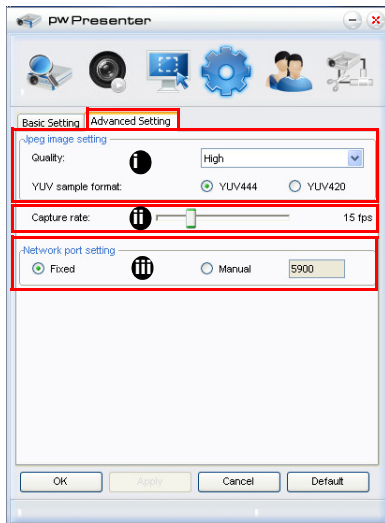

- i. To adjust the image quality, click the down arrow to reveal a drop-down list and select a desired quality level. Click Apply.
- ii. To adjust the capture rate, move the slide bar. The network bandwidth may also affect the performance.
- iii. Network port setting for fixed or manual type.

6. Network Display Management displays the Device Management and pwPresenter Management information.

Device Management allows you to change device settings .

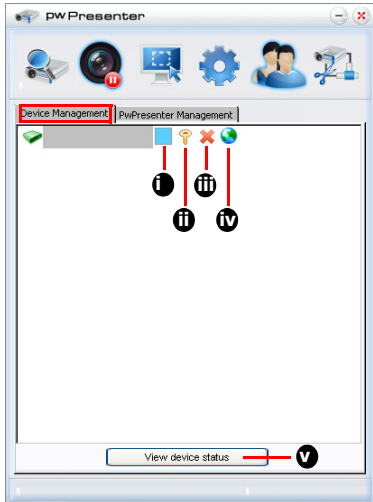

- i. Click to change display port allows you to select display location of screen.
- ii. Change password allows you to change password for the user type.
- iii. Disconnect allows you to disconnect the projector from network.
- iv. Access device via webpage allows you to access ViewSonic webpage control system.
- v. View device status displays device setting information and allows you to enter conference control mode.

pwPresenter Management allows you to select which computer to be connected and transfer the desktop content to the network projector.

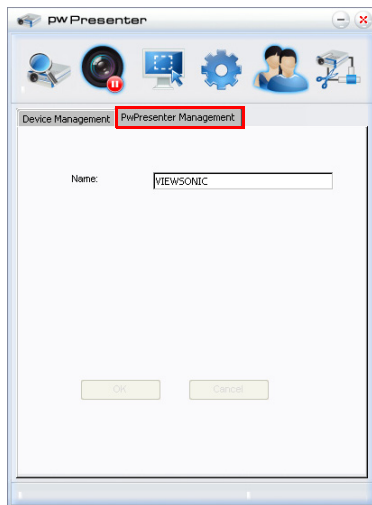

7. Disconnect allows you to disconnect from the projector(s) by clicking the Disconnect icon.



Important

- Be sure to turn off other virtual network control programs before using pwPresenter.

Displaying pictures with a USB storage device

The built-in the ImageViewer application can display packaged images on a USB storage device (e.g. USB flash drive, and USB disk), a digital camera, or other device. You can connect a USB storage device to your projector.

1. Take a USB cable and connect the larger end to the **USB A** socket on the projector, and smaller end to the USB port of the device. If you are using a USB flash drive, connect it directly to the **USB A** socket.
2. The projector automatically display the thumbnails. Or your can manually select USB Reader from the source selection bar.
3. The ImageView main screen is displayed and ready to use. The main screen is displayed in Thumbnail Display Mode which shows the following four parts:

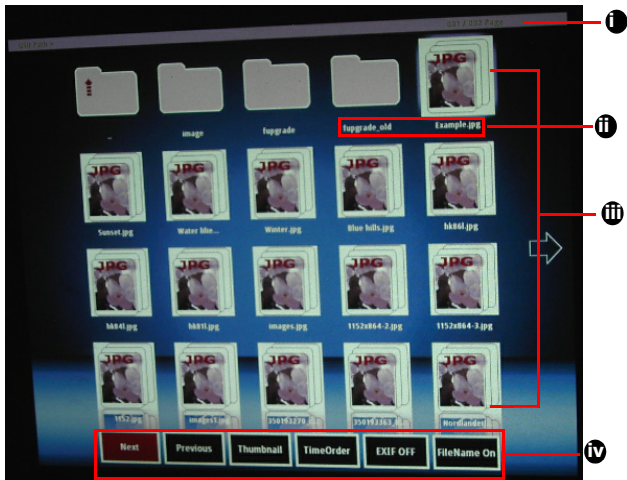

- i. Current path, USB storage device name and page number
 - ii. File and folder name display (i18N, multi-language)
 - iii. Thumbnail images (120 x 120 pixels images)
 - iv. Operation User Interface
4. Use the four directional buttons or page up/down button to move between pages/ folders. To Press and hold **Menu** and then press **Enter** to display the operation user interface. Use **◀/▶** to select the desired item and adjust the settings with **▲/▼**. To confirm the selection press **Enter**. The following buttons are supported in the user interface.
 - Next: Display next page.
 - Previous: Display previous page.

- Thumbnail/Slide show/Display: Display thumbnails, start the slide show or display the selected image.
- Name Order/Extend Order/Size Order/Time Order: Select the order setting by file/folder name, extended file name, image size or time.
- EXIF ON/EXIF OFF: Display the Exif information of the image or not.
- File Name On/File Name Off: Display the file name or not.

The projector supports the following image formats:

- JPEG (JPG)
- Bitmap (BMP)
- Portable Network Graphic (PNG)
- Graphics Interchange Format (GIF)
- Tagged Image File Format (TIFF)

Maintenance

The projector needs proper maintenance. You should keep the lens clean as dust, dirt or spots will project on the screen and diminish image quality. If any other parts need replacing, contact your dealer or qualified service personnel. When cleaning any part of the projector, always switch off and unplug the projector first.



Warning

Never open any of the covers on the projector. Dangerous electrical voltages inside the projector can cause severe injury. Do not attempt to service this product yourself. Refer all servicing to qualified service personnel.

Cleaning the Lens

Gently wipe the lens with lens cleaning paper. Do not touch the lens with your hands.

Cleaning the Projector Housing

Gently wipe with a soft cloth. If dirt and stains are not easily removed, use a soft cloth dampened with water, or water and neutral detergent, and wipe dry with a soft, dry cloth.

Cleaning the Filter Cover

The filter cover, which is located at the side of the projector, should be cleaned after every 100 hours of use. If it is not cleaned periodically, it can become clogged with dust and prevent the projector from being ventilated properly. This can cause over heating and damage the projector.

To clean the filter cover:

1. Switch the projector off and unplug the AC power cord from the wall socket.
2. Remove the filter cover as the illustration shown.
3. Clean the filter cover.
 - To clean the filter cover, you are advised to use a small vacuum cleaner designed for computers and other office equipment.
 - If the filter cover is torn, replace it.
4. Replace the filter cover.
5. Attach the filter cover.
6. Plug the power back into the projector.

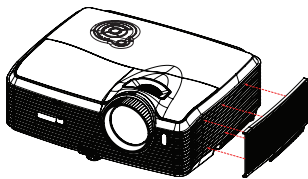

- Turn off the projector and remove the AC power cord from the power outlet before beginning maintenance work.
- Make sure the lens is cool before cleaning.
- Do not use detergents or chemicals other than those noted above. Do not use benzene or thinners.
- Do not use chemical sprays.
- Use a soft cloth or lens paper only.

Replacing the Lamp

As the projector operates over time, the brightness of the projector lamp gradually decreases and the lamp becomes more susceptible to breakage. We recommend replacing the lamp if a warning message is displayed. Do not attempt to replace the lamp yourself. Contact the qualified service personnel for replacement.



- *The lamp is extremely hot right after turning off the projector. If you touch the lamp, you may scald your finger. When you replace the lamp, wait for at least 45 minutes for the lamp to cool down.*
- *Do not touch the lamp glass at any time. The lamp may explode due to improper handling, including the touching of the lamp glass.*
- *Lamp lifetime may differ from lamp to lamp and according to the environment of use. There is no guarantee of the same lifetime for each lamp. Some lamps may fail or terminate their lifetime in a shorter period of time than other similar lamps.*
- *A lamp may explode as a result of vibration, shock or degradation as a result of hours of use as its lifetime draws to an end. Risk of explosion may differ according to the environment or conditions in which the projector and lamp are being used.*
- *Wear protective gloves and eyeglasses when fixing or detaching the lamp.*
- *Faster on-off-cycles will damage the lamp and reduce lamp life. Wait at least for 5 minutes to turn off the projector after powering on.*
- *Do not operate the lamp in proximity to paper, cloth, or other combustible material nor cover it with such materials.*
- *Do not operate the lamp in an atmosphere containing an inflammable substance, such as thinner.*
- *Thoroughly ventilate the area or the room when operating the lamp in an oxygen atmosphere (in the air). If ozone is inhaled, it could cause headaches, nausea, dizziness, and other symptoms.*
- *The inorganic mercury is involved in the lamp. If the lamp bursts, the mercury inside the lamp will be exposed. Leave the area immediately if the lamp shatters while being operated and ventilate the area for at least 30 minutes in order to avoid the inhalation of mercury fumes. Otherwise it could be harmful to user's health.*

1. Turn off the projector.
2. If the projector is installed in a ceiling mount, remove it
3. Unplug the power cord.
4. Loosen the screw in the side of the lamp cover and remove the cover.
5. Remove the screws from the lamp module, raise the handle, and lift out the module.
6. Insert the new lamp module into the projector and tighten the screws.
7. Replace the lamp cover and tighten the screw.
8. Turn on the projector. If the lamp does not turn on after the warm-up period, try reinstalling the lamp.
9. Reset the lamp hour. Refer to the “Information” menu.

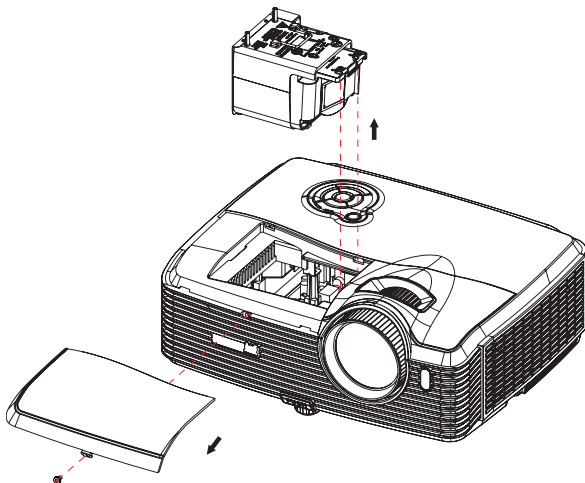

- *Dispose the used lamp according to local regulations.*
- *Ensure that screws are tightened properly. Screws not tightened fully may result in injury or accidents.*
- *Since the lamp is made of glass, do not drop the unit and do not scratch the glass.*
- *Do not reuse the old lamp. This could cause the lamp to explode.*
- *Be sure to turn off the projector and unplug the AC power cord before replacing the lamp.*
- *Do not use the projector with the lamp cover removed.*

Specifications

Display system	Single 0.7" DLP panel
Resolution	XGA (1024 × 768 pixels)
Zoom	1.5X
F/No.	2.41 - 2.97
Focal length	20.72 - 31mm
Screen size	30" - 300"
Lamp	280W
Input terminal	D-Sub 15-pin x 2, S-Video x 1, Video x 1, Audio signal input (3.5 mm stereo mini jack) x 2, HDMI x 1, Component RCA jack x 1, RCA audio jack (L/R) x 1, 3.5 mm Mic input x1, USB A type x1 (supports USB flash drive display and wireless dongle for USB display), USB mini-B type x1 (supports USB display)
Output terminal	D-Sub 15 pin x 1, Audio signal output (3.5 mm stereo mini jack) x 1
Control terminal	RS-232 x 1, USB B type x 1 (supports firmware upgrade and remote mouse control), RJ45 x 1, 12-Vdc trigger output x 1
Speaker	10 watt x 2
Video compatibility	NTSC, NTSC 4.43 PAL, PAL-N, PAL M SECAM, HDTV (480i/p, 576p, 720p, 1080i/p), Composite video
Scanning frequency	
Horizontal frequency	31 - 100 KHz
Vertical frequency	50 - 120 Hz
Environment	Operating: Temperature: 0°C to 40°C Humidity: 10%-80% Storage: Temperature: -20°C to 60°C Humidity: 30%-85%
Power requirement	AC 100-240 V, 50 - 60 Hz, 3.8A
Power consumption	380 W
Dimension (W x D x H)	334.6 x 264.5 x 109.5 mm
Weight	3.9 kg (8.6 lb)
Note: Design and Specifications are subject to change without prior notice.	

Dimensions

334.6 mm (W) x 264.5 mm (D) x 109.5 mm (H)

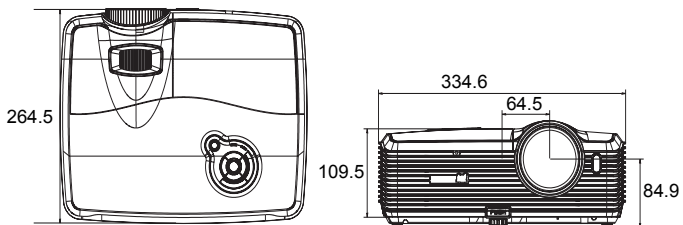

Ceiling mount installation

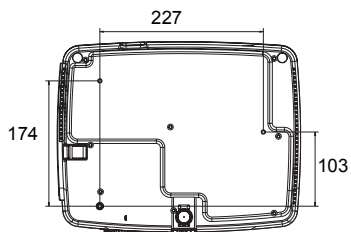

Ceiling mount screws:
M4 x 8 (Max. L = 8 mm)

Unit: mm

Appendix

LED Indicator Messages

LED Type	Color	Status	Meaning
Power LED	Blue	Solid	Standby mode when green mode is turned on.
Lamp LED	Red	Off	
Temp LED	Red	Off	
Power LED	Blue	Flash	Standby mode when green mode is turned off.
Lamp LED	Red	Off	
Temp LED	Red	Off	
Power LED	Blue	Solid	Powering up
Lamp LED	Red	Off	
Temp LED	Red	Off	
Power LED	Blue	Solid	Normal operation
Lamp LED	Red	Off	
Temp LED	Red	Off	
Power LED	Blue	Flash	Powering down (The projector needs to cool for 35 seconds after the projector is turned off.)
Lamp LED	Red	Off	
Temp LED	Red	Off	
Power LED	Blue	Solid	The projector system has some problems with its fans, so the projector cannot start up.
Lamp LED	Red	Solid	
Temp LED	Red	Flash	
Power LED	Blue	Solid	The lamp has reached its end of life and must be changed soon. The lamp will continue to operate until it fails. Change the lamp. If the lamp is off, then the ballast will become malfunction.
Lamp LED	Red	Solid	
Temp LED	Red	Off	
Power LED	Blue	Solid	Temperature is too high. The lamp will turn off. The fan motor is cooling the lamp.
Lamp LED	Red	Flash	
Temp LED	Red	Off	
Power LED	Blue	Off	The lamp ignition failed. If temperature is too high, the fans will cool the lamp.
Lamp LED	Red	Solid	
Temp LED	Red	Solid	
Power LED	Blue	Flash	The cooling process is not complete after the projector is shut down and re-started right away.
Lamp LED	Red	Solid	
Temp LED	Red	Off	

Compatibility Modes

Computer:

Compatibility	Resolution	H-Sync [KHz]	V-Sync [Hz]
VGA (Expanded) DOS/Text mode visible	640 x 480	24.69	50
		31.5	60
		37.9	72
		37.5	75
		43.3	85
SVGA (Expanded)	800 x 600	30.99	50
		35.2	56
		37.9	60
		48.1	72
		46.9	75
		53.7	85
XGA (Native)	1024 x 768	39.63	50
		48.4	60
		56.5	70
		60	75
SXGA (Compressed)	1280 x 1024	64	60
		80	75
UXGA (Compressed)	1600 x 1200	47.7	60
Mac 13	640 x 480	35	67
Mac 16	832 x 624	49.72	75
Mac 19	1024 x 768	60.24	75
Others	1280 x 768	47.8	60
	1280 x 800	49.7	60
	640 x 350	37.9	85
	1280 x 960	60.02	60
	1360 x 768	47.7	60

Video:

Compatibility	Resolution	H-Sync [KHz]	V-Sync [Hz]
1080p	1920 x 1080	67.5	60
1080p	1920 x 1080	56.3	50
1080i	1920 x 1080	33.8	60
1080i	1920 x 1080	28.1	50
720p	1280 x 720	45	60
720p	1280 x 720	37.5	50
576p	720 x 576	31.3	50
576i	720 x 576	15.6	50
480p	720 x 480	31.5	60
480i	720 x 480	15.8	60

Troubleshooting

Refer to the symptoms and measures listed below before sending the projector for repairs. If the problem persists, contact your local reseller or service center. Please refer to "LED Indicator Messages" as well.

Start-up problems

If no lights turn on:

- Be sure that the power cord is securely connected to the projector and the other end is plugged into an outlet with power.
- Press the power button again.
- Unplug the power cord and wait for a short while, then plug it in and press the power button again.

Image problems

If the searching source is displayed:

- Press **SOURCE** on the projector or **Source** on the remote control to select an active input source.
- Be sure the external source is turned on and connected.
- For a computer connection, ensure your notebook computer's external video port is turned on. Refer to the computer manual.

If the image is out of focus:

- Be sure the lens cover is removed.
- While displaying the on-screen menu, adjust the focus ring. (The image size should not change; if it does, you are adjusting the zoom, not the focus.)
- Check the projection lens to see if it needs cleaning.

If the image is flickering or unstable for a computer connection:

- Press **Auto** on the remote control.
- Press **MENU** on the projector or **Menu** on the remote control, go to **Video/Audio Setting** and adjust **Frequency** or **Tracking**.

Remote control problems

If the remote control does not operate:

- Be sure nothing is blocking the remote control receiver on the front of the projector. Use the remote control within the effective range.
- Aim the remote control at the screen or at the front or back of the projector.
- Move the remote control so it is more directly in front of or behind the projector and not as far to the side.

RS-232 Command and Configuration

POWER ON / POWER OFF	
POWER ON	BE,EF,10,05,00,C6,FF,11,11,01,00,01,00
POWER OFF	BE,EF,03,06,00,DC,DB,69,00,00,00,00,00
SOURCE SELECT	
Computer 1	BE,EF,03,19,00,19,29,01,47,02,CC,CC,00
Computer 2	BE,EF,03,19,1E,90,72,01,47,02,CC,CC,00
COMPONENT	BE,EF,03,19,00,89,E8,01,47,02,CC,CC,00
COMPOSITE	BE,EF,03,19,00,78,A8,01,47,02,CC,CC,00
S-VIDEO	BE,EF,03,19,00,E8,69,01,47,02,CC,CC,00
HDMI	BE,EF,03,19,00,DA,2B,01,47,02,CC,CC,00
USB Reader	BE,EF,02,06,00,D2,A1,38,00,00,00,00,00
USB Display Link	BE,EF,02,06,00,D3,70,39,00,00,00,00,00
QUICK KEY	
MENU	BE,EF,02,06,00,E9,D3,30,00,00,00,00,00
UP	BE,EF,02,06,00,6D,D2,34,00,00,00,00,00
DOWN	BE,EF,02,06,00,0B,D2,32,00,00,00,00,00
LEFT	BE,EF,02,06,00,DA,D3,33,00,00,00,00,00
RIGHT	BE,EF,02,06,00,38,D2,31,00,00,00,00,00
ENTER	BE,EF,02,06,00,D5,6B,12,00,00,00,00,00
RESYNC	BE,EF,02,06,00,86,D1,2F,00,00,00,00,00
ASPECT	BE,EF,03,06,00,0D,DA,68,00,00,00,00,00
MUTE	BE,EF,02,06,00,0E,DE,67,00,00,00,00,00
FREEZE	BE,EF,02,06,00,02,D0,2B,00,00,00,00,00
BLANK	BE,EF,02,06,00,DF,DF,66,00,00,00,00,00
SOURCE	BE,EF,02,06,00,57,D0,2E,00,00,00,00,00
OTHER FUNCTION	
DCR ON	BE,EF,02,06,00,D3,D1,2A,00,00,00,00,00
DCR OFF	BE,EF,02,06,00,02,D0,2B,00,00,00,00,00
ECO ON	BE,EF,03,06,00,EF,DB,6A,00,00,00,00,00
ECO OFF	BE,EF,03,06,00,3E,DA,6B,00,00,00,00,00
VOLUME INC	BE,EF,02,06,00,F1,DE,68,00,00,00,00,00
VOLUME DEC	BE,EF,02,06,00,20,DF,69,00,00,00,00,00
KEYSTONE INC	BE,EF,03,06,00,10,DB,65,00,00,00,00,00
KEYSTONE DEC	BE,EF,03,06,00,23,DB,66,00,00,00,00,00
LAMP HOURS RESET	BE,EF,02,06,00,D3,43,3A,00,00,00,00,00
FILTER HOURS RESET	BE,EF,02,06,00,D2,92,3B,00,00,00,00,00
FACTORY RESET	BE,EF,03,06,00,6B,DA,6E,00,00,00,00,00

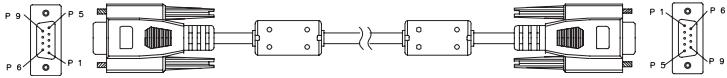

D-Sub 9 pin

1	1 CD
2	RXD
3	TXD
4	DTR
5	GND
6	DSR
7	RTS
8	CTS
9	RI

Wire List

C1	COLOR	C2
1	Black	1
2	Brown	2
3	Red	3
4	Orange	4
5	Yellow	5
6	Green	6
7	Blue	7
8	Purple	8
9	White	9
SHELL	DW	SHELL

IR Control Code

System Code: 83F4

Format : NEC



Customer Support

For technical support or product service, see the table below or contact your reseller.

Note : You will need the product serial number.

Country/Region	Website	T = Telephone F = FAX	Email
Australia/New Zealand	www.viewsonic.com.au	AUS= 1800 880 818 NZ= 0800 008 822	service@au.viewsonic.com
Canada	www.viewsonic.com	T (Toll-Free)= 1-866-463-4775 T (Toll)= 1-424-233-2533 F= 1-909-468-3757	service.ca@viewsonic.com
Europe	www.viewsoniceurope.com	www.viewsoniceurope.com/uk/Support/Calldesk.htm	
Hong Kong	www.hk.viewsonic.com	T= 852 3102 2900	service@hk.viewsonic.com
India	www.in.viewsonic.com	T= 1800 11 9999	service@in.viewsonic.com
Ireland (Eire)	www.viewsoniceurope.com/uk/	www.viewsoniceurope.com/uk/ support/call-desk/	service_ie@viewsoniceurope.com
Korea	www.kr.viewsonic.com	T= 080 333 2131	service@kr.viewsonic.com
Latin America (Argentina)	www.viewsonic.com/la/	T= 0800-4441185	soporte@viewsonic.com
Latin America (Chile)	www.viewsonic.com/la/	T= 1230-020-7975	soporte@viewsonic.com
Latin America (Columbia)	www.viewsonic.com/la/	T= 01800-9-157235	soporte@viewsonic.com
Latin America (Mexico)	www.viewsonic.com/la/	T= 001-8882328722	soporte@viewsonic.com
Renta y Datos, 29 SUR 721, COL. LA PAZ, 72160 PUEBLA, PUE. Tel: 01.222.891.55.77 CON 10 LINEAS Electroser, Av Reforma No. 403Gx39 y 41, 97000 Mérida, Yucatán. Tel: 01.999.925.19.16 Other places please refer to http://www.viewsonic.com/la/soporte/index.htm#Mexico			
Latin America (Peru)	www.viewsonic.com/la/	T= 0800-54565	soporte@viewsonic.com
Macau	www.hk.viewsonic.com	T= 853 2870 0303	service@hk.viewsonic.com
Middle East	ap.viewsonic.com/me/	Contact your reseller	service@ap.viewsonic.com
Puerto Rico & Virgin Islands	www.viewsonic.com	T= 1-800-688-6688 (English) T= 1-866-379-1304 (Spanish) F= 1-909-468-3757	service.us@viewsonic.com soporte@viewsonic.com
Singapore/Malaysia/Thailand	www.ap.viewsonic.com	T= 65 6461 6044	service@sg.viewsonic.com
South Africa	ap.viewsonic.com/za/	Contact your reseller	service@ap.viewsonic.com
United Kingdom	www.viewsoniceurope.com/uk/	www.viewsoniceurope.com/uk/ support/call-desk/	service_gb@viewsoniceurope.com
United States	www.viewsonic.com	T (Toll-Free)= 1-800-688-6688 T (Toll)= 1-424-233-2530 F= 1-909-468-3757	service.us@viewsonic.com

Limited Warranty

VIEWSONIC® PROJECTOR

What the warranty covers:

ViewSonic warrants its products to be free from defects in material and workmanship, under normal use, during the warranty period. If a product proves to be defective in material or workmanship during the warranty period, ViewSonic will, at its sole option, repair or replace the product with a like product. Replacement product or parts may include remanufactured or refurbished parts or components.

Limited Three (3) year General Warranty

Subject to the more limited one (1) year warranty set out below, North and South America: Three (3) years warranty for all parts excluding the lamp, three (3) years for labor, and one (1) year for the original lamp from the date of the first consumer purchase; Europe except Poland: Three (3) years warranty for all parts excluding the lamp, three (3) years for labor, and ninety (90) days for the original lamp from the date of the first consumer purchase; Poland: Two (2) years warranty for all parts excluding the lamp, two (2) years for labor, and ninety (90) days for the original lamp from the date of the first consumer purchase.

Limited One (1) year Heavy Usage Warranty:

Under heavy usage settings, where a projector's use includes more than four (4) hours average daily usage, North and South America: One (1) year warranty for all parts excluding the lamp, one (1) year for labor, and ninety (90) days for the original lamp from the date of the first consumer purchase; Europe: One (1) year warranty for all parts excluding the lamp, one (1) year for labor, and ninety (90) days for the original lamp from the date of the first consumer purchase.

Other regions or countries: Please check with your local dealer or local ViewSonic office for the warranty information.

Lamp warranty subject to terms and conditions, verification and approval. Applies to manufacturer's installed lamp only. All accessory lamps purchased separately are warranted for 90 days.

Who the warranty protects:

This warranty is valid only for the first consumer purchaser.

What the warranty does not cover:

1. Any product on which the serial number has been defaced, modified or removed.
2. Damage, deterioration, failure, or malfunction resulting from:
 - a. Accident, abuse, misuse, neglect, fire, water, lightning, or other acts of nature, improper maintenance, unauthorized product modification, or failure to follow instructions supplied with the product.
 - b. Operation outside of product specifications.
 - c. Operation of the product for other than the normal intended use or not under normal conditions.
 - d. Repair or attempted repair by anyone not authorized by ViewSonic.
 - e. Any damage of the product due to shipment.
 - f. Removal or installation of the product.
 - g. Causes external to the product, such as electric power fluctuations or failure.

- h. Use of supplies or parts not meeting ViewSonic's specifications.
 - i. Normal wear and tear.
 - j. Any other cause which does not relate to a product defect.
3. Removal, installation, and set-up service charges.

How to get service:

1. For information about receiving service under warranty, contact ViewSonic Customer Support (please refer to "Customer Support" page). You will need to provide your product's serial number.
2. To obtain warranted service, you will be required to provide (a) the original dated sales slip, (b) your name, (c) your address, (d) a description of the problem, and (e) the serial number of the product.
3. Take or ship the product freight prepaid in the original container to an authorized ViewSonic service center or ViewSonic.
4. For additional information or the name of the nearest ViewSonic service center, contact ViewSonic.

Limitation of implied warranties:

There are no warranties, express or implied, which extend beyond the description contained herein including the implied warranty of merchantability and fitness for a particular purpose.

Exclusion of damages:

ViewSonic's liability is limited to the cost of repair or replacement of the product. ViewSonic shall not be liable for:

1. Damage to other property caused by any defects in the product, damages based upon inconvenience, loss of use of the product, loss of time, loss of profits, loss of business opportunity, loss of goodwill, interference with business relationships, or other commercial loss, even if advised of the possibility of such damages.
2. Any other damages, whether incidental, consequential or otherwise.
3. Any claim against the customer by any other party.

Effect of state law:

This warranty gives you specific legal rights, and you may also have other rights which vary from state to state. Some states do not allow limitations on implied warranties and/or do not allow the exclusion of incidental or consequential damages, so the above limitations and exclusions may not apply to you.

Sales outside the U.S.A. and Canada:

For warranty information and service on ViewSonic products sold outside of the U.S.A. and Canada, contact ViewSonic or your local ViewSonic dealer.

The warranty period for this product in mainland China (Hong Kong, Macao and Taiwan Excluded) is subject to the terms and conditions of the Maintenance Guarantee Card.

For users in Europe and Russia, full details of warranty provided can be found in www.viewsoniceurope.com under Support/Warranty Information.

Mexico Limited Warranty

VIEWSONIC® PROJECTOR

What the warranty covers:

ViewSonic warrants its products to be free from defects in material and workmanship, under normal use, during the warranty period. If a product proves to be defective in material or workmanship during the warranty period, ViewSonic will, at its sole option, repair or replace the product with a like product. Replacement product or parts may include remanufactured or refurbished parts or components & accessories.

How long the warranty is effective:

3 years for all parts excluding the lamp, 3 years for labor, 1 year for the original lamp from the date of the first consumer purchase. Lamp warranty subject to terms and conditions, verification and approval. Applies to manufacturer's installed lamp only. All accessory lamps purchased separately are warranted for 90 days.

Who the warranty protects:

This warranty is valid only for the first consumer purchaser.

What the warranty does not cover:

1. Any product on which the serial number has been defaced, modified or removed.
2. Damage, deterioration or malfunction resulting from:
 - a. Accident, misuse, neglect, fire, water, lightning, or other acts of nature, unauthorized product modification, unauthorized attempted repair, or failure to follow instructions supplied with the product.
 - b. Any damage of the product due to shipment.
 - c. Causes external to the product, such as electrical power fluctuations or failure.
 - d. Use of supplies or parts not meeting ViewSonic's specifications.
 - e. Normal wear and tear.
 - f. Any other cause which does not relate to a product defect.
3. Any product exhibiting a condition commonly known as "image burn-in" which results when a static image is displayed on the product for an extended period of time.
4. Removal, installation, insurance, and set-up service charges.

How to get service:

For information about receiving service under warranty, contact ViewSonic Customer Support (Please refer to the attached Customer Support page). You will need to provide your product's serial number, so please record the product information in the space provided below on your purchase for your future use. Please retain your receipt of proof of purchase to support your warranty claim.

For Your Records

Product Name: _____ Model Number: _____
Document Number: _____ Serial Number: _____
Purchase Date: _____ Extended Warranty Purchase? _____ (Y/N)
If so, what date does warranty expire? _____

1. To obtain warranty service, you will be required to provide (a) the original dated sales slip, (b) your name, (c) your address, (d) a description of the problem, and (e) the serial number of the product.
2. Take or ship the product in the original container packaging to an authorized ViewSonic service center.
3. Round trip transportation costs for in-warranty products will be paid by ViewSonic.

Limitation of implied warranties:

There are no warranties, express or implied, which extend beyond the description contained herein including the implied warranty of merchantability and fitness for a particular purpose.

Exclusion of damages:

ViewSonic's liability is limited to the cost of repair or replacement of the product. ViewSonic shall not be liable for:

1. Damage to other property caused by any defects in the product, damages based upon inconvenience, loss of use of the product, loss of time, loss of profits, loss of business opportunity, loss of goodwill, interference with business relationships, or other commercial loss, even if advised of the possibility of such damages.
2. Any other damages, whether incidental, consequential or otherwise.
3. Any claim against the customer by any other party.
4. Repair or attempted repair by anyone not authorized by ViewSonic.

Contact Information for Sales & Authorized Service (Centro Autorizado de Servicio) within Mexico:	
Name, address, of manufacturer and importers: México, Av. de la Palma #8 Piso 2 Despacho 203, Corporativo Interpalmas, Col. San Fernando Huixquilucan, Estado de México Tel: (55) 3605-1099 http://www.viewsonic.com/la/soporte/index.htm	
NÚMERO GRATIS DE ASISTENCIA TÉCNICA PARA TODO MÉXICO: 001.866.823.2004	
Hermosillo: Distribuciones y Servicios Computacionales SA de CV. Calle Juárez 284 local 2 Col. Bugambilias C.P: 83140 Tel: 01-66-22-14-9005 E-Mail: disc2@hmo.megared.net.mx	Villahermosa: Compumantenimientos Garantizados, S.A. de C.V. AV. GREGORIO MENDEZ #1504 COL, FLORIDA C.P. 86040 Tel: 01 (993) 3 52 00 47 / 3522074 / 3 52 20 09 E-Mail: compumantenimientos@prodigy.net.mx
Puebla, Pue. (Matriz): RENTA Y DATOS, S.A. DE C.V. Domicilio: 29 SUR 721 COL. LA PAZ 72160 PUEBLA, PUE. Tel: 01(52).222.891.55.77 CON 10 LINEAS E-Mail: datos@puebla.megared.net.mx	Veracruz, Ver.: CONEXION Y DESARROLLO, S.A DE C.V. Av. Americas # 419 ENTRE PINZÓN Y ALVARADO Fracc. Reforma C.P. 91919 Tel: 01-22-91-00-31-67 E-Mail: gacosta@qplus.com.mx
Chihuahua Soluciones Globales en Computación C. Magisterio # 3321 Col. Magisterial Chihuahua, Chih. Tel: 4136954 E-Mail: Cefe@soluglobales.com	Cuernavaca Compusupport de Cuernavaca SA de CV Francisco Leyva # 178 Col. Miguel Hidalgo C.P. 62040, Cuernavaca Morelos Tel: 01 777 3180579 / 01 777 3124014 E-Mail: aquevedo@compusupportcva.com
Distrito Federal: QPLUS, S.A. de C.V. Av. Coyoacán 931 Col. Del Valle 03100, México, D.F. Tel: 01(52)55-50-00-27-35 E-Mail : gacosta@qplus.com.mx	Guadalajara, Jal.: SERVICRECE, S.A. de C.V. Av. Niños Héroes # 2281 Col. Arcos Sur, Sector Juárez 44170, Guadalajara, Jalisco Tel: 01(52)33-36-15-15-43 E-Mail: mmiranda@servicrece.com
Guerrero Acapulco GS Computación (Grupo Sesicomp) Progreso #6-A, Colo Centro 39300 Acapulco, Guerrero Tel: 744-48-32627	Monterrey: Global Product Services Mar Caribe # 1987, Esquina con Golfo Pérsico Fracc. Bernardo Reyes, CP 64280 Monterrey N.L. México Tel: 8129-5103 E-Mail: aydeem@gps1.com.mx
MÉRIDA: ELECTROSER Av Reforma No. 403Gx39 y 41 Mérida, Yucatán, México CP97000 Tel: (52) 999-925-1916 E-Mail: rrrb@sureste.com	Oaxaca, Oax.: CENTRO DE DISTRIBUCION Y SERVICIO, S.A. de C.V. Murguía # 708 P.A., Col. Centro, 68000, Oaxaca Tel: 01(52)95-15-15-22-22 Fax: 01(52)95-15-13-67-00 E-Mail: gpotai2001@hotmail.com
Tijuana: STD Av Ferrocarril Sonora #3780 L-C Col 20 de Noviembre Tijuana, Mexico	FOR USA SUPPORT: ViewSonic Corporation 381 Brea Canyon Road, Walnut, CA. 91789 USA Tel: 800-688-6688 (English); 866-323-8056 (Spanish); Fax: 1-800-685-7276 E-Mail: http://www.viewsonic.com

