

***myprojectorlamps.com***

**The most trusted, dependable name  
in projector lamp sales.**



<http://www.myprojectorlamps.com>



<http://www.myprojectorlamps.ca>



<http://www.myprojectorlamps.eu>

The following projector manual has not been modified or altered in any way.

**TOSHIBA**

*OWNER'S MANUAL*

**3LCD DATA PROJECTOR**

**TLP710U**

**TLP711U** (WITH DOCUMENT IMAGING CAMERA)

**TLP770U**

**TLP771U** (WITH DOCUMENT IMAGING CAMERA)

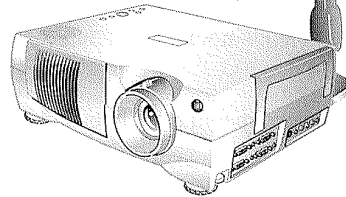
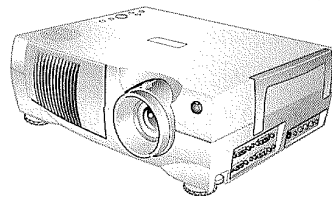
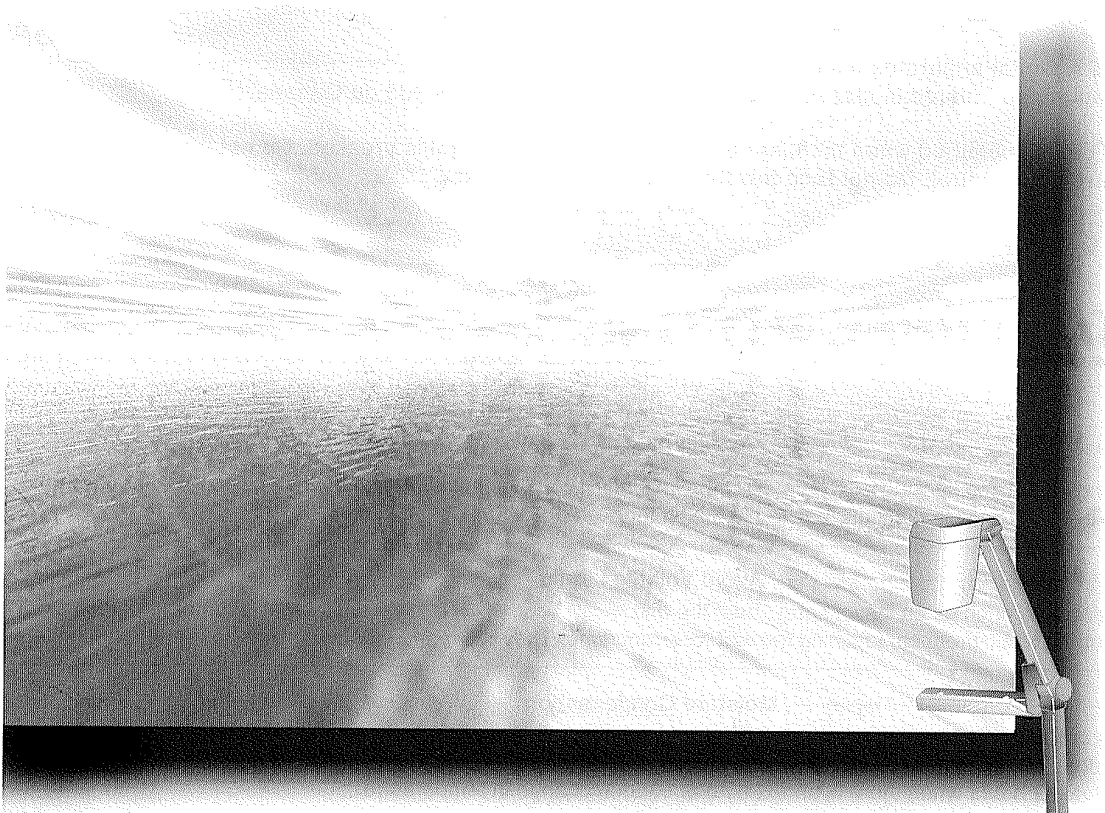

BEFORE USE

CONNECTIONS

INSTALLATION

OPERATIONS

ADJUSTMENTS

CAMERA

MAINTENANCE

OTHERS

# SAFETY PRECAUTIONS

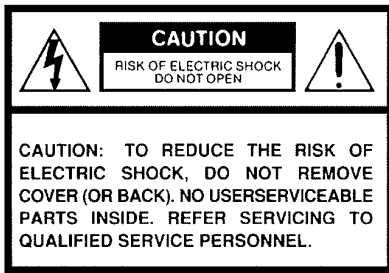

The lightning flash with arrowhead symbol, within an equilateral triangle, is intended to alert the user to the presence of uninsulated "dangerous voltage" within the product's enclosure that may be of sufficient magnitude to constitute a risk of electric shock to persons.



The exclamation point within an equilateral triangle is intended to alert the user to the presence of important operating and maintenance (servicing) instructions in the literature accompanying the appliance.

**WARNING: TO REDUCE THE RISK OF FIRE OR ELECTRIC SHOCK, DO NOT EXPOSE THIS APPLIANCE TO RAIN OR MOISTURE. DANGEROUS HIGH VOLTAGES ARE PRESENT INSIDE THE ENCLOSURE. DO NOT OPEN THE CABINET. REFER SERVICING TO QUALIFIED PERSONNEL ONLY.**

## FCC Radio Frequency Interference Statement

**Note:** This equipment has been tested and found to comply with the limits for a Class A digital device, pursuant to part 15 of the FCC Rules. These limits are designed to provide reasonable protection against harmful interference when the equipment is operated in a commercial environment. This equipment generates, uses, and can radiate radio frequency energy and, if not installed and used in accordance with the instruction manual, may cause harmful interference to radio communications. Operation of this equipment in a residential area is likely to cause harmful interference in which case the user will be required to correct the interference at his own expense.

**WARNING:** Changes or modifications made to this equipment, not expressly approved by Toshiba, or parties authorized by Toshiba, could void the user's authority to operate the equipment.

**Notice:** This Class A digital apparatus complies with Canadian ICES-003.  
Cet appareil numérique de la classe A est conforme à la norme NMB-003 du Canada.

**CAUTION:** Laser beam is emitted when the laser button of the remote control is pressed. Do not look from the front of the remote control. Do not face toward a person or to a mirror.

# IMPORTANT PRECAUTIONS

## Save Original Packing Materials

The original shipping carton and packing materials will come in handy if you ever have to ship your LCD projector. For maximum protection, repack the set as it was originally packed at the factory.

## Avoid Volatile Liquid

Do not use volatile liquids, such as an insect spray, near the unit.  
Do not leave rubber or plastic products touching the unit for a long time. They will mar the finish.

## Moisture Condensation

Never operate this unit immediately after moving it from a cold location to a warm location. When the unit is exposed to such a change in temperature, moisture may condense on the crucial internal parts. To prevent the unit from possible damage, do not use the unit for at least 2 hours when there is an extreme or sudden change in temperature.

In the spaces provided below, record the Model and Serial No. located at the rear of your LCD projector.

Model No. \_\_\_\_\_ Serial No. \_\_\_\_\_

Retain this information for future reference.

# IMPORTANT SAFETY INSTRUCTIONS

**CAUTION: PLEASE READ AND OBSERVE ALL WARNINGS AND INSTRUCTIONS GIVEN IN THIS OWNER'S MANUAL AND THOSE MARKED ON THE UNIT. RETAIN THIS BOOKLET FOR FUTURE REFERENCE.**

This set has been designed and manufactured to assure personal safety. Improper use can result in electric shock or fire hazard. The safeguards incorporated in this unit will protect you if you observe the following procedures for installation, use and servicing. This unit is fully transistorized and does not contain any parts that can be repaired by the user.

**DO NOT REMOVE THE CABINET COVER, OR YOU MAY BE EXPOSED TO DANGEROUS VOLTAGE. REFER SERVICING TO QUALIFIED SERVICE PERSONNEL ONLY.**

BEFORE USE

## 1. Read owner's manual

After unpacking this product, read the owner's manual carefully, and follow all the operating and other instructions.

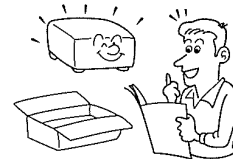

## 2. Power Sources

This product should be operated only from the type of power source indicated on the marking label. If you are not sure of the type of power supply to your home, consult your product dealer or local power company. For products intended to operate from battery power, or other sources, refer to the operating instructions.



## 3. Source of Light

Do not look into the lens while the lamp is on. The strong light from the lamp may cause damage to your eyes or sight.

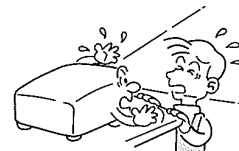

## 4. Ventilation

Openings in the cabinet are provided for ventilation and to ensure reliable operation of the product and to protect it from overheating, and these openings must not be blocked or covered. The openings should never be blocked by placing the product on a bed, sofa, rug or other similar surface. This product should not be placed in a built-in installation such as a bookcase or rack unless proper ventilation is provided or the manufacturer's instructions have been adhered to.

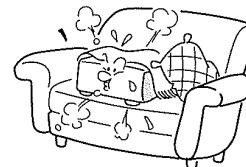

## 5. Heat

The product should be situated away from heat sources such as radiators, heat registers, stoves, or other products (including amplifiers) that produce heat.

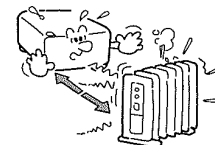

# IMPORTANT SAFETY INSTRUCTIONS

## 6. Water and Moisture

Do not use this product near water - for example, near a bath tub, wash bowl, kitchen sink, or laundry tub; in a wet basement; or near a swimming pool and the like.

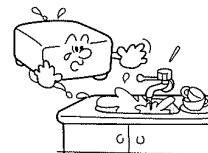

## 7. Cleaning

Unplug this product from the wall outlet before cleaning. Do not use liquid cleaners or aerosol cleaners. Use a damp cloth for cleaning.



## 8. Power-Cord Protection

Power-supply cords should be routed so that they are not likely to be walked on or pinched by items placed upon or against them, paying particular attention to cords at plugs, convenience receptacles, and the point where they exit from the product.



## 9. Overloading

Do not overload wall outlets; extension cords, or integral convenience receptacles as this can result in a risk of fire or electric shock.

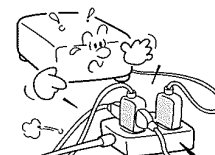

## 10. Lightning

For added protection for this product during storm, or when it is left unattended and unused for long periods of time, unplug it from the wall outlet.

This will prevent damage to the product due to lightning and power-line surges.

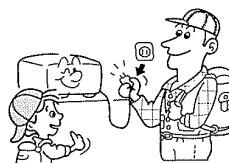

## 11. Object and Liquid Entry

Never push objects of any kind into this product through openings as they may touch dangerous voltage points or short-out parts that could result in a fire or electric shock. Never spill liquid of any kind on the product.

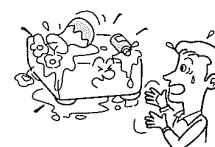

**12. Do not place the product vertically**

Do not use the product in the upright position to project the pictures at the ceiling, or any other vertical positions.  
It may fall down and dangerous.

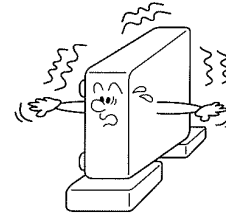

**13. Stack inhibited**

Do not stack other equipment on this product or do not place this product on the other equipment.  
Top and bottom plates of this product develops heat and may give some undesirable damage to other unit.

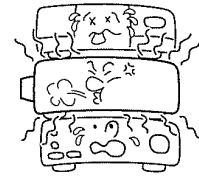

**14. Attachments**

Do not use attachments not recommended by the product manufacturer as they may cause hazards.

**15. Accessories**

Do not place this product on an unstable cart, stand, tripod, bracket, or table. The product may fall, causing serious injury to a child or adult, and serious damage to the product. Use only with a cart, stand, tripod, bracket, or table recommended by the manufacturer, or sold with the product. Any mounting of the product should follow the manufacturer's instructions, and should use a mounting accessory recommended by the manufacturer.

A product and cart combination should be moved with care. Quick stops, excessive force, and uneven surfaces may cause the product and cart combination to overturn.



**16. Damage Requiring Service**

Unplug this product from the wall outlet and refer servicing to qualified service personnel under the following conditions:

- a) When the power-supply cord or plug is damaged.
- b) If liquid has been spilled, or objects have fallen into the product.
- c) If the product has been exposed to rain or water.
- d) If the product does not operate normally by following the operating instructions. Adjust only those controls that are covered by the operating instructions as an improper adjustment of other controls may result in damage and will often require extensive work by a qualified technician to restore the product to its normal operation.
- e) If the product has been dropped or damaged in any way.
- f) When the product exhibits a distinct change in performance - this indicates a need for service.

### 17. Servicing

Do not attempt to service this product yourself as opening or removing covers may expose you to dangerous voltage or other hazards. Refer all servicing to qualified service personnel.



### 18. Replacement Parts

When replacement parts are required, be sure the service technician has used replacement parts specified by the manufacturer or have the same characteristics as the original part. Unauthorized substitutions may result in fire, electric shock, or other hazards.

(Replacement of the lamp only should be made by users.)

### 19. Safety Check

Upon completion of any service or repairs to this product, ask the service technician to perform safety checks to determine that the product is in proper operating condition.

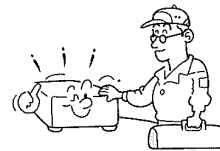

### 20. Do not get your hands between the camera arm and the main unit when setting the camera arm back in its original position.

To avoid injury, be careful not to get your hands caught when setting the camera arm back in its original position. Families with children should be particularly careful.

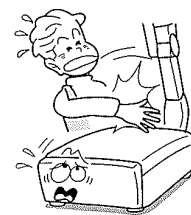

### 21. Do not carry by the camera arm.

Do not carry the projector by the camera arm. Doing so can result in damage or injury.

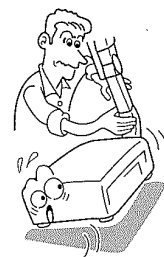

**22. Do not leave documents on the unit for long periods of time while using the document imaging function.**

Do not leave texts, papers or other documents for projection on the unit for long periods of time. The heat could erase the letters on a thermal paper.

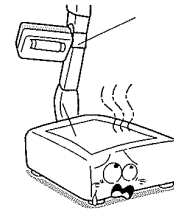

**23. Before replacing the fluorescent light, turn off the power and wait at least one hour for the fluorescent light to cool down.**

The fluorescent light gets hot, so handle it with care. Failure to do so may result in burns or other injuries.

**24. Do not leave documents in the bottom of the projector.**

Documents can block the air intake holes, making the inside of the projector heat up and causing breakdowns.

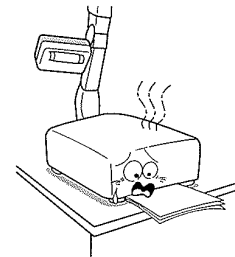

**25. Do not move the projector while the arm is still erect.**

Always store the arm back in position when moving the projector. Otherwise injury or damage may result.

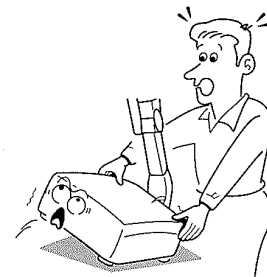

**26. Camera section is not locked. Do not hold the camera cover and camera unit when carrying out, etc.**

Danger such as dropping, or cause of failure and injury may result.





# FEATURES

Here are the main features of this projector.

## Uniformly bright high-quality picture

The newly developed optic unit displays uniformly bright pictures. The high aperture ratio LCD panel and UHP lamp provide high intensity output and beautiful bright images.

## High-density, high-quality video for multimedia

Reproduces video for the world's main television signal formats, NTSC, PAL, SECAM, and XGA, SVGA, VGA type computer video reliably and with high precision. Also compatible with Hi-vision signal and SXGA, UXGA signal can also be displayed in a compressed format.

## Compact, light-weight main unit

This projector is light-weight and compact so it is easy to carry around and set up.

## Large-screen display of up to about 300 inches

Can project picture sizes from about 20 inches to 300 inches.

## Up/down/left/right screen inversion function

The up/down/left/right screen inversion function allows forward or rear projection while mounted either on the floor or ceiling. (However, the document imaging camera model could not be mounted on the ceiling.)

## High sensitivity document imaging camera

The document imaging camera has a camera with a high sensitivity of 810,000 picture elements. It can directly project in high sensitivity any materials (documents, illustrations, etc.) without using an OHP film. (Only the document imaging camera model)

## 6 Languages on screen display





Can select a display language from 6 of English, Japanese, French, German, Spanish and Italian.

## Newly developed field converting IC

With a new developed field, converting IC, it can project pictures at the maximal projection size regardless of the signal types of VGA, SVGA, XGA, NTSC and PAL.

## POWER SUPPLY CORD SELECTION

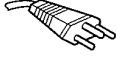
If your line voltage is 220 to 240V, use one of the following types of cable.

Plug Configuration	Plug Type	Line Voltage	Plug Configuration	Plug Type	Line Voltage
	EURO 240V 10 – 15A	220 – 240V		North American 240V 15A	200 – 240V
	UK 240V 6A	200 – 240V		Switzerland 240V 6A	200 – 240V
	Australian 240V 10A	200 – 240V			

# CONTENTS

<b>BEFORE USE</b>	<b>SAFETY PRECAUTIONS</b> .....	1	<b>BEFORE USE</b>
	<b>IMPORTANT PRECAUTIONS</b> .....	1	
	<b>IMPORTANT SAFETY INSTRUCTIONS</b> .....	2	
	<b>FEATURES</b> .....	7	
	<b>PARTS NAMES AND FUNCTIONS</b> .....	9	
	Body and Control Panel .....	9	
	Remote Control .....	11	
<b>CONNECTIONS</b>	<b>CONNECTIONS</b> .....	13	<b>CONNECTIONS</b>
	Connecting an IBM PC or Compatible Computer (DOS/V) .....	13	
	Connecting a Macintosh Computer .....	13	
	Connecting Video Equipment .....	14	
	Output Terminals .....	14	
<b>INSTALLATION</b>	<b>PROJECTOR PLACEMENT</b> .....	15	<b>INSTALLATION</b>
	Front Projecting Placement .....	15	
<b>OPERATIONS</b>	<b>PICTURE PROJECTION</b> .....	17	<b>OPERATIONS</b>
	Projecting a Picture .....	17	
	Turning Off the Power After Use .....	18	
	<b>RESIZE FUNCTION</b> .....	19	
	<b>MUTE FUNCTION / FREEZE FUNCTION / CALL FUNCTION</b> .....	21	
	<b>OPERATING THE COMPUTER BY THE REMOTE CONTROL</b> .....	22	
<b>ADJUSTMENTS</b>	<b>SELECTING THE DISPLAY LANGUAGE</b> .....	23	<b>ADJUSTMENTS</b>
	<b>PICTURE DETAIL ADJUSTMENTS</b> (Contrast/Brightness/Color/Tint/Sharpness) .....	24	
	<b>R, G, B, LEVEL ADJUSTMENTS</b> .....	25	
	<b>PROJECTION DETAIL ADJUSTMENTS</b> (Vertical shift/Horizontal shift/Phase/Clock frequency) .....	26	
	<b>PICTURE ORIENTATION SETTING</b> .....	27	
	<b>SETTING OSD (ON SCREEN DISPLAY) MUTE FUNCTION</b> .....	28	
	<b>SAVING THE ADJUSTMENTS</b> .....	29	
<b>CAMERA</b>	<b>PROJECTING IMAGES WITH THE DOCUMENT IMAGING CAMERA</b> .....	30	<b>CAMERA</b>
	Names and Functions of the Document Imaging Camera .....	30	
	Projecting Images with the Document Imaging Camera .....	31	
	<b>ADJUSTING THE DOCUMENT IMAGING CAMERA</b> .....	34	
	Adjusting the Exposure .....	34	
<b>MAINTENANCE</b>	<b>TROUBLE INDICATIONS</b> .....	35	<b>MAINTENANCE</b>
	<b>AIR FILTER, LENS, AND MAIN UNIT CLEANING</b> .....	36	
	<b>LAMP REPLACEMENT</b> .....	37	
	<b>FLUORESCENT LIGHT REPLACEMENT</b> .....	38	
<b>OTHERS</b>	<b>BEFORE CALLING SERVICE PERSONNEL</b> .....	39	<b>OTHERS</b>
	<b>INPUT SIGNAL</b> .....	41	
	Mode Determination and Signal System / Signal Assignment .....	41	
	RGB Signal Defaults .....	42	
	<b>ADJUSTMENTS WITH RS-232C</b> .....	43	
	<b>SPECIFICATIONS</b> .....	45	
	<b>LIMITED WARRANTY</b> .....	Back cover	

# PART NAMES AND FUNCTIONS

For detail, use the page inside the  mark next to the name.

## Body and control panel

### Control panel

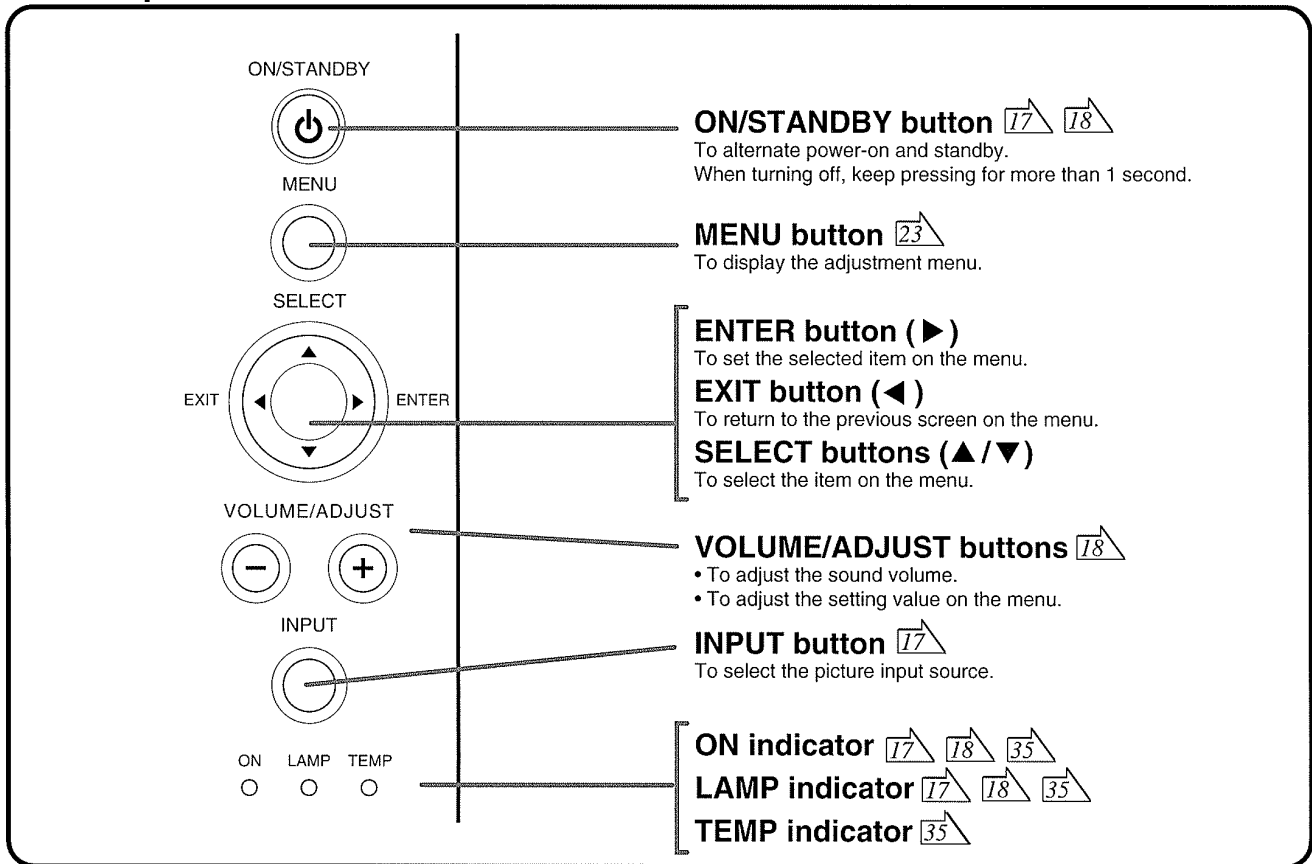

### Lens cap

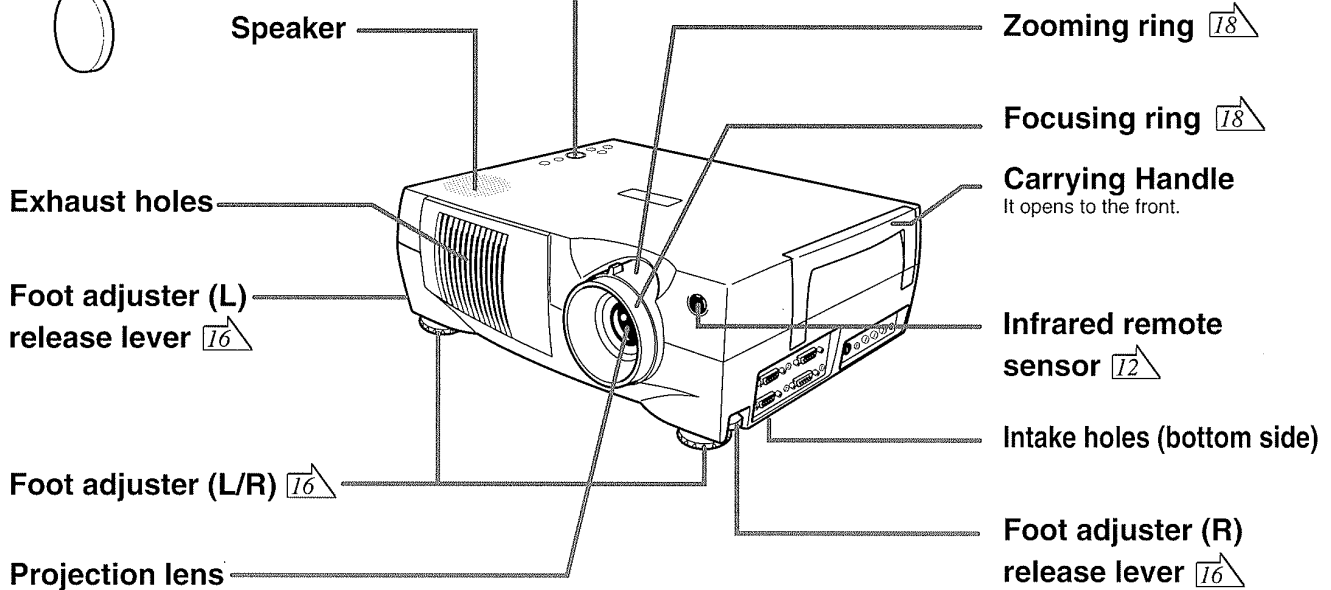

**Left side**

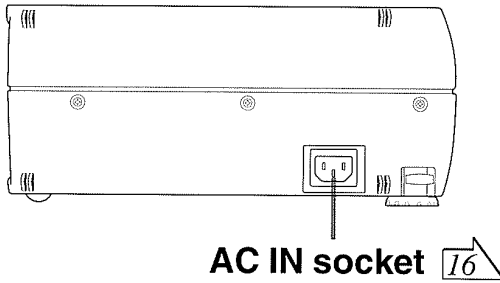

**Right side**

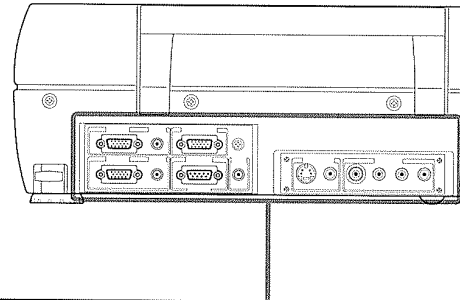

**RGB1 IN connector** I3  
To connect a computer, etc.

**MONITOR OUT connector** I4  
To connect a monitor.

**CONTROL (RS-232C) connector** I4 43  
To connect a computer to control the projector.

**RGB2 IN connector** I3  
To connect a computer, etc.

**AUDIO OUT jack** I4  
To connect audio equipment.

**VIDEO1 IN jacks** I4  
(S-Video input, Audio input)  
To connect a video tape player, etc.

**VIDEO2 IN jacks** I3  
(Video input/Color difference video input, Audio input)  
To connect a video tape player, etc.

**Rear side**

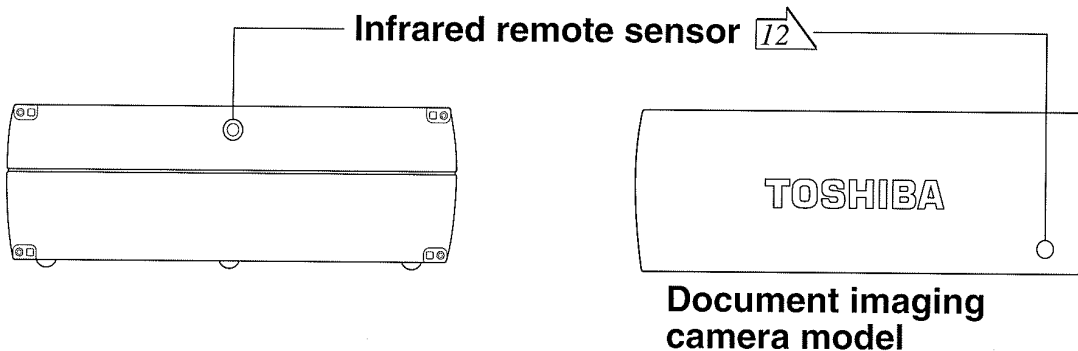

# PART NAMES AND FUNCTIONS (CONTINUED)

This instruction uses remote control. For details, see the page inside the  mark next to the name.

## Remote Control

### CALL button

To display the current input source and signal status information.

### DIRECT INPUT buttons

(RGB1, RGB2, VIDEO1, VIDEO2, CAMERA buttons)  
To select directly the picture input source. (CAMERA button works only with document imaging camera model.)

### MUTE button

To cut off the picture and sound output temporarily.

### MOUSE button (right)

To operate a computer.  
(Needs to connect the infrared remote sensor unit (supplied) to the computer.)



### FREEZE button

To freeze the picture.

### RESIZE buttons

To switch the picture size.

### VOLUME/ADJUST

buttons    
To adjust the sound volume, to adjust the setting.

### ▲, ▼, EXIT/◀, ENTER/▶ buttons

(FOCUS▲, FOCUS▼, ZOOM T, ZOOM W buttons)

- To select the items (▲, ▼ buttons) to set (ENTER button), to return to previous screen (EXIT button) on the menu.
- When increasing the picture size or changing to through size by using the RESIZE button, moves the location picture of the projected picture (▲, ▼, ◀, ▶ buttons).
- If the input source is camera and the menu screen is not displayed or the picture size is not changed, the focus adjustment (FOCUS▲, FOCUS▼ buttons) or the zoom adjustment (ZOOM T, ZOOM W buttons) of the camera can be executed. (FOCUS▲, FOCUS▼, ZOOM T, ZOOM W function is available with document imaging camera model only.)

Caution – use of controls or adjustments or performance of procedures other than those specified herein may result in hazardous radiation exposure.

### Laser emission part

### ON/STANDBY button

To alternate power-on and standby. When turning off, keep pressing for more than 1 second.

### LASER button

To display the laser pointer by pointing the laser emission part toward the screen.

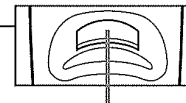

### REAR SIDE

### MOUSE button (left)

To operate a computer.  
(Needs to connect the infrared remote sensor unit (supplied) to the computer.)

### POINTER CONTROL

To operate a computer.  
(Needs to connect the infrared remote sensor unit (supplied) to the computer.)

### MENU button

To display the adjustment menu.

### RESET button

The setting values are reset to the initial values.

### Location of the labels

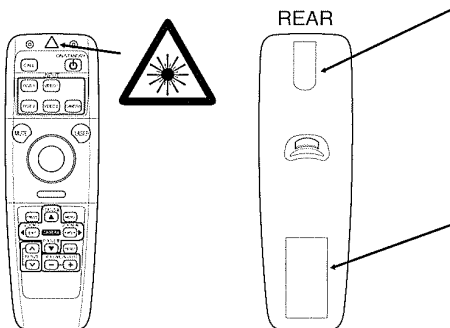

**AVOID EXPOSURE-LASER**  
RADIATION IS EMITTED  
FROM THIS APERTURE

 <p><b>CAUTION</b> LASER RADIATION DO NOT STARE INTO BEAM WAVE LENGTH : 645nm MAX OUTPUT : 1mW CLASS II LASER PRODUCT</p>	<p>RAYONNEMENT LASER NE PAS REGARDER DANS LE FAISCEAU APPAREIL A LASER DE CLASSE 2 LONGUEUR D'ONDE: 645nm PUISSANCE MAXIMA: 1mW</p>
	<p>LASER-STRAHLUNG NIGHT IN DEN STRAHL BLICKEN LASER KLASS 2 WELLENLÄNGE: 645nm MAX AUSGANGSLEISTUNG: 1mW</p>
<p>COMPLIES WITH DHHS 21 CFR SUBCHAPTER J TOSHIBA AMERICA CONSUMER PRODUCTS, INC. 82 TOTOWA RD., WAYNE, NJ 07470, U.S.A.</p>	
<p>REMOTE CONTROL MODEL CT-9971 MADE IN JAPAN</p>	

## Installing Batteries

Install batteries to enable remote control operation.

### 1 Open the cover.

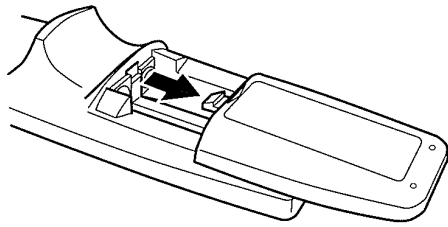

### 2 Install the batteries.

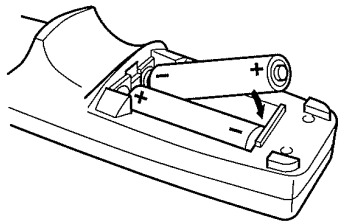

Make sure that the +/- polarities match the illustration in the compartment.

### 3 Attach the cover.

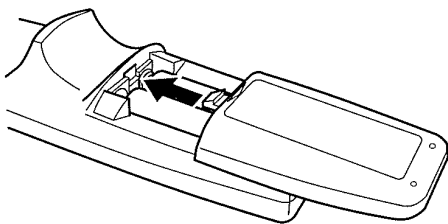

#### Batteries

Using batteries incorrectly can cause them to leak or burst. Strictly observe the following.

- Install the batteries with their + and - ends facing correctly.
- Do not charge, heat, disassemble, or short the batteries or throw them into a fire.
- Do not leave exhausted batteries in the remote control.
- Do not mix different types or batteries or new and old batteries.
- When you will not be using the remote control for a prolonged period, take the batteries out of the remote control.
- When the remote control stops working or only works from very close distance, replace all the batteries with new ones.
- When replacing the batteries, use a more longer life alkaline batteries.
- If a battery leaks, carefully wipe off any residue inside the battery case before loading new batteries.

## Remote Control Operation

Instruction to use the remote control.

### 1 Face the infrared sensor and press a remote control button.

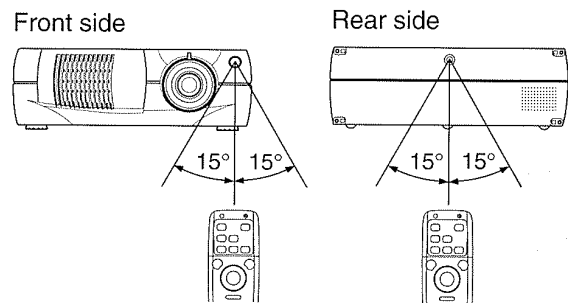

Rear side of the Document imaging camera model

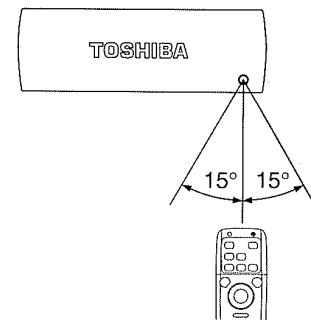

Distance : within about 5 meters from the front of the remote sensor.

Angle : within about 15° of the remote sensor in every direction.

- The remote control may not operate when there is sunlight or other strong light such as a fluorescent lamp shining on the remote sensor.

#### Remote Control

- Keep strong light off the remote sensor.
- Operate the remote control from a position where the remote sensor is visible.
- Do not drop the remote control or otherwise jolt it.
- Keep the remote control out of locations with excessively high temperature or humidity.
- Do not get water on the remote control or place wet objects on it.
- Do not disassemble the remote control.
- Under unusual circumstances the remote control may not operate well due to the location being used or the surroundings. At such times, turn the remote control sensor face to the projector unit again and retry the remote control operation.

BEFORE USE

# CONNECTIONS

Pictures can be imported from connected equipment such as a computer or a video tape player.

## Connecting an IBM PC or Compatible Computer (DOS/V)

Check that the power for the projector and computer are off before connecting the cables.

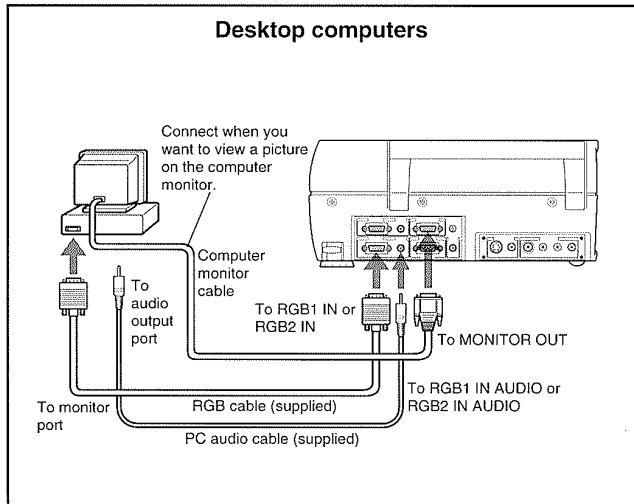

## Connecting a Macintosh Computer

- Attach the supplied adapter for Macintosh computers.
- Check that the power for the projector and computer are off before connecting the cables.

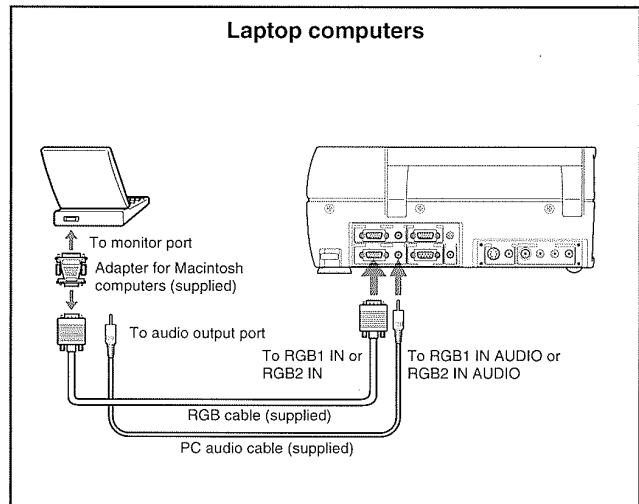
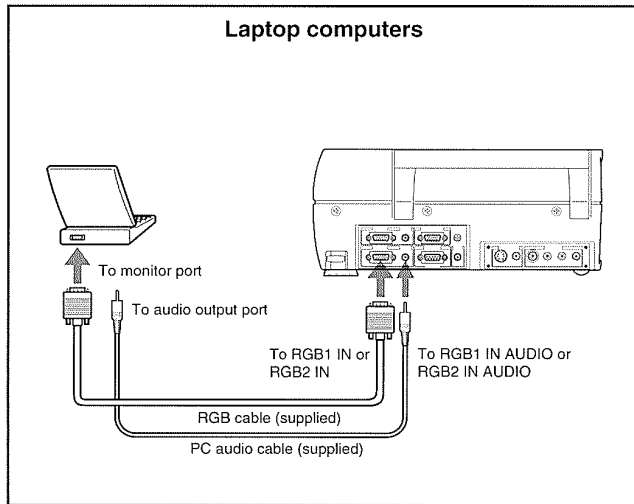
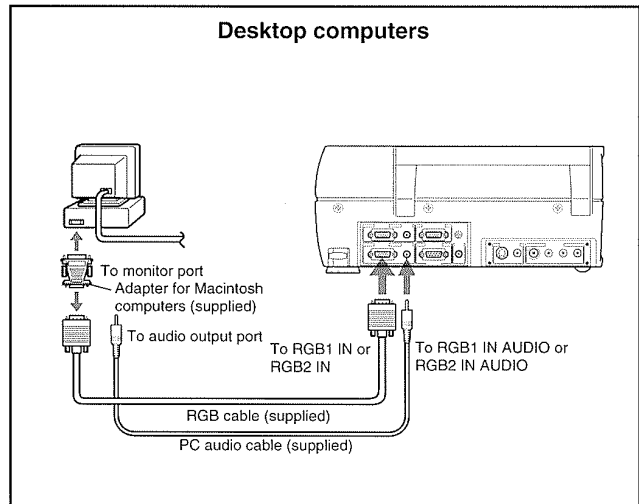

### Notes

- The projector cannot be connected to a computer that does not have an analog RGB output terminal. For details, refer to the computer manual.
- You may not be able to connect some computers to the projector. For details, consult the dealer.
- If NTSC/PAL/SECAM signals are input to the RGB1 INPUT connector or RGB2 INPUT connector, they cannot be displayed. (Input NTSC/PAL/SECAM signals to the VIDEO1 INPUT jacks or VIDEO2 INPUT jacks.)

### Notes

- The projector cannot be connected to a computer that does not have an analog RGB output terminal. For details, refer to the computer manual.
- You may not be able to connect some computers to the projector. For details, consult the dealer.
- The adapter for Macintosh computers is conformable to MULTIPLE SCAN 21.

## Connecting Video Equipment

Check that the power for the projector and computer are off before connecting the cables.

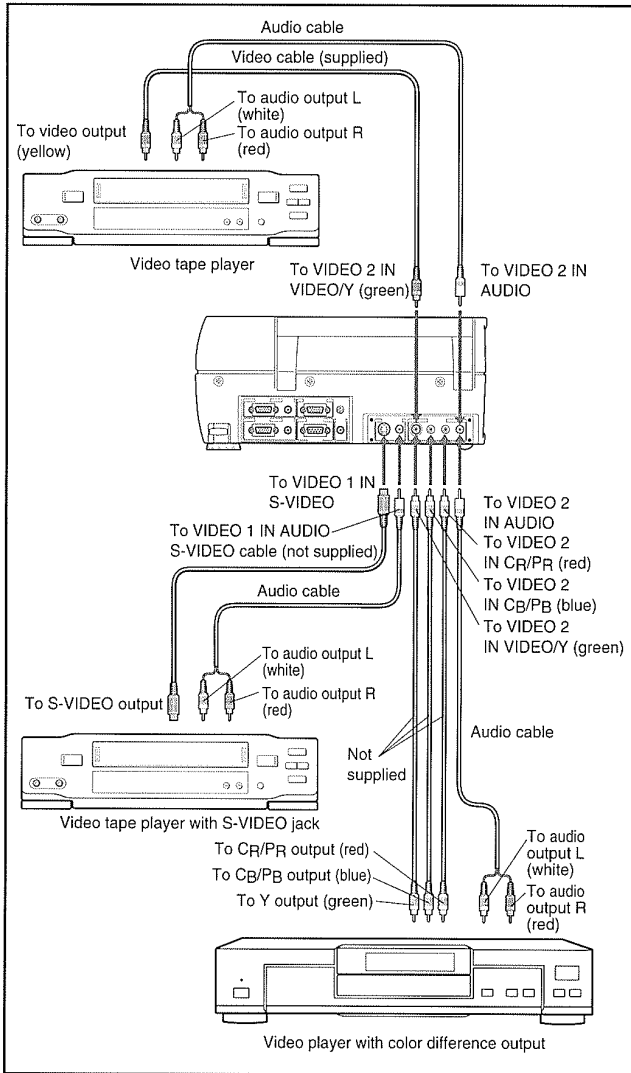

**Note**

One set of audio cable (stereo mini plug, pin plug x 2) is supplied.

## Output Terminals

Check that the power for the projector and computer are off before connecting the cables.

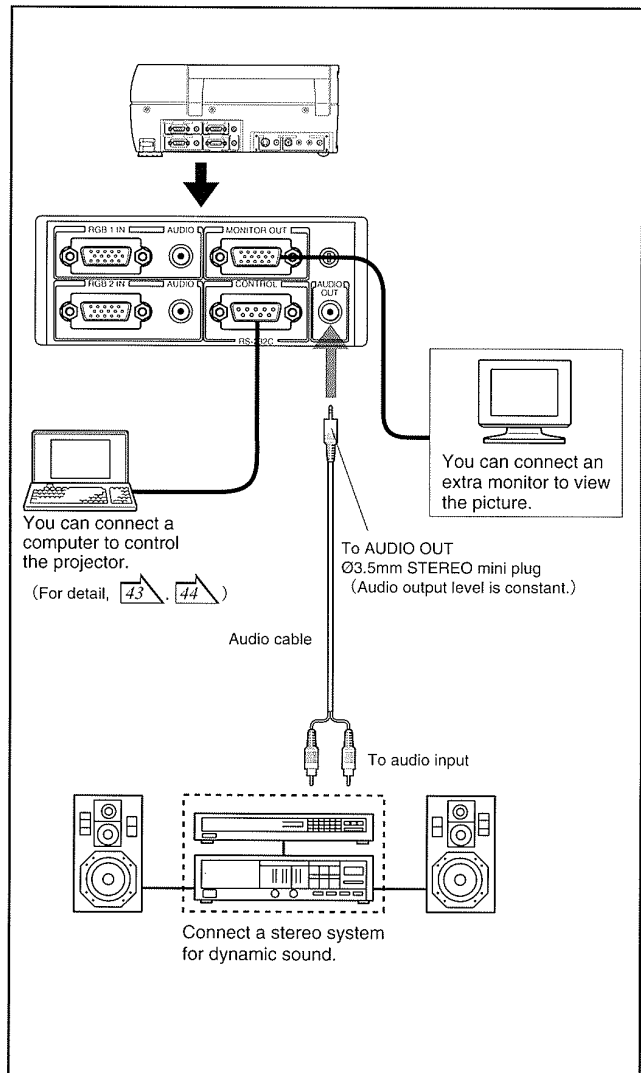

**Notes**

- The sound of the source selected with the INPUT button or DIRECT INPUT buttons is the output to the stereo system, etc.
- The MONITOR OUT connector send out the signal (RGB1 or RGB2) that was selected with the INPUT button or DIRECT INPUT buttons. If other signal than RGB1 or RGB2 is selected, the output will be the last source selected before the change.
- On Standby mode, the last selected input signal will be send from the MONITOR OUT.



# PROJECTOR PLACEMENT

**CAUTION**  
When carrying the unit always handle the carrying handle.

Following are placement guidelines for standard front projection usage.

## Front Projecting Placement

- Select a room that can be darkened.
- Refer to the table below for the screen size and required distance.

### 1 Place the projector on a steady, level surface such as a table.

Point the projector squarely at the screen for the best possible picture.

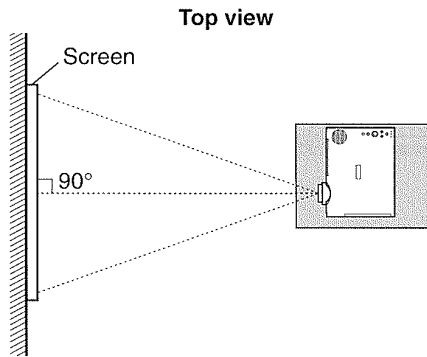

Point the lens straight at the center of the screen as above.

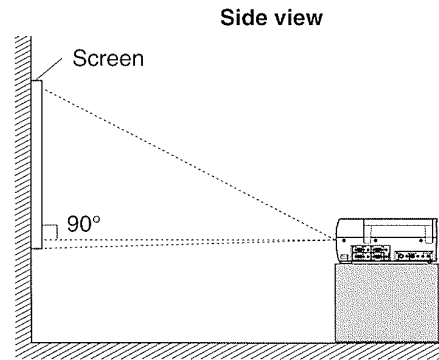

Place the projector horizontally so that the projecting light hits the screen squarely.

### 2 Adjust the distance between the lens and the screen.

The projection size depends on the distance between the lens and the screen. Adjust the projection size by changing the distances as shown below.

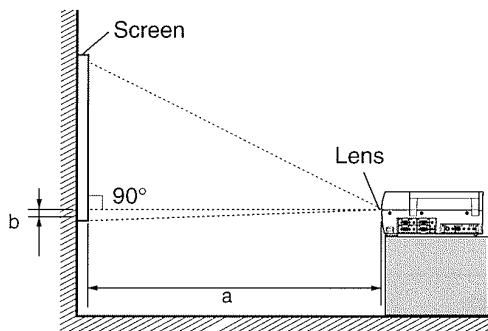

a: Distance between the lens and the screen.  
b: Distance between the lens height and the bottom of the screen.

\* The value in the list below are approximations.

Screen size (inches)	Distance between the lens and the screen: a (m)		Distance between the lens height and the bottom of the screen: b (cm)
	Minimum (WIDE)	Maximum (TELE)	
22	0.74	1.04	1.8
40	1.41	1.95	3.4
60	2.15	2.96	5.1
80	2.88	3.97	6.8
100	3.62	4.98	8.5
150	5.47	7.51	12.7
200	7.32	10.03	16.9
300	11.02	15.09	25.4

#### Note

When the projector is moved from a cold location to a warm location, or when the ambient temperature in the projection room has risen suddenly, moisture may condense on the lens or the mirror to blur the projected pictures. In such a case, leave the projector for an adequate time (1 to 2 hours, depending on the room's condition) before using it so it adjusts to the ambient temperature.

### 3 Connect the power cord.

- Insert one end in the AC IN socket on the rear panel.
- Insert the other end in a wall outlet.

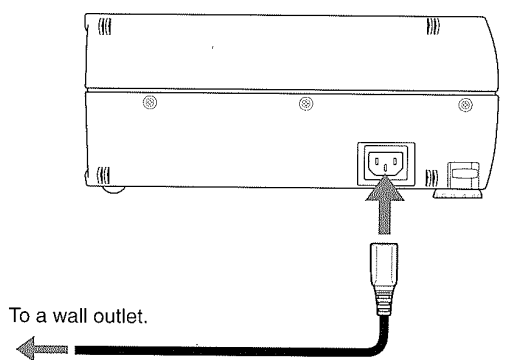

ON indicator (orange) lights and turn to standby mode.

### 4 Take off the lens cover.

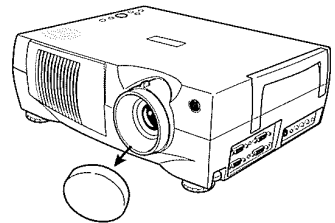

### How to use the foot adjusters

The tilt of the projector can be adjusted using the foot adjusters.

- 1 Lift the front of the projector until a tilt angle desired is obtained and pull up the foot adjuster release lever.**

Foot adjuster will stretch.  
Release the lever to lock in position.

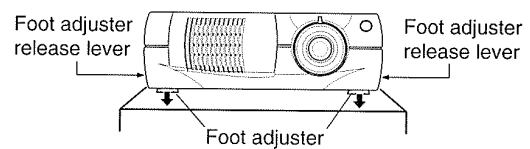

Side view

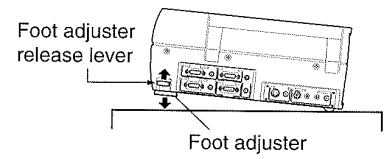

- 2 Turn the foot adjuster to make fine adjustment of the height.**

Turn clockwise to lift up.  
Turn counterclockwise to lower.

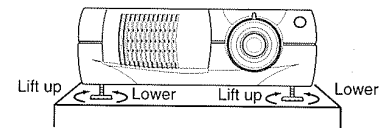

- 3 To put the foot adjuster back, hold down the foot adjuster release lever and lower the front slowly.**

The foot adjuster will put back.

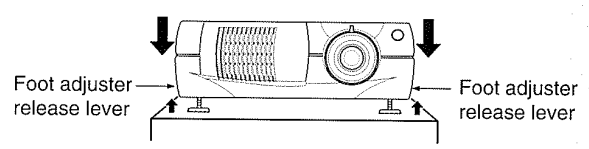

#### Notes

- To not pinch your fingers, when pulling up the foot adjuster release lever, always hold both sides of the unit.
- If the screen is exposed to direct sunlight or other strong light, the projected picture becomes too faint to see. Shut out the light with curtains or other means.
- If the screen and the projector are not installed properly the projected picture may be distorted.
- If the projector is tilted, the picture may be distorted. To obtain the best possible picture, place the projector so it faces the screen squarely.

# PICTURE PROJECTION

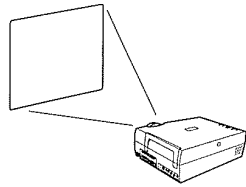

Explains the basic procedure for projecting a picture.

**CAUTION**

Do not look into the projection lens while operating the projector.

## Projecting a Picture

- Install and connect the projector properly.
- Take off the lens cover.

**1** **ON/STANDBY** **Press ON/STANDBY.**

Both ON and LAMP indications light up in green, and the projector is ready to project a picture.

ON	LAMP
●	☀
On	Flashing
(Green)	(Green)

↓

ON	LAMP
●	●
On	On
(Green)	(Green)

**2** **Turn on the connected equipment and put it in playback mode.**

Turn on the computer or video tape player connected with the projector and put it in playback mode.

**3** **(Using the remote control) Press the DIRECT INPUT button (RGB1, RGB2, VIDEO1, VIDEO2, CAMERA) of the remote control to select the input source.**

The picture changes directly to the selected input.

- The CAMERA button works only with document imaging camera model.

**(Using the control panel of the unit)**

**1 Press the INPUT button of the unit.**

Input menu appears on the screen.

"Camera" is displayed only on the document imaging camera model.

RGB1

RGB2

Video1

Video2

Camera

**2 Press the INPUT button of the unit to select the input source.**

The input source is switched each time you press the button. After selecting, the picture mutes for approximately 1 second and the picture changes to the selected input source.

RGB1

RGB2

Video1

Video2

Camera (document imaging camera model only)

RGB1: To project pictures from a computer connected to RGB1. 13

RGB2: To project pictures from a computer connected to RGB2. 13

Video1: To project pictures from a video player connected to VIDEO1. 14

Video2: To project pictures from a video player connected to VIDEO2. 14

**CAMERA:** To project pictures from a document imaging camera. 33

**Notes**

- "No Signal" is displayed on the screen if the projector does not receive any signal from the connected equipment. Put the equipment in playback mode.
- Due to the lamp characteristic, flickers may occasionally occur in a picture. This is not malfunction of the unit.
- You can select and input by using ▲/▼ button on the menu screen. In that case, if you select by using the ENTER button, the picture changes to the selected input source.
- Tie the lens cover to the body with a string so as not to lose it.

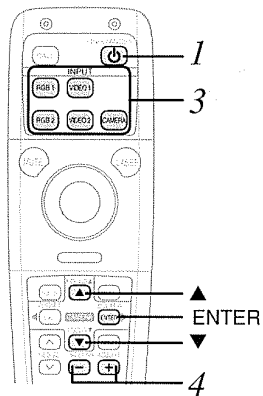
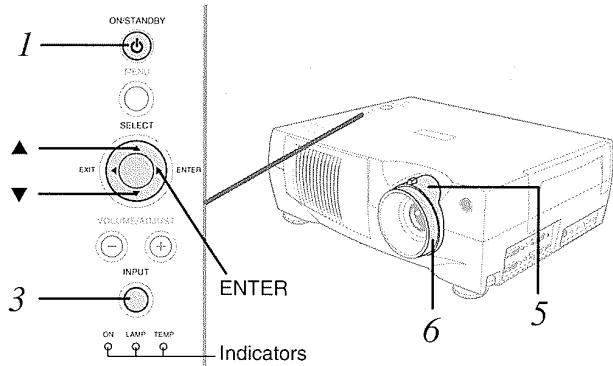

## Turning Off the Power After Use

Following are guidelines for turning off the power.

**4** **VOLUME/ADJUST** **Press VOLUME/ADJUST to set the sound volume.**

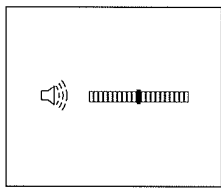

+ : To turn up the volume.  
- : To turn down the volume.

**5** **Adjust the picture size by turning the zooming ring.**

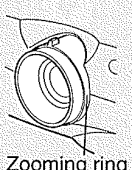

Turn to the right to enlarge the picture.  
Turn to the left to reduce the picture.

**6** **Focus on the picture by turning the focusing ring.**

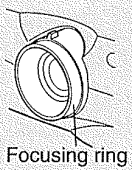

A still picture is recommended for focusing.

**1** **ON/STANDBY** **Press ON/STANDBY for more than 1 second after using the projector.**

The LAMP indicator will turn off, and the projector is now in STANDBY mode.

ON	LAMP
○	☀
On	Flashing
(Orange)	(Green)
↓	
ON	LAMP
○	○
On	Off
(Orange)	

**2** **After confirming the exhaust fan stops, unplug the power cord.**

The ON indicator turns off.

ON
○
Off

OPERATIONS

### Notes

- When the input source is selected to RGB1 or RGB2 and if no signal is sent from the computer, it enters to power-save mode after 30 minutes and turns to stand-by mode. It automatically turn on when the signal is sent again. The power can be turned on if the ON/STANDBY button is pressed.
- When operating the projector " " can be displayed on the screen. This means that the operation can not be completed.

### Notes

- Before unplugging the power cord, make sure that the fans are stopped.
- When the ON/STANDBY button is pressed after use, the intake and exhaust fans continue to work for about 3 minutes more to cool the inside of the projector.
- Immediately after the power off, the projector may not be turned on while the LAMP indicator is flashing in green.

# RESIZE FUNCTION

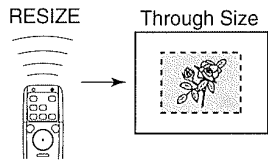

You may change the size of the picture.

## Changing the Picture Size

Pictures are projected at the maximal projection size regardless of the signal types. Optionally you can change the picture size to through size or enlarge it.

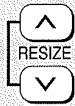

### Press RESIZE (^) or (v).

The picture size changes from the center of the picture.

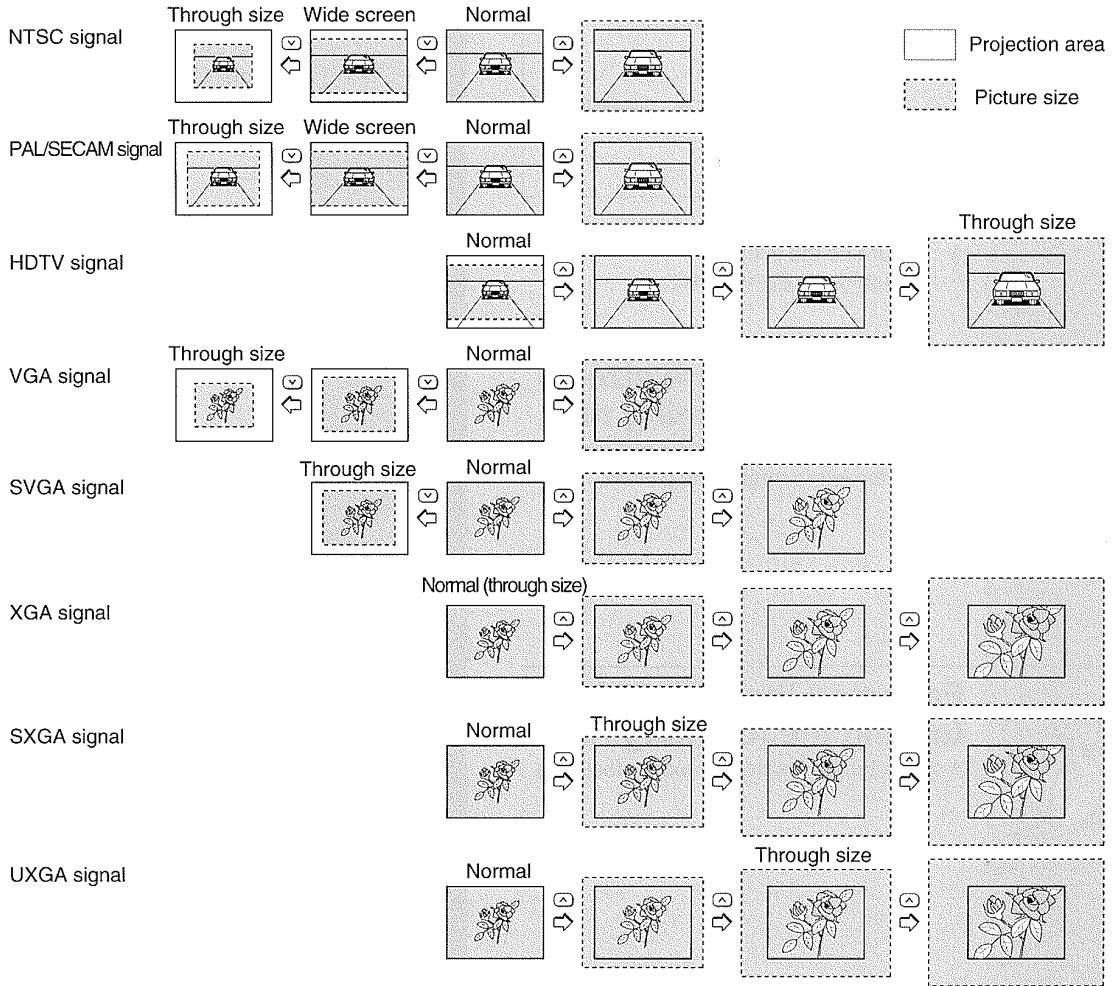

The picture changes to the smallest size when the RESIZE (^) button is pressed with the biggest size selected. The picture changes to the biggest size when the RESIZE (v) button is pressed with the smallest size selected.

### Notes

- Picture size returns to normal after the power is turned off. The values are not saved.
- You may not change the picture size depending to the signal.
- Pictures of VGA and SVGA signals may be slightly inferior in quality at the initial size because they are enlarged.

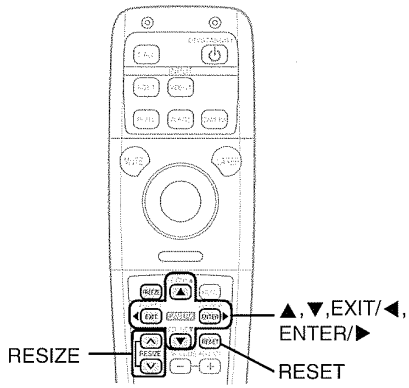

- When the picture size is smaller than the projection area, the picture can be moved inch by inch in up, down, left, right direction by pressing the ▲, ▼, EXIT/◀, ENTER/▶ buttons.

Example

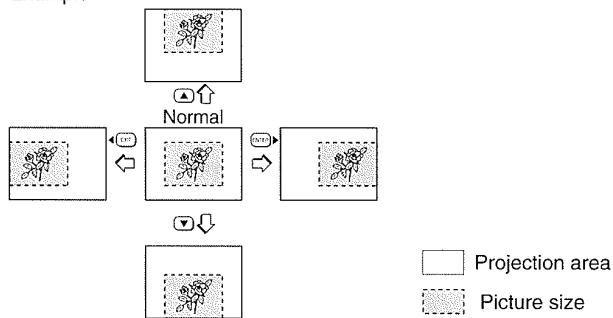

- When the picture size is bigger than the projection area, the projected picture can be moved inch by inch in up, down, left, right direction by pressing the ▲, ▼, EXIT/◀, ENTER/▶ buttons.

Example

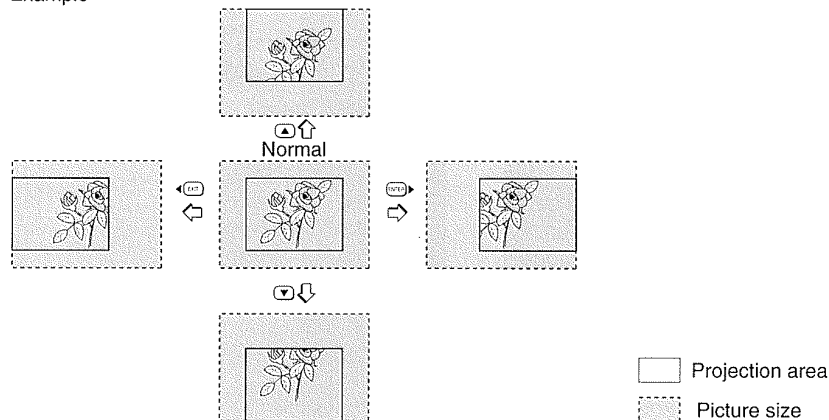

Notes

- The picture returns to the normal position when the RESET button is pressed after the picture is moved.
- The picture may not be projected properly while moving the picture.

# MUTE FUNCTION / FREEZE FUNCTION / CALL FUNCTION

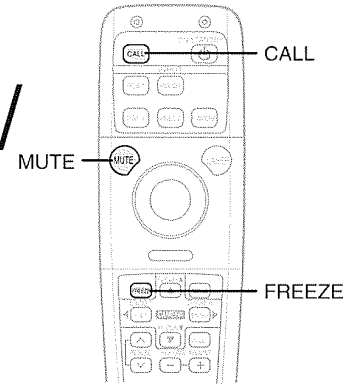
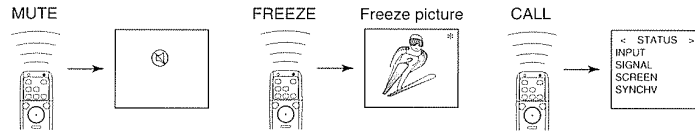



Cutting off the picture and sound temporarily and displaying the current input source information.

## Cutting Off the Picture and Sound Temporarily

Cut off the picture and sound temporarily.

- 1 Press MUTE.**

The sound is cut off temporarily.
- 2 Press MUTE again.**

The picture is also cut off temporarily. To restore, press the MUTE button again.

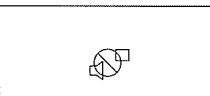
**Note**

If you press the MUTE button while the adjustment menu is displayed, the menu disappears and cancels the adjustment mode.

## Freezing the Picture

You can freeze the picture.

**Press FREEZE.**

The picture freezes. To cancel the freeze mode, press the FREEZE button again. When the picture freezes, " \* " mark will be shown on the up right corner of the screen. When making other operations, freeze mode will be cancelled.

**Note**

This function is convenient for the case where you are using the document imaging camera model and change documents to project through the camera.

## Displaying the Input Source Information

Displaying the current input source information.



### Press CALL.

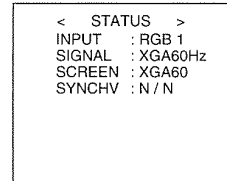

The current input source signal information is displayed. To close the display, press the CALL button again.

#### Contents of displayed items

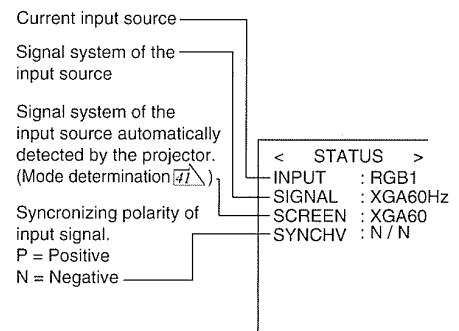

**Notes**

- The display automatically disappears after about 10 seconds.
- If you press the CALL button while the adjustment or setting menu is displayed, the menu disappears and cancels the adjustment mode.

# OPERATING THE COMPUTER BY THE REMOTE CONTROL

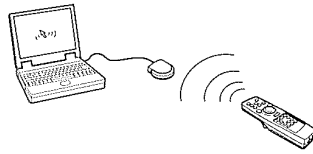

If you connect the infrared remote sensor unit to the computer, the supplied remote control can work as a mouse of the computer.

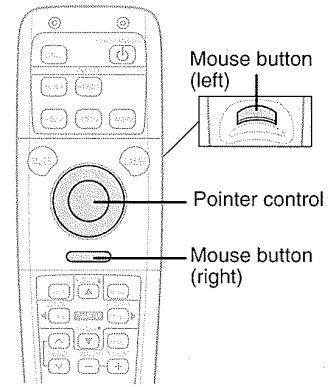

## Connecting the Infrared Remote Sensor Unit

Check that the power of the computer is turned off.

Connect the infrared remote sensor unit.

- Remove the mouse actually used and change it to the supplied cable.

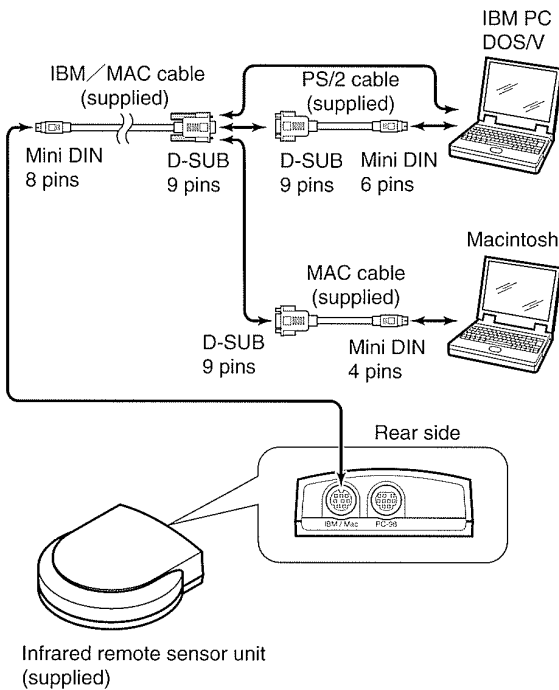

## Operating the Computer by the Remote Control

Press the remote control button facing to the infrared remote sensor unit.

### To move the pointer



#### Press the pointer control.

The pointer moves to the pressed direction.

Example

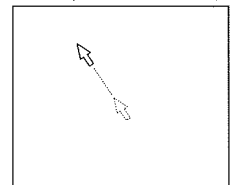

### To click



#### Press the mouse button (left).

The pointer clicks.

### To right-click



#### Press the mouse button (right).

The pointer right-clicks.

### Notes

- To operate the projector and the computer by the remote control, place the infrared remote sensor unit close to the projector.
- If the mouse used is PS/2 type, connect a PS/2 cable, or if the mouse is a serial mouse, directly connect an IBM/MAC cable.

### Notes

- The remote control operating range is about 5 meter from the front of the remote sensor.
- The remote control may not operate when there is sunlight or other strong light such as a fluorescent lamp shining on the remote sensor.



# SELECTING THE DISPLAY LANGUAGE



You can select the display language.  
This owner's manual explains using an instance where English is selected.

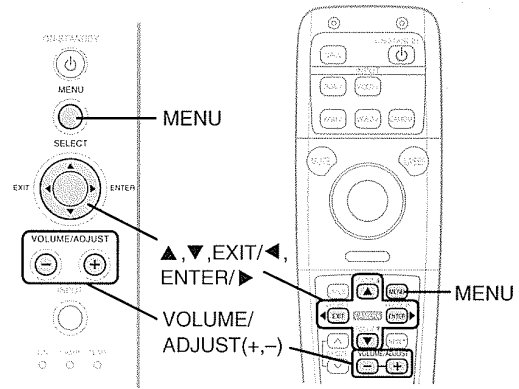

## Selecting the Display Language

Display the image as explained in "PICTURE PROJECTION".

<b>1</b>		<p><b>Press MENU.</b> The menu is displayed. It automatically disappears after about 30 seconds if no button is pressed.</p>	Video1 Video2 Panel Mode Language Save
<b>2</b>	 	<p><b>Press ▲ or ▼ to select "Language".</b></p>	Video1 Video2 Panel Mode Language Save
<b>3</b>		<p><b>Press ENTER/▶.</b> The setting menu of "Language" is displayed.</p>	English * 日本語 Français Deutsch Español Italiano

<b>4</b>	 	<p><b>Press ▲ or ▼ to select a preferred language.</b>  Example : When selecting English</p>	English * 日本語 Français Deutsch Español Italiano
<b>5</b>	VOLUME/ADJUST 	<p><b>Press VOLUME/ADJUST (+).</b> The menu is displayed in the selected language.</p>	English * 日本語 Français Deutsch Español Italiano
<b>6</b>		<p><b>Press EXIT/◀.</b> The menu returns.</p> <ul style="list-style-type: none"> <li>This setting is stored until you turn the power off.</li> </ul>	
<b>7</b>		<p><b>Press EXIT/◀.</b> The menu disappears.</p>	

**Notes**

- If you want to store the setting even if the power is turned off, select "Save".
- If you press the RESET button when this setting menu is displayed, the setting returns to default (English).

# PICTURE DETAIL ADJUSTMENTS

## Adjustment items

Contrast.....	Contrast
Bright.....	Brightness
Color.....	Color
Tint.....	Tint
Sharp.....	Sharpness

Explains how to adjust the projected picture quality.

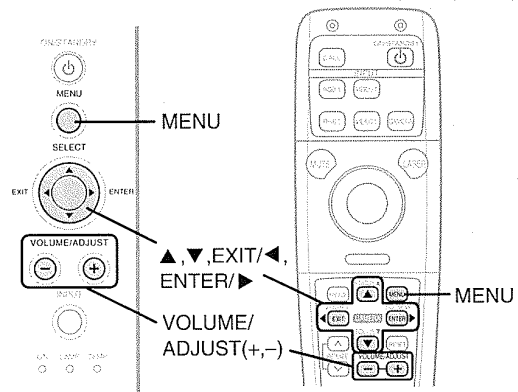

## Adjusting the Picture Details

- Display the image as explained in "PICTURE PROJECTION". [17](#)
- Select the input source to adjust.

**1** **Press MENU.**  
The menu is displayed. It automatically disappears after about 30 seconds if no button is pressed.

Video1  
Video2  
Panel  
Mode  
Language  
Save

**2** **Press ▲ or ▼ to select "Video1".**

Video1  
Video2  
Panel  
Mode  
Language  
Save

**3** **Press ENTER/▶.**  
The adjusting menu of "Video1" is displayed.

Contrast	■■■■■■■■■■
Bright	■■■■■■■■■■
Color	■■■■■■■■■■
Tint	■■■■■■■■■■
Sharp.	■■■■■■■■■■

**4** **Press ▲ or ▼ to select a preferred item.**

**5** **Press VOLUME/ADJUST (+, -) to adjust the item.**  
Example: Adjusting the Contrast to + position

Contrast	■■■■■■■■■■
Bright	■■■■■■■■■■
Color	■■■■■■■■■■
Tint	■■■■■■■■■■
Sharp.	■■■■■■■■■■

	-	+
Contrast	Lower	Higher
Bright	Darker	Brighter
Color	Duller	Brighter
Tint	Redder	Greener
Sharp.	Softer	Sharper

- If you want to adjust an other item, press ▲ or ▼ to select an adjusting item and adjust it by pressing VOLUME/ADJUST (+, -).

**6** **Press EXIT/◀.**  
The menu returns.

- This adjustments are stored until you turn the power off.

**7** **Press EXIT/◀.**  
The menu disappears.

ADJUSTMENTS

### Notes

- Tint adjustment is not available for PAL nor SECAM signals.
- Color, Tint and Sharp. adjustments are not possible when RGB input is selected.
- If you want to store the adjustments even if the power is turned off, select "Save". [29](#)
- The adjustment can be stored on each INPUT source (RGB1, RGB2, Video1, Video2, Camera.)
- If you press the RESET button when this adjusting menu is displayed, all the adjusting items of "Video1" returns to default.

# R, G, B LEVEL ADJUSTMENTS

Adjustment items

- R-Level ..... Red level
- G-Level ..... Green level
- B-Level ..... Blue level

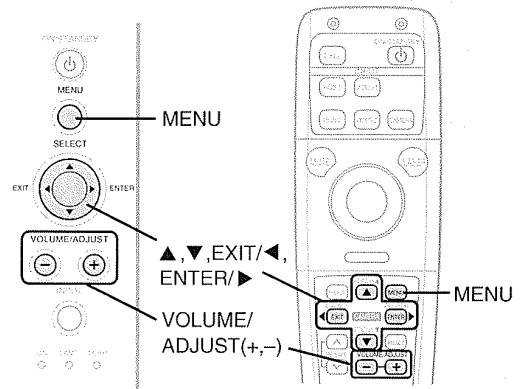

## Adjusting R, G, B Level

- Display the image as explained in "PICTURE PROJECTION".
- Select the input source to adjust.

**1** **Press MENU.**  
The menu is displayed.  
It automatically disappears after about 30 seconds if no button is pressed.

Video1  
**Video2**  
 Panel  
 Mode  
 Language  
 Save

**2** **Press ▲ or ▼ to select "Video2".**

Video1  
**Video2**  
 Panel  
 Mode  
 Language  
 Save

**3** **Press ENTER/▶.**  
The adjusting menu of "Video2" is displayed.

R-Level   
 G-Level   
 B-Level

**4** **Press ▲ or ▼ to select a preferred item.**

**5** **Press VOLUME/ADJUST (+, -) to adjust the item.**  
Example: Adjusting the R-Level to + position

R-Level   
 G-Level   
 B-Level

	-	+
R-Level	Red level Lower	Red level Higher
G-Level	Green level Lower	Green level Higher
B-Level	Blue level Lower	Blue level Higher

- If you want to adjust an other item, press ▲ or ▼ to select an adjusting item and adjust it by pressing VOLUME/ADJUST (+, -).

**6** **Press EXIT/◀.**  
The menu returns.  
• This adjustments are stored until you turn the power off.

**7** **Press EXIT/◀.**  
The menu disappears.

**Notes**

- If you want to store the adjustments even if the power is turned off, select "Save".
- Each input source (RGB1, RGB2, Video1, Video2, Camera) adjustment can be saved.
- If you press the RESET button when this adjusting menu is displayed, all the adjusting items of "Video2" returns to default.

# PROJECTION DETAIL ADJUSTMENTS

Adjustment items	
V-pos. ....	Vertical shift
H-pos. ....	Horizontal shift
Phase .....	Phase
Clock .....	Clock frequency

Explains how to adjust the projection details.  
 The projector identifies the model of the input source automatically and adjusts the projection details appropriately. If the picture still flickers or is blurred or losing the positional balance beyond the adjustment, this procedure is required.

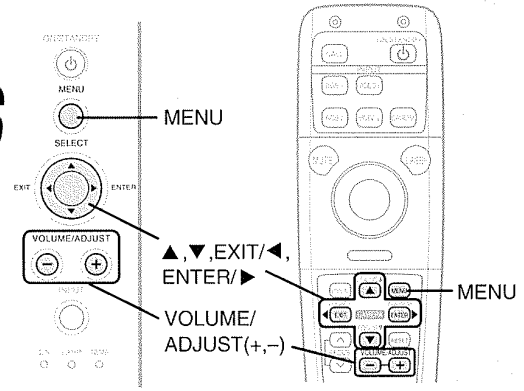

## Adjusting the Projection Details

- Display the image as explained in "PICTURE PROJECTION". 17
- Select the input source to adjust.

**1** **Press MENU.**  
 The menu is displayed.  
 It automatically disappears after about 30 seconds if no button is pressed.

Video1
Video2
Panel
Mode
Language
Save

**2** **Press ▲ or ▼ to select "Panel".**

Video1
Video2
Panel
Mode
Language
Save

**3** **Press ENTER/▶.**  
 The adjusting menu of "Panel" is displayed.

V-pos.	
H-pos.	
Phase	
Clock	

**4** **Press ▲ or ▼ to select a preferred item.**

**5** **Press VOLUME/ADJUST (+, -) to adjust the item.**  
 Example: Adjusting the V-pos. to + position

V-pos.	
H-pos.	
Phase	
Clock	

V-pos. To shift the picture down (-), to up (+).  
 H-pos. To shift the picture to the left (-), to the right (+).  
 Phase To reduce flickers.  
 Clock To remove vertical stripes.

**6** **Press EXIT/◀.**  
 The menu returns.  
 • This adjustments are stored until you turn the power off.

**7** **Press EXIT/◀.**  
 The menu disappears.

ADJUSTMENTS

**Notes**

- If you project a picture from a computer with an LCD screen while monitoring the picture on the computer, the picture may not be projected properly, depending on the computer model. In this case, turn off the computer display, or make the necessary picture adjustments on the projector. For details on controlling the computer display, etc. refer to the computer's manual and description on the software for the computer used.
- When adjusting V-pos. and H-pos. values, the picture may not be projected properly.
- While using, an aberration of the phase may occur. In that case, make the Phase adjustment again.
- If you want to store the adjustments even if the power is turned off, select "Save". 29
- If you press the RESET button when this adjusting menu is displayed, all the adjusting items of "Panel" returns to default.

# PICTURE ORIENTATION SETTING

**CAUTION**

- When a ceiling mount is required, please consult with the dealer. (Always use the specially designed ceiling fixture “TLPTK5” (for high ceiling) or “TLPTK6” (for low ceiling).) For more details, refer to the instruction manual attached to the ceiling fixture.
- If you use the projector mounted on the ceiling, ask the dealer to clean the filter and replace the lamp, etc. for your own safety.

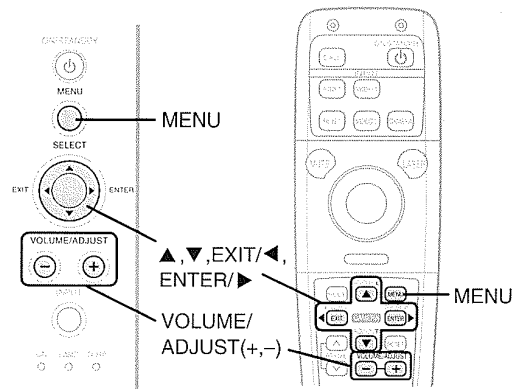

By inverting the picture, various projector installations are possible to meet the room conditions.

## Setting the Picture Orientation

Display the image as explained in “PICTURE PROJECTION”.

Location of the screen and projector	Setting
<p><b>Floor-mounted front projection</b></p> <p>Viewing a picture projected on the front of the screen from a floor.</p>	Rear Off Ceiling Off
<p><b>Floor-mounted rear projection</b></p> <p>Viewing a picture projected through the back of the screen from a floor installation.</p>	Rear On Ceiling Off
<p><b>Ceiling-mounted front projection</b></p> <p>The document imaging camera model could not be mounted on the ceiling.</p> <p>Viewing a picture projected on the front of the screen from a ceiling installation.</p>	Rear Off Ceiling On
<p><b>Ceiling-mounted rear projection</b></p> <p>The document imaging camera model could not be mounted on the ceiling.</p> <p>Viewing a picture projected through the back of the screen from a ceiling installation.</p>	Rear On Ceiling On

**1** **Press MENU.**  
The menu is displayed.  
It automatically disappears after about 30 seconds if no button is pressed.

**2** **Press ▲ or ▼ to select “Mode”.**

---

**3** **Press ENTER/▶.**  
The setting menu of “Mode” is displayed.

Rear	Off
Ceiling	Off
OSD mute	Off

---

**4** **Press ▲ or ▼ to select “Rear” or “Ceiling”, and press VOLUME/ADJUST (+, -) to select the required orientation. (Refer to left chart)**  
Example: When setting “Floor-mounted rear projection”

Rear	On
Ceiling	Off
OSD mute	Off

---

**5** **Press EXIT/◀.**  
The menu returns.  
• This setting is stored until you turn the power off.

---

**6** **Press EXIT/◀.**  
The menu disappears.

**Notes**

- If you want to store the setting even if the power is turned off, select “Save”.
- If you press the RESET button when this setting menu is displayed, all the setting items of “Mode” returns to default.

# SETTING OSD (ON SCREEN DISPLAY) MUTE FUNCTION

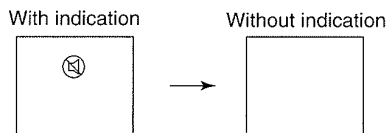

You can keep the on-screen displays (OSD) off even while switching the input sources (RGB1, RGB2, Video1, Video2) or losing then (⏻, ⏷), or cutting off the picture and sound (⏻, ⏷).

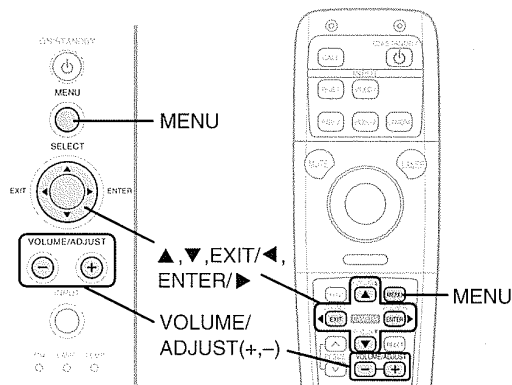

## Setting OSD MUTE

Display the image as explained in "PICTURE PROJECTION" . 17

**1** **Press MENU.**  
The menu is displayed.  
It automatically disappears after about 30 seconds if no button is pressed.

Video1
Video2
Panel
Mode
Language
Save

**2**   
 **Press ▲ or ▼ to select "Mode".**

Video1
Video2
Panel
<b>Mode</b>
Language
Save

**3** **Press ENTER/▶.**  
The setting menu of "Mode" is displayed.

Rear	Off
Ceiling	Off
OSD mute	Off

**4**   
 **Press ▲ or ▼ to select "OSD mute".**

Rear	Off
Ceiling	Off
<b>OSD mute</b>	<b>Off</b>

**5** **Press VOLUME/ADJUST (+, -) to select "On" or "Off".**

-	+
Off	On
not making	making
OSD to Mute. OSD to Mute.	

Rear	Off
Ceiling	Off
<b>OSD mute</b>	<b>On</b>

**6** **Press EXIT/◀.**  
The menu returns.  
• This setting is stored until you turn the power off.

**7** **Press EXIT/◀.**  
The menu disappears.

ADJUSTMENTS

**Notes**

- If you want to store the setting even if the power is turned off, select "Save". 29
- If you press the RESET button when this setting menu is displayed, all the setting items of "Mode" returns to default.

# SAVING THE ADJUSTMENTS

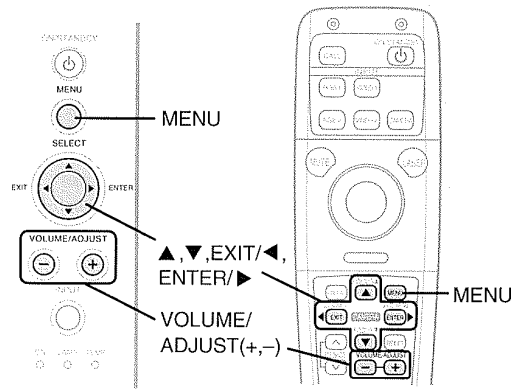

You can save the adjusting values.

## Saving the Adjustments

Display the image as explained in "PICTURE PROJECTION" .

**1** **Press MENU.**  
The menu is displayed.  
It automatically disappears after about 30 seconds if no button is pressed.

Video1  
Video2  
Panel  
Mode  
Language  
Save

**2** **Press ▲ or ▼ to select "Save".**

Video1  
Video2  
Panel  
Mode  
Language  
Save

**3** **Press ENTER/▶.**  
"Save On" is displayed.

Save On

If the adjustments or setting are not changed, "Save Off" will be displayed.

**4** **Press VOLUME/ADJUST (+).**

Save Off

All the values adjusted and set in the menu are memorized and held if the power is turned off.

**5** **Press EXIT/◀.**  
The menu returns.

**6** **Press EXIT/◀.**  
The menu disappears.



# PROJECTING IMAGES WITH THE DOCUMENT IMAGING CAMERA

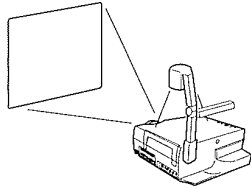

## Caution

- When using the camera, be careful to not pinch your hand or fingers into the arm.
- Do not look into the projection lens while operating the projector.

On the document imaging camera model, you can project pictures using the document imaging camera. The document imaging camera can directly project any materials (documents, illustrations etc.) without using an OHP film.

## Names and Functions of the Document Imaging Camera

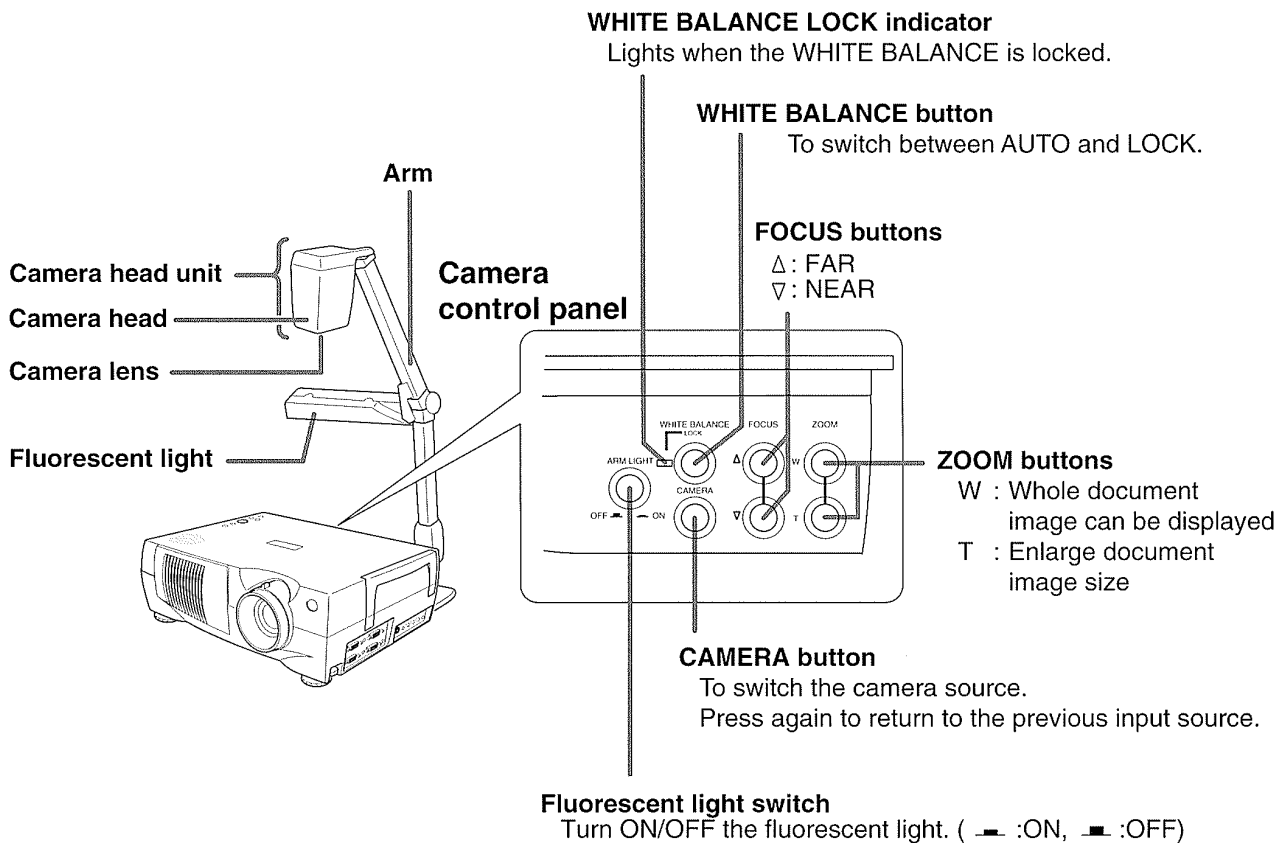

## Left side

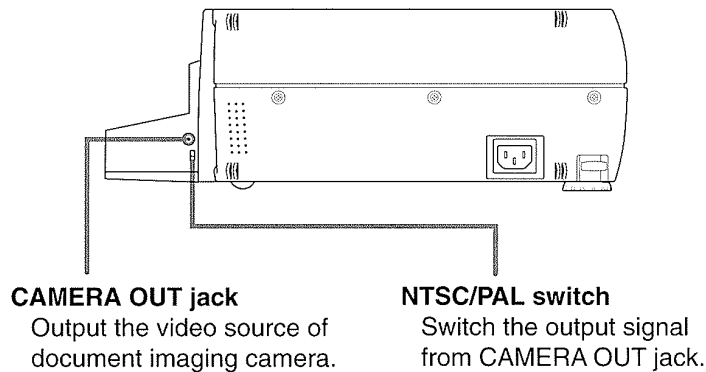



# PROJECTING IMAGES WITH THE DOCUMENT IMAGING CAMERA (CONTINUED)

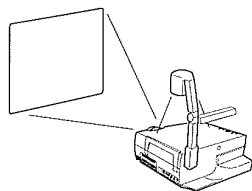

## Projecting Images with the Document Imaging Camera

- Adjust the focus between the projector and screen by turning the focus ring as needed.
- Adjusting the focus is easier if done while pressing the MENU button and displaying the menu.

1

### Open the rear cover.

Detach by pressing the buttons on both sides of the cover to release the locks.

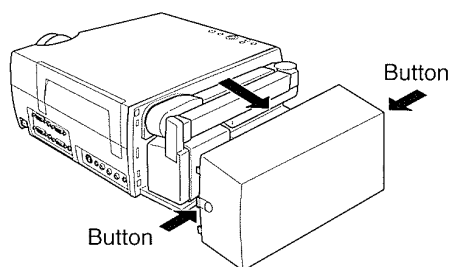

3

### Stretch the arm.

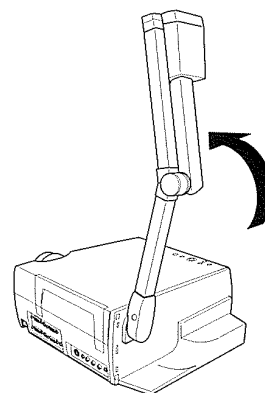

2

### Raise up the arm.

Pull up the arm until it clicks and be fixed.

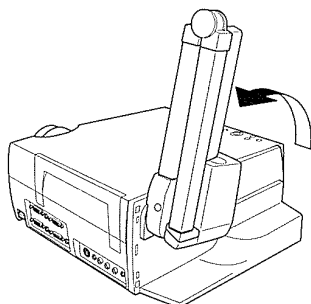

4

### Turn the camera head unit.

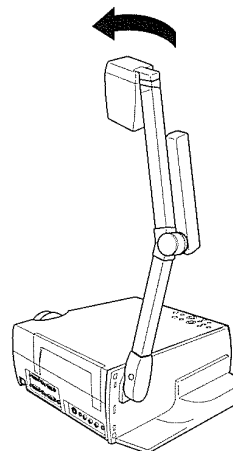

### Notes

- Never give shocks or impacts to the camera or arm as this may cause breakdowns.
- While raising up the arm in step 3, be careful to not hit your face or your body.

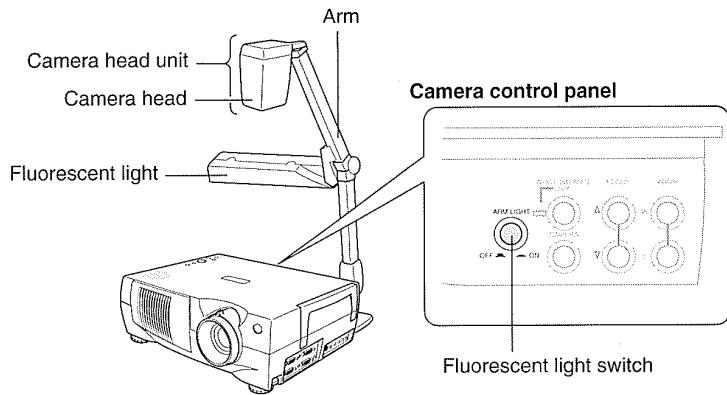

5



**Pull out the fluorescent light as illustrated below and turn on the fluorescent light switch.**

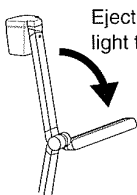

Eject the fluorescent light to the side

Turn the fluorescent light on to illuminate the document. When set to ON the fluorescent light automatically lights up or turns off when the arm is raised or lowered.

6

**Place the document (text, illustration) you want to show, onto the projector and turn the camera head to direction of the document.**

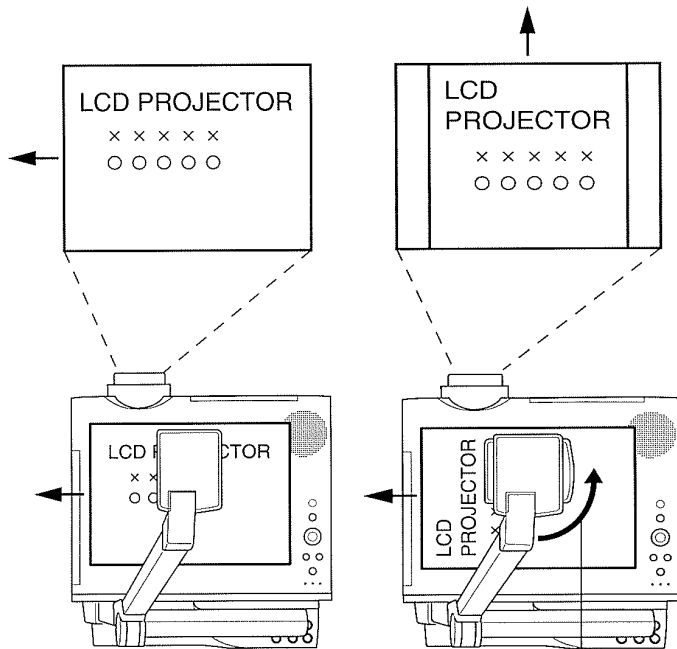

Turn the camera head 90°

Projectable documents size is about 390 (mm) x 300 (mm). Turn the camera head to the direction of the projected material.

**Projecting around**

You can project around the projector by moving the camera head.

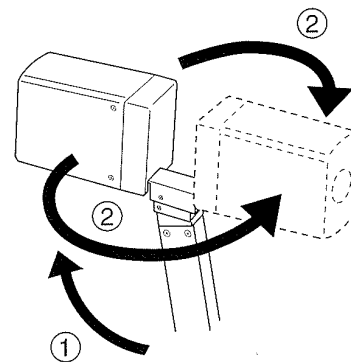

- 1 Lift the camera head unit (①).
- 2 Turn the camera head unit (②).

CAMERA

**Notes**

- When projecting a transparent draft such as an OHP film or small size data such as a name card, etc., use the projector with the accessory Pad placed.
- When a glossy draft such as a photograph is placed, the projected document may become difficult to see due to a light such as a fluorescent lamp is reflected. In such a case, try to move the draft forward and project with the camera head direction adjusted to the draft moved.

# PROJECTING IMAGES WITH THE DOCUMENT IMAGING CAMERA (CONTINUED)

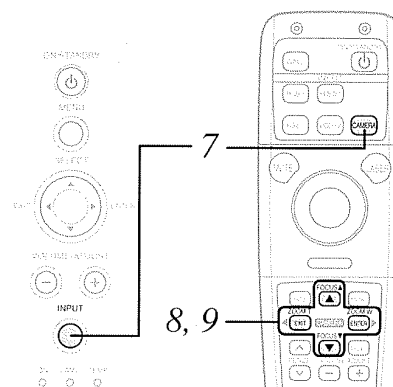
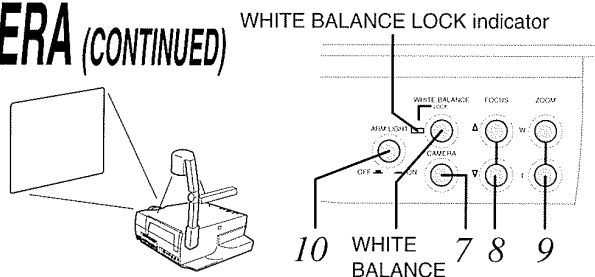

## Projecting Images with the Document Imaging Camera (Continued)

7

CAMERA

Select "Camera" by pressing CAMERA.

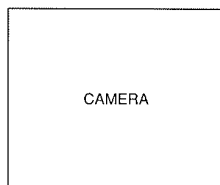

You can switch to camera input by pressing the CAMERA button of the camera control panel or the INPUT button of the main unit.



8

FOCUS▲



FOCUS▼



Press FOCUS ▲ and FOCUS ▼ to focus.

First enlarge the picture to the maximum using the ZOOM T button, and adjust the focus.

The FOCUS buttons on the camera control panel are available as well.

First, adjust the focus of the main unit.



9

ZOOM T ZOOM W

EXIT ENTER

Press ZOOM T and ZOOM W to adjust the size of the picture.

The ZOOM buttons on the camera control panel are available as well.

10

ARM LIGHT



When finished, turn off the fluorescent light, and return the camera and arm to the original position.

Follow steps 1 to 4 in inverse.

Set the camera head on its original position.

Lay down the arm while pressing the button on the base of the arm.

If the button is hard to press, slightly move the arm up and down to press the button.

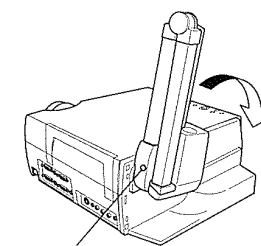

Press this button

Put back with arm and head section aligned.

## Locking the white balance

This camera is always adjusting the color balance when set to AUTO. If the color balance is not shown properly, follow the steps below to lock the white balance.

- 1 Place a white paper and enlarge it to the size of the screen.
- 2 Light the LOCK indicator by pressing the WHITE BALANCE button.  
To return to AUTO mode, press again the WHITE BALANCE button. The LOCK indicator will turn off.

### Notes

- When the arm is not raised up, the picture from the "Camera" input is not projected.
- Connecting a capture card to the CAMERA OUT jack, you can export pictures on the document imaging camera to a computer.
- When the arm is raised with the camera input selected, the color of the camera picture will vary for an instant period due to the white balance function worked, but this is normal not a failure.
- When the arm is laid down and raised again, signals obtained from the CAMERA OUT jack may disturb. In this case, raise the arm again.
- When the arm is laid down and raised again with the white balance locked (lock indicator ON), the indicator is kept ON, but the white balance lock is released. In this case, pressing the white balance button again returns the lock indicator to the normal status.

# ADJUSTING THE DOCUMENT IMAGING CAMERA

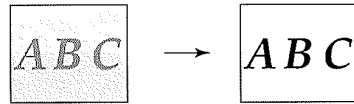

Explains how to adjust the exposure.

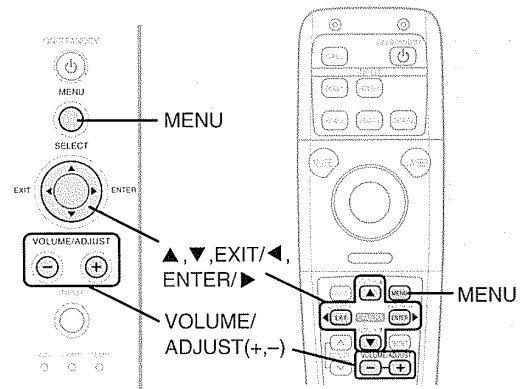

## Adjusting the Exposure

The exposure is automatically adjusted, and the fine adjustment can be made manually. If the projected document is dark, adjust the iris to "+". If the projected document is too bright, adjust the iris to "-".

**1** **Press MENU.**  
The menu is displayed. It automatically disappears after about 30 seconds if no button is pressed.

Video1  
Video2  
Panel  
Mode  
Language  
Camera  
Save

"Camera" is displayed only in the camera input selected.

**2** **Press ▲ or ▼ to select "Camera".**

Video1  
Video2  
Panel  
Mode  
Language  
Camera  
Save

**3** **Press ENTER/▶.**  
The adjusting menu of "Camera" is displayed.

Iris

**4** **Press VOLUME/ADJUST (+, -) to adjust the iris.**

Example: Adjusting to + position.

Iris

If the projected document is dark, adjust the iris to "+". If the projected document is too bright, adjust the iris to "-".

**5** **Press EXIT/◀.**  
The menu returns.  
• This adjustment is stored until you turn the power off.

**6** **Press EXIT/◀.**  
The menu disappears.

### Notes

- If you want to store the adjustment even if the power is turned off, select "Save". [29](#)
- If you press the RESET button when this adjusting menu is displayed, the adjustment of "Iris" returns to default.

# TROUBLE INDICATIONS

If there is some problem inside the projector, the indicators light up or flash.

## Troubleshooting

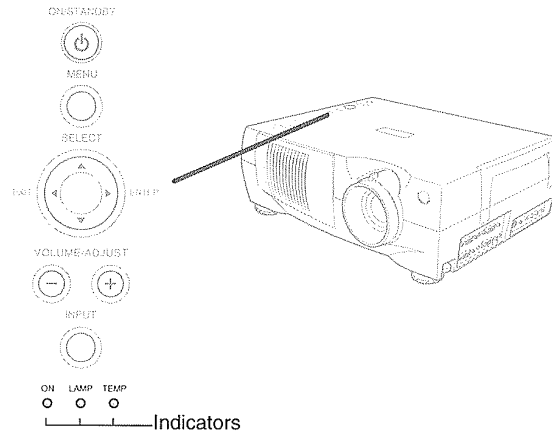

Indicators			Symptom and cause	Solutions
ON	LAMP	TEMP		
off	–	–	The power does not come on. → Malfunction of the unit.	Unplug the power cord and call the dealer.
Lit (Red)	–	–		
Lit (Red)	Lit (Red)	–	The lamp turns off or does not light up.	<ul style="list-style-type: none"> <li>Lamp's life length is over, replace the lamp with new one. <a href="#">37</a></li> <li>Unplug the power cord and call the dealer.</li> </ul>
Lit (Red)	–	Lit (Red)	The power turns off or does not come on. → The inside is too hot, or the projector has been working in an area of high temperature.	<ul style="list-style-type: none"> <li>Place the projector correctly so the intake and exhaust fans' holes are not covered.</li> <li>Turn the projector off, and leave it for a while, and turn it on again.</li> <li>Clean the air filter. <a href="#">36</a></li> </ul>
Lit (Red)	–	Flashing (Red)	The power turns off or does not come on. → Trouble with the intake fan.	Unplug the power cord and call the dealer.
Lit (Red)	–	Flashing (Orange)	The power turns off or does not come on. → Trouble with the exhaust fan.	Unplug the power cord and call the dealer.

**Note**

Before attempting any maintenance, unplug the power cord.

# AIR FILTER, LENS, AND MAIN UNIT CLEANING

Give a frequent clean especially to the air filter.  
(The cleaning period is once per about 50 hours).

**CAUTION**

If you use the projector mounted on the ceiling, ask the dealer to carry out the maintenance such as cleaning.

## Cleaning the Air Filter

The filter under the air filter cover is the device to shut out dusts or dregs.  
Do not use the projector with the filter taken off.

**1 Unplug the power cord.**

**2 Take off the air filter cover.**

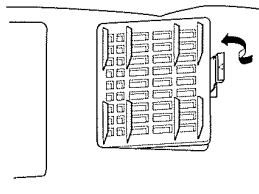

The filter is on the bottom side of the projector.  
Pull up the filter tabs.

**3 Clean the air filter cover.**

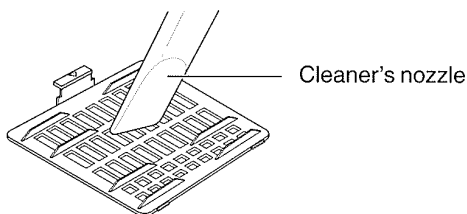

Remove dust and stains with a vacuum cleaner.

**4 Attach the air filter cover.**

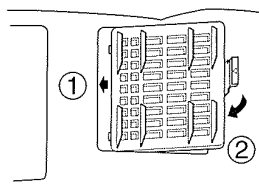

## Cleaning the Lens

Use a blower or a lens cleaner to clean the lens.  
Never rub or tap the lens with a hard object as the lens surface is fragile.

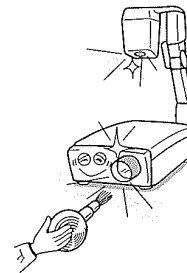

## Cleaning the Main Unit

- Pull out the power cord before cleaning.
- Use a soft cloth to wipe off stains from the surface.
- To remove difficult stains, use a soft cloth slightly moistened with a weak solution of synthetic detergent and water, and finish with a soft, dry cloth.

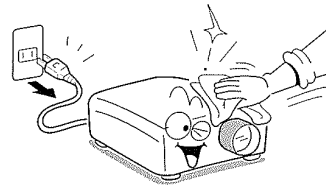

## Replacing the Intake, Exhaust Fans and Air Filter

To maintain the efficiency of the projector, replace the intake and exhaust fans about every two to three years.  
Ask the dealer for the replacement.

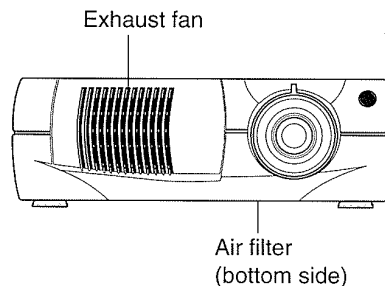

**Notes**

- When the air filter is dusty, the ventilation is impaired. This causes the temperature inside the projector to rise, and may damage the unit.
- Attach the air filter cover firmly after the cleaning. If it is not set correctly, the dusts will enter and they will be projected and overlapped on the picture.

# LAMP REPLACEMENT

The lamp will eventually begin to project dark or dull pictures and finally will not light up. (Lamp's life length depends on the use condition.) In such a case, replace the lamp with new one.

## Replacing the Lamp

### CAUTION

- If you use the projector mounted on the ceiling, ask the dealer to carry out the maintenance such as cleaning or replacement of the lamp.
- When replacing, always use lamp "TLPL3" (for TLP710U, TLP711U) or "TLPL7" (for TLP770U, TLP771U) (sold separately). For detail, refer to the lamp instruction.
- If you have been using the projector, the lamp will be very hot, and may cause burn injuries. Wait for the lamp to cool (for longer than 1 hour) before replacing it.

**1 Unplug the power cord.**

**2 Wait until the lamp gets cold enough.**

**3 Take off the lamp cover on the bottom panel.**

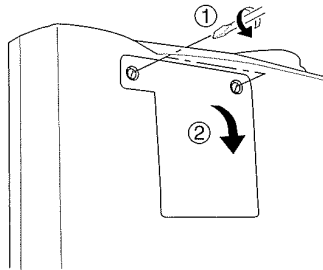

Loosen two screws, and pull off the lamp cover.

**4 Pull out the lamp.**

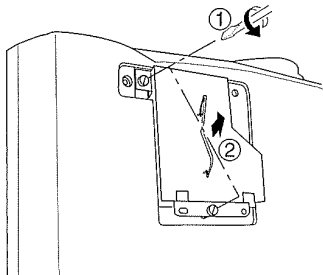

Loosen the two fixing screws, and lift up the handle to pull out the lamp.

**5 Load a new lamp.**

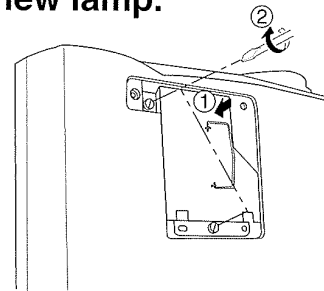

Slide until it hit the bottom and tighten the two fixed screws.

**6 Attach the lamp cover.**

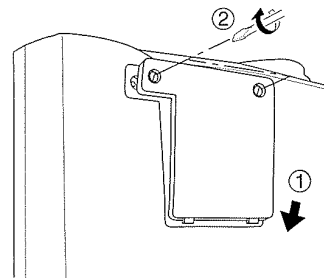

Slide the cover in place and tighten two screws.

**7 Reset the lamp timer.**

Refer to the lamp instructions for resetting.

### Notes

- The projector displays the total working time at every 1,000 hours (only when plugged in and turned on; ex. ">1000H", ">2000H").
- The lamp should be replaced if the total working time exceeds about 2,000 hours.
- Attach the lamp cover firmly after replacing the lamp. If it is not set correctly, the power will not turn on.
- Use a new lamp when replacing it.
- The lamp is made of glass and is very fragile. Do not touch the lamp with your bare hands and do not jolt or damage it. Do not use an exhausted lamp.

# FLUORESCENT LIGHT REPLACEMENT

If both ends of the fluorescent light are blackened or flickering, the light is worn out. Replace it.

## Replacing the Fluorescent Light

**CAUTION**

If you have been using the projector, the fluorescent light will be very hot, and may cause burn injuries. Wait for the fluorescent light to cool before replacing it.

**1 Unplug the power cord.**

**2 Remove the cover pressing the clips on it.**

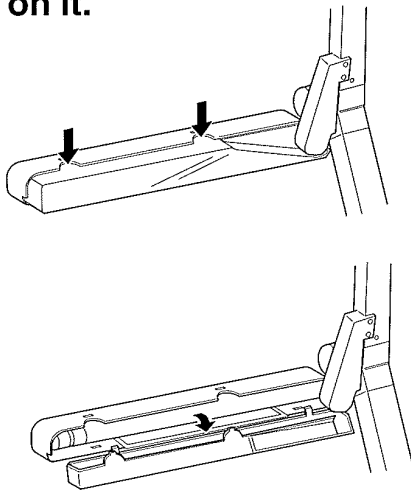

**3 Rotate the fluorescent light and pull out the light towards you.**

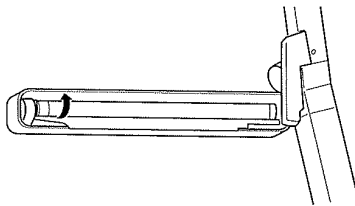

To take off, turn the left side 90° to the direction shown by the arrow.

**4 Install a new fluorescent light.**

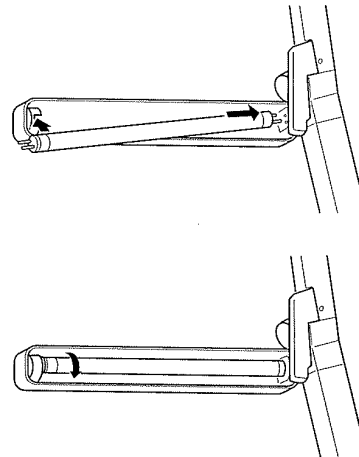

After fitting the left side, turn the light 90° to the direction shown by the arrow.

**5 Reinstall the cover.**

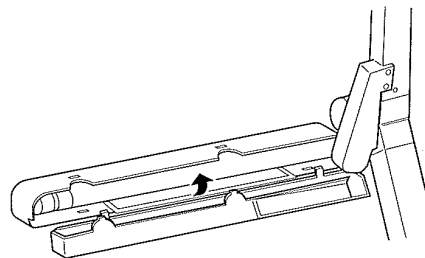

Fit the bottom clips first and then fit the top clips.

**Notes**

- Even with a good fluorescent light, flickering may occur. In such a case, if you switch off, wait for a short while, then switch on again, the flickering should go away. (If the light blinks a few times or the flickering stops after the light is on for a few minutes, this is not a problem.)
- Use FL6W for the fluorescent light.



# BEFORE CALLING SERVICE PERSONNEL

Check the following points before asking for support service.

## Symptoms and Solutions

Refer also to "TROUBLE INDICATIONS" 

Symptom	Cause	Solution	Reference page
The power does not come on.	The power cord is disconnected.	Firmly plug in the power cord.	16
	The lamp cover is not attached correctly.	Attach the cover correctly.	37
The power turns off while using the projector.	The ambient temperature of the projection room is too high.	Lower the ambient temperature of the projection room, and turn the power on.	–
No images appear.	The lens cover is on.	Take off the lens cover.	16
	The wrong input is selected.	Select the input source correctly.	17
	The MUTE mode is on.	Press MUTE button to restore the picture.	21
	The brightness adjustment is at its darkest.	Adjust the brightness.	24
	The source is not correctly connected to the projector.	Connect the source correctly to the projector.	13,14
No sounds are heard.	The wrong input is selected.	Select the input source correctly.	17
	The AUDIO MUTE mode is on.	Press the MUTE button to restore the sound.	21
	The sound volume is at the minimum.	Adjust the sound volume with the VOLUME buttons.	18
	The source is not correctly connected to the projector.	Connect the source correctly to the projector.	13,14
The images are blurred. Focusing is uneven.	The lens is dirty.	Clean the lens. Use a lens cleaner to clean the lens.	36
	The picture is out of focus.	Focus the picture.	18
	The projection distance is not appropriate.	Adjust the distance properly.	15
	The projecting light is not hitting the screen squarely.	Adjust the projecting direction so that the light hits the screen squarely.	15
	The brightness, contrast, sharpness or synchronization adjustments are not correct.	Adjust the picture.	24, 26

Symptom	Cause	Solution	Reference page
The pictures are dim.	The brightness or contrast adjustments are not correct.	Adjust the picture.	24
	The lamp life is ending.	Replace the lamp.	37
The colors are faint. The colors are strange.	The color, tint, R-Level, G-Level or B-Level adjustments are not correct.	Adjust the picture.	24,25
	The lamp life is ending.	Replace the lamp.	37
Image does not appear when using the document imaging camera.	The wrong input is selected.	Select the correct input source.	33
	Document to be projected is not positioned properly.	Place the document within the projectable range.	32
Image is out of focus or not clear when using the document imaging camera.	The camera lens is dirty.	Clean the camera lens. Use a lens cleaner to clean the lens.	36
	The document imaging camera is out of focus.	Focus the document imaging camera.	33
	Focus between main unit and screen is not correct.	Focus the picture by turning the focusing ring.	18
	Fluorescent light is not on. The image may not be projected clearly if the fluorescent light is not on.	Turn on the fluorescent light.	32
On-screen characters are not displayed.	OSD mute is set to On.	Set OSD mute to Off.	28
The remote control does not work.	The remote control is not facing the remote sensor.	Face the remote control transmitter toward the remote sensor on the projector.	12
	The remote control is too far.	Operate within about 5 meters.	12
	There is an obstruction between the remote control and the remote sensor.	Remove the obstacle.	-
	The batteries are exhausted.	Replace the batteries.	12

# INPUT SIGNAL

## Mode Determination and Signal System

Mode	Signal System	Frequency		Resolution Lines		Synchronizing H/V	Default	Remarks
		Hor. (kHz)	Ver. (Hz)	Horizontal	Vertical			
NTSC	NTSC	15.734	59.940	664	484	N/N	●	VIDEO IN
PAL/SECAM	PAL/SECAM	15.625	50.000	756	574	N/N	●	VIDEO IN
NTSC/DTV480i	Digital broadcasting	15.750	60.000	720/640	480	N/N	●	VIDEO IN/RGB IN
DTV480P/VGA60Hz	Digital broadcasting	31.500	60.000	720/640	480	N/N	◎	VIDEO IN/RGB IN
DTV720P	Digital broadcasting	47.500	60.000	1280	720	N/N	○	VIDEO IN/RGB IN
HDTV/DTV1080i	Hi-Vision/Digital broadcasting	33.750	60.000	1920	1080	N/N	○	VIDEO IN/RGB IN
NEC24K	PC98 STANDARD	24.830	56.420	640	400	N/N	◎	RGB IN
TEXT70	VGA-350	31.470	70.090	640	350	P/N	◎	RGB IN
TEXT70	VGA-400	31.470	70.090	640	400	N/P	◎	RGB IN
TEXT85	VGA 85Hz-1	37.861	85.080	640	350	P/N	◎	RGB IN
TEXT85	VGA 85Hz-2	37.861	85.080	640	400	N/P	◎	RGB IN
VGA60	VGA 60Hz	31.470	59.940	640	480	N/N	◎	RGB IN
VGA72	VGA 72Hz	37.861	72.809	640	480	N/N	◎	RGB IN
VGA75	VGA 75Hz	37.500	75.000	640	480	N/N	◎	RGB IN
VGA85	VGA 85Hz-4	43.269	85.008	640	480	N/N	◎	RGB IN
MAC13	MAC-13"	35.000	66.667	640	480	-/-	◎	RGB IN
SVGA56	SVGA 56Hz	35.156	56.250	800	600	P/P	◎	RGB IN
SVGA60	SVGA 60Hz	37.879	60.317	800	600	P/P	◎	RGB IN
SVGA72	SVGA 72Hz	48.077	72.188	800	600	P/P	◎	RGB IN
SVGA75	SVGA 75Hz	46.875	75.000	800	600	P/P	◎	RGB IN
SVGA85	SVGA 85Hz	53.674	85.061	800	600	P/P	◎	RGB IN
MAC16	MAC-16"	49.724	74.550	832	624	-/-	◎	RGB IN
XGA43i	XGA 43Hz interlace	35.522	43.479x2	1024	768	P/P	◎	RGB IN
XGA60	XGA 60Hz	48.363	60.004	1024	768	N/N	◎	RGB IN
XGA70	XGA 70Hz	56.476	70.069	1024	768	N/N	◎	RGB IN
XGA75	XGA 75Hz	60.023	75.029	1024	768	P/P	◎	RGB IN
XGA85	XGA 85Hz	68.677	84.997	1024	768	N/N	◎	RGB IN
MAC19	MAC-19"	60.197	74.872	1024	768	N/N	◎	RGB IN
SXGA75-1	SXGA 75 Hz	67.500	75.000	1152	864	P/P	○	RGB IN
MAC21	MAC-21"	68.681	75.062	1152	870	-/-	○	RGB IN
SXGA60-1	SXGA 60 Hz	60.000	60.000	1280	960	P/P	○	RGB IN
SXGA85-1	SXGA 85 Hz	85.938	85.002	1280	960	P/P	□	RGB IN
SXGA43i	SXGA 43Hz interlace	46.433	43.436x2	1280	1024	P/P	○	RGB IN
SXGA60-2	SXGA 60 Hz	63.981	60.020	1280	1024	P/P	○	RGB IN
SXGA75-2	SXGA 75 Hz	79.976	75.025	1280	1024	P/P	○	RGB IN
SXGA85-2	SXGA 85 Hz	91.146	85.024	1280	1024	P/P	□	RGB IN
UXGA60	UXGA 60 Hz	75.000	60.000	1600	1200	P/P	□	RGB IN
UXGA65	UXGA 65 Hz	81.130	65.000	1600	1200	P/P	□	RGB IN
UXGA70	UXGA 70 Hz	87.500	70.000	1600	1200	P/P	□	RGB IN
UXGA75	UXGA 75 Hz	93.750	75.000	1600	1200	P/P	□	RGB IN

◎: full compatible ○: dot resizing display □: simplified display ●: high resolution serial transfer control

### Notes

- If the mode identification does not define the mode described on the chart above, adjust to the projection details.
- If the mode identification is carried out correctly, a normal display may be not obtained depending on the signal frequency.
- SXGA, UXGA signals can be projected since the projector has simplified compatibility with them. (However, letters and lines can be inequal or a part can be missing. Some signals may not be projected at all.)
- Some computers may have output modes which are not compatible with this projector. Check the compatibility of the connectors, signal levels, timing, and resolutions.

## Signal Assignment

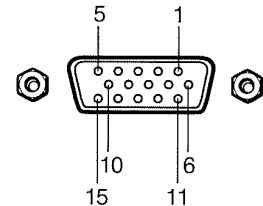

D-SUB 15 pin shrinking terminal

### Input Signal

Video signal Analog  
0.7V(p-p)  
75Ω

Horizontal TTL level  
synchronizing (positive/negative  
signal polarity)

Vertical TTL level  
synchronizing (positive/negative  
signal polarity)

Composite TTL level  
synchronizing  
signal

### Pin arrangements

Pin No.	
1	Video input (Red)
2	Video input (Green)
3	Video input (Blue)
4	N.C
5	GND
6	GND (Red)
7	GND (Green)
8	GND (Blue)
9	N.C
10	GND
11	GND
12	N.C
13	Horizontal synchronizing/ composite synchronizing signal
14	Vertical synchronizing signal
15	N.C

## RGB Signal Defaults

The following signals are factory set as defaults in each mode. However, some computers may have different timings than those in the chart. Make the necessary adjustments if the picture has flickers or is blurred.

### Timing Chart

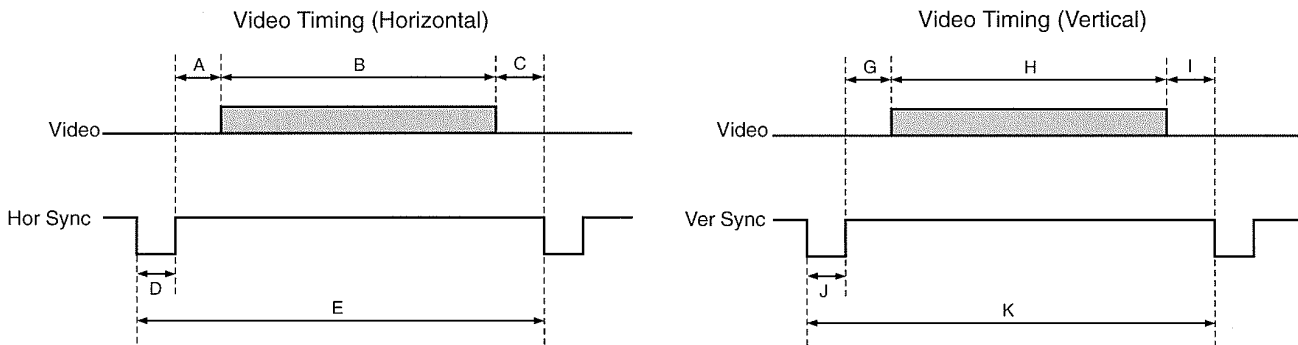

Mode	Resolution	A (Pixels)	B (Pixels)	C (Pixels)	D (Pixels)	E (Pixels)	fh (kHz)	fv (Hz)	clock (MHz)	G (Lines)	H (Lines)	I (Lines)	J (Lines)	K (Lines)
NEC24k	640 x 400	85	640	59	64	848	24.83	56.42	21.053	25	400	7	8	440
TEXT70	640 x 350	50	640	14	96	800	31.47	70.09	25.175	59	350	38	2	449
TEXT70	640 x 400	50	640	14	96	800	31.47	70.09	25.175	34	400	13	2	449
TEXT85	640 x 350	96	640	32	64	832	37.86	85.08	31.500	60	350	32	3	445
TEXT85	640 x 400	96	640	32	64	832	37.86	85.08	31.500	41	400	1	3	445
VGA60	640 x 480	48	640	16	96	800	31.47	59.94	25.175	33	480	10	2	525
VGA72	640 x 480	128	640	24	40	832	37.86	72.81	31.500	28	480	9	3	520
VGA75	640 x 480	120	640	16	64	840	37.50	75.00	31.500	16	480	1	3	500
VGA85	640 x 480	80	640	56	56	832	43.27	85.01	36.000	25	480	1	3	509
MAC13	640 x 480	96	640	64	64	864	35.00	66.67	30.240	39	480	3	3	525
SVGA56	800 x 600	128	800	24	72	1024	35.16	56.25	36.000	22	600	1	2	625
SVGA60	800 x 600	88	800	40	128	1056	37.88	60.32	40.000	23	600	1	4	628
SVGA72	800 x 600	64	800	56	120	1040	48.08	72.19	50.000	23	600	37	6	666
SVGA75	800 x 600	160	800	16	80	1056	46.88	75.00	49.500	21	600	1	3	625
SVGA85	800 x 600	152	800	32	64	1048	53.67	85.06	56.250	27	600	1	3	631
MAC16	832 x 624	216	832	40	64	1152	49.72	74.55	57.283	39	632	1	3	667
XGA60	1024 x 768	160	1024	24	136	1344	48.363	60.004	65.000	29	768	3	6	806
XGA70	1024 x 768	144	1024	24	136	1328	56.476	70.069	75.000	29	768	3	6	806
XGA75	1024 x 768	176	1024	16	96	1312	60.023	75.029	78.750	28	768	1	3	800
XGA85	1024 x 768	208	1024	48	96	1376	68.677	84.997	94.500	36	768	1	3	808
MAC19	1024 x 768	180	1024	20	96	1320	60.197	74.872	73.200	30	768	3	3	804

# ADJUSTMENTS WITH RS-232C

## Controlling Via the RS-232C Terminal

Conditioning of the Projection Unit can also be done by a computer via the RS-232C, as well as by the remote control.

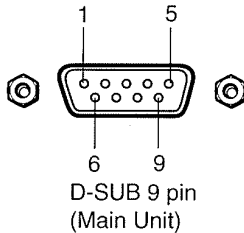

Pin No.	Signal	Meaning
1	N.C	No connection
2	TXD	Sending data
3	RXD	Receiving data
4	DSR	Data set ready
5	GND	Signal ground
6	DTR	Data terminal ready
7	CTS	Consent to send
8	RTS	Request to send
9	N.C	No connection

Use a straight-wired communication cable.

## Interface Format

The interface is established according to the following format.

1	Communication method	RS-232C No parity + 8DATA + 1 STOP bit			
2	Data format	Command shall be composed of alphanumeric characters of ASCII description. Use only capital letters.			
3	Speed	9600 bps			
4	Communication format	<table border="1" style="margin-left: 20px;"> <tr> <td>STX (02h)</td> <td>Command (3Byte)</td> <td>ETX (03h)</td> </tr> </table> <p>One command only can be used in one communication.</p>	STX (02h)	Command (3Byte)	ETX (03h)
STX (02h)	Command (3Byte)	ETX (03h)			
5	Return value	Acknowledge <table border="1" style="margin-left: 20px;"><tr><td>ACK (06h)</td></tr></table> Not Acknowledge <table border="1" style="margin-left: 20px;"><tr><td>NAK (15h)</td></tr></table>	ACK (06h)	NAK (15h)	
ACK (06h)					
NAK (15h)					

## Command List

### (1) NORMAL COMMAND

Command	Original meaning of command	Meaning	Command	Original meaning of command	Meaning
PON	PowerON	Power on.	POF	PowerOFF	Power off.
IN0	INput-0	Adjusts to INPUT-0 (CAMERA).	IN1	INput-1	Adjusts to INPUT-1 (RGB1).
IN2	INput-2	Adjusts to INPUT-2 (RGB2).	IN3	INput-3	Adjusts to INPUT-3 (VIDEO1).
IN4	INput-4	Adjusts to INPUT-4 (VIDEO2).			
VUP	Vol-UP	Volume up.	VDW	Vol-DoWn	Volume down.
MON	MuteON	All mute on.	MOF	MuteOFF	All mute off.
AON	AudioON	Audio mute on.	AOF	AudioOFF	Audio mute off.
DON	DisplayON	Displaying condition on.	DOF	DisplayOFF	Displaying condition off.
FON	FreezeON	Freezing on.	FOF	FreezeOFF	Freezing off.
RUP	ResizeUP	Resizing up.	RDW	ResizeDoWn	Resizing down.
RS0	ReSize0	Resize reset.	PO0	POsition0	Position reset.
PO1	POsition1	Move up.	PO2	POsition2	Move down.
PO3	POsition3	Move left.	PO4	POsition4	Move right.

(2) COMMON ADJUSTMENT

Command	Original meaning of command	Meaning	Command	Original meaning of command	Meaning
ALF	Adj-LeFt	Adjusts value down.	ARG	Adj-RiGht	Adjusts value up.
DSV	DataSaVe	Save adjusts value.	DRS	DataReSet	Adjust value to default.

(3) VIDEO1 ADJUSTMENT

Command	Original meaning of command	Meaning	Command	Original meaning of command	Meaning
VCN	Video-CoNtrast	Adjusts contrast balance.	VBR	Video-BRight	Adjusts brightness balance.
VCL	Video-CoLor	Adjusts color balance.	VTN	Video-TiNt	Adjusts tint balance.
VSH	Video-SHarp	Adjusts sharpness balance.			

(4) VIDEO2 ADJUSTMENT

Command	Original meaning of command	Meaning	Command	Original meaning of command	Meaning
VLR	Video-Level-Red	Adjusts Red level.	VLG	Video-Level-Green	Adjusts Green level.
VLB	Video-Level-Blue	Adjusts Blue level.			

(5) PANEL ADJUSTMENT

Command	Original meaning of command	Meaning	Command	Original meaning of command	Meaning
PVP	Panel-V-Pos	Adjusts of vertical position.	PHP	Panel-H-Pos	Adjusts of horizontal position.
PPH	Panel-PHase	Adjust of sample phase.	PCK	Panel-Clock	Adjust of sample clock.

(6) MODE ADJUSTMENT

Command	Original meaning of command	Meaning	Command	Original meaning of command	Meaning
MO0	Mode-Osd0	OSD mute off.	MO1	Mode-Osd1	OSD mute on.
MC0	Mode-Ceil0	Ceiling mounted off.	MC1	Mode-Ceil1	Ceiling mounted on.
MR0	Mode-Rear0	Rear mounted off.	MR1	Mode-Rear1	Rear mounted on.

(7) LANGUAGE ADJUSTMENT

Command	Original meaning of command	Meaning	Command	Original meaning of command	Meaning
LEN	Lang. ENGLISH	Adjusts to English display.	LJP	Lang. JaPanese	Adjusts to Japanese display.
LFR	Lang. FRench	Adjusts to French display.	LGR	Lang. GeRman	Adjusts to German display.
LSP	Lang. SPanish	Adjusts to Spanish display.	LIT	Lang. ITalian	Adjusts to Italian display.

(8) CAMERA ADJUSTMENT

Command	Original meaning of command	Meaning	Command	Original meaning of command	Meaning
CZU	Cam-ZoomUp	Zoom wide.	CZD	Cam-ZoomDown	Zoom tele.
CFU	Cam-FocusUp	Focus far.	CFD	Cam-FocusDown	Focus near.
CIR	Cam-IRis	Adjusts of IRIS.			

# SPECIFICATIONS

## SPECIFICATIONS

### [Main Unit]

Power requirements	AC 100 – 240V 50/60Hz
Power consumption	TLP710U: 205W (120V), TLP770U: 240W (120V) TLP711U: 220W (120V), TLP771U: 255W (120V)
Mass	TLP710U, TLP770U: 6.9 Kg TLP711U, TLP771U: 8.2 Kg
Dimensions	TLP710U, TLP770U: 390 x 139 x 309 (mm) (W/H/D) (Including the projecting sections) TLP711U, TLP771U: 390 x 139 x 390 (mm) (W/H/D) (Including the projecting sections)
Ambient environment	Temperature: 0°C to 35°C Humidity: 30% to 70% RH
Lamp	TLP710U, TLP711U: UHP lamp 120W TLP770U, TLP771U: UHP lamp 150W
Speaker	1.5W (monaural)
RGB1 inputs	RGB signal (D-sub 15-pin) Audio: 1V(p-p), more than 22k $\Omega$ , $\phi$ 3.5mm stereo mini jack
RGB2 inputs	RGB signal (D-sub 15-pin) Audio: 1V(p-p), more than 22k $\Omega$ , $\phi$ 3.5mm stereo mini jack
VIDEO1 inputs	S-video signal (Mini DIN 4-pin): Y input: 1V(p-p), 75 $\Omega$ , negative synchronization C input: 0.286V(p-p) (burst signal), 75 $\Omega$ Audio: 1V(p-p), more than 22k $\Omega$ , $\phi$ 3.5mm stereo mini jack
VIDEO2 inputs	Video signal/Y: 1V(p-p), 75 $\Omega$ Cb/Pb: 0.7V(p-p), 75 $\Omega$ Cr/Pr: 0.7V(p-p), 75 $\Omega$ Audio: 1V(p-p), more than 22k $\Omega$ , $\phi$ 3.5mm stereo mini jack
Outputs	RGB signal (D-sub 15-pin) Audio: 1V(p-p), less than 2.2k $\Omega$ , $\phi$ 3.5mm stereo mini jack
CONTROL terminal	D-sub 9-pin (RS-232C)
Cabinet Material	ABS resin

### [Liquid Crystal Display]

Projection system	3-panels transmission
Panel size	1.3 inches
Driving system	TFT active matrix
Picture elements	786,432 (1024 x 768 dots) x 3

### [Projection Lens]

Lens	Zooming lens F=2.0 – 2.5 f=50 – 70mm
Focusing	Manual operation
Zooming	Manual operation

## [Document Imaging Camera]

Lens	F=1.8 – 2.3, f=5.8 – 23.2mm
Filming area	Max 390 (mm) horizontal, 300 (mm) vertical (WIDE)
Zoom	Motor-driven (Manual)
Focus	Motor-driven (Manual)
Iris	Auto/Level adjustment allowed
Image element	1/3 inch CCD
Total picture elements	810,000
Resolution	Horizontal 1024, vertical 768
Lighting	6W fluorescent light
Output Terminal	Pin jack (NTSC/PAL signal)

## [Accessories]

Wireless remote control .....	1
AA size battery .....	2
Power cord .....	1
RGB cable .....	1
Adapter for Macintosh computers .....	1
PC Audio cable .....	1
Video cable .....	1
Audio cable .....	1
Lens cover .....	1
Pad .....	1 (Only the document imaging camera model)
Infrared remote sensor unit.....	1
IBM/MAC cable (for infrared remote sensor unit) .....	1
PS/2 cable (for infrared remote sensor unit) .....	1
MAC cable (for infrared remote sensor unit).....	1

The design and specifications are subject to change without notice.

### Trademarks

NEC, PC-98 series are trademarks of NEC Corporation.

IBM, DOS/V, VGA, SVGA, XGA, SXGA, UXGA are trademarks or registered trademarks of International Business Machines Corporation.

Macintosh is a trademark of Apple Computer Inc.



# **LIMITED WARRANTY**

## **TOSHIBA TLP700 Series 3LCD Data Projector**

Toshiba America Consumer Products, Inc. (TACP) makes the following limited warranties. These limited warranties extend to the original end-user purchaser.

### **Limited two (2) Years Warranty of Parts and Labor**

TACP warrants this product and its parts against defects in materials or workmanship for a period of two years after the date of original retail purchase.

For a period of two years after the date of original retail purchase, TACP will repair a defective product or a part, without charge to you.

This warranty also covers accessories of 3LCD Data Projector.

This warranty period of the lamp is ninety (90) days.

### **Your Responsibility**

The above warranties are subject to the following conditions.

1. You must retain your bill of sale or provide other proof of purchase.
2. You must make a written notification within thirty (30) days after your discovery of a defective product or part.
3. All warranty servicing of this product or parts must be made by TACP or a service facility authorized by TACP.
4. These warranties are effective only if the product is purchased and operated in the USA.
5. Labor service charges for installation and adjustment of customer controls are not covered by this warranty.
6. Warranties extend only to defects in materials or workmanship as limited above and do not extend to any product or parts which have been lost or discarded by you or to damage to products or parts caused by misuse, accident, improper installation, improper maintenance or use in violation of instructions furnished by us; or to units which have been altered or modified without authorized of TACP or to damage to product or parts thereof which have had the serial number removed, altered, defaced or rendered illegible.
7. If it is determined after investigation that the claimed problem was not covered with this warranty, you shall pay the cost of investigation at prevailing rate.

### **Step-by-step procedure how to obtain warranty service**

To obtain warranty servicing, you should:

1. Read the owners manual thoroughly before operating.
2. Please contact your dealer for an immediate service and an advice.
3. If your dealer is not able to assist you, please contact TACP Service Center listed below or a servicing facilities authorized by TACP for a warranty service within thirty (30) days after you find a defective product or part.
4. Arrange for a delivery of the product to TACP Service Center or a servicing facilities authorized by TACP.
5. The shipment of the product must be insured, safely and securely packed, preferably in the original carton or a carton with an equivalent protection. A letter explaining the defect and also a copy of the bill of sale or other proof of purchase must be enclosed. All transportation and insurance charges must be prepaid by you.
6. The repaired product is returned freight prepaid to the purchaser after warranty servicing.
7. If you have any questions about service, please contact the following TACP Service Center.

TACP is not obligated to provide purchasers with a substitute unit during the warranty period.

82 Totowa Rd., Wayne,  
NJ 07470, U.S.A.

Phone: (973) 628-8000

Fax: (973) 628-1875

Toll Free for Service Call: 1-800-631-3811

**TOSHIBA AMERICA CONSUMER PRODUCTS, INC.**