

myprojectorlamps.com

**The most trusted, dependable name
in projector lamp sales.**



<http://www.myprojectorlamps.com>



<http://www.myprojectorlamps.ca>



<http://www.myprojectorlamps.eu>

The following projector manual has not been modified or altered in any way.

TOSHIBA

OWNER'S MANUAL

3LCD DATA PROJECTOR

TLP510U

TLP511U (WITH DOCUMENT IMAGING CAMERA)

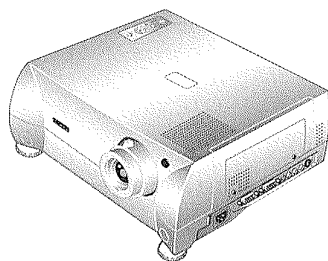
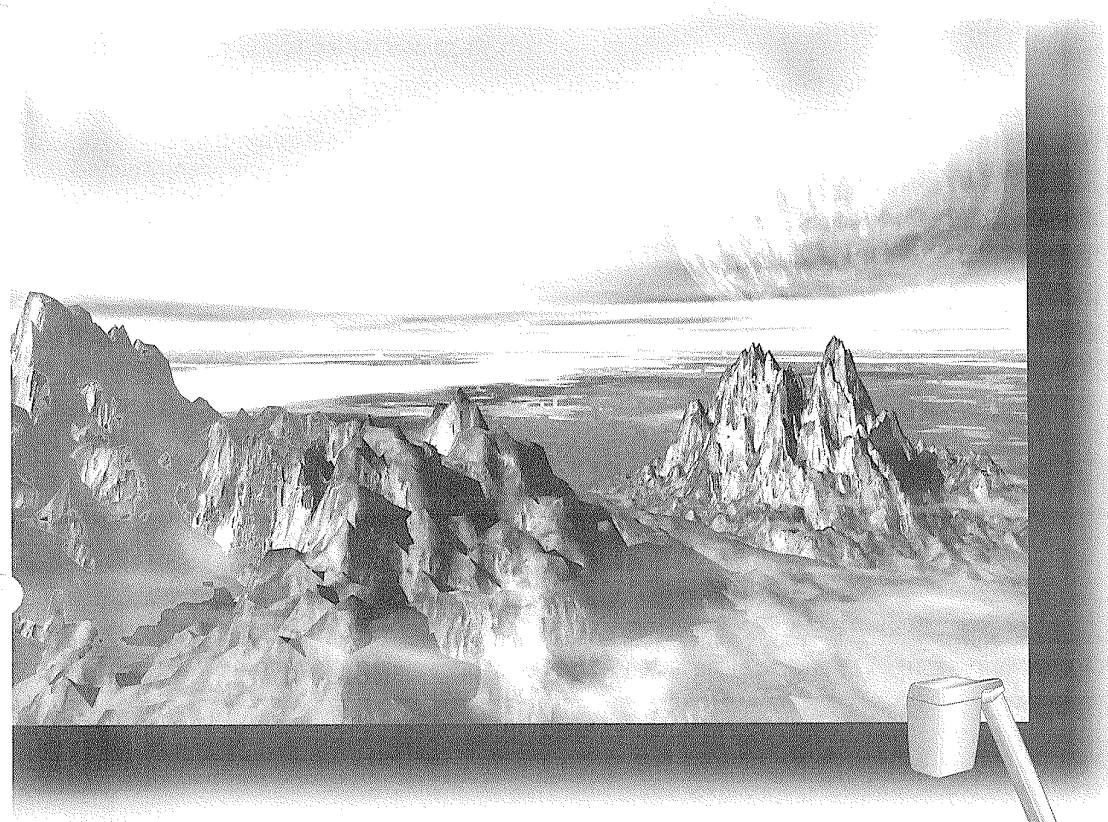

TLP510U

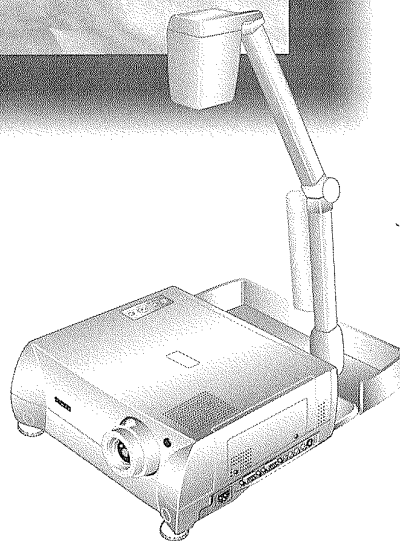

TLP511U

BEFORE USE

CONNECTIONS

INSTALLATION

OPERATIONS

ADJUSTMENTS

CAMERA

MAINTENANCE

OTHERS

SAFETY PRECAUTIONS

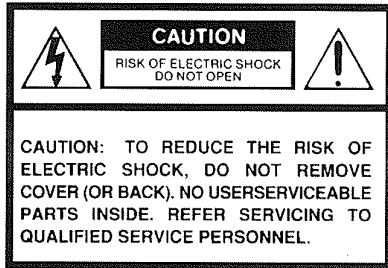

The lightning flash with arrowhead symbol, within an equilateral triangle, is intended to alert the user to the presence of uninsulated "dangerous voltage" within the product's enclosure that may be of sufficient magnitude to constitute a risk of electric shock to persons.



The exclamation point within an equilateral triangle is intended to alert the user to the presence of important operating and maintenance (servicing) instructions in the literature accompanying the appliance.

WARNING: TO REDUCE THE RISK OF FIRE OR ELECTRIC SHOCK, DO NOT EXPOSE THIS APPLIANCE TO RAIN OR MOISTURE. DANGEROUS HIGH VOLTAGES ARE PRESENT INSIDE THE ENCLOSURE. DO NOT OPEN THE CABINET. REFER SERVICING TO QUALIFIED PERSONNEL ONLY.

CAUTION: TO PREVENT ELECTRIC SHOCK, DO NOT USE THIS (POLARIZED) PLUG WITH AN EXTENSION CORD, RECEPTACLE OR OTHER OUTLET UNLESS THE BLADES CAN BE FULLY INSERTED TO PREVENT BLADE EXPOSURE.

WARNING FCC Radio Frequency Interference Statement

Note: This equipment has been tested and found to comply with the limits for a Class A digital device, pursuant to part 15 of the FCC Rules. These limits are designed to provide reasonable protection against harmful interference when the equipment is operated in a commercial environment. This equipment generates, uses, and can radiate radio frequency energy and, if not installed and used in accordance with the instruction manual, may cause harmful interference to radio communications. Operation of this equipment in a residential area is likely to cause harmful interference in which case the user will be required to correct the interference at his own expense.

DOC compliance notice

This digital apparatus does not exceed the Class A limit for radio noise emissions from digital apparatuses as set forth in the Radio Interference Regulations of the Canadian Department of Communications.

IMPORTANT PRECAUTIONS

Save Original Packing Materials

The original shipping carton and packing materials will come in handy if you ever have to ship your LCD projector. For maximum protection, repack the set as it was originally packed at the factory.

Avoid Volatile Liquid

Do not use volatile liquids, such as an insect spray, near the unit.
Do not leave rubber or plastic products touching the unit for a long time. They will mar the finish.

Moisture Condensation

Never operate this unit immediately after moving it from a cold location to a warm location. When the unit is exposed to such a change in temperature, moisture may condense on the crucial internal parts. To prevent the unit from possible damage, do not use the unit for at least 2 hours when there is an extreme or sudden change in temperature.

In the spaces provided below, record the Model and Serial No. located at the rear of your LCD projector.

Model No. _____ Serial No. _____

Retain this information for future reference.

IMPORTANT SAFETY INSTRUCTIONS

CAUTION: PLEASE READ AND OBSERVE ALL WARNINGS AND INSTRUCTIONS GIVEN IN THIS OWNER'S MANUAL AND THOSE MARKED ON THE UNIT. RETAIN THIS BOOKLET FOR FUTURE REFERENCE.

This set has been designed and manufactured to assure personal safety. Improper use can result in electric shock or fire hazard. The safeguards incorporated in this unit will protect you if you observe the following procedures for installation, use and servicing. This unit is fully transistorized and does not contain any parts that can be repaired by the user.

DO NOT REMOVE THE CABINET COVER, OR YOU MAY BE EXPOSED TO DANGEROUS VOLTAGE. REFER SERVICING TO QUALIFIED SERVICE PERSONNEL ONLY.

BEFORE USE

1. Read owner's manual

After unpacking this product, read the owner's manual carefully, and follow all the operating and other instructions.

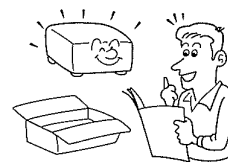

2. Power Sources

This product should be operated only from the type of power source indicated on the marking label. If you are not sure of the type of power supply to your home, consult your product dealer or local power company. For products intended to operate from battery power, or other sources, refer to the operating instructions.



3. Source of Light

Do not look into the lens while the lamp is on. The strong light from the lamp may cause damage to your eyes or sight.



4. Ventilation

Openings in the cabinet are provided for ventilation and to ensure reliable operation of the product and to protect it from overheating, and these openings must not be blocked or covered. The openings should never be blocked by placing the product on a bed, sofa, rug or other similar surface. This product should not be placed in a built-in installation such as a bookcase or rack unless proper ventilation is provided or the manufacturer's instructions have been adhered to.

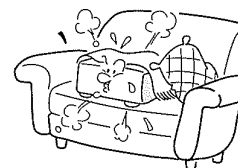

5. Heat

The product should be situated away from heat sources such as radiators, heat registers, stoves, or other products (including amplifiers) that produce heat.

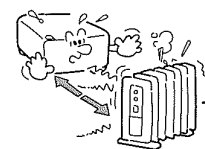

IMPORTANT SAFETY INSTRUCTIONS

6. Water and Moisture

Do not use this product near water - for example, near a bath tub, wash bowl, kitchen sink, or laundry tub; in a wet basement; or near a swimming pool and the like.

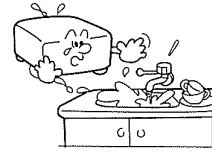

7. Cleaning

Unplug this product from the wall outlet before cleaning. Do not use liquid cleaners or aerosol cleaners. Use a damp cloth for cleaning.



8. Power-Cord Protection

Power-supply cords should be routed so that they are not likely to be walked on or pinched by items placed upon or against them, paying particular attention to cords at plugs, convenience receptacles, and the point where they exit from the product.



9. Overloading

Do not overload wall outlets; extension cords, or integral convenience receptacles as this can result in a risk of fire or electric shock.

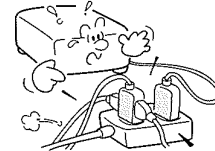

10. Lightning

For added protection for this product during storm, or when it is left unattended and unused for long periods of time, unplug it from the wall outlet.

This will prevent damage to the product due to lightning and power-line surges.

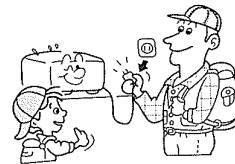

11. Object and Liquid Entry

Never push objects of any kind into this product through openings as they may touch dangerous voltage points or short-out parts that could result in a fire or electric shock. Never spill liquid of any kind on the product.

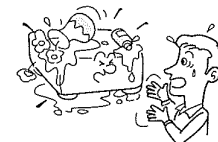

12. Do not place the product vertically

Do not use the product in the upright position to project the pictures at the ceiling, or any other vertical positions.

It may fall down and dangerous.

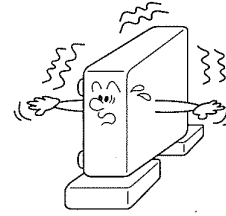
**13. Stack inhibited**

Do not stack other equipment on this product or do not place this product on the other equipment. Top and bottom plates of this product develops heat and may give some undesirable damage to other unit.

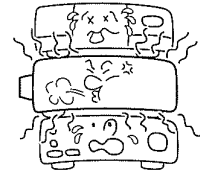
**14. Attachments**

Do not use attachments not recommended by the product manufacturer as they may cause hazards.

15. Accessories

Do not place this product on an unstable cart, stand, tripod, bracket, or table. The product may fall, causing serious injury to a child or adult, and serious damage to the product. Use only with a cart, stand, tripod, bracket, or table recommended by the manufacturer, or sold with the product. Any mounting of the product should follow the manufacturer's instructions, and should use a mounting accessory recommended by the manufacturer.

A product and cart combination should be moved with care. Quick stops, excessive force, and uneven surfaces may cause the product and cart combination to overturn.

**16. Damage Requiring Service**

Unplug this product from the wall outlet and refer servicing to qualified service personnel under the following conditions:

- a) When the power-supply cord or plug is damaged.
- b) If liquid has been spilled, or objects have fallen into the product.
- c) If the product has been exposed to rain or water.
- d) If the product does not operate normally by following the operating instructions. Adjust only those controls that are covered by the operating instructions as an improper adjustment of other controls may result in damage and will often require extensive work by a qualified technician to restore the product to its normal operation.
- e) If the product has been dropped or damaged in any way.
- f) When the product exhibits a distinct change in performance - this indicates a need for service.

17. Servicing

Do not attempt to service this product yourself as opening or removing covers may expose you to dangerous voltage or other hazards. Refer all servicing to qualified service personnel.



18. Replacement Parts

When replacement parts are required, be sure the service technician has used replacement parts specified by the manufacturer or have the same characteristics as the original part. Unauthorized substitutions may result in fire, electric shock, or other hazards.

(Replacement of the lamp only should be made by users.)

19. Safety Check

Upon completion of any service or repairs to this product, ask the service technician to perform safety checks to determine that the product is in proper operating condition.

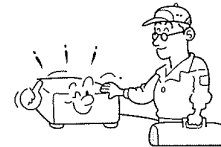

20. Do not get your hands between the camera arm and the main unit when setting the camera arm back in its original position.

To avoid injury, be careful not to get your hands caught when setting the camera arm back in its original position. Families with children should be particularly careful.

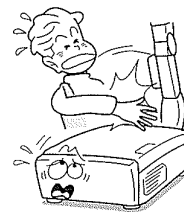

21. Do not carry by the camera arm.

Do not carry the projector by the camera arm. Doing so can result in damage or injury.

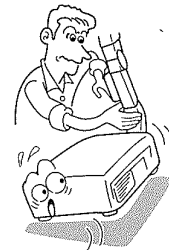

22. Do not leave documents on the unit for long periods of time while using the document imaging function.

Do not leave texts, papers or other documents for projection on the unit for long periods of time. The heat could erase the letters on a thermal paper.

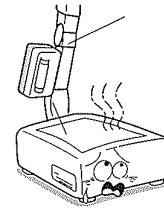

23. Before replacing the fluorescent light, turn off the power and wait at least one hour for the fluorescent light to cool down.

The fluorescent light gets hot, so handle it with care. Failure to do so may result in burns or other injuries.

24. Do not leave documents in the bottom of the projector.

Documents can block the air intake holes, making the inside of the projector heat up and causing breakdowns.

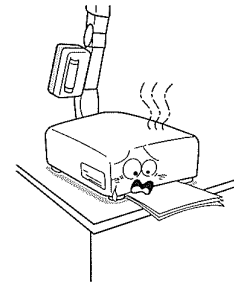

25. Do not move the projector while the arm is still erect.

Always store the arm back in position when moving the projector. Otherwise injury or damage may result.



26. Camera section is not locked. Do not hold the camera cover and camera unit when carrying out, etc.

Danger such as dropping, or cause of failure and injury may result.



FEATURES

Here are the main features of this projector.

Uniformly bright high-quality picture

The newly developed optic unit displays uniformly bright pictures. The high aperture ratio LCD panel and UHP lamp provide high intensity output and beautiful bright images.

High-density, high-quality video for multimedia

Reproduces video for the world's main television signal formats, NTSC, PAL, SECAM, and XGA, SVGA, VGA type computer video reliably and with high precision. In addition, SXGA signal can also be displayed in a simple format.

Compact, light-weight main unit

This projector is light-weight and compact so it is easy to carry around and set up.

Large-screen display of up to about 300 inches

Can project picture sizes from about 23 inches to 300 inches.

Up/down/left/right screen inversion function

The up/down/left/right screen inversion function allows forward or rear projection while mounted either on the floor or ceiling. (However, the document imaging camera model could not be mounted on the ceiling.)

6 Languages on screen display

Can select a display language from 6 of English, Japanese, French, German, Spanish and Italian.

Newly developed field converting IC





Can project pictures at the maximal projection size regardless of the signal types of VGA, SVGA, NTSC and PAL.

Document imaging camera

The document imaging camera can directly project any materials (documents, illustrations, moving pictures samples) without using an OHP film. (Only the document imaging camera model)

POWER SUPPLY CORD SELECTION

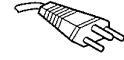
If your line voltage is 220 to 240V, use one of the following types of cable.

Plug Configuration	Plug Type	Line Voltage Selector Setting	Plug Configuration	Plug Type	Line Voltage Selector Setting
	EURO 240V 10 – 15A	220 – 240V		North American 240V 15A	200 – 240V
	UK 240V 6A	200 – 240V		Switzerland 240V 6A	200 – 240V
	Australian 240V 10A	200 – 240V			

CONTENTS

BEFORE USE	SAFETY PRECAUTIONS	1	BEFORE USE
	IMPORTANT PRECAUTIONS	1	
	IMPORTANT SAFETY INSTRUCTIONS	2	
	FEATURES	7	
	PARTS NAMES AND FUNCTIONS	9	
	Body and Control Panel	9	
	Remote Control	11	
CONNECTIONS	CONNECTIONS	13	CONNECTIONS
	Connecting an IBM PC or Compatible Computer (DOS/V)	13	
	Connecting a Macintosh Computer	13	
	Connecting Video Equipment	14	
	Output Terminals	14	
INSTALLATION	PROJECTOR PLACEMENT	15	INSTALLATION
	Front Projecting Placement	15	
OPERATIONS	PICTURE PROJECTION	17	OPERATIONS
	Projecting a Picture	17	
	Turning Off the Power After Use	18	
	MUTE FUNCTION / CALL FUNCTION	19	
	FREEZE FUNCTION / RESIZE FUNCTION	20	
	OPERATING THE COMPUTER BY THE REMOTE CONTROL	21	
ADJUSTMENTS	SELECTING THE DISPLAY LANGUAGE	22	ADJUSTMENTS
	PICTURE DETAIL ADJUSTMENTS (Contrast/Brightness/Color/Tint/Sharpness)	23	
	PROJECTION DETAIL ADJUSTMENTS (Vertical shift/Horizontal shift/Phase/Clock frequency)	25	
	PICTURE ORIENTATION SETTING	27	
	WIDE SCREEN SETTING	28	
	MICROPHONE SETTING	29	
	SETTING OSD (ON SCREEN DISPLAY) MUTE FUNCTION	30	
CAMERA	PROJECTING IMAGES WITH THE DOCUMENT IMAGING CAMERA	31	CAMERA
	Projecting Images with the Document Imaging Camera	31	
	ADJUSTING THE DOCUMENT IMAGING CAMERA	34	
	Adjusting the Exposure/Setting the Sensitivity	34	
MAINTENANCE	TROUBLE INDICATIONS	35	MAINTENANCE
	AIR FILTER, LENS, AND MAIN UNIT CLEANING	36	
	LAMP REPLACEMENT	37	
	FLUORESCENT LIGHT REPLACEMENT	38	
OTHERS	BEFORE CALLING SERVICE PERSONNEL	39	OTHERS
	RGB INPUT SIGNAL	41	
	Signal Assignment / Mode Determination and Signal System	41	
	Signal Defaults	42	
	ADJUSTMENTS WITH RS-232C	43	
	SPECIFICATIONS	45	
	LIMITED WARRANTY	Back cover	

PART NAMES AND FUNCTIONS

For detail, use the page inside the  mark next to the name.

Body and control panel

Control panel

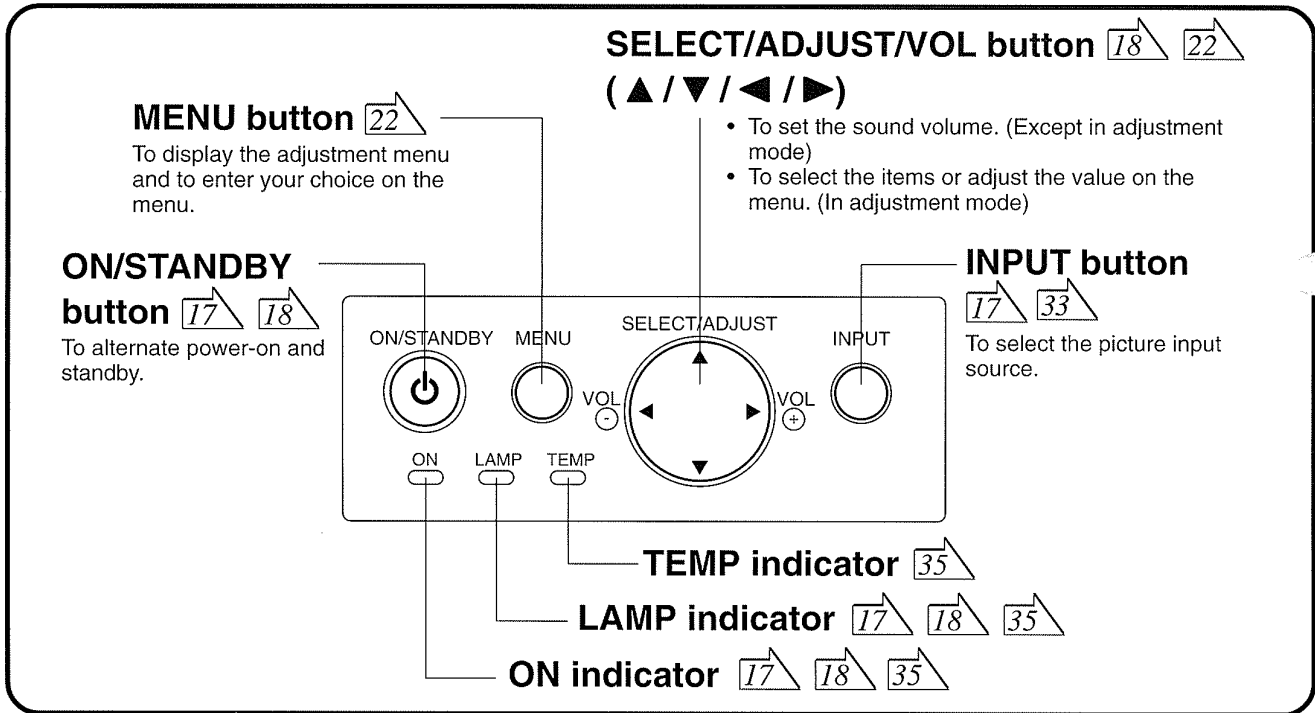

Lens cover



Zooming ring  18

Focusing ring  18

Projection Lens

Foot adjuster  16

Foot adjuster release button  16

Foot adjuster  16

Carrying Handle

If opens to the front. It's practical, when you are carrying.

Speaker

Intake fan (bottom side)

Infrared remote sensor  12

Left side

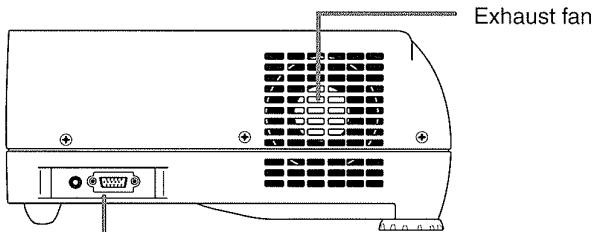

Right side

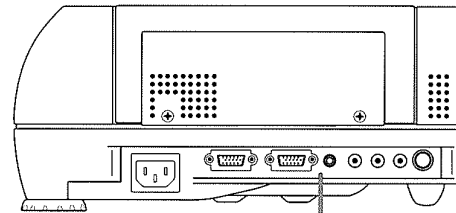

CONTROL (RS-232C) connector ¹⁴ ⁴³

To connect a computer to control the projector.

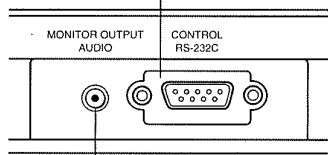

MONITOR OUTPUT AUDIO jack ¹⁴

To connect audio equipment.

MONITOR OUTPUT connector ¹⁴

To connect a monitor.

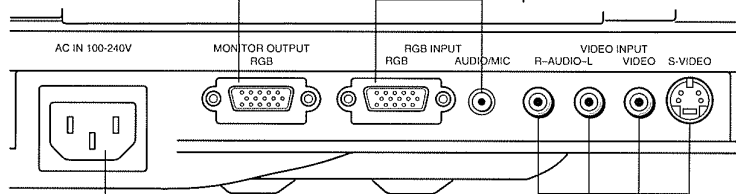

AC IN socket

VIDEO INPUT jacks ¹⁴

To connect a video tape player, etc.

RGB INPUT jack/connector ¹³ ²⁹

To connect external equipment such as a computer. AUDIO/MIC jack is available for inputting sound and microphone input.

Rear side

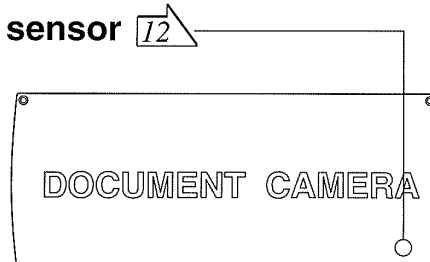
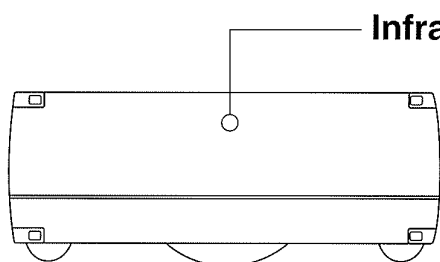

Document imaging camera model

PART NAMES AND FUNCTIONS (CONTINUED)

This instruction uses remote control. For details, see the page inside the  mark next to the name.

Remote Control

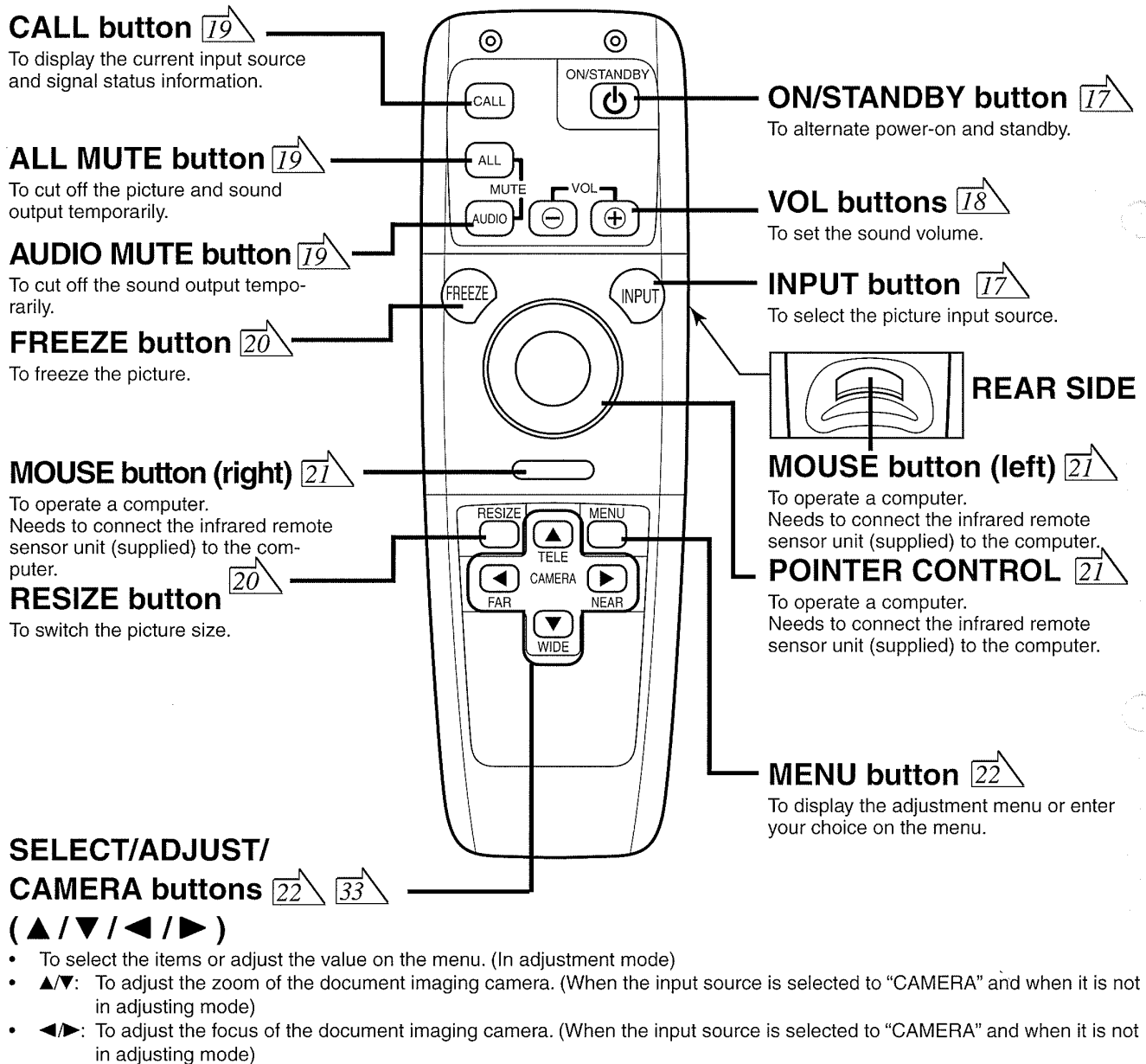

Installing Batteries

Install batteries to enable remote control operation.

1 Open the cover.

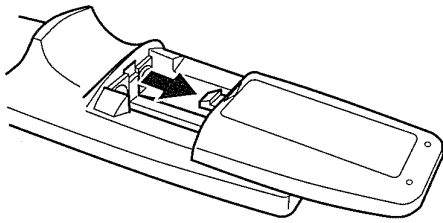

2 Install the batteries.

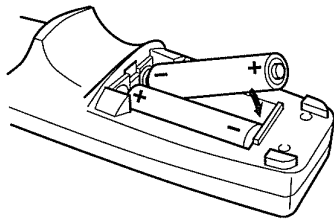

Make sure that the +/- polarities match the illustration in the compartment.

3 Attach the cover.

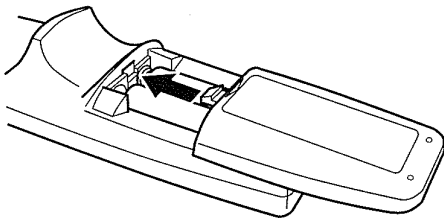

Batteries

Using batteries incorrectly can cause them to leak or burst. Strictly observe the following.

- Install the batteries with their + and - ends facing correctly.
- Do not charge, heat, disassemble, or short the batteries or throw them into a fire.
- Do not leave exhausted batteries in the remote control.
- Do not mix different types or batteries or new and old batteries.
- When you will not be using the remote control for a prolonged period, take the batteries out of the remote control.
- When the remote control stops working or only works from very close distance, replace all the batteries with new ones.
- When replacing the batteries, use a more longer life alkaline batteries.
- If a battery leaks, carefully wipe off any residue inside the battery case before loading new batteries.

Remote Control Operation

Instruction to use the remote control.

1 Face the main unit and press a remote control button.

Front side

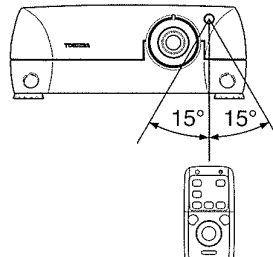

Rear side

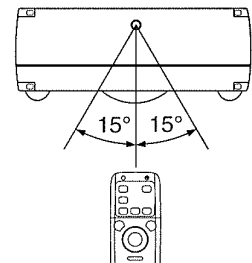

Rear side of the Document imaging camera model

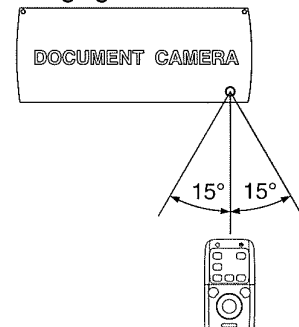

Distance : within about 5 meters from the front of the remote sensor.

Angle : within about 15° of the remote sensor in every direction.

- The remote control may not operate when there is sunlight or other strong light such as a fluorescence lamp shining on the remote sensor.

Remote Control

- Keep strong light off the remote sensor.
- Operate the remote control from a position where the remote sensor is visible.
- Do not drop the remote control or otherwise jolt it.
- Keep the remote control out of locations with excessively high temperature or humidity.
- Do not get water on the remote control or place wet objects on it.
- Do not disassemble the remote control.

BEFORE USE

CONNECTIONS

Pictures can be imported from connected equipment such as a computer or a video tape player.

Connecting an IBM PC or Compatible Computer (DOS/V)

Check that the power for the projector and computer are off before connecting the cables.

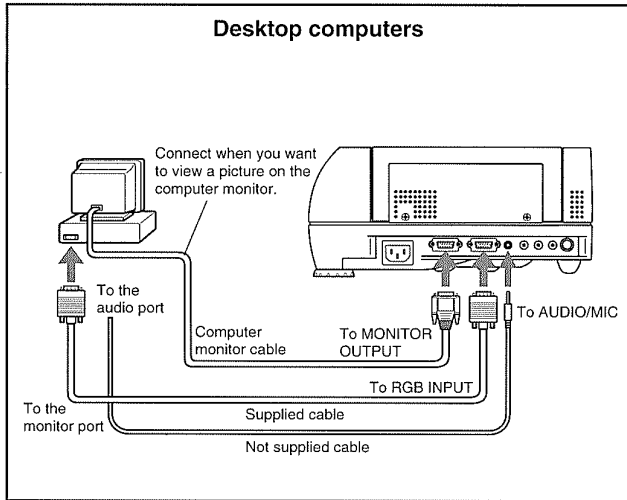

Connecting a Macintosh Computer

- Attach the supplied adapter for Macintosh computers.
- Check that the power for the projector and computer are off before connecting the cables.

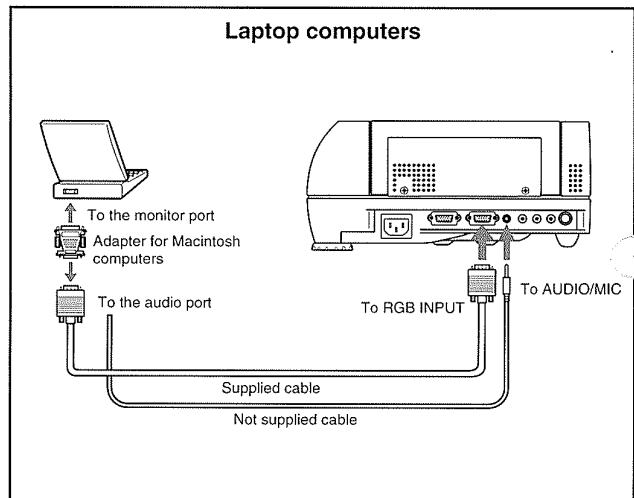
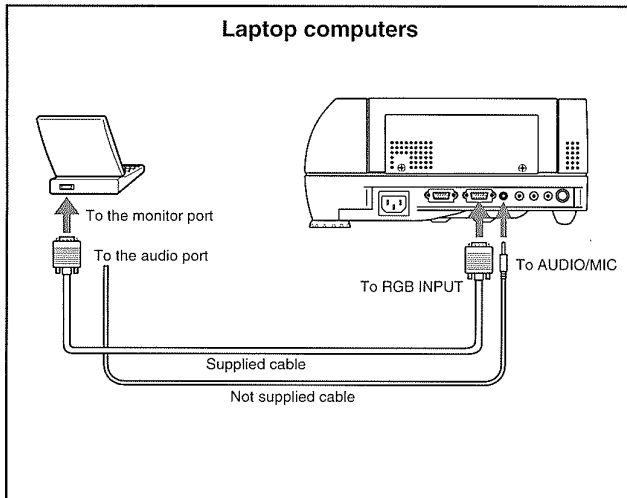
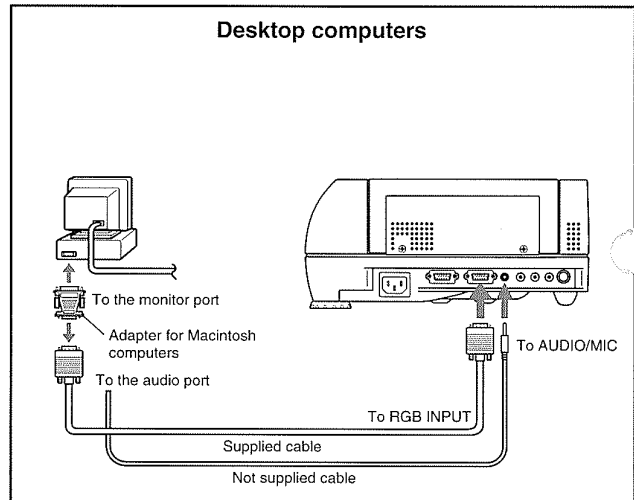

Notes

- The projector cannot be connected to a computer that does not have an analog RGB output terminal. For details, refer to the computer manual.
- You may not be able to connect some computers to the projector. For details, consult the dealer.
- If NTSC/PAL/SECAM signals are input to the RGB INPUT connector, they cannot be displayed. (Input NTSC/PAL/SECAM signals to the VIDEO INPUT jacks.)
- You may input computer sounds or microphone sounds from AUDIO/MIC jack. Refer to "MICROPHONE SETTING" 29.

Notes

- The projector cannot be connected to a computer that does not have an analog RGB output terminal. For details, refer to the computer manual.
- You may not be able to connect some computers to the projector. For details, consult the dealer.
- The adapter for Macintosh computers is conformable to MULTIPLE SCAN 21.

Connecting Video Equipment

Check that the power for the projector and computer are off before connecting the cables.

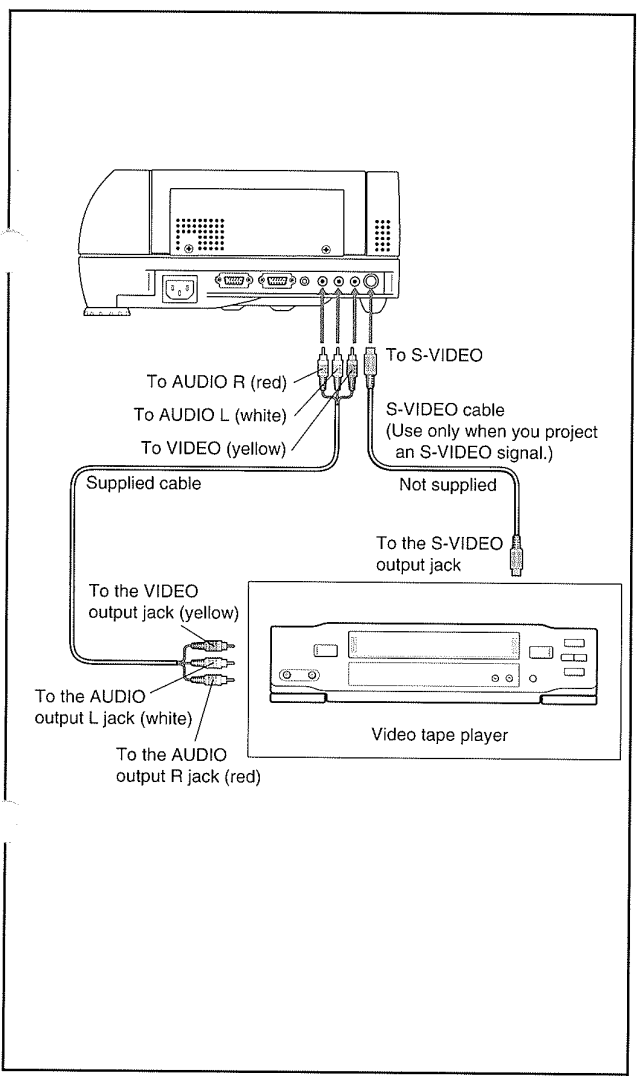

Notes

- When both the VIDEO (pin plug) jack and the S-VIDEO jack are connected, the signal through the S-VIDEO jack has priority.
To project a signal through the VIDEO (pin plug) jack, leave the S-VIDEO jack unplugged.
- When you play a monaural sound audio signal, use the AUDIO L (white) jack only.

Output Terminals

Check that the power for the projector and computer are off before connecting the cables.

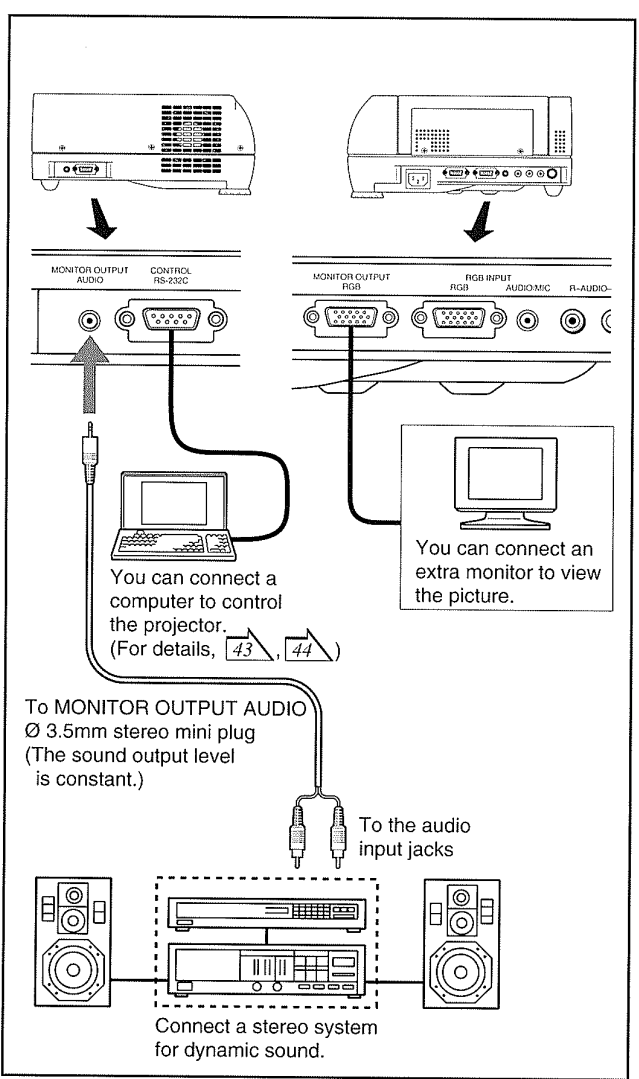

Notes

- The sound of the source selected with the INPUT button is the output to the stereo system, etc.
- The cables for the connections above are not supplied. Use separately available ones.
- The MONITOR OUTPUT connector always send out the video signal that was input to the RGB INPUT connector regardless of the selected input source.

PROJECTOR PLACEMENT

Following are placement guidelines for standard front projection usage.

Front Projecting Placement

- Select a room that can be darkened.
- Refer to the table below for the screen size and required distance.

1 Place the projector on a steady, level surface such as a table.

Point the projector squarely at the screen for the best possible picture.

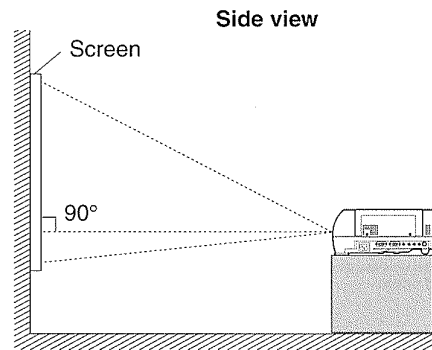
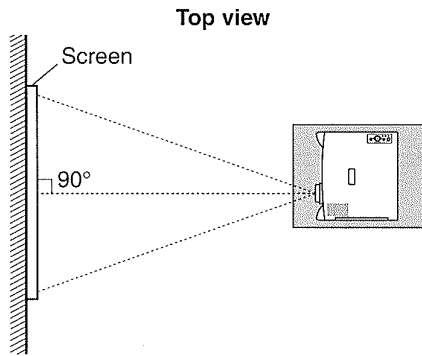

Point the lens straight at the center of the screen as above.

Place the projector horizontally so that the projecting light hits the screen squarely.

2 Adjust the distance between the lens and the screen.

The projection size depends on the distance between the lens and the screen. Adjust the projection size by changing the distances as shown below.

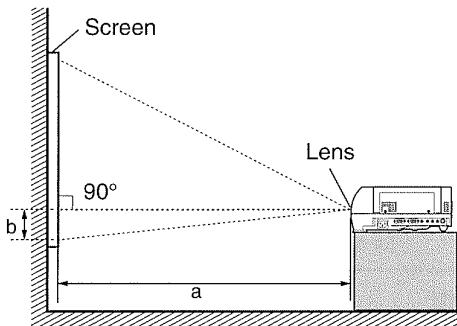

a: Distance between the lens and the screen.
b: Distance between the lens height and the bottom of the screen.

* The value in the list below are approximations.

Screen size (inches)	Distance between the lens and the screen: a (m)		Distance between the lens height and the bottom of the screen: b (cm)
	Minimum (WIDE)	Maximum (TELE)	
22	—	1.14	5
40	1.49	2.12	9
60	2.27	3.20	14
80	3.05	4.29	18
100	3.82	5.37	23
120	4.60	6.46	27
150	5.76	8.09	34
200	7.70	10.81	46
300	11.58	—	68

Note

When the projector is moved from a cold location to a warm location, or when the ambient temperature in the projection room has risen suddenly, moisture may condense on the lens or the mirror to blur the projected pictures. In such a case, leave the projector for an adequate time (1 to 2 hours, depending on the room's condition) before using it so it adjusts to the ambient temperature.

3 Connect the power cord.

- Insert one end in the AC IN socket on the rear panel.
- Insert the other end in a wall outlet.

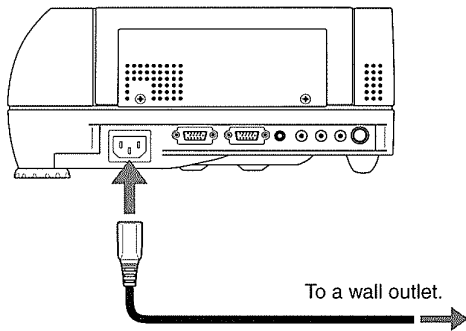

ON indicator (orange) turns on.

4 Take off the lens cover.

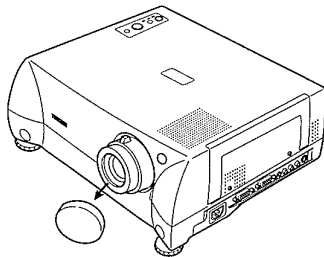

How to use the foot adjusters

The tilt of the projector can be adjusted using the foot adjusters.

1 Lift the front of the projector and press the foot adjuster release buttons.

Foot adjuster will stretch.
Release the buttons to lock in position.

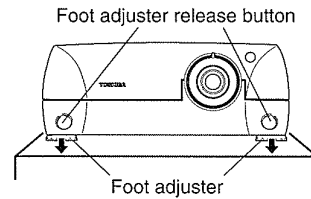

Side view

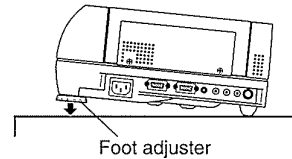

2 Turn the foot adjuster to adjust the height.

Turn clockwise to lift up.
Turn counterclockwise to lower.

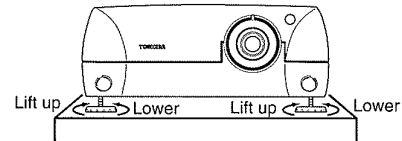

3 To put the foot adjuster back, hold down the foot adjuster release buttons and lower the front slowly.

The foot adjuster will put back.

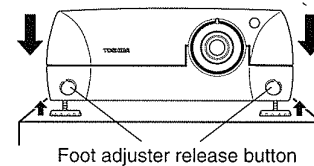

Notes

- To not pinch your fingers, when pushing the foot adjuster release buttons, always hold both sides of the unit.
- If the screen is exposed to direct sunlight or other strong light, the projected picture becomes too faint to see. Shut out the light with curtains or other means.
- If the screen and the projector are not installed properly the projected picture may be distorted.
- If the projector is tilted, the picture may be distorted. To obtain the best possible picture, place the projector so it faces the screen squarely.

PICTURE PROJECTION

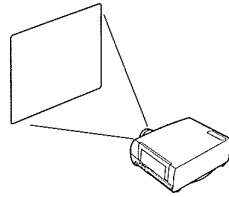

Explains the basic procedure for projecting a picture.

CAUTION

Do not look into the projection lens while operating the projector.

Projecting a Picture

- Install and connect the projector properly.
- Take off the lens cover.

1  **Press ON/STANDBY.**
Both the ON and LAMP indications light up in green, and the projector is ready to project a picture.

ON	LAMP
On (Green)	Flashing (Green)

↓

ON	LAMP
On (Green)	On (Green)

2 **Turn on the connected equipment and put it in playback mode.**
Turn on the connected computer or video tape player and put it in playback mode.

3  **Press INPUT to select the input source.**

VIDEO

The input source is switched each time you press the button.

VIDEO → RGB → CAMERA (document imaging camera model only)

VIDEO: To project pictures from a connected video tape player. [74](#)

RGB: To project pictures from a connected computer. [73](#)

CAMERA: To project pictures from a document imaging camera. [33](#)

Notes

- Tie the lens cover to the body with a string so as not to lose it.
- "NO SIGNAL" is displayed on the screen if the projector does not receive any signal from the connected equipment. Put the equipment in playback mode.
- Due to the lamp characteristic, flickers may occasionally occur in a picture. This is not malfunction of the unit.

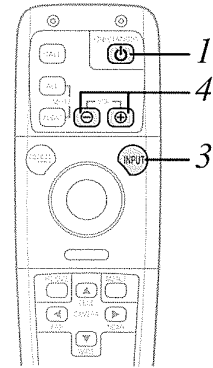
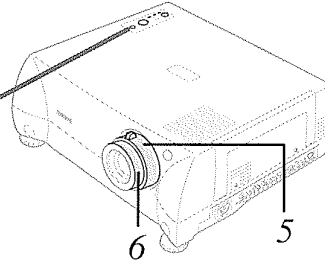
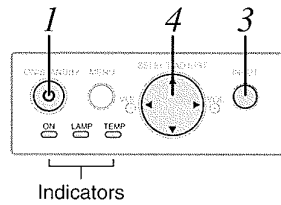

Turning Off the Power After Use

Following are guidelines for turning off the power.

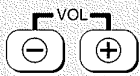
4  **Press VOL to set the sound volume.**

VOLUME 0 

+ : To turn up the volume.
- : To turn down the volume.

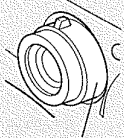
5  **Adjust the picture size by turning the zooming ring.**

Turn to the right to enlarge the picture.
Turn to the left to reduce the picture.

Zooming ring

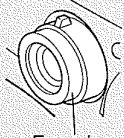
6  **Focus on the picture by turning the focusing ring.**

A still picture is recommended for focusing.

Focusing ring

1  **Press ON/STANDBY after using the projector.**

The LAMP indicator will turn off, and the projector is now in STANDBY mode.

ON	LAMP
On (Orange)	Flashing (Green)
↓	
ON	LAMP
On (Orange)	Off

2 **After confirming the intake and exhaust fans stop, unplug the power cord.**

The ON indicator turns off.

ON
Off

OPERATIONS

Notes

- Before unplugging the power cord, make sure that the fans is stopped.
- When the ON/STANDBY button is pressed after use, the intake and exhaust fans continue to work for about 3 minutes more to cool the inside of the projector.
- Immediately after the power off, the projector may not be turned on while the LAMP indicator is flashing in green.

MUTE FUNCTION / CALL FUNCTION

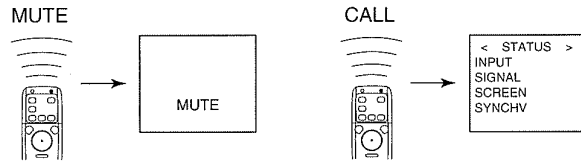
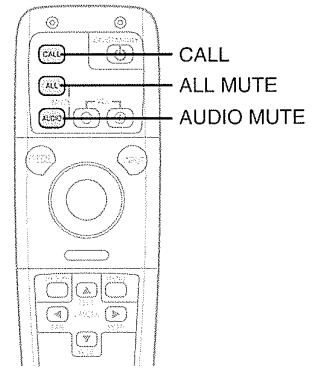

Cutting off the picture and sound temporarily and displaying the current input source information.

Cutting Off the Picture and Sound Temporarily

Cut off the picture and sound temporarily.

ALL Press **ALL MUTE**.

ALL MUTE

The picture and sound are cut off.
To restore, press the ALL MUTE button again.

Note

If you press the ALL MUTE button while the adjustment menu is displayed, the menu disappears and cancels the adjustment mode.

Cutting Off the Sound Temporarily

Cut off only the sound temporarily.

AUDIO Press **AUDIO MUTE**.

AUDIO MUTE

The sound is cut off.
To restore, press the AUDIO MUTE button again.

Displaying the Input Source Information

Displaying the current input source information.

CALL Press **CALL**.

< STATUS >
INPUT : VIDEO
SIGNAL : NTSC
SCREEN : NTSC
SYNCHV : - / -

The current input source signal information is displayed.
To close the display, press the CALL button again.

The contents of displayed items are as follows.

- Current input source
- Signal system output from the connected equipment.
- Signal system of the input source automatically detected by the projector. ("Mode Determination",)
- Synchronizing polarity of input signal.
 - P = Positive
 - N = Negative

< STATUS >
INPUT : VIDEO
SIGNAL : NTSC
SCREEN : NTSC
SYNCHV : - / -

Notes

- The display automatically disappears after about 10 seconds.
- If you press the CALL button while the adjustment menu is displayed, the menu disappears and cancels the adjustment mode.

FREEZE FUNCTION / RESIZE FUNCTION

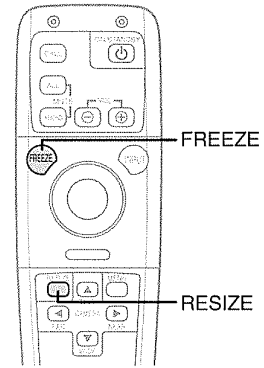
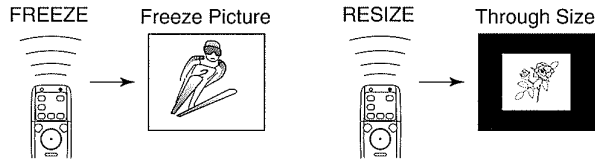

You may freeze the picture, change the size of the picture.

Freezing the Picture

You can freeze the picture.

FREEZE

Press FREEZE.

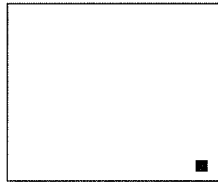

The picture freezes.
 To cancel the freeze mode, press the FREEZE button again.
 When the picture freezes, "■" mark will be shown on the bottom right corner of the screen.
 When making other operations, freeze mode will be cancelled.

Note

- This function is convenient for the case where you are using the document imaging camera model and change documents to project through the camera.

Changing the Picture Size

Pictures are projected at the maximal projection size regardless of the signal types. Optionally you can change the picture size if the input source is RGB.

RESIZE

Press RESIZE.

The picture size changes.
 To return to the initial position size, press the RESIZE button again.

VGA signals

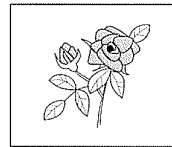

Enlarged to the maximal projection size.



Projected the signal as it is.

SVGA signals

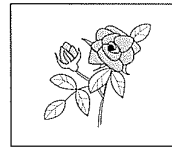

Enlarged to the maximal projection size.



Projected the signal as it is.

XGA signals

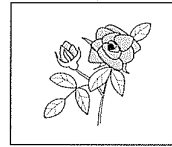

Projected the signal as it is.

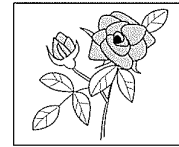

Enlarged 1.25 times the initial size from the center of the picture.

When making other operation, resize mode will be cancelled.

Notes

- You may not change the picture size depending to the signal.
- Distances of VGA and SVGA signals may be slightly inferior in quality at the initial size because they are enlarged.

OPERATING THE COMPUTER BY THE REMOTE CONTROL

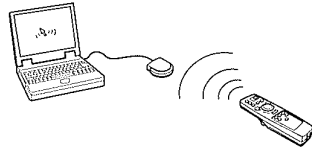

If you connect the infrared remote sensor unit to the computer, the supplied remote control can work as a mouse of the computer.

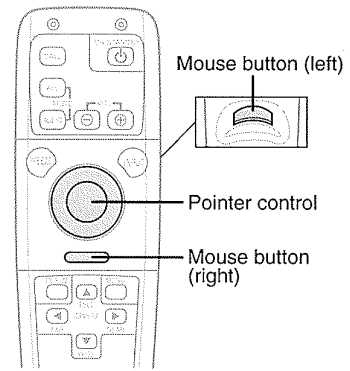

Connecting the Infrared Remote Sensor Unit

Check that the power of the computer is turned off.

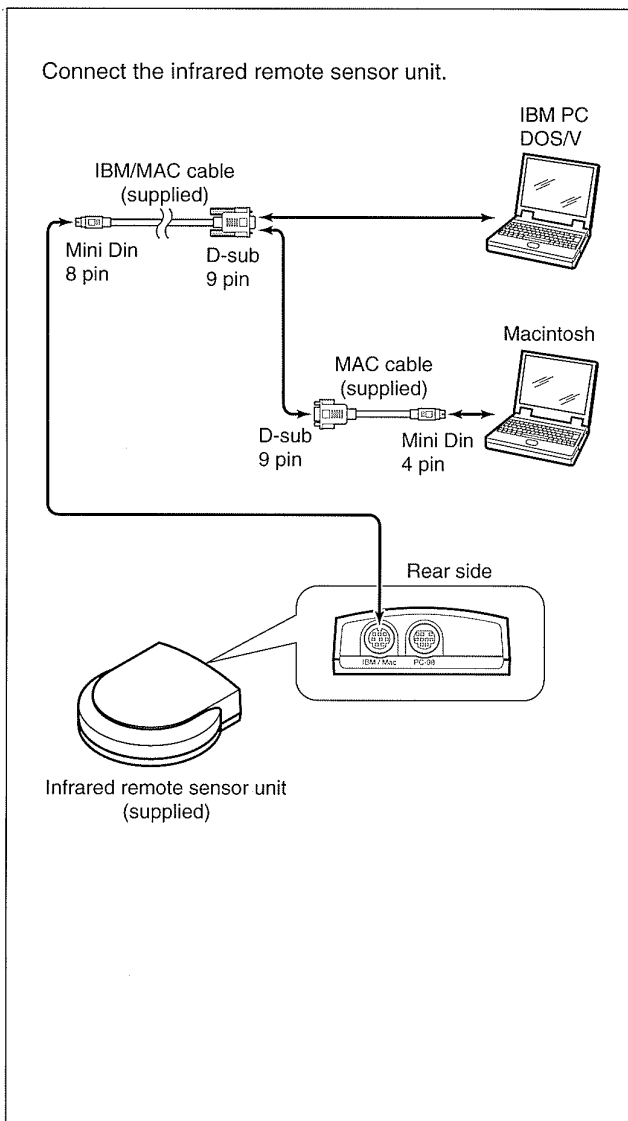

Operating the Computer by the Remote Control

Press the remote control button facing to the infrared remote sensor unit.

To move the pointer



Press the pointer control!

The pointer moves to the pressed direction.

Example

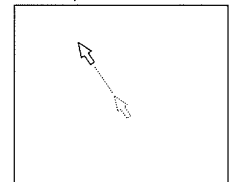

To click



Press the mouse button (left).

The pointer clicks.

To right-click



Press the mouse button (right).

The pointer right-clicks.

Note

To operate the projector and the computer by the remote control, place the infrared remote sensor unit close to the projector.

Notes

- The remote control operating range is about 5 meter from the front of the remote sensor.
- The remote control may not operate when there is sunlight or other strong light such as a fluorescence lamp shining on the remote sensor.

SELECTING THE DISPLAY LANGUAGE

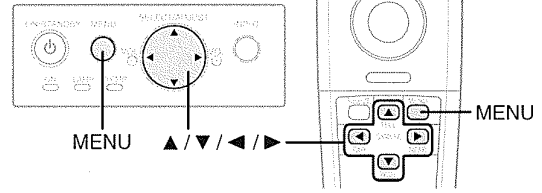
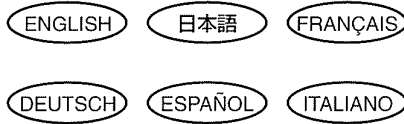

You can select the display language.
This owner's manual explains using an instance where English is selected.

Selecting the Display Language

Display the image as explained in "PICTURE PROJECTION".

1 **Press MENU.**
The menu is displayed.
It automatically disappears after about 10 seconds if no button is pressed.

"CAMERA" is displayed only on the document imaging camera model.

EXIT	
▲	
VIDEO	CONTRAST 0
PANEL	BRIGHT 0
MODE	COLOR 0
LANGUAGE	TINT 0
CAMERA	SHARP. 0
◁ : SELECT MENU : ENTER	

2 **Press ▲ / ▼ to select "LANGUAGE".**
The selecting items of language are listed.
A mark will be shown at the current adjusted language.

EXIT	
▲	
VIDEO	ENGLISH
PANEL	日本語
MODE	FRANÇAIS
LANGUAGE	DEUTSCH
	ESPAÑOL
	ITALIANO
◁ : SELECT MENU : ENTER	

3 **Press ►.**
The selecting bar moves to the list of the selecting items.

SAVE EXIT RESET	
▲	
VIDEO	ENGLISH
PANEL	日本語
MODE	FRANÇAIS
LANGUAGE	DEUTSCH
	ESPAÑOL
	ITALIANO
◁ : SELECT MENU : ENTER	

4 **Press ▲ / ▼ to select a language and press MENU.**
The menu is displayed in the selected language.

Example : When selecting ENGLISH

SAVE EXIT RESET	
▲	
VIDEO	ENGLISH
PANEL	日本語
MODE	FRANÇAIS
LANGUAGE	DEUTSCH
	ESPAÑOL
	ITALIANO
◁ : SELECT MENU : ENTER	

5 **Press ▲.**

SAVE EXIT RESET	
▼	
VIDEO	ENGLISH
PANEL	日本語
MODE	FRANÇAIS
LANGUAGE	DEUTSCH
	ESPAÑOL
	ITALIANO
◁ : SELECT MENU : ENTER	

6 **To exit from the menu, press ◀ / ▶ to select "EXIT" and press MENU.**
The menu disappears.

- If you select "SAVE", the setting is memorized and stored in memory even after you turn the power off.

Notes

- Even if you do not have the settings saved, they are stored until you turn the power off.
- If you select "RESET" and press the MENU button, the default setting of ENGLISH returns.
- If you select "SAVE" and press the MENU button, it will not only save the current adjusting item's value. It will save all the adjusting item's value.

PICTURE DETAIL ADJUSTMENTS

Adjustment items	
CONTRAST	Contrast
BRIGHT	Brightness
COLOR	Color
TINT	Tint
SHARP	Sharpness

Explains how to adjust the projected picture quality.

Adjusting the Picture Details

- Display the image as explained in "PICTURE PROJECTION".
- Select the picture source to adjust with the INPUT button.

1 **Press MENU.**
The MENU is displayed.
It automatically disappears after about 10 seconds if no button is pressed.

EXIT	
VIDEO	CONTRAST 0
PANEL	BRIGHT 0
MODE	COLOR 0
LANGUAGE	TINT 0
	SHARP 0

⇐ : SELECT MENU : ENTER

2 **Press ▲ / ▼ to select "VIDEO".**
The adjustment items of VIDEO are listed.

EXIT	
VIDEO	CONTRAST 0
PANEL	BRIGHT 0
MODE	COLOR 0
LANGUAGE	TINT 0
	SHARP 0

⇐ : SELECT MENU : ENTER

3 **Press ►.**
The selecting bar moves to the list of the adjustment items.

SAVE EXIT RESET	
VIDEO	CONTRAST 0
PANEL	BRIGHT 0
MODE	COLOR 0
LANGUAGE	TINT 0
	SHARP 0

⇐ : SELECT MENU : ENTER

4 **Press ▲ / ▼ to select an item, and press MENU adjustment.**
Each menu is displayed.

When selecting "CONTRAST"

BACK SAVE EXIT RESET	
CONTRAST 0	

⇐ : SELECT MENU : ENTER

When selecting "BRIGHT"

BACK SAVE EXIT RESET	
BRIGHT 0	

When selecting "COLOR"

BACK SAVE EXIT RESET	
COLOR 0	

When selecting "TINT"

BACK SAVE EXIT RESET	
TINT 0	

When selecting "SHARP"

BACK SAVE EXIT RESET	
SHARP 0	

Notes

- TINT and SHARP adjustments are available only for NTSC signals, not for PAL nor SECAM signals.
- Only CONTRAST and BRIGHT adjustments are possible when RGB input is selected.
- Items which cannot be adjusted is displayed as "----".
- The adjustment can be saved on each INPUT source (VIDEO ,RGB, CAMERA.)

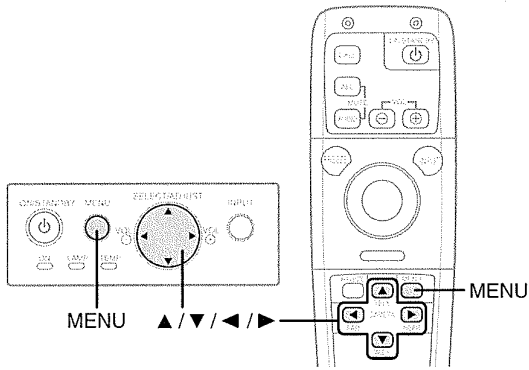

5 Adjust the item using ◀ / ▶.

Example: CONTRAST

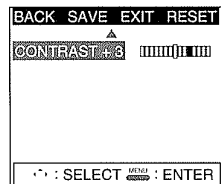

	-	+
CONTRAST	Lower	Higher
BRIGHT	Darker	Brighter
COLOR	Duller	Brighter
TINT	Redder	Greener
SHARP	Softer	Sharper

Press ▲.

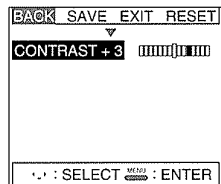

7 To exit from the menu, press ◀ / ▶ to select "EXIT" and press MENU.

The menu disappears.
 • If you select "SAVE", the setting values are memorized and stored in memory even after you turn the power off.



Notes

- Even if you do not have the adjustments saved, they are stored until you turn the power off.
- If you select "BACK" and press the MENU button, you will return to the previous menu.
- If you select "RESET" and press the MENU button, the value returns to the center.
- If you select "SAVE" and press the MENU button, it will not only save the current adjusting item's value. It will save all the adjusting item's value.

PROJECTION DETAIL ADJUSTMENTS

Adjustment items

- V-POSITION..... Vertical shift
- H-POSITION Horizontal shift
- PHASE Phase
- CLOCK Clock frequency

Explains how to adjust the projection details.

The projector identifies the model of the input source automatically and adjusts the projection details appropriately. If the picture still flickers or is blurred or losing the positional balance beyond the adjustment, this procedure is required.

Adjusting the Projection Details

- Display the image as explained in "PICTURE PROJECTION". 
- Select the picture source to adjust with the INPUT button.

1  **Press MENU.**
The menu is displayed.
It automatically disappears after about 10 seconds if no button is pressed.

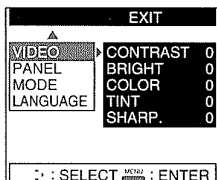

2  **Press ▲ / ▼ to select "PANEL".**
The adjustment items of PANEL are listed. Automatically identified signal mode and its value will be displayed.

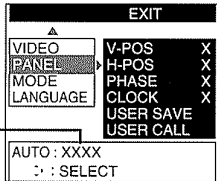

3  **Press ►.**
The selecting bar moves to the list of the adjustment items.

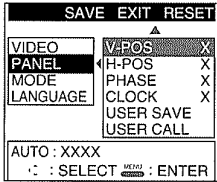

4  **Press ▲ / ▼ to select an adjust item, and press MENU.**
Each menu is displayed.

When selecting "V-POSITION"

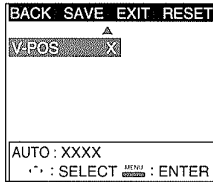

When selecting "H-POSITION"





When selecting "PHASE"



When selecting "CLOCK"



When selecting "USER-SAVE": up to 5 different adjusting value, other than the automatically identified value can be saved. 

When selecting "USER-CALL": the saved setting values are called up. 

Notes

- If you project a picture from a computer with an LCD screen while monitoring the picture on the computer, the picture may not be projected properly, depending on the computer model. In this case, turn off the computer display, or make the necessary picture adjustments on the projector. For details on controlling the computer display, etc, refer to the computer's manual and description on the software for the computer used.
- When adjusting V-POS and H-POS values, the picture may not be projected properly.
- While using, an aberration of the phase may occur. In that case, make the PHASE adjustment again.

PICTURE ORIENTATION SETTING

CAUTION

- When a ceiling mount is required, please consult with the dealer. (Always use the specially designed ceiling fixture "TLPTK3".) For more details, refer to the instruction manual attached to the ceiling fixture.
- If you use the projector mounted on the ceiling, ask the dealer to clean the filter and replace the lamp, etc, for your own safety.

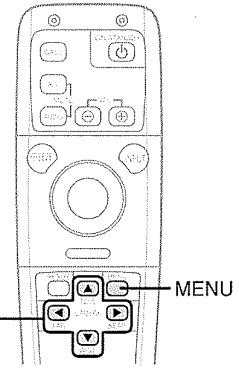
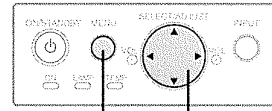

By inverting the picture, various projector installations are possible to meet the room conditions.

Setting the Picture Orientation

Display the image as explained in "PICTURE PROJECTION".

Location of the screen and projector	Setting
<p>Floor-mounted front projection</p> <p>Viewing a picture projected on the front of the screen from a floor.</p>	STD
<p>Floor-mounted rear projection</p> <p>Viewing a picture projected through the back of the screen from a floor installation.</p>	REA
<p>Ceiling-mounted front projection</p> <p>Always make sure the document imaging camera is stored securely when mounting the projector on the ceiling.</p> <p>Viewing a picture projected on the front of the screen from a ceiling installation.</p>	CEI
<p>Ceiling-mounted rear projection</p> <p>Always make sure the document imaging camera is stored securely when mounting the projector on the ceiling.</p> <p>Viewing a picture projected through the back of the screen from a ceiling installation.</p>	R.C

1 **Press MENU.**
The menu is displayed. It automatically disappears after about 10 seconds if no button is pressed.

2 **Press ▲ / ▼ to select "MODE".**
The setting items of MODE are listed.

3 **Press ►.**
The selecting bar moves to the list of the setting items.

```

SAVE EXIT RESET
VIDEO WIDE OFF
PANEL MIC OFF
MODE OSD-MUTE OFF
LANGUAGE PROJECT STD
: SELECT : ENTER
    
```

4 **Press ▲ / ▼ to select "PROJECT", and press MENU.**

```

BACK SAVE EXIT RESET
PROJECT STD
    
```

5 **Press ◀ / ▶ to select the required orientation, and press ▲. (Refer to left chart)**

(STD ◀ REA ▶ CEI ▶ R.C)

```

BACK SAVE EXIT RESET
PROJECT REA
: SELECT : ENTER
    
```

6 **To exit from the menu, press ◀ / ▶ to select "EXIT" and press MENU.**
The menu disappears.

- If you select "SAVE", the setting is memorized and stored in memory even after you turn the power off.

Notes

- Even if you do not have the adjustments saved, they are stored until you turn the power off.
- If you select "BACK" and press the MENU button, you will return to the previous menu.
- If you select "RESET" and press the MENU button, the setting value returns to "STD".
- If you select "SAVE" and press the MENU button, it will not only save the current adjusting item's value. It will save all the adjusting item's value.

WIDE SCREEN SETTING

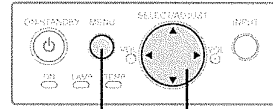
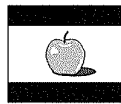

MENU

▲/▼/◀/▶

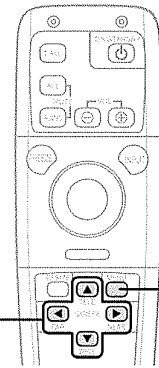

MENU

Can make the VIDEO input picture to a wide screen picture.

Setting the Wide Screen

Display the image as explained in "PICTURE PROJECTION".

1 **Press MENU.**
The menu is displayed. It automatically disappears after about 10 seconds if no button is pressed.

EXIT	
▲	
VIDEO	CONTRAST 0
PANEL	BRIGHT 00
MODE	COLOR 00
LANGUAGE	TINT 00
	SHARP. 0
◁ : SELECT MENU : ENTER	

2 **Press ▲ / ▼ to select "MODE".**
The setting items of MODE are listed.

EXIT	
▲	
VIDEO	WIDE OFF
PANEL	MIC OFF
MODE	CSD MUTE OFF
LANGUAGE	PROJECT STD
◁ : SELECT MENU : ENTER	

3 **Press ▶.**
The selecting bar moves to the list of the setting items.

SAVE EXIT RESET	
▲	
VIDEO	WIDE OFF
PANEL	MIC OFF
MODE	CSD MUTE OFF
LANGUAGE	PROJECT STD
◁ : SELECT MENU : ENTER	

4 **Press ▲ / ▼ to select "WIDE", and press MENU.**

BACK SAVE EXIT RESET	
▲	
WIDE	OFF
◁ : SELECT MENU : ENTER	

5 **Press ◀ / ▶ to select "ON" or "OFF", and press ▲.**

(OFF ON)
OFF: Not in wide mode.
ON: In wide mode.

BACK SAVE EXIT RESET	
▼	
WIDE	ON
◁ : SELECT MENU : ENTER	

6 **To exit from the menu, press ◀ / ▶ to select "EXIT" and press MENU.**
The menu disappears.
• "WIDE ON" can not be saved.

ADJUSTMENTS

Notes

- If you select "BACK" and press the MENU button, you will return to the previous menu.
- If you select "RESET" and press the MENU button, the setting value returns to "WIDE OFF".

MICROPHONE SETTING

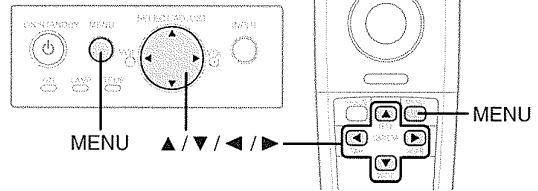
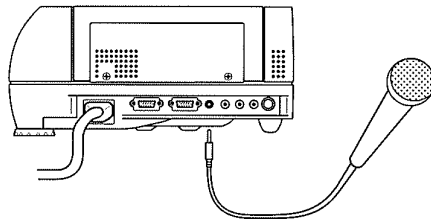

When using a microphone, the microphone setting has to be set "ON".

Setting the Microphone

- Connect a microphone to the AUDIO/MIC INPUT jack.
- Display the image as explained in "PICTURE PROJECTION".

1 **MENU** **Press MENU.**
The menu is displayed.
It automatically disappears after about 10 seconds if no button is pressed.

EXIT	
VIDEO	CONTRAST 0
PANEL	BRIGHT 0
MODE	COLOR 0
LANGUAGE	TINT 0
	SHARP. 0

• : SELECT MENU : ENTER

2 **Press ▲ / ▼ to select "MODE".**
The setting items of MODE are listed.

EXIT	
VIDEO	WIDE OFF
PANEL	MIC OFF
MODE	OSD MUTE OFF
LANGUAGE	PROJECT STD

• : SELECT MENU : ENTER

3 **Press ►.**
The selecting bar moves to the list of the setting items.

SAVE EXIT RESET	
VIDEO	WIDE OFF
PANEL	MIC OFF
MODE	OSD MUTE OFF
LANGUAGE	PROJECT STD

• : SELECT MENU : ENTER

4 **Press ▲ / ▼ to select "MIC", and press MENU.**

BACK SAVE EXIT RESET
MIC OFF

• : SELECT MENU : ENTER

5 **Press ◀ / ▶ to select "ON" or "OFF", and press ▲.**
(OFF → ON)
OFF: not using a microphone.
ON: using a microphone.

BACK SAVE EXIT RESET
MIC ON

• : SELECT MENU : ENTER

6 **To exit from the menu, press ◀ / ▶ to select "EXIT" and press MENU.**
The menu disappears.
• "MIC ON" can not be saved.

Notes

- If you select "BACK" and press the MENU button, you will return to the previous menu.
- If you select "RESET" and press the MENU button, the setting value returns to "MIC OFF".
- If you set "MIC" to "ON", the microphone input keeps priority regardless of the selected input source.
- Set "MIC" to "OFF" when not using a microphone.
- Use a dynamic type (monaural) microphone.

SETTING OSD (ON SCREEN DISPLAY) MUTE FUNCTION

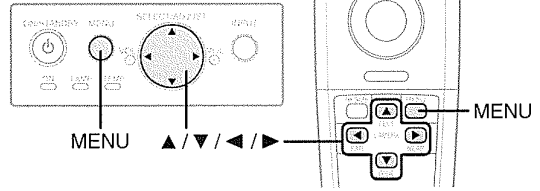
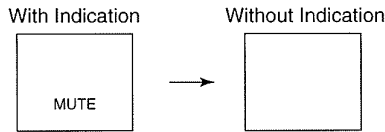

You can keep the on-screen displays (OSD) off even while switching the input sources ("VIDEO", "RGB") or losing then ("NO-SIGNAL"), or cutting off the picture and sound ("MUTE").

Setting OSD MUTE

Display the image as explained in "PICTURE PROJECTION" . 17

1 Press **MENU**.

The menu is displayed. It automatically disappears after about 10 seconds if no button is pressed.

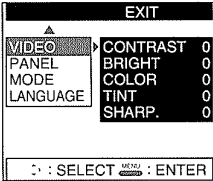

2 Press **▲ / ▼** to select **"MODE"**.

The setting items of MODE are listed.

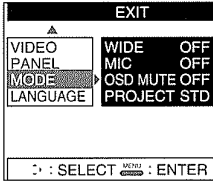

3 Press **▶**.

The selecting bar moves to the list of the setting items.

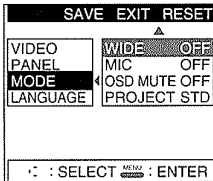

4 Press **▲ / ▼** to select **"OSD MUTE"**, and press **MENU**.

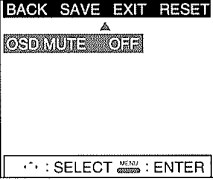

5 Press **◀ / ▶** to select **"ON" or "OFF"**, and press **▲**.

(OFF → ON)
 OFF: not making OSD to Mute.
 ON: making OSD to Mute.



6 To exit from the menu, press **◀ / ▶** to select **"EXIT"** and press **MENU**.

The menu disappears.

- If you select "SAVE", the setting values are memorized and stored in memory even after you turn the power off.

ADJUSTMENTS

Notes

- Even if you do not have the adjustments saved, they are stored until you turn the power off.
- If you select "BACK" and press the MENU button, you will return to the previous menu.
- If you select "RESET" and press the MENU button, the setting value returns to "OSD MUTE OFF".
- If you select "SAVE" and press the MENU button, it will not only save the current adjusting item's value. It will save all the adjusting item's value.

PROJECTING IMAGES WITH THE DOCUMENT IMAGING CAMERA

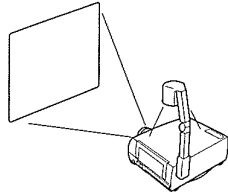

On the document imaging camera model, you can project pictures using the document imaging camera. The document imaging camera can directly project any materials (documents, illustrations etc.) without using an OHP film.

Caution

When using the camera, be careful to not pinch your hand or fingers into the arm.

Projecting Images with the Document Imaging Camera

- Adjust the focus between the projector and screen by turning the focus ring as needed.
- Adjusting the focus is easier if done while pressing the MENU button and displaying the menu.

1

Open the rear cover.

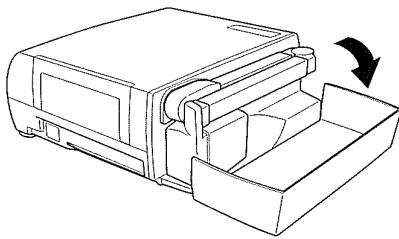

2

Raise up the arm.

Pull up the arm until it clicks and be fixed.

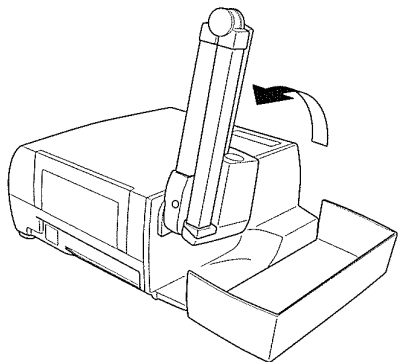

3

Stretch the arm.

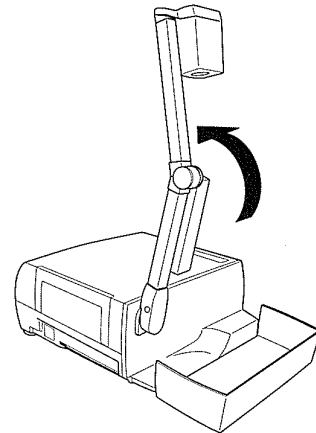

4

Turn the camera head unit.

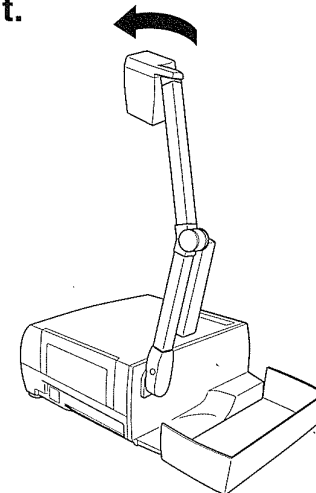

Note

- Never give shocks or impacts to the camera or arm as this may cause breakdowns.
- While raising up the arm in step 3, be careful to not hit your face or your body.

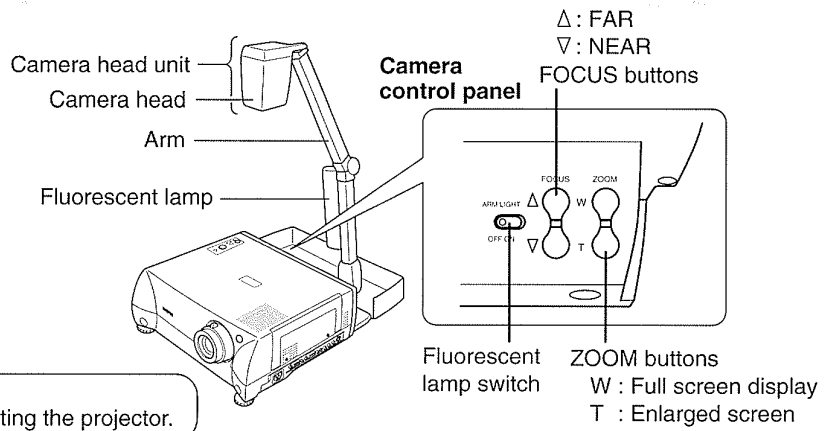

Caution

Do not look into the projection lens while operating the projector.

5 Place the document (text, illustration) you want to show, onto the projector.

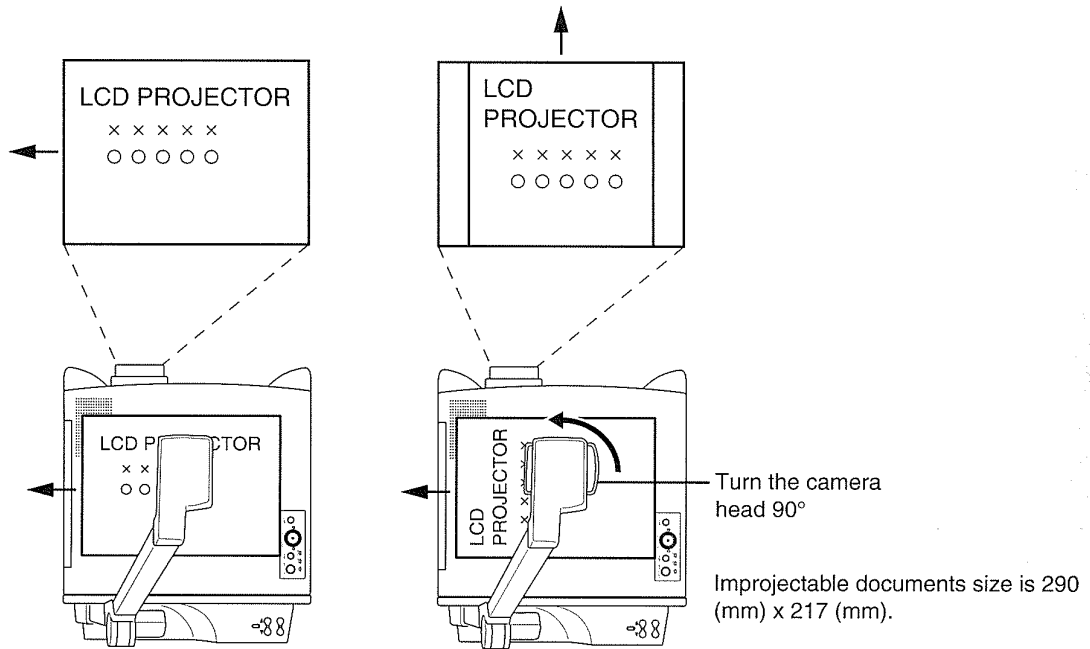

Turn the camera head to the direction of the projected material.



Turn on the fluorescent light switch.

Turn the fluorescent light on to illuminate the document.
When set to ON the fluorescent light automatically lights up or turns off when the arm is raised or lowered.

CAMERA

Note

When projecting a transparent draft such as an OHP film or small size data such as a name card, etc., use the projector with the accessory Pad placed.

PROJECTING IMAGES WITH THE DOCUMENT IMAGING CAMERA (CONTINUED)

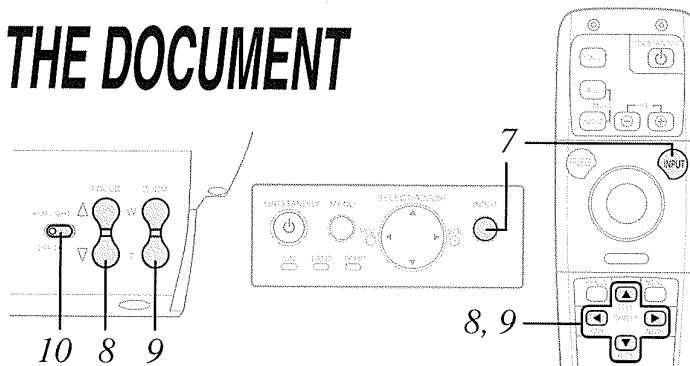

Projecting Images with the Document Imaging Camera (Continued)

7 **INPUT**

Select "CAMERA" by pressing INPUT.

CAMERA

The input source is switched each time you press the button.

VIDEO → RGB → CAMERA

8 **◀ ▶ (FAR/NEAR)**

Press **◀ / ▶ (FAR/NEAR)** to focus.

First enlarge the picture to the maximum using the ▲ (TELE) button, and adjust the focus.

The FOCUS buttons on the camera control panel are available as well.

Adjust the focus of the main unit previously.

9 **▲ ▼ (TELE/WIDE)**

Press **▲ / ▼ (TELE/WIDE)** to adjust the size of the picture.

The ZOOM buttons on the camera control panel are available as well.

10 **ARM LIGHT**

OFF ON

When finished, turn off the fluorescent light, and return the camera and arm to the original position.

Follow steps 1 to 4 in inverse.

Set the camera head on its original position.

Lay down the arm while pressing the button on the base of the arm.

If the button is hard to press, slightly move the arm up and down to press the button.

Button

Document imaging camera OUT-PUT jack

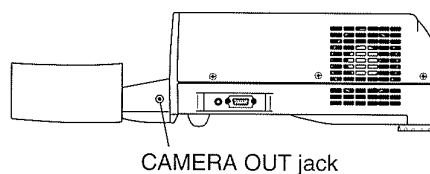

The CAMERA OUT jack outputs pictures on the document imaging camera in the PAL signal.

Notes

- When the arm is not raised up, the input source won't switch to "CAMERA".
- Connecting a capture card to the CAMERA OUT jack, you can export pictures on the document imaging camera to a computer.
- Once the fluorescent light is lit, it will stay on (lit) while the fan is running, even if the power is turned off with the ON/STANDBY button. The fluorescent light is off when the fan stops.

ADJUSTING THE DOCUMENT IMAGING CAMERA

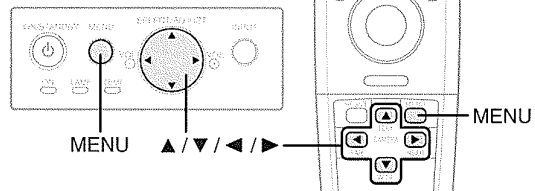
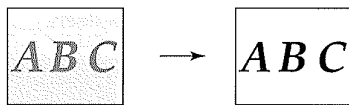

Explains how to adjust the exposure or switch the level of sensitivity.

Adjusting the Exposure/Setting the Sensitivity

If the projected document is dark, adjust the exposure to "+". If the projected document is too bright, adjust the exposure to "-". In the darkened projection room, you can get a better view by raising the sensitivity.

- 1** **PRESS MENU.**
The menu is displayed.
It automatically disappears after about 10 seconds if no button is pressed.
- 2** **PRESS ▲ / ▼ TO SELECT "CAMERA".**
The adjustment items of camera are listed.

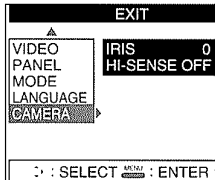
- 3** **PRESS ►.**
The selecting bar moves to the selecting items of CAMERA.

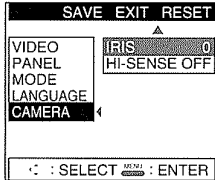

- 4** **PRESS ▲ / ▼ TO SELECT ADJUSTMENT ITEM, AND PRESS MENU.**
IRIS: To adjust the exposure.
HI-SENSE: To set the sensitivity.

- 5** **(When selecting IRIS.)**
PRESS ◀ / ▶ TO ADJUST THE EXPOSURE, AND PRESS ▲.

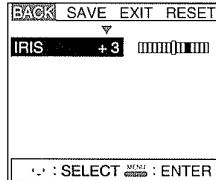
+: OPEN
-: CLOSE

- (When selecting HI-SENSE.)**
PRESS ◀ / ▶ TO SELECT "ON" OR "OFF", AND PRESS ▲.

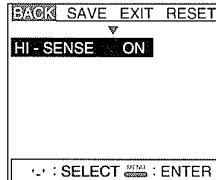
(OFF → ON)
OFF: Standard
ON: High sensitivity

- 6** **TO EXIT FROM MENU, PRESS ◀ / ▶ AND SELECT "EXIT" AND PRESS MENU.**
The menu disappears.

 - If you select "SAVE", the setting values are memorized and stored in memory even after you turn the power off.

Notes

- Even if you do not have the settings saved, they are stored until you turn the power off.
- If you select "BACK" and press the MENU button, you will return to the previous menu.
- If you select "RESET" and press the MENU button, the adjustment value returns to default.
- If you select "SAVE" and press the MENU button, it will not only save the current adjusting item's value. It will save all the adjusting item's value.
- When raising the sensitivity some afterimages and noises may be produced.
- While the high sensitivity is on, picture from the camera output jack may flicker.

TROUBLE INDICATIONS

If there is some problem inside the projector, the indicators light up or flash.

Troubleshooting

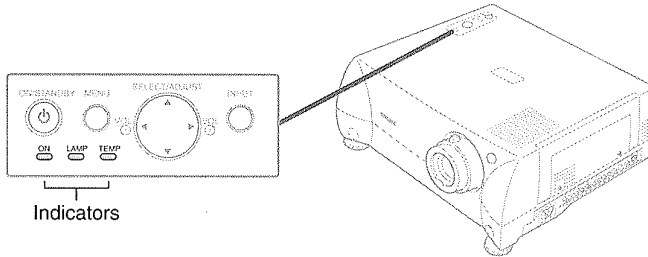

Indicators			Symptom and cause	Solutions
ON	LAMP	TEMP		
off	–	–	The power does not come on. → Malfunction of the unit.	Unplug the power cord and call the dealer.
Lit (Red)	–	–		
Lit (Red)	Lit (Red)	–	The lamp turns off or does not light up.	<ul style="list-style-type: none"> Lamp's life length is over, replace the lamp with new one. 37 Unplug the power cord and call the dealer.
Lit (Red)	–	Lit (Red)	The power turns off or does not come on. → The inside is too hot, or the projector has been working in an area of high temperature.	<ul style="list-style-type: none"> Place the projector correctly so the intake and exhaust fans' holes are not covered. Turn the projector off, and leave it for a while, and turn it on again. Clean the air filter. 36
Lit (Red)	–	Flashing (Red)	The power turns off or does not come on. → Trouble with the intake fan.	Unplug the power cord and call the dealer.
Lit (Red)	–	Flashing (Orange)	The power turns off or does not come on. → Trouble with the exhaust fan.	Unplug the power cord and call the dealer.
Lit (Red)	–	Flashing (Green)	The air filter cover is taken off.	Attach the cover correctly. 36

Note

Before attempting any maintenance, unplug the power cord.

AIR FILTER, LENS, AND MAIN UNIT CLEANING

Give a frequent clean especially to the air filter.
(The cleaning period is once per about 50 hours).

CAUTION

If you use the projector mounted on the ceiling, ask the dealer to carry out the maintenance such as cleaning.

Cleaning the Air Filter

The filter under the air filter cover is the device to shut out dusts or dregs.
Do not use the projector with the filter taken off.

1 Unplug the power cord.

2 Take off the air filter cover.

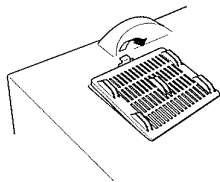

The filter is on the bottom side of the projector. Pull up the filter tabs.

3 Clean the air filter cover.

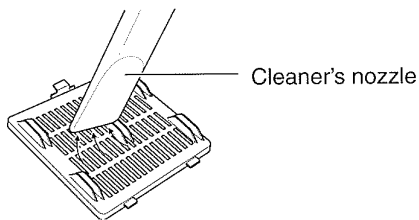

Remove dust and stains with a vacuum cleaner.

4 Attach the air filter cover.

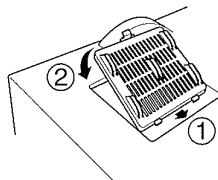

Cleaning the Lens

Use a blower or a lens cleaner to clean the lens.
Never rub or tap the lens with a hard object as the lens surface is fragile.

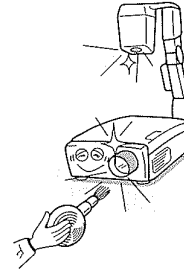

Cleaning the Main Unit

- Pull out the power cord before cleaning.
- Use a soft cloth to wipe off stains from the surface.
- To remove difficult stains, use a soft cloth slightly moistened with a weak solution of synthetic detergent and water, sand finish with a soft, dry cloth.

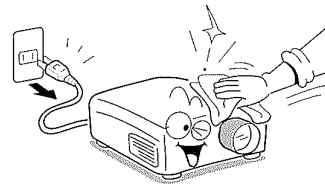

Note on Intake and Exhaust Fans

To maintain the efficiency of the projector, replace the intake and exhaust fans about every two to three years.
Ask the dealer for the replacement.

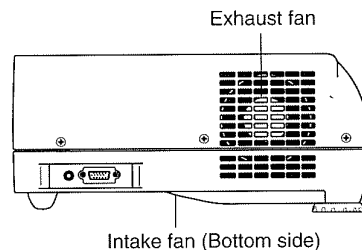

Notes

- When the air filter is dusty, the ventilation is impaired. This causes the temperature inside the projector to rise, and may damage the unit.
- Attach the air filter cover firmly after the cleaning. If it is not set correctly, the projector power will not be turned on.

LAMP REPLACEMENT

The lamp will eventually begin to project dark or dull pictures and finally will not light up. (Lamp's life length depends on the use condition.) In such a case, replace the lamp with new one.

CAUTION

If you use the projector mounted on the ceiling, ask the dealer to carry out the maintenance such as cleaning or replacement of the lamp.

Replacing the Lamp

CAUTION

- The lamp is made of glass and is very fragile. Do not touch the lamp with your bare hands and do not jolt or damage it. Do not use an exhausted lamp.
- If you have been using the projector, the lamp will be very hot, and may cause burn injuries. Wait for the lamp to cool (for longer than 1 hour) before replacing it.

1 Unplug the power cord.

2 Wait until the lamp gets cold enough.

3 Take off the lamp cover on the bottom panel.

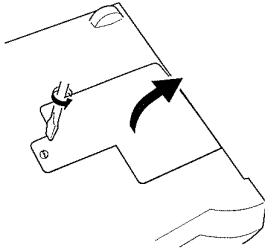

Loosen one screw, and pull off the lamp cover.

4 Pull out the lamp.

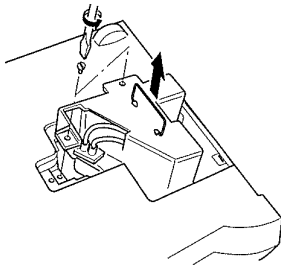

Loosen the two fixing screws, and lift up the handle to pull out the lamp.

5 Load a new lamp.

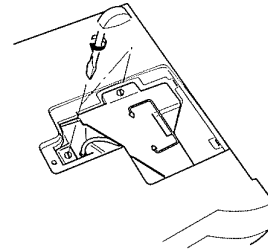

Replace the lamp facing the same direction, and tighten the two fixed screws.

6 Attach the lamp cover.

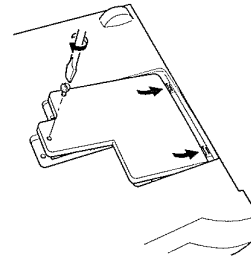

Slide the cover in place and tighten one screw.

7 Reset the lamp timer.

Refer to the lamp instructions for resetting.

When replacing, use lamp "TLPL2" (sold separately) for the exclusive use of this projector. For details, refer to the TLP2 instructions.

Notes

- The projector displays the total working time at every 1,000 hours. (Only when plugged in and turned on.)
- The lamp should be replaced if the total working time exceeds about 2,000 hours.
- Use a new lamp when replacing it.
- Attach the lamp cover firmly after replacing the lamp. If it is not set correctly, the power will not turn on.

FLUORESCENT LIGHT REPLACEMENT

If both ends of the fluorescent light are blackened or flickering, the light is worn out. Replace it.

Replacing the Fluorescent Light

CAUTION

If you have been using the projector, the fluorescent light will be very hot, and may cause burn injuries. Wait for the fluorescent light to cool before replacing it.

1 Unplug the power cord.

2 Remove the cover pressing the clips on it.

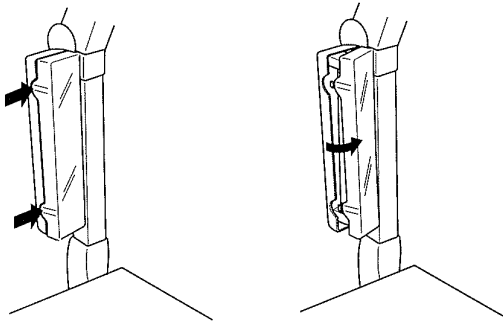

3 Rotate the fluorescent light and pull out the light towards you.

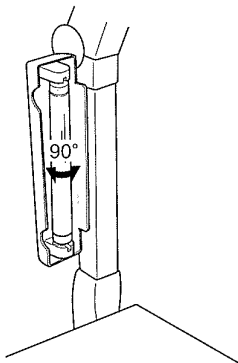

4 Install a new fluorescent light.

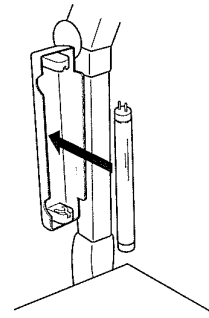

Turn the light 90° after inserting it.

5 Reinstall the cover.

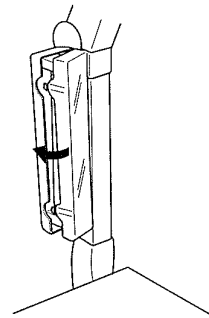

Fit it on as shown in the drawing.

Notes

- Use FL-4N for the fluorescent light.
- Even with a good fluorescent light, flickering may occur. In such a case, if you switch off, wait for a short while, then switch on again, the flickering should go away. (If the light blinks a few times or the flickering stops after the light is on for a few minutes, this is not a problem.)

BEFORE CALLING SERVICE PERSONNEL

Check the following points before asking for support service.

Symptoms and Solutions

Refer also to "TROUBLE INDICATIONS" 

Symptom	Cause	Solution	Reference page
The power does not come on.	The power cord is disconnected.	Firmly plug in the power cord.	16
	The lamp cover is not attached correctly.	Attach the cover correctly.	37
The power turns off while using the projector.	The ambient temperature of the projection room is too high.	Lower the ambient temperature of the projection room, and turn the power on.	–
No images appear.	The lens cover is on.	Take off the lens cover.	16
	The wrong input is selected.	Select the input source correctly with the INPUT button.	17
	The ALL MUTE mode is on.	Press the ALL MUTE button to restore the picture.	19
	The brightness adjustment is at its darkest.	Adjust the brightness.	23
	The source is not correctly connected to the projector.	Connect the source correctly to the projector.	13,14
No sounds are heard.	The wrong input is selected.	Select the input source correctly with the INPUT button.	17
	The AUDIO MUTE mode is on.	Press the AUDIO MUTE button to restore the sound.	19
	The sound volume is at the minimum.	Adjust the sound volume with the VOL buttons.	11
	The source is not correctly connected to the projector.	Connect the source correctly to the projector.	13,14
The images are blurred. Focusing is uneven.	The lens is dirty.	Clean the lens. Use a lens cleaner to clean the lens.	36
	The picture is out of focus.	Focus the picture.	18
	The projection distance is not appropriate.	Adjust the distance properly.	15
	The projecting light is not hitting the screen squarely.	Adjust the projecting direction so that the light hits the screen squarely.	15
	The brightness, contrast, sharpness or synchronization adjustments are not correct.	Adjust the picture.	23, 25

Symptom	Cause	Solution	Reference page
The pictures are dim.	The brightness or contrast adjustments are not correct.	Adjust the picture.	23
	The lamp life is ending.	Replace the lamp.	37
The colors are faint. The colors are strange.	The color or tint adjustments are not correct.	Adjust the picture.	23
	The lamp life is ending.	Replace the lamp.	37
Image does not appear when using the document imaging camera.	The wrong input is selected.	Select the correct input source with the INPUT button.	33
	Document to be projected is not positioned properly.	Place the document within the projectable range.	32
Image is out of focus or not clear when using the document imaging camera.	The lens is dirty.	Clean the lens. Use a lens cleaner to clean the lens.	36
	The document imaging camera is out of focus.	Focus the document imaging camera.	33
	Focus between main unit and screen is not correct.	Focus the picture by turning the focusing ring.	18
	Fluorescent light is not on. The image may not be projected clearly if the fluorescent light is not on.	Turn on the fluorescent light.	32
On-screen characters are not displayed.	OSD MUTE is set to ON.	Set OSD MUTE to OFF.	28
The remote control does not work.	The remote control is not facing the remote sensor.	Face the remote control transmitter toward the remote sensor on the projector.	12
	The remote control is too far.	Operate within about 5 meters.	12
	There is an obstruction between the remote control and the remote sensor.	Remove the obstacle.	-
	The batteries are exhausted.	Replace the batteries.	12

RGB INPUT SIGNAL

Signal Assignment

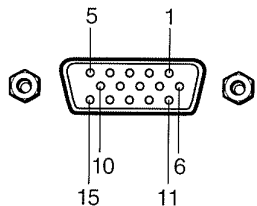

D-SUB 15 pin shrinking terminal

Input Signal

Video signal Analog
0.7V(p-p)
75Ω

Horizontal TTL level
synchronizing (positive/negative
signal polarity)

Vertical TTL level
synchronizing (positive/negative
signal polarity)

Composite TTL level
synchronizing
signal

Pin arrangements

Pin No.	
1	Video input (Red)
2	Video input (Green)
3	Video input (Blue)
4	N.C
5	GND
6	GND (Red)
7	GND (Green)
8	GND (Blue)
9	N.C
10	GND
11	GND
12	N.C
13	Horizontal synchronizing/composite synchronizing signal
14	Vertical synchronizing signal
15	N.C

Mode Determination and Signal System

Mode	Signal System	Frequency		Resolution Lines		Synchronizing		Default	Remarks
		Hor. (kHz)	Ver. (Hz)	Horizontal	Vertical	H/V			
NTSC	NTSC	15.734	59.940	664	483	N/N	⊙	VIDEO	
PAL	PAL	15.625	50.000	720	575	N/N	⊙	VIDEO	
PAL	CAMERA	15.625	50.000	720	575	N/N	⊙	CAMERA	
NEC24K	PC98 STANDARD	24.830	56.420	640	400	N/N	⊙	RGB	
TEXT70	VGA-350	31.470	70.090	640	400	N/P	⊙	RGB	
TEXT70	VGA-400	31.470	70.090	640	350	P/N	⊙	RGE	
TEXT85	VGA 85Hz-1	37.861	85.080	640	350	P/N	⊙	RGB	
TEXT85	VGA 85Hz-2	37.861	85.080	640	400	N/P	⊙	RGB	
VGA60	VGA 60Hz	31.470	59.940	640	480	N/N	⊙	RGB	
VGA72	VGA 72Hz	37.861	72.809	640	480	N/N	⊙	RGB	
VGA75	VGA 75Hz	37.500	75.000	640	480	N/N	⊙	RGB	
VGA85	VGA 85Hz-4	43.269	85.008	640	480	N/N	⊙	RGB	
MAC13	MAC-13"	35.000	66.667	640	480	-/-	⊙	RGB	
SVGA56	SVGA 56Hz	35.156	56.250	800	600	P/P	⊙	RGB	
SVGA60	SVGA 60Hz	37.879	60.317	800	600	P/P	⊙	RGB	
SVGA72	SVGA 72Hz	48.077	72.188	800	600	P/P	⊙	RGB	
SVGA75	SVGA 75Hz	46.875	75.000	800	600	P/P	⊙	RGB	
SVGA85	SVGA 85Hz	53.674	85.061	800	600	P/P	⊙	RGB	
MAC16	MAC-16"	49.724	74.550	832	624	-/-	⊙	RGB	
XGA60	XGA 60Hz	48.363	60.004	1024	768	N/N	⊙	RGB	
XGA70	XGA 70Hz	56.476	70.069	1024	768	N/N	⊙	RGB	
XGA75	XGA 75Hz	60.023	75.029	1024	768	P/P	⊙	RGB	
XGA85	XGA 85Hz	68.677	84.997	1024	768	N/N	⊙	RGB	
MAC19	MAC-19"	60.197	74.872	1024	768	N/N	⊙	RGB	

Notes

- If the mode identification does not define the mode described on the chart above, adjust to the projection details.
- If the mode identification is carried out correctly, a normal display may be not obtained depending on the signal frequency.
- The XGA 85 Hz is set to default adjustment but, it may not project properly. In that case, change the computer side output to XGA 75 Hz.
- SXGA signals can be projected since the projector has simplified compatibility with them. (However, letters and lines can be unequal or a part can be missing. Some signals may not be projected at all.)
- Some computers may have output modes which are not compatible with this projector. Check the compatibility of the connectors, signal levels, timing, and resolutions.

RGB INPUT SIGNAL (CONTINUED)

Signal Defaults

The following signals are factory set as defaults in each mode. However, some computers may have different timings than those in the chart. Make the necessary adjustments if the picture has flickers or is blurred.

Timing Chart

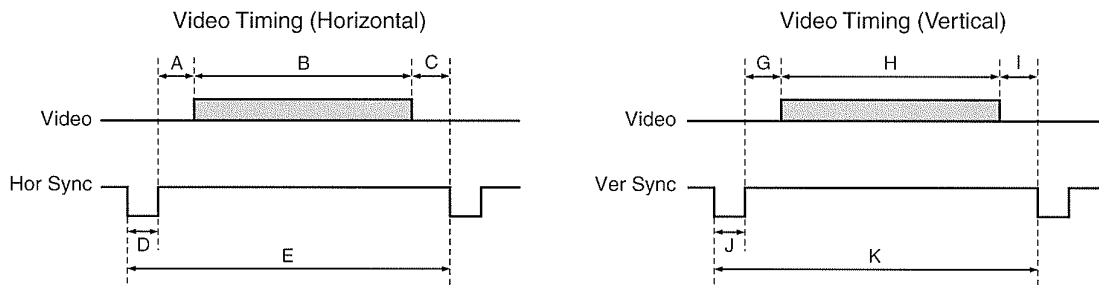

Timing Name	A (Pixels)	B (Pixels)	C (Pixels)	D (Pixels)	E (Pixels)	fh (kHz)	fv (Hz)	clock (MHz)	G (Lines)	H (Lines)	I (Lines)	J (Lines)	K (Lines)
24k(NEC24k) 640 x 400	85	640	59	64	848	24.830	56.420	21.053	25	400	7	8	440
VGA@60(VGA60) 640 x 480	48	640	16	96	800	31.470	59.940	25.175	33	480	10	2	525
VGA@350(TEXT70) 640 x 400	50	640	14	96	800	31.470	70.090	25.175	59	350	38	2	449
VGA@400(TEXT70) 640 x 350	50	640	14	96	800	31.470	70.090	25.175	34	400	13	2	449
VGA@72(VGA72) 640 x 480	128	640	24	40	832	37.860	72.810	31.500	28	480	9	3	520
VGA@75(VGA75) 640 x 480	120	640	16	64	840	37.500	75.000	31.500	16	480	1	3	500
VGA@85(TEXT85) 640 x 350	96	640	32	64	832	37.860	85.080	31.500	60	350	32	3	445
VGA@85(TEXT85) 640 x 400	96	640	32	64	832	37.860	85.080	31.500	41	400	1	3	445
VGA@85(VGA85) 640 x 480	80	640	56	56	832	43.270	85.010	36.000	25	480	1	3	509
Macintosh13'(M13) 640 x 480	96	640	64	64	864	35.000	66.670	30.240	39	480	3	3	525
SVGA@56(SVGA56) 800 x 600	128	800	24	72	1024	35.160	56.250	36.000	22	600	1	2	625
SVGA@60(SVGA60) 800 x 600	88	800	40	128	1056	37.880	60.320	40.000	23	600	1	4	628
SVGA@72(SVGA72) 800 x 600	64	800	56	120	1040	48.080	72.190	50.000	23	600	37	6	666
SVGA@75(SVGA75) 800 x 600	160	800	16	80	1056	46.880	75.000	49.500	21	600	1	3	625
SVGA@85(SVGA85) 800 x 600	152	800	32	64	1048	53.670	85.060	56.250	27	600	1	3	631
Macintosh16'(M16) 832 x 624	216	832	40	64	1152	49.720	74.550	57.283	39	632	1	3	667
XGA@60(XGA60) 1024 x 768	160	1024	24	136	1344	48.363	60.004	65.000	29	768	3	6	806
XGA@70(XGA70) 1024 x 768	144	1024	24	136	1328	56.476	70.069	75.000	29	768	3	6	806
XGA@75(XGA75) 1024 x 768	176	1024	16	96	1312	60.023	75.029	78.750	28	768	1	3	800
XGA@85(XGA85) 1024 x 768	208	1024	48	96	1376	68.677	84.997	94.500	36	768	1	3	808
Macintosh19'(MAC19) 1024 x 768	180	1024	20	96	1320	60.197	74.872	73.200	30	768	3	3	804

ADJUSTMENTS WITH RS-232C

Controlling Via the RS-232C Terminal

Conditioning of the Projection Unit can also be done by a computer via the RS-232C, as well as by the remote control.

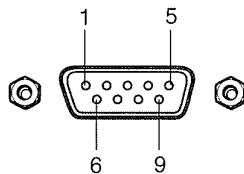

D-SUB 9 pin

Pin No.	Signal	Meaning
1	N.C	No connection
2	RXD	Receiving data
3	TXD	Sending data
4	DTR	Data terminal ready
5	GND	Signal ground
6	DSR	Data set ready
7	RTS	Request to send
8	CTS	Consent to send
9	N.C	No connection

Interface Format

The interface is established according to the following format.

1	Communication method	RS-232C No parity + 8DATA + 1 STOP bit
2	Data format	Command shall be composed of alphanumeric characters of ASCII description. Use only capital letters.
3	Speed	9600 bps
4	Communication format	STX (02h) Command (3Byte) ETX (03h) One command only can be used in one communication.
5	Return value	Acknowledge ACK (06h) Not Acknowledge NAK (15h)

Command List

(1) NORMAL COMMAND

Command	Original meaning of command	Meaning	Command	Original meaning of command	Meaning
PON	PowerON	Power ON.	POF	PowerOFF	Power OFF.
IN1	INput-1	Adjusts to INPUT-1 (RGB).	IN2	INput-2	Adjusts to INPUT-2 (VIDEO).
IN3	INput-3	Adjusts to INPUT-3 (CAMERA).			
VUP	Vol-UP	Volume UP.	VDW	Vol-DoWn	Volume down.
MON	MuteON	All mute ON.	MOF	MuteOFF	All mute off.
ADN	AudioON	Audio mute ON.	AOF	AudioOFF	Audio mute OFF.
DON	DisplayON	Displaying condition ON.	DOF	DisplayOFF	Displaying condition OFF.
FON	FreezeON	Freezing ON.	FOF	FreezeOFF	Freezing OFF.
RON	ResizeON	Resizing ON.	ROF	ResizeOFF	Resizing OFF.

(2) COMMON ADJUSTMENT

Command	Original meaning of command	Meaning	Command	Original meaning of command	Meaning
AUP	Adj-UP	Move adjusts item up.	ADW	Adj-DoWn	Move adjusts item down.
ALF	Adj-LeFt	Move adjusts item left. Adjusts value down.	ARG	Adj-RiGht	Move adjusts item right. Adjusts value up.
MNU	MeNU select	Select MENU. Execute item.			
DSV	DataSaVe	Save adjusts value.	DRS	DataReSet	Adjust value to default.

VIDEO ADJUSTMENT

Command	Original meaning of command	Meaning	Command	Original meaning of command	Meaning
VCN	Video-CoNtrast	Adjusts contrast balance.	VBR	Video-BRiGht	Adjusts brightness balance.
VCL	Video-CoLor	Adjusts color balance.	VTN	Video-TiNt	Adjusts tint balance.
VSH	Video-SHarp	Adjusts sharpness balance.			

(4) PANEL ADJUSTMENT

Command	Original meaning of command	Meaning	Command	Original meaning of command	Meaning
PVP	Panel-V-Pos	Adjusts of vertical position.	PHP	Panel-H-Pos	Adjusts of horizontal position.
PPH	Panel-PHase	Adjust of sample phase.	PCK	Panel-ClocK	Adjust of sample clock.
PSO	PanelSave0	Reset to user save.	PS1	PanelSave1	Save to user 1
PS2	PanelSave2	Save to user 2.	PS3	PanelSave3	Save to user 3
PS4	PanelSave4	Save to user 4.	PS5	PanelSave5	Save to user 5
PL0	PanelLoad0	Reset to user call.	PL1	PanelLoad1	Call from user 1
PL2	PanelLoad2	Call from user 2	PL3	PanelLoad3	Call from user 3
PL4	PanelLoad4	Call from user 4	PL5	PanelLoad5	Call from user 5

MODE ADJUSTMENT

Command	Original meaning of command	Meaning	Command	Original meaning of command	Meaning
WON	Wide-mode ON	Wide-mode ON.	WOF	Wide-0mode OFF	Wide-mode OFF.
CON	miC-sel ON	Mic mode ON.	COF	miC-0sel OFF	Mic-mode OFF.
OON	Osd-mute ON	OSD-mute ON.	OOF	Osd-mute OFF	OSD-mute OFF.
PJ0	ProJect0	Floor mounted front projection.	PJ1	ProJect1	Floor mounted rear projection.
PJ2	ProJect2	Ceiling mounted front projection.	PJ3	ProJect3	Ceiling mounted rear projection.

(6) LANGUAGE ADJUSTMENT

Command	Original meaning of command	Meaning	Command	Original meaning of command	Meaning
LEN	Lang. ENGLISH	Adjusts to English display.	LJP	Lang. JaPanese	Adjusts to Japanese display.
LFR	Lang. FRench	Adjusts to French display.	LGR	Lang. GeRman	Adjusts to German display.
LSP	Lang. SPanish	Adjusts to Spanish display.	LIT	Lang. ITalian	Adjusts to Italian display.

(7) CAMERA ADJUSTMENT

Command	Original meaning of command	Meaning	Command	Original meaning of command	Meaning
CZU	Cam-ZoomUp	Zoom wide.	CZD	Cam-ZoomDown	Zoom tele.
CFU	Cam-FocusUp	Focus near.	CFD	Cam-FocusDown	Focus far.
CSH	Cam-SenseHi	High Sensitivity ON.	CSL	Cam-Sense Lo	High sensitivity OFF.
CIR	Cam-IRis	Adjusts of IRIS.			

SPECIFICATIONS

SPECIFICATIONS

[Main Unit]

Power requirements	AC 100 – 240V 50/60Hz
Power consumption	TLP510: 205W (120V)
	TLP511: 210W (120V)
Mass	TLP510: 6.8 Kg
	TLP511: 8.2 Kg †
Dimensions	TLP510: 340 x 138 x 295 (mm) (W/H/D) (Including the projecting sections)
	TLP511: 340 x 138 x 365 (mm) (W/H/D) (Including the projecting sections)
Ambient environment	Temperature: 0°C to 35°C Humidity: 30% to 70% RH
Lamp	UHP lamp 120W
Speaker	1.5W (monaural)
RGB inputs	RGB signal (D-sub 15-pin) Audio: 1V(p-p), more than 22kΩ, ø35mm stereo mini jack
VIDEO inputs	S-video signal : Y input: 1V(p-p), 75Ω, negative synchronization (Mini DIN 4-pin) C input: 0.286V(p-p) (burst signal), 75Ω Video: 1V(p-p), 75Ω, negative synchronization, pin jack Audio: 1V(p-p), more than 22kΩ, pin jacks (L, R)
Outputs	RGB signal (D-sub 15-pin) Audio: 1V(p-p), less than 2.2kΩ, ø3.5mm stereo mini jack
CONTROL terminal	D-sub 9-pin (RS-232C)
Cabinet Material	ABS resin

[Liquid Crystal Display]

Projection system	3-pannels transmission
Panel size	1.3 inches
Driving system	TFT active matrix
Picture elements	786,432 (1024 x 768 dots) x 3

[Projection Lens]

Lens	Zooming lens F=2.5 – 3.0 f=50 – 70mm
Focusing	Manual operation
Zooming	Manual operation

[Document Imaging Camera]

Lens	F=1.8 – 2.3, f=5.8 – 17.4mm
Filming area	Max 290 (mm) horizontal, 217 (mm) vertical (WIDE)
Zoom	Motor-driven (Manual)
Focus	Motor-driven (Manual)
Iris	Auto/Lever adjustment allowed
TV signal	PAL
Image element	1/3 inch CCD
Total picture elements	480,000
Resolution	Horizontal 450, vertical 420
Lighting	4W fluorescent light
Output Terminal	Pin jack PAL signal

[Accessories]

Wireless remote control	1
AA size battery	2
Power cord	1
RGB cable	1
Adapter for Macintosh computers	1
Audio/video cable	1
Lens cover	1
Pad	1
Infrared remote sensor unit	1
IBM/MAC cable (for infrared remote sensor unit)	1
MAC cable (for infrared remote sensor unit)	1

The design and specifications are subject to change without notice.

Trademarks

NEC, PC-98 series are trademarks of NEC Corporation.

IBM, DOS/V, SXGA, VGA, S-VGA, XGA are trademarks or registered trademarks of International Business Machines Corporation.

Macintosh is a trademark of Apple Computer Inc.

LIMITED WARRANTY

TOSHIBA 3LCD Data Projector with document imaging camera

Toshiba America Consumer Products, Inc. (TACP) makes the following limited warranties. These limited warranties extend to the original end-user purchaser.

Limited one (1) Year Warranty of Parts and Labor

TACP warrants this product and its parts against defects in materials or workmanship for a period of one year after the date of original retail purchase.

For a period of one year after the date of original retail purchase, TACP will repair a defective product or a part, without charge to you.

This warranty also covers accessories of 3LCD Data Projector with document imaging camera.

This warranty period of the lamp is ninety (90) days.

Your Responsibility

The above warranties are subject to the following conditions.

1. You must retain your bill of sale or provide other proof of purchase.
2. You must make a written notification within thirty (30) days after your discovery of a defective product or part.
3. All warranty servicing of this product or parts must be made by TACP or a service facility authorized by TACP.
4. These warranties are effective only if the product is purchased and operated in the USA.
5. Labor service charges for installation and adjustment of customer controls are not covered by this warranty.
6. Warranties extend only to defects in materials or workmanship as limited above and do not extend to any product or parts which have been lost or discarded by you or to damage to products or parts caused by misuse, accident, improper installation, improper maintenance or use in violation of instructions furnished by us; or to units which have been altered or modified without authorized of TACP or to damage to product or parts thereof which have had the serial number removed, altered, defaced or rendered illegible.
7. If it is determined after investigation that the claimed problem was not covered with this warranty, you shall pay the cost of investigation at prevailing rate.

Step-by-step procedure how to obtain warranty service

To obtain warranty servicing, you should:

1. Read the owners manual thoroughly before operating.
2. Please contact your dealer for an immediate service and an advice.
3. If your dealer is not able to assist you, please contact TACP Service Center listed below or a servicing facilities authorized by TACP for a warranty service within thirty (30) days after you find a defective product or part.
4. Arrange for a delivery of the product to TACP Service Center or a servicing facilities authorized by TACP.
5. The shipment of the product must be insured safety and securely packed, preferably in the original carton or a carton with an equivalent protection. A letter explaining the defect and also a copy of the bill of sale or other proof of purchase must be enclosed. All transportation and insurance charges must be prepaid by you.
6. The repaired product is returned freight prepaid to the purchaser after warranty servicing.
7. If you have any questions about service, please contact the following TACP Service Center.

TACP is not obligated to provide purchasers with a substitute unit during the warranty period.

82 Totowa Rd., Wayne,
NJ 07470, U.S.A.

Phone: (201) 628-8000

Fax: (201) 628-1875

Toll Free for Service Call: 1-800-631-3811

TOSHIBA AMERICA CONSUMER PRODUCTS, INC.