

myprojectorlamps.com

**The most trusted, dependable name
in projector lamp sales.**



<http://www.myprojectorlamps.com>



<http://www.myprojectorlamps.ca>



<http://www.myprojectorlamps.eu>

The following projector manual has not been modified or altered in any way.

TOSHIBA

OWNER'S MANUAL

3LCD DATA PROJECTOR

TLP-T70M (XGA)

TLP-T71M (XGA / With Document Camera)

TLP-T60M (XGA)

TLP-T61M (XGA / With Document Camera)

TLP-S40 (SVGA)

TLP-S41 (SVGA / With Document Camera)

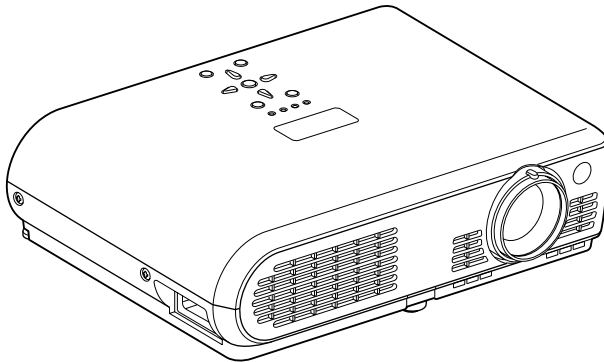

TLP-T70M / T60M / TLP-S40

Before Using

Preparations

Operations

Maintenance

Others

SAFETY PRECAUTIONS

<p>WARNING: BEFORE OPERATING, PLEASE READ OWNER'S MANUAL. DO NOT REMOVE SCREWS EXCEPT LAMP COVER SCREWS. DO NOT BLOCK VENTING OPENINGS.</p>	<p>THE RISK OF COMBUSTION FROM THE HOT BALLS, WHICH ARE USED TO ILLUMINATE THE UNIT, IS HIGH. THESE BALLS MAY NOT COOL SUFFICIENTLY TO PREVENT THE RISK OF COMBUSTION OF COVERINGS. EL RIESGO DE QUE EL APAREJO COMBUSTIONE EN SU CASILLERO A CAUSA DE LA ALTA TEMPERATURA DE LAS BOLSAS DE BILBORES ES ALTO.</p>
<p>AVIS: Veuillez lire le mode d'emploi avant l'usage. NE PAS RETIRER LES VIS AL'EXCEPTION DES VIS DU COUVERCLE DE LA LAMPÉ. NE BOCHEZ PAS LES OUVERTURES DE VENTILATION.</p>	<p>WARNING: VOR DEM EINSATZ DIE BEDIENUNGSANLEITUNG LESEN. KEINE SCHRAUBEN AUSSER DEN LAMPENDECKELSCHRAUBEN ENTFERNEN. LÜFTUNGSÖFFNUNGEN NICHT BLOCKIEREN.</p>
<p>警告: 操作前、必ず説明書をお読みください。 ランプカバーのネジを、必ず取り除く以外のネジを、取り除かないでください。 通気孔をふさがないでください。</p>	<p>警告: ご使用前必ず、取扱説明書をお読みください。 ランプカバー以外のネジを、取り除かないでください。 通気孔をふさがないでください。</p>
<p>声明: 此为 A 级产品, 在生活环境中, 该产品可能会造成无线电干扰。在这种情况下, 可能需要用户对干扰采取切实可行的措施。 23555888</p>	



The lightning flash with arrowhead symbol, within an equilateral triangle, is intended to alert the user to the presence of uninsulated "dangerous voltage" within the product's enclosure that may be of sufficient magnitude to constitute a risk of electric shock to persons.



The exclamation point within an equilateral triangle is intended to alert the user to the presence of important operating and maintenance (servicing) instructions in the literature accompanying the appliance.

WARNING: TO REDUCE THE RISK OF FIRE OR ELECTRIC SHOCK, DO NOT EXPOSE THIS APPLIANCE TO RAIN OR MOISTURE. DANGEROUS HIGH VOLTAGES ARE PRESENT INSIDE THE ENCLOSURE. DO NOT OPEN THE CABINET. REFER SERVICING TO QUALIFIED PERSONNEL ONLY.

WARNING: Handling the cord on this product or cords associated with accessories sold with this product, will expose you to lead, a chemical known to the State of California to cause birth defects or other reproductive harm. **Wash hands after handling.**

FCC Radio Frequency Interference Statement

Note: This equipment has been tested and found to comply with the limits for a Class A digital device, pursuant to part 15 of the FCC Rules. These limits are designed to provide reasonable protection against harmful interference when the equipment is operated in a commercial environment. This equipment generates, uses, and can radiates radio frequency energy and, if not installed and used in accordance with the instruction manual, may cause harmful interference to radio communications. Operation of this equipment in a residential area is likely to cause harmful interference in which case the user will be required to correct the interference at his own expense.

WARNING: Changes or modifications made to this equipment, not expressly approved by Toshiba, or parties authorized by Toshiba, could void the user's authority to operate the equipment.

Notice: This Class A digital apparatus complies with Canadian ICES-003. Cet appareil numérique de la classe A est conforme à la norme NMB-003 du Canada.

WARNING: This is a Class A product. In a domestic environment this product may cause radio interference in which case the user may be required to take adequate measures.

CAUTION: Laser beam is emitted when the laser button of the remote control is pressed. Do not look at the laser beam directly from the front of the remote control. Do not turn the laser beam toward a person or to a mirror.

IMPORTANT SAFETY INSTRUCTIONS

CAUTION: PLEASE READ AND OBSERVE ALL WARNINGS AND INSTRUCTIONS GIVEN IN THIS OWNER'S MANUAL AND THOSE MARKED ON THE UNIT. RETAIN THIS BOOKLET FOR FUTURE REFERENCE.

This set has been designed and manufactured to assure personal safety. Improper use can result in electric shock or fire hazard. The safeguards incorporated in this unit will protect you if you observe the following procedures for installation, use and servicing. This unit is fully transistorized and does not contain any parts that can be repaired by the user.

DO NOT REMOVE THE CABINET COVER, OR YOU MAY BE EXPOSED TO DANGEROUS VOLTAGE. REFER SERVICING TO QUALIFIED SERVICE PERSONNEL ONLY.

1. Read Owner's Manual

After unpacking this product, read the owner's manual carefully, and follow all the operating and other instructions.

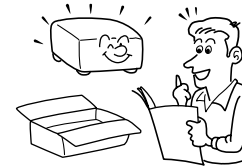

2. Power Sources

This product should be operated only from the type of power source indicated on the marking label. If you are not sure of the type of power supply to your home, consult your product dealer or local power company. For products intended to operate from battery power, or other sources, refer to the operating instructions.



3. Source of Light

Do not look into the lens while the lamp is on. The strong light from the lamp may cause damage to your eyes or sight.



4. Ventilation

Openings in the cabinet are provided for ventilation and to ensure reliable operation of the product and to protect it from overheating, and these openings must not be blocked or covered. The openings should never be blocked by placing the product on a bed, sofa, rug or other similar surface. This product should not be placed in a built-in installation such as a bookcase or rack unless proper ventilation is provided or the manufacturer's instructions have been adhered to.



IMPORTANT SAFETY INSTRUCTIONS (Continued)

5. Heat

The product should be situated away from heat sources such as radiators, heat registers, stoves, or other products (including amplifiers) that produce heat.

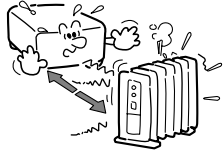

6. Water and Moisture

Do not use this product near water. - for example, near a bath tub, wash bowl, kitchen sink, or laundry tub; in a wet basement; or near a swimming pool and the like.

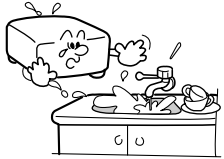

7. Cleaning

Unplug this product from the wall outlet before cleaning. Do not use liquid cleaners or aerosol cleaners. Use a soft cloth for cleaning.

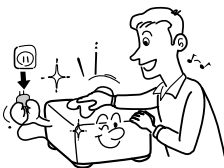

8. Power-Cord Protection

Power-supply cords should be routed so that they are not likely to be walked on or pinched by items placed upon or against them, paying particular attention to cords at plugs, convenience receptacles, and the point where they exit from the product.



9. Overloading

Do not overload wall outlets; extension cords, or integral convenience receptacles as this can result in a risk of fire or electric shock.



10. Lightning storms

For added protection for this product during storm, or when it is left unattended and unused for long periods of time, unplug it from the wall outlet. This will prevent damage to the product due to lightning and power-line surges.



11. Object and Liquid Entry

Never push objects of any kind into this product through openings as they may touch dangerous voltage points or short-out parts that could result in a fire or electric shock. Never spill liquid of any kind on the product.



12. Do not place the product vertically

Do not use the product in the upright position to project the pictures at the ceiling, or any other vertical positions. It may fall down and dangerous.

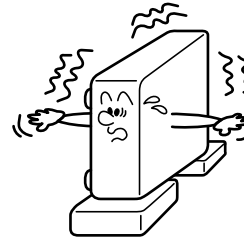

13. Stack Inhibited

Do not stack other equipment on this product or do not place this product on the other equipment. Top and bottom plates of this product develops heat and may give some undesirable damage to other unit.

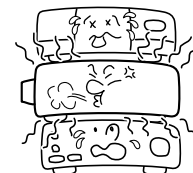

14. Attachments

Do not use attachments not recommended by the product manufacturer as they may cause hazards.

15. Accessories

Do not place this product on an unstable cart, stand, tripod, bracket, or table. The product may fall, causing serious injury to a child or adult, and serious damage to the product. Use only with a cart, stand, tripod, bracket, or table recommended by the manufacturer, or sold with the product. Any mounting of the product should follow the manufacturer's instructions, and should use a mounting accessory recommended by the manufacturer. A product and cart combination should be moved with care. Quick stops, excessive force, and uneven surfaces may cause the product and cart combination to overturn.



IMPORTANT SAFETY INSTRUCTIONS (Continued)

16. Damage Requiring Service

Unplug this product from the wall outlet and refer servicing to qualified service personnel under the following conditions:

- a) When the power-supply cord or plug is damaged.
- b) If liquid has been spilled, or objects have fallen into the product.
- c) If the product has been exposed to rain or water.
- d) If the product does not operate normally by following the operating instructions. Adjust only those controls that are covered by the operating instructions as an improper adjustment of other controls may result in damage and will often require extensive work by a qualified technician to restore the product to its normal operation.
- e) If the product has been dropped or damaged in any way.
- f) When the product exhibits a distinct change in performance - this indicates a need for service.

17. If glass components, including lens and lamp, should break, contact your dealer for repair service.

This product incorporates glass components, including a lens and a lamp. If such parts should break, please handle with care to avoid injury and contact your dealer for repair service. The broken pieces of glass may cause to injury. In the unlikely event of the lamp rupturing, thoroughly clean the area around the projector and discard any edible items placed in that area.

18. Servicing

Do not attempt to service this product yourself as opening or removing covers may expose you to dangerous voltage or other hazards. Refer all servicing to qualified service personnel.



19. Replacement Parts

When replacement parts are required, be sure the service technician has used replacement parts specified by the manufacturer or have the same characteristics as the original part. Unauthorized substitutions may result in fire, electric shock, or other hazards. (Replacement of the lamp only should be made by users.)

20. Safety Check

Upon completion of any service or repairs to this product, ask the service technician to perform safety checks to determine that the product is in proper operating condition.



21. Do not leave thermal-paper documents or easily deformed items on top of the unit or near the air exhaust for long periods of time.

The heat from the unit could erase the information on the thermal paper, or cause deformation or warping.

22. Do not get your hands between the camera arm and the main unit when setting the camera arm back in its original position. (Models equipped with document camera)

To avoid injury, be careful not to get your hands caught when setting the camera arm back in its original position. Families with children should be particularly careful.

23. Do not carry by the camera arm. (Models equipped with document camera)

Do not carry the projector by the camera arm. Doing so can result in damage or injury.

24. Do not move the projector while the arm is still erect. (Models equipped with document camera)

Always store the arm back in position when moving the projector. Otherwise injury or damage may result.

LABEL LOCATIONS

WARNING Label
WARNING: BEFORE CHECKING OR REPAIRING THE PROJECTOR, UNPLUG THE PROJECTOR FROM THE POWER SOURCE. TO PREVENT ELECTRIC SHOCK, DO NOT TOUCH ANY ELECTRICAL COMPONENTS WITH YOUR FINGER. USE OF THE PROJECTOR OR THE REMOTE CONTROL IS PROHIBITED WHEN THE PROJECTOR IS PLUGGED INTO THE AC POWER SOURCE.
WARNING: VOR DER BEWEGUNG VON VERTEILERN ODER DES WECHSELNS VON VERTEILERN SIE DIE PROJECTOR VON DER STEUERSOURCE ABZUFÜHREN. FÜHREN SIE KEINE BERÜHRUNGEN AN ELEKTRISSCHLÜSSELN UND VERTEILERN DURCH. ES VERBIBT, DAS PROJECTOR ODER DIE FERNBEDIENUNGSWECHSELN WÄHREND DER ANSCHLUSSE AN DIE STEUERSOURCE ZU VERWENDEN.

MODEL NO. / RATING Label
TOSHIBA LCD PROJECTOR PROJECTOR/LCD 投影机投影机
MODEL: 投影机 TLp-XXXX
PART NO: AC 300-XXXX-1, 1, 1, 1
製造 投影机 TLp-XXXX
TOSHIBA CORPORATION
UNIVERSAL
UL
ETL

SERIAL NO. Label
MANUFACTURED: []
SERIAL NO: []

CAUTION Label
CAUTION! HOT ATTENTION CHAUD ACHTUNG HEISS
注意 高温 予知 : 高温
CAUTION: DO NOT TOUCH THE LAMP WHEN IT IS HOT.
AVERTISSEMENT: NE PAS TOUCHER LA LAMPILLE QUAND ELLE EST CHAUDE.
警告: 投影机高温時にランプを触らないでください。
注意: 投影机高温時にランプを触らないでください。

LAMP REPLACEMENT CAUTION BEFORE REMOVING THE SCREEN, DISCONNECT FROM THE MAIN POWER SUPPLY. ALWAYS REMOVE THE FUSE COVER BEFORE REPLACING THE LAMP. HANDLE WITH CARE. RISK OF ELECTRICAL SHOCK OR DAMAGE TO THE LAMP.
PROJECTOR IS HOT TO REPLACE THE LAMP. ALWAYS REMOVE THE FUSE COVER BEFORE REPLACING THE LAMP. HANDLE WITH CARE. RISK OF ELECTRICAL SHOCK OR DAMAGE TO THE LAMP.
A WARNING LABEL IS ATTACHED TO THE LAMP. HANDLE WITH CARE. RISK OF ELECTRICAL SHOCK OR DAMAGE TO THE LAMP.
ACHTUNG! BEI LAMPENWECHSELN VOR DER WECHSELN VON VERTEILERN SIE DIE PROJECTOR VON DER STEUERSOURCE ABZUFÜHREN. FÜHREN SIE KEINE BERÜHRUNGEN AN ELEKTRISSCHLÜSSELN UND VERTEILERN DURCH. ES VERBIBT, DAS PROJECTOR ODER DIE FERNBEDIENUNGSWECHSELN WÄHREND DER ANSCHLUSSE AN DIE STEUERSOURCE ZU VERWENDEN.

CAUTION Label (LASER)
CAUTION LASER RADIATION DO NOT STARE INTO BEAM
WAVE LENGTH : 640-860nm
MAX OUTPUT : 1mW
CLASS II LASER PRODUCT
COMPLIES WITH DHHS 21 CFR SUBCHAPTER J REMOTE CONTROL MODEL CT-90177
PLACE OF MANUFACTURE: A
MANUFACTURED: SEPTEMBER 2002 MADE IN CHINA
TOSHIBA AMERICA INFORMATION SYSTEMS, INC.
9740 Irvine Blvd. Irvine, CA 92618-1697

Remote Control
LASER WARNING
AVOID EXPOSURE - LASER RADIATION IS EMITTED FROM THIS APERTURE

CAUTION Label (LASER)
警告 注意
LASER-STRAHLUNG NICHT IN DEN STRAHL BLICKEN LASER KLASSE 2 PRODUKT
レーザー光線 ヒームの直射を避けてください。1mW レーザークラス2製品。最大出力: 1mW 波長: 640-860nm 注: © 8800/1997/78
ENVIRONNEMENT LASER NE PAS REGARDER DANS LE FAISCEAU APPAREIL A LASER DE CLASSE 2
LASER RADIATION DO NOT STARE INTO BEAM CLASS 2 LASER PRODUCT
MAX OUTPUT: 1mW WAVE LENGTH: 640-860nm IEC60825-1:1993+A1:1997+A2:2001

POWER SUPPLY CORD SELECTION

If your line voltage is 220 to 240V, use one of the following types of cable.

Plug configuration	Plug type	Line voltage	Plug configuration	Plug type	Line voltage
	EURO	220 - 240V		Australian 240V 10A	200 - 240V
	UK	220 - 240V		Switzerland 240V 6A	200 - 240V
				North American 240V 15A	200 - 240V

Use a 5A fuse which is approved by ASTA or BSI to BS1362. Always replace the fuse cover after changing the fuse.

IMPORTANT PRECAUTIONS

Save Original Packing Materials

The original shipping carton and packing materials will come in handy if you ever have to ship your LCD projector. For maximum protection, repack the set as it was originally packed at the factory.

Moisture Condensation

Never operate this unit immediately after moving it from a cold location to a warm location. When the unit is exposed to such a change in temperature, moisture may condense on the crucial internal parts. To prevent the unit from possible damage, do not use the unit for at least 2 hours when there is an extreme or sudden change in temperature.

Place and Manner of Installation

- Do not place in hot locations, such as near heating equipment. Doing so could cause malfunction, and shorten the life of the LCD panel.
- Avoid locations with oil or cigarette smoke. Doing so will dirty the LCD panel and other optical parts, shortening their lives, and darkening the screen.
- Do not place slantwise in angle of 20° or more. Doing so could shorten the life of the lamp.
- Using this instrument near a TV or radio may cause interference to the images or audio sound. If this happens, move it away from the TV or radio.
- Moving the projector from a low-temperature room to a high-temperature room may cause condensation on the lens or internal parts in the instrument. If you continue to use it in that situation, the malfunction may result. Ensure to wait until the condensation naturally disappears.
- In a high altitude location where air is thin, cooling efficiency of the scanner is reduced so use it with the ambient temperature being lowered.

IMPORTANT PRECAUTIONS (Continued)

Avoid Volatile Liquid

Do not use volatile liquids, such as an insect spray, near the unit. Do not leave rubber or plastic products touching the unit for a long time. They will leave marks on the finish. If cleaning with a chemically saturated cloth, be sure to follow the product's precautions.

LCD Panel

The life of the LCD panel is limited. Take care over the points below so as to use the panel for years.

- To prolong the life of this panel, never fail to turn the power off when the panel is not in use and make sure that the lamp has gone out. The state of the lamp being extinguished helps enhance the effect of energy saving.
- If the air filter is stained and is clogged up, the main unit inner temperature rises. As a result, the life of the LCD is shortened and a malfunction may also occur. Clean the air filter from time to time and replace it regularly. It is recommended that this replacement be done at the time of replacing a lamp. (Ask a dealer where the unit was purchased or your nearby service station about an air filter for replacement.)

In the spaces provided below, record the Model and Serial No. located at the bottom of your LCD projector.

Model No. _____ Serial No. _____

Retain this information for future reference.

EXEMPTION CLAUSES

- Toshiba Corporation bears no responsibility in the case of damages arising from natural disaster such as earthquakes, lightning, etc., fire not liable to Toshiba Corporation, operating by third parties, other accidents, or use under abnormal conditions including erroneous or improper operation and other problems.
- Toshiba Corporation bears no responsibility for incidental damages (lost profit, work interruption, corruption or loss of the memory contents, etc.) arising from the use of or the inability to use this unit.
- Toshiba Corporation accepts no liability whatsoever for any damages arising from not having followed the descriptions in this Instruction Manual.
- Toshiba Corporation accepts no liability whatsoever for any damages arising from malfunctions arising from combination with equipment or software that is not related to Toshiba Corporation.

OTHER CAUTIONS AND INFORMATIONS

Copyrights

Showing or transmitting commercial imaging software or broadcast or cable-broad casting programs with the purpose of other than the personal and private viewing, including modifying images using the freeze or resize functions, or displaying with the varying aspect ratio of the images, could violate the direct or indirect copyrights of the imaging software or broadcast program, etc., if done without first consulting with the copyright holder. For this reason, please take appropriate measures before performing one of the actions listed above, including obtaining a license from the copyright holder.

Disposal

- This product contains substances which are harmful to humans and the environment.
- Solder used in the internal parts contains the lead.
 - The lamp contains inorganic mercury.
- Please dispose of this product or used lamps in accordance with local regulations.

Trademarks

- VGA, SVGA, XGA, SXGA, UXGA are trademarks or registered trademarks of International Business Machines Corporation.
- Macintosh is a registered trademark of Apple Computer, Inc.
- Windows is a registered trademark of Microsoft Corporation in the U.S. and other countries.
- Adobe is a registered trademark and Acrobat Reader is a trademark of Adobe Systems Incorporated.

Notational Conventions Used in This Manual

References to pages with related information are annotated as follows. For example, if making a reference to page 36: [p.36](#)

CONTENTS

Before Using

SAFETY PRECAUTIONS	2
IMPORTANT SAFETY INSTRUCTIONS	3
LABEL LOCATIONS	8
POWER SUPPLY CORD SELECTION	9
IMPORTANT PRECAUTIONS	9
EXEMPTION CLAUSES	11
OTHER CAUTIONS AND INFORMATIONS	11
CONTENTS	12

Preparations

Checking the package contents	14
Names of each part on the main unit	15
Names of each part on the control panel and remote control	16
Names of each part on the document camera (models with a document camera)	17
Preparing and using the remote control	18
Placement	19
Connection	21

Operations

Turning the power on and off	22
Basic operations	24
Using handy features	26
Using auto setting (Auto setting)	26
Correcting the keystone distortion (Keystone)	27
Zooming out the images	27
Cutting off the picture and sound temporarily (Mute)	28
Freezing the image (Freeze)	28
Enlarging the picture size (Resize)	29
Displaying Information [Status display]	30
Using the menus	31
How to use the menus	31
The image adjustment menu	32
The default setting menu	32
The display setting menu	33
Reset menu (Special menu)	33
Using the document camera	34
Uninstalling the camera	34
Installing the camera	34
Preparation of the document camera (when loading the camera)	35
Preparing the document camera (for use being separated from the projector)	35
Image projection with the document camera	36
Locking the white balance	38

Maintenance

Air filter cleaning	39
Lens and main unit cleaning	40
Lamp replacement	40

Others

Trouble indications	42
Before calling service personnel	43
Specifications	45
List of general specifications	45
Document camera specifications (Models equipped with document camera)	45
List of supported signals (RGB signals)	46
List of supported signals (Y/P _B /P _R signals)	47
List of supported signals (Video, S-Video signals)	47
Pin assignment of COMPUTER & MONITOR terminals	47
CONTROL terminal	48
Separately Sold Product	48

Checking the package contents

Please make sure that the following items are included in the box, along with the main unit. If any item is missing, please contact the store immediately where you purchased the product.

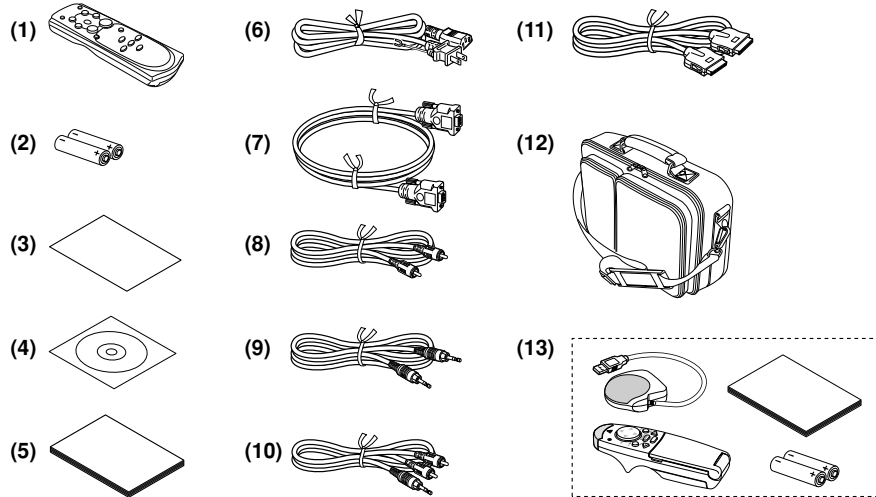

- (1) Remote control
 - (2) R03 (SIZE AAA) batteries for remote control (2)
 - (3) Quick Reference
 - (4) CD-ROM
 - (5) Owner's Manual
 - (6) Power cord (See note)
 - (7) RGB cable
 - (8) Video cable
 - (9) Audio cable (for computer)
 - (10) Audio cable
 - (11) Camera extension cable (supplied with the document camera)
 - (12) Carrying bag
 - (13) Mouse remote control set (*)
 - Mouse remote control
 - R03 (SIZE AAA) batteries for mouse remote control (2)
 - Mouse remote control receiver
 - Mouse remote control manual
- (*) Supplied with TLP-T60M, TLP-T61M, TLP-T70M, TLP-T71M

Note
The shape and number of supplied power cords vary depending on the product destination.

◆The Supplied CD-ROM

The supplied CD-ROM contains an owner's manual, including information omitted in this Owner's manual (Getting started) and Acrobat® Reader™ to view the manual.

■ Installing Acrobat® Reader™

Windows®: Run the CD-ROM, select the **Reader/English** folder, and run **ar500enu.exe**. Follow the on-screen instructions.
Macintosh: Run the CD-ROM, select the **Reader/English** folder, and run **Reader Installer**. Follow the on-screen instructions to install the software.

■ Viewing the manual

Run the CD-ROM and double-click on **Start.pdf**. Acrobat® Reader™ launches, and the menu screen of the Owner's manual appears. Click on your language. The Owner's Manual cover and list of bookmarks appear. Click on a bookmark title to view that section of the manual. Click on to view a reference page with related information. See the Help menu for more information about Acrobat® Reader™.

Names of each part on the main unit

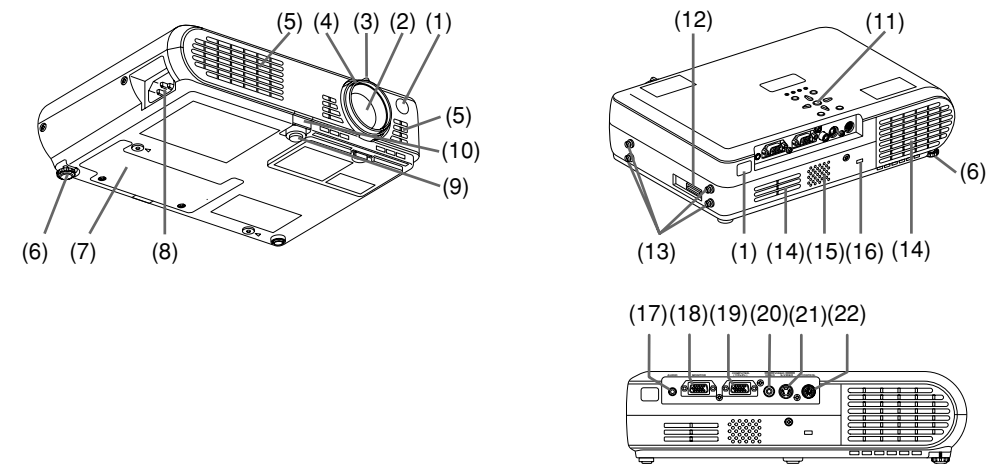

Name	Function
(1) Infrared remote sensor	: Senses commands from the remote control. p.18
(2) Lens	: Projects expanded image.
(3) Zooming lever	: Adjusts screen size. p.25
(4) Focusing ring	: Adjusts screen focus. p.25
(5) Air intake	: Draws in air from outside unit.
(6) Tilt adjuster	: Adjusts the projector's horizontal tilt. p.25
(7) Lamp cover	: Remove to replace lamp. p.41
(8) AC IN socket	: Connect the supplied power cord here. p.22
(9) Foot adjuster	: Adjusts the vertical projection angle. p.25
(10) Foot adjuster release button	: Press to stow the foot adjuster. p.25
(11) Control panel	: Operates the projector. p.16
(12) Camera input terminal*	: Connect the camera. p.34 p.35
(13) Camera mounting stays*	: Hold the camera control panel. p.34
(14) Air exhaust	: Expels air that has grown hot inside the projector.
(15) Speaker	: Plays audio.
(16) Anti-theft lock hole	: Attach a security chain, etc. here.
(17) AUDIO terminal	: Feeds the audio signal from a computer or video equipment.
(18) MONITOR terminal	: Connected to the monitor display.
(19) COMPUTER terminal	: Feeds the RGB signal from a computer or the component video signal (Y/Pb/Pr) from a video equipment.
(20) VIDEO terminal	: Feeds the video signal from a video equipment.
(21) S-VIDEO terminal	: Feeds the S-video signal from a video equipment.
(22) CONTROL terminal	: Connected to the RS-232C port on a controlling computer for operating the projector. p.48

Note
*: For the models with a document camera

Names of each part on the control panel and remote control

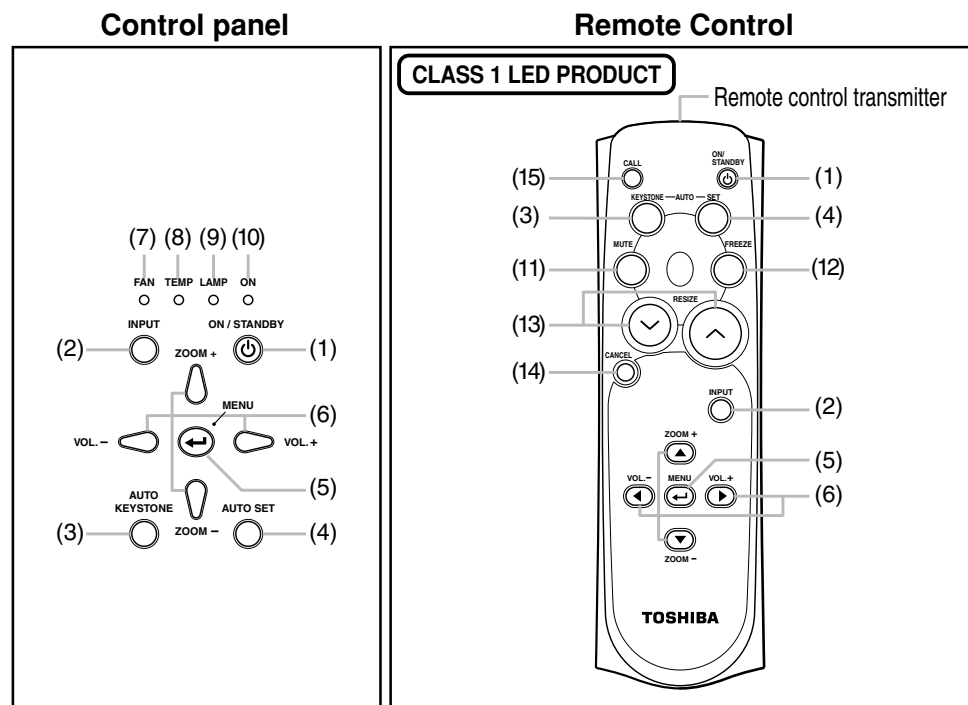

Names of each part on the document camera (models with a document camera)

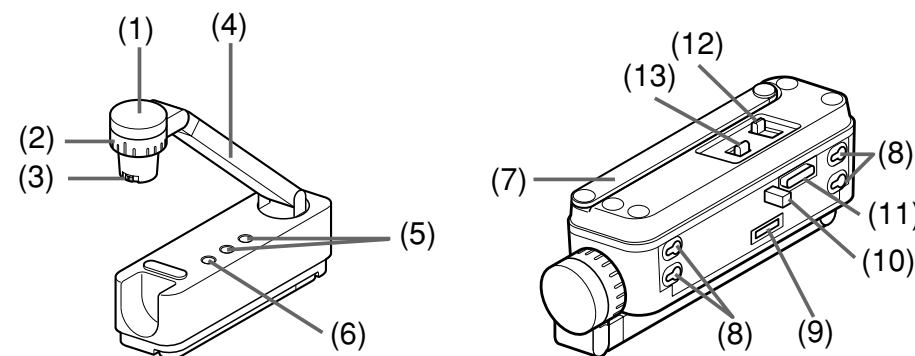

Name	Function
(1) Camera head	: Document camera.
(2) Camera lens	: Shooting lens for the document camera.
(3) Focus ring	: Adjusts the focus.
(4) Camera arm	: Adjusts the shooting angle. p.36
(5) CAMERA GAIN buttons	: Adjusts the camera gain. p.37
(6) CAMERA button	: Toggles between the camera input and previous input. p.36
(7) Tip resistant bar	: Pulled out when a camera is used separated from the projector.
(8) Stay mounting holes	: Aligns with the projector's stay.
(9) Camera output terminal (CAMERA OUT)	: Connected to the accessory camera cable when a camera is used separated from the projector.
(10) Lock bar	: Locked to the projector.
(11) Connector	: Camera signal is output.
(12) Connect lever	: Connector is connected to the projector.
(13) Lock lever	: Used when the camera is disconnected from the projector.

Name : Main Function

- (1) ON/STANDBY button : Turns the power on/off (standby). [p.22](#)
- (2) INPUT button : Selects input. [p.24](#)
- (3) AUTO KEYSTONE button : Adjusts keystone (trapezoidal distortion). [p.27](#)
- (4) AUTO SET button : Sets up image and mode. [p.26](#)
- (5) MENU button : Displays menus and makes selections. [p.31](#)
- (6) Selection buttons : Menu selections and adjustments, etc. [p.31](#)
- (7) FAN indicator : Displays cooling fan mode. [p.23](#) [p.42](#)
- (8) TEMP indicator : Lights when internal temperature too high. [p.42](#)
- (9) LAMP indicator : Displays lamp mode. [p.23](#)
- (10) ON indicator : Displays whether power is on or off. [p.22](#)
- (11) MUTE button : Cuts off the picture and sound temporarily. [p.28](#)
- (12) FREEZE button : Pauses image. [p.28](#)
- (13) RESIZE buttons : Enlarges picture size. [p.29](#)
- (14) CANCEL button : Exiting the operation. [p.30](#)
- (15) CALL button : Displays the information on the screen. [p.30](#)

Notes

- For the remainder of this manual, buttons are referred to as follows:
Selection buttons ⇒ ; MENU button ⇒
- For further information of the mouse remote control supplied with the TLP-T60M, TLP-T61M, TLP-T70M, TLP-T71M, see the Owner's Manual of the Mouse Remote Control.

Preparing and using the remote control

■ Loading dry-cell batteries into the remote control

- ① Remove the battery cover.

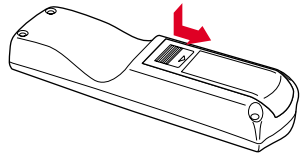

- ② Insert the dry-cell batteries.

Be sure to align the plus and minus ends of the batteries properly.

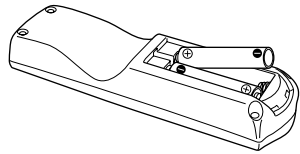

Two batteries (R03, SIZE AAA) are used.

- ③ Replace the battery cover.

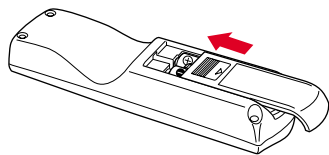

■ Dry-cell batteries

- Before using the batteries, be sure to observe the Safety Precautions described in previous pages.
- Remove batteries from remote control when not using for extended periods.
- If the remote control stops working, or if its range decreases, replace all the batteries with new ones.

■ The remote control

- The remote control may fail to operate if the infrared remote sensor is exposed to bright sunlight or fluorescent lighting.
- Do not drop or bang.
- Do not leave in hot or humid locations.
- Do not get wet or place on top of wet objects.
- Do not take apart.
- In rare cases, ambient conditions could impede the operation of the remote control. If this happens, point the remote control at the main unit again, and repeat the operation.
- For further information of the mouse remote control supplied with the TLP-T60M, TLP-T61M, TLP-T70M, TLP-T71M, see the Owner's Manual of the Mouse Remote Control.

■ Operating the remote control

Point the remote control toward the projector's infrared remote sensor, and press a button on the remote control.

- Operating the projector from the front

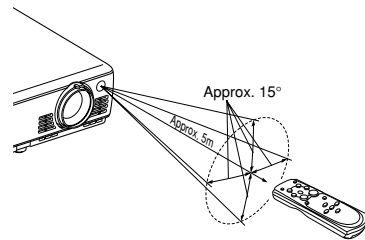

- Operating the projector from the rear

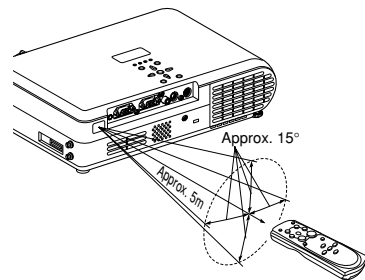

Placement

Placement Styles

As shown in the figures below, this device can be placed in 4 different styles. The factory setting is "floor-mounted front projection." Set the **placement style** in the **default setting menu** [p.32](#), in accordance with your needs.

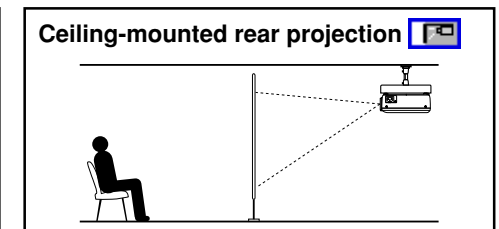
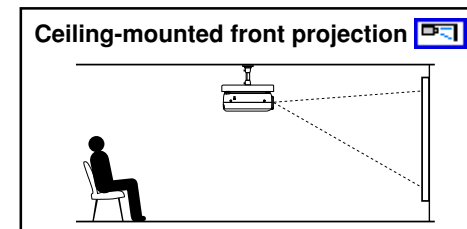
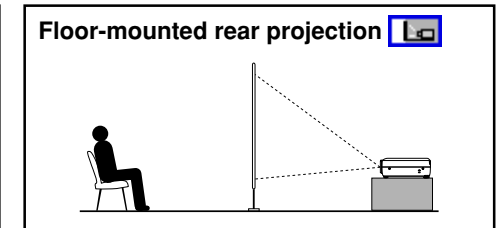
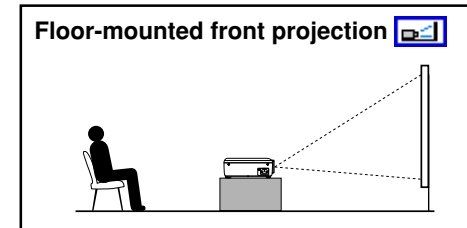

⚠ CAUTION

- Always obey the instructions listed in IMPORTANT SAFETY INSTRUCTIONS when placing the unit.
- If you wish to mount the projector on the ceiling, be sure to ask your dealer to do so. Mounting the projector on a ceiling requires special ceiling brackets (sold separately) and specialized knowledge. Improper mounting could cause the projector to fall, resulting in an accident.
- If the projector is ceiling-mounted, install the breaker for turning off the power in case of anomaly. Let everyone involved with the use of the projector know that fact.

Placement (Continued)

Projection Distance and Screen Size (with optical zooming)

Use the figures, tables, and formulas below to determine the screen size and projection distance. (Screen sizes are approximate values for full-size picture with no keystone adjustment)

Screen **As seen from above**

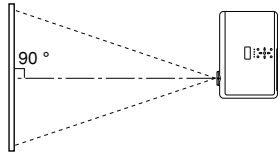

For TLP-T70M/T71M

$$a \text{ (min length)} = \frac{\text{projection size (inches)} - 1.547}{26.44}$$

$$a \text{ (max length)} = \frac{\text{projection size (inches)} - 1.2907}{22.06}$$

a is the distance (m) between the lens and the screen, and corresponds to a range of 1.45 m to 11.29 m.

screen size (cm)	projection distance a(m)	
	min length (zooming max)	max length (zooming min)
40 (102)	1.45	1.75
60 (152)	2.21	2.66
80 (203)	2.97	3.57
100 (254)	3.72	4.47
150 (381)	5.61	6.74
200 (508)	7.51	9.01
250 (635)	9.40	11.27
300 (762)	11.29	—

As seen from the side

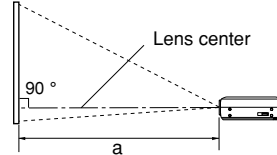

For TLP-T60M/T61M/S40/S41

$$a \text{ (min length)} = \frac{\text{projection size (inches)} - 1.4285}{30.68}$$

$$a \text{ (max length)} = \frac{\text{projection size (inches)} - 1.1908}{25.574}$$

a is the distance (m) between the lens and the screen, and corresponds to a range of 1.26 m to 9.73 m.

screen size (cm)	projection distance a(m)	
	min length (zooming max)	max length (zooming min)
40 (102)	1.26	1.52
60 (152)	1.91	2.30
80 (203)	2.56	3.08
100 (254)	3.21	3.86
150 (381)	4.84	5.82
200 (508)	6.47	7.77
250 (635)	8.10	9.73
300 (762)	9.73	—

Connection

Before connection

- Read the owner's manual of the device to connect to the projector.
- Some types of computer cannot be used or connected to this projector. Check for an RGB output terminal, supported signal [p.46](#), etc.
- Turn off the power of both devices before connecting.
- The figure below is a sample connection. This does not mean that all of these devices can or must be connected simultaneously. (Dotted lines mean items can be exchanged.)

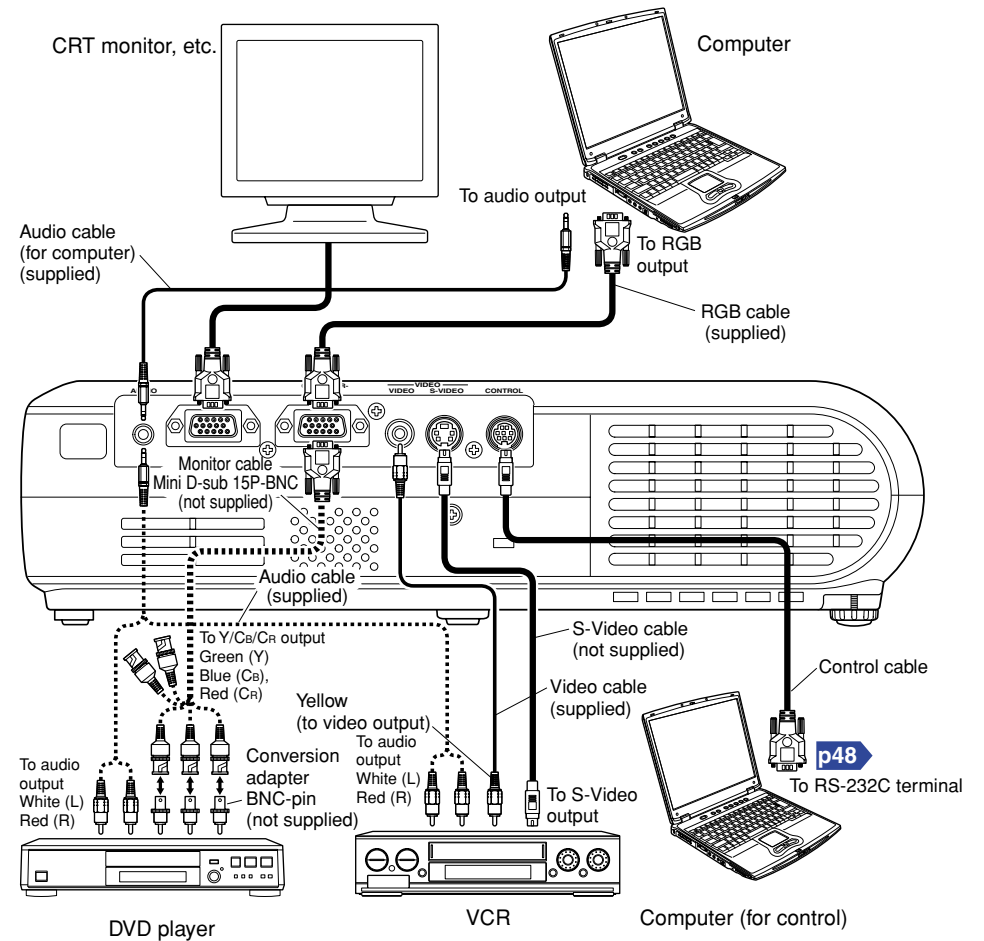

Note

- The AUDIO terminal can be used with all the devices for input terminal.

Turning the power on and off

Connecting the power cord

- 1 Insert the power cord connector into the AC IN socket of the projector.
- 2 Insert the power cord plug into a wall or other power outlet.

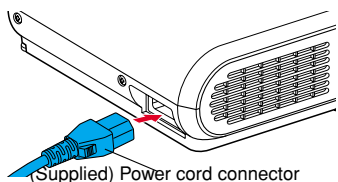

When the power cord is plugged in, the following three green indicators will come on for several seconds: ON, TEMP, and LAMP. Next, the ON indicator will change to orange, indicating standby mode. (Do not perform any operations while the 3 green indicators are on.)

Removing the lens cover

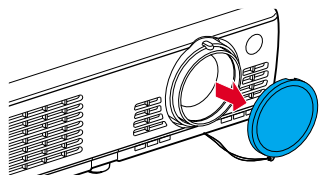

Be sure to remove the lens cover when the power is turned on. If it is left on, it could become deformed due to heat.

Turning the power on

- 1 Press the ON/STANDBY button.

The power turns on, and the following 3 green indicators light: ON, LAMP, and FAN. After a moment, the start-up screen appears.

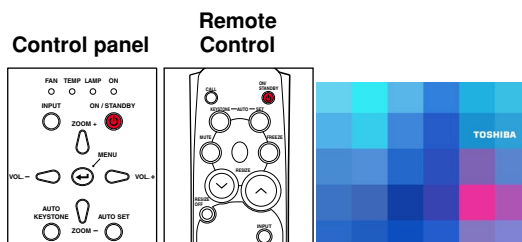

WARNING

- Do not look into the lens during operation. Doing so could damage your vision.

CAUTION

- Do not block the air intake or exhaust. Doing so could cause a fire due to internal overheating.
- Do not place your hands, face, or other objects near the air exhaust. Doing so could cause burns, deform/break the object.

Notes

- The start-up screen will disappear after a moment. You can dismiss the start-up screen before this by performing any operation. You can also configure the start-up screen not to appear via the **Display setting menu** [p.33](#).
- The first time you use the projector after purchase, after the start-up screen disappears, the Language menu is displayed [p.24](#).

Turning the power off

- 1 Press the ON/STANDBY button.

A message appears on the screen, confirming that you wish to shut off the power. This message will disappear after a moment. (This operation is no longer valid after the message disappears.)

- 2 Press the ON/STANDBY button again.

The screen turns off, but the internal cooling fan continues to operate for a short while. Then, the projector goes into standby mode.

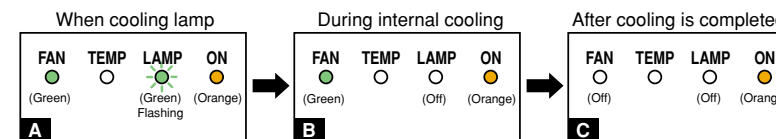

- During cooling, the LAMP indicator flashes. In this state, the power cannot be turned back on. In addition, unplugging the power cord in this state will shorten the life of the lamp.
- After the LAMP indicator goes off, the cooling fan continues to operate for a short while in order to expel excess internal heat. If you are in a hurry, there is no problem with unplugging the power cord in this state.
- In standby mode.

Note

- The projector consumes about 6W of power in standby. We recommend you to unplug the power cord if you will not use the projector for an extended period.

PRECAUTIONS

- Before unplugging the power cord, make sure that the LAMP indicator is off. Unplugging the power cord and cutting off the power while the projector is running or being cooled will shorten the life of the lamp. **However, please unplug the power cord if the projector locks up or acts abnormally.**
- If the power cord was unplugged before cooling was complete, give the lamp sufficient time to cool before plugging it back in. If the lamp overheats, it may fail to light, and its lifetime will be shortened.

LCD Panels

LCD panels wear out. In order to prolong the lifetime of your LCD panel, take the following precautions.

- In order to extend the lifetime of the LCD panel, always turn off the power when not in use, and make sure that the lamp is off. Keeping the lamp off is also very effective at saving electricity.
- If the air filter becomes dirty and clogged, the projector's internal temperature will rise, shortening the lifetime of the LCD panel and causing malfunctions. Clean the air filter from time to time [p.39](#), and replace it periodically. Contact the store where you purchased your projector, or your local Service Station for replacement air filters.

Basic operations

1 Turn on the power.

Turn on the power by following the instructions in “Turning on the power” [p.22](#).

2 Select the language and the lamp power (When using the first time).

When the projector is used for the first time after purchase, menu for language and lamp power selection and configuration is displayed in English. (If the screen is out of focus, adjust it according to the step 6.)

1 Use the ▲ or ▼ buttons to select the desired language and press the ⏺ button.

Message for setup confirmation is displayed in a selected language.

2 Using the ▲ or ▼ button, select Standard or Low and press the ⏺ button.

The lamp power, if selected, will be toggled without pressing the ⏺ button. The display automatically disappears in a few seconds.

English	English
Français	French
Deutsch	German
Italiano	Italian
Español	Spanish
Português	Portuguese
日本語	Japanese
中文(简体字)	Chinese (simplified)
中文(繁體字)	Chinese (traditional)
한국어	Korean

Notes

- When the projector is turned on the next time, the Language and Lamp power menus do not appear upon startup. However, if “Reset all” is executed from the **Reset** menu [p.33](#), the Language and Lamp power menus will be displayed the next time when the power is turned on
- The language can also be set via the Display setting menu [p.33](#) and Lamp power via the Default setting menu [p.32](#).
- This owner’s manual assumes that English has been selected.

3 Place connected device(s) in operating status.

Turn on and boot up connected computers and other devices.

4 Select input.

1 Press the INPUT button.

A list of inputs appears on the screen.

2 Use the ▲ ▼ buttons to select the desired input, and press the ⏺ button.

The picture for the selected input is projected.

Computer
Y/P_B/P_R
Video
S-video

When a camera is connected with the document camera model:

Computer
Y/P_B/P_R
Video
S-video
Camera

5 Projector placement angle adjustments

The placement angle and the height of the projected image can be adjusted by the foot adjuster.

1 Lift up the front of the projector to the desired angle, then press the foot adjuster release button.

The foot adjuster extends. Release the button to lock the position.

2 Turn the foot adjuster to fine-tune the angle.

3 To adjust the horizontal angle, use the tilt adjuster.

To stow the foot adjuster, hold up the projector while pressing the foot adjuster release button, then slowly lower the projector.

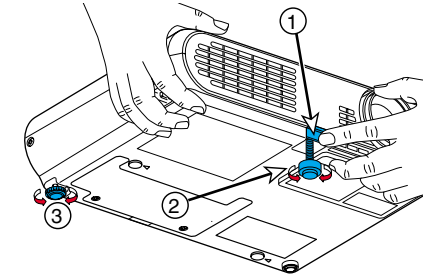

6 Adjusting the picture size and focus

1 Use the zooming lever to adjust the screen size.

2 Use the focusing ring to adjust the focus.

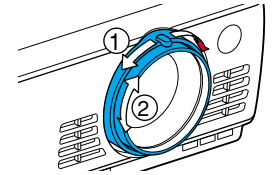

7 Adjusting the volume with the ◀ ▶ buttons

The speaker volume can be adjusted when an audio signal is being input.

Notes

- Note that because of the lamp characteristics, the brightness of the lamp may fluctuate slightly.
- A lamp is a consumable supply. If used for extended periods, images will appear dark, and the lamp could burn out. This is characteristic of a lamp, and is not malfunction. (The lifetime of the lamp depends on conditions of use.)
- The LCD panel is made using extremely advanced technology, but there may be black spots (pixels that do not light) or bright spots (pixels that are constantly lit) on the panel. Please note that these are not malfunctions.
- Although this projector supports a wide range of RGB signals [p.46](#), any resolutions not supported by the model (XGA or SVGA, depending on the model) will expand or shrink the pictures, and will affect image quality slightly. To view high-quality images, it is recommended that the computer’s external output should be set to the projector’s resolution.
- With some models of computer having LCD displays or the like, displaying images simultaneously on the projector and the monitor’s display may cause the images to be shown improperly. If this happens, turn off the computer’s LCD display. For information on how to turn off the LCD display, see the owner’s manual of your computer.
- If a signal not supported by the projector is input, the icon will appear.
- If a no signal is being input from the connected device, the **OFF** icon will appear.
- If an unavailable operation button is pressed, the icon will appear.

Using handy features

■ Using auto setting (Auto setting)

This function sets up the projector to the optimum state for each type of the input signal by using simple operations.

① Press the AUTO SET button.

The Auto setting menu appears.

② Press the AUTO SET button again.

The menu item is automatically adjusted/set.

For computer input, the  icon will appear during processing.

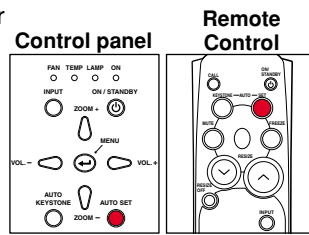





































■ Note

- Auto adjustment/setting may not be performed correctly for input signals other than those supported by the projector [p.46](#) , [p.47](#) .

● Manual adjustment and setting

The menu items vary depending on the input type, as shown in the table below.

Use the      buttons to adjust the items in the table below, then press the  button when you are finished. The menu disappears. (The CANCEL button on the remote control also allows you to exit the menu mode.)

Input	Item	Description
Computer	 Phase	Adjust with   to eliminate flicker.
	 Frequency	Adjust with   to eliminate periodic patterns and flickering when many vertical lines appear on the screen.
	 H-position	Move left   Move right
	 V-position	Move up   Move down
	 Clamp 1	Adjusts the clamp pulse position with  or  .
	 Clamp 2	Adjusts the clamp pulse width with  or  .
Y/Pb/Pr	 Phase	Adjust with   to eliminate flicker.
	 Signal format	[ : Enter to setting mode] → [  : Select one of the following] → [Apply: ] 480i(525i)@60Hz/480p(525p)@60Hz/ 576i(625i)@50Hz/576p(625p)@50Hz/ 720p(750p)@60Hz/720p(750p)@50Hz/ 1080i(1125i)@60Hz/1080i(1125i)@50Hz/ 1035i(1125i)@60Hz/1152i(1250i)@50Hz
Video S-video	 Video mode	[ : Enter to setting mode] → [  : Select one of the followings] → [Apply: ] NTSC/PAL/SECAM/PAL-N/PAL-M/PAL60/NTSC4.43

■ Note

- Moving pictures generated with the DVD software for computers may appear unnatural if it is projected with this projector, but it is not a malfunction.

■ Correcting the keystone distortion (Keystone)

When the foot adjuster [p.25](#) is used to change the projection angle, the picture will undergo keystone (trapezoidal) distortion.

This projector is capable of correcting this keystone distortion.

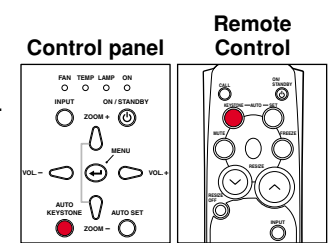
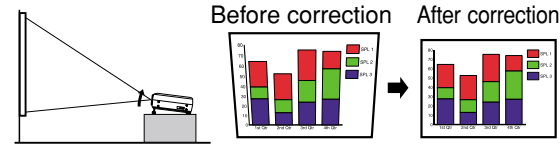



① Press the AUTO KEYSTONE button.



The Keystone menu appears.

② Press the AUTO KEYSTONE button again.

The keystone distortion is automatically corrected. The  icon will appear during processing.

● Manual adjustment

Use the   buttons for keystone adjustment. When the adjustment is finished, press the  button. The menu disappears. (The CANCEL button on the remote control also allows you to exit the menu mode.)

Item	Description
 Keystone	Shrink button of the screen   Shrink top of the screen

■ Notes

- Depending on the amount of keystone adjustment and the content of images, some information may be lost, or the picture quality may suffer.
- Keystone adjustment will not change the shape of the menus.

■ Zooming out the images

This equipment is provided with the digital zoom (electric zoom) (100-80%) capability in addition to the optical zoom.

You can use the digital zoom in applications where the optical zoom is not applicable due to some physical reasons for installations (Note, however, that digitally zoomed display suffers from some degradation).

① Press the ZOOM – button.

Each time the ZOOM – button is pressed, the image is reduced in size.

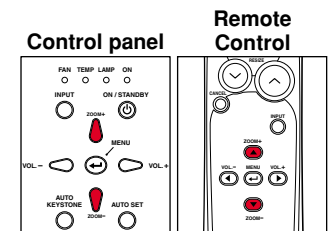
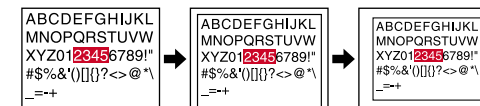

Using handy features (Continued)

2 Press the ZOOM + button to bring it back to the original size.

Each time the ZOOM + button is pressed, the image size increases.
(You cannot make it larger than the original size.)

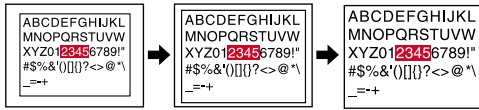

Notes

- Pressing either the ZOOM- or ZOOM+ button would display the  icon.
- The adjustment value will automatically be saved.

■ Cutting off the picture and sound temporarily (Mute)

When you want to project the images of another projector, overhead projector, etc. temporarily, this projector's images and sound can be turned off.

● Press the remote control's MUTE button.

The picture and sound are cut off. The Mute function is released when pressing the MUTE button again. To cancel the command, press the CANCEL button.

Notes

- The  icon will appear while mute is in effect.
- Operating any other functions cancel the muting.

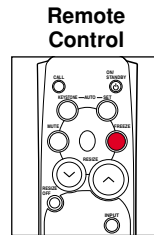
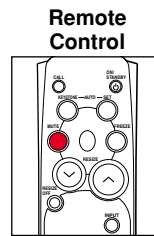

■ Freezing the image (Freeze)

The image being projected can be made to be frozen. This function is to be used to pause a video during a presentation, etc.

● Press the remote control's FREEZE button.

The picture pauses. The Freeze function is released when pressing the FREEZE button again. To cancel the command, press the CANCEL button.

Notes

- The  icon will appear while freeze is in effect.
- The freeze function can be used on the resize function. Other operations will release the freeze.
- Even if an image is frozen on the projector, the pictures are running on the video or other equipment.
- If you use this function on video soft sold on the market, broadcast or broadcast on cable except for the purpose of your private viewing and listening, it may infringe the copyright protected by the copyright laws.

■ Enlarging the picture size (Resize)

The image being projected can be enlarged.

1 Press the remote control's RESIZE button.

The enlargement ratio is increased each time the RESIZE  button is pressed.



2 To decrease the enlargement ratio, press the remote control's RESIZE button.

The enlargement ratio is decreased each time the RESIZE  button is pressed.
(The image cannot be shrunk to less than its original size.)

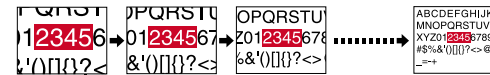

3 Press and hold down the buttons to move the enlarged area.

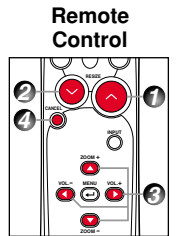
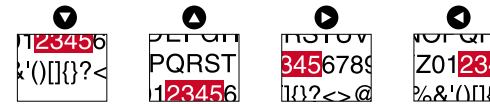

4 Press the CANCEL button to undo the resize.

The resize is released, and the image returns to its original size.

Notes

- The  icon will appear while resize is in effect.
- An enlarged image can be frozen using the FREEZE button. The resize function on a frozen image can also be used.
- Operations other than freeze will cancel the resize.
- Since the enlargement is performed using digital processing, enlarging will cause the image to appear jagged.
- Rarely, the picture could become garbled while the enlarged area is being moved.
- If you use this function on video soft sold on the market, broadcast or broadcast on cable except for the purpose of your private viewing and listening, it may infringe the copyright protected by the copyright laws.

Using handy features (Continued)

■ Displaying Information [Status display]

This displays information about the input signal, lamp use time, etc.

- Press the button twice (or press the CALL button on the remote control once).

When the button is pressed once, the **Setting display menu** appears. Pressing it again displays information [p.31](#). The table below shows what kind of information is displayed. Press the button (or press the CALL or CANCEL button on the remote control to serve the same purpose) again to dismiss the display.

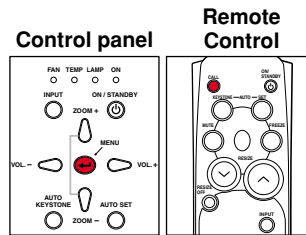

“Yes”: displayed, “No”: not displayed

Item	Description	Computer	Y/Pb/Pr	Video S-video	Camera
Input	Input source name	Yes	Yes	Yes	Yes
RGB signal mode	RGB input mode ^[Note 1]	Yes	No	No	No
H-resolution	Horizontal resolution (in bits)	Yes	No	No	No
V-resolution	Vertical resolution (in bits)	Yes	No	No	No
H-frequency	Horizontal sync frequency	Yes	No	No	No
V-frequency	Vertical sync frequency ^[Note 2]	Yes	No	No	No
Sync	Sync signal polarity ^[Note 3]	Yes	No	No	No
Signal format	Y/Pb/Pr signal format	No	Yes	No	No
Video mode	Color method of video signal	No	No	Yes	No
Lamp time	Time of lamp use ^[Note 4]	Yes	Yes	Yes	Yes
Version	Firmware version ^[Note 5]	Yes	Yes	Yes	Yes

Notes

- 1: The mode of supported RGB signals [p.46](#) is shown.
- 2: Same as the refresh rate of the computer signal.
- 3: Sync signal polarity shown as P (positive) or N (negative) for [H/V].
- 4: Displays [**Lamp time**] as a measure of when the lamp should be replaced. (Cannot be used as a counter of guaranteed lamp time.) When the displayed time approaches 3,000 hours, consult with a store about getting a TLPLV2 replacement lamp (sold separately) prepared.
- 5: [**Version**] shows the version of the projector's internal control program. This version is referred to for customer service, etc.

■ Notes

- The displayed information will not be refreshed if the status changes. To refresh the information, dismiss the display, then display it again.
- Conducting another operation while information is being displayed dismisses the display.

Using the menus

You can call up on-screen menus, and conduct a number of adjustments and settings using the operation buttons [p.16](#) on the control panel (main unit side) and remote control.

■ How to use the menus

The menu shown below is only for operation instructions and might be different from the actual display.

2. Select a Category

Select a category by using . There are following three categories.

Image adjustment menu [p.32](#)

Default setting menu [p.32](#)

Display setting menu [p.33](#)

1. Start Display the Setting display menu

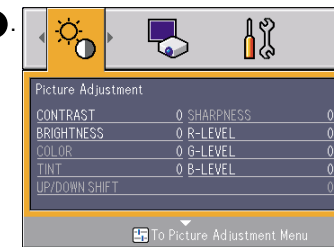

Displays the current adjustments of selected category. Item shown with gray cannot be adjusted with the current input source.

3. Adjustments & Settings

Press to open the menu of the selected category.

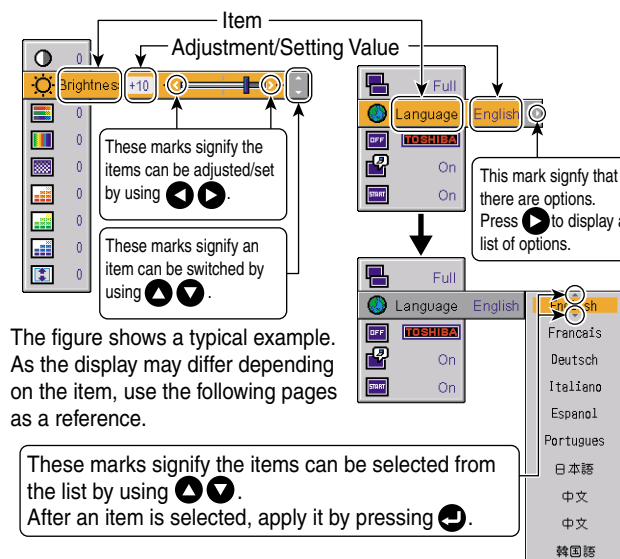

The figure shows a typical example. As the display may differ depending on the item, use the following pages as a reference.

These marks signify the items can be selected from the list by using . After an item is selected, apply it by pressing .

5. To Finish

Finish via the Status display menu.

To Status display [p.30](#)

6. End

The menu disappears.

■ Note

- Menu adjustments and settings are saved when the power is turned off via the **ON/STANDBY** button. If the power cable is disconnected before this, or the power goes out, then the data will not be saved.
- You can also use the **CANCEL** button on the remote control to dismiss the menu display.

Using the menu (Continued)

■ The image adjustment menu

Use this menu to adjust image-related items.

Items that can be adjusted are marked with “Yes”, and those that cannot are marked with “No”.

Item ▲ ▼	Description	Computer	Y/P _B /P _R	Video	S-video	Camera
Contrast	Lower ◀ ▶ Higher	Yes	Yes	Yes	Yes	Yes
Brightness	Darker ◀ ▶ Brighter	Yes	Yes	Yes	Yes	Yes
Color	Lighter ◀ ▶ Deeper	No	Yes	Yes	Yes	No
Tint [Note 1]	Reddish ◀ ▶ Greenish	No	No	Yes	Yes	No
Sharpness	Softer ◀ ▶ Sharper	No	Yes	Yes	Yes	Yes
R-level	Less red ◀ ▶ More red	Yes	Yes	Yes	Yes	Yes
G-level	Less green ◀ ▶ More green	Yes	Yes	Yes	Yes	Yes
B-level	Less blue ◀ ▶ More blue	Yes	Yes	Yes	Yes	Yes
Up/down shift [Note 2]	Shift down ◀ ▶ Shift up	No	Yes	Yes	Yes	No

Notes

1: **Tint** can only be adjusted when **Video mode** p.26 is set to **NTSC** or **NTSC4.43**.

2: **Up/down shift** can only be adjusted when **Screen size** p.33 is set **Wide**.

■ The default setting menu

This menu shows placement status and other settings.

Item ▲ ▼	Description
Projection mode	Sets projection mode in accordance with Placement Style p.19 (Placed on floor) ◀ ▶ (Rear) ◀ ▶ (Hung from ceiling) ◀ ▶ (Back hung from ceiling)
No signal power off	Sets the period of time to wait until turning off the power after signal input stops: Off (not turned off) ◀ ▶ 1 min ◀ ▶ 2 min ◀ ▶ ... ◀ ▶ 60 min
Power on	Sets whether to turn on the power when the ON/STANDBY button is pressed (Manual), or when the power cord is plugged in (Auto). Manual ◀ ▶ Auto
Lamp power [Note 1]	Sets the lamp power Standard ◀ ▶ Low
Shutter speed	Sets the camera's shutter speed to either (50Hz) or (60Hz). 50Hz ◀ ▶ 60Hz .
White balance [Note 2]	Sets the camera's white balance to (Auto) or (Fixed). Auto ◀ ▶ Fixed .

Notes

1: When **lamp power** is set to **low**, the screen becomes a little darker, but the cooling fan noise gets quieter. This setting will be cleared when you turn the power off. The setting will be back to “Standard” when the power is turned on next time.

2: White balance, if set to **Fixed**, is reset upon power off and the **Auto** is resumed the next time the unit is turned on. (Models with the document camera)

■ Notes

- Note that if **Power on** is set to **Auto**, then if the power cord is plugged in when power is restored after a power outage, the projector power will come on.
- Even if **Power on** is set to **Auto**, press the **ON/STANDBY** button to turn off the power. Unplugging the power cord to cut off the power will shorten the life of the lamp.

■ The display setting menu

Use this menu to set screen display-related items.

Item ▲ ▼	Description
Screen size	◀ ▶ ◀ ▶ ◀ ▶ (Full): Display with LCD panel's resolution (Thru): Display with sampling resolution (for computer input) (Wide): Wide-screen display (for Video, S-video, and Y/P _B /P _R)
Language	Select one of the languages below to use for displaying menus and messages [▶]: Enter setting mode → [▲▼]: Selection → [Apply: ◀]] English/Français/Deutsch/Italiano/Español/ Português/日本語/中文(简体字)/中文(繁体字)/한국어
Background	Screen to display when there is no input signal (Logo) ◀ ▶ (Blue) ◀ ▶ (None)
Icon	Display icons as function guides On ◀ ▶ Off
Start-up screen	Display start-up screen when power turned on On ◀ ▶ Off

■ Notes

- If “Thru” is selected for **screen size**, portions exceeding the pixel count of the LCD panel p.45 will not appear on the screen. Note that for RGB signals with clock speeds SXGA3_60 p.46 or lower, all input pixel signals are sampled. (This effect is noticeable when the screen is enlarged using the Resize function p.29). However, if the clock speed is higher than this, the RGB pixel signal is reduced before sampling.
- Displaying the images with the aspect ratio different from the original with the purpose of other than the personal and private viewing, using the screen size menu may violate the copyright protected by the law.

■ Reset menu (Special menu)

When other menus are not displayed and the ◀ button is held down, the menu appears.

- When the screen is placed vertically, and **Auto keystone correction** is executed, but the keystone correction is not successful, stow the foot adjuster in its original position, place the projector on a flat surface, select **Horizontal reference value reset**, and press the ◀ button.
- Select **Reset All** and press the ◀ button to return all menu items to the factory settings.

Item ▲ ▼	Description
Horizontal reference value reset	Reset the horizontal reference value for Auto keystone correction [▶]: Enter execution mode → [Yes ▲ ▼ No] → [Apply: ◀]
Reset all	Reset all menu items to their factory settings [▶]: Enter execution mode → [Yes ▲ ▼ No] → [Apply: ◀]

Using the document camera

Please read this chapter if the model you purchased includes a document camera.

■ Uninstalling the camera

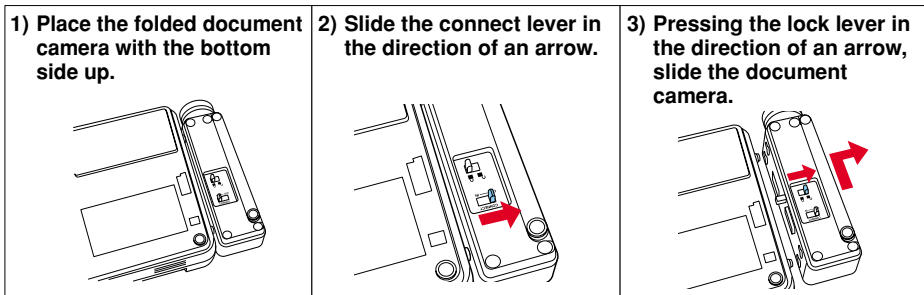

■ Installing the camera

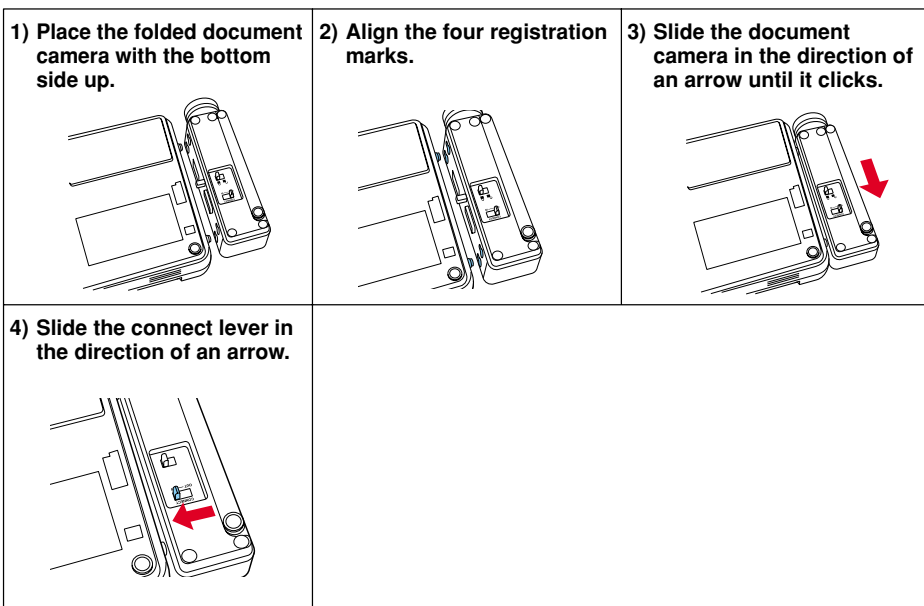

■ PRECAUTIONS

- Before mounting or dismantling the document camera, disconnect the power plug.
- Place a soft cloth beneath the projector when mounting or dismantling the camera.
- Do not dismount or mount the document camera while the projector is upright or kept in the air.
- Before mounting the camera, confirm that the interconnection connector is closed with the connect lever. If you attempt to mount the camera with the connector being protruded, connector may be damaged.
- When mounting the camera, be sure to slide the document camera until it is locked with click sound.
- Confirm the four registration stays are aligned before sliding the camera.

■ Preparation of the document camera (when loading the camera)

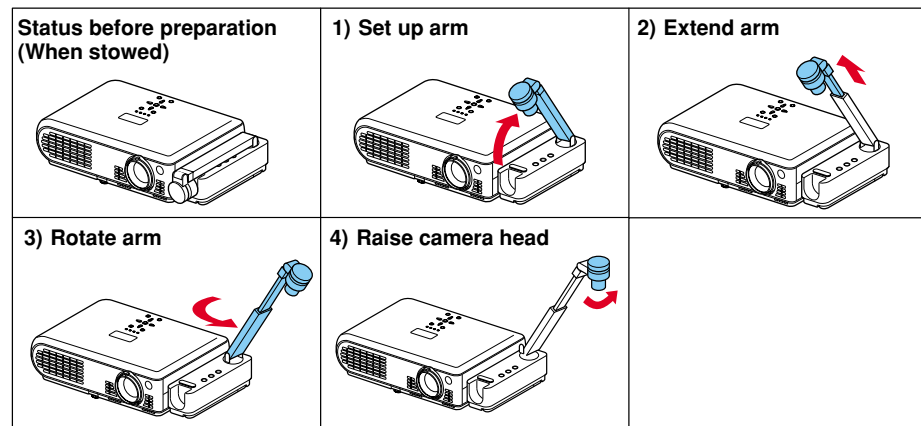

■ PRECAUTIONS

- Do not jolt or force the camera head or camera arm. Doing so could cause malfunction.
- Note that when extending or rotating the camera arm, the arm moves in an arc. Take care not to bump yourself or others with it.

■ Preparing the document camera (for use being separated from the projector)

- Before connecting the camera cable, make sure that the projector power is off.

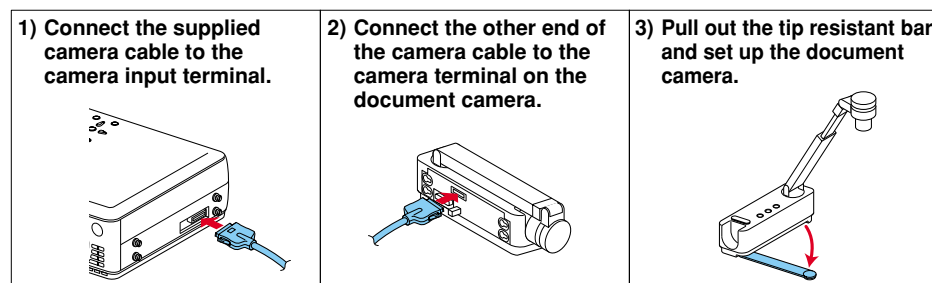

■ PRECAUTIONS

- Insert a camera cable straight and securely until it locks. When disconnecting the cable, pull it out releasing the lock on both sides of the plug.
- Be sure to pull the tip resistant bar fully until it forms the angle of 90 degree. If you don't use the bar, the camera may topple over.
- Note that the camera may tip over if you attempt to rotate the arm in the opposite side of the tip resistant bar.
- For camera interconnection, be sure to use the supplied camera cable (1 m). If you use the other cables, the normal operation cannot be achieved and even the malfunction may result.

■ Note

- Connecting or disconnecting the camera cable with the projector's power ON may cause camera error (E1 is displayed) and even turn off the power.

Using the document camera (Continued)

■ Image projection with the document camera

① Place the document.

Set the document at the top of or the side of the projector.

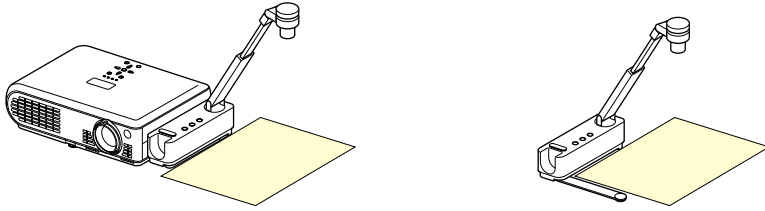

② Press the CAMERA button, and select camera input.

- The input returns to the previous input when the CAMERA button is pressed again.
- Camera input can also be selected by pressing the remote control or camera's INPUT button.

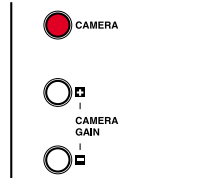

③ Rotate the camera lens to align the orientation of the document for shooting.

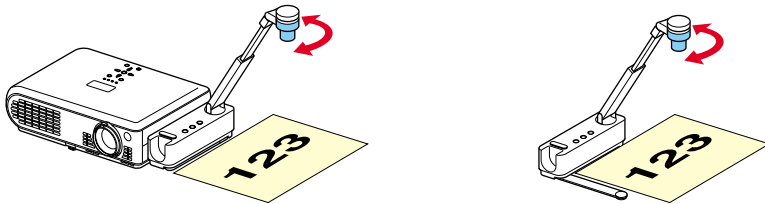

④ Move the camera head up and down to adjust the image size.

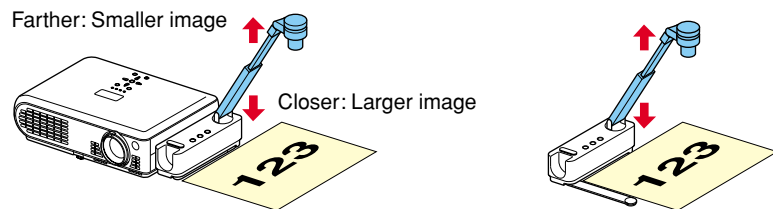

- Closeup shot with the distance shorter than 100 mm cannot be performed.

⑤ Adjust the focus using the focus ring on the camera head

Rotate the focus ring to either **NEAR** or **FAR**, whichever is better in focusing.

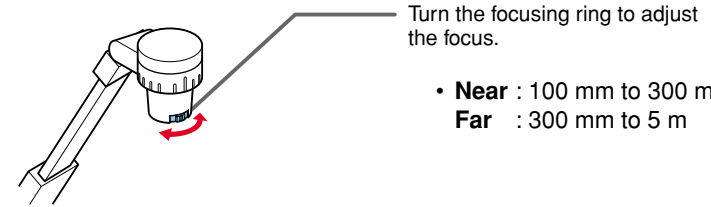

- **Near** : 100 mm to 300 mm
- **Far** : 300 mm to 5 m

⑥ If the screen is too dark or too bright, use the CAMERA GAIN (+/-) buttons to make it easier to see.

The Sharpness of the camera image can also be adjusted using the **Image adjustment menu** [p.32](#).



⑦ After use, turn off the light, and fold up the document camera.

Fold up the camera using the opposite order from **Preparation of the document camera**.

■ PRECAUTION

- If the room's fluorescent lighting causes the image to flicker, either turn off the fluorescent light, or set the **Shutter speed** from the **Default menu** [p.32](#). Note that changing the **Shutter speed** setting may not eliminate the flicker, depending on the lighting, state of the document, or image adjustment.

■ Note

- No audio is output when camera input is selected.

Using the document camera (Continued)

■ Locking the white balance

Although the projector's camera is constantly adjusting the color balance of the images it photographs, the color balance may be disrupted, depending on the color layout of the document, etc. If this happens, the white balance can be locked using the procedures below.

① Lay down a piece of white paper, and adjust so it fills the screen.

Adjust the camera head and arm so that the white paper fills the screen completely.

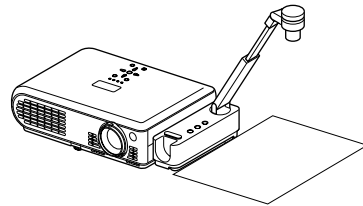

② Set the White balance to Lock in the Default menu. [p.32](#)

The white balance is locked. If you want to return to the auto adjustment, set the **White balance** to **Auto** in the **Default menu**.

■ Notes

- White balance setting to **Fixed**, if power is turned off, will be back to **Auto**.
- The color of the room lighting may prevent the white balance from being adjusted to the optimum level. In this situation, or if you want to use a certain tinting, adjust the **R-level**, **G-level** and **B-level** on the **Image adjustment menu** [p.32](#).

Air filter cleaning

The air filter prevents dust and debris from getting inside the projector. Never run the projector with the filter removed. It is recommended that the air filter is cleaned regularly.

- The icon message  "Check the air filter for dirt." is displayed every 100 hours. (If the usage time exceeds 100 hours, this message is displayed for 30 seconds when the image is displayed for the first time after power is turned on. This display will be dismissed with any operation.)
- Check out the filter and any debris is found, use the following procedure for cleaning.

⚠ WARNING

- Request cleaning and maintenance of a ceiling-mounted unit from your projector dealership.

① Unplug power cord.

② Remove the air filter.

Pull out the air filter by taking the catch shown in the figure.

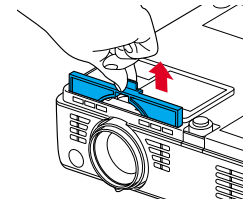

③ Clean the filter.

Carefully remove the dust and dirt from the air filter with a vacuum cleaner or the like.

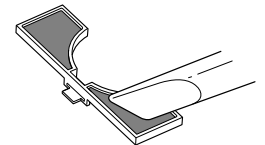

④ Replace the air filter.

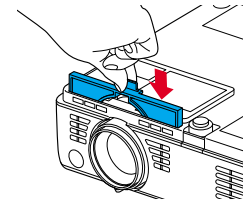

■ Notes

- Allowing dirt and dust to build up in the air filter will worsen the air circulation inside the projector, causing the internal temperature to rise, causing the projector to stop working or malfunction.
- Insert the air filter all the way in. Leaving gaps will allow dust and dirt to get inside the projector again.
- If you wash the air filter with water, make sure to dry it completely before replacing it.
- If the air filter is torn, consult with your dealer about replacing it with a new one. Continuing to use a ripped filter will allow dust and dirt to get inside the projector.

Lens and main unit cleaning

⚠ WARNING

- Request cleaning and maintenance of a ceiling-mounted unit from your projector dealership.

■ Lens cleaning

- Clean the lens with a commercially available blower and/or lens cleaner.
- The lens is easily scratched, so do not rub it with hard objects, or strike it.

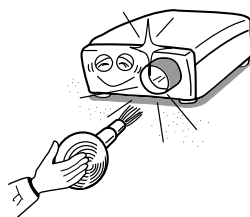

■ Main unit cleaning

- Clean the main unit after unplugging the power cord.
- Wipe dirt off the main unit gently with a soft cloth.
- If the soiling is severe, dip the cloth in a neutral detergent diluted in water, wring well, and gently wipe off the dirt, then finish up by wiping with a dry cloth.

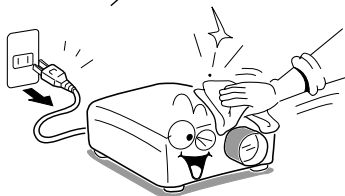

● Replacing air intake and exhaust fans, and air filter

To maintain the performance, it is recommended that these should be replaced about every 2 to 3 years. Consult with your dealer for details.

Lamp replacement

A lamp is consumable supplies. If used for extended periods, images will appear dark, and the lamp could burn out. This is characteristic of a lamp, and is not malfunction. (The lifetime of the lamp depends on condition of use. If this happens, replace it with a new one.)

⚠ WARNING

- If the projector is mounted on a ceiling, request a lamp replacement from your projector dealership.
- When replacing, always use lamp "TLPLV2" (sold separately).

⚠ CAUTION

- If you have been using the projector, the lamp will be very hot, and may cause burn injuries. Wait for the lamp to cool (for longer than 1 hour) before replacing it.
- If the lamp should break, please handle with care to avoid injury due to broken pieces and contact your dealer for repair service.

① Unplug power cord.

② Wait until lamp is sufficiently cooled.

Wait for at least 1 hour.

Lamp replacement (Continued)

③ Remove the lamp cover.

Loosen the 2 screws, then pull up to the direction of the arrow with your fingers on the area shown in the figure to remove the lamp cover.

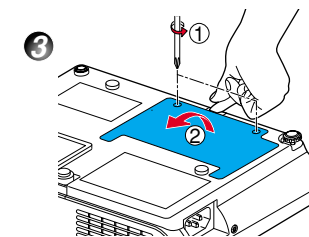

④ Pull out the lamp.

Loosen the 2 screws holding the lamp in place, and pull up the handle to remove the lamp.

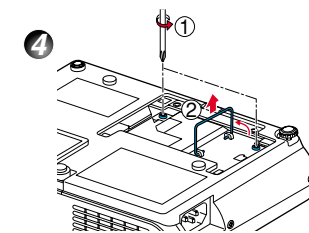

⑤ Mount the new lamp.

Align the orientation, press down until the bottom is reached, and lock in place using the two lamp locking screws.

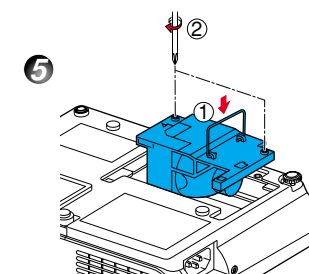



⑥ Replace the lamp cover.

Align the cover, and press it in, then tighten the screws loosened in step ③ until the lamp cover is no longer loose.

⑦ Reset the lamp timer.

See the lamp's manual for instructions on resetting the lamp timer.

■ Notes and Precautions

- Press the  button twice to display (a rough guide) the time of lamp use, the **Lamp time** item, in the **Status display menu**. [p.30](#)
- It is recommended that the lamp should be replaced after 3,000 hours of use. When **Lamp time** reaches 3,000 hours, the  icon and a message will appear. This display disappears when you press  button.
- Attach the lamp cover correctly so that it is not loose. If it is not attached correctly, the lamp may fail to come on [p.42](#), and the lamp's lifetime may be shortened.
- Always replace the lamp with a new one.
- The lamp is made out of glass. Do not touch the glass surface with your bare hands, bang it, or scratch it. (Dirt, jolts, scratches and the like could break the lamp.)

■ Used Lamps

This projector's lamps contain trace amounts of environmentally harmful inorganic mercury. Be careful not to break used lamps, and dispose it in accordance with local regulations.

Trouble indications

The indicator lights inform you of internal abnormalities.

	<p>No power</p> <p>⇒ Problem with projector</p> <ul style="list-style-type: none"> Unplug the power cord, and contact your dealer.
	<p>Lamp went out during use, or won't come on</p> <p>⇒ Lamp temperature is high so that it is difficult to turn on, the lifetime of the lamp has ended or the projector is malfunctioning.</p> <ul style="list-style-type: none"> Unplug the power cord and wait for a short while, then turn the power back on. If a lamp burns out, replace it with a new one. <p>✳ After approx. one minute of abnormal display, the projector returns to the standby state waiting for internal cool down.</p>
	<p>Power went out during use</p> <p>⇒ Internal overheating, or the outside temperature is too high.</p> <ul style="list-style-type: none"> Place the projector so that the air intake and exhaust are not blocked. Unplug the power cord and wait for a short while, then turn the power back on. Clean the air filter. p.39 <p>✳ The icon will appear before the power goes out.</p> <p>✳ After approx. one minute of abnormal display, the projector returns to the standby state waiting for internal cool down.</p>
	<p>Power went out during use</p> <p>⇒ Problem with internal cooling fan.</p> <ul style="list-style-type: none"> Unplug the power cord, and contact your dealer. <p>✳ The icon will appear before the power goes out.</p> <p>✳ After approx. one minute of abnormal display, the projector returns to the standby state waiting for internal cool down.</p>
	<p>Power went out during use, or power won't come on</p> <p>⇒ The lamp cover is not properly attached.</p> <ul style="list-style-type: none"> Unplug the power cord, and reattach the lamp cover. p.41 <p>✳ After approx. one minute of abnormal display, the projector returns to the standby state waiting for internal cool down.</p>
<p>Model with a document camera</p>	<p>Power went out during use</p> <p>⇒ Camera is not correctly connected.</p> <ul style="list-style-type: none"> Disconnect the power plug and check the connection with the camera. <p>✳ The icon will appear before the power goes out.</p> <p>✳ After approx. one minute of abnormal display, the projector returns to the standby state waiting for internal cool down.</p>

PRECAUTIONS

- Make sure to unplug the power cord if something goes wrong.
- If the power cord is unplugged before cooling is complete, give the lamp enough time to cool before plugging it back in. If the lamp overheats, it may fail to light. Unplugging the power cord repeatedly when the temperature is high will shorten the life of the lamp. (Even if you are not concerned about lamp lifetime, the light may not come on if you do not wait at least 3 minutes.)

Before calling service personnel

If you think something is wrong, check the followings before contacting customer service. Please see "Trouble indications" [p.42](#) as well.

If This Happens	Check
No power	<ul style="list-style-type: none"> Is the power cord plugged in? Is it connected to the projector? Is the lamp cover loose? p.42
Power goes out during use	<ul style="list-style-type: none"> Is the ambient temperature high? p.42 Is the air filter clogged? p.42 Is the air intake or air exhaust blocked? p.42
No picture	<ul style="list-style-type: none"> Is the projector turned on? p.24 Is the mute function on? p.28 Is the brightness setting minimized? p.32 Are the connections set up correctly? p.21 Are all the connected devices functioning properly?
No audio	<ul style="list-style-type: none"> Is the projector turned on? p.24 Is the mute function on? p.28 Is the volume setting minimized? p.25 Are the connections set up correctly? p.21 Are all the connected devices functioning properly?
Picture not displayed correctly	<ul style="list-style-type: none"> Is the input signal supported by the projector? p.46, p.47 Is the correct video mode selected? p.26 Is the correct signal format selected? p.26 Is the selecting of computer or Y/Pb/Pr input correct? p.24 Is there something generating an abnormal video signal, for instance the video tape?
Picture blurred	<ul style="list-style-type: none"> Is the lens dirty? p.40 Is the lens focus adjusted optimally? p.25
Part of picture out of focus	<ul style="list-style-type: none"> Is the projection distance within the projector's supported range? p.20 Is the projector's screen placement angle tilted too far? p.19 Are the sharpness or sampling phase adjustments off? p.26 p.32
Image is dark	<ul style="list-style-type: none"> Are the brightness or contrast adjustments off? p.32 Is the lamp nearing the end of its service life? p.30
Colors too light	<ul style="list-style-type: none"> Are the color, tint, R-level, G-level, or B-level adjustments off? p.32
Bad shading	<ul style="list-style-type: none"> Is the screen dirty? Is the lamp nearing the end of its service life? p.30
Remote control doesn't work	<ul style="list-style-type: none"> Are the remote control's batteries drained? Are the batteries inserted into the remote control correctly? p.18 Is the remote control being used within the effective range? p.18 Are there any obstructions between the remote control and projector? Are there any fluorescent or other bright lights shining at the projector's infrared remote sensor?

Before calling service personnel (Continued)

If This Happens	Check
The images from the document camera are blurry	<ul style="list-style-type: none"> Is the document imaging camera's lens dirty? Is the document imaging camera out of focus? p.37 Is the location of the object being focused too dark?
The images from the document camera are flickering	<ul style="list-style-type: none"> Is there impact from the room's fluorescent lighting? Turn off the fluorescent lights, or change the shutter speed settings. p.32

Specifications

List of general specifications

Item	Specification	
Consumption Power	265 W	
Weight	TLP-T70M/T60M/S40: 2.3 kg	
	TLP-T71M/T61M/S41: 2.8 kg	
External Dimensions (including protruding parts)	Models without document imaging camera: 303 × 84 × 206 mm (W × H × D)	
	Models equipped with document imaging camera: 358 × 84 × 206 mm (W × H × D)	
Cabinet material*	PC+ABS resin and ABS resin	
Conditions for usage environment	Temp: 0°C to 35°C; relative humidity: 30% to 70%	
LCD Panel	Display method	3-panel transmission
	Panel size	0.7 type
	Drive system	TFT active matrix
	Picture elements	TLP-T series: 786,432 pixels (1,024H × 768V) TLP-S series: 480,000 pixels (800H × 600V)
Lens	Zoom lens	TLP-T60M/T61M/S40/S41 F=2.0-2.3 f=23.0-27.4 mm
		TLP-T70M/T71M F=1.8-2.1 f=26.5-31.5 mm
Lamp	High-pressure mercury lamp	
Projection screen size	33-300 type	
Projection distance	TLP-T60M/T61M/S40/S41 : 1.26-9.73 m	
	TLP-T70M/T71M : 1.45-11.29 m	
Speaker	1 W (Monaural)	
Connection terminal	COMPUTER terminal	Mini D sub 15 pin RGB / Y/P _B /P _R (dual use)
	MONITOR terminal	Mini D sub 15 pin RGB / Y/P _B /P _R (dual use)
	S-VIDEO terminal	Mini DIN 4 pin
	VIDEO terminal	RCA Pin Jack, 1 V (p-p), 75 Ω
	AUDIO terminal	3.5mm dia. stereo mini-jack, 1.5V (rms); 22 kΩ or more
	CONTROL terminal	Mini DIN 8 pin (RS-232C)

* Each plastic part displays the materials it is made from, in order to facilitate recycling after this product becomes no longer usable.

Document camera specifications (Models equipped with document camera)

Item	Specification
Lens	F=2.8, f=2.8mm
Focusing	Switching in two steps
Zooming	None (adjusted through distance from subject)
Image element	1/4.2 type honeycomb CCD
Effective pixels for pickup section	629,856 pixels (648H × 486V × 2)

Specifications (Continued)

List of supported signals (RGB signals)

This projector supports the following RGB signals. Note, however, that depending on the computer model, the screen may show flicker or streaking. Please adjust the projector if this happens.

(Press the AUTO SET button, and adjust automatically or manually. [p.26](#))

Resolution	Mode	Refresh rate (Hz)	H-frequency (kHz)	Clock (MHz)
720 x 400	720x400_85	85.039	37.927	35.500
640 x 480	VGA_60	59.940	31.469	25.175
	VGA_72	72.809	37.861	31.500
	VGA_75	75.000	37.500	31.500
	VGA_85	85.008	43.269	36.000
800 x 600	SVGA_56	56.250	35.156	36.000
	SVGA_60	60.317	37.879	40.000
	SVGA_72	72.188	48.077	50.000
	SVGA_75	75.000	46.875	49.500
	SVGA_85	85.061	53.674	56.250
832 x 624	MAC16"	74.550	49.725	57.283
1024 x 768	XGA_43i	86.957	35.522	44.900
	XGA_60	60.004	48.363	65.000
	XGA_70	70.069	56.476	75.000
	XGA_75	75.029	60.023	78.750
	XGA_85	84.997	68.667	94.500
	MAC19"	74.700	60.134	79.857
1152 x 864	SXGA1_75	75.000	67.500	108.000
1280 x 960	QuadVGA_60	60.000	60.000	108.000
	QuadVGA_85	85.002	85.938	148.500
1280 x 1024	SXGA3_60	60.020	63.981	108.000
	SXGA3_75	75.025	79.976	135.000
	SXGA3_85	85.024	91.146	157.500
1400 x 1050	SXGA+	60.012	63.973	118.094
1600 x 1200	UXGA_60	60.000	75.000	162.000
	UXGA_65	65.000	81.250	175.500
	UXGA_70	70.000	87.500	189.000
	UXGA_75	75.000	93.750	202.500
	UXGA_85	85.000	106.250	229.500
1792 x 1344	1792x1344_60	60.000	83.640	204.750
1856 x 1392	1856x1392_60	60.000	86.333	218.250
1920 x 1440	1920x1440_60	60.000	90.000	234.000

Note

- Signals whose resolution exceeds the LCD panel's number of pixels [p.45](#) will be compressed. For this reason, some information may be lost, or image quality may be affected.

List of supported signals (Y/P_B/P_R signals)

Signal format	fh(kHz)	fv(Hz)
480i(525i)@60Hz	15.73	59.94
480p(525p)@60Hz	31.47	59.94
576i(625i)@50Hz	15.63	50.00
576p(625p)@50Hz	31.25	50.00
720p(750p)@60Hz	45.00	60.00
720p(750p)@50Hz	37.50	50.00
1080i(1125i)@60Hz	33.75	60.00
1080i(1125i)@50Hz	28.13	50.00
1035i(1125i)@60Hz	33.75	60.00
1152i(1250i)@50Hz	31.25	50.00

List of supported signals (Video, S-Video signals)

Video mode	fh(kHz)	fv(Hz)	fsc(MHz)
NTSC	15.73	60	3.58
PAL	15.63	50	4.43
SECAM	15.63	50	4.25 or 4.41
PAL-M	15.73	60	3.58
PAL-N	15.63	50	3.58
PAL-60	15.73	60	4.43
NTSC4.43	15.73	60	4.43

Pin assignment of COMPUTER & MONITOR terminals

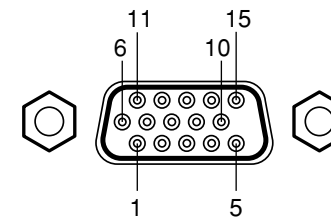

Mini D sub 15 Pin connector
Input Signal

- RGB input
 - R/G/B signals: 0.7V (p-p) 75 Ω
 - Horizontal sync signal: TTL level (Pos/neg polarity)
 - Vertical sync signal: TTL level (Pos/neg polarity)
- Y/P_B/P_R input
 - Y signal: 1.0V (p-p) 75 Ω
 - P_B/P_R signals: 0.7V (p-p) 75 Ω

Pin No.	Pin description	
	During RGB input	During Y/P _B /P _R input
1	Video signal (R)	Color difference signal (P _R)
2	Video signal (G)	Luminance signal (Y)
3	Video signal (B)	Color difference signal (P _B)
4	GND	*
5	GND	*
6	GND (R)	GND (P _R)
7	GND (G)	GND (Y)
8	GND (B)	GND (P _B)
9	N.C	*
10	GND	*
11	GND	*
12	N.C	*
13	Horizontal sync signal	*
14	Vertical sync signal	*
15	N.C	*

* Do not connect anything.

Specifications (Continued)

■ CONTROL terminal

● Pin assignment

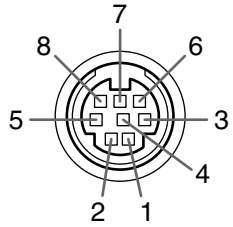

Mini DIN 8 pin connector

Pin No.	Signal Name	Description
1	RXD	Receiving data
2	CTS	Consent to send
3	DSR	Data set ready
4	GND	Signal ground
5	RTS	Request to send
6	N.C	No connection
7	TXD	Sending data
8	N.C	No connection

● Interface format

- 1 Communication method RS-232C, 9600bps, No Parity, Data Length: 8 bits;
Stop Bit Length: 1 bit
- 2 Communication format

STX (02h)	Command (3Byte)	ETX (03h)
-----------	-----------------	-----------

Only 1 command valid per communication.
- 3 Data format For input commands, only ASCII-compliant all-uppercase alphanumeric characters supported.
- 4 Replies

Acknowledge	ACK (06h)	CR (0Dh)	Data	... Normally ended
	ACK (06h)	ESC (1Bh)		... Aborted
No acknowledge	NAK (15h)			

If commands are to be sent consecutively, wait for the response from the projector before sending the next command.

● Main Commands

Item	Command
Power on	PON
Power off	POF
Icon display on	MO0
Icon display off	MO1
Auto setting (RGB input)	PAT
Status display on	DON
Status display off	DOF

Item	Command
Computer input select	IN1
Y/Pb/Pr input select	IN2
Video input select	IN3
S-video input select	IN4
Camera input select	IN5

■ Note

- Contact your dealer for control cable and other commands.

■ Separately Sold Product

Replacement Lamp Model TLPLV2

■ Note

- Design, specifications, etc. subject to change without notice for improvements, etc.

TOSHIBA CORPORATION