

***myprojectorlamps.com***

**The most trusted, dependable name  
in projector lamp sales.**



<http://www.myprojectorlamps.com>



<http://www.myprojectorlamps.ca>



<http://www.myprojectorlamps.eu>

The following projector manual has not been modified or altered in any way.

**TOSHIBA**

*OWNER'S MANUAL*

***3LCD DATA PROJECTOR***

---

**TLP-B2ultra U**

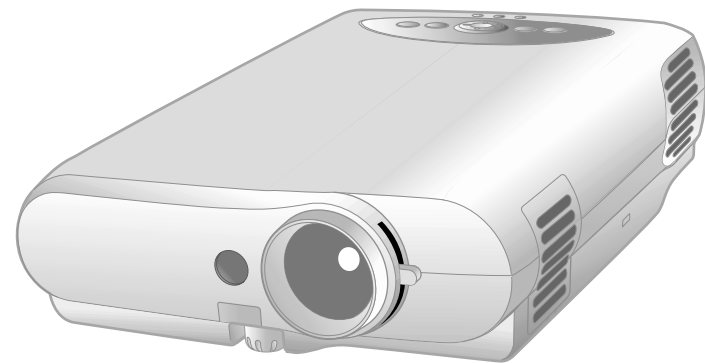

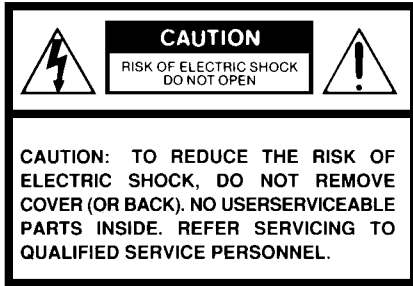

The lightning flash with arrowhead symbol, within an equilateral triangle, is intended to alert the user to the presence of uninsulated “dangerous voltage” within the product’s enclosure that may be of sufficient magnitude to constitute a risk of electric shock to persons.



The exclamation point within an equilateral triangle is intended to alert the user to the presence of important operating and maintenance (servicing) instructions in the literature accompanying the appliance.

**WARNING:** TO REDUCE THE RISK OF FIRE OR ELECTRIC SHOCK, DO NOT EXPOSE THIS APPLIANCE TO RAIN OR MOISTURE. DANGEROUS HIGH VOLTAGES ARE PRESENT INSIDE THE ENCLOSURE. DO NOT OPEN THE CABINET. REFER SERVICING TO QUALIFIED PERSONNEL ONLY.

**FCC NOTICE:** This equipment has been tested and found to comply with the limits for a Class B digital device, pursuant to part 15 of the FCC Rules. These limits are designed to provide reasonable protection against harmful interference in a residential installation.

This equipment generates, uses, and can radiate radio frequency energy and, if not installed and used in accordance with the instructions, may cause harmful interference to radio communications.

However, there is no guarantee that interference will not occur in a particular installation.

If this equipment does cause harmful interference to radio or television reception, which can be determined by turning the equipment off and on, the user is encouraged to try to correct the interference by one or more of the following measures:

- Reorient or relocate the receiving antenna.
- Increase the separation between the equipment and receiver.
- Connect the equipment into an outlet on a circuit different from that to which the receiver is connected.
- Consult the dealer or an experienced radio/TV technician for help.

**WARNING:** Changes or modifications made to this equipment, not expressly approved by Toshiba, or parties authorized by Toshiba, could void the user’s authority to operate the equipment.

**NOTICE:** This Class B digital apparatus complies with Canadian ICES-003. Cet appareil numérique de la classe B est conforme à la norme NMB-003 du Canada.

## Save Original Packing Materials

The original shipping carton and packing materials will come in handy if you ever have to ship your LCD projector. For maximum protection, repack the set as it was originally packed at the factory.

## Avoid Volatile Liquid

Do not use volatile liquids, such as an insect spray, near the unit. Do not leave rubber or plastic products touching the unit for a long time. They will mar the finish.

## Moisture Condensation

Never operate this unit immediately after moving it from a cold location to a warm location. When the unit is exposed to such a change in temperature, moisture may condense on the crucial internal parts. To prevent the unit from possible damage, do not use the unit for at least 2 hours when there is an extreme or sudden change in temperature.

In the spaces provided below, record the Model and Serial No. located at the rear of your LCD projector.

Model No. \_\_\_\_\_ Serial No. \_\_\_\_\_

Retain this information for future reference.

## DECLARATION OF CONFORMITY

TRADE NAME: LCD PROJECTOR

MODEL NAME: TLP-B2U

RESPONSIBLE PARTY: TOSHIBA AMERICA CONSUMER  
PRODUCTS, INC.

82 Totowa Rd., Wayne, NJ 07470  
U.S.A

Phone: (973) 628-8000

This device complies with part 15 of the FCC Rules.

Operation is subject to the following two conditions:

- (1) this device may not cause harmful interference, and
- (2) this device must accept any interference received, including interference that may cause undesired operation.

**CAUTION: PLEASE READ AND OBSERVE ALL WARNINGS AND INSTRUCTIONS GIVEN IN THIS OWNER'S MANUAL AND THOSE MARKED ON THE UNIT. RETAIN THIS BOOKLET FOR FUTURE REFERENCE.**

This set has been designed and manufactured to assure personal safety. Improper use can result in electric shock or fire hazard. The safeguards incorporated in this unit will protect you if you observe the following procedures for installation, use and servicing. This unit is fully transistorized and does not contain any parts that can be repaired by the user.

**DO NOT REMOVE THE CABINET COVER, OR YOU MAY BE EXPOSED TO DANGEROUS VOLTAGE. REFER SERVICING TO QUALIFIED SERVICE PERSONNEL ONLY.**

## 1. Read Owner's Manual

After unpacking this product, read the owner's manual carefully, and follow all the operating and other instructions.



## 2. Power Sources

This product should be operated only from the type of power source indicated on the marking label. If you are not sure of the type of power supply to your home, consult your product dealer or local power company.

For products intended to operate from battery power, or other sources, refer to the operating instructions.



## 3. Source of Light

Do not look into the lens while the lamp is on. The strong light from the lamp may cause damage to your eyes or sight.

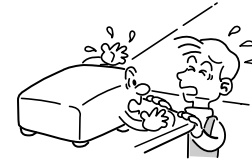

## 4. Ventilation

Openings in the cabinet are provided for ventilation and to ensure reliable operation of the product and to protect it from overheating, and these openings must not be blocked or covered. The openings should never be blocked by placing the product on a bed, sofa, rug or other similar surface. This product should not be placed in a built-in installation such as a bookcase or rack unless proper ventilation is provided or the manufacturer's instructions have been adhered to.



## 5. Heat

The product should be situated away from heat sources such as radiators, heat registers, stoves, or other products (including amplifiers) that produce heat.

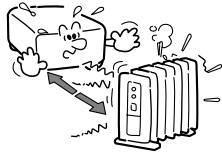

## 7. Cleaning

Unplug this product from the wall outlet before cleaning. Do not use liquid cleaners or aerosol cleaners. Use a damp cloth for cleaning.



## 9. Overloading

Do not overload wall outlets; extension cords, or integral convenience receptacles as this can result in a risk of fire or electric shock.



## 6. Water and Moisture

Do not use this product near water – for example, near a bath tub, wash bowl, kitchen sink, or laundry tub; in a wet basement; or near a swimming pool and the like.

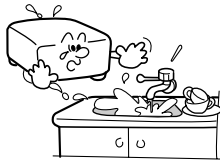

## 8. Power-Cord Protection

Power-supply cords should be routed so that they are not likely to be walked on or pinched by items placed upon or against them, paying particular attention to cords at plugs, convenience receptacles, and the point where they exit from the product.



## 10. Lightning

For added protection for this product during storm, or when it is left unattended and unused for long periods of time, unplug it from the wall outlet. This will prevent damage to the product due to lightning and power-line surges.

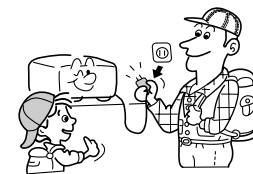

## 11. Object and Liquid Entry

Never push objects of any kind into this product through openings as they may touch dangerous voltage points or short-out parts that could result in a fire or electric shock. Never spill liquid of any kind on the product.



## 13. Stack Inhibited

Do not stack other equipment on this product or do not place this product on the other equipment. Top and bottom plates of this product develops heat and may give some undesirable damage to other unit.

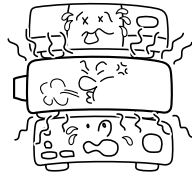

## 12. Do not place the product vertically

Do not use the product in the upright position to project the pictures at the ceiling, or any other vertical positions. It may fall down and dangerous.

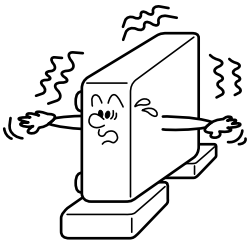

## 14. Attachments

Do not use attachments not recommended by the product manufacturer as they may cause hazards.

## 15. Accessories

Do not place this product on an unstable cart, stand, tripod, bracket, or table. The product may fall, causing serious injury to a child or adult, and serious damage to the product. Use only with a cart, stand, tripod, bracket, or table recommended by the manufacturer, or sold with the product. Any mounting of the product should follow the manufacturer's instructions, and should use a mounting accessory recommended by the manufacturer. A product and cart combination should be moved with care. Quick stops, excessive force, and uneven surfaces may cause the product and cart combination to overturn.



## 16. If glass components, including lens and lamp, should break, contact your dealer for repair service.

This product incorporates glass components, including a lens and a lamp. If such parts should break, please handle with care to avoid injury and contact your dealer for repair service. The broken pieces of glass may cause to injury.

## 17. Coin-shaped Battery

- a) Keep coin-shaped batteries out of children's reach. Be careful not to be taken internally, especially by children, as it may cause poisoning.
- b) Do not load a battery into the remote control the wrong side out.
- c) Do not charge, heat, open, or short-circuit the batteries. Do not throw the batteries into a fire.
- d) Do not leave a dead or exhausted battery in the remote control.
- e) If you do not use the remote control for a long period of time, remove the battery to avoid possible damage from battery corrosion.



## 18. Keeping of Coin-shaped Batteries

After unpacking coin-shaped batteries, keep them in poly bags, etc. separately one by one when unused. If you leave them unwrapped, they may be short-circuited by metal objects, resulting in battery leakage, heat or burst. These may cause burns or injury.

The batteries must be completely discharged when they are deposited in collection containers for old batteries in shops and at public collection sites. If a charge remains, countermeasures against short circuits have to be taken.

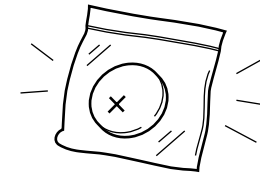



## 19. Damage Requiring Service

Unplug this product from the wall outlet and refer servicing to qualified service personnel under the following conditions:

- a) When the power-supply cord or plug is damaged.
- b) If liquid has been spilled, or objects have fallen into the product.
- c) If the product has been exposed to rain or water.
- d) If the product does not operate normally by following the operating instructions. Adjust only those controls that are covered by the operating instructions as an improper adjustment of other controls may result in damage and will often require extensive work by a qualified technician to restore the product to its normal operation.
- e) If the product has been dropped or damaged in any way.
- f) When the product exhibits a distinct change in performance – this indicates a need for service.

## 20. Servicing

Do not attempt to service this product yourself as opening or removing covers may expose you to dangerous voltage or other hazards. Refer all servicing to qualified service personnel.



## 21. Replacement Parts

When replacement parts are required, be sure the service technician has used replacement parts specified by the manufacturer or have the same characteristics as the original part. Unauthorized substitutions may result in fire, electric shock, or other hazards. (Replacement of the lamp only should be made by users.)



## 22. Safety Check

Upon completion of any service or repairs to this product, ask the service technician to perform safety checks to determine that the product is in proper operating condition.



# Power supply cord selection

If your line voltage is 220 to 240V, use one of the following types of cable.

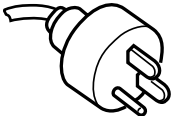
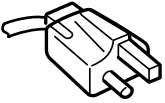
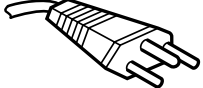
Plug configuration	Plug type	Line voltage
	EURO 240V 10 – 15A	220 – 240V
	UK 240V 6A	200 – 240V
	Australian 240V 10A	200 – 240V
	North American 240V 15A	200 – 240V
	Switzerland 240V 6A	200 – 240V

## Before use

---

<i>SAFETY PRECAUTIONS</i> .....	<b>2</b>
<i>IMPORTANT PRECAUTIONS</i> .....	<b>3</b>
<i>IMPORTANT SAFETY INSTRUCTIONS</i> .....	<b>4</b>
<i>Power supply cord selection</i> .....	<b>9</b>
<i>Names of each part on the main unit</i> .....	<b>11</b>
<i>Names of each part on the remote control</i> .....	<b>13</b>
<i>Loading a battery</i> .....	<b>14</b>
<i>Remote control operation</i> .....	<b>15</b>

## Installation and connections

---

<i>Floor-mounted projector placement</i> .....	<b>16</b>
<i>Projector placement angle adjustment</i> .....	<b>19</b>
<i>Ceiling-mounted projector placement</i> .....	<b>20</b>
<i>Connecting an IBM PC or compatible computer (DOS/V) ...</i>	<b>21</b>
<i>Connecting a Macintosh computer</i> .....	<b>22</b>
<i>Connecting video equipment</i> .....	<b>23</b>
<i>Projector operation control by a computer</i> .....	<b>24</b>

## Operations

---

<i>Projection on the screen</i> .....	<b>25</b>
<i>Turning the power off</i> .....	<b>28</b>
<i>Correcting the keystone distortion</i> .....	<b>29</b>
<i>Cutting off the picture and sound temporarily</i> .....	<b>30</b>
<i>Freezing the picture</i> .....	<b>31</b>
<i>Enlarging the picture size</i> .....	<b>32</b>

## Adjustments

---

<i>Menu screen structure</i> .....	<b>33</b>
<i>Quick menu setting</i> .....	<b>34</b>
<i>Adjusting picture (Picture adjustment)</i> .....	<b>36</b>
<i>Adjusting Image (Image adjustment)</i> .....	<b>38</b>
<i>Adjusting RGB-level (Level adjustment)</i> .....	<b>40</b>
<i>Adjusting audio output (Audio adjustment)</i> .....	<b>42</b>
<i>Setting the input signal (Signal setting)</i> .....	<b>44</b>
<i>Setting the display method (Display setting)</i> .....	<b>47</b>
<i>Default setting</i> .....	<b>49</b>
<i>Reset, Status display (Data setting)</i> .....	<b>52</b>

## Maintenance

---

<i>Trouble indications</i> .....	<b>54</b>
<i>Air filter cleaning</i> .....	<b>55</b>
<i>Lens and main unit cleaning</i> .....	<b>56</b>
<i>Lamp replacement</i> .....	<b>57</b>

## Others

---

<i>Before calling service personal</i> .....	<b>59</b>
<i>Signal assignment for RGB input</i> .....	<b>60</b>
<i>Applicable RGB signal</i> .....	<b>61</b>
<i>Controlling the projector by using RS-232C</i> .....	<b>62</b>
<i>Specifications</i> .....	<b>64</b>
<i>LIMITED WARRANTY</i> .....	<b>66</b>

# Names of each part on the main unit

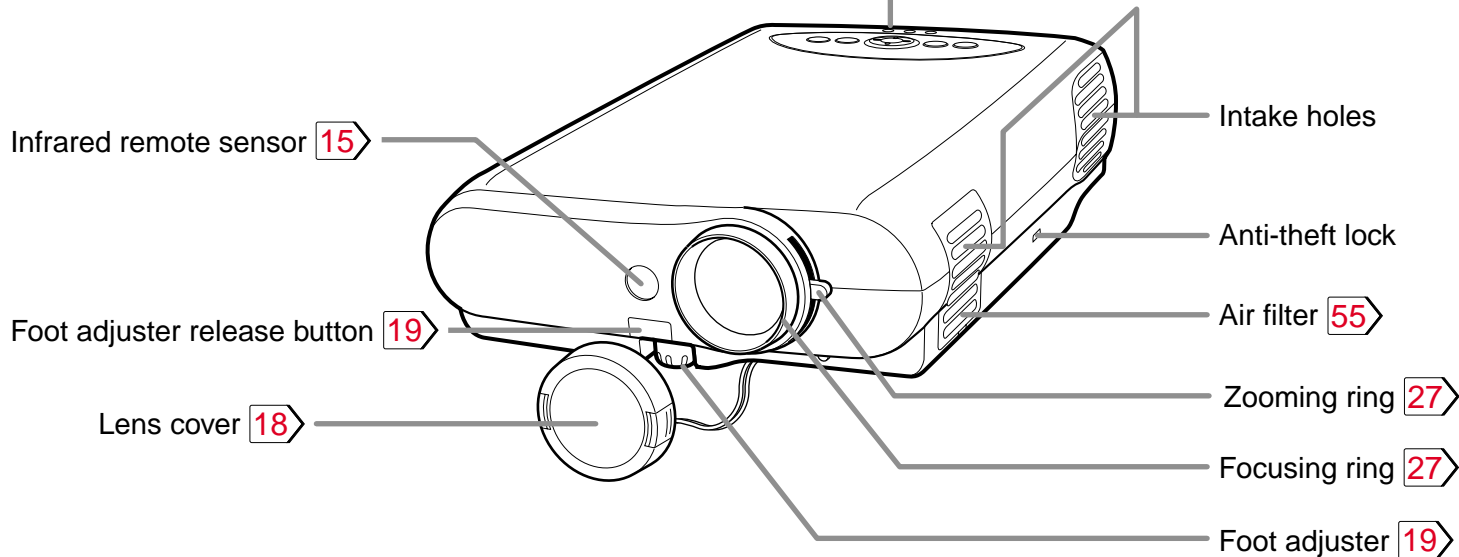
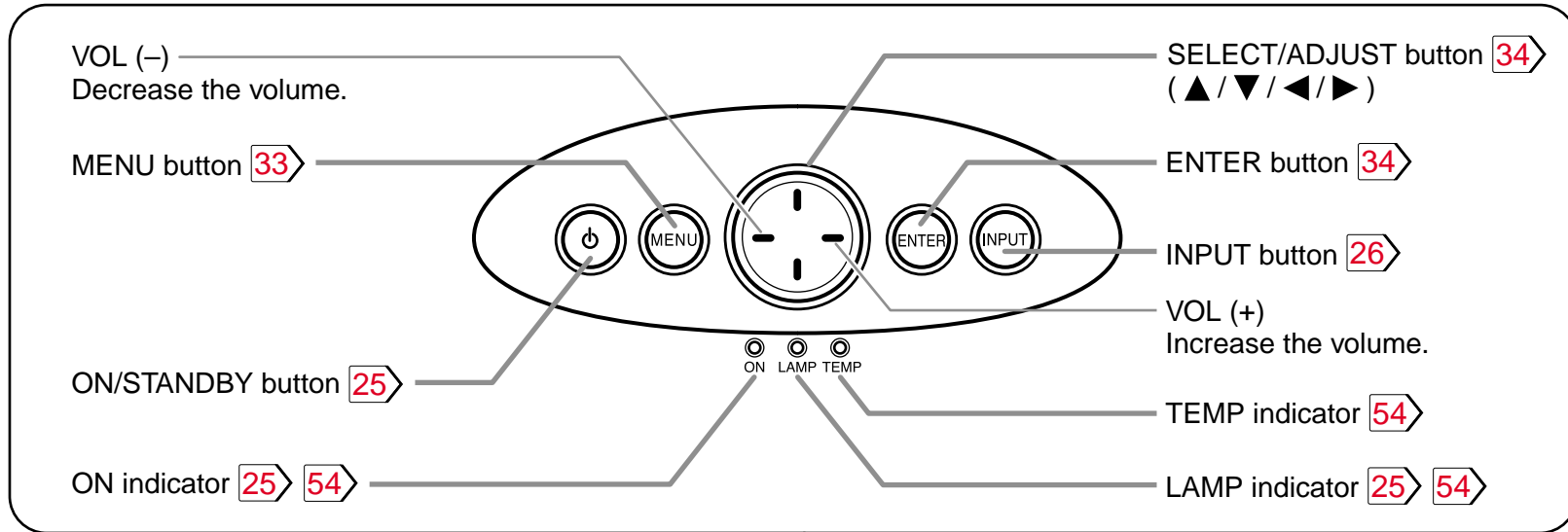

# Names of each part on the main unit (Continued)

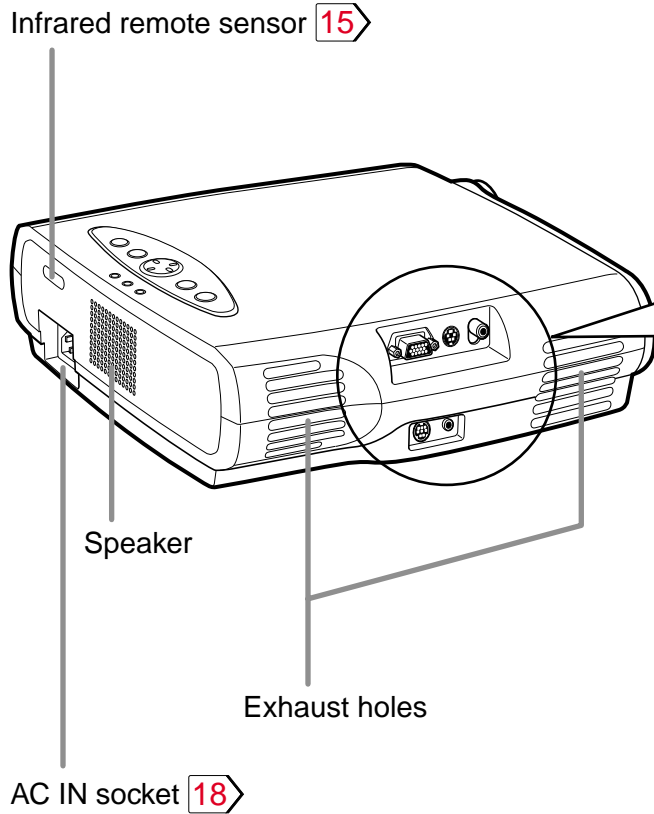

RGB connector 21  
To enter RGB signal from a computer, etc.

S-VIDEO jack 23  
To enter S video signal from a video equipment, etc.

VIDEO jack 23  
To enter video signal from a video equipment, etc.

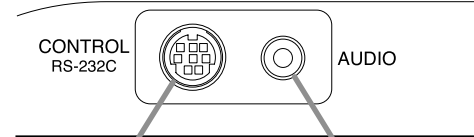
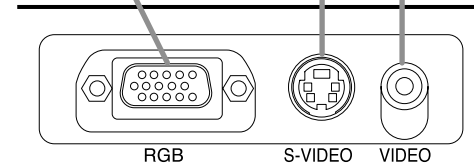

CONTROL connector (RS-232C Connector) 24 62  
To connect a computer to control the projector.

AUDIO jack (ø3.5mm stereo mini-jack) 21 23  
To enter audio signal from a computer or video equipment, etc.

# Names of each part on the remote control

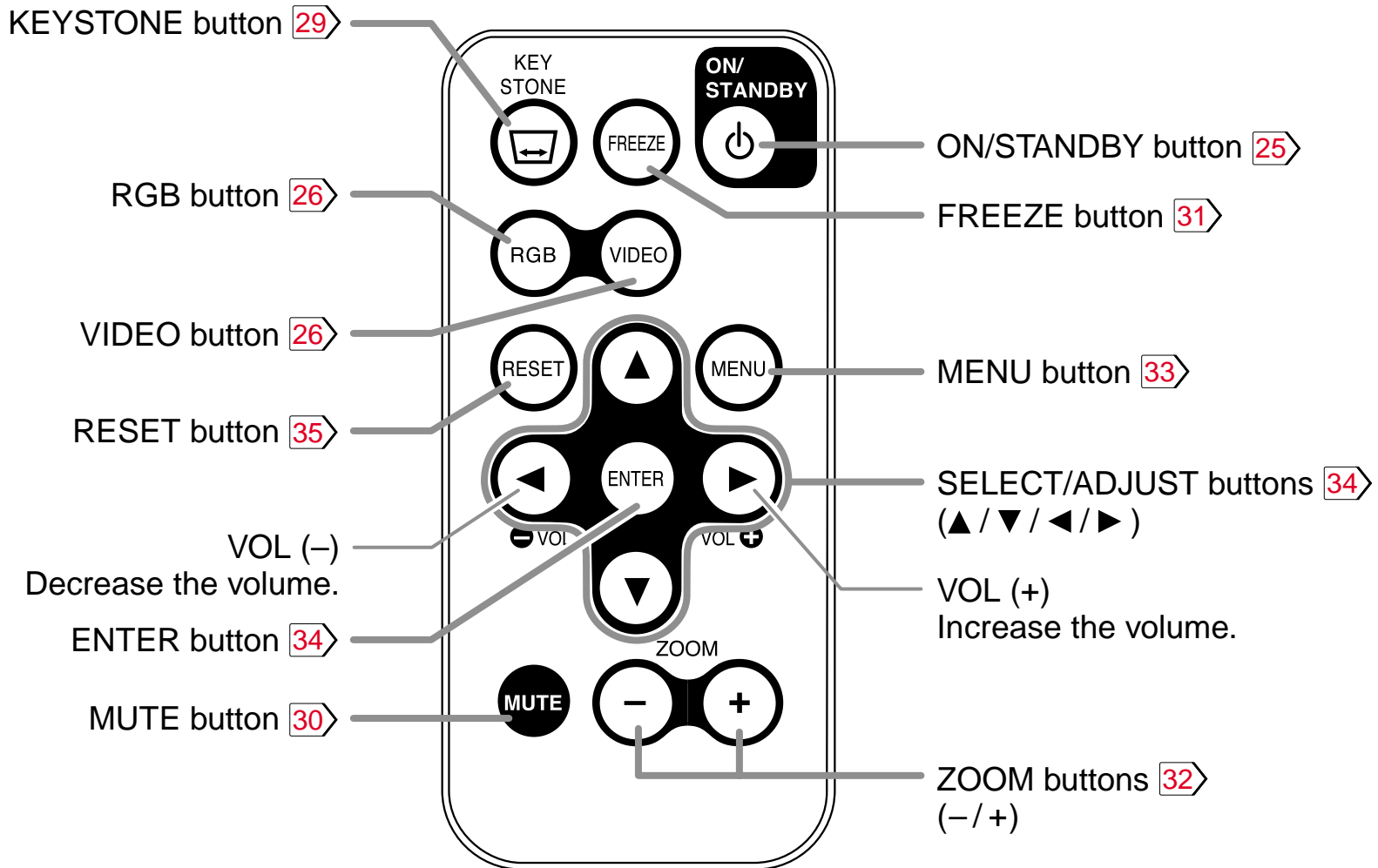

# Loading a battery

The remote control already contains battery.  
Remove the sheet before using.  
Follow the steps below when loading the battery.

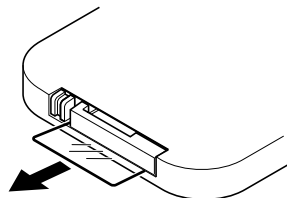
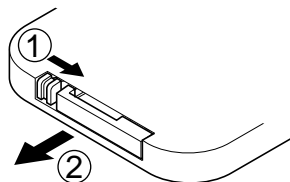
**1**

While pushing the holder in the direction 1, slide it out in the direction 2.

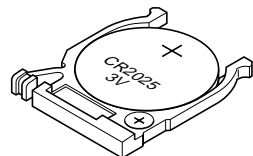
**2**

Set a coin-shaped battery (CR2025) with the + side up on the holder.

Keep the holder horizontally so that the battery will not fall through.

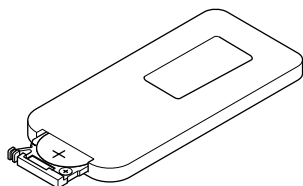
**3**

Push back the holder.

## Notes on coin-shaped batteries

- If the remote control does not function correctly or if the operating range becomes reduced, replace the battery with new one.
- See  for safety use of coin-shaped batteries.

# Remote control operation

Point the remote control at the infrared remote sensor and press a button.

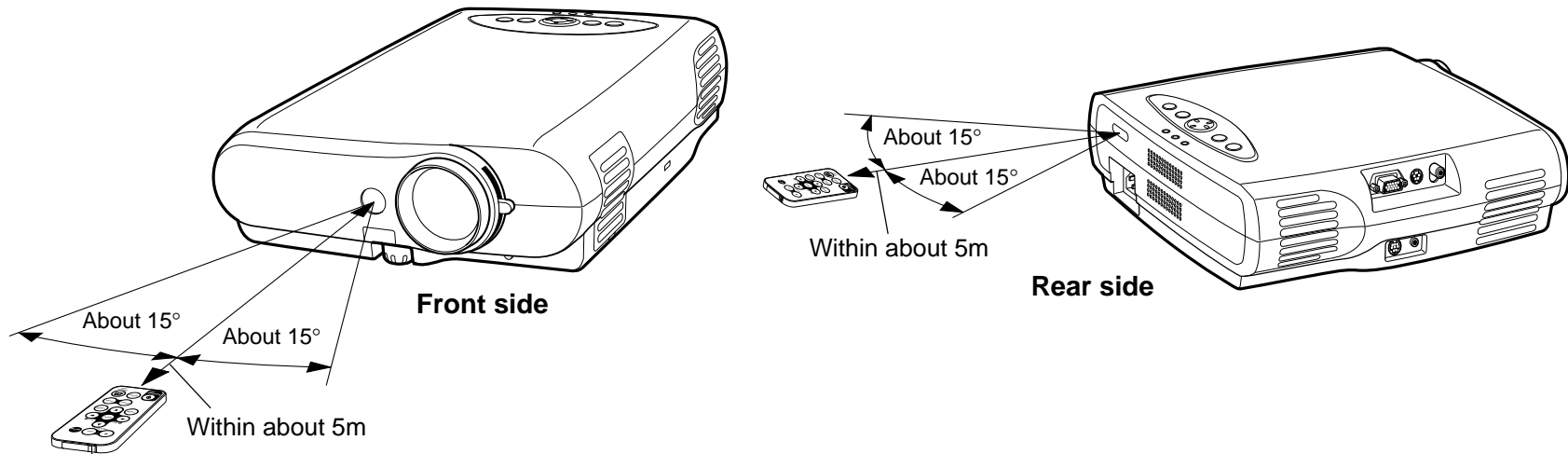

## Notes

- The remote control may not operate when there is sunlight or other strong light such as a fluorescent lamp shining on the remote sensor.
- Operate the remote control from a position where the remote sensor is visible.
- Do not drop the remote control or otherwise jolt it.
- Keep the remote control out of locations with excessively high temperature or humidity.
- Do not get water on the remote control or place wet objects on it.
- Do not disassemble the remote control.
- Under unusual circumstances the remote control may not operate well due to the location being used or the surroundings. At such times, change the direction of the remote control to the projector and retry the operation.



# Floor-mounted projector placement

There are two ways of floor-mounted projector placement. Perform the “Projection mode” setting on the menu screen for the projection method. [49](#)

For the ceiling-mounted projector placement, refer to the page [20](#) .

## Floor-mounted front projection

Viewing a picture projected on the front of the screen from a floor.

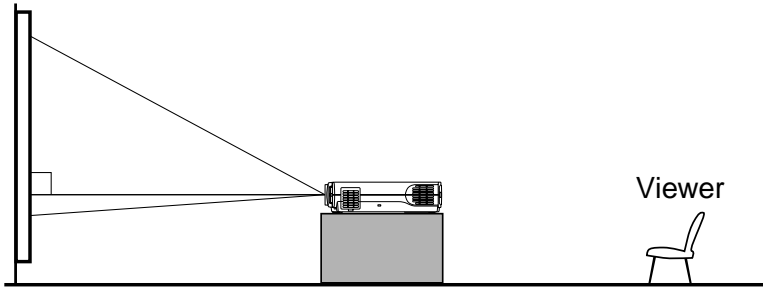

## Floor-mounted rear projection

Viewing a picture projected through the back of the screen from a floor installation.

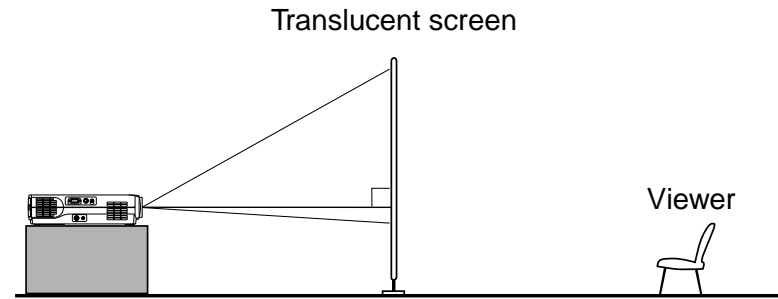

## 1 Place the projector on a steady, level surface such as a table.

To obtain proper screen projected, place the projector so that the projecting light hits the screen squarely.

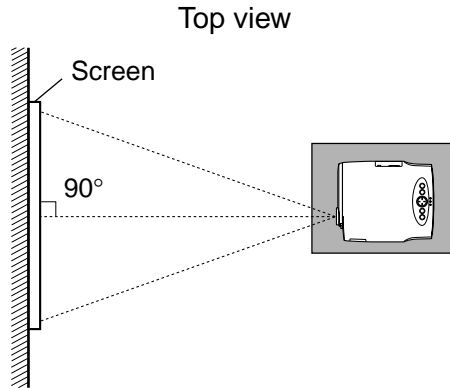

Point the lens straight at the center of the screen as above.

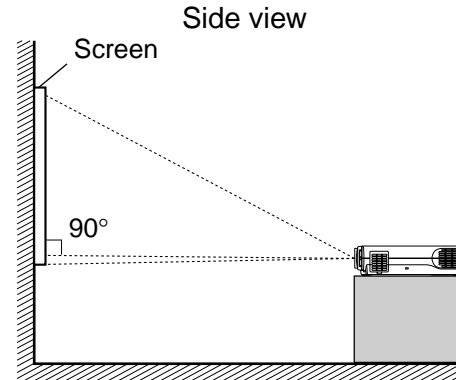

Place the projector horizontally so that the projecting light hits the screen squarely.

## 2 Determine the screen size projected on the screen.

The projection size depends on the distance between the lens and the screen. Adjust the projection size by changing the distances as shown below.

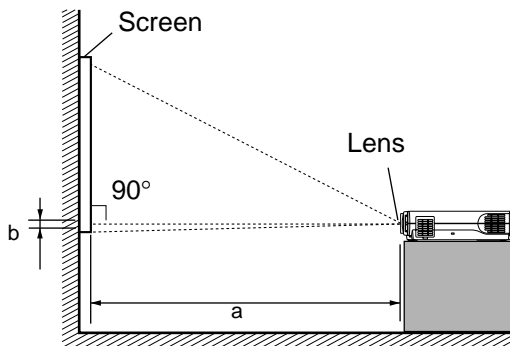

- a: Distance between the lens and the screen
- b: Distance between the lens height and the bottom of projection area

Projection size (inches)	a (m)		b (cm)
	Minimum (At maximum zoom)	Maximum (At minimum zoom)	
25	—	1.15	3.5
40	1.55	1.88	6.1
60	2.35	2.84	9.1
80	3.14	3.8	12.2
100	3.94	4.76	15.2
150	5.94	7.17	22.9
200	7.93	9.57	30.5
250	9.93	—	38.1

• The values are approximations.

## 3 Connect the power cord.

- Insert one end in the AC IN socket on the projector.
- Insert the other end in a wall outlet.

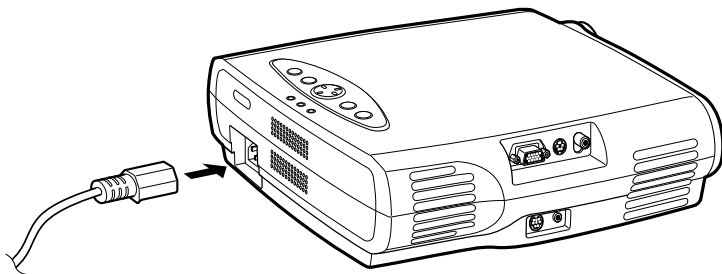

Control panel on the main unit

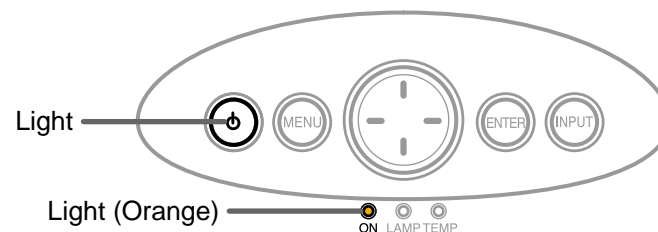

The ON indicator lights in orange and the projector turns to standby mode. The  mark of ON/STANDBY on the main unit will also light.

## 4 Take off the lens cover.

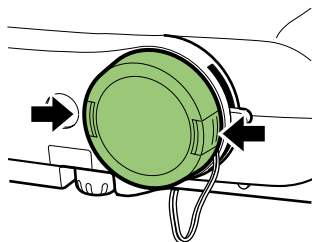

Push both sides of the lens cover to take off.

### Notes

- Select a room that can be darkened.
- When the projector is moved from a cold location to a warm location, or when the ambient temperature in the projection room has risen suddenly, moisture may condense on the lens or the mirror to blur the projected pictures. In such a case, leave the projector for an adequate time (1 to 2 hours, depending on the room's condition) before using it so it adjusts to the ambient temperature.
- If the screen is exposed to direct sunlight or other strong light, the projected picture becomes too faint to see. Shut out the light with curtains or other means.
- If the screen and the projector are not installed properly, the projected picture may be distorted.

# Projector placement angle adjustment

The tilt of the projector can be adjusted using the foot adjuster.

1

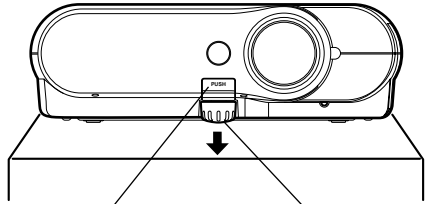

Foot adjuster  
release button

Foot adjuster

**Lift the front of the projector until a tilt angle desired is obtained and hold down the foot adjuster release button.**

The foot adjuster will stretch.

Release the button to lock in position.

2

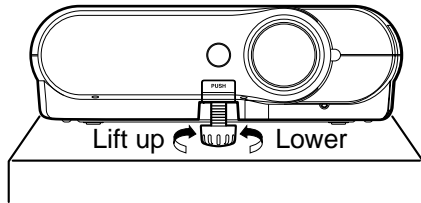

Lift up   Lower

**Turn the foot adjuster to make fine adjustment of the height.**

Turn clockwise to lift up.

Turn counterclockwise to lower.

## Notes

- To put the foot adjuster back, hold down the foot adjuster release button and lower the front slowly.
- Be sure to hold the projector when putting the foot adjuster back so as not to let the front fall on your fingers.

## CAUTION

When a ceiling mount is required, please consult with the dealer.

### Ceiling-mounted front projection

Viewing a picture projected on the front of the screen from a ceiling installation.

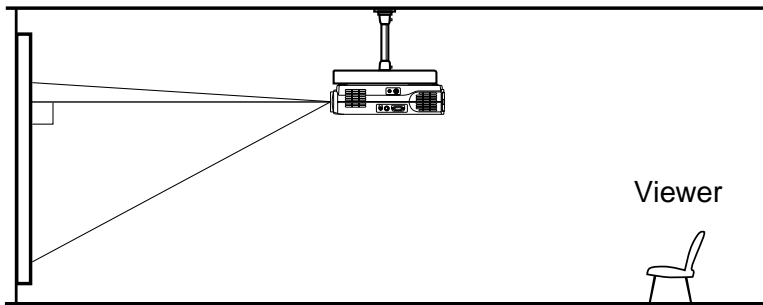

### Ceiling-mounted rear projection

Viewing a picture projected through the back of the screen from a ceiling installation.

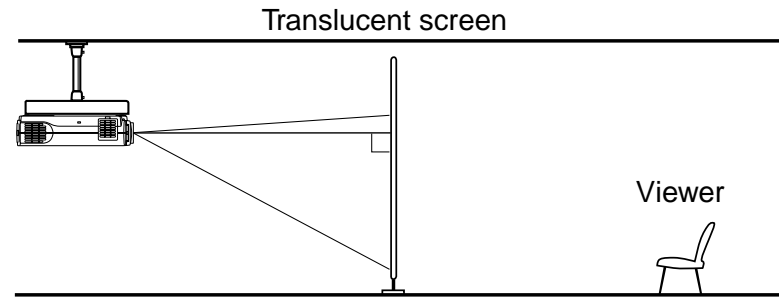

Perform the "Projection mode" setting on the menu screen for the projection method.  49

# Connecting an IBM PC or compatible computer (DOS/V)

You can project the picture from the computer.

Check that the power for the projector and computer is off before connecting the cables.

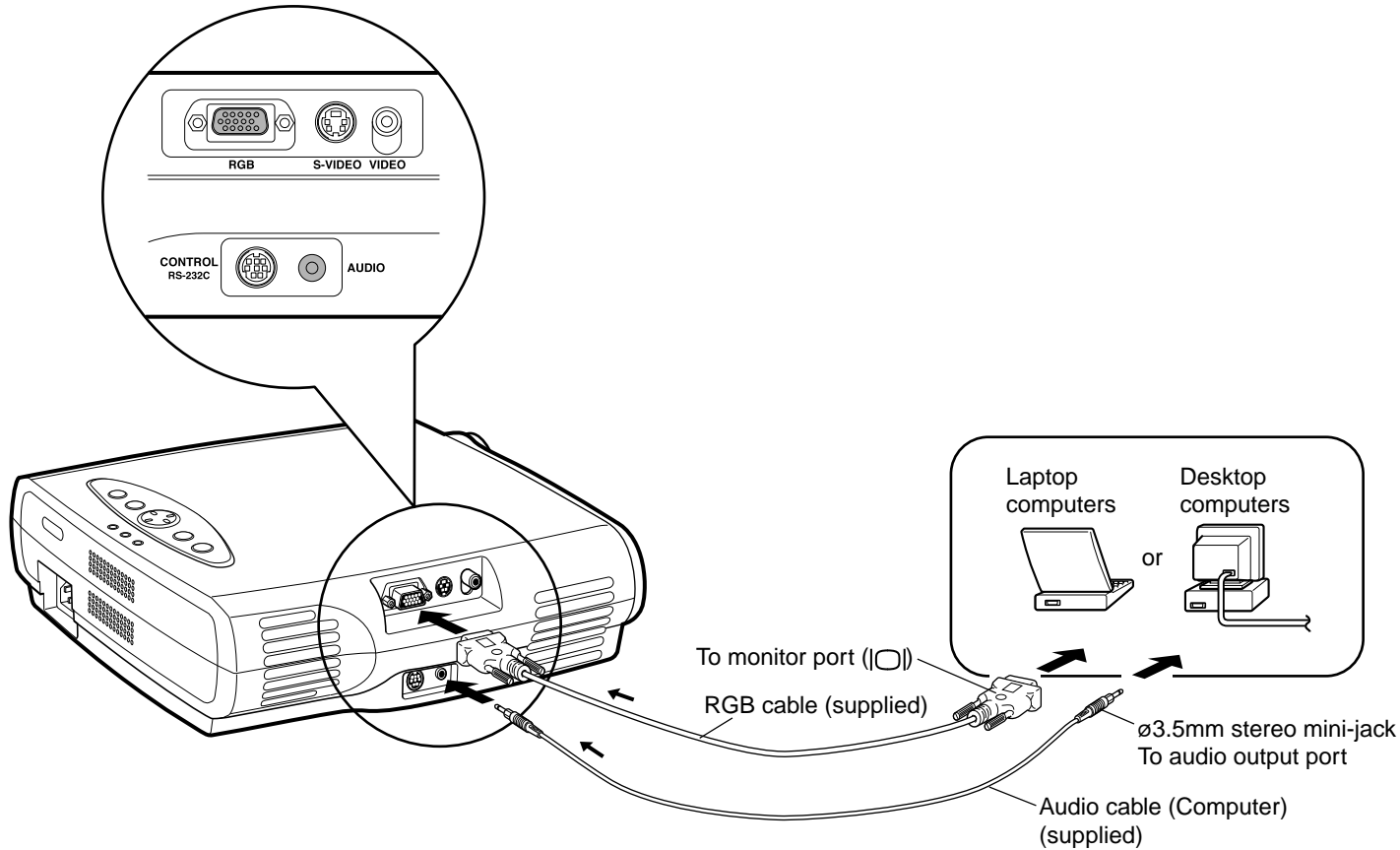

## Notes

- The projector cannot be connected to a computer that does not have an analog RGB output terminal. For details, refer to the computer manual.
- You may not be able to connect some computers to the projector. For details, consult the dealer.
- Some computers may have output modes which are not compatible with this projector. Check the compatibility of the connectors, signal levels, timing, and resolutions.

# Connecting a Macintosh computer

You can project the picture from the computer.

Check that the power for the projector and computer is off before connecting the cables.

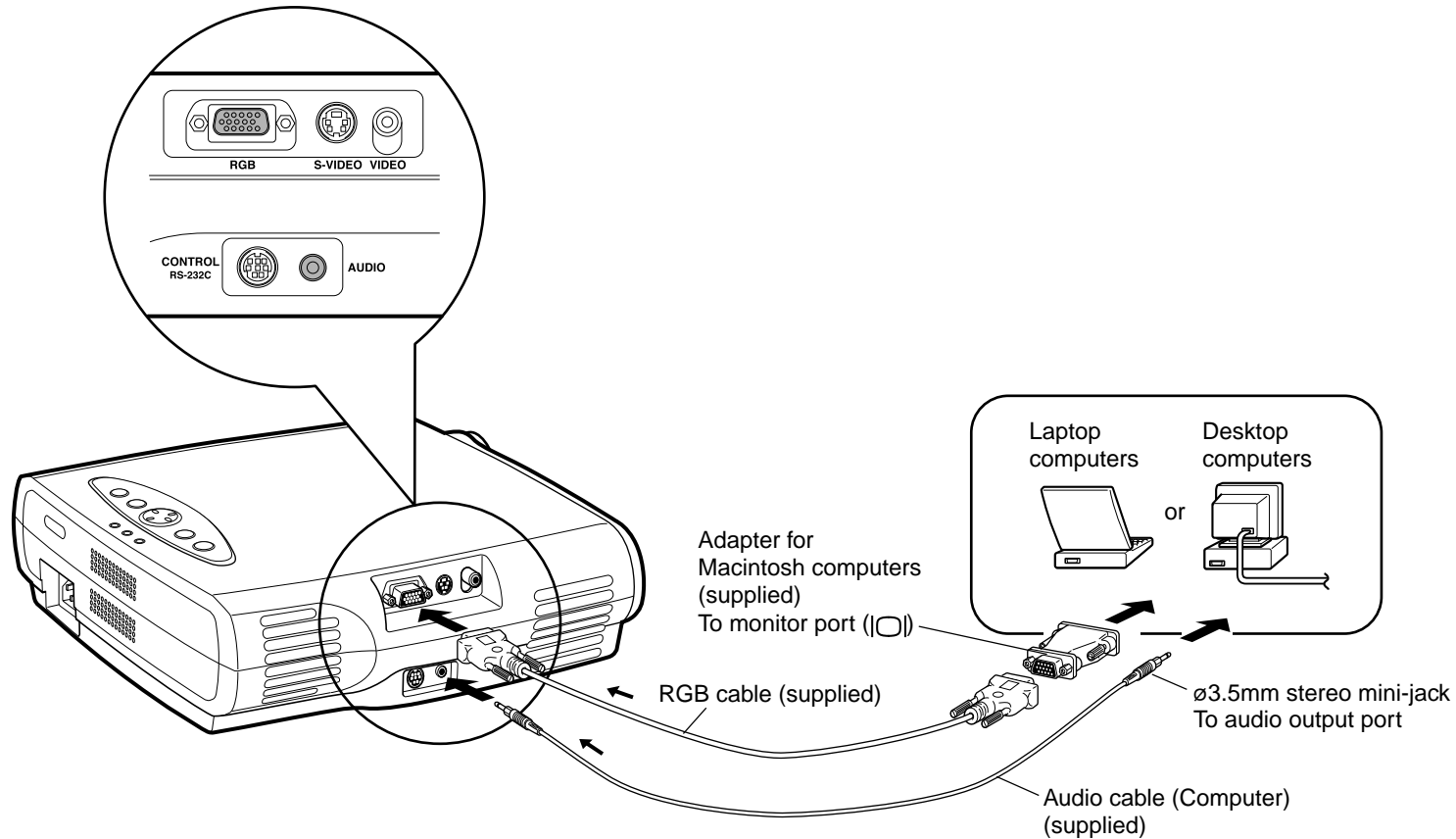

## Notes

- The projector cannot be connected to a computer that does not have an analog RGB output terminal. For details, refer to the computer manual.
- You may not be able to connect some computers to the projector. For details, consult the dealer.
- The adapter for Macintosh computers is conformable to MULTIPLE SCAN 21.
- Some computers may have output modes which are not compatible with this projector. Check the compatibility of the connectors, signal levels, timing, and resolutions.

# Connecting video equipment

You can project the picture from video equipment.  
Check that the power for the projector and video equipment is off before connecting the cables.

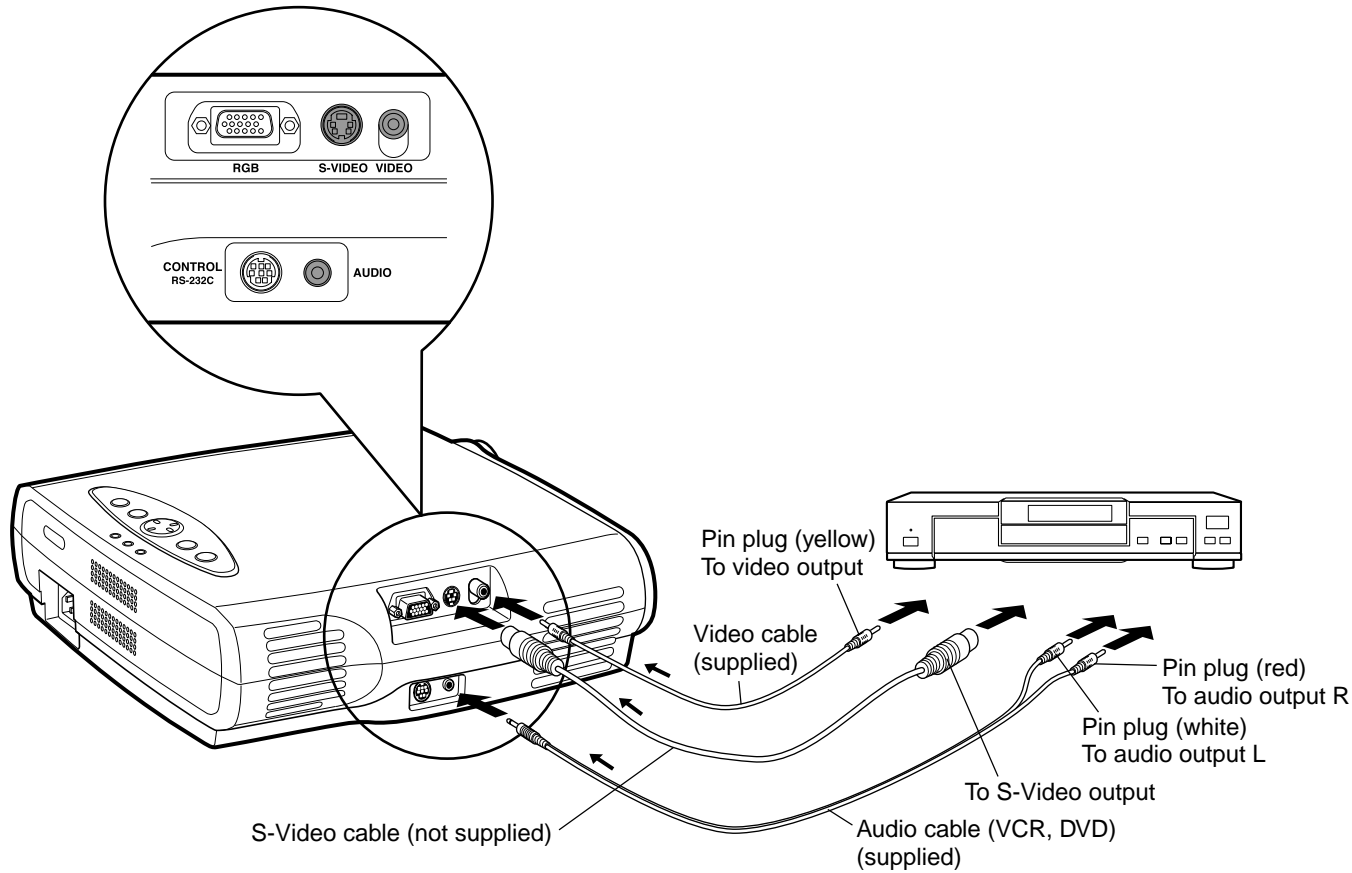

**Note**

Signal input to the S-VIDEO jack takes priority over that to the VIDEO jack.



# Projector operation control by a computer

You can control the projector by connecting a computer to the CONTROL connector (RS-232C Connector). 62  
Check that the power for the projector and computer is off before connecting the cables.

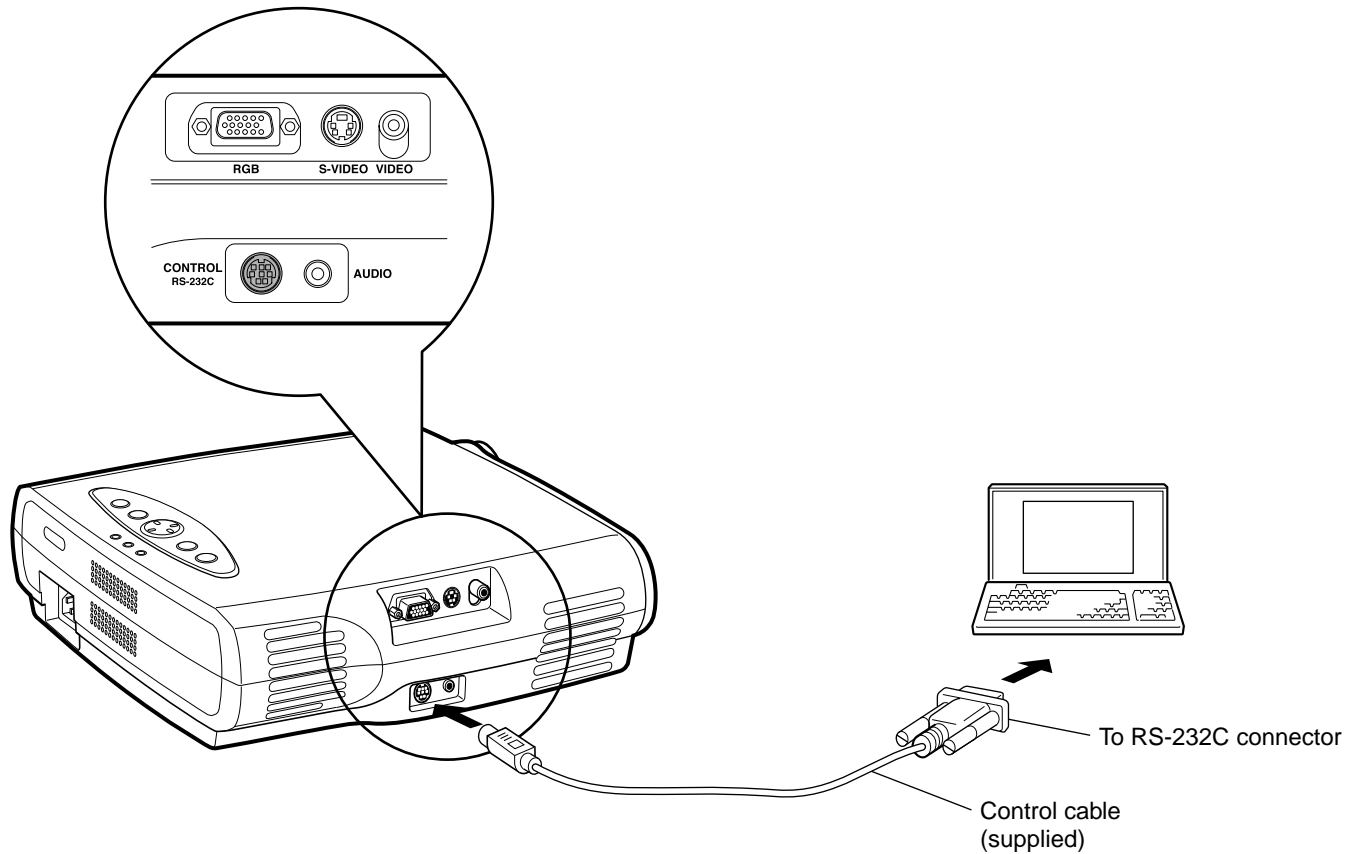

**Note**

Do not connect a cable other than the exclusive one attached.

**CAUTION** – Do not look into the projection lens while operating the projector.

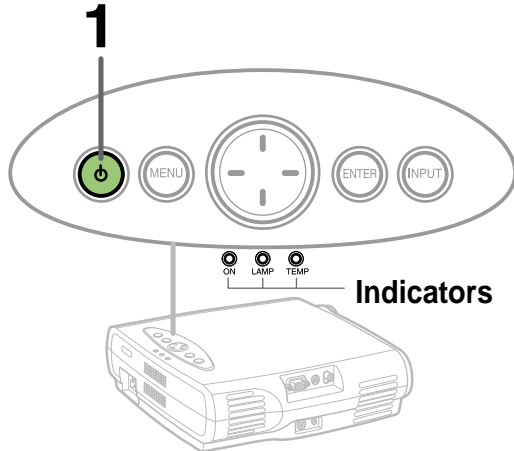

## Preparation

- 1 Install and connect the projector properly.
- 2 Take off the lens cover.

# 1



### Press ON/STANDBY.

The projector turns on and both the ON and LAMP indicators light up in green.

All of the buttons on the main unit will also light.

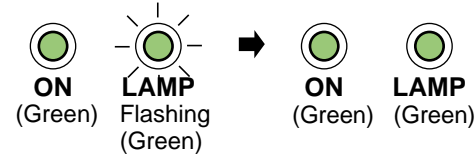

The lamp lights and the start up display appears.

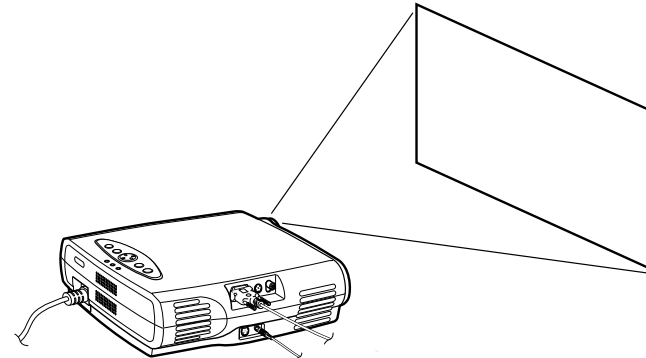

# 2

### Turn on the connected equipment and put it in playback mode.

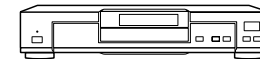

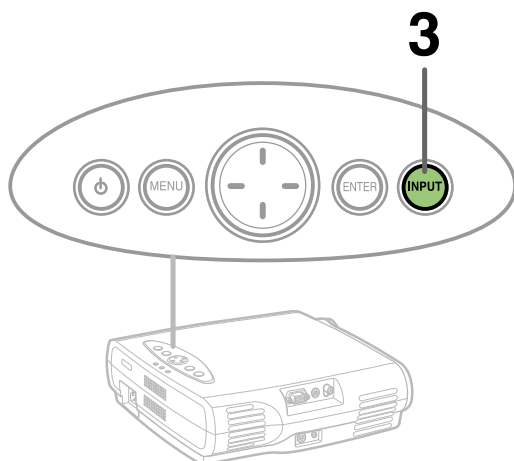
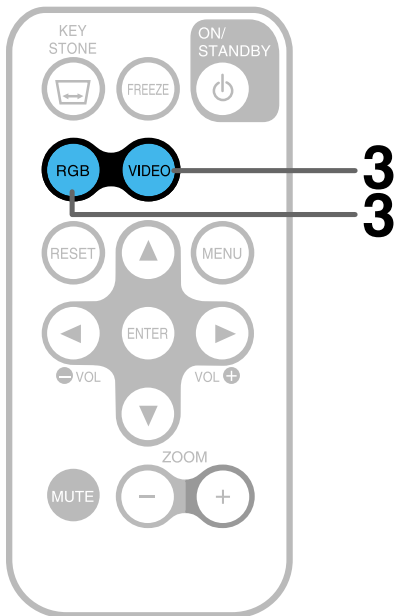
**3**

RGB or VIDEO

**Select the input source.**

On the remote control, press RGB or VIDEO.

INPUT

On the control panel of the main unit, press INPUT repeatedly.

Each time the button is pressed, the source indication on the screen changes as follows:

 : To project pictures from a computer connected to RGB connector.

 or  : To project pictures from a video player connected to VIDEO connector or S-VIDEO connector.

(Signal sent from the computer)

- If you project an image from a computer with an LCD screen while monitoring the image on the computer, the image may not be projected properly, depending on the computer model. In this case, turn off the computer display. For details on controlling the computer display, etc., refer to the computer's manual and description on the software for the computer used.
- When a signal of the blackish screen whose edges are dark is input, it may not be displayed normally. If this happens, input a signal whose picture is bright and whose frame is clear, then press the remote control unit's RGB button again.
- The projector projects an image by XGA signal (1024 x 768) in full screen.
- VGA, SVGA signal project the image by enlarging in full screen size, the image quality could be slightly degraded. SXGA signal can be projected since the projector has simplified compatibility with them. (However, letters and lines can be unequal or a part can be missing. Some signals may not be projected at all.)
- It is recommended to set an external monitor connected to the computer to XGA mode (1024 x 768).
- The projector can be also applied to DDC2B (Display Data Channel 2B). If your computer is applied to the DDC, start up your computer after turning on the projector.

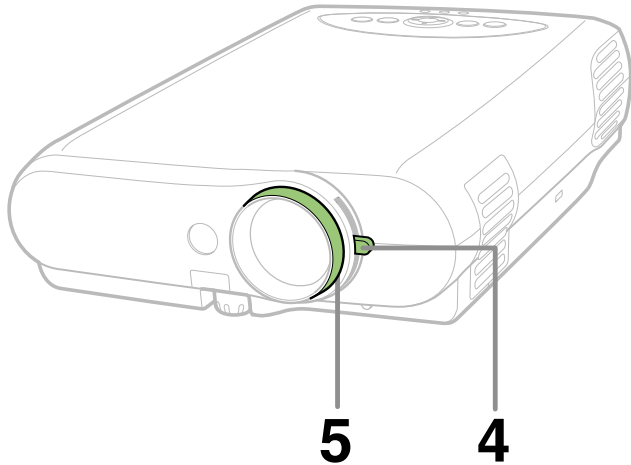
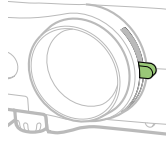
**4**

**Adjust the picture size by turning the zooming ring.**



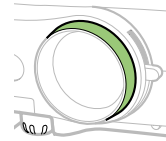

Turn to the right to enlarge the picture.  
Turn to the left to reduce the picture.

**5**

**Focus on the picture by turning the focusing ring.**

A still picture is recommended for focusing.

## Notes

- When changing the projecting angle, adjust the foot adjuster. [19](#)
- When the screen image is distorted in keystone, press the KEYSTONE button on the remote controller. [29](#)
- “” is displayed on the screen if the projector does not receive any signal from the connected equipment. Put the equipment in playback mode.
- Due to the lamp characteristic, flickers may occasionally occur in a picture. This is not malfunction of the unit.
- While operating the projector, “” may be displayed on the screen. This means that the operation cannot be completed.
- “” is displayed on the screen if:
  - The projector is too hot. Turn the projector off, and leave it for a while, and then turn it on again.
  - The ambient temperature is too high, use the projector under moderately cold temperature.
- “” is displayed on the screen if the air filter is dusty, the ventilation is impaired. This may cause the temperature inside the projector to rise. Clean the air filter. [55](#)

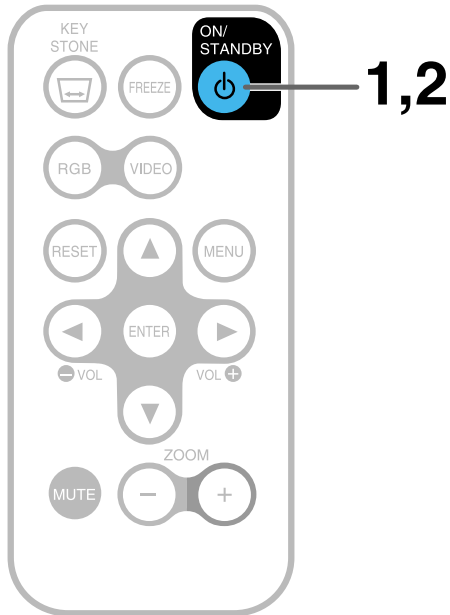

1



**Press ON/STANDBY after using the projector.**

An instruction message appears.



2



**Press ON/STANDBY again.**

The LAMP indicator turns off, and the projector turns to standby mode. (The ON indicator lights in orange.)

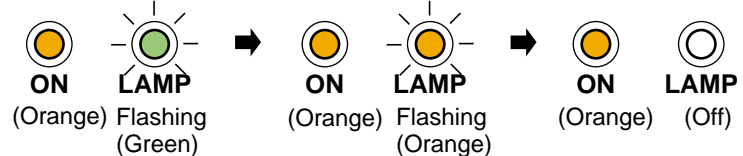

3

**After confirming the LAMP indicator turns off, unplug the power cord.**

The ON indicator turns off.

### Notes

- Immediately after the power off, the projector may not be turned on while the LAMP indicator is flashing in green.
- Even after turning the power off, the intake and exhaust fans continue to work for a while to cool the inside of the projector. (When the lamp indicator is flashing in orange.)
- Before unplugging the power cord, make sure that the LAMP indicator is turned off.

1,2

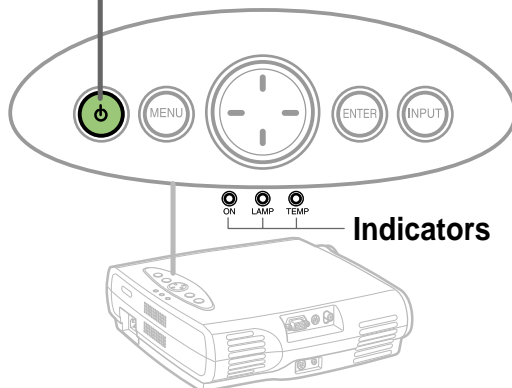

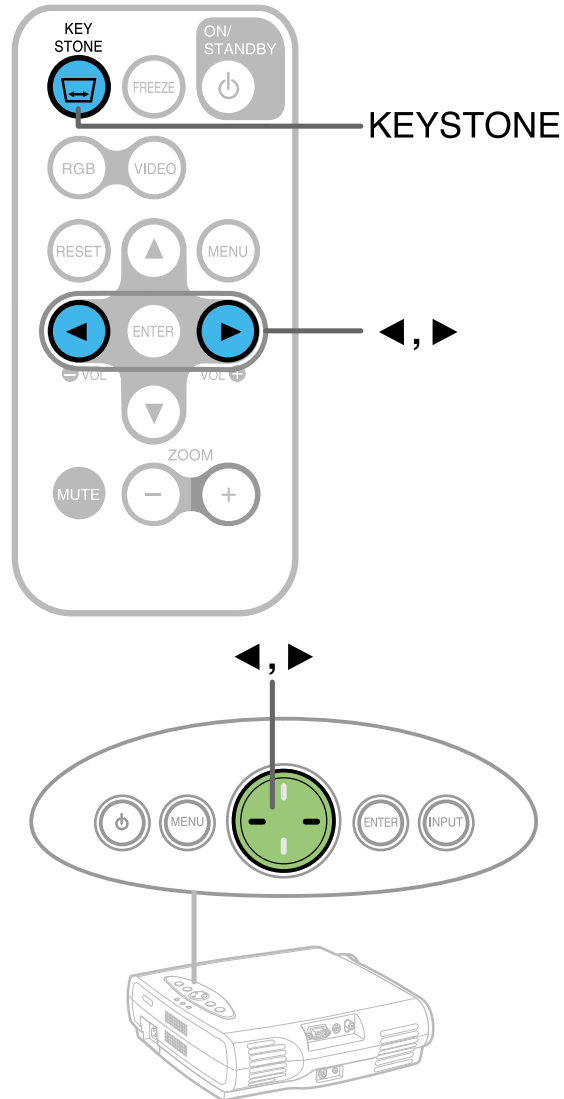

A picture may be expanded on the upper side if projected upward from the projector lifted up by the foot adjuster. The projector can correct this keystone distortion automatically.

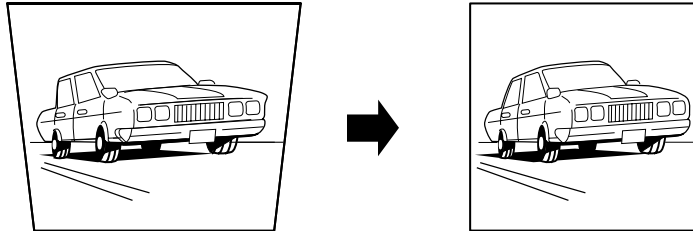

**Press KEYSTONE.**

The keystone distortion on the picture projected is automatically corrected and the fine adjustment screen of the keystone distortion correction appears.

You may perform the fine adjustment by pressing ◀/▶ buttons.

- ◀ (-): To reduce the lower width.
- ▶ (+): To reduce the upper width.

After a few seconds, the fine adjustment screen disappears.

To correct further, make the “Keystone” adjustment on the menu. **38**

# Cutting off the picture and sound temporarily

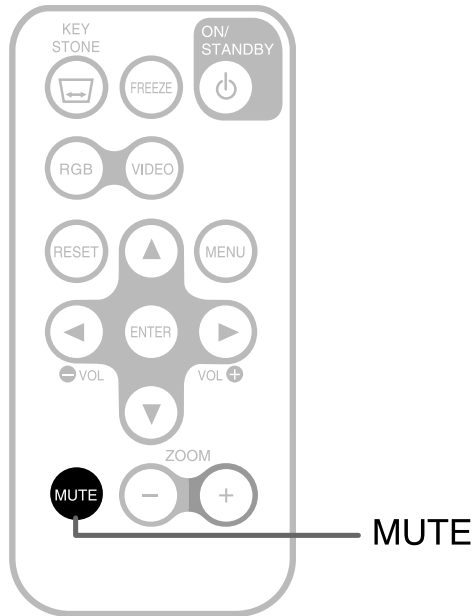

## Press MUTE.

The sound and picture are cut off temporarily.

“” appears.

To restore, press MUTE again.

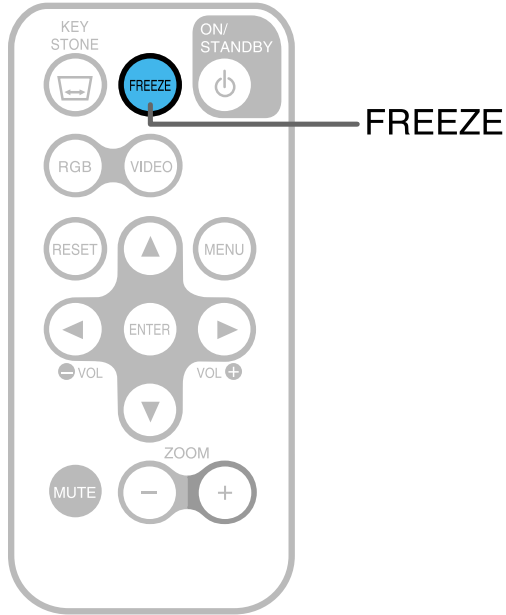

## Press FREEZE.

The picture freezes.

“⊘” mark appears on the screen.

To release the picture, press FREEZE again.

### Note

If you perform other operation while freezing the picture, the picture freezing operation is released.



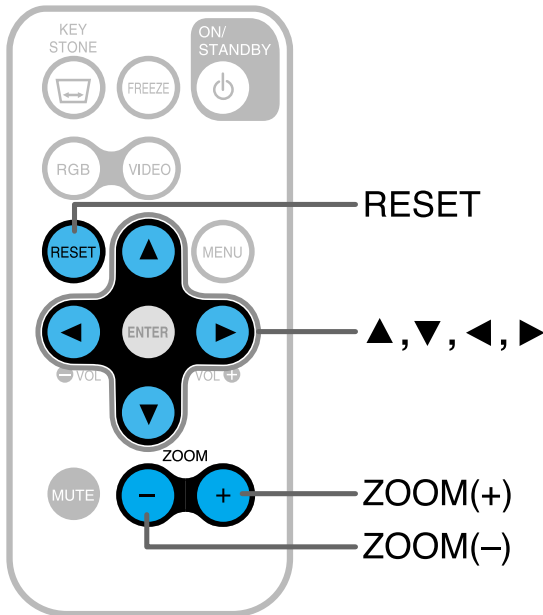

You can enlarge the picture size projected.

**Press ZOOM (+).**  
Each time the ZOOM (+) button is pressed, the enlargement ratio increases.

To decrease the enlargement ratio, press the ZOOM (-) button.

Pressing ▲ / ▼ / ◀ / ▶ buttons shifts the picture part enlarged.

Press the RESET button to cancel the zoom operation.

The diagram shows a ZOOM (+) button with a plus sign highlighted in blue, a ZOOM (-) button with a minus sign highlighted in blue, a set of four directional arrow buttons (up, down, left, right) each highlighted in blue, and a RESET button highlighted in blue.

## Notes

- Picture enlargement display will return to the normal size after the power turns off and on again.
- Some signals cannot be applicable for the enlargement operation.
- The picture may not be projected properly while shifting the picture.
- Since the electrical digital zoom system is employed, the picture quality may be degraded in accordance with the enlargement ratio.
- If you perform other operation, the zoom operation is cancelled.

- Most of adjustments and settings are made on the menu screen.
- Press MENU button, to display the menu screen.
- Quick menu and full menu are provided in the menu screen.

## Quick menu

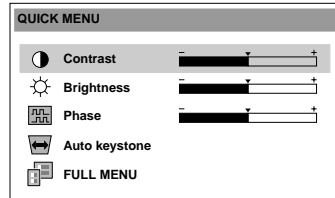

You can set the Basic setting used frequently. [34](#)

Contrast	To adjust the contrast.
Brightness	To adjust the brightness.
Phase	To adjust the flickering of the screen.
Auto keystone	To correct the keystone distortion of the picture projected automatically.
FULL MENU	To change to the full menu screen.

## Notes

- Select the “QUICK MENU” of the “Display setting” menu to change the display from full menu screen to quick menu screen.
- Pressing the MENU button again after exiting from the menu screen will display the screen displayed at last or the screen prior to that. The quick menu is displayed when the power turns on for the first time.
- Operation guide (indicated by the illustration of unit buttons) appears on the lowest portion of the menu screen, follow it when operating.

## Full menu

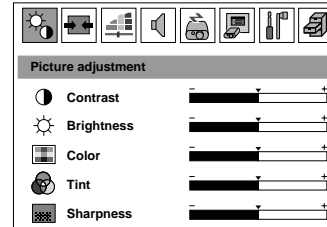

You can set all kinds of setting.

Picture adjustment <a href="#">36</a>	Contrast, Brightness, Color, Tint, Sharpness
Image adjustment <a href="#">38</a>	Keystone, Phase, Horizontal position, Vertical position, Clock
Level adjustment <a href="#">40</a>	Red level, Green level, Blue level
Audio adjustment <a href="#">42</a>	Volume, Channel select (Left+Right, Left, Right), Output select (Always, Video only, RGB only)
Signal setting <a href="#">44</a>	Picture mode (Bright, True color), Video mode (Auto, NTSC, NTSC4.43, PAL, PAL-N, SECAM, PAL60, PAL-M), No signal background (TOSHIBA logo, Blue background), No signal power off (OFF, 5 minutes)
Display setting <a href="#">47</a>	Quick menu, Menu position (Upper left, Upper right, Lower right, Lower left), Menu background color (Clear, Blue), On screen display (On, Off)
Default setting <a href="#">49</a>	Language (English, French, German, Italian, Spanish, Portuguese, Japanese, Simplified Chinese, Traditional Chinese, Korean), Projection mode (Standard, Rear, Ceiling, Rear ceiling), Start up display (On, Off), Power on (Manual, Auto)
Data setting <a href="#">52</a>	Status display, Factory reset mode, Keystone reset

# Quick menu setting

You can set the basic setting used frequently.

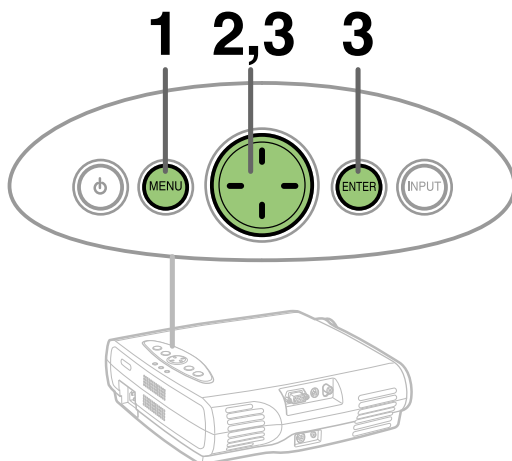
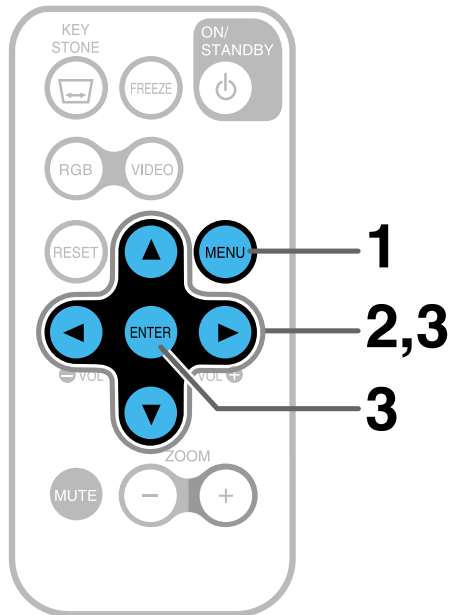

## Preparation

1 Project a picture on the screen as explained in the step "Projection on the screen". 25

1



### Press MENU.

The quick menu screen appears.

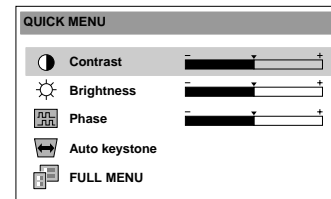

2

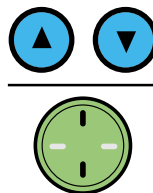

Select the setting item (Contrast, Brightness, Phase, Auto keystone, FULL MENU) by pressing ▲ / ▼.

3

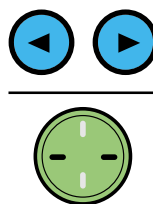

(When selecting "Contrast", "Brightness" or "Phase" in step 2.)

### Adjust the item by pressing ◀ / ▶.

-: ◀    +: ▶

	(-)	(+)
Contrast:	Lower	Higher
Brightness:	Darker	Brighter
Phase:	Adjust when a flicker occurs	



(When selecting "Auto keystone" in step 2.)

### Press ENTER.



The keystone distortion on the picture projected is automatically corrected and the fine adjustment screen of the keystone distortion correction appears.

Continued

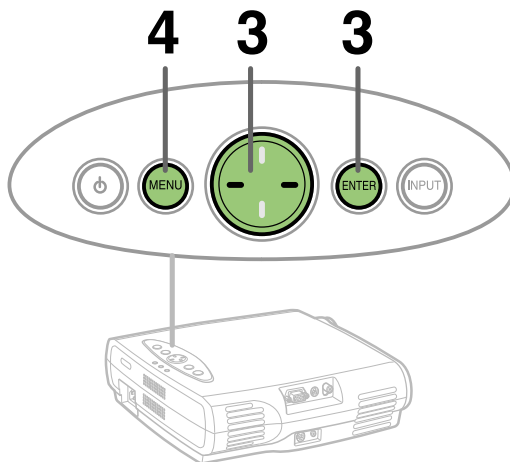
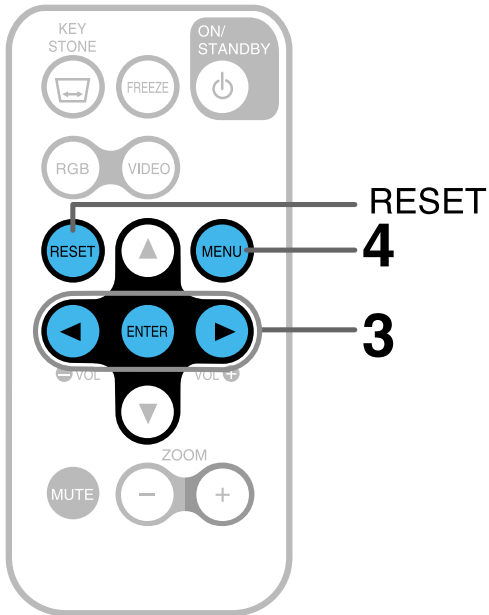

You may perform the fine adjustment by pressing ◀/▶ buttons.

- ◀ (-): To reduce the lower width.
- ▶ (+): To reduce the upper width.

After a few seconds, the fine adjustment screen disappears.



(When selecting "FULL MENU" in step 2.)

**Press ENTER.**

The screen changes to the full menu screen. **33**



**4**



**Press MENU several times until the quick menu screen disappears.**



## Notes

- Pressing the MENU button will return to the previous setting screen.
- You can adjust the "Contrast" and "Brightness" for every input sources (RGB, Video).
- You can not adjust the "Phase" at Video input.
- The value(s) adjusted for keystone distortion correction, contrast, brightness and/or phase is memorized.
- Press the RESET button, the menu screen disappears.



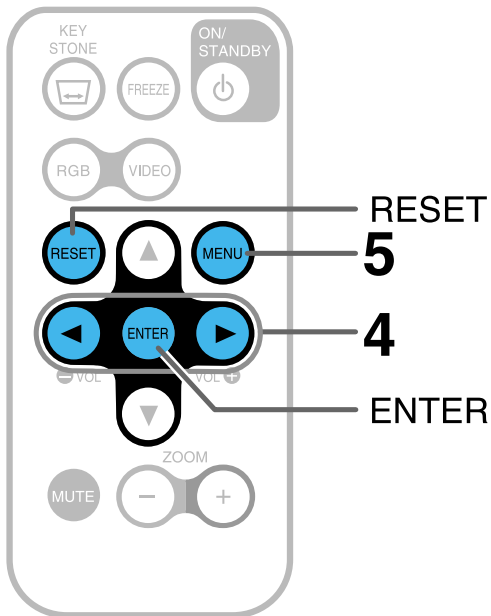

RESET

5

4

ENTER

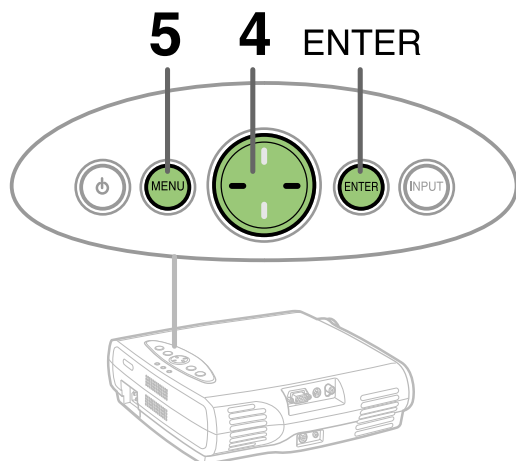

4



**Adjust the item by pressing ◀/▶.**

If you adjust other setting item, return to step 3.

-: ◀ +: ▶



	(-)	(+)
Contrast:	Lower	Higher
Brightness:	Darker	Brighter
Color:	Thinner	Deeper
Tint:	Redder	Greener
Sharpness:	Softer	Sharper



At this time, if you press the ENTER button, the screen changes to display the item selected only. Pressing the MENU button will return to the previous setting screen.



5



**Press MENU several times until the full menu screen disappears.**



### Notes

- Pressing the MENU button will return to the previous setting screen.
- You can adjust the “Contrast” and “Brightness” for every input sources (RGB, Video).
- You can not adjust “Color”, “Tint” and “Sharpness” at RGB input.
- The value(s) adjusted and/or setting(s) is memorized.
- Press the RESET button, the menu screen disappears.

# Adjusting Image (Image adjustment)

You can adjust the keystone and/or screen. Adjust when the distortion, flickering, blurring, deviation of the display position occur on the screen.

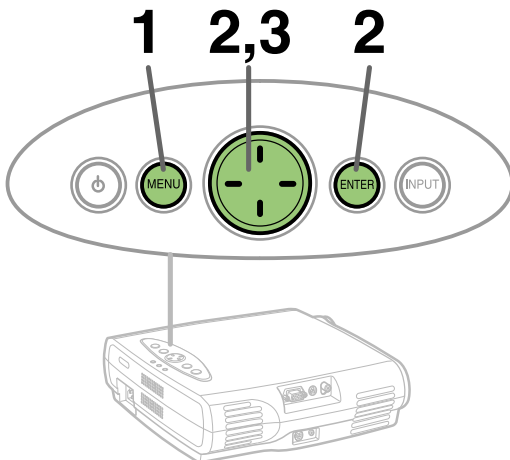
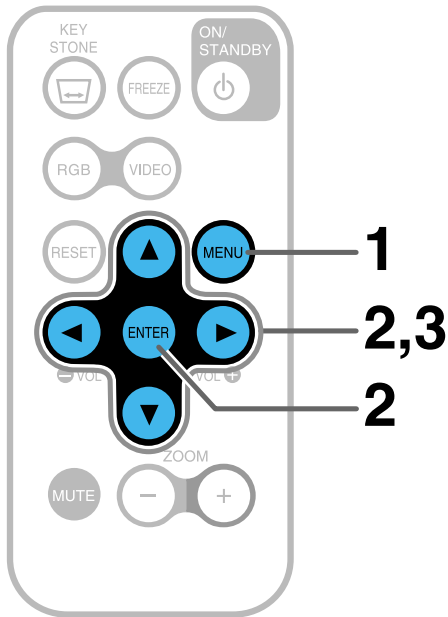

## Preparation

1 Project a picture on the screen as explained in the step "Projection on the screen". 25

1



### Display the full menu screen.

Press MENU.

When the quick menu is displayed, select "FULL MENU" by pressing ▲ / ▼ and then press ENTER.



2



### Select " " by pressing ◀ / ▶ and then press ENTER.

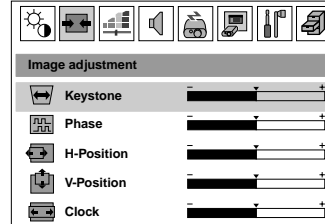

3



### Select the setting item (Keystone, Phase, H-position, V-position or Clock) by pressing ▲ / ▼.



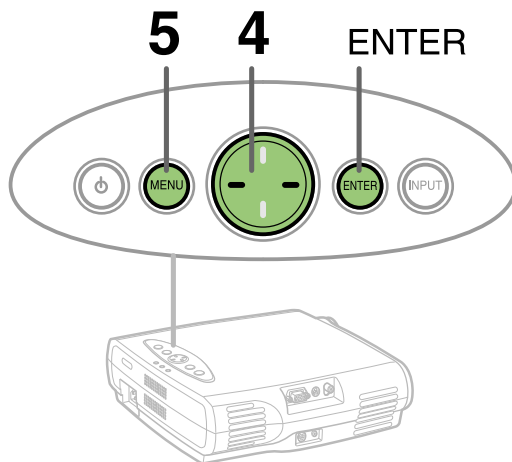
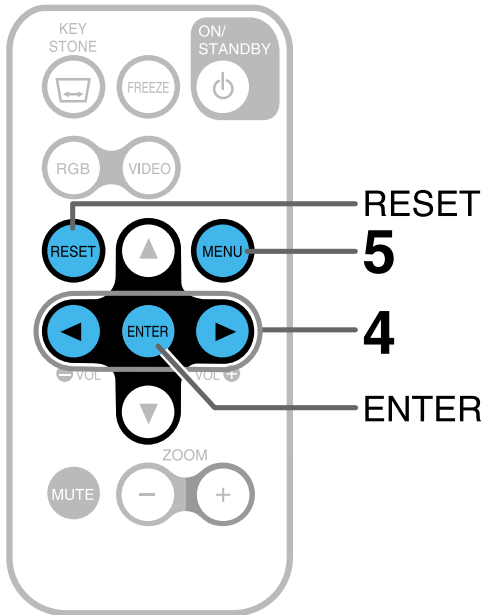

## 4



### Adjust the item by pressing ◀/▶.

If you adjust other setting item, return to step 3.

-: ◀ +: ▶



Keystone: (-) To reduce the lower width.  
(+) To reduce the upper width.

Phase: To reduce flickers.

H-position: To shift the image to the left (-), to the right (+).

V-position: To shift the image down (-), to up (+).

Clock: To remove vertical stripes.



At this time, if you press the ENTER button, the screen changes to display the item selected only. Pressing the MENU button will return to the previous setting screen.



## 5



### Press MENU several times until the full menu screen disappears.



#### Notes

- During adjustments of “H-position” or “V-position”, the image may not be projected properly.
- While using, an aberration of the phase may occur. In that case, adjust “Phase” again.
- Depending on the input signal, the adjustment bar when adjusting the clock may not move in full scale.
- Pressing the MENU button will return to the previous setting screen.
- You can adjust the “H-position” and “V-position” for every input sources (RGB, Video).
- You can not adjust “Phase” and “Clock” at Video input.
- The value(s) adjusted and/or setting(s) is memorized.
- Press the RESET button, the menu screen disappears.



# Adjusting RGB-level (Level adjustment)

You can adjust each ratio of red, green and blue.

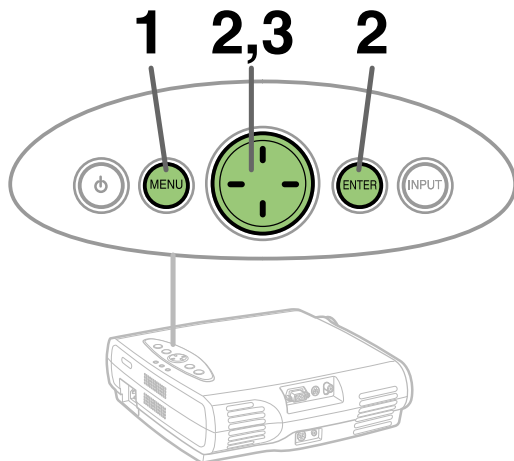
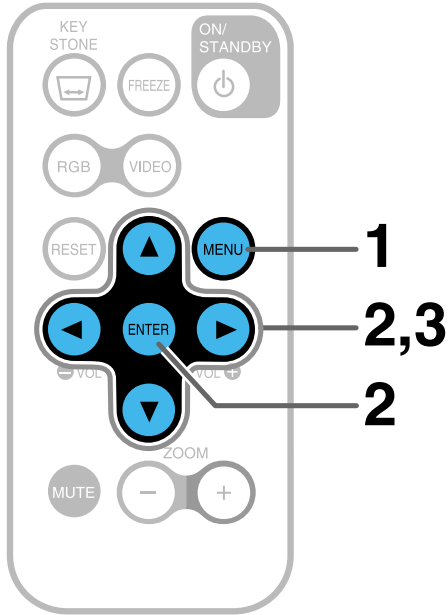



## Preparation



1 Project a picture on the screen as explained in the step "Projection on the screen". 25

**1**  **Display the full menu screen.**  
Press MENU.  
When the quick menu is displayed, select "FULL MENU" by pressing ▲ / ▼ and then press ENTER.

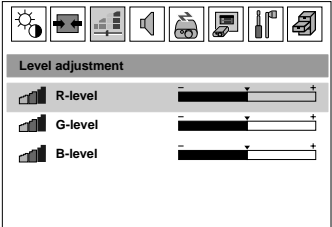
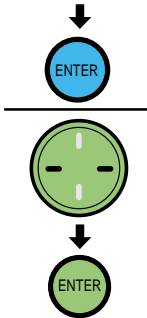

**2**   **Select "  " by pressing ◀ / ▶ and then press ENTER.**



**3**   **Select the setting item (R-level, G-level or B-level) by pressing ▲ / ▼.**



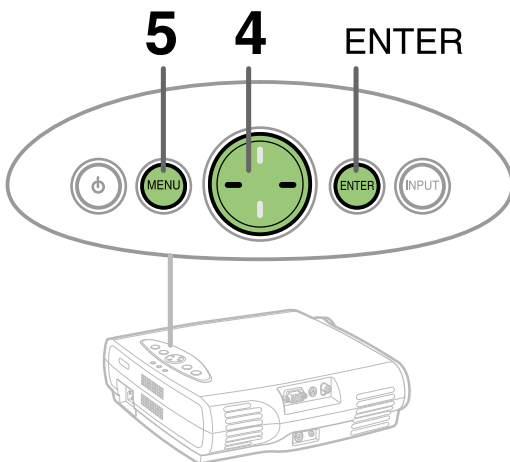
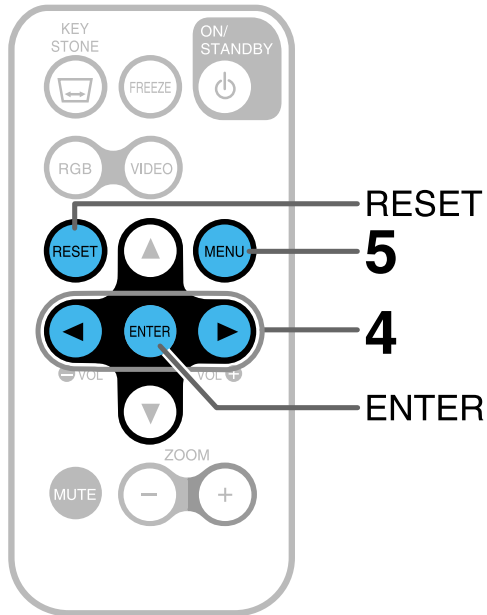

## 4 Adjust the item by pressing ◀/▶.

If you adjust other setting item, return to step 3.

–: ◀ +: ▶

R-level: (–) To reduce red

(+) To increase red

G-level: (–) To reduce green

(+) To increase green

B-level: (–) To reduce blue

(+) To increase blue



At this time, if you press the ENTER button, the screen changes to display the item selected only. Pressing the MENU button will return to the previous setting screen.



## 5 Press MENU several times until the full menu screen disappears.



### Notes

- Pressing the MENU button will return to the previous setting screen.
- You can adjust the setting item(s) for every input sources (RGB, Video).
- The value(s) adjusted and/or setting(s) is memorized.
- Press the RESET button, the menu screen disappears.

# Adjusting audio output (Audio adjustment)

You can adjust the sound volume, switch the audio channel and audio output.

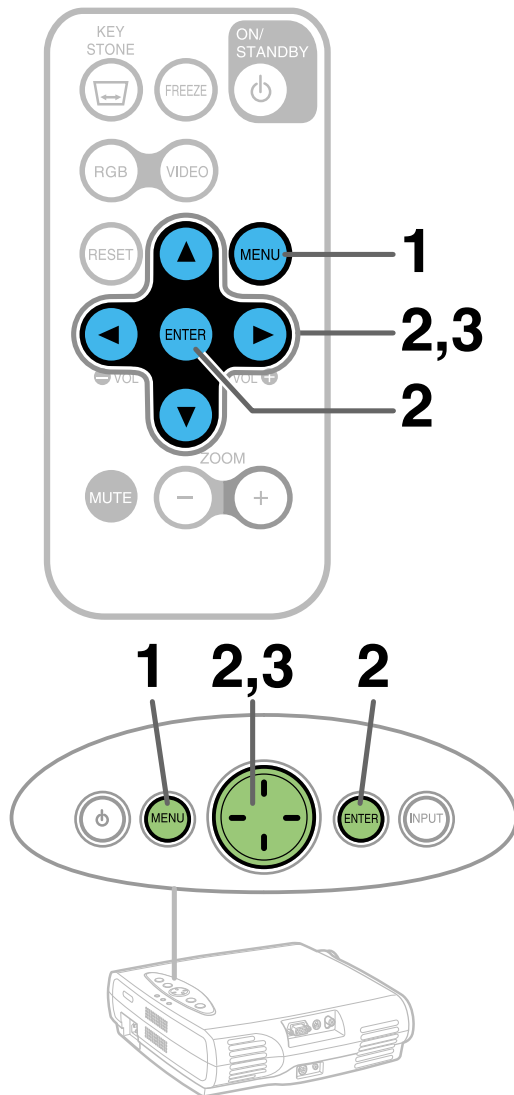

## Preparation

1 Project a picture on the screen as explained in the step “Projection on the screen”. 25

- 1 Display the full menu screen.**  
Press MENU.  
When the quick menu is displayed, select “FULL MENU” by pressing ▲ / ▼ and then press ENTER.  

The screenshot shows a quick menu with icons for Picture, Audio, Input, and other settings. The 'Picture adjustment' section is visible, showing a 'Contrast' slider.
- 2 Select “” by pressing ◀ / ▶ and then press ENTER.**  

The screenshot shows the 'Audio adjustment' menu with options for Volume, Channel select, and Output select. A speaker icon is highlighted.
- 3 Select the setting item (Volume, Channel select, Output select) by pressing ▲ / ▼.**  

The screenshot shows the 'Audio adjustment' menu with 'Volume' selected.

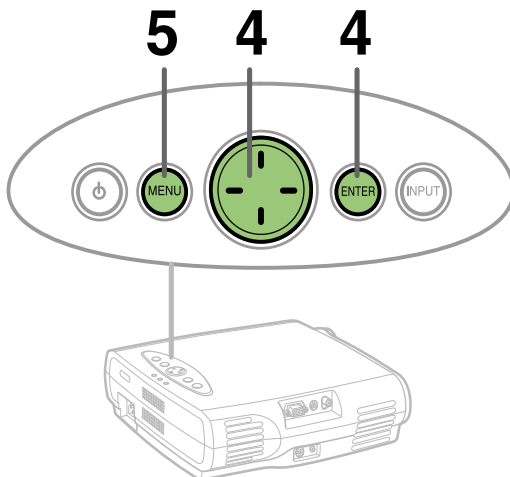
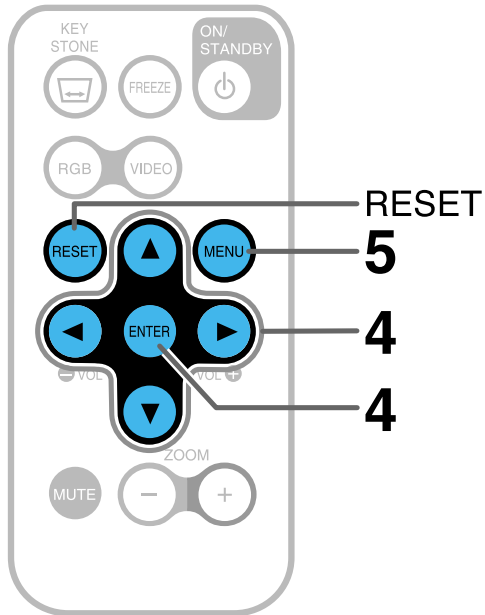

## 4



(When selecting "Volume" in step 3.)

**Adjust the Volume by pressing ◀ / ▶.**

- ◀ (-): To turn down.
- ▶ (+): To turn up.



(When selecting "Channel select" or "Output select" in step 3.)

1 Press ENTER.

The setting screen selected appears.

2 Change the selection by pressing ▲ / ▼.

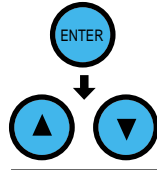

**Channel select:**

You can switch the channel of the sound developed from the speaker(s).

- Left + Right: To develop both left and right input audio signals.
- Left: To develop only left input audio signal.
- Right: To develop only right input audio signal.



**Output select:**

You can select the sound developed from the speaker(s) regarding of the input switching.

- Always: To develop sound regardless of input sources types.
- Video only: To develop sound at VIDEO input.
- RGB only: To develop sound at RGB input.



## 5



**Press MENU several times until the full menu screen disappears.**



### Notes

- Pressing the MENU button will return to the previous setting screen.
- You can adjust the "Volume" for every input source (RGB, Video).
- The value(s) adjusted and/or setting(s) is memorized.
- Press the RESET button, the menu screen disappears.

# Setting the input signal (Signal setting)

You can set the picture mode, kind of input video signal and no signal status.

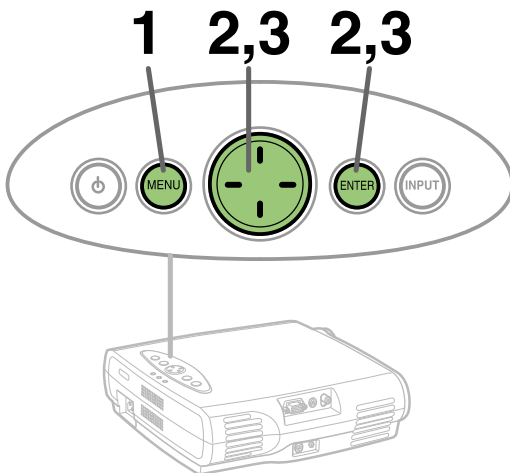
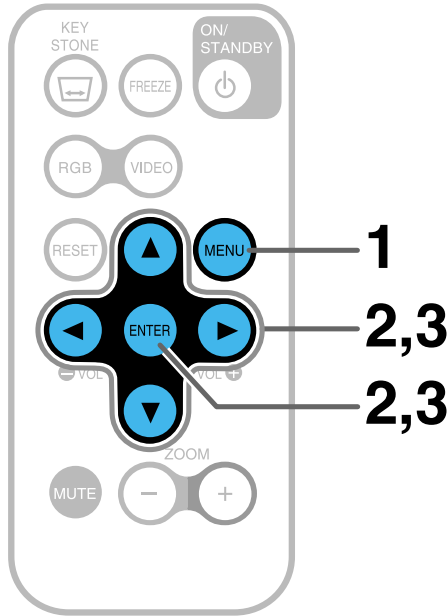

## Preparation

1 Project a picture on the screen as explained in the step "Projection on the screen". 25

1



### Display the full menu screen.

Press MENU.

When the quick menu is displayed, select "FULL MENU" by pressing ▲ / ▼ and then press ENTER.



2

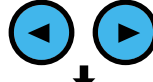

### Select " [Camera icon] " by pressing ◀ / ▶ and then press ENTER.

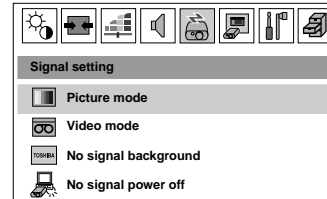

3

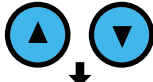

### Select the setting item (Picture mode, Video mode, No signal background, No signal power off) by pressing ▲ / ▼ and then press ENTER.



The setting screen for the item selected appears.



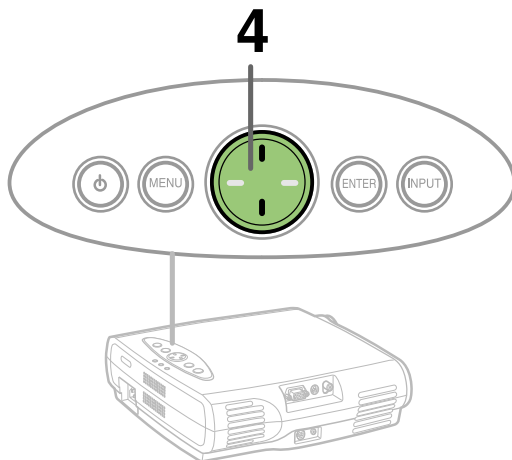
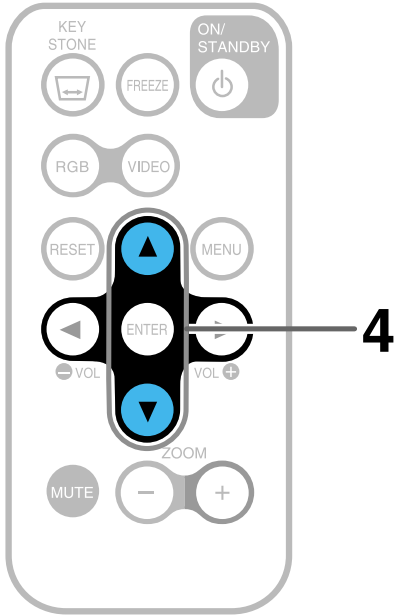

## 4



Change the selection by pressing ▲ / ▼.



### Picture mode:

- Bright: To set the picture with its brightness priority.
- True color: To set the picture with its picture quality (color) priority.

### Video mode:

- Auto: To determine the kinds of video signal entered automatically. If not determined properly, select the kind of signal among the signals shown below.

NTSC, NTSC4.43, PAL, PAL-N, SECAM, PAL60, PAL-M

### No signal background:

- TOSHIBA logo: To set TOSHIBA logo on the background at no signal status.
- Blue background: To set blue screen on the background at no-signal status.

### No signal power off:

- OFF: The power does not turn off automatically even if the no signal status continues.
- 5 minutes : The power turns off automatically if the no signal status continues for approx. 5 min.

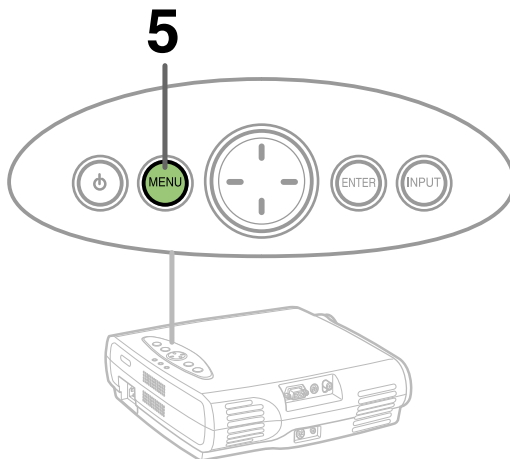
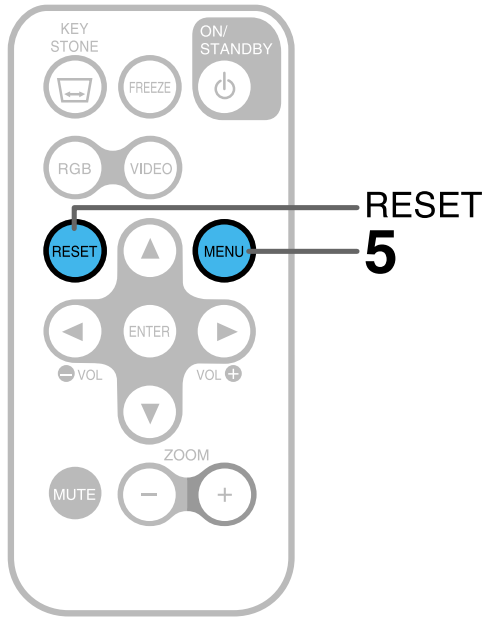

## 5



Press MENU several times until the full menu screen disappears.



### Notes

- Pressing the MENU button will return to the previous setting screen.
- You can not set "Picture mode" at Video input.
- You can not set "Video mode" at RGB input.
- The value(s) adjusted and/or setting(s) is memorized.
- Press the RESET button, the menu screen disappears.

# Setting the display method (Display setting)

You can switch to the quick menu screen. Then you can set the menu screen position, menu screen background color and on screen display.

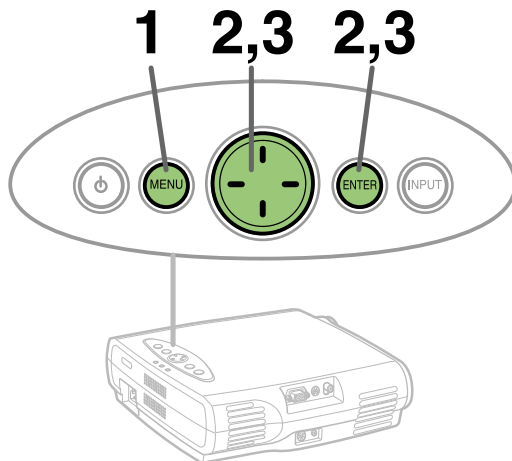
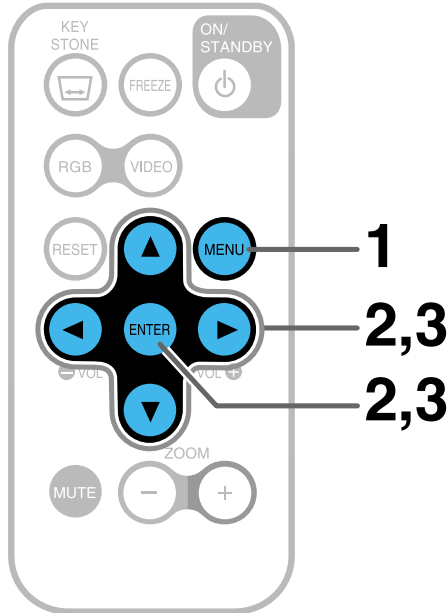

## Preparation

1 Project a picture on the screen as explained in the step "Projection on the screen". 25

1



### Display the full menu screen.

Press MENU.

When the quick menu is displayed, select "FULL MENU" by pressing ▲/▼ and then press ENTER.



2



### Select " " by pressing ◀/▶ and then press ENTER.

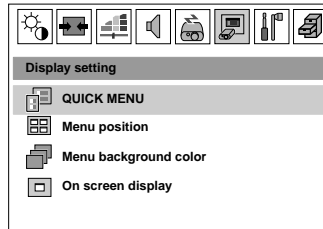

3



### Select the setting item (QUICK MENU, Menu position, Menu background color, On screen display) by pressing ▲/▼ and then press ENTER.



The setting screen for the item selected appears.

When you select "QUICK MENU", the display changes to the quick menu screen.





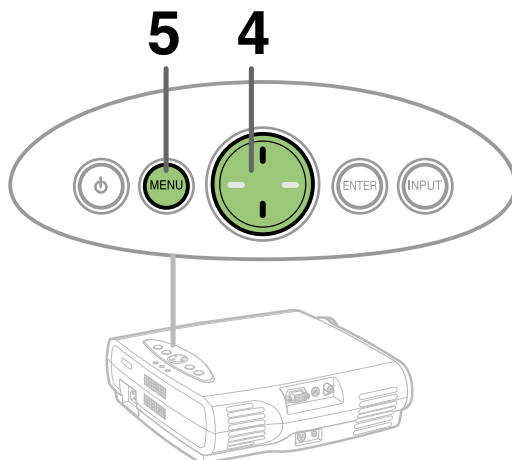
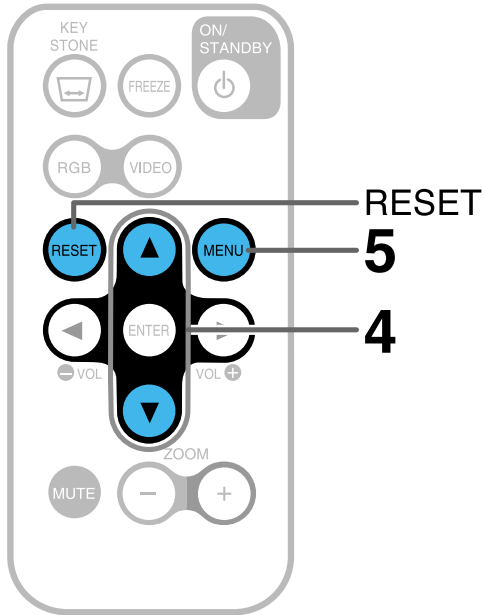

## 4 Change the selection by pressing ▲ / ▼.



### Menu position:

- Upper left: To display the menu on the upper left position.
- Upper right: To display the menu on the upper right position.
- Lower left: To display the menu on the lower left position.
- Lower right: To display the menu on the lower right position.

### Menu background color:

- Clear: To set the menu background color to translucent color.
- Blue: To set the menu background color to blue.

### On screen display:

- On: To display the On-screen display at input selection, signal absence display, etc.
- Off: Not to set On-screen display. When using the projector for presentation, etc., setting the on-screen display to off will be convenient.

## 5 Press MENU several times until the full menu screen disappears.



### Notes

- Pressing the MENU button will return to the previous setting screen.
- The value(s) adjusted and/or setting(s) is memorized.
- Press the RESET button, the menu screen disappears.

# Default setting

You can set the language, projection mode, start up display and automatic power on.

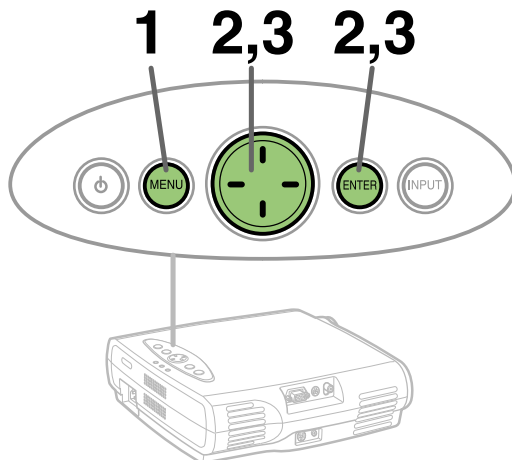
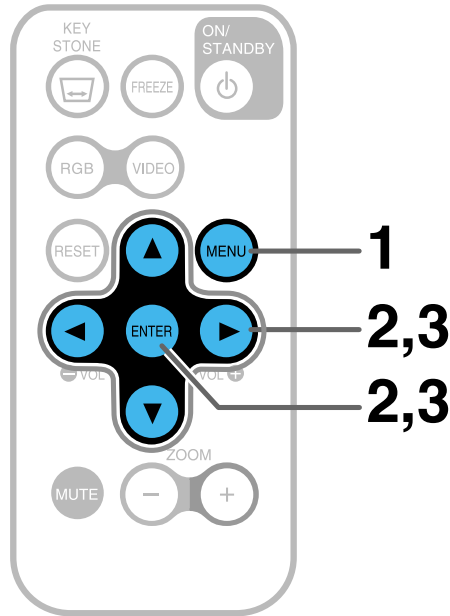

## Preparation

1 Project a picture on the screen as explained in the step “Projection on the screen”. 25

1



### Display the full menu screen.

Press MENU.

When the quick menu is displayed, select “FULL MENU” by pressing ▲ / ▼ and then press ENTER.



2



Select “” by pressing ◀ / ▶ and then press ENTER.

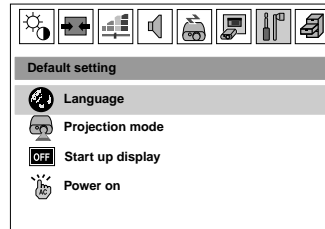

3

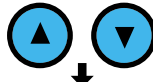

Select the setting item (Language, Projection mode, Start up display, Power on) by pressing ▲ / ▼ and then press ENTER.



The setting screen for the item selected appears.



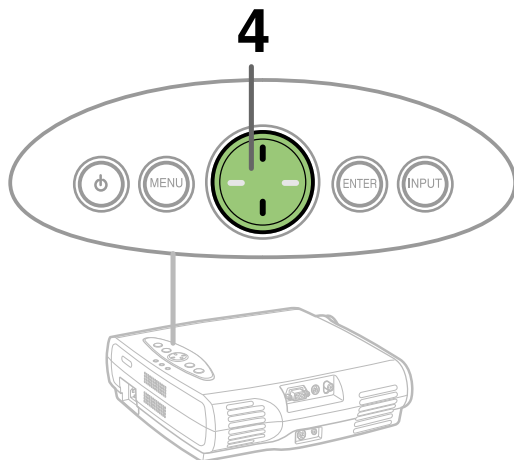
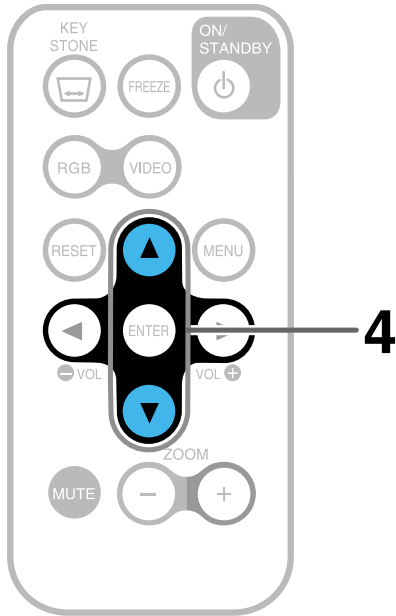

## 4

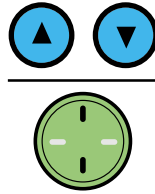

### Change the selection by pressing ▲ / ▼.

#### Language:

Select the language used for the menu screen.

- English: English
- Français: French
- Deutsch: German
- Italiano: Italian
- Español: Spanish
- Português: Portuguese
- 日本語: Japanese
- 简体字: Simplified Chinese
- 繁體字: Traditional Chinese
- 한국어: Korean

#### Projection mode:

Select the installation position of the projector. Confirm by referring to the chart on page 16 > 20 >.

- Standard: Floor-mounted front projection
- Rear: Floor-mounted rear projection
- Ceiling: Ceiling-mounted front projection
- Rear ceiling: Ceiling-mounted rear projection

#### Start up display:

- On: To display the start up display which appears when the power turns on.
- Off: Not to display the start up display.

#### Power on:

- Manual: The power turns on by pressing ON/STANDBY with the power cord plugged.
- Auto: When the power cord is plugged, the power turns on and the lamp lights.

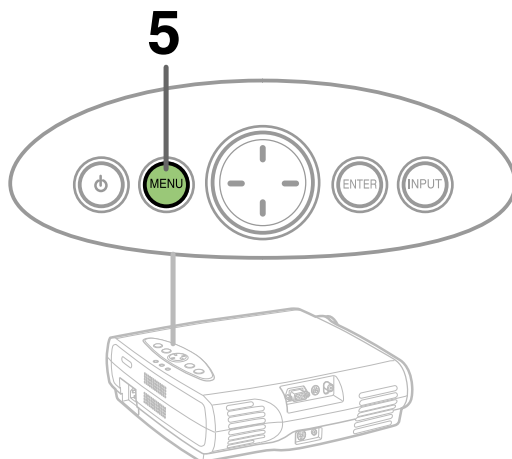
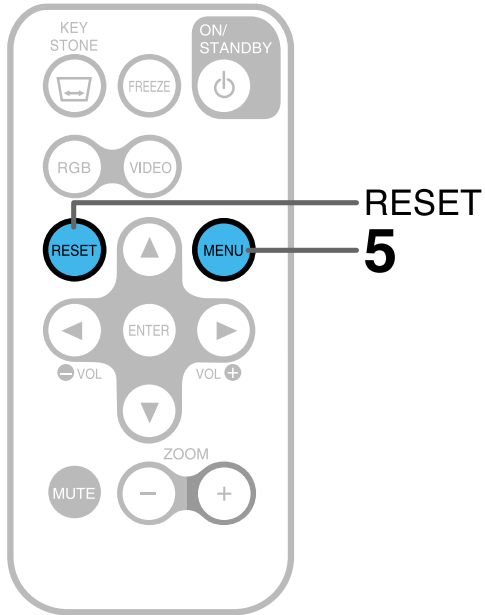

## 5



Press MENU several times until the full menu screen disappears.



### Notes

- Pressing the MENU button will return to the previous setting screen.
- The value(s) adjusted and/or setting(s) is memorized.
- Press the RESET button, the menu screen disappears.

# Reset, Status display (Data setting)

You can display the status, return to the factory reset mode and reset to the standard setting for keystone distortion correction.

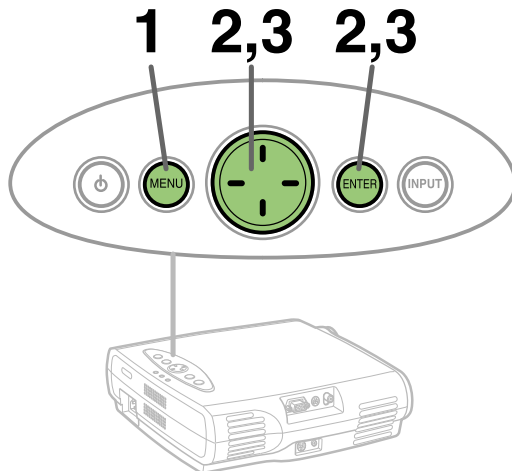
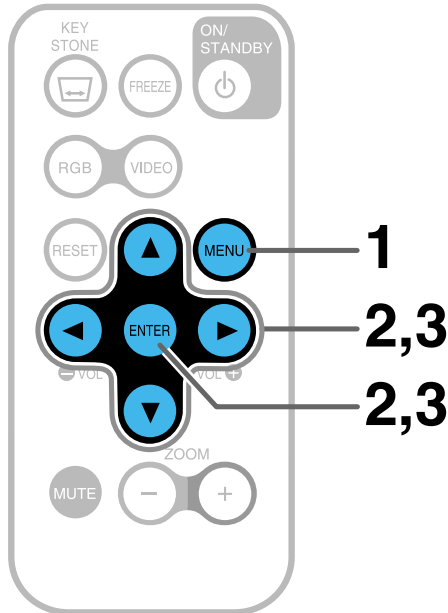

## Preparation

1 Project a picture on the screen as explained in the step "Projection on the screen". 25

1



### Display the full menu screen.

Press MENU.

When the quick menu is displayed, select "FULL MENU" by pressing ▲/▼ and then press ENTER.



2



### Select " " by pressing ◀/▶ and then press ENTER.

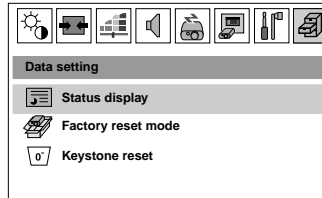

3

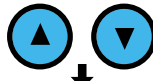

### Select the setting item (Status display, Factory reset mode, Keystone reset) by pressing ▲/▼ and then press ENTER.



#### Status display:

Display the current operation status.

<ul style="list-style-type: none"> <li>▢ Status display</li> <li>Input</li> <li>Horizontal resolution</li> <li>Vertical resolution</li> <li>Horizontal frequency</li> <li>Vertical frequency</li> </ul>	<ul style="list-style-type: none"> <li>RGB</li> <li>—</li> <li>—</li> <li>—</li> <li>—</li> <li>—</li> </ul>	<ul style="list-style-type: none"> <li>Current input source</li> <li>Signal horizontal resolution</li> <li>Signal vertical resolution</li> <li>Signal horizontal frequency</li> <li>Signal vertical frequency</li> </ul>
---	--	--

Continued

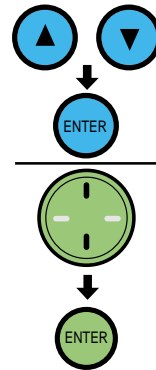
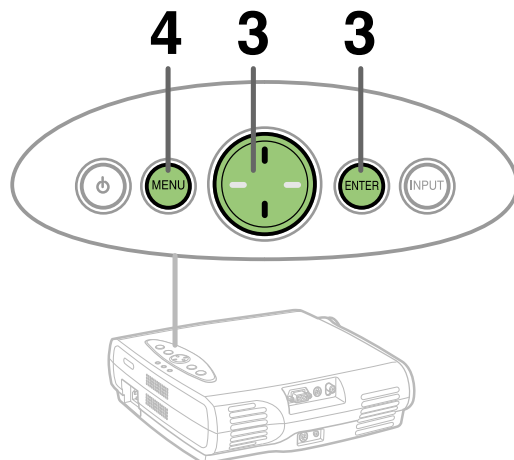
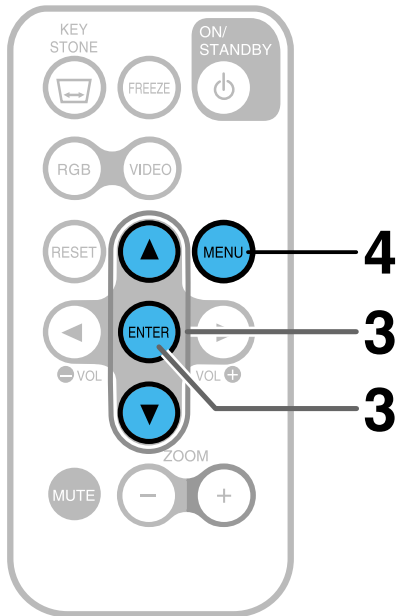

Status display  
Input  
Video mode  
Vertical frequency

Video  
— Current input source  
— Video signal system  
— Signal vertical frequency

### Factory reset mode:

Return the adjusting or setting contents on the menu screen to the factory setting status.

### Keystone reset:

The operating environment with vibration and/or shocks, etc. may prevent from performing the keystone distortion correction normally. This may occur due to the change of setting in the horizontal status. In this case, perform the "Keystone reset".

Perform the setting with the projector installed on the horizontal plane.

## 4



**Press MENU several times until the full menu screen disappears.**

When performing "Factory reset mode" or "Keystone reset", the menu screen disappears.

### Note

Pressing the MENU button will return to the previous setting screen.

# Trouble indications

If there is some problem inside the projector, the indicators light up or flash.

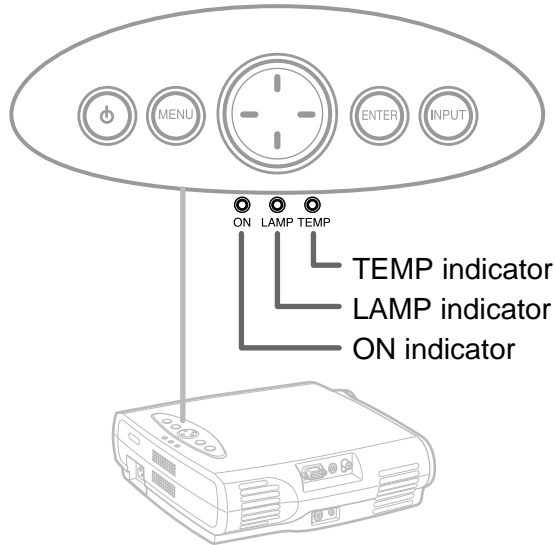

<p> <input type="radio"/> ON (OFF)    <input type="radio"/> LAMP    <input type="radio"/> TEMP            or  <input checked="" type="radio"/> ON Lit (red)    <input type="radio"/> LAMP    <input type="radio"/> TEMP         </p>	<p>The power does not come on.            → Malfunction of the unit.</p> <ul style="list-style-type: none"> <li>• Unplug the power cord and call the dealer.</li> </ul>
<p> <input checked="" type="radio"/> ON Lit (red)    <input checked="" type="radio"/> LAMP Lit (red)    <input type="radio"/> TEMP         </p>	<p>The lamp turns off or does not light up.            → The lamp's end, or malfunction of the unit.</p> <ul style="list-style-type: none"> <li>• Lamp's life length is over, replace the lamp with new one.</li> <li>• Unplug the power cord and call the dealer.</li> </ul>
<p> <input checked="" type="radio"/> ON Lit (red)    <input type="radio"/> LAMP    <input checked="" type="radio"/> TEMP Lit (red)         </p>	<p>The power turns off or does not come on.            → The inside is too hot, or the projector has been working in an area of high temperature.</p> <ul style="list-style-type: none"> <li>• Place the projector correctly so the intake and exhaust fans' holes are not covered.</li> <li>• Turn the projector off, and leave it for a while, and turn it on again.</li> <li>• Clean the air filter.</li> </ul>
<p> <input checked="" type="radio"/> ON Lit (red)    <input type="radio"/> LAMP    <input checked="" type="radio"/> TEMP Flashing (red)         </p>	<p>The power turns off or does not come on.            → Trouble with the intake fan.</p> <ul style="list-style-type: none"> <li>• Unplug the power cord and call the dealer.</li> </ul>
<p> <input checked="" type="radio"/> ON Lit (red)    <input type="radio"/> LAMP    <input checked="" type="radio"/> TEMP Flashing (orange)         </p>	<p>The power turns off or does not come on.            → Trouble with the exhaust fan.</p> <ul style="list-style-type: none"> <li>• Unplug the power cord and call the dealer.</li> </ul>

**Note**

Before attempting any maintenance, unplug the power cord.

## CAUTION

If you use the projector mounted on the ceiling, ask the dealer to carry out the maintenance such as cleaning.

The filter under the air filter cover is the device to shut out dusts or dregs. Do not use the projector with the filter taken off. Give a frequent clean especially to the air filter. (The cleaning period is once per about 50 hours).

## Notes

- When the air filter is dusty, the ventilation is impaired. This causes the temperature inside the projector to rise, and may damage the unit.
- Attach the air filter cover firmly after the cleaning. If it is not set correctly, the dusts will enter and they will be projected and overlapped on the picture.

**1** Unplug the power cord.

**2**

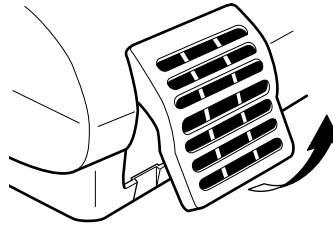

**Take off the air filter cover.**

The filter is on the right side of the projector. Pull the bottom side of the cover upward to remove the filter cover.

**3**

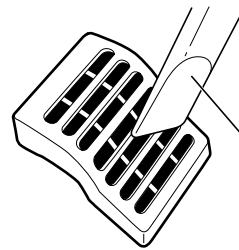

**Clean the air filter cover.**

Remove dust and stains with a vacuum cleaner.

**4**

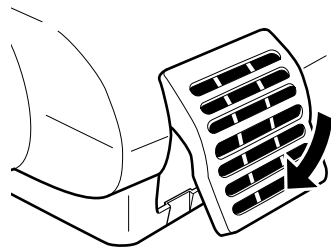

**Attach the air filter cover.**



## CAUTION

If you use the projector mounted on the ceiling, ask the dealer to carry out the maintenance such as cleaning.

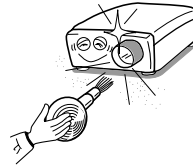

## Cleaning the lens

Use a blower or a lens cleaner to clean the lens.

Never rub or tap the lens with a hard object as the lens surface is fragile.

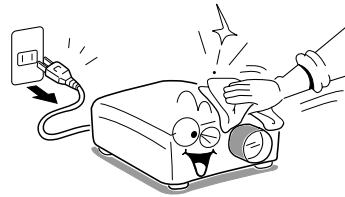

## Cleaning the main unit

- Pull out the power cord before cleaning.
- Use a soft cloth to wipe off stains from the surface.
- To remove difficult stains, use a soft cloth slightly moistened with a weak solution of synthetic detergent and water, and finish with a soft, dry cloth.

## Replacing the intake, exhaust fans and air filter

To maintain the efficiency of the projector, replace the intake and exhaust fans about every two to three years.

Ask the dealer for the replacement.

The lamp will eventually begin to project dark or dull pictures and finally will not light up. (Lamp's life length depends on the use condition.) In such a case, replace the lamp with new one.

### CAUTION

- If you use the projector mounted on the ceiling, ask the dealer to carry out the maintenance such as cleaning or replacement of the lamp.
- When replacing, always use lamp "TLPLB2P" (sold separately). For detail, refer to the lamp instruction.
- If you have been using the projector, the lamp will be very hot, and may cause burn injuries. Wait for the lamp to cool (for longer than 1 hour) before replacing it.
- If the lamp should break, please handle with care to avoid injury due to broken pieces and contact your dealer for repair service.

**1** Unplug the power cord.

**2** Wait until the lamp gets cold enough.

**3** Take off the lamp cover on the bottom panel.

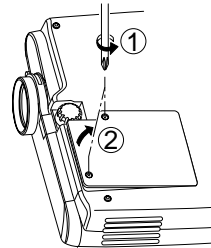

Loosen two screws, and pull off the lamp cover.

**4** Pull out the lamp.

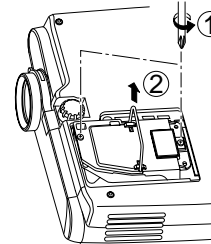

Loosen the two fixing screws, and lift up the handle to pull out the lamp.

## Notes

- The projector displays the total working time at every 1,000 hours (only when plugged in and turned on).
- The lamp should be replaced if the total working time exceeds about 2,000 hours.
- Attach the lamp cover firmly after replacing the lamp. If it is not set correctly, the power will not turn on.
- Use a new lamp when replacing it.
- The lamp is made of glass and is very fragile. Do not touch the lamp with your bare hands and do not jolt or damage it. Do not use an exhausted lamp.

5

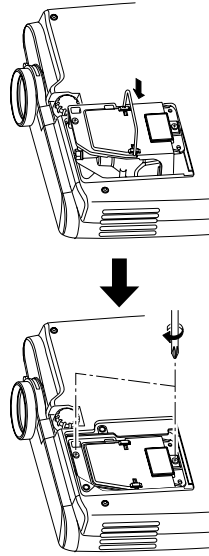

### Load a new lamp.

Slide until it hits the bottom and tighten the two fixed screws.

6

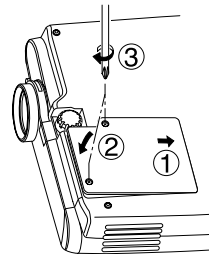

### Attach the lamp cover.

Slide the cover in place and tighten two screws.

7

### Reset the lamp timer.

Refer to the lamp instructions for resetting.

# Before calling service personal

Check the following points before asking for support service. Refer also to “Trouble indications”. [54](#)

Symptom	Cause	Correction	Page
The power does not come on.	• The power cord is disconnected.	Firmly plug in the power cord.	<a href="#">18</a>
	• The lamp cover is not attached correctly.	Attach the cover correctly.	<a href="#">57</a>
The power turns off while using the projector.	• The ambient temperature of the projection room is too high.	Lower the ambient temperature of the projection room, and turn the power on.	–
No image appears.	• The lens cover is on.	Take off the lens cover.	<a href="#">18</a>
	• The wrong input is selected.	Select the input source correctly.	<a href="#">26</a>
	• The muting mode is on.	Press MUTE to restore the picture.	<a href="#">30</a>
	• The “Brightness” adjustment is at its darkest.	Make the “Brightness” adjustment.	<a href="#">34</a>
	• The source is not correctly connected to the projector.	Connect the source correctly to the projector.	<a href="#">21</a>
No sounds are heard.	• The wrong input is selected.	Select the input source correctly.	<a href="#">26</a>
	• The muting mode is on.	Press MUTE to restore the sound.	<a href="#">30</a>
	• The sound volume is at the minimum.	Adjust the sound volume.	<a href="#">42</a>
	• The source is not correctly connected to the projector.	Connect the source correctly to the projector.	<a href="#">21</a>
The images are blurred. Focusing is uneven.	• The lens is dirty.	Clean the lens. Use a lens cleaner to clean the lens.	<a href="#">56</a>
	• The picture is out of focus.	Focus the picture.	<a href="#">27</a>
	• The projection distance is not appropriate.	Adjust the distance properly.	<a href="#">17</a>
	• The projecting light is not hitting the screen squarely.	Adjust the projecting direction so that the light hits the screen squarely.	<a href="#">17</a>
	• The “Brightness”, “Contrast”, “Sharpness” or “Phase” adjustments are not correct.	Make the “Picture” or “Image” adjustments.	<a href="#">36</a> <a href="#">38</a>
The pictures are dim.	• The “Brightness” or “Contrast” adjustments are not correct.	Make the “Picture” adjustments.	<a href="#">34</a>
	• The lamp life is ending.	Replace the lamp.	<a href="#">57</a>
The colors are faint. The colors are strange.	• The “Color”, “Tint”, “R-Level”, “G-Level” or “B-Level” adjustments are not correct.	Make the “Picture” or “Level” adjustments.	<a href="#">36</a> <a href="#">40</a>
	• The lamp life is ending.	Replace the lamp.	<a href="#">57</a>
The remote control does not work.	• The remote control is not facing the remote sensor.	Face the remote control transmitter toward the remote sensor on the projector.	<a href="#">15</a>
	• The remote control is too far.	Operate within about 5 meters.	<a href="#">15</a>
	• There is an obstruction between the remote control and the remote sensor.	Remove the obstacle.	–
	• The batteries are exhausted.	Replace the batteries.	<a href="#">14</a>

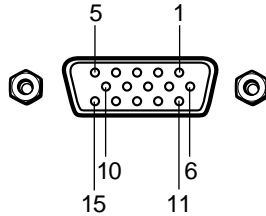

D-SUB 15 pin shrinking terminal

## Pin arrangements

Pin No.	
1	Video input (Red)
2	Video input (Green)
3	Video input (Blue)
4	GND
5	GND
6	GND (Red)
7	GND (Green)
8	GND (Blue)
9	N.C
10	GND
11	GND
12	SDA (DDC2B)
13	Horizontal synchronizing/ composite synchronizing signal
14	Vertical synchronizing signal
15	SCL (DDC2B)

Input Signal

Video signal

Analog 0.7V(p-p) 75Ω

Horizontal synchronizing signal

TTL level (positive/negative polarity)

Vertical synchronizing signal

TTL level (positive/negative polarity)

Composite synchronizing signal

TTL level

# Applicable RGB signal

The unit is applicable to the following signals. However, some computers may have different timings than those in the chart. Make the necessary adjustments if the picture has flickers or is blurred.

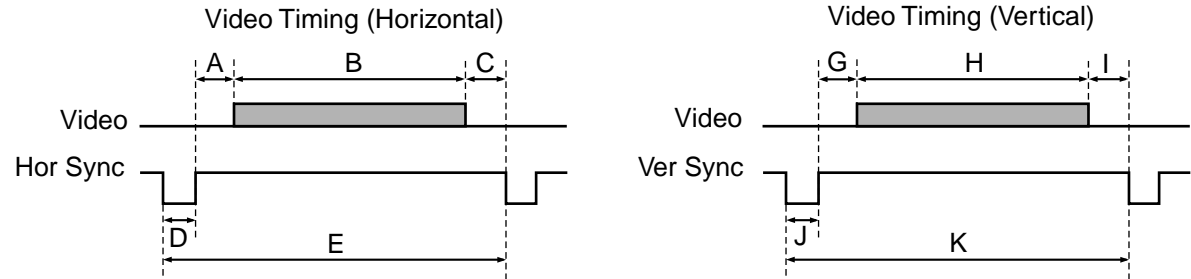

Timing chart

Mode	Resolution	A (Pixels)	B (Pixels)	C (Pixels)	D (Pixels)	E (Pixels)	fh (kHz)	fv (Hz)	Clock (MHz)	G (Lines)	H (Lines)	I (Lines)	J (Lines)	K (Lines)
TEXT70	640 x 350	50	640	14	96	800	31.47	70.09	25.175	59	350	38	2	449
TEXT70	640 x 400	50	640	14	96	800	31.47	70.09	25.175	34	400	13	2	449
TEXT85	640 x 350	96	640	32	64	832	37.86	85.08	31.500	60	350	32	3	445
TEXT85	640 x 400	96	640	32	64	832	37.86	85.08	31.500	41	400	1	3	445
VGA60	640 x 480	48	640	16	96	800	31.47	59.94	25.175	33	480	10	2	525
VGA72	640 x 480	128	640	24	40	832	37.86	72.81	31.500	28	480	9	3	520
VGA75	640 x 480	120	640	16	64	840	37.50	75.00	31.500	16	480	1	3	500
VGA85	640 x 480	80	640	56	56	832	43.27	85.01	36.000	25	480	1	3	509
MAC13	640 x 480	96	640	64	64	864	35.00	66.67	30.240	39	480	3	3	525
SVGA56	800 x 600	128	800	24	72	1024	35.16	56.25	36.000	22	600	1	2	625
SVGA60	800 x 600	88	800	40	128	1056	37.88	60.32	40.000	23	600	1	4	628
SVGA72	800 x 600	64	800	56	120	1040	48.08	72.19	50.000	23	600	37	6	666
SVGA75	800 x 600	160	800	16	80	1056	46.88	75.00	49.500	21	600	1	3	625
SVGA85	800 x 600	152	800	32	64	1048	53.67	85.06	56.250	27	600	1	3	631
MAC16	823 x 624	216	832	40	64	1152	49.72	74.55	57.283	39	632	1	3	667
XGA60	1024 x 768	160	1024	24	136	1344	48.363	60.004	65.000	29	768	3	6	806
XGA70	1024 x 768	144	1024	24	136	1328	56.476	70.069	75.000	29	768	3	6	806
XGA75	1024 x 768	176	1024	16	96	1312	60.023	75.029	78.750	28	768	1	3	800
XGA85	1024 x 768	208	1024	48	96	1376	68.677	84.997	94.500	36	768	1	3	808
MAC19	1024 x 768	180	1024	20	96	1320	60.197	74.872	73.200	30	768	3	3	804

# Controlling the projector by using RS-232C

Conditioning of the Projection Unit can also be done by a computer via the RS-232C, as well as by the remote control.

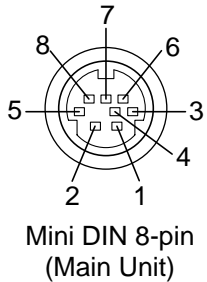

Pin No.	Signal	Meaning
1	RXD	Receiving data
2	CTS	Consent to send
3	DSR	Data set ready
4	GND	Signal ground
5	RTS	Request to send
6	N.C	No connection
7	TXD	Sending data
8	N.C	No connection

## Interface format

- Communication method** RS-232C  
9600 bps, No parity, Data length: 8 bit, Stop bit: 1 bit
- Communication format** STX (02h) Command (3Byte) ETX (03h)  
One command only can be used in one communication.
- Data format** Command shall be composed of alphanumeric characters of ASCII description. Use only capital letters.
- Return value** Acknowledge ACK (06h)  
Not Acknowledge NAK (15h)

### Note

When commands are transmitted serially, keep more than 100 ms intervals between the commands. However, leave a sufficient time interval for processing which requires time, such as input switching.

## Command list

Classification	Command	Meaning
Remote control/Key	POF	Power (Off)
Remote control/Key	PON	Power (On)
Special	PSD	Power shut down
Key	IN0	Input (Toggle)
Remote control/Key	IN1	Input (RGB)
Remote control/Key	IN2	Input (Reset)
Remote control	RS0	Zoom (Reset)
Remote control	RDP	Zoom (Enlarge)
Remote control	RDW	Zoom (Reduce)
Remote control	PO1	Zoom position (Upward)
Remote control	PO2	Zoom position (Downward)
Remote control	PO3	Zoom position (Leftward)
Remote control	PO4	Zoom position (Rightward)
Remote control	FOF	Freeze (Off)
Remote control	FON	Freeze (On)
Remote control	MOF	Mute (Off)
Remote control	MON	Mute (On)
Remote control	PKA	Auto keystone
Adjustment	ARG	Adjustment value (Increase)
Adjustment	ALF	Adjustment value (Decrease)
Picture adjustment	VCN	Contrast adjustment
Picture adjustment	VBR	Brightness adjustment
Picture adjustment	VCL	Color adjustment
Picture adjustment	VTN	Tint adjustment
Picture adjustment	VSH	Sharpness adjustment

Classification	Command	Meaning
Image adjustment	PKS	Keystone adjustment
Image adjustment	PPH	Phase adjustment
Image adjustment	PHP	Horizontal position adjustment
Image adjustment	PVP	Vertical position adjustment
Image adjustment	PCK	Clock adjustment
Level adjustment	VLR	Red level adjustment
Level adjustment	VLG	Green level adjustment
Level adjustment	VLB	Blue level adjustment
Audio adjustment	VOL	Volume adjustment
Audio adjustment	ACA	Channel select (L+R)
Audio adjustment	ACL	Channel select (L only)
Audio adjustment	ACR	Channel select (R only)
Audio adjustment	AOA	Output select (Always)
Audio adjustment	AOV	Output select (Video only)
Audio adjustment	AOR	Output select (RGB only)
Signal setting	MVB	Picture mode (Brightness priority)
Signal setting	MVP	Picture mode (True color)
Signal setting	KV0	Video mode (Auto)
Signal setting	KV1	Video mode (NTSC) (NTSC/60/3.58)
Signal setting	KV2	Video mode (PAL) (PAL/50/4.43)
Signal setting	KV3	Video mode (SECAM) (PAL/50/SECAM)
Signal setting	KV4	Video mode (PAL-N) (PAL/50/3.58)
Signal setting	KV5	Video mode (PAL-M) (PAL/60/3.58)
Signal setting	KV6	Video mode (PAL60) (PAL/60/4.43)
Signal setting	KV7	Video mode (NTSC4.43) (NTSC/60/4.43)
Signal setting	BG0	No signal background (TOSHIBA logo)
Signal setting	BG1	No signal background (Blue background)
Signal setting	PN0	No signal power off (OFF)
Signal setting	PN1	No signal power off (5 minutes)
Signal setting	MI0	Auto input switching (On)
Signal setting	MI1	Auto input switching (Off)

Classification	Command	Meaning
Display setting	MP1	Menu position (Upper left)
Display setting	MP2	Menu position (Lower left)
Display setting	MP3	Menu position (Upper right)
Display setting	MP4	Menu position (Lower right)
Display setting	MB0	Menu background color (Blue)
Display setting	MB1	Menu background color (Clear)
Display setting	MO0	On screen display (On)
Display setting	MO1	On screen display (Off)
Default setting	LEN	Language (English)
Default setting	LFR	Language (French)
Default setting	LGR	Language (German)
Default setting	LIT	Language (Italian)
Default setting	LSP	Language (Spanish)
Default setting	LPO	Language (Portuguese)
Default setting	LPK	Language (Simplified Chinese)
Default setting	LKT	Language (Traditional Chinese)
Default setting	LKK	Language (Korean)
Default setting	LJP	Language (Japanese)
Default setting	PJ0	Projection mode (Standard)
Default setting	PJ1	Projection mode (Rear)
Default setting	PJ2	Projection mode (Ceiling)
Default setting	PJ3	Projection mode (Rear ceiling)
Default setting	MS0	Start up display (On)
Default setting	MS1	Start up display (Off)
Default setting	AP0	Power on (Manual)
Default setting	AP1	Power on (Auto)
Data setting	DON	Status display (Display)
Data setting	DOF	Status display (Not display)
Data setting	DRS	Factory reset mode
Data setting	PKR	Keystone reset



## Main unit

Power requirements	AC 100 – 240V 50/60Hz
Power consumption	185W
Mass	2.6Kg
Dimensions	232 x 71 x 276 (mm) (W/H/D) (Except the protrusion parts)
Ambient environment	Temperature : 0°C to 35°C Humidity : 30% to 70% RH
Lamp	125W
Speaker	1W (monaural)
RGB inputs	Mini D-sub 15-pin
S-VIDEO inputs	Mini DIN 4-pin
VIDEO inputs	1V(p-p), 75Ω, pin jack
AUDIO inputs	1V(p-p), more than 22kΩ, ø3.5mm stereo mini jack
CONTROL connector	Mini DIN 8-pin (RS-232C)
Cabinet Material	Polycarbonate & ABS resin

## Liquid crystal display

Projection system	3-panels transmission
Panel size	0.9 inches
Driving system	TFT active matrix
Picture elements	786,432 pixels (1024 x 768 dots) x 3

## Projection lens

Lens	Zooming lens F = 2.3 – 2.6 f = 36 – 43.2mm
Focusing	Manual operation
Zooming	Manual operation

## Accessories

Wireless remote control .....	1
Coin shaped battery (CR2025) (Contained in the remote control).....	1
Power cord .....	1
RGB cable .....	1 (3m)
Adapter for Macintosh computers .....	1
Video cable .....	1 (3m)
Audio cable (Computer) .....	1 (3m)
Audio cable (VCR, DVD) .....	1 (3m)
Control cable .....	1
Soft case .....	1

The design and specifications are subject to change without notice.

### Trademarks

NEC, PC-98 series are trademarks of NEC Corporation.

IBM, DOS/V, VGA, SVGA, XGA, SXGA, UXGA are trademarks or registered trademarks of International Business Machines Corporation.

Macintosh is a registered trademark of Apple Computer, Inc.

Windows is a registered trademark of Microsoft Corporations in the U.S. and other countries.

Display Data Channel is a trade mark of Video Electronics Standard Association.

## TOSHIBA TLP-B2 Series 3LCD Data Projector

Toshiba America Consumer Products, Inc. (TACP) makes the following limited warranties.

These limited warranties extend to the original end-user purchaser.

### **Limited two (2) Years Warranty of Parts and Labor**

TACP warrants this product and its parts against defects in materials or workmanship for a period of two years after the date of original retail purchase.

For a period of two years after the date of original retail purchase, TACP will repair a defective product or a part, without charge to you.

This warranty also covers accessories of 3LCD Data Projector.

This warranty period of the lamp is ninety (90) days.

### **Your Responsibility**

The above warranties are subject to the following conditions.

1. You must retain your bill of sale or provide other proof of purchase.
2. You must make a written notification within thirty (30) days after your discovery of a defective product or part.
3. All warranty servicing of this product or parts must be made by TACP or a service facility authorized by TACP.
4. These warranties are effective only if the product is purchased and operated in the USA.
5. Labor service charges for installation and adjustment of customer controls are not covered by this warranty.

6. Warranties extend only to defects in materials or workmanship as limited above and do not extend to any product or parts which have been lost or discarded by you or to damage to products or parts caused by misuse, accident, improper installation, improper maintenance or use in violation of instructions furnished by us; or to units which have been altered or modified without authorized of TACP or to damage to product or parts thereof which have had the serial number removed, altered, defaced or rendered illegible.
7. If it is determined after investigation that the claimed problem was not covered with this warranty, you shall pay the cost of investigation at prevailing rate.

### **Step-by-step procedure how to obtain warranty service**

To obtain warranty servicing, you should:

1. Read the owners manual thoroughly before operating.
2. Please contact your dealer for an immediate service and an advice.
3. If your dealer is not able to assist you, please contact TACP Service Center listed below or a servicing facilities authorized by TACP for a warranty service within thirty (30) days after you find a defective product or part.
4. Arrange for a delivery of the product to TACP Service Center or a servicing facilities authorized by TACP.
5. The shipment of the product must be insured, safely and securely packed, preferably in the original carton or a carton with an equivalent protection. A letter explaining the defect and also a copy of the bill of sale or other proof of purchase must be enclosed. All transportation and insurance charges must be prepaid by you.

# LIMITED WARRANTY (Continued)

6. The repaired product is returned freight prepaid to the purchaser after warranty servicing.
7. If you have any questions about service, please contact the following TACP Service Center.

TACP is not obligated to provide purchasers with a substitute unit during the warranty period.

82 Totowa Rd., Wayne,

NJ 07470, U.S.A.

Phone: (973) 628-8000

Fax: (973) 628-1875

Toll Free for Service Call: 1-800-631-3811

**TOSHIBA AMERICA CONSUMER PRODUCTS, INC.**