

myprojectorlamps.com

**The most trusted, dependable name
in projector lamp sales.**



<http://www.myprojectorlamps.com>



<http://www.myprojectorlamps.ca>



<http://www.myprojectorlamps.eu>

The following projector manual has not been modified or altered in any way.

TOSHIBA

OWNER'S MANUAL (Getting Started)

DATA PROJECTOR

TDP-T9

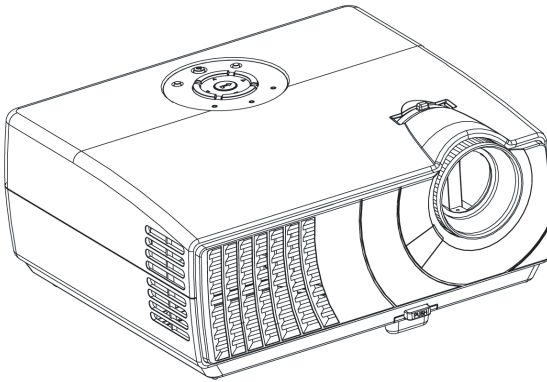

Before Using

Preparations

Operations

Maintenance

Others

For more details , please refer to the owner's manual of the CD-ROM version

SAFETY PRECAUTIONS



The lightning flash with arrowhead symbol, within an equilateral triangle, is intended to alert the user to the presence of uninsulated “dangerous voltage” within the product’s enclosure that may be of sufficient magnitude to constitute a risk of electric shock to persons.



The exclamation point within an equilateral triangle is intended to alert the user to the presence of important operating and maintenance (servicing) instructions in the literature accompanying the appliance.

WARNING: TO REDUCE THE RISK OF FIRE OR ELECTRIC SHOCK, DO NOT EXPOSE THIS APPLIANCE TO RAIN OR MOISTURE. DANGEROUS HIGH VOLTAGES ARE PRESENT INSIDE THE ENCLOSURE. DO NOT OPEN THE CABINET. REFER SERVICING TO QUALIFIED PERSONNEL ONLY.

WARNING: Handling the cord on this product or cords associated with accessories sold with this product, will expose you to lead, a chemical known to the State of California to cause birth defects or other reproductive harm. ***Wash hands after handling.***

WARNING: This [product] contains mercury. Disposal of mercury may be regulated due to environmental considerations. For disposal or recycling information, please contact your local authorities or the Electronic Industries Alliance: www.eiae.org.

MODEL NAME: TDP-T9 **USA only**

TRADE NAME: DATA PROJECTOR

MODEL NAME: TDP-T9



Tested To Comply
With FCC Standards

FOR HOME OR OFFICE USE

FCC NOTICE: This device complies with part 15 of the FCC Rules. Operation is subject to the following two conditions:

(1) This device may not cause harmful interference, and (2) this device must accept any interference received, including interference that may cause undesired operation. This equipment has been tested and found to comply with the limits for a Class B digital device, pursuant to part 15 of the FCC Rules. These limits are designed to provide reasonable protection against harmful interference in a residential installation. This equipment generates, uses and can radiate radio frequency energy and, if not installed and used in accordance with the instructions, may cause harmful interference to radio communications. However, there is no guarantee that interference will not occur in a particular installation. If this equipment does cause harmful interference to radio or television reception, which can be determined by turning the equipment off and on, the user is encouraged to try to correct the interference by one or more of the following measures:

-
- Reorient or relocate the receiving antenna.
 - Increase the separation between the equipment and receiver.
 - Connect the equipment into an outlet on a circuit different from that to which the receiver is connected.
 - Consult the dealer or an experienced radio/TV technician for help.

RESPONSIBLE PARTY: TOSHIBA AMERICA INFORMATION SYSTEMS, INC.
9740 Irvine Blvd., Irvine, CA 92618-1697 U.S.A
Phone: (949) 583-3000

WARNING: Changes or modifications made to this equipment, not expressly approved by **USA only** Toshiba, or parties authorized by Toshiba, could void the user's authority to operate the equipment.

WARNING: This Class B digital apparatus complies with Canadian ICES-003. Cet appareil numérique de la classe B est conforme à la norme NMB-003 du Canada. **CANADA only**

IMPORTANT SAFETY INSTRUCTIONS

CAUTION: PLEASE READ AND OBSERVE ALL WARNINGS AND INSTRUCTIONS GIVEN IN THIS OWNER'S MANUAL AND THOSE MARKED ON THE UNIT. RETAIN THIS BOOKLET FOR FUTURE REFERENCE.

This set has been designed and manufactured to assure personal safety. Improper use can result in electric shock or fire hazard. The safeguards incorporated in this unit will protect you if you observe the following procedures for installation, use and servicing. This unit is fully transistorized and does not contain any parts that can be repaired by the user.

DO NOT REMOVE THE CABINET COVER, OR YOU MAY BE EXPOSED TO DANGEROUS VOLTAGE. REFER SERVICING TO QUALIFIED SERVICE PERSONNEL ONLY.

1. Read Owner's Manual

After unpacking this product, read the owner's manual carefully, and follow all the operating and other instructions.



2. Power Sources

This product should be operated only from the type of power source indicated on the marking label. If you are not sure of the type of power supply to your home, consult your product dealer or local power company. For products intended to operate from battery power, or other sources, refer to the operating instructions.



3. Source of Light

Do not look into the lens while the lamp is on. The strong light from the lamp may cause damage to your eyes or sight.

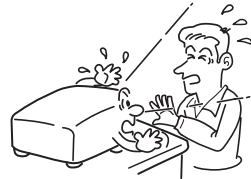

4. Ventilation

Openings in the cabinet are provided for ventilation and to ensure reliable operation of the product and to protect it from overheating, and these openings must not be blocked or covered. The openings should never be blocked by placing the product on a bed, sofa, rug or other similar surface. This product should not be placed in a built-in installation such as a bookcase or rack unless proper ventilation is provided or the manufacturer's instructions have been adhered to.



5. Heat

The product should be situated away from heat sources such as radiators, heat registers, stoves, or other products (including amplifiers) that produce heat.

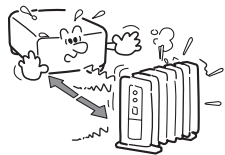

6. Water and Moisture

Do not use this product near water. - for example, near a bath tub, wash bowl, kitchen sink, or laundry tub; in a wet basement; or near a swimming pool and the like.

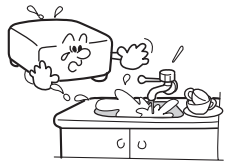

7. Cleaning

Unplug this product from the wall outlet before cleaning. Do not use liquid cleaners or aerosol cleaners. Use a soft cloth for cleaning.



8. Power-Cord Protection

Power-supply cords should be routed so that they are not likely to be walked on or pinched by items placed upon or against them, paying particular attention to cords at plugs, convenience receptacles, and the point where they exit from the product.



9. Overloading

Do not overload wall outlets; extension cords, or integral convenience receptacles as this can result in a risk of fire or electric shock.



IMPORTANT SAFETY INSTRUCTIONS (Continued)

10. Lightning storms

For added protection for this product during storm, or when it is left unattended and unused for long periods of time, unplug it from the wall outlet. This will prevent damage to the product due to lightning and power-line surges. However, while it is thundering or lightning, do not touch the apparatus and any connected cable and/or equipment. This will prevent you from receiving the electric shock by an electric surge.

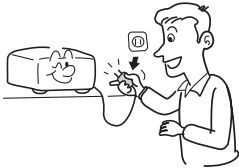

11. Object and Liquid Entry

Never push objects of any kind into this product through openings as they may touch dangerous voltage points or short-out parts that could result in a fire or electric shock. Never spill liquid of any kind on the product.



12. Do not place the product vertically

Do not use the product in the upright position to project the pictures at the ceiling, or any other vertical positions. It may fall down and dangerous.

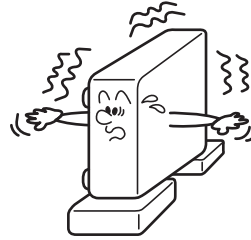

13. Stack Inhibited

Do not stack other equipment on this product or do not place this product on the other equipment. Top and bottom plates of this product develops heat and may give some undesirable damage to other unit.

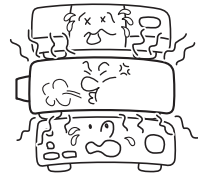

14. Attachments

Do not use attachments not recommended by the product manufacturer as they may cause hazards.

15. Accessories

Do not place this product on an unstable cart, stand, tripod, bracket, or table. The product may fall, causing serious injury to a child or adult, and serious damage to the product. A product and cart combination should be moved with care. Quick stops, excessive force, and uneven surfaces may cause the product and cart combination to overturn.



16. Damage Requiring Service

Unplug this product from the wall outlet and refer servicing to qualified service personnel under the following conditions:

- a) When the power-supply cord or plug is damaged.
- b) If liquid has been spilled, or objects have fallen into the product.
- c) If the product has been exposed to rain or water.
- d) If the product does not operate normally by following the operating instructions. Adjust only those controls that are covered by the operating instructions as an improper adjustment of other controls may result in damage and will often require extensive work by a qualified technician to restore the product to its normal operation.

- e) If the product has been dropped or damaged in any way.
- f) When the product exhibits a distinct change in performance - this indicates a need for service.

17. If glass components, including lens and lamp, should break, contact your dealer for repair service.

This product incorporates glass components, including a lens and a lamp. If such parts should break, please handle with care to avoid injury and contact your dealer for repair service. The broken pieces of glass may cause injury. In the unlikely event of the lamp rupturing, thoroughly clean the area around the projector and discard any edible items placed in that area.

18. Servicing

Do not attempt to service this product yourself as opening or removing covers may expose you to dangerous voltage or other hazards. Refer all servicing to qualified service personnel.



IMPORTANT SAFETY INSTRUCTIONS (Continued)

19. Replacement Parts

When replacement parts are required, be sure the service technician has used replacement parts specified by the manufacturer or have the same characteristics as the original part.

Unauthorized substitutions may result in fire, electric shock, or other hazards.

(Replacement of the lamp only should be made by users.)

20. Safety Check

Upon completion of any service or repairs to this product, ask the service technician to perform safety checks to determine that the product is in proper operating condition.



21. Do not leave thermal paper documents or easily deformed items on top of the unit or near the air exhaust for long periods of time.

The heat from the unit could erase the information on the thermal paper, or cause deformation or warping.

22. Do not use the product in a closed installation state.

Do not place the product in a box or in any other closed installation state. Otherwise it may overheat. This could result in a risk of fire.

23. Do not look into the laser light source of the remote control or direct the laser pointer toward a person or a mirror.

The laser beam may cause damage to the eyes or sight.

POWER SUPPLY CORD SELECTION

If your line voltage is 220 to 240V, use one of the following types of cable.

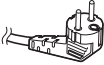
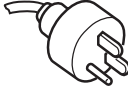
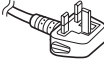
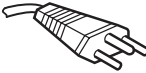
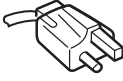
Plug configuration	Plug type	Line voltage	Plug configuration	Plug type	Line voltage
	EURO	220 – 240V		Australian 240V 10A	200 – 240V
	UK	220 – 240V		Switzerland 240V 6A	200 – 240V
Use a 5A fuse which is approved by ASTA or BSI to BSI362. Always replace the fuse cover after changing the fuse.				North American 240V 15A	200 – 240V

IMPORTANT PRECAUTIONS

Save Original Packing Materials

The original shipping carton and packing materials will come in handy if you ever have to ship your projector. For maximum protection, repack the set as it was originally packed at the factory.

Moisture Condensation

Never operate this unit immediately after moving it from a cold location to a warm location. When the unit is exposed to such a change in temperature, moisture may condense on the lens and the crucial internal parts. To prevent the unit from possible damage, do not use the unit for at least 2 hours when there is an extreme or sudden change in temperature.

Place and Manner of Installation

- Do not place in hot locations, such as near heating equipment. Doing so could cause malfunction, and shorten the life of the projector.
- Avoid locations with oil or cigarette smoke. Doing so will dirty the optical parts, shortening their lives, and darkening the screen.
- Do not use this product in the upright position or tilt it up or down by more than 20° from level. Doing so may cause a failure or shorten the life of the product.
- Using this instrument near a TV or radio may cause interference to the images or audio sound. If this happens, move it away from the TV or radio.
- Moving the projector from a low-temperature room to a high-temperature room may cause condensation on the lens or internal parts in the instrument. If you continue to use it in that situation, the malfunction may result. Ensure to wait until the condensation naturally disappears.
- In a high altitude location where air is thin, cooling efficiency is reduced so use the projector with **[Fan mode]** set to **[High]**.

IMPORTANT PRECAUTIONS (Continued)

- The set of projector is hot after use. Handle with care.
- Do not use the projector while holding it in your hands or lap.
- Do not use the projector near a power source and the like, or in locations like a ship or vehicle that are subject to vibration or shock. Doing so may lead to a malfunction or shorten service life.

Avoid Volatile Liquid

Do not use volatile liquids, such as an insect spray, near the unit. Do not leave rubber or plastic products touching the unit for a long time. They will leave marks on the finish. If cleaning with a chemically saturated cloth, be sure to follow the product's precautions.

EXEMPTION CLAUSES

- Toshiba Corporation bears no responsibility in the case of damages arising from natural disaster such as earthquakes, lightning, etc., fire not liable to Toshiba Corporation, acts by third parties, other accidents, or use under abnormal conditions including erroneous or improper operation and other problems.
- Toshiba Corporation bears no responsibility for incidental damages (lost profit, work interruption, corruption or loss of the memory contents, etc.) arising from the use of or the inability to use this unit.
- Toshiba Corporation accepts no liability whatsoever for any damages arising from not having followed the descriptions in this Instruction Manual.
- Toshiba Corporation accepts no liability whatsoever for any damages arising from malfunctions arising from combination with equipment or software that is not related to Toshiba Corporation.

In the spaces provided below, record the Model and Serial No. located at the bottom of your projector.

Model No. _____ Serial No. _____

Retain this information for future reference.

OTHER CAUTIONS AND INFORMATIONS

Copyrights

Showing or transmitting commercial imaging software or broadcast or cable-broad casting programs with the purpose of other than the personal and private viewing, including modifying images using the freeze functions, or displaying with the varying aspect ratio of the images, could violate the direct or indirect copyrights of the imaging software or broadcast program, etc., if done without first consulting with the copyright holder. For this reason, please take appropriate measures before performing one of the actions listed above, including obtaining a license from the copyright holder.

Disposal

Following information is only for EU-member states:

The use of the symbol indicates that this product may not be treated as household waste. By ensuring this product is disposed of correctly, you will help prevent potential negative consequences for the environment and human health, which could otherwise be caused by inappropriate waste handling of this product. For more detailed information about recycling of this product, please contact your local city office, your household waste disposal service or the shop where you purchased the product.



This product contains substances which are harmful to humans and the environment.

- The lamp contains inorganic mercury.
- Please dispose of this product or used lamps in accordance with local regulations.

Trademarks

- VGA, SVGA, XGA, SXGA, UXGA are trademarks or registered trademarks of International Business Machines Corporation.
- Digital Light Processing, Digital Micromirror Device and DMD are trademarks of Texas Instruments.
- Macintosh is a registered trademark of Apple Computer, Inc.
- Windows is a registered trademark of Microsoft Corporation in the U.S. and other countries.
- Adobe is a registered trademark and Acrobat Reader is a trademark of Adobe Systems Incorporated.

Notational Conventions Used in This Manual

- References to pages with related information are annotated as follows. For example, if making a reference to page 35:
- The illustrations in this document are for reference purposes only and may not reflect your package exactly.

REMOTE CONTROL BATTERIES

Caution

- Never throw batteries into a fire.

Notes

- Be sure to use AAA size batteries.
- Dispose of batteries in a designated disposal area.
- Attention should be drawn to the environmental aspects of battery disposal.
- Do not mix different battery types or combine used batteries with new ones.
- If the remote control does not operate correctly, or if the operating range becomes reduced, replace both batteries with new ones.
- If the batteries are dead or if you will not be using the remote control for a long time, remove the batteries to prevent battery acid from leaking into the battery compartment.

Using the batteries improperly may cause them to explode or leak and lead to burn or injury. If battery-leaking fluid contacts skin, wash the fluid off immediately with clean water and consult a doctor. If the fluid is spilt on an instrument, avoid contact and wipe it off using tissue paper.

(Dispose of the used tissue paper as flammable garbage after moistening with water.)

CONTENTS

Before Using

SAFETY PRECAUTIONS	2
IMPORTANT SAFETY INSTRUCTIONS	4
POWER SUPPLY CORD SELECTION	9
IMPORTANT PRECAUTIONS	9
EXEMPTION CLAUSES	10
OTHER CAUTIONS AND INFORMATIONS	11
REMOTE CONTROL BATTERIES	12

Preparations

Checking the package contents	15
Names of each part on the main unit	16
Names of each part on the control panel and remote control	17
Label locations	18
Parts on the rear panel	19
Preparing and using the remote control	20
Operating a computer using the remote control	21
Placement	22
Connection	24

Operations

Turning the power on and off	25
Basic operations	27
Using handy features	29
Using auto setting	29
Correcting the keystone distortion	29
Cutting off the picture and sound temporarily (Mute)	30
Freezing the image (Freeze)	30
Key Lock	30
Password function	30
Using the menus	32
How to use the menus	32
The image adjustment menu	33
The display setting menu	34
The default setting menu	35
Displaying Information (Status display)	36

Maintenance

About lamp	37
Lamp replacement	37
Lens and main unit cleaning	40

Others

Trouble indications	41
---------------------------	----

Before calling service personnel	42
Specifications	43
List of general specifications.....	43
Separately sold product.....	43
List of supported signals (RGB signals)	44
List of supported signals (Y/PB/PR signals)	45
List of supported signals (Video, S-Video signals)	45
Pin assignment of COMPUTER IN & MONITOR terminals.....	45
CONTROL terminal	46

Checking the package contents

Please make sure that the following items are included in the box, along with the main unit. If any item is missing, please contact the store immediately where you purchased the product.

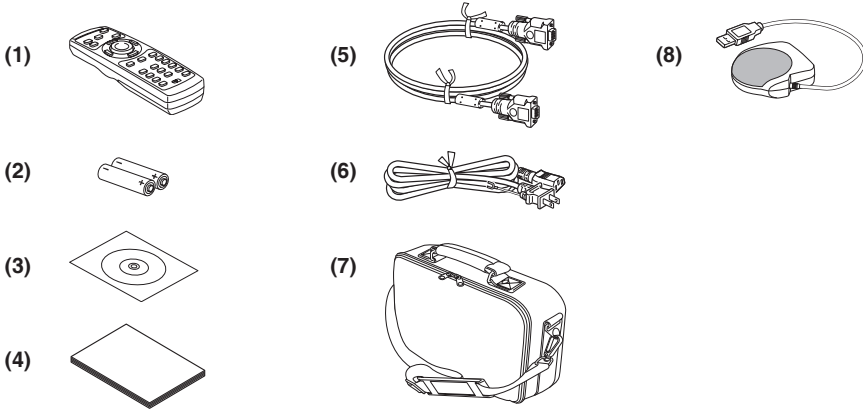

- (1) Remote control
- (2) LR03 (SIZE AAA) batteries for remote control (2)
- (3) CD-ROM
- (4) Owner's Manual
- (5) RGB cable (3m)
- (6) Power cord (See note)
- (7) Carrying bag
- (8) Mouse remote control receiver

Note

The shape and number of supplied power cords vary depending on the product destination.

◆ The Supplied CD-ROM

The supplied CD-ROM contains an owner's manual, including information not available for the printed Owner's manual (Getting started) and Acrobat® Reader™ to view the manual.

■ Installing Acrobat® Reader™

Windows®: Run the CD-ROM, select the **Reader/English** folder, and run **ar500enu.exe**. Follow the on-screen instructions.

Macintosh: Run the CD-ROM, select the **Reader/English** folder, and run **Reader Installer**. Follow the on-screen instructions to install the software.

■ Viewing the manual

Run the CD-ROM and double-click on **Start.pdf**. Acrobat® Reader™ launches, and the menu screen of the Owner's manual appears. Click on your language. The Owner's Manual cover and list of bookmarks appear. Click on a bookmark title to view that section of the manual. Click on **p.** to view a reference page with related information. See the Help menu for more information about Acrobat® Reader™.

Names of each part on the main unit

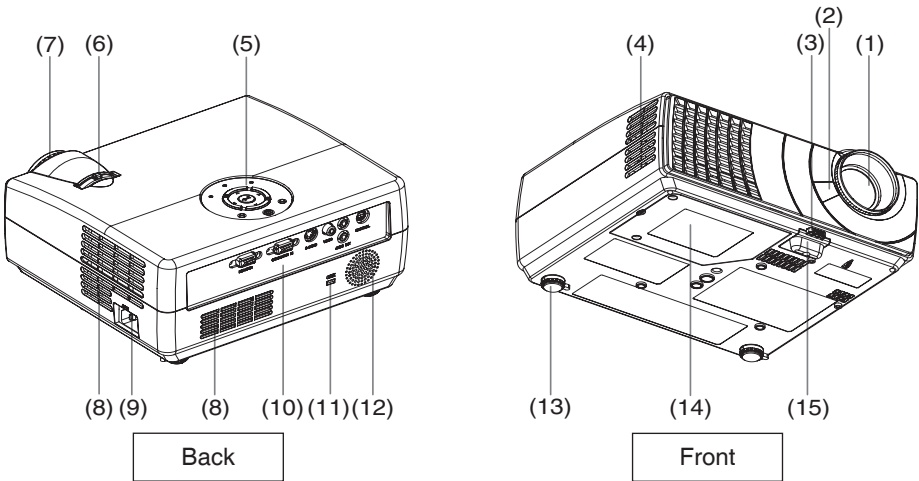

Name	: Function
(1) Lens	: Projects expanded image.
(2) Infrared remote sensor	: Senses commands from the remote control. p.20
(3) Foot adjuster release button	: Press to set up or stow the foot adjuster. p.28
(4) Air exhaust	: Expels air that has grown hot inside the projector.
(5) Control panel	: Operates the projector. p.17
(6) Zooming lever	: Adjusts screen size. p.28
(7) Focusing ring	: Adjusts screen focus. p.28
(8) Air intake	: Draws in air from outside the projector.
(9) AC IN socket	: Connect the supplied power cord here.
(10) Rear panel	: Connects external devices. p.17
(11) Antitheft lock hole	: Attach a safety cable or any other antitheft device.
(12) Speaker	: Outputs audio sound.
(13) Tilt adjuster	: Adjusts the projector's horizontal tilt. p.28
(14) Lamp cover	: Remove to replace lamp. p.38
(15) Foot adjuster	: Adjusts the vertical projection angle. p.28

Names of each part on the control panel and remote control

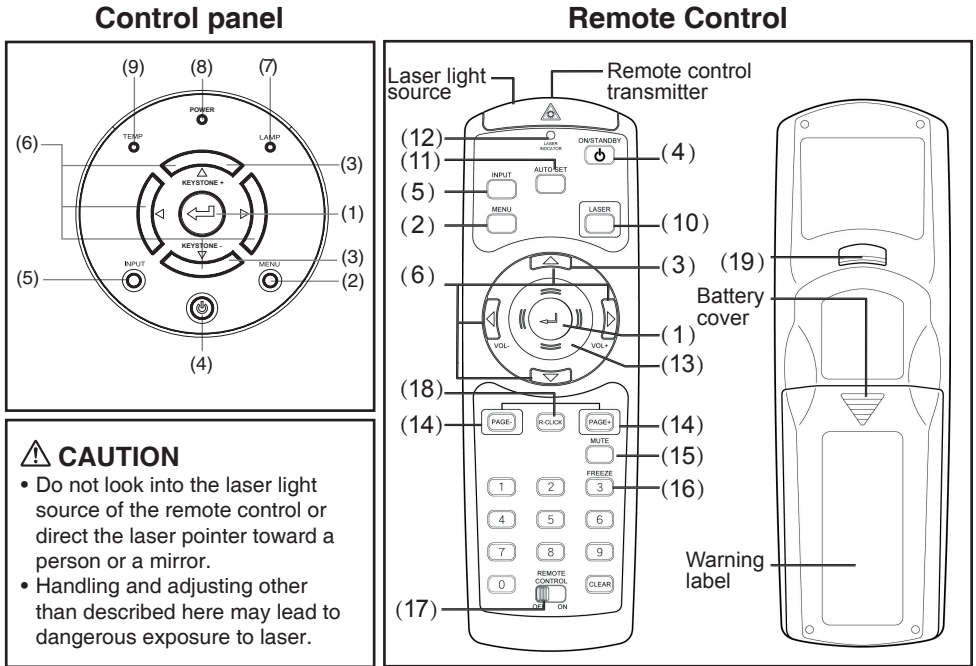

CAUTION

- Do not look into the laser light source of the remote control or direct the laser pointer toward a person or a mirror.
- Handling and adjusting other than described here may lead to dangerous exposure to laser.

Name : Main Function

Control panel

- (1) ENTER button : Accepts the selected mode.
- (2) MENU button : Displays menus. [p.32](#)
- (3) KEystone button : Adjusts keystone distortion. [p.29](#)
- (4) ON/STANDBY button : Turns the power on/off (standby). [p.26](#)
- (5) INPUT button : Selects input. [p.27](#)
- (6) Selection button : Menu selections and adjustments. [p.32](#)
- (7) LAMP indicator : Displays lamp mode. [p.26](#)
- (8) POWER indicator : Displays power on/off mode. [p.26](#)
- (9) TEMP indicator : Lights when internal temperature too high. [p.41](#)

Remote control

- (1) ENTER button : Accepts the selected mode.
- (2) MENU button : Displays menus. [p.32](#)
- (3) KEystone button : Adjusts keystone distortion. [p.29](#)
- (4) ON/STANDBY button : Turns the power on/off (standby). [p.26](#)
- (5) INPUT button : Selects input. [p.27](#)
- (6) Selection button : Menu selections and adjustments. [p.32](#)
- (10) LASER button : Shows a laser pointer.
- (11) AUTO SET button : Sets up analog input from computer. [p.29](#)

Preparations

Name	: Main Function
(12) Laser indicator	: Lights when laser is on.
(13) Mouse control button	: Controls a mouse pointer. p.21
(14) PAGE+/- button	: Proceeds PowerPoint® slides. p.21
(15) MUTE button	: Cuts off the picture and sound temporarily. p.30
(16) FREEZE button	: Pauses image. p.30
(17) Remote control ON/OFF switch	: Switches on/off the remote control. p.20
(18) R-CLICK button	: Functions as right-click of a mouse. p.21
(19) L-CLICK button	: Functions as left-click of a mouse. p.21

Note

- For the remainder of this manual, buttons are referred to as follows:
 Selection buttons ⇒ ; ENTER button ⇒

Label locations

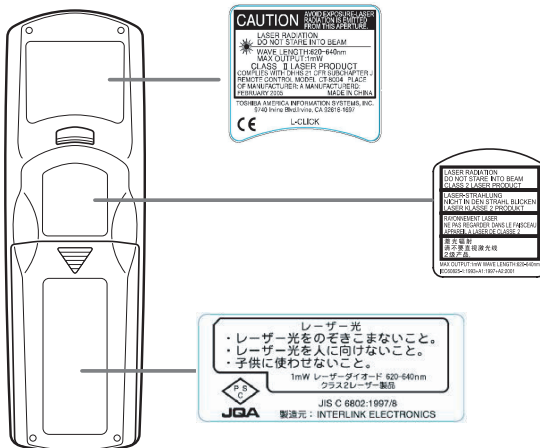

Caution – use of controls or adjustments or performance of procedures other than those specified herein may result in hazardous radiation exposure.

Parts on the rear panel

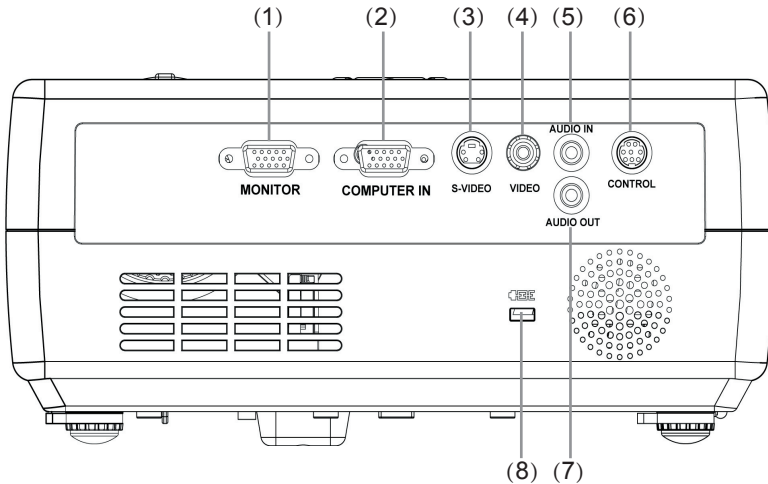

Name	: Main Function
(1) MONITOR terminal	: Connect to a computer display, etc.
(2) COMPUTER IN terminal	: Input analog RGB signal from a computer or other source, or a component video signal (Y/PB/PR) from video equipment.
(3) S-VIDEO terminal	: Input S video signals from video equipment.
(4) VIDEO terminal	: Input video signals from video equipment.
(5) AUDIO IN terminal	: Input audio signals.
(6) CONTROL terminal	
	RS232C :When operating the projector via a computer, connect this to the controlling computer's RS-232C port. p.46
(7) AUDIO OUT terminal	: Outputs audio signals.
(8) Antitheft lock hole	: Attach a safety cable or any other antitheft device.

Preparing and using the remote control

■ Loading dry-cell batteries into the remote control

- ① Remove the battery cover.

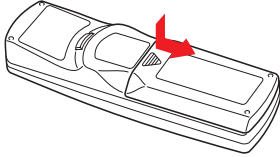

- ② Insert the dry-cell batteries.

Be sure to align the plus and minus ends of the batteries properly.

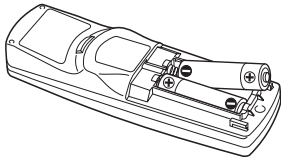

Two batteries (LR03, SIZE AAA) are used.

- ③ Replace the battery cover.

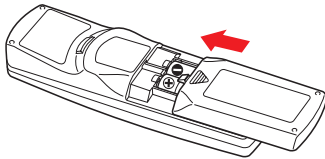

■ Dry-cell batteries

- Before using the batteries, be sure to observe the Safety Precautions described in previous pages.
- Remove batteries from remote control when not using for extended periods.
- If the remote control stops working, or if its range decreases, replace all the batteries with new ones.

■ The remote control

- Turn off the ON/OFF switch of the remote control when not in use or to store in baggage.
- The remote control may fail to operate if the infrared remote sensor is exposed to bright sunlight or fluorescent lighting.
- Do not drop or bang.
- Do not leave in hot or humid locations.
- Do not get wet or place on top of wet objects.
- Do not take apart.
- In rare cases, ambient conditions could impede the operation of the remote control. If this happens, point the remote control at the main unit again, and repeat the operation.

■ Operating the remote control

Turn on the ON/OFF switch of the remote control.

Point toward the projector's infrared remote sensor, and press a button on the remote control.

- Operating the projector from the front

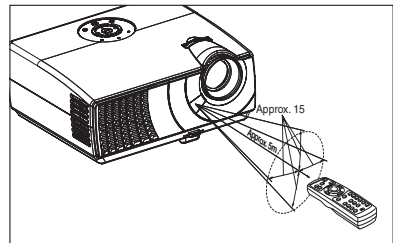

Operating a computer using the remote control

A computer can be operated using the projector's remote control. This function is available on any computer with the Windows 98/98SE, Windows Me, Windows 2000, or Windows XP OS, that is equipped with a USB port which can support USB1.1 (The mouse remote control receiver is also supported on OS 9 or OS X for the Macintosh). However, please note that Toshiba does not guarantee the operation of all computers.

1 Connecting a computer

Connect the mouse remote control receiver (supplied) to a computer.

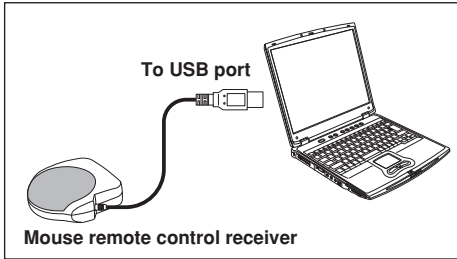

The remote control may fail to operate if the mouse remote control receiver is exposed to bright sunlight or fluorescent lighting.

In such a case, change position or direction of the mouse remote control receiver and retry.

2 Operating a computer

Operate remote control's buttons towards the mouse remote control receiver.

● Moving the mouse pointer

Press the mouse control button in the direction you wish the mouse pointer to move, then press.

● To left click

Press the L-CLICK button.

● To right click

Press the R-CLICK button.

● To drag and drop

Holding down the L-CLICK button, move the mouse control button until the mouse pointer is over the desired location, then release the L-CLICK button.

● Using the computer's page up [↑] and down [↓] function

Press the PAGE+ and PAGE- buttons to switch PowerPoint® slides.

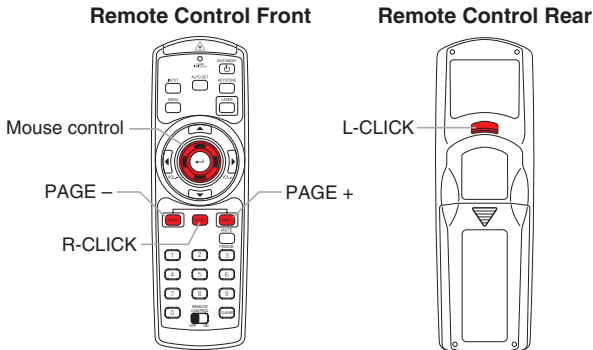

Placement

Placement Styles

As shown in the figures below, this device can be placed in 4 different styles. The factory setting is “floor-mounted front projection.” Set the [**Projection mode**] in the **Default setting** menu [p.36](#), in accordance with your needs.

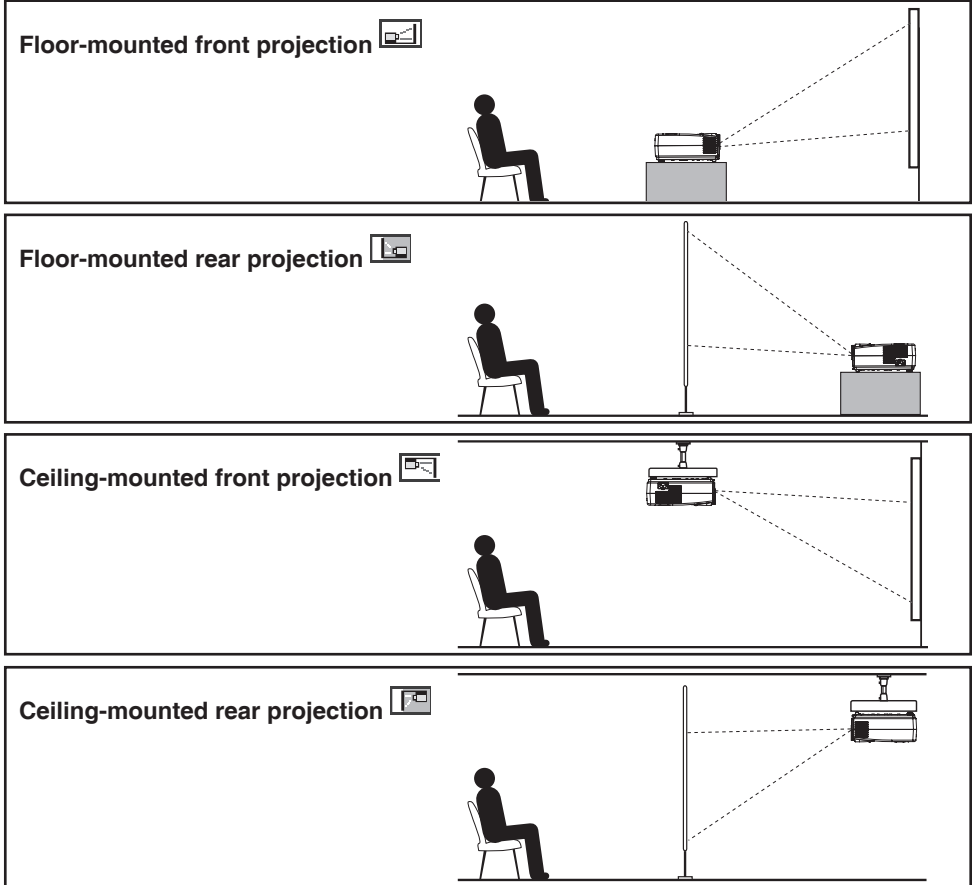

WARNING

- Always obey the instructions listed in **IMPORTANT SAFETY INSTRUCTIONS** when placing the unit. Attempting to clean/replace the lamp at a high site by yourself may cause you to drop down, thus resulting in injury.
- If you wish to mount the projector on the ceiling, be sure to ask your dealer to do so. Mounting the projector on a ceiling requires special ceiling brackets (sold separately) and specialized knowledge. Improper mounting could cause the projector to fall, resulting in an accident.
- If the projector is ceiling-mounted, install the breaker for turning off the power in case of anomaly. Let everyone involved with the use of the projector know that fact.

Projection Distance and Size

Use the figures, tables, and formulas below to determine the projection size and projection distance. (Projection sizes are approximate values for full-size picture with no keystone adjustment.)

Screen **As seen from above**

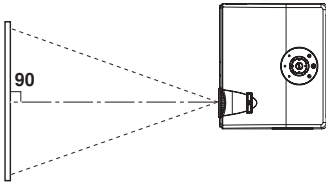

As seen from the side

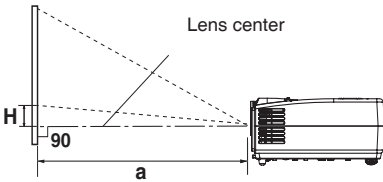

$$a \text{ (min length)} = \frac{\text{projection size (inches)}}{25.3807}$$

$$a \text{ (max length)} = \frac{\text{projection size (inches)}}{23.0947}$$

projection size (inches)	projection distance a (m)		height (H) (cm)
	min length (zooming max)	max length (zooming min)	
34.67	1.36	1.50	7.9
40	1.57	1.73	9.1
60	2.36	2.60	13.7
80	3.15	3.46	18.3
100	3.94	4.33	22.9
150	5.90	6.49	34.3
200	7.87	8.65	45.7
250	9.84	10.82	57.2
254.22	10	11	58.1

a is the distance (m) between the lens and the screen, and corresponds to a range of 1.36 m to 11 m. **H** is the height from the image bottom to the center of the lens.

Connection

Before connection

- Read the owner's manual of the device you are connecting to the projector.
- Some types of computer cannot be used or connected to this projector. Check for an RGB output terminal, supported signal [p.44](#), etc.
- Turn off the power of both devices before connecting.
- The figures are sample connections.
- The MONITOR terminal outputs analog RGB signals or component video signals (Y/Pb/Pr) from the COMPUTER IN terminals as selected with the INPUT button. If no input is selected, the MONITOR terminal outputs the input signals last selected among the COMPUTER terminals.
- A computer monitor usually cannot accept Y/Pb/Pr signals correctly.

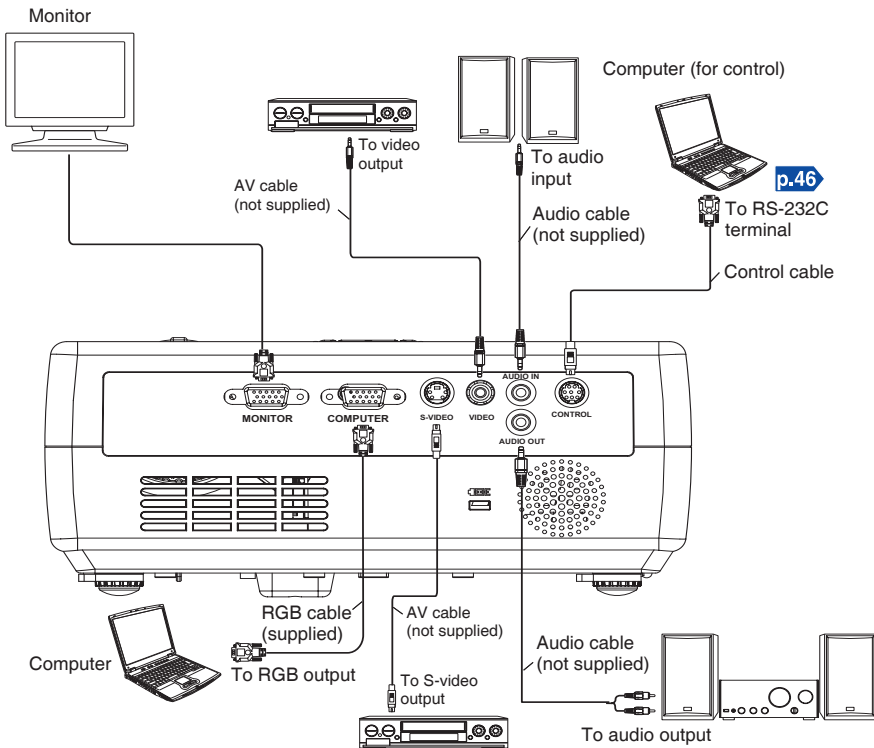

Notes

- Moving pictures played back on computers using DVD software may appear unnatural if it is projected with this projector, but it is not a malfunction.
- When an AUDIO OUT terminal is connected, sound is not output from the projector speaker.
- Output volume of AUDIO OUT terminal can be adjusted by the **VOL** button.

Turning the power on and off

■ Connecting the power cord

- 1 Insert the power cord connector into the AC IN socket of the projector.
- 2 Insert the power cord plug into a wall or other power outlet.

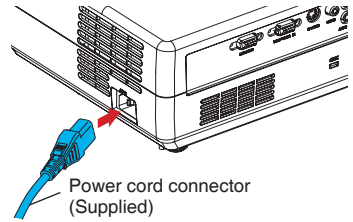

■ Removing the lens cover

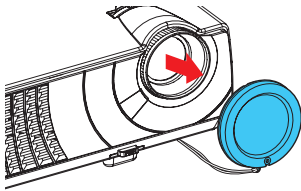

Be sure to remove the lens cover when the power is turned on. If it is left on, it could become deformed due to heat.

■ Turning the power on

- 1 Press the ON/STANDBY button.

The power turns on the green indicators light: Power. After a moment, the start-up screen appears.

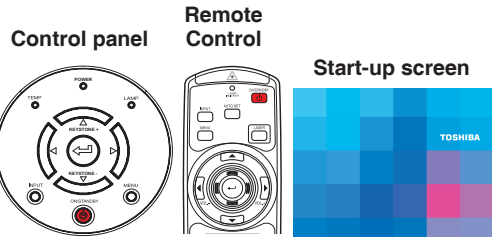

⚠ CAUTION

- Do not look into the lens while the lamp is on. The strong light from the lamp may cause damage to your eyes or sight.
- Do not block the air intake or exhaust. Doing so could cause a fire due to internal overheating.
- Do not place your hands, face, or other objects near the air exhaust. Doing so could cause burns, deform/break the object.

■ Notes

- The start-up screen will disappear after a moment. You can dismiss the start-up screen before this by performing any operation. You can also configure the start-up screen not to appear via the **Display setting** menu [p.34](#).
- The first time you use the projector after purchase, after the start-up screen disappears, the start menu is displayed [p.27](#).
- When [**Key lock**] is [**On**], the operation buttons of the projector do not work [p.30](#).
- When [**Password**] is [**On**], the start-up screen is displayed after the Password entry screen disappears [p.30](#).

■ Turning the power off

1 Press the ON/STANDBY button.

A message appears on the screen, confirming that you wish to shut off the power. This message will disappear after a moment. (This operation is no longer valid after the message disappears.)

2 Press the ON/STANDBY button again.

The screen turns off, but the internal cooling fan continues to operate for a short. Then, the projector goes into standby mode.

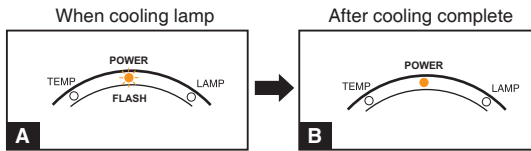

A During cooling, the Power indicator flashes. In this state, the power cannot be turned back on.

If you are in a hurry, there is no problem with unplugging the power cord or turning off the main power switch in this state.

B In standby mode

■ Note

- The projector consumes about 15W of power in standby. We recommend that you unplug the power cord if you will not be using the projector for an extended period.

■ PRECAUTION

- If the power cord is unplugged before cooling is complete, give the lamp time (about 5 minutes) to cool before plugging it back in.

Basic operations

1 Turn on the power.

Turn on the power by following the instructions in “Turning the power on” [p.25](#).

2 Select the language (When using the first time).

When the projector is used for the first time after purchase, the start menu for language (to display the menus and messages on screen) and configuration is displayed in English. (if the screen is out of focus, adjust it according to the step 6.)

① Use the ▲ or ▼ button to select the desired language and press the ⏏ button.

Message for setup confirmation is displayed in a selected language.

English	English
Deutsch	German
Français	French
Italiano	Italian
Español	Spanish
Português	Portuguese
中文(繁體字)	Chinese (traditional)
中文(简体字)	Chinese (simplified)
日本語	Japanese
한국어	Korean
Русский	Russian
Svenska	Swedish
Türkçe	Turkish
Polski	Polish

Notes

- When the projector is turned on the next time, the start menu does not appear upon startup. However, if [Reset all] is executed from the **Default setting** menu [p.35](#), the start menu will be displayed the next time when the power is turned on.
- The language can also be set via the **Display setting** menu [p.34](#).
- This owner's manual assumes that English has been selected.

3 Activate the connected device.

Turn on and start the connected device such as a computer.

4 Press the INPUT button.

An image of the connected equipment is projected.

Each time you press the **INPUT** button, it switches to the input of the connected equipment that is outputting video signals.

Notes

- When [Auto input search] is set to [On] in the **Default setting** menu [p.35](#) (factory setting is [On]), the input is switched to the connected equipment that is outputting video signals each time you press the **INPUT** button [p.43](#).

5 Projector placement angle adjustments

The placement angle and the height of the projected image can be adjusted by the foot adjuster.

- 1 **Lift up the front of the projector to the desired angle, then press the foot adjuster release button.**
The foot adjuster extends. Release the button to lock the position.
- 2 **To adjust the horizontal angle, use the tilt adjuster.**

To stow the foot adjuster, hold up the projector while pressing the foot adjuster release button, then slowly lower the projector.

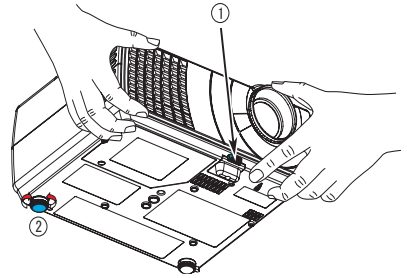

6 Adjusting the screen size and focus

- 1 **Use the zooming lever to adjust the screen size.**
- 2 **Use the focusing ring to adjust the focus.**

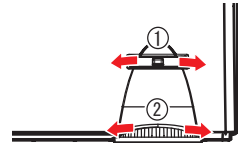

Notes

- Note that a lamp characteristics may rarely cause the brightness to fluctuate slightly.
- A lamp is consumable item. If used for extended periods, images will appear dark, and the lamp could burn out. This is characteristic of a lamp, and is not malfunction. (The lifetime of the lamp depends on conditions of use.)
- The DMD™ is made using extremely advanced technology, but there may be black spots (pixels that do not light) or bright spots (pixels that are constantly lit) on the panel. Please note that these are not malfunctions.
- Although this projector supports a wide range of RGB signals [p.44](#), any resolutions not supported by this projector (XGA) will be expanded or shrunk, which will affect image quality slightly. To view high-quality images, it is recommended that the computer's external output should be set to XGA resolution.
- With some models of computer having LCD displays or the like, displaying images simultaneously on the projector and the monitor's display may prevent the images from displaying properly. If this happens, turn off the computer's LCD display. For information on how to turn off the LCD display, see the owner's manual of your computer.
- If no signal is being input from the connected equipment or signal input is stopped while projecting, the "No signal" will appear.
- If a signal not supported by the projector is input, the "Unsupport signal" will appear.
- If an unavailable operation button is pressed, the  icon will appear.

Using handy features

■ Using auto setting (Only for analog input from computer)

This function sets up the projector to the optimum state such as sampling phase, frequency, screen position, and clamp for each type of the input signal by using simple operations.

● Press the remote control's AUTO SET button.

For computer input, the  icon will appear during processing.

Remote Control

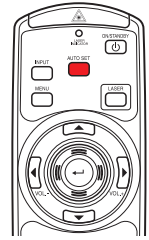

■ Notes

- The image may not be projected or auto adjustment/setting may not be performed correctly for input signals other than those supported by the projector [p.43](#) , [p.44](#) .

■ Correcting the keystone distortion

When the projector placement angle against the screen is changed while projecting the image, the picture will undergo keystone (trapezoidal) distortion.

This projector is capable of correcting this keystone distortion.

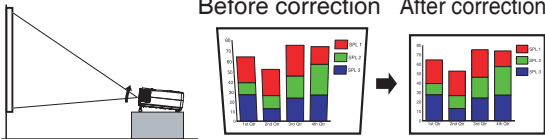

Control panel

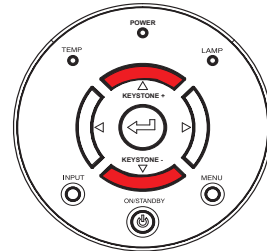

Press the **KEYSTONE ▲** or **▼** button.

■ Cutting off the picture and sound temporarily (Mute)

When you want to project the images of another projector, overhead projector, etc. temporarily, this projector's images and sound can be turned off.

● Press the remote control's MUTE button.

The picture and sound are cut off. (The Mute function is released when pressing the **MUTE** button again.)

■ Notes

- The  icon will appear while mute is in effect.
- Operating any other functions will also cancel the muting.

Remote Control



■ Freezing the image (Freeze)

The image being projected can be frozen. This function is to be used to pause a video during a presentation, etc.

● Press the remote control's FREEZE button.

The picture pauses. (The Freeze function is released when pressing the **FREEZE** button again.)

■ Notes

- The  icon will appear while freeze is in effect.
- Other operation will also release the freeze.
- Even if an image is frozen on the projector, the pictures are running on the video or other equipment.
- If you use this function on commercial video software, broadcast or cable-broadcasting except for the purpose of your private viewing and listening, it may infringe the copyright protected by the copyright laws.

Remote Control

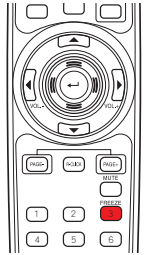

■ Key Lock

① To enter key lock

Push and hold MENU button 5sec.

② To exit from key lock

Push and hold MENU button 5sec.

If push any key during key locking, display key lock icon.

- Protect from operating errors by locking on the control panel buttons of the projector (The remote control operation are available)

■ Password function

● How to set password (from [Off] to [On])

① Select [Password] in the Default setting menu and press the button.

The password setting screen is displayed

Using handy features (Continued)

② Select [On] and press  button to the set new password item and press .

③ Enter a 4 digit number for the password using numeric key of the remote control.

The input number appears as [****].

④ Re-enter the same password for confirmation.

When the password is confirmed the setting is complete and the password becomes [On].

If the password is wrong repeat the procedure from step ③.

● How to operate when password is [On]

① Turn on the power.

② The lamp lights and the password entry screen appears.

③ Enter the password using numeric keys of the remote control.

If the entered password is correct, the start-up screen appears and the projector goes into normal operation. If the password is wrong, a message appears to prompt you to re-enter the password. If you enter a wrong password for more than 5 times, the projector will automatically power off and enter standby mode.

● How to cancel password (from [On] to [Off])

① Select [Password] in the Default setting menu and press the  button.

The password entry screen is displayed.

② Enter the password using numeric key of the remote control.

③ Select [Off] and press the menu button.

④ Select [OK] and press the  button.

The [Password] is canceled and becomes [Off].

■ Note

- The password entry screen appears when the power is turned back on only after the power cord is unplugged.

If you forgot the password, please inquire your dealer.

Using the menus



You can call up on-screen menus, and conduct a number of adjustments and settings using the operation buttons **p.17** on the control panel (main unit side) and remote control.

■ How to use the menus





The menu shown below is for operation instructions purposes and might differ from the actual display.

1. Press the MENU button Display the **Setting display** menu.

2. Select a Category

Select a category by using  .

There are following five categories:

-  **Image adjustment menu**
-  **Display setting menu**
-  **Default setting menu**
-  **Status display menu**

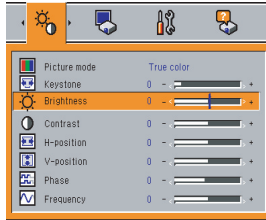

Displays the current adjustments and settings of selected category. Item shown with gray cannot be adjusted with the current input source.



3. Adjustments & Settings

Press the  or  button.

Item

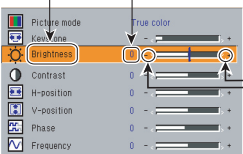

Adjustment/Setting Value

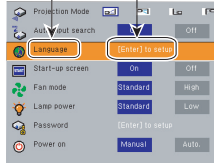

These marks signify the items can be adjusted/set by using  .



These marks signify that there are options. Press  to display a list of options.

These marks signify the items can be selected from the list by using  . After an item is selected, apply it by pressing .

Select Language

- English
- Deutsch
- Franses
- Italiano
- Espanol
- Portugues
- 繁體中文
- 简体中文
- 한국어
- Русский
- Срpsки
- Turkce
- ไทย





































The figure shows displays given for operation instructions purposes. As the display may differ depending on the item, use the following pages as a reference.

5. End
Press the **MENU button**
The menu disappears.

4. Back MENU button

■ The image adjustment menu

Use this menu to set or adjust image-related items. Items that can be set or adjusted are marked with “Yes”, and those that cannot are marked with “No”. (When an item is masked, it indicates that you cannot select for the current input.)













Item  	Description	Analog (D-SUB)		Video	S-video
		RGB	Y/P _B /P _R		
 Picture mode	Toggle the picture mode with  /  Bright/Standard/True color(RGB) Standard/Cinema (Y/P _B /P _R , Video, S-video)	Yes	Yes	Yes	Yes
 Keystone	Correct the keystone (trapezoid) distortion of the screen. Screen shrinking   Screen shrinking downward   Screen shrinking upward	Yes	Yes	Yes	Yes
 Brightness	Adjust the brightness of the image. Darker   Brighter	Yes	Yes	Yes	Yes
 Contrast	Adjust the image contrast. Lower   Higher	Yes	Yes	Yes	Yes
 Color	Adjust the color of the image. Lighter   Deeper	No	Yes	Yes	Yes
 Tint ^{*1}	Adjust the tint of the image color. Reddish   Greenish	No	No	Yes	Yes
 Sharpness	Adjust the sharpness of the image. Softer   Sharper	No	Yes	Yes	Yes
 H-position	Adjust the horizontal position of the image. Move left   Move right	Yes	No	No	No
 V-position	Adjust the vertical position of the image. Move down   Move up	Yes	No	No	No
 Phase	Adjust with   to eliminate flicker.	Yes	No	No	No
 Frequency	Adjust with   to eliminate periodic patterns and flickering when many vertical lines appear on the screen.	Yes	No	No	No

*1: [Tint] can be displayed and adjusted only when the video signal is set to [NTSC] and [NTSC4.43].

■ The display setting menu

Use this menu to set screen display-related items.

(The items in gray color cannot be set with the current input selection.)

Item ▲ ▼	Description
 Screen size	  (Full): Display with 1024 × 768 dot resolution  (Thru): Display with sampling resolution  (Wide): Wide-screen display
 16:9 Position	Adjust the vertical position of 16:9 image Lower ◀ ▶ Higher
 Background	Screen to display when there is no input signal (Logo)  ◀ ▶  (Blue) ◀ ▶  (Black)
 Icon	Display icons as function guides On ◀ ▶ Off
 Reset all	Press  Resets all adjustments and settings to their factory settings. Yes ◀ ▶ No

● Detailed description

[Screen size]

- If “Thru” is selected for [Screen size], portions exceeding the native resolution (1024 × 768 pixels) will not appear on the screen. Note that for RGB signals with clock frequency 140MHz or lower, all input pixel signals are sampled. However, if the clock speed is higher than this, the RGB pixel signal is thinned before sampling.
- If you use the screen size setting function on commercial video software, broadcast or cable-broadcasting programs to display images with the varying aspect ratio except for the purpose of your private viewing and listening, it may infringe the copyright protected by the copyright laws.















[Background]

- TOSHIBA is set for [Logo] by factory setting.

Using the menu (Continued)

■ The default setting menu

This menu shows placement status and other settings.

Item ▲ ▼	Description
 Projection mode	Sets projection mode in accordance with Placement Style. p.22  (Standard) ◀ ▶  (Rear) ◀ ▶  (Ceiling) ◀ ▶  (Rear ceiling)
 Auto input search	Set whether the input with signals is only selected or not. On ◀ ▶ Off
 Language	Select one of the languages below to use for displaying the menu and messages [ : Enter setting mode] → [▲ ▼ : Selection] → [Apply: ] English/Français/Deutsch/Italiano/Español/Português/Русский /Svenska/Türkçe/Polски/日本語 / 中文(簡体字) / 中文(繁体字) / 한국어
 Start-up screen	Display start-up screen when power is turned on On ◀ ▶ Off
 Fan mode	Sets the cooling fan speed. Standard ◀ ▶ High
 Lamp power	Sets the lamp power. Low ◀ ▶ Standard
 Password	Password function p.30 On ◀ ▶ Off When [Password] is [On], the Password Setting screen is displayed.
 Power on	Sets whether to turn on the power when the ON/STANDBY button is pressed (Manual), or when the power cord is plugged in (Auto). Manual ◀ ▶ Auto

● Detailed description

[Fan mode]

Setting [**Fan mode**] to [**High**] increases the cooling fan speed. Set this option to use the projector, for example, at high altitude (over 1,500 meters above sea level).

[Lamp power]

When [**Lamp power**] is set to [**Low**], the screen becomes a little darker, but the cooling fan noise gets quieter.

Using the menus (Continued)

■ Displaying Information (Status display)

This displays information about the input signal, lamp use time, etc.

“Yes”: displayed, “No”: not displayed

Item	Description	Computer	Y/Pb/Pr	Video	S-video
Input	Input source name	Yes	Yes	Yes	Yes
Resolution	Resolution (in dots)	Yes	No	No	No
Video mode	Color method of video signal	No	Yes	Yes	Yes
Picture mode	A group of Pre-set display mode	Yes	Yes	Yes	Yes
Lamp time	Time of lamp use ^[Note 3]	Yes	Yes	Yes	Yes
Version	Firmware version ^[Note 4]	Yes	Yes	Yes	Yes

Notes

- 1: The mode of supported RGB signals [p.44](#) is shown.
- 2: Sync signal polarity shown as P (positive) or N (negative) for [H/V].
- 3: Displays [**Lamp time**] as a measure of when the lamp should be replaced. (Cannot be used as a counter of guaranteed lamp time.) When the displayed time approaches 2,000 hours, consult with a store about getting a TLPLV6 replacement lamp (sold separately) prepared.
- 4: [**Version**] shows the version of the projector's internal control program. This version is referred to for customer service, etc.

About lamp

The product's light source is a mercury lamp that lights at increased internal pressure. Be sure to fully understand the following characteristics of the lamp and handle it with extreme care.

- The lamp may burst with a loud noise due to impact or deterioration, or fail to light at the expiration of its life.
- How long it takes before the lamp bursts or the life expires may vary greatly by lamp. Some may burst shortly after first use.
- Burst is likely to happen if the lamp is used after the replacement period has elapsed.
- When the lamp bursts, the broken pieces of glass may get inside the product or be released outside from the openings for ventilation.
- When the lamp bursts, a slight amount of mercury gas enclosed in the lamp along with glass dust may be released from the openings for ventilation.

■ Immediately replace the lamp when a sign appears on the screen.

- When the replacement time approaches, a message will appear on the screen.
- The risk of burst will increase if the lamp is continuously used without being replaced.
- Frequently check the used hours and prepare spares when the replacement time approaches. (Refer to "Status display". [p.36](#))

■ When the lamp is broken

- If glass components, including a lamp and a lens, should break, handle the broken pieces with care to avoid injury and contact your dealer for repair service.
- In the event of lamp burst, unplug the product from the wall outlet, leave and completely ventilate the room. Then, thoroughly clean the area around the projector and discard any edible items placed in that area.
- When the lamp bursts, consult a doctor if glass dust or mercury gas gets into your eyes or you breathe it.

Lamp replacement

A lamp is consumable supplies. If used for extended periods, images will appear dark, and the lamp could burn out. This is characteristic of a lamp, and is not malfunction. (The lifetime of the lamp depends on condition of use.) If this happens, replace it with a new one.

WARNING

- **If the projector is mounted on the ceiling, it is recommended to use your Toshiba dealership when the lamp has to be exchanged.**
Uncovering the lamp while the projector is mounted on a ceiling may lead to a danger of damage from falling pieces of glass if the lamp is broken. Besides, working at high elevations can also be hazardous. Do not attempt to replace the lamp by yourself.
- When replacing, always use lamp "TLPLV6" (sold separately).

CAUTION

- If you have been using the projector, the lamp will be very hot, and may cause burn injuries. Wait for the lamp to cool (for longer than 1 hour) before replacing it.
- If the lamp should break, please handle with care to avoid injury due to broken pieces and contact your dealer for repair service.

Lamp replacement (Continued)

1 Unplug power cord.

2 Wait until lamp is sufficiently cooled.

Wait for at least 1 hour.

3 Remove the lamp cover.

Loosen the two screws, raise the outer lamp cover with your fingers as shown to remove the outer lamp cover. Use care to avoid any damage to nails and/or tip of your finger(s). If you have any difficulty in removal, you can use a screwdriver or any other smaller tool for your convenience.

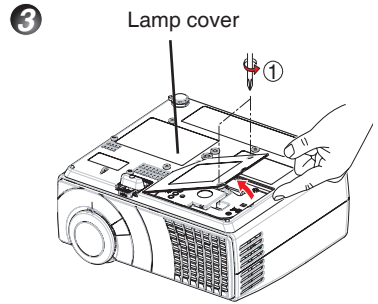

4 Pull out the lamp.

Loosen the two lamp locking screws, pull up the handle to remove the lamp.

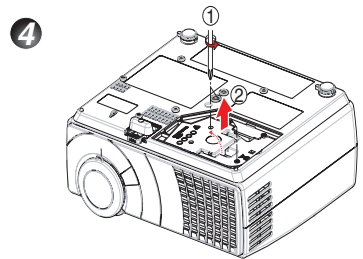

5 Mount the new lamp.

Align the orientation, press down the new lamp until the bottom is reached, and lock in place using the two lamp locking screws.

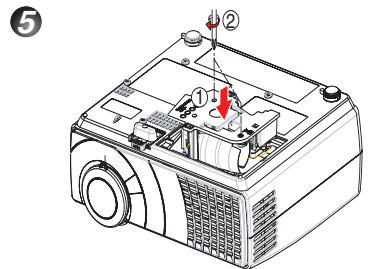



6 Replace the lamp cover.

Align the cover, and press it in, then tighten the screws loosened in step 3 until the lamp cover is no longer loose.

7 Reset the lamp timer.

See the lamp's manual for instructions on resetting the lamp timer.

■ Notes and Precautions

- It is recommended that the lamp be replaced after 2,000 hours of use. When **[Lamp time]** reaches 2,000 hours, the  icon and a message will appear. (After 2,000 hours, they will appear when the power is on at the first time every 100 hours.) This display disappears when you press the  button.
- Attach the outer lamp cover correctly so that it is not loose. If it is not attached correctly, the projector may fail to be powered on or the lamp may fail to come on.
- Always replace the lamp with a new one.
- The lamp is made out of glass. Do not touch the glass surface with your bare hands, bang it, or scratch it. (Dirt, jolts, scratches and the like could break the lamp.)

■ Used Lamps

This projector's lamps contain trace amounts of environmentally harmful inorganic mercury. Be careful not to break used lamps, and dispose of them in accordance with local regulations.

Lens and main unit cleaning

WARNING

- Request cleaning and maintenance of a ceiling-mounted unit from your projector dealership. Attempting to clean/replace the lamp at a high site by yourself may cause you to fall down, thus resulting in injury.

■ Lens cleaning

- Clean the lens with a commercially available blower and/or lens cleaner.
- The lens is easily scratched, so do not rub it with hard objects, or strike it.

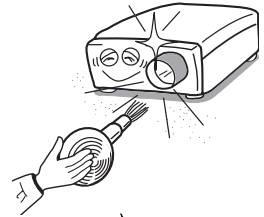





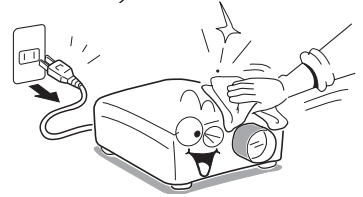

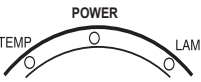

■ Main unit cleaning

- Clean the main unit after unplugging the power cord.
- Wipe dirt off the main unit gently with a soft cloth.
- Do not wipe the main unit with a damp cloth. Doing so may allow water to get inside, resulting in an electric shock or failure.
- Do not use benzene, thinner and the like as they may deform or discolor the unit or damage the paint surface.
- When using a chemically treated cloth, follow the precautions included with the cloth.



Trouble indications

The indicator lights inform you of interterminal abnormalities.

	<p>No power</p> <p>⇒ Problem with projector</p> <ul style="list-style-type: none"> • Unplug the power cord, and contact your dealer.
	<p>Lamp went out during use, or won't come on</p> <p>⇒ Lamp temperature is high so that it is difficult to turn on, the lifetime of the lamp has ended or the projector is malfunctioning.</p> <ul style="list-style-type: none"> • Unplug the power cord and wait for a short while, then turn the power back on. • If a lamp burns out, replace it with a new one. <p>※ After approx. 5 second of abnormal display, the projector returns to the standby state waiting for internal cool down.</p>
	<p>Power went out during use</p> <p>⇒ Internal overheating, or the outside temperature is too high.</p> <ul style="list-style-type: none"> • Place the projector so that the air intake and exhaust are not blocked. • Unplug the power cord and wait for a short while, then turn the power back on. <p>※ The  icon will appear before the power goes out.</p> <p>※ After approx. 5 second of abnormal display, the projector returns to the standby state waiting for internal cool down.</p>
	<p>Power went out during use</p> <p>⇒ Problem with internal cooling fan.</p> <ul style="list-style-type: none"> • Unplug the power cord, and contact your dealer. <p>※ The  icon will appear before the power goes out.</p> <p>※ After approx. 5 second of abnormal display, the projector returns to the standby state waiting for internal cool down.</p>
	<p>Power went out during use</p> <p>⇒ Problem inside the projector.</p> <ul style="list-style-type: none"> • Unplug the power cord and wait for a short while, then turn the power back on. • If the above action will not clear the problem, unplug the power cord, and contact your dealer. <p>※ The  icon will appear before the power goes out.</p> <p>※ After approx. 5 second of abnormal display, the projector returns to the standby state waiting for internal cool down.</p>

Before calling service personnel

If you think something is wrong, check the followings before contacting customer service. Please see “Trouble indications” [p.41](#) as well.

If This Happens	Check
No power	<ul style="list-style-type: none"> • Is the power cord plugged in? Is it connected to the projector? • Is the outer lamp cover attached properly? p.38
Power goes out during use	<ul style="list-style-type: none"> • Is the ambient temperature high? p.41 • Is the air intake or air exhaust blocked? p.41
No picture	<ul style="list-style-type: none"> • Is the mute function on? p.30 • Is the brightness setting minimized? p.33 • Are the connections set up correctly? p.24 • Are all the connected devices functioning properly?
No audio	<ul style="list-style-type: none"> • Is the mute function on? p.30 • Are the connections set up correctly? p.24 • Are all the connected devices functioning properly?
Picture not displayed correctly	<ul style="list-style-type: none"> • Is the input signal supported by the projector? p.44, p.45 • Is there something generating an abnormal video signal, for instance the video tape?
Picture blurred Part of picture out of focus	<ul style="list-style-type: none"> • Is the lens dirty? p.40 • Is the lens focus adjusted optimally? p.28 • Is the projection distance within the projector’s supported range? p.23 • Is the projector’s screen placement angle tilted too far? p.23 • Are the sharpness or sampling phase adjustments off?
Image is dark	<ul style="list-style-type: none"> • Are the brightness or contrast adjustments off? p.33 • Is the lamp nearing the end of its service life? p.36
Colors too light Bad shading	<ul style="list-style-type: none"> • Are the color,tint adjustments off? p.33 • Is the screen dirty? • Is the lamp nearing the end of its service life? p.33
Control panel key doesn’t work	<ul style="list-style-type: none"> • Is the key lock function on? p.30
Remote control doesn’t work	<ul style="list-style-type: none"> • Is the remote control ON/OFF switch set off? p.20 • Are the remote control’s batteries drained? • Are the batteries inserted into the remote control correctly? p.20 • Is the remote control being used within the effective range? p.20 • Are there any obstructions between the remote control and projector? • Are there any fluorescent or other bright lights shining at the projector’s infrared remote sensor?

Specifications

■ List of general specifications

Item	Specification	
Consumption Power	275 W	
Weight	2.0 kg	
External Dimensions (including protruding parts)	239 x 107 x 207 (W x H x D)	
Cabinet material	PC+ABS resin and ABS resin	
Conditions for usage environment	Temp: 5°C to 35°C; relative humidity: 30% to 70%	
Display pixels	1 chip DMD™	
Picture elements	786,432 pixels (1024H × 768V)	
Lens	Zoom lens F=2.7-3.0 f=21.81-23.77 mm	
Lamp	High-pressure mercury lamp (200 W)	
Projection screen size	34.67-254.22 inches	
Projection distance	1.36-11m	
Speaker	2 W	
Connection terminal	CONTROL terminal	RS-232C: Mini DIN 8 pin
	COMPUTER(Y/P _B /P _R) IN terminal	Mini D sub 15 pin Analog RGB / Y/P _B /P _R (dual use)
	VIDEO terminal	S-VIDEO: Mini DIN 4 pin
		VIDEO: RCA Pin Jack
		AUDIO 3.5mm dia stereo mini-jack
	MONITOR terminal	Mini D sub 15 pin RGB / Y/P _B /P _R (dual use)
AUDIO OUT terminal	3.5mm dia. stereo mini-jack	

■ Notes

- This model complies with the above specifications.
- Designs and specifications are subject to change without notice.
- This model may not be compatible with features and/or specifications that may be added in the future.

■ Separately sold product

Replacement Lamp Model TLPLV6

Specifications (Continued)

■ List of supported signals (RGB signals)

This projector supports the following RGB signals. Note, however, that depending on the computer model, the screen may show flicker or streaking. Please adjust the projector if this happens.

Resolution	Mode	Refresh rate [Hz]	H-frequency [KHz]	Clock (MHz)
640x480	VGA_60	59.94	31.46	25.17
	VGA_72	72.8	37.86	31.5
	VGA_75	75	37.5	31.5
	VGA_85	85	43.26	36
720x400	720x400_70	70	31.5	32
	720x400_85	85.03	37.92	35.5
800x600	SVGA_56	56.25	35.15	36
	SVGA_60	60.3	37.87	40
	SVGA_72	72.18	48.07	50
	SVGA_75	75	46.87	49.5
	SVGA_85	85.06	53.67	56.25
1024x768	XGA_60	60	48.36	65
	XGA_70	70.06	56.47	75
	XGA_75	75.02	60.02	78.75
	XGA_85	84.99	68.67	94.5
1280x1024	1280x1024_60	60.02	63.98	108
	1280x1024_75	75.02	79.97	135
1152x864	1152x864_70	70	63.85	90.3
	1152x864_75	75	67.5	108
	1152x864_85	84.99	77.09	130
1280x960	1280x960_60	60	60	108
	1280x960_75	75	75	120
1400x1050	SXGA +	60	63.98	118
832x624	MAC 16"	74.55	49.725	57.28
1024x768	MAC 19"	75	60.24	79.85
1152x870	MAC	75.06	68.68	81
640x480	MAC G4	60	31.35	40
1024x768	i Mac DV	75	60	79
1152x870	i Mac DV	75	68.49	80.05
1280x960	i Mac DV	75	75	120

■ Note

- Signals which resolution exceeds the native resolution (1024 × 768 pixels) will be compressed. For this reason, some information may be lost, or image quality may be affected.

■ List of supported signals (Y/P_B/P_R signals)

Signal format	fh(kHz)	fv(Hz)
* 480i(525i)@60Hz	15.73	59.94
480p(525p)@60Hz	31.47	59.94
* 576i(625i)@50Hz	15.63	50.00
576p(625p)@50Hz	31.25	50.00
720p(750p)@60Hz	45.00	60.00
720p(750p)@50Hz	37.50	50.00
1080i(1125i)@60Hz	33.75	60.00
1080i(1125i)@50Hz	28.13	50.00

■ List of supported signals (Video, S-Video signals)

Video mode	fh(kHz)	fv(Hz)	fsc(MHz)
NTSC	15.73	60	3.58
PAL	15.63	50	4.43
SECAM	15.63	50	4.25 or 4.41
PAL-M	15.73	60	3.58
PAL-N	15.63	50	3.58
PAL-60	15.73	60	4.43
NTSC4.43	15.73	60	4.43

■ Pin assignment of COMPUTER IN & MONITOR terminals

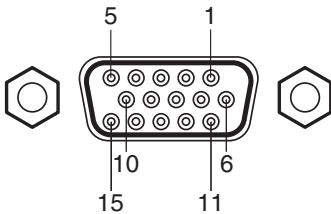

Mini D sub 15 Pin connector

Input Signal

• RGB input

- RGB signals: 0.7V (p-p) 75 Ω
- Horizontal sync signal: TTL level (Pos/neg polarity)
- Vertical sync signal: TTL level (Pos/neg polarity)

• Y/P_B/P_R input

- Y signal: 1.0V (p-p) 75 Ω
- P_B/P_R signals: 0.7V (p-p) 75 Ω

Pin No.	Pin description	
	During RGB input	During Y/P _B /P _R input
1	Video signal (R)	Color difference signal (P _R)
2	Video signal (G)	Luminance signal (Y)
3	Video signal (B)	Color difference signal (P _B)
4	N.C	*
5	GND	*
6	GND (R)	GND (P _R)
7	GND (G)	GND (Y)
8	GND (B)	GND (P _B)
9	+5V	*
10	GND	*
11	N.C	*
12	SDA	*
13	Horizontal sync signal	*
14	Vertical sync signal	*
15	SCL	*

* Do not connect anything.

■ CONTROL terminal

● Pin assignment

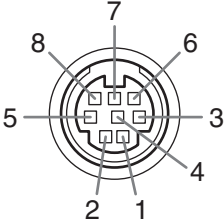

Mini DIN 8 pin connector

Pin No.	Signal Name	Description
1	RXD	Receiving data
2	N.C	No connection
3	N.C	No connection
4	GND	Signal ground
5	N.C	No connection
6	N.C	No connection
7	TXD	Sending data
8	GND	Signal ground

■ Notes

- Contact your dealer for control cable and commands.



TOSHIBA CORPORATION