

***myprojectorlamps.com***

**The most trusted, dependable name  
in projector lamp sales.**



<http://www.myprojectorlamps.com>



<http://www.myprojectorlamps.ca>



<http://www.myprojectorlamps.eu>

The following projector manual has not been modified or altered in any way.

**TOSHIBA**  
Leading Innovation >>>

# TDP-T420 TDP-T360 DATA PROJECTOR

---

## OWNER'S MANUAL

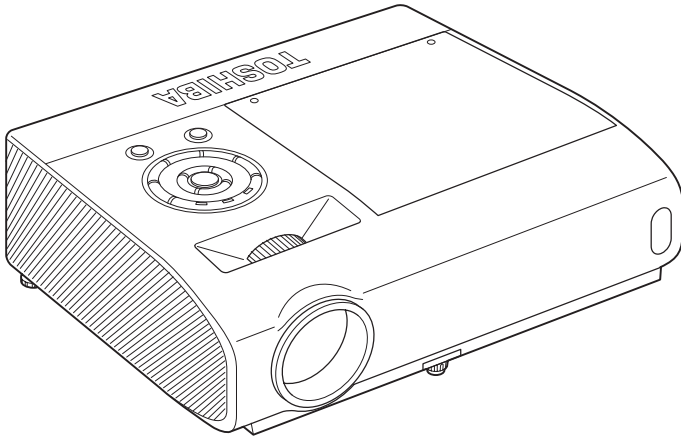

In the spaces provided below, record the Model and Serial No. located at the bottom of your projector.

Model No. \_\_\_\_\_ Serial No. \_\_\_\_\_

Retain this information for future reference.

Before Using

Preparations

Operations

Maintenance

Others



# SAFETY PRECAUTIONS



The lightning flash with arrowhead symbol, within an equilateral triangle, is intended to alert the user to the presence of uninsulated "dangerous voltage" within the product's enclosure that may be of sufficient magnitude to constitute a risk of electric shock to persons.



The exclamation point within an equilateral triangle is intended to alert the user to the presence of important operating and maintenance (servicing) instructions in the literature accompanying the appliance.

**WARNING:** TO REDUCE THE RISK OF FIRE OR ELECTRIC SHOCK, DO NOT EXPOSE THIS APPLIANCE TO RAIN OR MOISTURE. DANGEROUS HIGH VOLTAGES ARE PRESENT INSIDE THE ENCLOSURE. DO NOT OPEN THE CABINET. REFER SERVICING TO QUALIFIED PERSONNEL ONLY.

**WARNING:** Handling the cord on this product or cords associated with accessories sold with this product, will expose you to lead, a chemical known to the State of California to cause birth defects or other reproductive harm. ***Wash hands after handling.***

**USA only**

**USA only**

Lamp contains mercury. Disposal of this product may be regulated due to environmental considerations. For disposal, reuse or recycling information, please contact your local government or the Electronic Industries Alliance at [www.eiae.org](http://www.eiae.org).

## MODEL NAME: TDP-T420 / TDP-T360

### FCC Radio Frequency Interference Statement

**Note:** This equipment has been tested and found to comply with the limits for a Class A digital device, pursuant to part 15 of the FCC Rules. These limits are designed to provide reasonable protection against harmful interference when the equipment is operated in a commercial environment. This equipment generates, uses, and can radiates radio frequency energy and, if not installed and used in accordance with the instruction manual, may cause harmful interference to radio communications. Operation of this equipment in a residential area is likely to cause harmful interference in which case the user will be required to correct the interference at his own expense.

**USA only**

**WARNING:** Changes or modifications made to this equipment, not expressly approved by Toshiba, or parties authorized by Toshiba, could void the user's authority to operate the equipment.

**USA only**

**Notice:** This Class A digital apparatus complies with Canadian ICES-003. Cet appareil numérique de la classe A est conforme à la norme NMB-003 du Canada.

**CANADA only**

**WARNING:** This is a Class A product. In a domestic environment this product may cause radio interference in which case the user may be required to take adequate measures.

Following information is only valid for EU-member States:

### Disposal of batteries and/or accumulators

The crossed out wheeled dust bin symbol indicates that batteries and/or accumulators must be collected and disposed of separately from household waste.

If the battery or accumulator contains more than the specified values of lead (Pb), mercury (Hg), and/or cadmium (Cd) defined in the Battery Directive (2006/66/EC), then the chemical symbols for lead (Pb), mercury (Hg) and/or cadmium (Cd) will appear below the crossed out wheeled dust bin symbol.

By participating in separate collection of batteries, you will help to assure the proper disposal of products and batteries and thus help to prevent potential negative consequences for the environment and human health.

For more detailed information about the collection and recycling programmes available in your country, please contact your local city office or the shop where you purchased the product.



Hg Cd Pb

Before Using

# IMPORTANT SAFETY INSTRUCTIONS

**CAUTION: PLEASE READ AND OBSERVE ALL WARNINGS AND INSTRUCTIONS GIVEN IN THIS OWNER'S MANUAL AND THOSE MARKED ON THE UNIT. RETAIN THIS BOOKLET FOR FUTURE REFERENCE.**

This unit is fully transistorized and does not contain any parts that can be repaired by the user.

**WARNING: DO NOT REMOVE THE CABINET COVER, OR YOU MAY BE EXPOSED TO DANGEROUS VOLTAGE. REFER SERVICING TO QUALIFIED SERVICE PERSONNEL ONLY.**

## 1. Read Owner's Manual

After unpacking this product, read the owner's manual carefully, and follow all the operating and other instructions.



## 2. Power Sources

This product should be operated only from the type of power source which does not exceed the voltage range specified on the rating label and the power cord. If you are not sure of the type of power supply to your home, consult your product dealer or local power company.



## 3. Source of Light

Do not look into the lens while the lamp is on. The strong light from the lamp may cause damage to your eyesight.

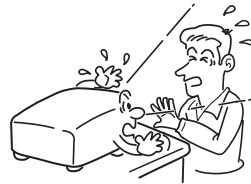

## 4. Ventilation

Openings in the cabinet are provided for ventilation and to ensure reliable operation of the product and to protect it from overheating. These openings must not be blocked or covered. Never block an opening by placing the product on a bed, sofa, rug or other similar surface. Do not place it in a built-in installation such as a bookcase or rack, unless proper ventilation is provided.



## 5. Heat

The product should be situated away from heat sources such as radiators, heat registers, stoves, or other products (including amplifiers) that produce heat.

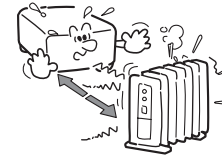

## 6. Water and Moisture

Do not use this product near water. - for example, near a bath tub, wash bowl, kitchen sink, or laundry tub; in a wet basement; or near a swimming pool and the like.

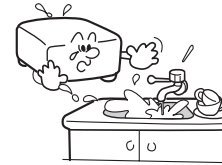

## 7. Cleaning

Unplug this product from the wall outlet before cleaning. Do not use liquid cleaners or aerosol cleaners. Always use a soft cloth for cleaning.

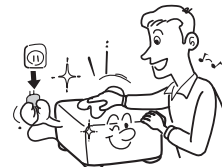

## 8. Be sure that you firmly insert the plug into the wall outlet.

Incorrect or faulty connections may result in fire or electric shock. Avoid using an unsound or loose outlet.

## 9. Power Cord Protection

Power cords should be routed so that they are not likely to be walked on or pinched by items placed upon or against them, paying particular attention to cords at plugs, convenience receptacles, and the point where they exit from the product.



## 10. Overloading

Do not overload wall outlets. To reduce the risk of electric shock, do not use the polarized plug with an extension cord, receptacle, or other outlet unless the blades can be inserted completely with three-wire grounding type to prevent blade exposure. Failure to follow these instructions may result in fire or electric shock.



## IMPORTANT SAFETY INSTRUCTIONS (Continued)

### 11. Lightning storms

For added protection for this product during a storm, or when it is left unattended and unused for long periods of time, unplug it from the wall outlet. This will prevent damage to the product due to lightning and power-line surges. Never operate this unit on AC power during a thunderstorm. If you see lightning or hear thunder, never touch the unit, cables and/or peripherals. An electric surge caused by the storm, may result in an electrical shock or damage to the unit.

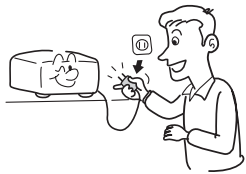

### 12. Object and Liquid Entry

Never push objects of any kind into this product through openings as they may touch dangerous voltage points or short-out parts that could result in a fire or electric shock. Never spill liquid of any kind on the product.

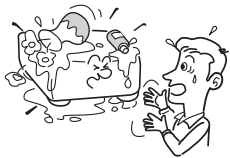

### 13. Do not place or keep the projector within the reach of the children.

It may fall or tip over, possibly causing serious injury.

### 14. Do not place the product vertically

Do not use the product in the upright position or any other vertical positions to project the pictures. It may fall which could result in serious injury and/or damage to the product.

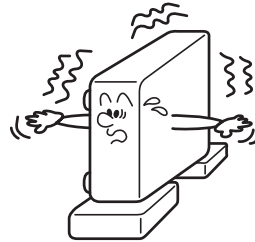

### 15. Stack Inhibited

Do not stack other equipment on this product and do not place this product on other equipment. The top and bottom surface of this product increase in temperature during normal use and may damage the other unit.



### 16. Moving the projector

When carrying the projector, be sure to use the carrying handle to avoid any damage to the lens or main unit.

### 17. Attachments

Do not use attachments not recommended by the product manufacturer. Use of an incompatible attachments could cause hazards or damage to the product.

### 18. Accessories

Do not place this product on an unstable cart, stand, tripod, bracket, or table. The product may fall, causing serious injury to a child or adult, and serious damage to the product. A product and cart combination should be moved with care. Quick stops, excessive force, and uneven surfaces may cause the product and cart combination to overturn.



### 19. Damage Requiring Service

Unplug this product from the wall outlet and take the product to qualified service personnel if you encounter any of the following conditions:

- The power supply cord or plug is damaged.
- Liquid has been spilled, or objects have fallen into the product.
- The product has been exposed to rain or water.
- The product does not operate normally when following the operating instructions. Adjust only those controls that are covered by the operating instructions since an improper adjustment of other controls may result in damage and will often require extensive work by a qualified technician to restore the product to its normal operation.
- The product has been dropped or damaged in any way (If the cabinet should break, please handle with care to avoid injury) .
- The product exhibits a distinct change in performance, which indicates a need for service.

## IMPORTANT SAFETY INSTRUCTIONS (Continued)

### 20. If glass components, including lens and lamp, should break, contact your dealer for repair service.

This product incorporates glass components, including a lens and a lamp.

If these should break, please handle with care to avoid injury and contact your dealer for repair service. Avoid any broken pieces of glass since they may cause injury. In the unlikely event that the lamp ruptures, thoroughly clean the area around the projector and discard any edible items placed in that area since they may be contaminated.

### 21. Servicing

Do not attempt to service this product yourself as opening or removing covers may expose you to dangerous voltage or other hazards. Refer all servicing to qualified service personnel.



### 22. Replacement Parts

When replacement parts are required, be sure the service technician has used replacement parts specified by the manufacturer or have the same characteristics as the original part. Unauthorized substitutions may result in fire, electric shock, or other hazards. (Only the replacement of the lamp should be made by users.)

### 23. Safety Check

Upon completion of any service or repairs to this product, ask the service technician to perform safety checks to verify that the product is in proper operating condition.



### 24. Do not leave thermal-paper documents or easily deformed items on top of the unit or near the air exhaust for long periods of time.

The heat from the unit could erase the information on the thermal paper, or cause deformation or warping.

### 25. Do not use the product in a closed installation location.



Do not place the product in a box or in any other closed installation location. Otherwise it may overheat, which could result in a risk of fire.

### 26. Do not look into the laser light source of the remote control or direct the laser pointer toward a person or a mirror.

The laser beam may cause damage to the eyesight.

## POWER SUPPLY INFORMATION

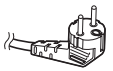
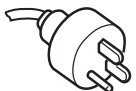
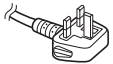
If your line voltage is 220 to 240 V, use one of the following types of cable/plug.

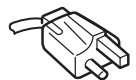
Plug configuration	Plug type	Line voltage	Plug configuration	Plug type	Line voltage
	EURO	220 – 240 V		Australian 240 V 10 A	200 – 240 V
	UK	220 – 240 V		Switzerland 240 V 6 A	200 – 240 V
				North American 240 V 15 A	200 – 240 V

Use a 5 A fuse which is approved by ASTA or BSI to BS1362. Always replace the fuse cover after changing the fuse.

## IMPORTANT PRECAUTIONS

### Moisture Condensation

Never operate this unit immediately after moving it from a cold location to a warm location. When the unit is exposed to such a change in temperature, moisture may condense on the lens and the crucial internal parts. Do not use the unit for at least 2 hours when there is an extreme or sudden change in temperature to prevent the unit from possible damage.

### Place and Manner of Installation

- Do not place in hot locations, such as near heating equipment. Doing so could cause malfunction, and shorten the life of the projector.
- Avoid locations with oil or cigarette smoke. Doing so will dirty the optical parts, shortening their lives, and darkening the screen.
- Do not use this product in the upright position or tilt it up or down by more than 20° from level. Doing so may cause a failure or shorten the life of the product.
- Using this instrument near a TV or radio may cause interference to the images or audio sound. If this happens, move it away from the TV or radio.
- Moving the projector from a low-temperature room to a high-temperature room may cause condensation on the lens or internal parts. If you continue to use it in that situation, it may malfunction. Wait until the condensation naturally disappears.
- In a high altitude location where air is thin, cooling efficiency is reduced so use the projector with [Fan mode] set to [High]. [p.42](#)
- Only plug the power cord into outlets rated for use with the power cord's specified voltage range. Do not overload extension cords or power strips as this can result in fire or electric shock.
- Route the power cable or the connecting cable away from where people could trip over it. The projector may fall down, which could result in severe injury.
- Be sure the power cord is easily reached for unplugging in case of emergency. Do not place any obstacles near a wall outlet in which the cord is plugged.

## IMPORTANT PRECAUTIONS (Continued)

### Avoid Volatile Liquid

Do not use volatile liquids, such as an insect spray, near the unit. Do not leave rubber or plastic products touching the unit for a long time as they will leave marks on the finish. Do not use a chemically saturated cloth.

## EXEMPTION CLAUSES

- Toshiba Corporation bears no responsibility in the case of damages arising from natural disaster such as earthquakes, lightning, etc., fire not liable to Toshiba Corporation, acts by third parties, other accidents, or use under abnormal conditions including erroneous or improper operation and other problems.
- Toshiba Corporation bears no responsibility for incidental damages (lost profit, work interruption, corruption or loss of the memory contents, etc.) arising from the use of or the inability to use this unit.
- Toshiba Corporation accepts no liability whatsoever for any damages arising from not having followed the descriptions in this Owner's Manual.
- Toshiba Corporation accepts no liability whatsoever for any damages arising from malfunctions arising from combination with equipment or software that is not related to Toshiba Corporation.

## OTHER INFORMATION

### Copyrights

Showing or transmitting commercial imaging software or broadcast or cable-broad casting programs with the purpose of other than the personal and private viewing, including modifying images using the freeze or resize functions, or displaying with the varying aspect ratio of the images, could violate the direct or indirect copyrights of the imaging software or broadcast program, etc., if done without first consulting with the copyright holder. For this reason, please take appropriate measures before performing one of the actions listed above, including obtaining a license from the copyright holder.

### Disposal

This product contains substances which are harmful to humans and the environment.

- The lamp contains mercury.

Please dispose of this product or used lamps in accordance with local regulations.

#### Following information is only for EU-member states:

The use of the symbol indicates that this product may not be treated as household waste. By ensuring this product is disposed of correctly, you will help prevent potential negative consequences for the environment and human health, which could otherwise be caused by inappropriate waste handling of this product. For more detailed information about recycling of this product, please contact your local city office, your household waste disposal service or the shop where you purchased the product.



## OTHER INFORMATION (Continued)

### Trademarks

- VGA, SVGA, XGA, SXGA, UXGA are trademarks or registered trademarks of International Business Machines Corporation.
- DLP (Digital Light Processing) is a registered trademark of Texas Instruments, Inc.
- Macintosh is a registered trademark of Apple Computer, Inc.
- Windows is a registered trademark of Microsoft Corporation in the U.S. and other countries.
- Adobe and Acrobat Reader are registered trademarks of Adobe Systems Incorporated.
- All other brand and product names are trademarks or registered trademarks of their respective companies.

### Notational Conventions Used in This Manual

- References to pages with related information are annotated as follows. For example, if making a reference to page 36: [p.36](#)
- The illustrations in this document are for reference purposes only and may not reflect your package exactly.

## REMOTE CONTROL BATTERIES

### Warning

- Never throw batteries into a fire.

Using the batteries improperly may cause them to explode or leak and may result in serious injury.

If battery-leaking fluid contacts skin, wash the fluid off immediately with clean water and consult a doctor. If the fluid spills on an instrument, avoid contact and wipe it off using tissue paper. Then dispose of the used tissue paper as flammable garbage after moistening with water.

### Notes

- Be sure to use AAA (LR03) size batteries.
- Dispose of batteries in a designated disposal area.
- Attention should be drawn to the environmental aspects of battery disposal.
- Do not mix different battery types or combine used batteries with new ones.
- If the remote control does not operate correctly, or if the operating range becomes reduced, replace both batteries with new ones.
- If the batteries are dead or if you will not be using the remote control for a long time, remove the batteries to prevent battery acid from leaking into the battery compartment.

# CONTENTS

## Before Using

SAFETY PRECAUTIONS .....	2
IMPORTANT SAFETY INSTRUCTIONS .....	4
POWER SUPPLY INFORMATION .....	9
IMPORTANT PRECAUTIONS .....	9
EXEMPTION CLAUSES .....	10
OTHER INFORMATION .....	10
REMOTE CONTROL BATTERIES .....	11
CONTENTS .....	12

## Preparations

Checking the package contents .....	14
Names of each part on the main unit .....	15
Names of each part on the control panel and remote control .....	16
Label location .....	17
Names of the terminals on the rear panel .....	18
Preparing and using the remote control .....	19
Operating a computer using the remote control .....	20
Placement .....	21
Connection .....	22

## Operations

Turning the power on and off .....	24
Basic operations .....	26
Using handy features .....	29
Using auto setting (For computer input only) .....	29
Correcting the keystone distortion .....	29
Zooming out the images .....	30
Resizing image .....	31
Cutting off the picture and sound temporarily (Mute) .....	32
Changing picture mode .....	32
Changing screen size .....	32
Freezing the image (Freeze) .....	33
Setting the password .....	33
Using the menus .....	35
Setup using the Setting display .....	35
The image adjustment menu .....	36
The position adjustment menu .....	37
The display setting menu .....	38
The Default setting menu .....	41
Displaying Information (Status display) .....	43

## Maintenance

About lamp .....	44
Lamp replacement .....	45
Lens and main unit cleaning .....	48

## Others

Trouble indications .....	49
Troubleshooting .....	50
Specifications .....	52



# Checking the package contents

Please make sure that the following items are included in the box, along with the main unit. If any item is missing, immediately contact the store where you purchased the product.

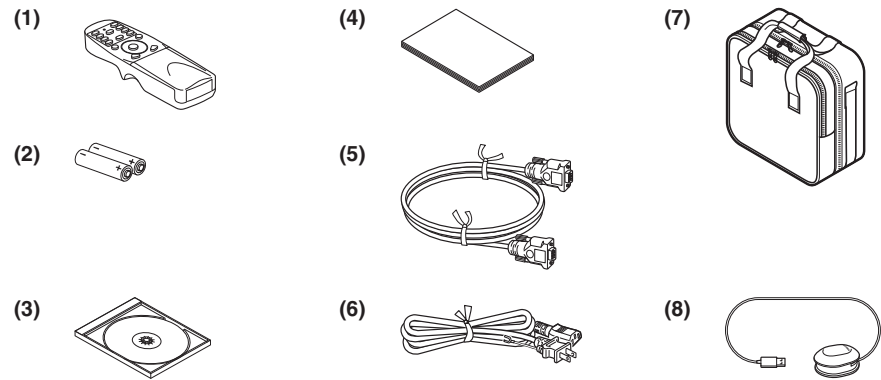

- (1) Remote control
- (2) LR03 (SIZE AAA) batteries for remote control (2)
- (3) CD-ROM
- (4) Owner's Manual
- (5) RGB cable (3 m) <sup>[Note 1]</sup>
- (6) Power cord <sup>[Note 1, 2]</sup>
- (7) Carrying bag
- (8) Mouse remote control receiver

### Notes

- 1: To maintain original performance, always use the supplied cables.
- 2: The shape and number of supplied power cords vary depending on the product destination.

## Save Original Packing Materials

The original shipping carton and packing materials will come in handy if you ever have to ship your projector. For maximum protection when shipping your projector, repack the set as it was originally packed at the factory.

### ◆The Supplied CD-ROM

The supplied CD-ROM contains an owner's manual including information not available for the printed Owner's manual (Getting started) and Quick Reference in Portable Document Format (PDF). Please use **Acrobat Reader 5** or later version to view the manual.

### ■ Adobe® Acrobat® Reader® or Adobe® Reader®

The supplied CD-ROM does not contain **Acrobat® Reader®**. If you cannot read PDF files, please install **Acrobat Reader** software in your computer by downloading it from the Adobe Systems website.

### ■ Viewing the manual

Run the CD-ROM and double-click on **Start.pdf**. Acrobat® Reader® launches, and a screen appears asking you that "Select your model", then click on the model name that you are using. After you select [Owner's manual] on the next screen, click on the desired language. The Owner's Manual cover and list of bookmarks appear. Click on a bookmark title to view that section of the manual. Click on **p.** to view a reference page with related information. See the Help menu for more information about Acrobat® Reader®.

# Names of each part on the main unit

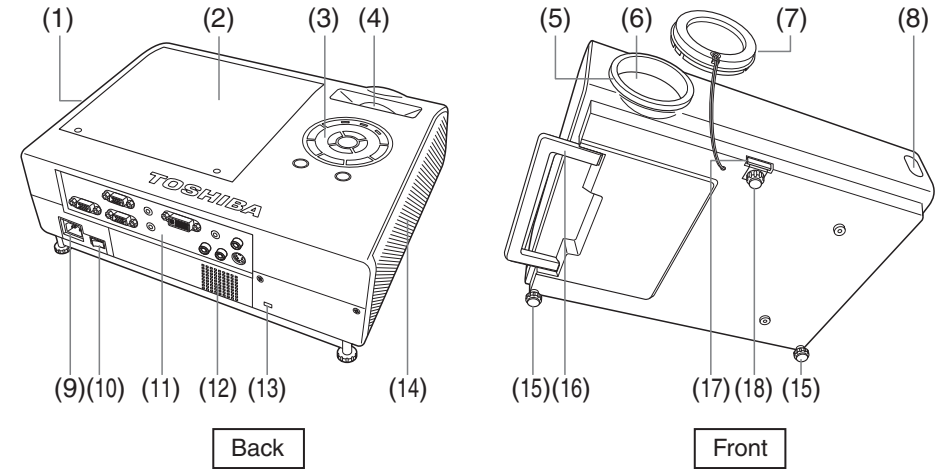

Name	Function
(1) Air exhaust	: Expels air that has grown hot inside the projector.
(2) Lamp cover	: Remove to replace lamp. <a href="#">p.46</a>
(3) Control panel	: Operates the projector. <a href="#">p.16</a>
(4) Zooming ring	: Adjusts screen size. <a href="#">p.27</a>
(5) Focusing ring	: Adjusts screen focus. <a href="#">p.27</a>
(6) Lens	: Projects expanded image.
(7) Lens cap	: Replace the cap when not using the projector to protect the lens.
(8) Infrared remote sensor	: Senses commands from the remote control. <a href="#">p.19</a>
(9) AC IN socket	: Connect the supplied power cord here.
(10) Main power switch	: AC power line ON (standby)/OFF.
(11) Terminals on the rear panel	: Connects external devices. <a href="#">p.18</a>
(12) Speaker	: Outputs audio sound.
(13) Antitheft lock slot	: Attach a safety cable or any other antitheft device.
(14) Air intake	: Draws in air from outside the projector for internal cool down.
(15) Tilt adjuster	: Adjusts the projector's horizontal tilt. <a href="#">p.27</a>
(16) Handle	: Hold to carry the projector by pulling out.
(17) Foot adjuster release button	: Press to set up or stow the foot adjuster. <a href="#">p.27</a>
(18) Foot adjuster	: Adjusts the vertical projection angle. <a href="#">p.27</a>

# Names of each part on the control panel and remote control

## Control panel

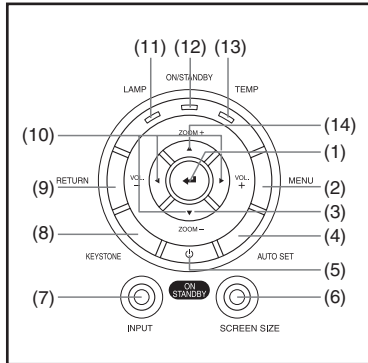

### CAUTION

- Do not look into the laser light source of the remote control or direct the laser pointer toward a person or a mirror.
- Handling and adjusting other than described in this manual may lead to dangerous exposure to laser.

## Remote Control

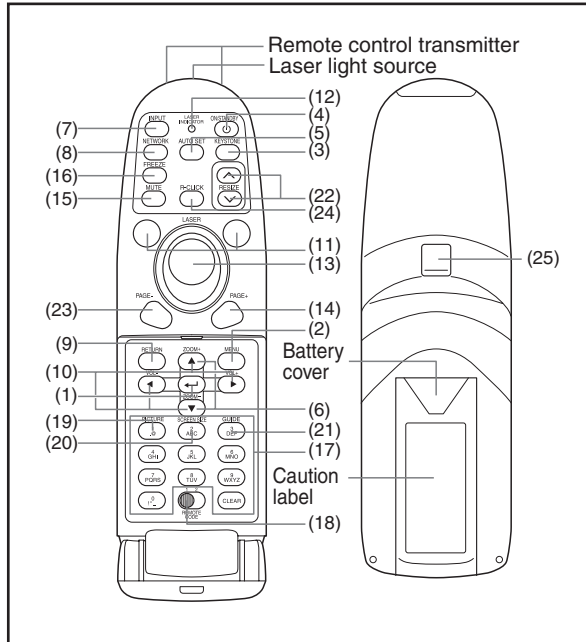

Name : Main Function

### Control panel

- (1) ENTER button : Accepts the selected mode.
- (2) MENU button : Displays menus. [p.35](#)
- (3) ZOOM – button : Adjusts the screen size.
- (4) AUTO SET button : Performs auto-adjustment of input signals from computer. [p.29](#)
- (5) ON/STANDBY button : Turns the power on/off (standby). [p.24](#)
- (6) SCREEN SIZE button : Changes screen size. [p.32](#)
- (7) INPUT button : Selects input. [p.26](#)
- (8) KEYSTONE button : Adjusts keystone distortion. [p.29](#)
- (9) RETURN button : Goes back one screen.
- (10) Selection button : Menu selections and adjustments, volume control, etc. [p.35](#)
- (11) LAMP indicator : Displays lamp mode. [p.49](#)
- (12) ON/STANDBY indicator : Displays whether power is on or off (standby). [p.24](#)
- (13) TEMP indicator : Lights when internal temperature is too high. [p.49](#)
- (14) ZOOM + button : Adjusts the screen size.

### Remote control

- (1) ENTER button : Accepts the selected mode.
- (2) MENU button : Displays menus. [p.35](#)
- (3) KEYSTONE button : Adjusts keystone distortion. [p.29](#)
- (4) ON/STANDBY button : Turns the power on/off (standby). [p.24](#)
- (5) AUTO SET button : Performs auto-adjustment of input signals from computer. [p.29](#)
- (6) ZOOM button : Adjusts the screen size.
- (7) INPUT button : Selects input. [p.26](#)
- (8) NETWORK button : **NETWORK** button is not operable with this projector.

Name : Main Function

- (9) RETURN button : Goes back one screen.
- (10) Selection button : Menu selections and adjustments, volume control, etc. [p.35](#)
- (11) LASER button : Shows a laser pointer.
- (12) Laser indicator : Lights when laser is on.
- (13) Mouse control button : Controls a mouse pointer. [p.20](#)
- (14) PAGE+ button : Proceeds PowerPoint® slides. [p.20](#)
- (15) MUTE button : Cuts off the picture and sound temporarily. [p.32](#)
- (16) FREEZE button : Pauses image. [p.33](#)
- (17) Ten-Key button\* : Use when entering password.

Remote control button	Input items	Remote control button	Input items
	[1]		[7]
	[2]		[8]
	[3]		[9]
	[4]		[0]
	[5]		Deletes one character.
	[6]		

- (18) Remote control code switch : Sets the code of remote control to that of the projector. [p.42](#)
- (19) PICTURE button : Changes image mode. [p.32](#)
- (20) SCREEN SIZE button : Changes screen size. [p.32](#)
- (21) GUIDE button : **GUIDE** button is not operable with this projector.
- (22) RESIZE button : Enlarges image. [p.31](#)
- (23) PAGE- button : Goes back PowerPoint® slides. [p.20](#)
- (24) R-CLICK button : Functions as right-click of a mouse. [p.20](#)
- (25) L-CLICK button : Functions as left-click of a mouse. [p.20](#)

\* The characters of **Ten-Key** buttons are not available.

### Note

- For the remainder of this manual, buttons are referred to as follows:  
Selection buttons ⇒ ; ENTER button ⇒

## Label location

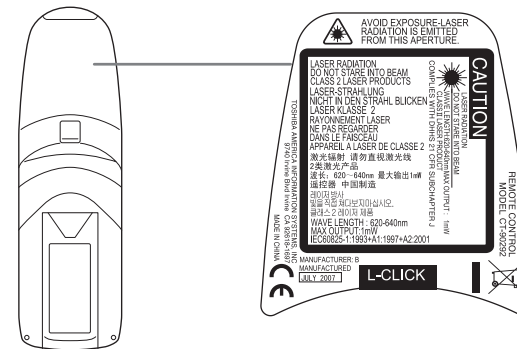

**Caution** – use of controls or adjustments or performance of procedures other than those specified herein may result in hazardous radiation exposure.

## Names of the terminals on the rear panel

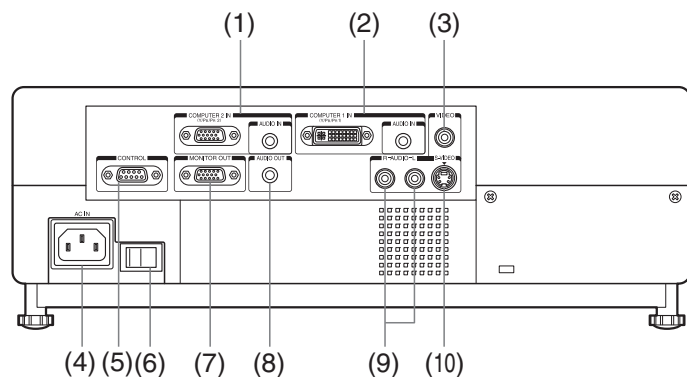

Name	Main Function
(1) COMPUTER (Y/P <sub>B</sub> /P <sub>R</sub> ) 2 IN terminal	: Input analog RGB signal from a computer or other source, or a component video signal (Y/P <sub>B</sub> /P <sub>R</sub> ) from video equipment. AUDIO IN: Input audio signals.
(2) COMPUTER (Y/P <sub>B</sub> /P <sub>R</sub> ) 1 IN terminal	: Input analog or digital RGB signal from a computer, or a component video signal (Y/P <sub>B</sub> /P <sub>R</sub> ) from video equipment. AUDIO IN: Input audio signals.
(3) VIDEO terminal	: Input video signals from video equipment.
(4) AC IN socket	: Connects the supplied power cord here.
(5) CONTROL terminal	: When operating the projector via a computer, connect this to the controlling computer's RS-232C port. <a href="#">p.56</a>
(6) Main power switch	: AC power line ON (standby)/OFF.
(7) MONITOR terminal	: Connect to a computer display, etc.
(8) AUDIO OUT terminal	: Outputs audio signals.
(9) AUDIO (L/R) terminal	: Input audio signals from video equipment. (Dual use for VIDEO and S-VIDEO)
(10) S-VIDEO terminal	: Input S video signals from video equipment.

## Preparing and using the remote control

### ■ Loading dry-cell batteries into the remote control

- 1 Remove the battery cover.

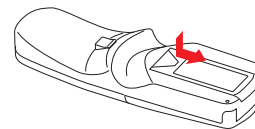

- 2 Insert the dry-cell batteries.

Be sure to align the plus and minus ends of the batteries properly.

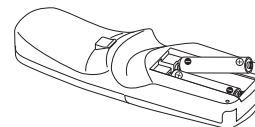

Two batteries (LR03, SIZE AAA) are used.

- 3 Replace the battery cover.

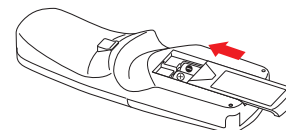

### ■ Operating the remote control

Point toward the projector's infrared remote sensor, and press any button on the remote control.

- Operating the projector from the front

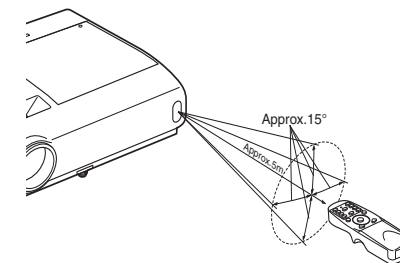

When operating the remote control from behind the projector, the infrared signal is reflected on the projecting surface and may travel a shorter distance to reach the projector depending on the shape and material of the projecting surface.

### ■ Dry-cell batteries

- Before using the batteries, be sure to observe the Safety Precautions described in previous pages.
- Remove batteries from remote control when not using for extended periods.
- If the remote control stops working, or if its range decreases, replace all the batteries with new ones.
- Keep the batteries away from the reach of children.  
Batteries are choking hazards and can be very dangerous if swallowed. If the batteries are swallowed, seek medical assistance immediately.

### ■ The remote control

- The remote control may fail to operate if the infrared remote sensor is exposed to bright sunlight or fluorescent lighting.
- Do not drop or bang.
- Do not leave in hot or humid locations.
- Do not allow it to get wet or place it on top of wet objects.
- Do not take apart.
- In rare cases, ambient conditions could impede the operation of the remote control. If this happens, point the remote control at the main unit again, and repeat the operation.

# Operating a computer using the remote control

A computer can be operated using the projector's remote control. This function is available on any computer with the Windows® 98/98SE, Windows® Me, Windows® 2000, Windows® XP, or Windows Vista® OS, that is equipped with a USB port which can support USB1.1 (The mouse remote control receiver is also supported on OS 9 or OS X for the Macintosh). However, please note that Toshiba does not guarantee the operation of all computers.

## 1 Connecting a computer

Connect the mouse remote control receiver (supplied) to a computer.

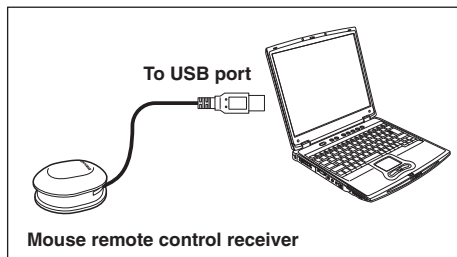

**The remote control may fail to operate if the mouse remote control receiver is exposed to bright sunlight or fluorescent lighting. In such a case, change position or direction of the mouse remote control receiver and retry.**

## 2 Operating a computer

Operate remote control's buttons towards the mouse remote control receiver.

### ● Moving the mouse pointer

Press the mouse control button in the direction you wish the mouse pointer to move, then press.

### ● To left click

Press the L-CLICK button.

### ● To right click

Press the R-CLICK button.

### ● To drag and drop

Holding down the L-CLICK button, move the mouse control button until the mouse pointer is over the desired location, then release the L-CLICK button.

### ● Using the computer's page up [↑] and down [↓] function

Press the PAGE+ and PAGE- buttons to switch PowerPoint® slides.

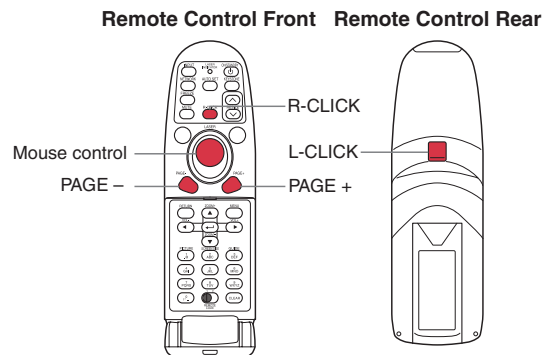

# Placement

## Placement Styles

As shown in the figures below, this device can be placed in 4 different styles. The factory setting is "floor-mounted front projection." Set the [Projection mode] in the **Default setting 2** menu [p.42](#), in accordance with your needs.

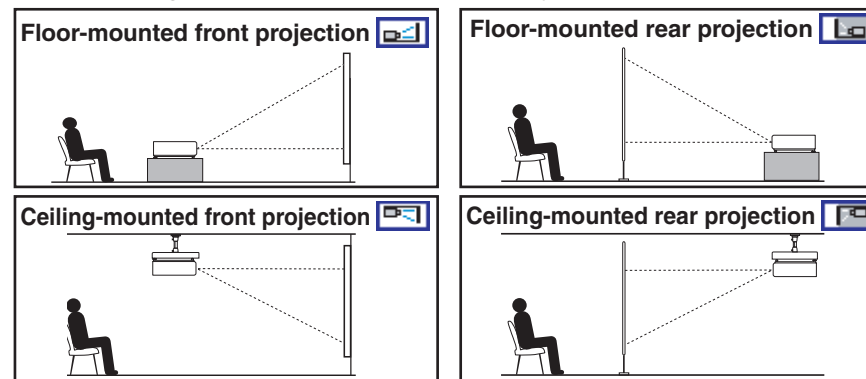

## ⚠ WARNING

- **Always obey the instructions listed in IMPORTANT SAFETY INSTRUCTIONS when placing the unit.** Attempting to clean and replace the lamp in a high location by yourself may cause you to fall, resulting in injury.
- **If you wish to mount the projector on the ceiling, be sure to ask your dealer to do so.** Mounting the projector on a ceiling requires special ceiling brackets (sold separately) and specialized knowledge. Improper mounting could cause the projector to fall, resulting in an accident.
- **If the projector is ceiling-mounted, install the breaker for turning off the power in case of anomaly.** Let everyone involved with the use of the projector know that fact.

## Projection Distance and Size

Use the figures, tables, and formulas below to determine the projection size and projection distance. (Projection sizes are approximate values for full-size picture with no keystone adjustment.)

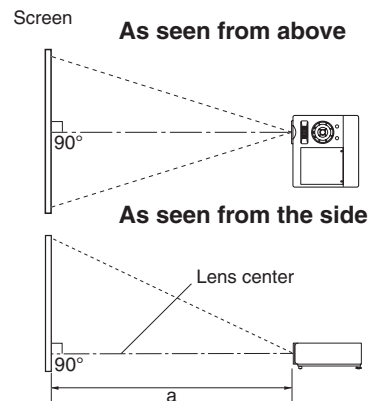

$a$  (min length) = 0.0335 x Projection size (inches) - 0.05  
 $a$  (max length) = 0.0402 x Projection size (inches) - 0.0488

Projection size	Projection distance $a$	
	min length (zooming max)	max length (zooming min)
40 inches	1.29 m (4.23 ft.)	1.56 m (5.12 ft.)
60 inches	1.96 m (6.43 ft.)	2.36 m (7.74 ft.)
80 inches	2.63 m (8.63 ft.)	3.17 m (10.40 ft.)
100 inches	3.30 m (10.83 ft.)	3.97 m (13.02 ft.)
150 inches	4.98 m (16.34 ft.)	5.98 m (19.62 ft.)
200 inches	6.65 m (21.82 ft.)	7.99 m (26.21 ft.)
250 inches	8.33 m (27.33 ft.)	10.00 m (32.81 ft.)
300 inches	10.00 m (32.81 ft.)	12.01 m (39.40 ft.)

$a$  is the distance (m feet) between the lens and the screen, and corresponds to a range of 1.29 m (4.23 ft.) to 12.01 m (39.40 ft.). The lens center is in the same level with an image bottom.

# Connection

## Before connection

- Read the owner's manual of the device you are connecting to the projector.
- Some computers cannot be used with or connected to this projector. Check for an RGB output terminal, supported signal [p.53](#), etc.
- Turn off the power of both devices before connecting.
- The figure below shows sample connections. This does not mean that all of these devices can or must be connected simultaneously.

### Connecting with computers

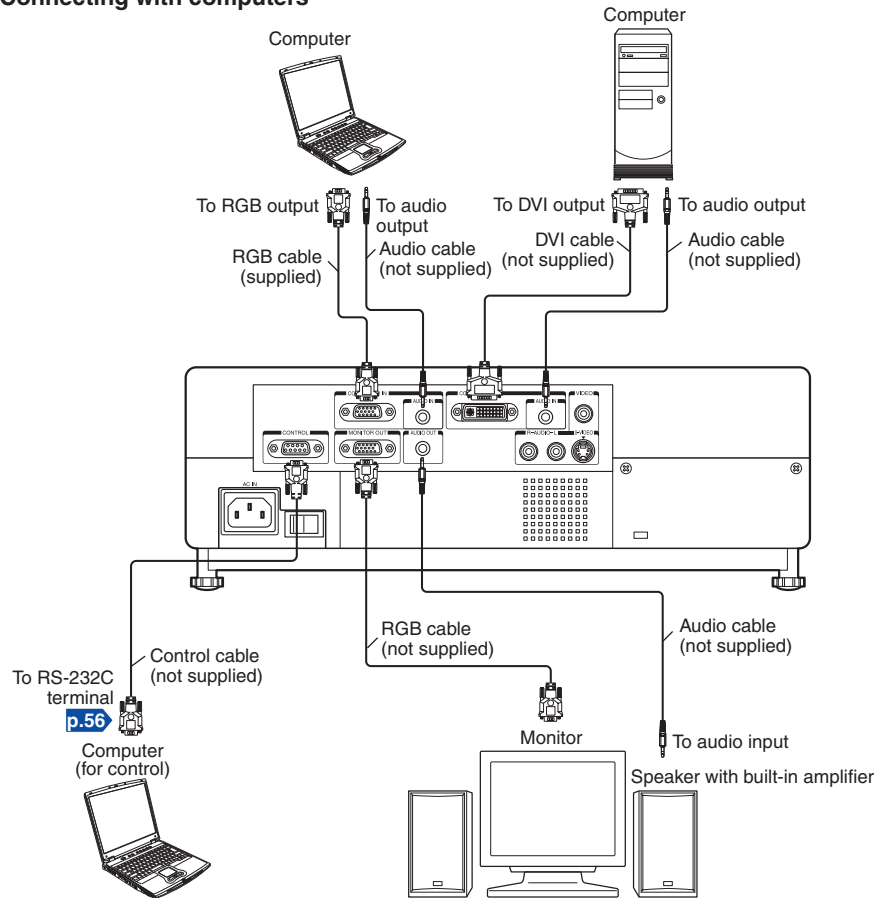

### Notes

- The MONITOR OUT terminal outputs analog RGB signals from the COMPUTER 1 IN terminal or the COMPUTER 2 IN terminal, or outputs Y/P<sub>B</sub>/P<sub>R</sub> signals as selected with the INPUT button. If no input is selected, the MONITOR OUT terminal outputs the input signals last selected for each input terminal. (Digital RGB signals will not be output.)
- Signals are output from MONITOR OUT terminal even in standby mode. However, from AUDIO OUT terminal, no audio signal is output.
- A computer monitor cannot accept Y/P<sub>B</sub>/P<sub>R</sub> signals correctly.

### Connecting with AV equipments

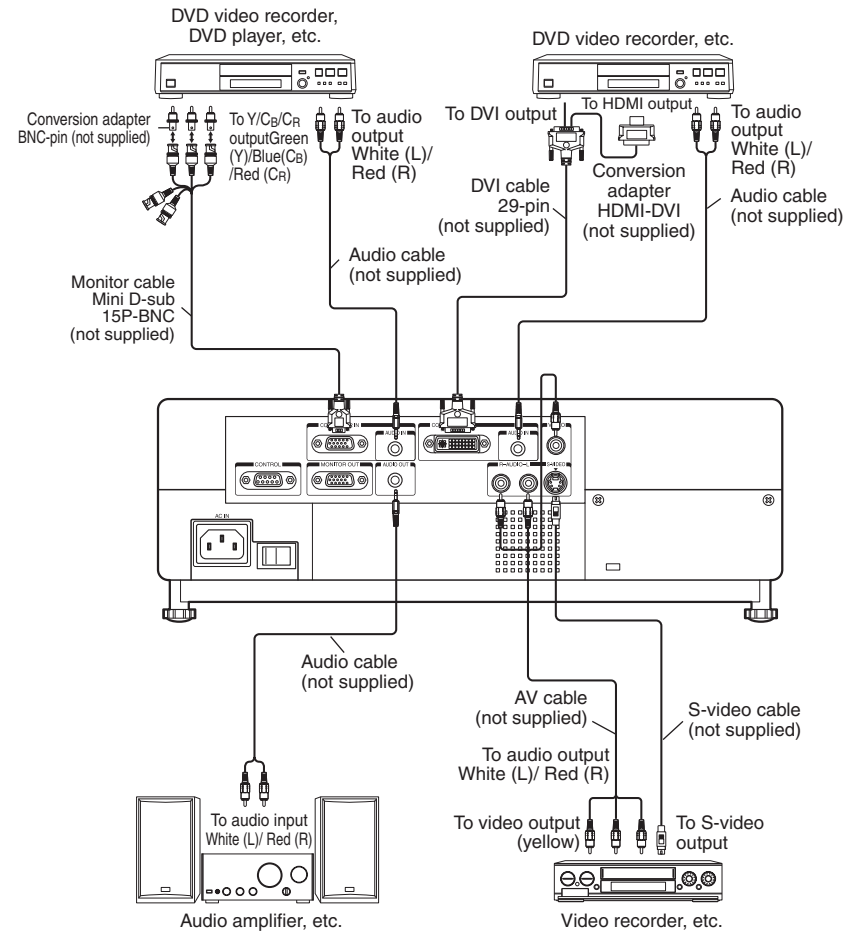

### Notes

- The AUDIO (L/R) terminal doubles for devices connected to S-VIDEO terminal and VIDEO terminal.
- When an AUDIO OUT terminal is connected, sound is not output from the projector speaker.
- Output volume of AUDIO OUT terminal can be adjusted by the **VOL** button.

# Turning the power on and off

## ■ Connecting the power cord

- 1 Insert the power cord connector into the AC IN socket of the projector.
- 2 Insert the power cord plug into a wall or other power outlet.

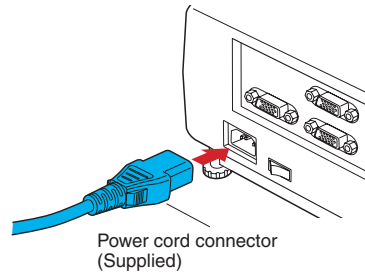

## ■ Removing the lens cap

Be sure to remove the lens cap when the power is turned on. If the cap is left on the projector, it could become deformed due to heat.

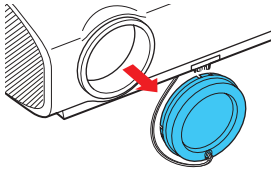

## ■ Turning the power on

- 1 Turn on the main power switch.

The ON/STANDBY indicator will change to orange, indicating standby mode.

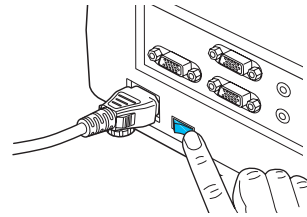

- 2 Press the ON/STANDBY button.

The power turns on with a beep sound (if the beep sound is set to [On]), and the ON/STANDBY indicator lights green. After a moment, the start-up screen appears.

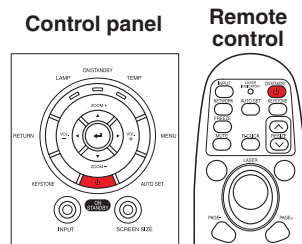

## ⚠ CAUTION

- Do not look into the lens while the lamp is on. The strong light from the lamp may cause damage to your eyesight.
- Do not block the air intake or exhaust. Doing so could cause a fire due to internal overheating.
- Do not place your hands, face, or other objects near the air exhaust, the lamp cover or the bottom of the unit. Doing so could result in injury and/or damage the object.

## ■ Notes

- The start-up screen will disappear after a moment. You can dismiss the start-up screen before this by performing any operation. You can also configure the system to prevent the start-up screen from appearing. To do this, use the **Display setting** menu [p.38](#).
- The first time you use the projector after purchase, after the start-up screen disappears, the start menu is displayed [p.26](#).
- You can disable the beep sound in the **Default setting 1** menu [p.41](#).
- When [Key lock] is [On], the operation buttons of the projector do not work [p.43](#).
- When [Password] is [On], enter password then the start-up screen is displayed after the Password entry screen disappears [p.33](#).
- Do not touch the lens directly with your hand. If fingerprints or stains are left on the projection lens surface, they may interfere with the projector's ability to project images on the screen.

## ■ Turning the power off

- 1 Press the ON/STANDBY button.

When the setting of beep sound is [On], the projector beeps, and a message appears on the screen, confirming that you wish to shut off the power. To shut off the power, press the ON/STANDBY button again. If you do not wish to shut off the power, wait for a while without conducting any operations. This message will disappear after a moment. (This operation is no longer valid after the message disappears.)

- 2 Press the ON/STANDBY button again.

When the setting of beep sound is [On], the projector beeps, and the screen disappears, but the internal cooling fan continues to operate. Then, the projector goes into standby mode.

During cooling, the ON/STANDBY indicator flashes. While the indicator is flashing, the power can not be turned back on. There is no problem with unplugging the power cord in this state.

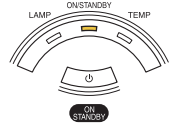

- 3 Turn off the main power switch.

- 4 Replace the lens cap.

After use, replace the lens cap.

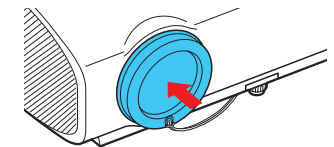

## ■ Note

- The projector consumes about 6 W of power in standby. We recommend that you unplug the power cord if you will not be using the projector for an extended period.

## ■ Precautions

- When you wish to restart the projector again right after turning off the power, give the lamp time (about 5 minutes) to cool before plugging it back in. If the lamp overheats, it may fail to light.
- Right after turning off the power, the unit may become very hot, especially air exhaust, lamp cover or the bottom of the unit. Please handle with care to avoid burn injuries.

# Basic operations

## 1 Turn on the power.

Turn on the power by following the instructions in “Turning the power on” [p.24](#).

## 2 Select the language and the lamp power (When using the first time).

When the projector is used for the first time after purchase, the start menu for language (to display the menus and messages on the screen) and lamp power selection and configuration is displayed in English. (If the screen is out of focus, adjust it according to the step [6](#).)

### 1 Use the **▲**, **▼**, **◀** or **▶** button to select the desired language and press the **⏻** button.

English	English	日本語	Japanese
Français	French	中文(简体字)	Chinese (simplified)
Deutsch	German	中文(繁體字)	Chinese (traditional)
Italiano	Italian	한국어	Korean
Español	Spanish	Indonesia	Indonesian
Português	Portuguese		
Русский	Russian		
Svenska	Swedish		
Türkçe	Turkish		
Polski	Polish		
Norsk	Norwegian		
Suomi	Finnish		
Čeština	Czech		
Magyar	Hungarian		
Ελληνικά	Greek		
Dansk	Danish		
Nederlands	Dutch		
Română	Rumanian		

Message for setup confirmation is displayed in a selected language.

Then, the menu for lamp power selection and configuration is displayed. It is automatically set as Standard. To change the setting, follow the step [2](#).

### 2 Use the **▲** or **▼** button to select the lamp power and press the **⏻** button.

The lamp power, if selected, will be toggled without pressing the **⏻** button. The display automatically disappears in a few seconds.

### Notes

- When the projector is turned on the next time, the start menu does not appear upon startup. However, if [Reset all] is executed from the **Default setting 2** menu [p.42](#), the start menu will be displayed the next time when the power is turned on.
- The language can also be set via the **Display setting** menu [p.38](#) and Lamp power via the **Default setting 2** menu [p.42](#).
- This owner's manual assumes that English has been selected.

## 3 Activate the connected device.

Turn on and start the connected device such as a computer.

## 4 Press the INPUT button.

An image of the connected equipment is projected.

Each time you press the **INPUT** button, it switches to the input of the connected equipment that is outputting video signals.

### Notes

- When [Auto input search] is set to [Off] in the **Default setting 1** menu [p.41](#) (factory setting is [On]), the **Input select** menu appears if you press the **INPUT** button.
- If no signal is being output from the connected equipment, pressing the **INPUT** button does not change the input and “There is no other input signal.” message will appear.

## 5 Projector placement angle adjustments

The placement angle and the height of the projected image can be adjusted by the foot adjuster.

### 1 Lift up the front of the projector to the desired angle, then press the foot adjuster release button.

The foot adjuster extends. Release the button to lock the position.

### 2 To fine adjust the angle, twist the foot adjuster.

### 3 To adjust the horizontal angle, use the right and left tilt adjusters.

- To stow the foot adjuster, hold up the projector while pressing the foot adjuster release button, then slowly lower the projector.

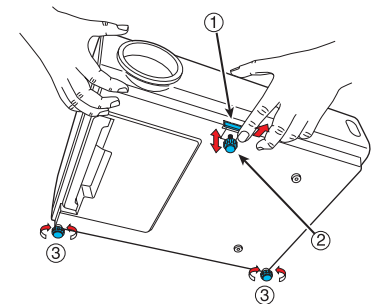

### Note

- When [Auto keystone] is set to [On] in the **Default setting 1** menu, the keystone distortion will automatically be corrected based on the projector placement angle. If you do not desire the automatic keystone correction, set [Auto keystone] to [Off].

## 6 Adjusting the screen size and focus

### 1 Use the zooming ring to adjust the screen size.

### 2 Use the focusing ring to adjust the focus.

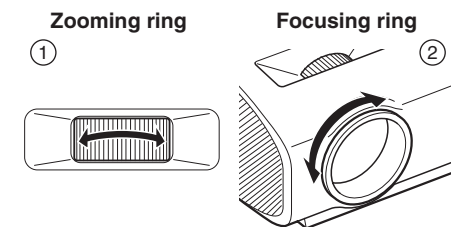

## 7 Adjusting the volume with the **◀** **▶** buttons

The speaker volume can be adjusted when an audio signal is being input.

## Basic operations (Continued)

### ■ Precautions

- Lamp characteristics may rarely cause the brightness to fluctuate slightly.
- The DLP® chip is made using extremely advanced technology. There may be black spots (pixels that do not light) or bright spots (pixels that are constantly lit) on the panel. These are intrinsic characteristics of the technology and are not malfunctions.

### ■ Notes

- A lamp is consumable item. If used for extended periods, images will appear dark, and the lamp could burn out. This is characteristic of a lamp, and is not malfunction. (The lifetime of the lamp depends on conditions of use.)
- Although this projector supports a wide range of RGB signals [p.53](#), any resolutions not supported by this projector (XGA) will be expanded or shrunk, which will affect image quality slightly. To view high-quality images, set the computer's external output to XGA.
- With some models of computer having LCD displays or the like, displaying images simultaneously on the projector and the monitor's display may prevent the images from displaying properly. If this happens, turn off the computer's LCD display. For information on how to turn off the LCD display, see the computer's owner's manual.
- If no signal is being input from the connected equipment or signal input is stopped while projecting, the "No signal" message will appear.
- If a signal not supported by the projector is input, the "Unsupported signal" message will appear.
- If an unavailable operation button is pressed, the  icon will appear with a beep sound (if the beep sound is set to [On]).
- Moving pictures played back on computers using DVD software may appear unnatural when projected with this projector. However, it is not a malfunction of the projector.

## Using handy features

### ■ Using auto setting (For computer input only)

This function automatically sets up the projector to the optimum state. It sets up sampling phase, frequency and screen position, for each type of the input signal by using simple operations.

#### ● Press the remote control's AUTO SET button.

The  icon will appear during processing.

#### ■ Notes

- The image may not be projected or auto adjustment/setting may not be performed correctly for input signals other than those supported by the projector [p.53](#), [p.54](#).
- If auto setting fails adjustment, adjust manually with the **Position adjustment** menu [p.37](#).

Remote control

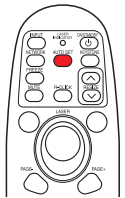

### ■ Correcting the keystone distortion

When the projector placement angle against the screen is changed while projecting the image, the picture will undergo keystone (trapezoidal) distortion. This projector is capable of correcting this keystone distortion.

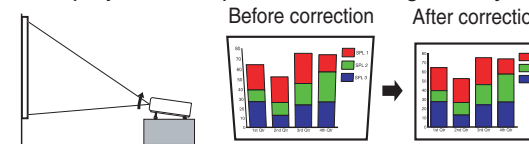

- The keystone distortion will be corrected automatically based on the projector's placement angle.

### Adjusting Keystone distortion [Manual]

#### ① Press the KEYSTONE button.

#### ② Use the buttons for keystone adjustment.

#### ■ Notes

- Depending on the amount of keystone adjustment and the content of images, some information may be lost, or the picture quality may suffer.
- Even if [Auto keystone] is set to [On], keystone distortion can be adjusted manually. Note that if you change the position or angle of the projector, automatic keystone correction will be performed again.
- When [Auto keystone] is set to [On], the automatic keystone correction will be performed each time the power is turned on.
- The keystone correction settings are memorized after the power has been turned off. Therefore, it is recommended that you set [Auto keystone] to [Off], if the case is that the projector placement angle against the screen remains unchanged and you do not wish to change the keystone adjustment that you set.
- Some adjustments using both digital zoom and keystone correction while displaying an input image with a 16:9 aspect ratio, may affect displaying the menu properly. In such a case, reset either digital zoom or keystone correction to use the menu.

Control panel

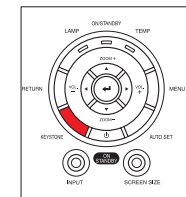

Remote control

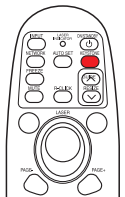



## Using handy features (Continued)

### ■ Zooming out the images

This projector is provided with the digital zoom (electric zoom: 100 - 62%) in addition to the optical zoom (manual adjustment with zooming ring). (Note that the display, if digitally zoomed out, may suffer from some degradation.)

#### ① Press the ZOOM – button.

Each time the ZOOM – button is pressed, the image is reduced in size.

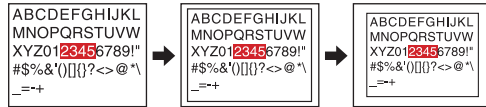

#### ② Press ZOOM + button to bring it back to the original size.

Each time the ZOOM + button is pressed, the image size increases.

(You cannot make it larger than the original size.)

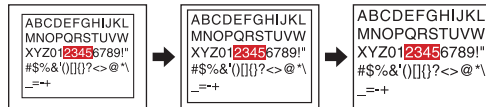

#### ■ Notes

- Pressing either ZOOM – or ZOOM + button will display an adjustment bar.
- The adjustment value will automatically be saved.

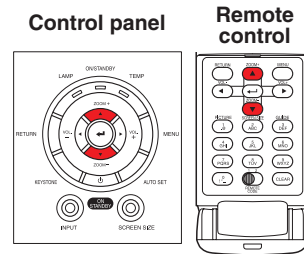

### ■ Resizing image

The projected image can be resized (zoomed in/out).

#### ① Press the remote control's RESIZE button.

Each time you press the RESIZE button, zoom ratio is up. You can keep pressing.

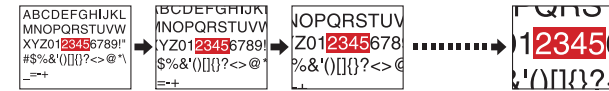

#### ② To zoom out, press the remote control's RESIZE button.

Each time you press the RESIZE button, zoom ratio is down. You can keep pressing. (However, the image cannot be smaller than the original size.)

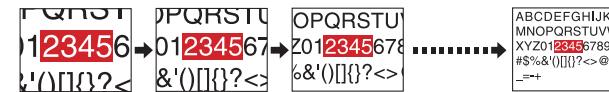

#### ③ To move the area to zoom in, use the buttons.

You can keep pressing.



#### ④ When the image returns to the original size by pressing RESIZE button several times, the zoom will be reset.

Pressing the RETURN button during resizing also resets the zoom.

#### ■ Notes

- The icon appears while resizing.
- Operating a function other than Mute will release resizing.
- As zooming is processed digitally, the image quality is degraded in larger zoom ratio.
- During resizing or moving the zooming area, the image may be distorted.

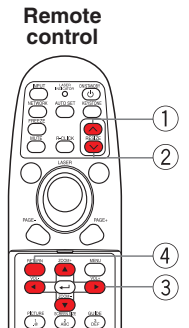

## Using handy features (Continued)

### ■ Cutting off the picture and sound temporarily (Mute)

When you want to project the images of another projector, overhead projector, etc. temporarily, this projector's images and sound can be turned off.

#### ● Press the remote control's MUTE button.

The picture and sound are cut off. (The Mute function is released when pressing the MUTE button again.)

#### ■ Notes

- The  icon will appear while mute is in effect.
- Operating any other functions will also cancel the muting.

Remote control



### ■ Changing picture mode

The projected image mode can be selected.

#### ● Press the remote control's PICTURE button.

Pressing the button switches **Bright/Standard/True color** in turn.

#### ■ Note

- [Picture mode] of the **Image adjustment** menu has the same function [p.36](#).

Remote control

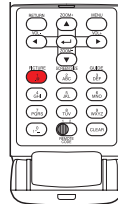

### ■ Changing screen size

The screen size for the projected image can be changed.

#### ● Press the SCREEN SIZE button.

Pressing the button switches Normal/Full/Thru/Wide in turn.

#### ■ Notes

- Thru display is available for Computer-input images.
- Wide display is available for Y/PB/PR, Video and S-video-input images.
- [Screen size] of the **Display setting** menu has the same function [p.38](#).
- If you use this function on commercial video software, broadcast or cable-broadcasting except for the purpose of your private viewing and listening, it may infringe the copyright protected by the copyright laws.

Control panel

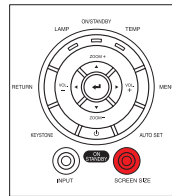

Remote control



### ■ Freezing the image (Freeze)

The projected image can be frozen. This function is to be used to pause a video during a presentation, etc.

#### ● Press the remote control's FREEZE button.

The picture pauses. (The Freeze function is released by pressing the FREEZE button again.)

#### ■ Notes

- The  icon will appear while freeze is in effect.
- Other operations will also release the freeze.
- Even if an image is frozen on the projector, the pictures are running on the video or other equipment.
- If you use this function on commercial video software, broadcast or cable-broadcasting except for the purpose of your private viewing and listening, it may infringe the copyright protected by the copyright laws.

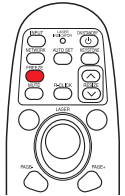

Remote control



### ■ Setting the password

#### ● How to change password

The default password is 000000.

- 1 Select [Password] in the Default setting 2 menu and press the  or  button.
- 2 Select [Password registration] in the password registration, setting menu, and press the  button.  
The password entry screen is displayed.
- 3 Enter the current password (6-digit number) using numeric keys of the remote control.
  - Enter [000000] (6 zeros) for the first change.
  - The password is not displayed. Instead it appears as [\*\*\*\*\*].
- 4 Enter a new password (6-digit number).
- 5 Re-enter the same password for confirmation.

#### ■ Note

- Please do not forget your password. If you forget the password, you can not release the password by yourself.  
In such a case, please inquire your dealer.

## Using handy features (Continued)

### ● How to set password (from [Off] to [On])

- 1 Select [Password] in the Default setting 2 menu and press the or button.
- 2 Select [Password setting] next, and press the or button.
- 3 Select [On].
- 4 Select [OK] and press the button.  
The password entry screen is displayed.
- 5 Enter the password using numeric keys of the remote control.

### ● The password setting will be set as [On].

### ● How to operate when password is [On]

- 1 Turn on the power.
- 2 The lamp lights and the password entry screen appears.
- 3 Enter the password using numeric keys of the remote control.  
If the entered password is correct, the start-up screen appears and the projector goes into normal operation. If the password is wrong, a message appears to prompt you to re-enter the password, and again the password entry screen is displayed. If you enter a wrong password for more than 5 times, the projector will automatically power off and enter standby mode.

#### ■ Note

- When the password setting is [On], the password function will be enabled only when the projector is restarted after the main power switch has been turned off. The password that you set will not be enabled when restarting from standby mode without turning off the main power switch.

### ● How to set password (from [On] to [Off])

- 1 Select [Password] in the Default setting 2 menu and press the or button.  
The password entry screen is displayed.
- 2 Enter the password using numeric keys of the remote control.
- 3 Select [Password setting] next, and press the or button.
- 4 Select [OFF].
- 5 Select [OK] and press the button.

## Using the menus

You can call up on-screen menus, and conduct a number of adjustments and settings using the **MENU** button [p.16](#) on the control panel (main unit side) and remote control.

### ■ Setup using the Setting display

The menu shown below is for operation instructions purposes and might differ from the actual display.

1. Press the **MENU** button Display the **Setting display** menu.
2. Select a Category

Select a category by using .

There are following 6 categories:

- Image adjustment menu** [p.36](#)
- Position adjustment menu** [p.37](#)
- Display setting menu** [p.38](#)
- Default setting 1 menu** [p.41](#)
- Default setting 2 menu** [p.42](#)
- Status display menu** [p.43](#)

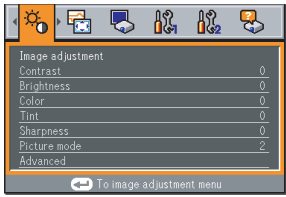

Displays the current adjustments and settings of selected category.  
Item shown with gray cannot be adjusted with the current input source.

3. Adjustments & Settings Press or to open the menu.

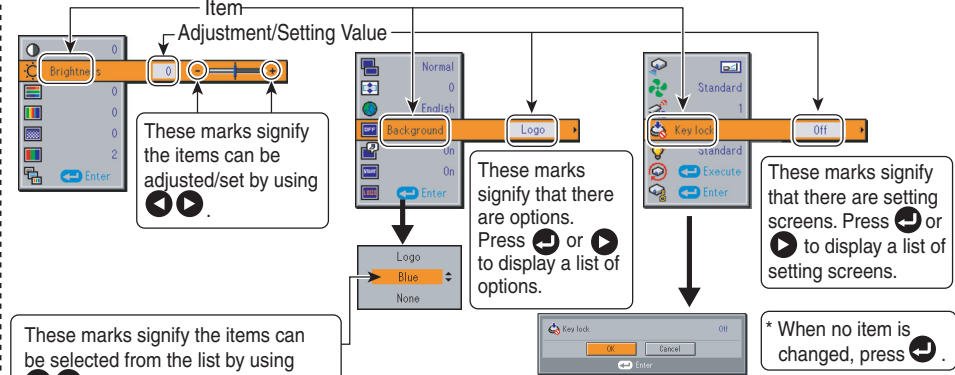

Item

Adjustment/Setting Value

These marks signify the items can be selected from the list by using .

After an item is selected, apply it by pressing .

These marks signify that there are options. Press or to display a list of options.

These marks signify that there are setting screens. Press or to display a list of setting screens.

\* When no item is changed, press .

Toggle items with .

Select items with and press .

Fix selection with .

These marks signify the items can be adjusted/set by using .

These marks signify that there are options. Press or to display a list of options.

These marks signify that there are setting screens. Press or to display a list of setting screens.

\* When no item is changed, press .

Toggle items with .

Select items with and press .

Fix selection with .

The figure shows displays given for operation instructions purposes. As the display may differ depending on the item, refer to the following applicable pages for the menu item you desire.

To return to previous item, press the RETURN button.

4. End Press the **MENU** button once more.

(The menu will disappear automatically after 30 seconds, if no operation is conducted.)

## Using the menu (Continued)

### ■ The image adjustment menu

Use this menu to set or adjust image-related items. Items that can be set or adjusted are marked "Yes", and those that cannot are marked "No". (When an item is masked, it indicates that you cannot select for the current input.)

Item ▲ ▼	Description	Digital		Analog		Video	S-video	
		RGB	Y/Pb/Pr	RGB	Y/Pb/Pr			
<b>Contrast</b>	Adjust the image contrast. Lower ◀ ▶ Higher	Yes	Yes	Yes	Yes	Yes	Yes	
<b>Brightness</b>	Adjust the brightness of the image. Darker ◀ ▶ Brighter	Yes	Yes	Yes	Yes	Yes	Yes	
<b>Color</b>	Adjust the color of the image. Lighter ◀ ▶ Deeper	No	Yes	No	Yes	Yes	Yes	
<b>Tint</b> <sup>*1</sup>	Adjust the tint of the image color. Reddish ◀ ▶ Greenish	No	No	No	No	Yes	Yes	
<b>Sharpness</b>	Adjust the sharpness of the image. Softer ◀ ▶ Sharper	No	Yes	No	Yes	Yes	Yes	
<b>Picture mode</b>	Press . Toggle the picture mode with ▲ ▼. Bright/Standard/True color	Yes	Yes	Yes	Yes	Yes	Yes	
<b>Advanced adjustment</b> Press  to enter the advanced adjustment	<b>Noise reduction</b> <sup>*2</sup>	Yes	Yes	Yes	Yes	Yes	Yes	
	<b>R-level</b>	Yes	Yes	Yes	Yes	Yes	Yes	
	<b>G-level</b>	Yes	Yes	Yes	Yes	Yes	Yes	
	<b>B-level</b>	Yes	Yes	Yes	Yes	Yes	Yes	
	<b>NTSC mode</b> <sup>*3</sup>	Set the black level with ◀ ▶. US : NTSC (US) mode JAPAN : NTSC (JAPAN) mode	No	No	No	No	Yes	Yes
	<b>DVI mode</b> <sup>*4</sup>	Set the connecting device with ◀ ▶. PC : connect to PC AV equipment : connect to AV equipment (DVD player)	Yes	Yes	No	No	No	No

\*1: [Tint] can be displayed and adjusted only when the video signal is set to [NTSC] or [NTSC4.43].

\*2: [Noise reduction] may not work depending on signal type.

\*3: [NTSC mode] can be displayed and adjusted only when the video signal is set to [NTSC] or [NTSC4.43]. NTSC mode is set to JAPAN when the language is set to Japanese. It is set to US for other languages.

\*4: If the output settings of the connected device are incorrectly set, black and dark areas of the picture may not be displayed properly.

### ■ The position adjustment menu

Use this menu to set or adjust picture position-related items. Items that can be set or adjusted are marked "Yes", and those that cannot are marked "No". (When an item is masked, it indicates that you cannot select for the current input.)































Item ▲ ▼	Description	Digital		Analog		Video	S-video
		RGB	Y/Pb/Pr	RGB	Y/Pb/Pr		
<b>Phase</b>	Adjust to eliminate flicker with ◀ ▶	No	No	Yes	No	No	No
<b>Frequency</b>	Adjust with ◀ ▶ to eliminate periodic patterns and flickering when fine vertical lines appear on the screen.	No	No	Yes	No	No	No
<b>H-position</b>	Adjust the horizontal position of the image. Move left ◀ ▶ Move right	No	No	Yes	No	No	No
<b>V-position</b>	Adjust the vertical position of the image. Move down ◀ ▶ Move up	No	No	Yes	No	No	No
<b>Clamp pulse 1</b>	Adjust the clamp pulse position. Lower ◀ ▶ Higher	No	No	Yes	No	No	No
<b>Clamp pulse 2</b>	Adjust the clamp pulse width. Narrower ◀ ▶ Wider	No	No	Yes	No	No	No

## Using the menu (Continued)

### ■ The display setting menu

Use this menu to set screen display-related items.

(The items in gray color cannot be set with the current input selection.)

Item ▲ ▼	Description
 <b>Screen size</b>	Screen size setting [Enter:  or  : Enter setting] → [▲ ▼: Selection] → [Enter:  ] <b>Normal/Full/Thru/Wide</b>
 <b>Up/down shift</b>	Lets the projected images shift vertically when the screen size setting is wide display (within the range of 1024 × 768). Lower the image  Raise the image 
 <b>Language</b>	Select one of the languages below to use for displaying the menu and messages [Enter:  or  : Enter setting] → [▲ ▼ ◀ ▶: Selection] → [Enter:  ] English / Français / Deutsch / Italiano / Español / Português / Русский / Svenska / Türkçe / Polski / Norsk / Suomi / Čeština / Magyar / Ελληνικά / Dansk / Nederlands / Română / 日本語 / 中文(简体字) / 中文(繁體字) / 한국어 / Indonesia
 <b>Background</b>	Screen to display when there is no input signal [Enter:  or  : Enter setting] → [▲ ▼: Selection] → [Enter:  ] <b>Logo/Blue/None</b>
 <b>Icon</b>	Display icons as function guides <span style="float: right;">On  Off</span>
 <b>Start-up screen</b>	Display start-up screen when power is turned on <span style="float: right;">On  Off</span>
 <b>User logo</b>	Display a logo customized by the user for the start-up screen or when there is no input signal. [Enter:  or  : Enter setting] → [▲ ▼: Selection]
 <b>Logo registration</b>	Press  to display the registration menu.
 <b>Display style</b>	
 <b>Logo confirmation</b>	Press  .
 <b>Reset logo</b>	Yes  No

### ● Detailed description

#### [Screen size]

- **Normal** : Enlarge an input image to fit the screen without changing the aspect ratio of video signals.
- **Full** : Displays an input image in 1024 × 768 dot resolution by enlarging it to fill the entire screen.
- **Thru** : Displays an input image in the native resolution of the video signals. Thru display is not available for Y/Pb/Pr, Video and S-Video-input images. The larger image than the screen size will be displayed over the screen. The input image may appear vertically long with some frequencies of video signals.
- **Wide** : Displays an input image in the center of the screen with a 16:9 aspect ratio by enlarging it to fit the width of the screen. The upper and lower portions of the image will be compressed. Wide display is not available for Computer-input images.
- For Y/Pb/Pr input, screen size setting function is not available for the video signals with a 16:9 aspect ratio.

#### ■ Note

- If you use the screen size setting function on commercial video software, broadcast or cable-broadcasting programs to display images with the varying aspect ratio except for the purpose of your private viewing and listening, it may infringe the copyright protected by the copyright laws.

#### [Up/down shift]

Shifts the projected image vertically when [Screen size] is [Wide].

#### [Background]

- TOSHIBA is set for [Logo] by factory setting.
- If user's logo has been registered, it is displayed when [Logo] is set for background.

#### [Start-up screen]

If user's logo has been registered and this setting is [On], the logo is displayed at start-up.

#### [User logo]

Registers a part of the image that is input from computer, as a stationary picture and displays it as a logo at start-up and when no signal is input.

## Using the menu (Continued)

### <Logo registration>

#### ● How to register user logo

- 1 Project a picture to register.
- 2 Select [User logo] in the Display setting menu, and press the or button.
- 3 Select <Logo registration> from the displayed menu list and press the button.
- 4 The registration area is displayed for confirmation. Select [OK] and press the button.
  - If the registered picture does not fall within the display area, operate the computer to scroll the screen.
- 5 Registration starts.
  - A message will appear after the registration has been completed.
  - To stop the registration, press the **RETURN** button.

#### ■ Notes

- You can register a logo when the input is set to Computer.
- If you register a logo after keystone distortion or digital zoom has been adjusted, those adjustments will be reset to their factory settings. However, once the logo registration is complete, they will return to the adjustments that you made.
- The area that can be registered is 512 × 384 dots at the center of the screen. To register a company logo, prepare the image within the limit.
- Only one logo can be registered. When a new image is registered, the old one is erased.
- The time needed to register or display the image varies depending on the data size.
- If you use this function on commercial video software, broadcast or cable-broadcasting except for the purpose of your private viewing and listening, it may infringe the copyright protected by the copyright laws.

### <Display style>

Select the size of the registered logo.

- : Displays the registered image in original size at center of the screen.
- : Displays the registered image by enlarging fully in the screen.  
(As processed digitally, the image quality is degraded.)

### <Logo confirmation>

You can preview the registered logo.

### <Reset logo>

You can reset the registered logo and display style to the factory setting. (The logo set for the start-up screen and background is reset.)

## ■ The Default setting menu

This menu shows placement status and other settings.

### Default setting 1 menu

Item	Description
<b>Keystone</b>	Screen shrinking at bottom   Screen shrinking at top
<b>Auto keystone</b>	Always correct keystone distortion automatically. On   Off
<b>Blackboard mode</b>	When projecting on a non-screen surface, select a color in accordance with the projecting surface. Press  and switch with  and . Off/Green/Black/Brown/Blue/Beige
<b>No signal power off</b>	Set the time to wait for the power to be turned off after the last operation is made with no input signal. On (not turned off)   30 min.
<b>Auto input search</b>	Set whether the input with signals is only selected or not. On   Off
<b>Beep</b>	Beep when operation is made. On   Off
<b>Power on</b>	Sets whether to turn on the power when the <b>ON/STANDBY</b> button is pressed (Manual), or when the main power switch is turned on (Auto). Manual   Auto

#### ● Detailed description

##### [Blackboard mode]

Projects the image in colors more like projecting on a screen.

##### ■ Precaution

- The projected image may differ depending on the type, color, and material of the blackboard and wall even if the selected color is the same as the projected screen.

##### [Auto input search]

[On]: Automatically searches the signals that can be projected, and switches input from the connected device that outputs the video signals each time the **INPUT** button is pressed. The input from the connected device that outputs no video signals is skipped.

[Off]: Displays the **Input select** menu.

Toggle with buttons and press button.  
(The input without signals can be also selected.)

##### Input select menu

Input select
<input checked="" type="radio"/> Computer 1 (Digital) └ Y/Pb/Pr 1 (Digital)
<input type="radio"/> Computer 1 (Analog)
<input type="radio"/> Y/Pb/Pr 1 (Analog)
<input checked="" type="radio"/> Computer 2
<input type="radio"/> Y/Pb/Pr 2
<input checked="" type="radio"/> Video
<input type="radio"/> S-video

●/○ shows whether signal is input or not.

##### ■ Notes

- In normal operation, set [Auto input search] to [On].  
Set to [Off] when you want to select the input source from Input select menu, or if the image does not appear properly.

##### [Power on]

If [Power on] is set to [Auto] and there is a power outage, the projector will come on once power is restored.

# Using the menus (Continued)

## Default setting 2 menu

Item ▲ ▼	Description
<b>Projection mode</b>	Sets projection mode in accordance with Placement Style. <a href="#">p.21</a> (Standard)  (Rear)  (Ceiling)  (Rear ceiling)
<b>Fan mode</b>	Sets the cooling fan speed. <b>Standard</b> <b>High</b>
<b>Remote control</b>	When 2 projectors are used and controlled by the remote control respectively, this menu sets the code for the projector and the remote control. [Left arrow] or [Right arrow]: Enter setting] → [Left arrow] or [Right arrow]: Select from 1, 2] → [Enter]: Confirm] → [Enter]: Select OK to end] Press [Cancel] to return.
<b>Key lock</b>	Lock the control panel buttons. [Left arrow] or [Right arrow]: Enter setting] → [Left arrow] or [Right arrow]: Select On/Off] → [Enter]: Confirm] → [Enter]: Select OK to end] Press [Cancel] to return.
<b>Lamp power</b>	Set the lamp power. <b>Low</b> <b>Standard</b>
<b>Reset all</b>	Press [Enter]. (The password and user logo are not reset.) Resets all adjustments and settings to their factory settings. <b>Yes</b> <b>No</b>
<b>Password</b>	Password setting <a href="#">p.33</a> Press [Enter] → Password registration/Password setting

### ● Detailed description

#### [Fan mode]

Setting [Fan mode] to [High] increases the cooling fan speed. (The cooling fan noise gets louder.) Set this option to use the projector, for example, at high altitude (over 1,500 meters above sea level).

- Do not set Fan mode to [High] when using the projector at a lower altitude.

#### [Remote control]

Sets a remote control code from 2 types. You can set each code respectively for up to 2 projectors. The factory setting is [1].

To switch codes, set the same code for the projector and the remote control.

A remote control code is applied after the setting is done.

- You cannot operate the remote control if the codes of the projector and the remote control do not match.

#### Remote control code setting for remote control

Set the same **remote control code switch** as the projector. [p.16](#) [p.17](#)



#### [Key lock]

Protect from operating errors by locking on the control panel buttons of the projector. (The remote control operations are available.)

Control panel operations are locked after the setting is done, and accordingly operation with the control panel buttons is disabled.

- To release the key lock, set the [Key lock] to [Off] using remote control. Pressing the [RETURN] button on the projector for 10 seconds also sets the [Key lock] to [Off]. (When operating the main unit, the 2 indicators of LAMP and TEMP light orange for 3 seconds, and at the same time the projector beeps.)

#### [Lamp power]

When [Lamp power] is set to [Low], the screen becomes a little darker, but the cooling fan noise gets quieter.

### ■ Displaying Information (Status display)

This displays information about the input signal, lamp use time, etc.

"Yes": displayed, "No": not displayed

Item	Description	Digital		Analog		Video	S-video
		RGB	Y/Pb/Pr	RGB	Y/Pb/Pr		
Input	Input source name	Yes	Yes	Yes	Yes	Yes	Yes
Mode name	RGB input mode <sup>[Note 1]</sup>	Yes	No	Yes	No	No	No
Resolution	Resolution (in dots)	Yes	No	Yes	No	No	No
Frequency	Sync frequency	Yes	No	Yes	No	No	No
Sync	Sync signal polarity <sup>[Note 2]</sup>	Yes	No	Yes	No	No	No
Signal format	Y/Pb/Pr signal format	No	Yes	No	Yes	No	No
Video mode	Color method of video signal	No	No	No	No	Yes	Yes
Lamp time	Time of lamp use <sup>[Note 3]</sup>	Yes	Yes	Yes	Yes	Yes	Yes
Lamp reset count	The count for lamp replacement	Yes	Yes	Yes	Yes	Yes	Yes
Total time	The total time that this projector is used.	Yes	Yes	Yes	Yes	Yes	Yes
Version	Firmware version <sup>[Note 4]</sup>	Yes	Yes	Yes	Yes	Yes	Yes

#### Notes

- The mode of supported RGB signals [p.53](#) is shown.
- Sync signal polarity shown as P (positive) or N (negative) for [H/V].
- Displays [Lamp time] as a measure of when the lamp should be replaced. (Cannot be used as a counter of guaranteed lamp time.) When the displayed time approaches 2,000 hours, consult with a dealer about getting replacement for: TLPLW23 (sold separately).
- [Version] shows the version of the projector's internal control program. This version will be requested for customer service purposes.

#### ■ Note

- The displayed information will not be refreshed if the status changes. To refresh the information, dismiss the display, then display it again.

## About lamp

The product's light source is a mercury lamp that lights at increased internal pressure. Be sure to fully understand the following characteristics of the lamp and handle it with extreme care.

- The lamp may burst with a loud noise due to impact or deterioration, or fail to light at the expiration of its life.
- How long it takes before the lamp bursts or the life expires may vary greatly by lamp. Some may burst shortly after first use.
- Burst is likely to happen if the lamp is used after the replacement period has elapsed.
- When the lamp bursts, the broken pieces of glass may get inside the product or be released outside from the openings for ventilation.
- When the lamp bursts, a slight amount of mercury gas enclosed in the lamp along with glass dust may be released from the openings for ventilation.

### ■ Immediately replace the lamp when a replacement message appears on the screen.

- When the replacement time approaches, a message will appear on the screen.
- The risk of burst will increase if the lamp is continuously used without being replaced.
- Frequently check the used hours and prepare spares when the replacement time approaches. (Refer to "Status display". [p.43](#))

### ■ When the lamp is broken

- If glass components, including a lamp and a lens, should break, handle the broken pieces with care to avoid injury and contact your dealer for repair service.
- In the event of lamp burst, unplug the product from the wall outlet, leave and completely ventilate the room. Then, thoroughly clean the area around the projector and discard any edible items placed in that area, as they may be contaminated.
- If the lamp bursts, consult a doctor if glass dust or mercury gas gets into your eyes or is inhaled.

## Lamp replacement

A lamp is consumable supplies. If used for extended periods, images will appear dark, and the lamp could burn out. This is characteristic of a lamp, and is not malfunction. (The lifetime of the lamp depends on condition of use.) If this happens, replace it with a new one.

### WARNING

- **If the projector is mounted on the ceiling, it is recommended to use your Toshiba dealership when the lamp has to be exchanged.**  
Uncovering the lamp while the projector is mounted on a ceiling may lead to a danger of damage from falling pieces of glass if the lamp is broken. Besides, working at high elevations can also be hazardous. Do not attempt to replace the lamp by yourself.
- **When replacing, always use lamp "TLPLW23" (sold separately).**  
If the lamp other than the specified one is used, it may cause a malfunction or damage to the unit due to the difference in the connector shape or the lamp rate.

### CAUTION

- **If you have been using the projector, the lamp will be very hot, and may cause burn injuries.**  
Wait for the lamp to cool (for longer than 1 hour) before replacing it.
- **If the lamp should break, please handle with care to avoid injury due to broken pieces and contact your dealer for repair service.**



## Lamp replacement (Continued)

### 1 Unplug power cord.

### 2 Wait until lamp is sufficiently cooled.

Wait for at least 1 hour.

### 3 Remove the outer lamp cover.

Loosen the 2 screws, raise the outer lamp cover with your fingers as shown to remove the outer lamp cover. Use care to avoid any damage to nails and/or tip of your finger(s). If you have any difficulty in removal, you can use a screwdriver or any other smaller tool for your convenience.

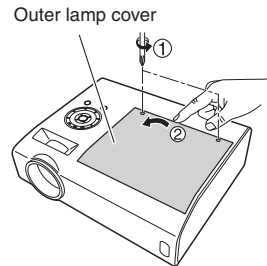

### 4 Remove the inner lamp cover.

Remove the screw and carefully set it aside, and take off the inner lamp cover. Be sure not to lose the screw.

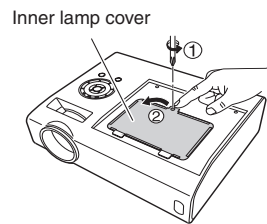

### 5 Pull out the lamp.

Loosen the 3 lamp locking screws, pull up the handle, and press the tab to remove the lamp.

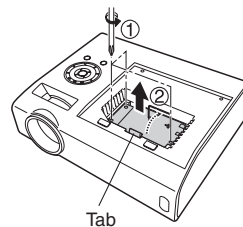

### 6 Mount the new lamp.

Align the orientation, press down the new lamp until the bottom is reached, and lock in place using the 3 lamp locking screws.

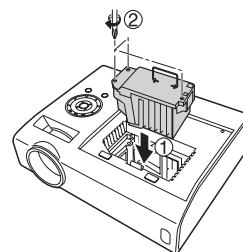

### 7 Replace the inner lamp cover.

Tighten the screw removed in step 4 until the inner lamp cover is no longer loose.

### 8 Replace the outer lamp cover.

Align the cover, and press it in, then tighten the screws loosened in step 3 until the outer lamp cover is no longer loose. (Be sure to replace the outer lamp cover.)

### 9 Reset the lamp time.

See the lamp's manual for instructions on resetting the lamp time.

#### Notes and Precautions

- The [Lamp time] item in the **Status display** menu indicates the time of lamp use (as a rough guide) [p.43](#)
- Please replace the lamp after 2000 hours of use with [Lamp power] in the **Default setting 2** menu set to [Standard], and 3000 hours of use with [Lamp power] in the **Default setting 2** menu set to [Low]. [p.42](#)
- There are cases that the lamp can not work before the above mentioned period expires or before the replacement message is displayed.
- Attach the outer lamp cover correctly so that it is not loose. If it is not attached correctly, the projector may fail to be powered on or the lamp may fail to come on.
- Always replace the lamp with a new one.
- The lamp is made out of glass. Do not touch the glass surface with your bare hands, bang it, or scratch it. (Dirt, jolts, scratches and the like could break the lamp.)

#### About lamp replacement messages

- The lamp replacement message of this projector displays an appropriate period according to the use period for [Standard] / [Low] of the [Lamp power] respectively.
- When the replacement time approaches, the message of "The lamp life is ending. Please change the lamp." is displayed every time the power is turned on. This display disappears when you press the button.

#### Used Lamps

This projector's lamps contain trace amounts of environmentally harmful inorganic mercury. Be careful not to break used lamps, and dispose of them in accordance with local regulations.

# Lens and main unit cleaning

## ⚠ WARNING

- Request cleaning and maintenance of a ceiling-mounted unit from your projector dealership. Attempting to clean or replace the lamp in a high location by yourself may cause you to fall, resulting in injury.

### ■ Lens cleaning

- Clean the lens with a commercially available blower and/or lens cleaner.
- The lens is easily scratched, so do not rub it with hard objects, or strike it.

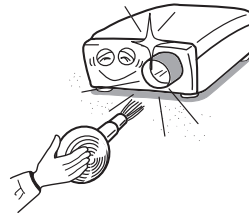

### ■ Main unit cleaning

- Unplug the power cord before cleaning the main unit.
- Wipe dirt off the main unit gently with a soft cloth.
- Do not wipe the main unit with a damp cloth. Doing so may allow water to get inside, resulting in an electric shock or unit failure.
- Do not use benzene, thinner and the like as they may deform or discolor the unit or damage the paint surface.
- Do not use a chemically saturated cloth.

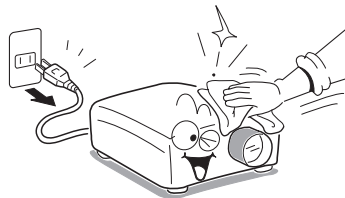

# Trouble indications

The indicator illuminates and a beep sound informs you of internal abnormalities.

	<p><b>No power</b></p> <p>⇒ Problem with projector</p> <ul style="list-style-type: none"> <li>Unplug the power cord, and contact your dealer.</li> </ul>
	<p><b>Lamp went out during use, or won't come on</b></p> <p>⇒ Lamp temperature is high so that it is difficult to turn on, the lifetime of the lamp has ended or the projector is malfunctioning.</p> <ul style="list-style-type: none"> <li>Unplug the power cord and wait for a short while, then turn the power back on.</li> <li>If a lamp burns out, replace it with a new one.</li> </ul>
	<p><b>Power went out during use</b></p> <p>⇒ Internal overheating, or the outside temperature is too high.</p> <ul style="list-style-type: none"> <li>Place the projector so that the air intake and exhaust are not blocked.</li> <li>Unplug the power cord and wait for a short while, then turn the power back on.</li> </ul> <p>*The  icon will appear before the power goes out.</p>
	<p><b>Power went out during use</b></p> <p>⇒ Problem with internal cooling fan.</p> <ul style="list-style-type: none"> <li>Unplug the power cord, and contact your dealer.</li> </ul> <p>*The  icon will appear before the power goes out.</p>
	<p><b>Power went out during use, or power won't come on</b></p> <p>⇒ The lamp cover is not properly attached.</p> <ul style="list-style-type: none"> <li>Unplug the power cord, and reattach the lamp cover. <a href="#">p.46</a></li> </ul>
	<p><b>Power went out during use</b></p> <p>⇒ Problem inside the projector.</p> <ul style="list-style-type: none"> <li>Unplug the power cord and wait for a short while, then turn the power back on.</li> <li>If the above action will not clear the problem, unplug the power cord, and contact your dealer.</li> </ul> <p>*The  icon will appear before the power goes out.</p>

### ■ Note

- After there is an abnormal indication, the abnormal status remains until the main power switch is turned off.

# Troubleshooting

If you think something is wrong, check the followings before contacting customer service. Please see “**Trouble indications**” [p.49](#) as well.

If This Happens	Check
<b>No power</b>	<ul style="list-style-type: none"> <li>Is the power cord plugged in? Is it connected to the projector?</li> <li>Is the main power switch turned on? <a href="#">p.24</a></li> <li>Is the outer lamp cover attached properly? <a href="#">p.46</a></li> </ul>
<b>Power goes out during use</b>	<ul style="list-style-type: none"> <li>Is the ambient temperature high? <a href="#">p.49</a></li> <li>Is the air intake or air exhaust blocked? <a href="#">p.49</a></li> </ul>
<b>No picture</b>	<ul style="list-style-type: none"> <li>Is the input source selected correctly? (When [Auto input search] is [Off]) <a href="#">p.41</a></li> <li>Is the mute function on? <a href="#">p.32</a></li> <li>Is the brightness setting minimized? <a href="#">p.36</a></li> <li>Are the connections set up correctly? <a href="#">p.22</a> <a href="#">p.23</a></li> <li>Are all the connected devices functioning properly?</li> </ul>
<b>No audio</b>	<ul style="list-style-type: none"> <li>Is the mute function on? <a href="#">p.32</a></li> <li>Is the volume setting minimized? <a href="#">p.27</a></li> <li>Are the connections set up correctly? <a href="#">p.22</a> <a href="#">p.23</a></li> <li>Are all the connected devices functioning properly?</li> </ul>
<b>Picture not displayed correctly</b>	<ul style="list-style-type: none"> <li>Is the input signal supported by the projector? <a href="#">p.53</a> <a href="#">p.54</a></li> <li>Is there something generating an abnormal video signal, for instance the video tape?</li> </ul>
<b>Picture blurred Part of picture out of focus</b>	<ul style="list-style-type: none"> <li>Is the lens dirty? <a href="#">p.48</a></li> <li>Is the lens focus adjusted optimally? <a href="#">p.27</a></li> <li>Is the projection distance within the projector's supported range? <a href="#">p.21</a></li> <li>Is the projector's screen placement angle tilted too far? <a href="#">p.21</a></li> <li>Are the sharpness or sampling phase adjustments off? <a href="#">p.36</a> <a href="#">p.37</a></li> </ul>
<b>Image is dark</b>	<ul style="list-style-type: none"> <li>Are the brightness or contrast adjustments off? <a href="#">p.36</a></li> <li>Is the lamp nearing the end of its service life? <a href="#">p.43</a></li> </ul>
<b>Colors too light Bad shading</b>	<ul style="list-style-type: none"> <li>Are the color, tint, R-level, G-level, or B-level adjustments off? <a href="#">p.36</a></li> <li>Is the screen dirty?</li> <li>Is the blackboard mode set properly? <a href="#">p.41</a></li> <li>Is the lamp nearing the end of its service life? <a href="#">p.43</a></li> </ul>
<b>Control panel key doesn't work</b>	<ul style="list-style-type: none"> <li>Is the key lock function on? <a href="#">p.43</a></li> </ul>

If This Happens	Check
<b>Remote control doesn't work</b>	<ul style="list-style-type: none"> <li>Is the remote control code identical with the projector's code? <a href="#">p.42</a></li> <li>Are the remote control's batteries drained?</li> <li>Are the batteries inserted into the remote control correctly? <a href="#">p.19</a></li> <li>Is the remote control being used within the effective range? <a href="#">p.19</a></li> <li>Are there any obstructions between the remote control and projector?</li> <li>Are there any fluorescent or other bright lights shining at the projector's infrared remote sensor?</li> </ul>

# Specifications

## List of general specifications

Item	Specification	
Consumption Power	385 W	
Weight	4.2 kg	
External Dimensions (including protruding parts)	338 × 128 × 280 mm (W × H × D)	
Cabinet material	PC+ABS resin and ABS resin	
Conditions for usage environment	Temp: 5°C to 35°C; relative humidity: 30% to 70%	
Display pixels	1 DLP® chip	
Picture elements	786,432 pixels (1024 H × 768 V)	
Lens	F=2.3~2.47 f=22.97~27.56 mm	
Lamp	High-pressure mercury lamp (275 W)	
Projection screen size	40-300 inches	
Projection distance	1.29 m – 12.01 m	
Speaker	1W (Mono)	
Connection terminal	COMPUTER(Y/PB/PR) 1 IN terminal	DVI-I: Analog RGB / Digital RGB / Y/PB/PR (dual use) AUDIO: 3.5 mm dia. stereo mini-jack, 1.5 V (rms)
	COMPUTER(Y/PB/PR) 2 IN terminal	Mini D sub 15 pin Analog RGB / Y/PB/PR (dual use) AUDIO: 3.5 mm dia. stereo mini-jack, 1.5 V (rms), 22 kΩ or more
	MONITOR terminal	Mini D sub 15 pin RGB / Y/PB/PR (dual use)
	S-VIDEO terminal	Mini DIN 4 pin
	VIDEO terminal	RCA Pin Jack, 1 V (p-p), 75 Ω
	AUDIO (L/R) terminal	RCA Pin Jack × 2, 1.5 V (rms), 22 kΩ or more
	AUDIO OUT terminal	3.5mm dia. stereo mini-jack
	CONTROL terminal	D sub 9 pin (RS-232C)

## Notes

- This model complies with the above specifications.
- Designs and specifications are subject to change without notice.
- This model may not be compatible with features and/or specifications that may be added in the future.

## Separately sold product

Replacement Lamp Model : TLPLW23

## List of supported signals (RGB signals)

This projector supports the following RGB signals. Note, however, that depending on the computer model, the screen may show flicker or streaking. Please adjust the projector if this happens.

Resolution	Mode	Refresh rate (Hz)	H-frequency (kHz)	Clock (MHz)	
720 x 400	720x400_85	85.039	37.927	35.500	
640 x 480	VGA_60	59.940	31.469	25.175	
	VGA_72	72.809	37.861	31.500	
	VGA_75	75.000	37.500	31.500	
	VGA_85	85.008	43.269	36.000	
800 x 600	SVGA_56	56.250	35.156	36.000	
	SVGA_60	60.317	37.879	40.000	
	SVGA_72	72.188	48.077	50.000	
	SVGA_75	75.000	46.875	49.500	
832 x 624	SVGA_85	85.061	53.674	56.250	
	MAC16"	74.550	49.725	57.283	
	1024 x 768	XGA_60	60.004	48.363	65.000
		XGA_70	70.069	56.476	75.000
XGA_75		75.029	60.023	78.750	
XGA_85		84.997	68.667	94.500	
1152 x 864	MAC19"	74.700	60.134	79.857	
	SXGA1_75	75.000	67.500	108.000	
1280 x 960	QuadVGA_60	60.000	60.000	108.000	
	QuadVGA_85	85.002	85.938	148.500	
1280 x 1024	SXGA3_60	60.020	63.981	108.000	
	SXGA3_75	75.025	79.976	135.000	
	SXGA3_85	85.024	91.146	157.500	
1400 x 1050	SXGA+	59.978	65.317	121.750	
1600 x 1200	UXGA_60	60.000	75.000	162.000	

## Note

- Signals whose resolution exceeds the native resolution (1024 × 768 pixels) will be compressed. For this reason, some information may be lost, or image quality may be affected.

## Specifications (Continued)

### List of supported signals (Component signals)

Signal format	fh(kHz)	fv(Hz)
480i(525i)@60Hz*	15.73	59.94
480p(525p)@60Hz	31.47	59.94
576i(625i)@50Hz*	15.63	50.00
576p(625p)@50Hz	31.25	50.00
720p(750p)@60Hz	45.00	60.00
720p(750p)@50Hz	37.50	50.00
1080i(1125i)@60Hz	33.75	60.00
1080i(1125i)@50Hz	28.13	50.00
1080p(1125p)@60Hz	67.50	60.00
1080p(1125p)@50Hz	56.25	50.00

\* DVI digital input is not supported.

### List of supported signals (Video, S-Video signals)

Video mode	fh(kHz)	fv(Hz)	fsc(MHz)
NTSC	15.73	60	3.58
PAL	15.63	50	4.43
SECAM	15.63	50	4.25 or 4.41
PAL-M	15.73	60	3.58
PAL-N	15.63	50	3.58
PAL-60	15.73	60	4.43
NTSC4.43	15.73	60	4.43

### Pin assignment of DVI-I terminal

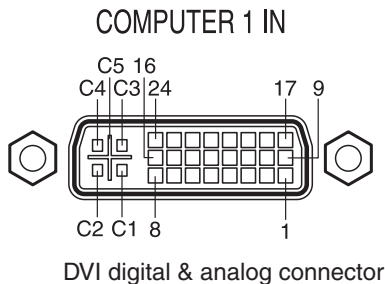

#### Analog input signal

- Analog RGB input  
 RGB signals: 0.7 V (p-p) 75 Ω  
 Horizontal sync signal: TTL level (Pos/neg polarity)  
 Vertical sync signal: TTL level (Pos/neg polarity)
- Y/P<sub>B</sub>/P<sub>R</sub> input  
 Y signal: 1.0 V (p-p) 75 Ω  
 P<sub>B</sub>/P<sub>R</sub> signals: 0.7 V (p-p) 75 Ω

Pin No.	Pin description
1	T.M.D.S. data 2 –
2	T.M.D.S. data 2 +
3	T.M.D.S. data 2/4 shielded
4	T.M.D.S. data 4 – (N.C)
5	T.M.D.S. data 4 + (N.C)
6	DDC clock
7	DDC data
8	Analog vertical sync signal
9	T.M.D.S. data 1 –
10	T.M.D.S. data 1 +
11	T.M.D.S. data 1/3 shielded
12	T.M.D.S. data 3 – (N.C)
13	T.M.D.S. data 3 + (N.C)
14	+5 V power source
15	GND(+5 V, H Sync & V Sync)

Pin No.	Pin description
16	Hot plug detection
17	T.M.D.S. data 0 –
18	T.M.D.S. data 0 +
19	T.M.D.S. data 0/5 shielded
20	T.M.D.S. data 5 – (N.C)
21	T.M.D.S. data 5 + (N.C)
22	T.M.D.S. clock shielded
23	T.M.D.S. clock +
24	T.M.D.S. clock –
C1	Analog video signal (R/P <sub>R</sub> )
C2	Analog video signal (G/Y)
C3	Analog video signal (B/P <sub>B</sub> )
C4	Analog horizontal sync signal
C5	Analog GND (R/P <sub>R</sub> , G/Y, B/P <sub>B</sub> )

### Pin assignment of COMPUTER 2 IN & MONITOR terminals

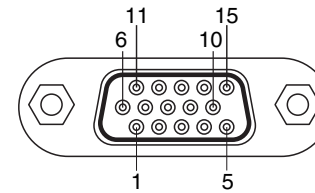

Mini D sub 15 Pin connector

#### Input Signal

- RGB input  
 RGB signals: 0.7 V (p-p) 75 Ω  
 Horizontal sync signal: TTL level (Pos/neg polarity)  
 Vertical sync signal: TTL level (Pos/neg polarity)
- Y/P<sub>B</sub>/P<sub>R</sub> input  
 Y signal: 1.0 V (p-p) 75 Ω  
 P<sub>B</sub>/P<sub>R</sub> signals: 0.7 V (p-p) 75 Ω

Pin No.	Pin description	
	During RGB input	During Y/P <sub>B</sub> /P <sub>R</sub> input
1	Video signal (R)	Color difference signal (P <sub>R</sub> )
2	Video signal (G)	Luminance signal (Y)
3	Video signal (B)	Color difference signal (P <sub>B</sub> )
4	GND	*
5	GND	*
6	GND(R)	GND(P <sub>R</sub> )
7	GND(G)	GND(Y)
8	GND(B)	GND(P <sub>B</sub> )
9	N.C	*
10	GND	*
11	GND	*
12	N.C	*
13	Horizontal sync signal	*
14	Vertical sync signal	*
15	N.C	*

\* Do not connect anything.

## Specifications (Continued)

### ■ CONTROL terminal

#### ● Pin assignment

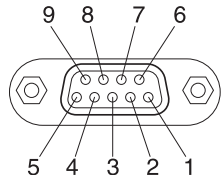

D sub 9 pin connector

Pin No.	Signal Name	Description
1	DCD	Data carrier detect
2	TXD	Sending data
3	RXD	Receiving data
4	DTR	Data terminal ready
5	GND	Signal ground
6	DSR	Data set ready
7	RTS	Request to send
8	CTS	Consent to send
9	RI	Ring indicator

#### ● Interface format

1. Communication method RS-232C, 9600 bps, No Parity, Data Length: 8 bits; Stop Bit Length: 1 bit
2. Communication format 

STX (02 h)	Command (3 Byte)	ETX (03 h)
------------	------------------	------------
3. Data format Only 1 command valid per communication. For input commands, only ASCII-compliant all-uppercase alphanumeric characters supported.
4. Replies
 

Acknowledge	ACK (06 h)	CR(0 Dh)	Data	... Normally ended
	ACK (06 h)	ESC(1 Bh)		... Aborted
No acknowledge	NAK (15 h)			

If commands are to be sent consecutively, wait for the response from the projector before sending the next command.

#### ● Main Commands

Item	Command
Power on	<b>PON</b>
Power off	<b>POF</b>
Icon display on	<b>MO0</b>
Icon display off	<b>MO1</b>
Auto setting (RGB input)	<b>PAT</b>
Status display on	<b>DON</b>
Status display off	<b>DOF</b>

#### ■ Note

- Contact your dealer for control cable and other commands.

**TOSHIBA CORPORATION**