

myprojectorlamps.com

**The most trusted, dependable name
in projector lamp sales.**



<http://www.myprojectorlamps.com>



<http://www.myprojectorlamps.ca>



<http://www.myprojectorlamps.eu>

The following projector manual has not been modified or altered in any way.

TOSHIBA

Owner's Manual
Home Theater Projector

TDP-MT700

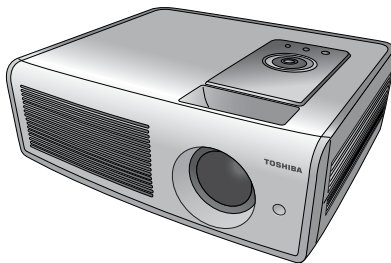

SAFETY PRECAUTION



The lightning flash with arrowhead symbol, within an equilateral triangle, is intended to alert the user to the presence of uninsulated "dangerous voltage" within the product's enclosure that may be of sufficient magnitude to constitute a risk of electric shock to persons.



The exclamation point within an equilateral triangle is intended to alert the user to the presence of important operating and maintenance (servicing) instructions in the literature accompanying the appliance.

WARNING: TO REDUCE THE RISK OF FIRE OR ELECTRIC SHOCK, DO NOT EXPOSE THIS APPLIANCE TO RAIN OR MOISTURE. DANGEROUS HIGH VOLTAGES ARE PRESENT INSIDE THE ENCLOSURE. DO NOT OPEN THE CABINET. REFER SERVICING TO QUALIFIED PERSONNEL ONLY.

WARNING: Handling the cord on this projector, or the cords associated with accessories sold with this projector, will expose you to lead, a chemical known to the State of California to cause birth defects or other reproductive harm. **Wash hands after handling.**

USA only

WARNING: The lamp used in this projector contains mercury. Disposal of mercury may be regulated due to environmental considerations. For disposal or recycling information, please contact your local authorities or the Electronic Industries Alliance: www.eiae.org.

USA only

MODEL NAME: TDP-MT700

TRADE NAME: HOME THEATER PROJECTOR

MODEL NAME: TDP-MT700



Tested To Comply
With FCC Standards

FOR HOME OR OFFICE USE

FCC NOTICE: This device complies with part 15 of the FCC Rules. Operation is subject to the following two conditions:

(1) This device may not cause harmful interference, and (2) this device must accept any interference received, including interference that may cause undesired operation. This equipment has been tested and found to comply with the limits for a Class B digital device, pursuant to part 15 of the FCC Rules. These limits are designed to provide reasonable protection against harmful interference in a residential installation. This equipment generates, uses and can radiate radio frequency energy and, if not installed and used in accordance with the instructions, may cause harmful interference to radio communications.

However, there is no guarantee that interference will not occur in a particular installation. If this equipment does cause harmful interference to radio or television reception, which can be determined by turning the equipment off and on, the user is encouraged to try to correct the interference by one or more of the following measures:

- Reorient or relocate the receiving antenna.
- Increase the separation between the equipment and receiver.
- Connect the equipment into an outlet on a circuit different from that to which the receiver is connected.
- Consult the dealer or an experienced radio/TV technician for help.

RESPONSIBLE PARTY: TOSHIBA AMERICA CONSUMER PRODUCTS, L.L.C.

82 Totowa Road, Wayne, NJ, 07470

Phone: (973) 628-8000

WARNING: Changes or modifications made to this equipment, not expressly approved by Toshiba, or parties authorized by Toshiba, could void the user's authority to operate the equipment.

USA only

Notice: This Class B digital apparatus complies with Canadian ICES-003. Cet appareil numérique de la classe B est conforme à la norme NMB-003 du Canada.

Canada only

IMPORTANT SAFETY INSTRUCTIONS

CAUTION: PLEASE READ AND OBSERVE ALL WARNINGS AND INSTRUCTIONS GIVEN IN THIS OWNER'S MANUAL AND THOSE MARKED ON THE UNIT. RETAIN THIS BOOKLET FOR FUTURE REFERENCE.

This set has been designed and manufactured to ensure personal safety. Improper use can result in electric shock or fire hazard. The safeguards incorporated in this unit will protect you if you observe the following procedures for installation, use and servicing. This unit is fully transistorized and does not contain any parts that can be repaired by the user.

DO NOT REMOVE THE CABINET COVER OR YOU MAY BE EXPOSED TO DANGEROUS VOLTAGE. REFER SERVICING TO QUALIFIED SERVICE PERSONNEL ONLY.

1. Read owner's manual

After unpacking this product, read the owner's manual carefully, and follow all the operating and other instructions.

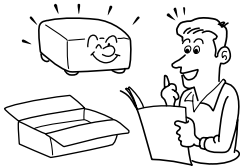

2. Power sources

This product should be operated only from the type of power source indicated on the marking label. If you are not sure of the type of power supply to your home, consult your product dealer or local power company. For products intended to operate from battery power or other sources, refer to the operating instructions.



3. Source of light

Do not look into the lens while the lamp is on. The strong light from the lamp may cause damage to your eyes or sight.



4. Ventilation

Openings in the cabinet are provided for ventilation to ensure reliable operation of the product and protect it from overheating. These openings must not be blocked or covered. The openings should never be blocked by placing the product on a bed, sofa, rug or other similar surface. This product should not be placed in a built-in installation such as a bookcase or rack unless proper ventilation is provided or the manufacturer's instructions have been adhered to.



5. Heat

The product should be situated away from heat sources such as radiators, heat registers, stoves, or other products (including amplifiers) that produce heat.

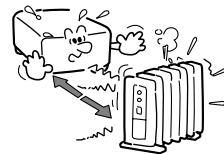

6. Replacement parts

When replacement parts are required, be sure the service technician has used replacement parts specified by the manufacturer or that have the same characteristics as the original part. Unauthorized substitutions may result in fire, electric shock, or other hazards. (The lamp is the only user-replaceable part.)

7. Water and moisture

Do not use this product near water (for example, near a bath tub, wash bowl, kitchen sink, or laundry tub; in a wet basement; or near a swimming pool).

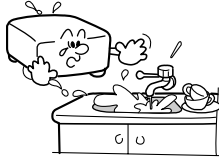

8. Cleaning

Unplug this product from the wall outlet before cleaning. Do not use liquid cleaners or aerosol cleaners. Use a soft cloth for cleaning.

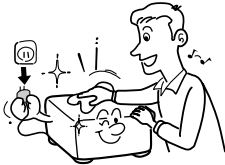

9. Power cord protection

Power-supply cords should be routed so that they are not likely to be walked on or pinched by items placed upon or against them, paying particular attention to cords at plugs, convenience receptacles, and the point where they exit from the product.



10. Overloading

Do not overload wall outlets; extension cords, or integral convenience receptacles as this can result in a risk of fire or electric shock.



11. Do not use the product in a closed installation state.

Do not place the product in a box or in any other closed installation state. Otherwise it may overheat. This could result in a risk of fire.

12. Lightning storms

For added protection for this product during a storm, or when it is left unattended and unused for long periods of time, unplug it from the wall outlet. This will prevent damage to the product due to lightning and power line surges. However, while it is thundering or lightning, do not touch the apparatus and any connected cable and/or equipment. This will prevent you from receiving the electric shock by an electric surge.



13. Object and liquid entry

Never push objects of any kind into this product through the openings, as they may touch dangerous voltage points or short-out parts that could result in a fire or electric shock. Never spill liquid of any kind on the product.



14. Do not place the product vertically.

Do not use the product in the upright position to project pictures at the ceiling, or any other vertical positions. The product may fall over, causing personal injury or product damage.

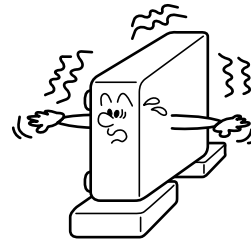

15. Do not leave thermal-paper documents or easily deformed items on top of the unit or near the air exhaust for long periods of time.

The heat from the unit could erase the information on the thermal paper, or cause deformation or warping.

16. Do not stack components.

Do not stack other equipment on this product or stack this product on other equipment. The top and bottom surfaces of this product develop heat and may damage the other unit.

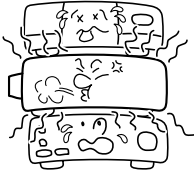
**17. Attachments**

Do not use attachments not recommended by the product manufacturer, as they may cause hazards.

18. Accessories

Do not place this product on an unstable cart, stand, tripod, bracket, or table. The product may fall, causing serious injury to a child or adult, and serious damage to the product. A product and cart combination should be moved with care. Quick stops, excessive force, and uneven surfaces may cause the product and cart combination to overturn.



S3125A

19. Safety check

Upon completion of any service or repairs to this product, ask the service technician to perform safety checks to determine that the product is in proper operating condition.

**20. Damage requiring service**

Unplug this product from the wall outlet and refer servicing to qualified service personnel under the following conditions:

- a) when the power-supply cord or plug is damaged;
- b) if liquid has been spilled or objects have fallen into the product;
- c) if the product has been exposed to rain or water;
- d) if the product does not operate normally by following the operating instructions (adjust only those controls that are covered by the operating instructions as an improper adjustment of other controls may result in damage and will often require extensive work by a qualified technician to restore the product to its normal operation);
- e) if the product has been dropped or damaged in any way; or
- f) when the product exhibits a distinct change in performance.

21. If glass components, including the lens and lamp, should break, contact your dealer for repair service.

This product incorporates glass components, including the lens and lamp. If such parts should break, please handle with care to avoid injury. Contact your dealer for repair service. The broken pieces of glass may cause injury. In the unlikely event of the lamp rupturing, thoroughly clean the area around the projector and discard any edible items placed in that area.

22. Servicing

Do not attempt to service this product yourself, as opening or removing covers may expose you to dangerous voltage or other hazards. Refer all servicing to qualified service personnel.



POWER SUPPLY CORD SELECTION

If your line voltage is 220 to 240V, use one of the following types of cable.

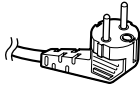
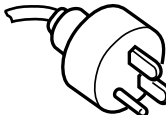
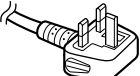
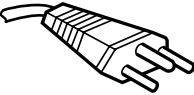
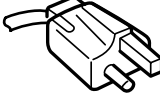
Plug configuration	Plug type	Line voltage	Plug configuration	Plug type	Line voltage
	EURO	220 - 240V		Australian 240V 10A	200 - 240V
	UK	220 - 240V		Switzerland 240V 6A	200 - 240V
Use a 5A fuse approved by ASTA or BSI to BSI362. Always replace the fuse cover after changing the fuse.				North American 240V 10A	200 - 240V

IMPORTANT PRECAUTIONS

Save Original Packing Materials

The original shipping carton and packing materials will come in handy if you ever have to ship your projector. For maximum protection, repack the set as it was originally packed at the factory.

Moisture Condensation

Never operate this unit immediately after moving it from a cold location to a warm location. When the unit is exposed to such a change in temperature, moisture may condense on the crucial internal parts. To prevent the unit from possible damage, do not use the unit for at least 2 hours after there is an extreme or sudden change in temperature.

Location and Installation

- Do not place in hot locations, such as near a heater. Doing so could cause malfunction and shorten the life of the projector.
- Avoid locations with oil or cigarette smoke, which can affect the quality and useful life of the product's optical parts and darken the screen.
- Do not use the product vertically in any upright position or slantwise at an angle of 20 degrees or more.
- Using this product near a TV or radio may cause interference in the image or sound. If this happens, move it away from the TV or radio.
- In a high-altitude location where the air is thin, cooling efficiency is reduced; therefore, use the projector in a cool area.

IMPORTANT PRECAUTIONS (Continued)

Avoid Volatile Liquids

Do not use volatile liquids, such as an insect spray, near the unit. Do not leave rubber or plastic products touching the unit for a long time. They will leave marks on the finish. If cleaning with a chemically saturated cloth, be sure to follow the product's precautions.

In the spaces provided below, record the model and serial numbers located at the bottom of your projector.

Model No. _____

Serial No. _____

Retain this information for future reference.

EXEMPTION CLAUSES

- Toshiba Corporation bears no responsibility in the case of damages arising from natural disaster such as earthquakes, lightning, etc., fire not liable to Toshiba Corporation, operation, theft or mischief by third parties, other accidents, or use under abnormal conditions including erroneous or improper operation and other problems.
- Toshiba Corporation bears no responsibility for incidental damages (lost profit, work interruption, corruption or loss of the memory contents, etc.) arising from the use of or the inability to use this unit.
- Toshiba Corporation accepts no liability whatsoever for any damages arising from not having followed the descriptions in this Instruction Manual.
- Toshiba Corporation accepts no liability whatsoever for any damages arising from malfunctions arising from combination with equipment or software that is not related to Toshiba Corporation.

OTHER NOTES AND INFORMATION

Copyrights

Showing or transmitting commercial imaging software or broadcast or cable-broad casting programs with the purpose of other than the personal and private viewing, including modifying images using the freeze, screen size, PIP or POP functions, or displaying with the varying aspect ratio of the images, could violate the direct or indirect copyrights of the imaging software or broadcast program, etc., if done without first consulting with the copyright holder. For this reason, please take appropriate measures before performing one of the actions listed above, including obtaining a license from the copyright holder.

Disposal

This product contains substances which are harmful to humans and the environment.

- Solder used in the internal parts contains the lead.
- The lamp contains inorganic mercury.

Please dispose of this product or used lamps in accordance with local regulations.

Trademarks

- VGA, SVGA, XGA, SXGA, UXGA are trademarks or registered trademarks of International Business Machines Corporation.
- DLP and Digital Light Processing, Digital Micromirror Device, DMD, and DLP are trademarks of Texas Instruments.
- Macintosh is a registered trademark of Apple Computer, Inc.
- Theater Wide is a registered trademark of Toshiba America Consumer Products, L.L.C.
- HDMI, the HDMI logo and High-Definition Multimedia Interface are trademarks or registered trademarks of HDMI licensing LLC.
- DCDi, TrueLife and Fraudja are trademarks of Fraudja, a division of Genesis Microchip Corp.

Notational Conventions Used in This Manual

- References to pages with related information are annotated as follows. For example, if making a reference to page 36: [p.36](#)
- The illustrations in this document are for reference purposes only and may not reflect your package exactly.

REMOTE CONTROL BATTERIES

Caution

- Never throw batteries into a fire.

Note

- Be sure to use AAA batteries.
- Dispose of batteries in a designated disposal area.
- Attention should be drawn to the environmental aspects of battery disposal.
- Do not mix different battery types or combine used batteries with new ones.
- If the remote control does not operate correctly, or if the operating range becomes reduced, replace both batteries with new ones.
- If the batteries are dead or if you will not be using the remote control for a long time, remove the batteries to prevent battery acid from leaking into the battery compartment.

Using the batteries improperly may cause them to explode or leak and lead to burn or injury. If battery-leaking fluid contacts skin, wash the fluid off immediately with clean water and consult a doctor. If the fluid is spilled on an instrument, avoid contact and wipe it off using tissue paper. (Dispose of the used tissue paper as flammable garbage after moistening with water.)

CONTENTS

SAFETY PRECAUTION	2
IMPORTANT SAFETY INSTRUCTIONS	3
POWER SUPPLY CORD SELECTION	6
IMPORTANT PRECAUTIONS	6
EXEMPTION CLAUSES	7
OTHER NOTES AND INFORMATION	7
REMOTE CONTROL BATTERIES	8
CONTENTS	9
Overview	11
Shipping contents	11
Projector exterior view	12
Controls and functions	13
Positioning your projector	15
Choosing a location	15
Obtaining a preferred projected image size	16
Connecting various equipment	18
Connecting video inputs	18
Connecting a computer	19
Using the projector and remote control	20
Preparations	20
Turning the power on	20
Switching input signals	20
Adjust the image	21
Optimizing the image	21
Personalizing the projector menu display	23
Saving and loading the video memory	23
Using PIP (Picture-In-Picture) and POP (Picture-On-Picture) functions	23
Pausing the picture	24
Turning the power off	24
Menus	25
Menu structure	25
Using the menus	26

Picture menu	26
Display menu	27
Options menu	28
Setup menu	28
Advanced menu	29
Additional information	30
Care of the projector	30
About lamp	31
Replacing the lamp	31
Indicator lights	33
Troubleshooting	34
Specifications	35
Dimensions	35
Control terminal	36

Overview

Shipping contents

Please make sure that the following items are included in the box, along with the main unit. If any item is missing, please contact your dealer immediately.

 **Some of the accessories may vary from country to country.**



Projector

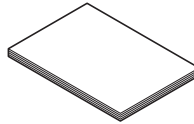

Owner's manual

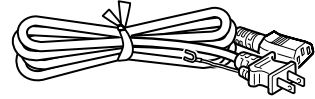

Power cord



Remote control

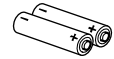

Batteries

Installing or replacing batteries

Push on the cover and slide it to open. Install two AAA batteries with the correct polarities, then close the cover.

Notes on batteries

- Before using the batteries, be sure to observe "REMOTE CONTROL BATTERIES" described in previous pages.
- Avoid leaving the remote control and batteries in an excessive heat or humid environment like the kitchen, bathroom, sauna, sunroom, or in a closed car.
- Dispose of used batteries according to the battery manufacturer's instructions and local environment regulations for your region.
- If the remote control will not be used for an extended period of time, remove the batteries to avoid damage to the control from possible battery leakage.

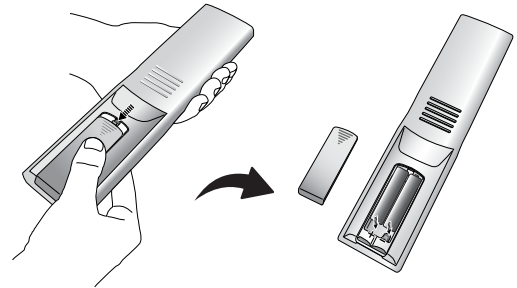

Projector exterior view

Front / Upper side

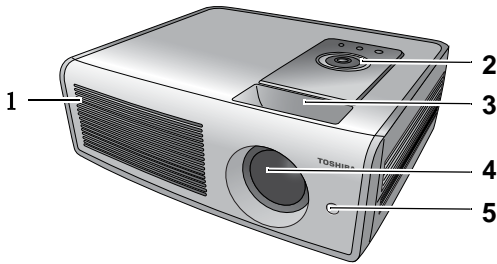

1. Ventilation holes (exhaust)
2. Control panel [p.13](#)
3. Focus ring and zoom ring
4. Projection lens
5. Front IR sensor

Rear side

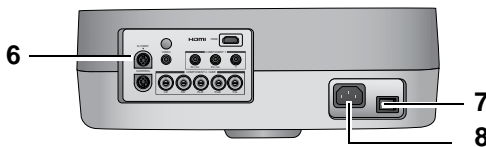

6. Connector panel (see below)
7. Main AC power switch
8. Power cord socket

Bottom and left sides

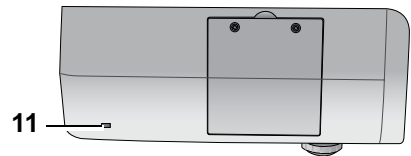

9. Front adjuster feet
10. Ceiling mounting holes
11. Antitheft lock hole

Connector panel

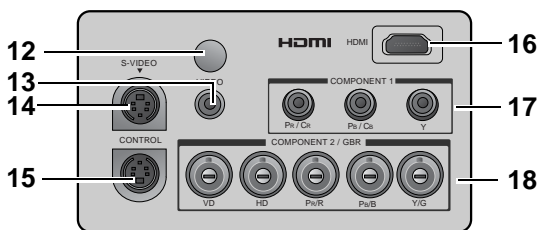

12. Rear IR sensor
13. Composite Video input (RCA jack)
14. S-Video input (mini DIN 4-pin)
15. Control terminal
16. HDMI™ (High-Definition Multimedia Interface) input
Supports an all-digital video source, such as a set-top box, DVD player.

17. Component video input (RCA jacks)
Supports Y/PB/PR or Y/CB/CR video signal input.
18. RGB/ HDTV input (BNC)
Supports Y/PB/PR, Y/CB/CR, or RGB video signal input or PC signal input.

Controls and functions

Control panel

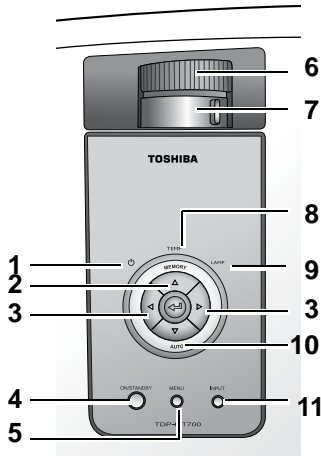



1. **POWER indicator light** [p. 33](#)
Lights up or flashes when the projector is under operation.
2. **MEMORY ▲** [p. 23](#)
Sequentially recalls settings saved in memory locations 1, 2, and 3.
When the on-screen menu is activated, this button is used as directional arrow.
3. **ARROWS <◀/▶/▲/▼>**
When the on-screen menu is activated, arrows #2, #3, and #10 (see illustration above) are used as directional arrows to select the desired menu items and to make adjustments.
4. **ON/STANDBY** [p. 20](#) , [p. 24](#) , [p. 33](#)
Press and hold this button to turn the projector on when it is in the standby mode. Or press this button twice to turn the projector off.
5. **MENU**
Turns the on-screen display control menu on. Exits and saves the menu settings.
6. **Focus Ring** [p.21](#)
Adjusts the focus of the projected image.
7. **Zoom Ring** [p.21](#)
Adjusts the size of the projected image.
8. **Temperature warning light** [p.33](#)
Lights up or flashes red if the projector's temperature becomes too high.
9. **LAMP indicator light** [p.33](#)
Indicates the status of the lamp.
Lights up or flashes red when the lamp has developed a problem. Please contact your dealer for assistance.
10. **AUTO ▼**
Automatically determines the best picture timings for the displayed image.
When the on-screen menu is activated, this button is used as directional arrow.
11. **INPUT** [p.26](#)
Switches input sources sequentially.

Remote control

Notes on remote control operation

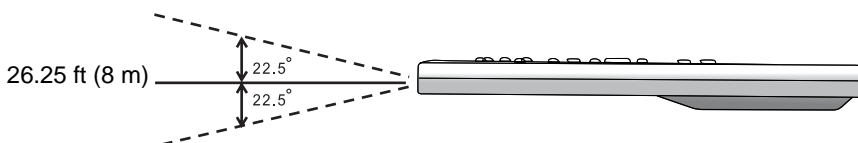
- Make sure there is nothing between the remote control and the projector's IR sensor that might obstruct the infrared beam.
- The effective range of the remote control is up to 26.25 feet (8 meters) from the front of the projector or 26.25 feet (8 meters) from the rear of the projector. The remote control must be held at an angle within 45 degrees of the projector's IR remote control sensor.



- If the remote control stops working, or if its effective range decreases, replace the batteries with new ones.
- The remote control may fail to operate if the infrared remote sensor is exposed to bright sunlight or fluorescent lighting.
- In rare cases, ambient conditions could impede the operation of the remote control. If this happens, point the remote control at the main unit again, and repeat the operation.
- If you press a button for a function that is not available, the icon  will appear on the screen when the button press is not effective.

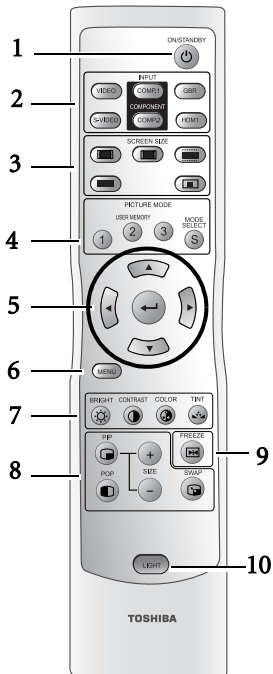

1. **ON/STANDBY** [p. 20](#) , [p. 24](#) , [p. 33](#)
Press and hold this button to turn the projector on when it is in the standby mode. Or press this button twice to turn the projector off.
2. **INPUT buttons** [p. 20](#)
Selects an input source to display on the projector.
3. **SCREEN SIZE buttons** [p.27](#)
Selects the image aspect ratio according to the input signal.
4. **PICTURE MODE selection buttons** [p.23](#)
Restores settings saved in memory locations 1, 2, and 3, or restores the default modes for the current input source (Dynamic, Standard, Theater 1, or Theater 2).
5. **Arrows (▲/◀/▼/▶)** [p.26](#)
Used to select the desired menu or to make adjustments.
-  **Enter button** [p.26](#)
Opens the selected items of the menu.
6. **MENU** [p.26](#)
Turns the on-screen display control menu on or return to upper level.
7. **Picture quality adjustment buttons** [p.26](#)

8. **PIP and POP buttons** [p.23](#)

To turn the PIP or POP function on or off, press the **PIP** or **POP** button. Adjust the size of the PIP image by pressing the + or - button. To switch between the two windows, repeatedly press **SWAP** to adjust the image settings in the selected window.

9. **FREEZE** [p.26](#)

Pauses the image.

10. **LIGHT**

Turns on the remote control's backlight.

Positioning your projector

Choosing a location

Your projector can be installed in one of four possible installation locations:

1. Floor in front of screen (Standard);
2. Ceiling in front of screen (Ceiling);
3. Floor at rear of screen (Rear);
4. Ceiling at rear of screen (Rear Ceiling).

Your room layout or personal preference will dictate which installation location you select. Take into consideration the size and position of your screen, the location of a suitable power outlet, as well as the location and distance between the projector and the rest of your equipment.

I. Floor in front of screen

Select this location with the projector placed near the floor in front of the screen. This is the most common way to position the projector for quick setup and portability.

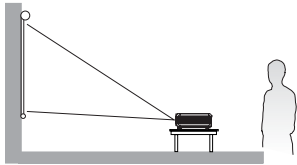

II. Ceiling in front of screen

Select this location with the projector suspended from the ceiling in front of the screen.

Select **Ceiling** in the **Setup > Projection Mode** menu after you turn the projector on.

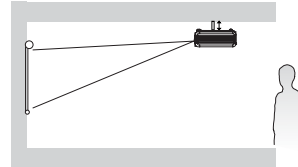

III. Floor at rear of screen

Select this location with the projector placed near the floor behind the screen.

Note that a special rear projection screen is required.

Select **Rear** in the **Setup > Projection Mode** menu after you turn the projector on.

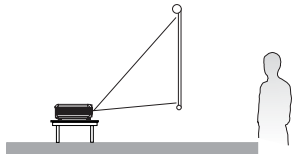

IV. Ceiling at rear of screen

Select this location with the projector suspended from the ceiling behind the screen.

Note that a special rear projection screen and the Projector Ceiling Mounting Kit are required for this installation location.

Select **Rear Ceiling** in the **Setup > Projection Mode** menu after you turn the projector on.

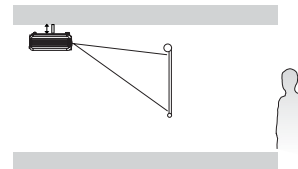

WARNING

- Always obey the instructions listed in **IMPORTANT SAFETY INSTRUCTIONS** when placing the unit. Attempting to clean/replace the lamp at a high site by yourself may cause you to drop down, thus resulting in injury.
- If you wish to mount the projector on the ceiling, be sure to ask your dealer to do so. Mounting the projector on a ceiling requires special ceiling brackets (sold separately) and specialized knowledge. Improper mounting could cause the projector to fall, resulting in an accident.
- If the projector is ceiling-mounted, install the breaker for turning off the power in case of anomaly. Let everyone involved with the use of the projector know that fact.

Obtaining a preferred projected image size

Factors that affect the projected image size including the distance from the projector lens to the screen, the zoom setting, and the video format. Tables of dimensions for both 16:9 and 4:3 screen ratios are provided below to help you determining the ideal location for your projector.

1. Determine the aspect ratio of your screen (16:9 or 4:3).
2. Select your desired **Screen Size** from the applicable screen dimension table below (16:9 or 4:3 ratio, depending on your screen ratio). Install the projector at a distance from the screen between the **Min.** and **Max. Projection Distance** values in the table.
3. Determine the preferred height of your projector.

For example, if you have a 16:9 screen that is 69.7 in. W x 39.4 in. H (177 cm W x 100 cm H), you should place your projector within a range of 92.1 in. to 125.2 in. (234 cm to 318 cm) from the screen. **The ideal height of your projector lens center will be level with the bottom or top side of the screen.**

Installation for a 16:9 ratio screen

Ceiling Installation

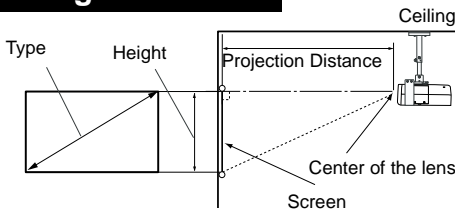

Floor Installation

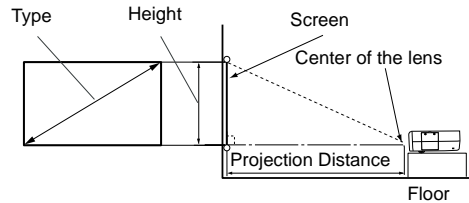

16:9 (widescreen) ratio screen dimension table

Screen Size			Projection Distance	
Type (inch) / (cm)	Height (inch) / (cm)	Width (inch) / (cm)	Min. (inch) / (cm)	Max. (inch) / (cm)
37 / 94	18.1 / 46	32.3 / 82	42.5 / 108	57.9 / 147
50 / 127	24.4 / 62	43.7 / 111	57.5 / 146	78.4 / 199
60 / 152	29.5 / 75	52.4 / 133	68.9 / 175	93.7 / 238
70 / 178	34.8 / 87	61.0 / 155	80.3 / 204	109.5 / 278
80 / 203	39.4 / 100	69.7 / 177	92.1 / 234	125.2 / 318
90 / 229	44.1 / 112	78.4 / 199	103.5 / 263	140.6 / 357
100 / 254	49.2 / 125	87.0 / 221	115.0 / 292	156.3 / 397
110 / 279	54.8 / 137	96.1 / 244	126.4 / 321	172.1 / 437
120 / 305	58.7 / 149	104.7 / 266	137.8 / 350	187.4 / 476
130 / 325	63.8 / 162	113.4 / 288	149.6 / 380	203.2 / 516
140 / 356	68.5 / 174	122.1 / 310	161.0 / 409	218.9 / 556
150 / 381	73.6 / 187	130.7 / 332	172.4 / 438	234.7 / 596
160 / 406	78.4 / 199	139.4 / 354	183.9 / 467	250.0 / 635
170 / 432	83.5 / 212	148.0 / 376	195.3 / 496	265.8 / 675
180 / 457	88.2 / 224	156.7 / 398	207.1 / 526	281.5 / 715
190 / 483	93.3 / 237	165.8 / 421	218.5 / 555	296.9 / 754
200 / 508	98.0 / 249	174.4 / 443	229.9 / 584	312.6 / 794
250 / 635	122.4 / 311	217.7 / 553	287.4 / 730	390.9 / 993
300 / 762	147.2 / 374	261.4 / 664	344.9 / 876	468.9 / 1191

 **The above numbers are approximate and may be slightly different from the actual measurements. Only the recommended screen sizes are listed. If the your screen size is not in the table above, please contact your dealer for assistance.**

An examination of the table reveals that you can place the projector lens in the range from 42.5 in. (108 cm) to 468.9 in. (1191 cm) distance from the screen, which will give you a projected image from 32.3 in. W x 18.1 in. H (82 cm W x 46 cm H) to 261.4 in. W x 147.2 in. H (664 cm W x 374 cm H) full screen.

Installation for a 4:3 ratio screen

Ceiling Installation

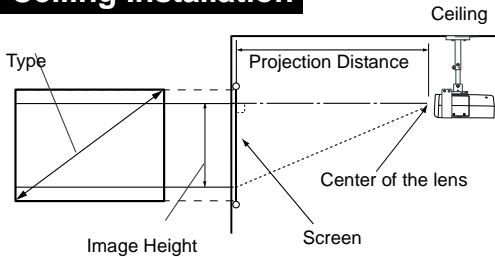

Floor Installation

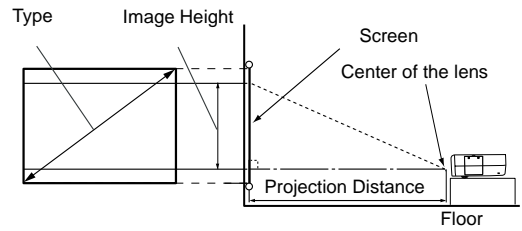

4:3 (standard) ratio screen dimension table:

Screen Size			Projection Distance		Image Height (inch) / (cm)
Type (inch) / (cm)	Height (inch) / (cm)	Width (inch) / (cm)	Min. (inch) / (cm)	Max. (inch) / (cm)	
37 / 94	22.1 / 56	29.5 / 75	39.0 / 99	53.2 / 135	16.5 / 42
50 / 127	29.9 / 76	40.2 / 102	52.8 / 134	71.7 / 182	22.4 / 57
60 / 152	35.8 / 91	48.0 / 122	63.0 / 160	85.8 / 218	27.2 / 69
70 / 178	42.1 / 107	55.9 / 142	73.62 / 187	100.4 / 255	31.5 / 80
80 / 203	48.0 / 122	64.2 / 163	84.3 / 214	114.6 / 291	35.8 / 91
90 / 229	53.9 / 137	72.1 / 183	94.9 / 241	128.7 / 327	40.6 / 103
100 / 254	59.8 / 152	79.9 / 203	105.1 / 267	143.3 / 364	44.9 / 114
110 / 279	66.1 / 168	88.2 / 224	115.8 / 294	157.5 / 400	49.6 / 126
120 / 305	72.1 / 183	96.1 / 244	126.4 / 321	171.7 / 436	53.9 / 137
130 / 325	78.0 / 198	103.9 / 264	137.0 / 348	186.2 / 473	58.7 / 149
140 / 356	83.9 / 213	111.8 / 284	147.2 / 374	200.4 / 509	63.0 / 160
150 / 381	90.2 / 229	120.1 / 305	157.9 / 401	214.6 / 545	67.3 / 171
160 / 406	96.1 / 244	128.0 / 325	168.5 / 428	229.1 / 582	72.1 / 183
170 / 432	102.0 / 259	135.8 / 345	179.1 / 455	243.3 / 618	76.4 / 194
180 / 457	107.9 / 274	144.1 / 366	189.3 / 481	257.9 / 655	81.1 / 206
190 / 483	114.2 / 290	152.0 / 386	200.0 / 508	272.1 / 691	85.4 / 217
200 / 508	120.1 / 305	159.8 / 406	210.6 / 535	286.2 / 727	90.2 / 229
250 / 635	150.0 / 381	200.0 / 508	263.0 / 668	357.9 / 909	112.6 / 286
300 / 762	180.0 / 457	239.0 / 610	315.8 / 802	429.5 / 1091	135.0 / 343

 The above numbers are approximate and may be slightly different from the actual measurements. Only the recommended screen sizes are listed. If the your screen size is not in the table above, please contact your dealer for assistance.

An examination of the table reveals that you can place the projector lens in the range from 39.0 in. (99 cm) to 429.5 in. (1091 cm) distance from the screen, which will give you a projected image from 29.5 in. W x 16.5 in. H (75 cm W x 42 cm H) to 239.0 in. W x 135.0 in. H (610 cm W x 343 cm H).

Connecting various equipment

You can connect the projector to many types of video equipment, such as a VCR, DVD player, digital tuner, cable box, satellite box, video game console, or digital camera. You can also connect it to a desktop or laptop PC or Apple Macintosh.

The projector can connect to multiple video devices at the same time by using different cables. Make sure you select the correct input to display.

When connecting any signal source to the projector, be sure to:

1. Turn off all equipment before making any connections.
2. Use the correct cables for each source.
3. Ensure that the cables are firmly inserted.
4. Connect all audio signals to external speakers. This projector is not equipped with speakers.

 In the connections shown below, cables are not included with the projector (see [p.11](#)). Cables are commercially available from electronics stores.

Connecting video inputs

Connecting HDMI™ devices

You must use an HDMI™ cable when connecting the projector to an HDMI™ device. The HDMI™ (High-Definition Multimedia Interface) terminal supports uncompressed video data transmission between compatible devices (such as DVD tuners, DVD players, and displays) over a single cable. It provides a pure digital viewing and listening experience.

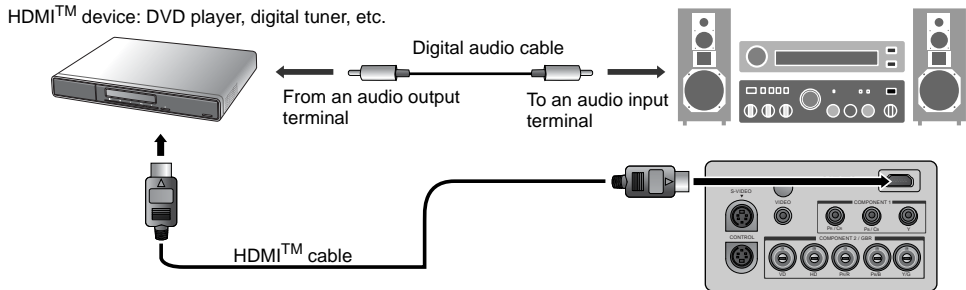

 Because HDMI™ is an evolving technology, it is possible that some devices may not operate properly with the projector.

Connecting component video devices

Be sure to match the corresponding colors between the cables and the terminals.

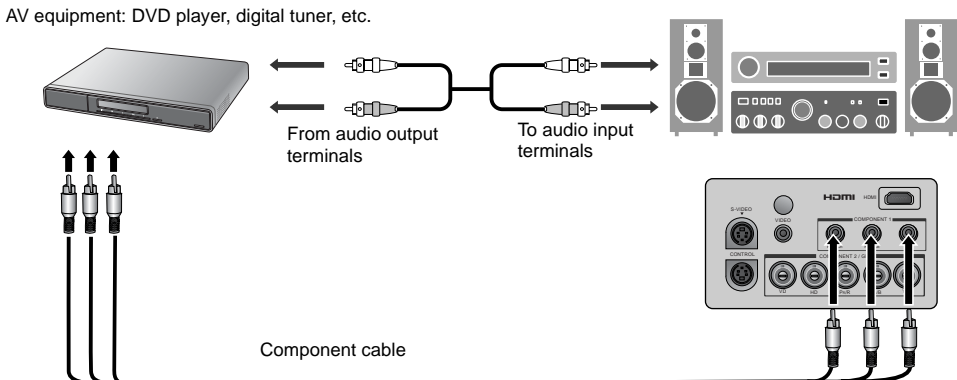

Connecting S-video or video devices

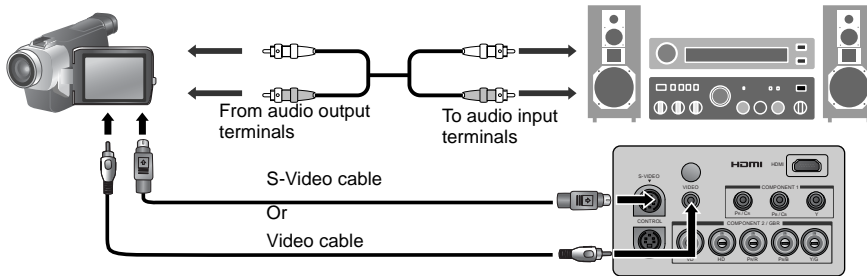

Connecting a computer

Connect the projector to a computer with a VGA-BNC cable.

Laptop or desktop computer

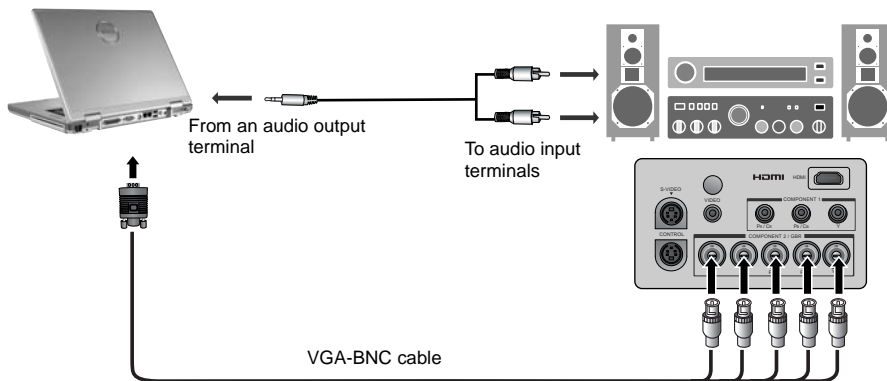

- ☞ If the selected video image does not display after the projector is turned on and the correct video source has been selected, make sure the video source is turned on and operating correctly. Also make sure all signal cables have been connected correctly.
- ☞ Many laptops do not turn on their external video ports when connected to a projector. Usually a key combo such as FN + F3 or CRT/LCD key turns the external display on/off. Locate a function key labeled CRT/LCD or a function key with a monitor symbol on the laptop. Press FN and the labeled function key simultaneously. Refer to your laptop's documentation to learn your laptop's key combination.

Using the projector and remote control

Preparations

1. Turn on all connected devices.
2. Remove the lens cap.
3. Plug the supplied power cord into the AC inlet on the rear of the projector and turn the main AC power switch on.

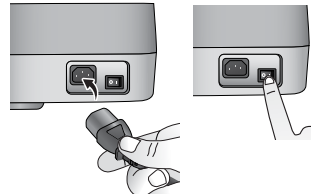
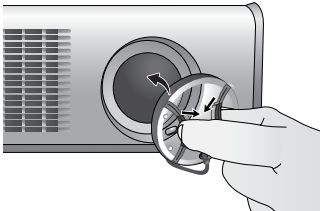

4. Plug the power cord into a power outlet.

Turning the power on

Follow the steps below.

1. Make sure the Power light is orange after power has been applied and the main AC power switch is turned on.
2. Press and hold the **ON/STANDBY** button on the projector or remote control to turn the projector on.

 **The ON/STANDBY button may not work while the projector is warming up.**

3. The fans will be running. A start-up image shows on-screen for a few seconds.
4. "Searching...." will display on-screen before the projector identifies the input signal. This message will remain on-screen until a valid signal is detected.
5. If the horizontal frequency of the input signal exceeds the range of the projector, a message reading "Unsupported timing" will display on-screen. This message will remain on-screen until you change the input signal.



Switching input signals

The projector can be connected to multiple devices at the same time. To sequentially select input signals, press one of the INPUT buttons on the remote control or **INPUT** on the projector.

- When the projector is turned on, it will search for the input source you last selected.
- If you need to use the PIP or POP function, refer to [p.23](#) for advanced operation.

CAUTION

- Do not look into the lens while the lamp is on. The strong light from the lamp may cause damage to your eyes or sight.
- Do not block the air intake or exhaust. Doing so could cause a fire due to internal overheating.
- Do not place your hands, face, or other objects near the air exhaust. Doing so could cause burns, deform/break the object.



Adjust the image

Adjusting the angle height

Turn the two feet on the bottom of the projector to adjust the image height and projection angle (see illustration at right).

☞ If the screen and the projector are not perpendicular to each other, the projected image becomes distorted (trapezoidal). To correct this problem, adjust the Keystone value in the Setup menu.

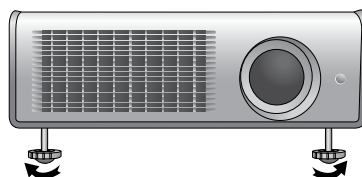

Auto-adjusting the image

When you press the Auto button on the projector, the built-in intelligent auto-adjustment function will readjust the values of Frequency and Clock to provide the best image quality.

The current source information will display at the bottom right corner of the screen for 3 seconds.

☞ The screen will be blank while the auto-adjustment is functioning.

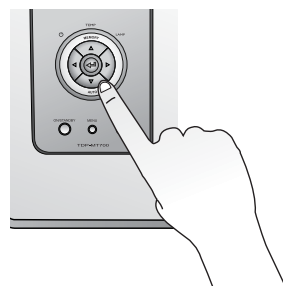

Fine-tuning the image size and clarity

1. Use the zoom ring to adjust the projected image to the size you need.

2. Then sharpen the image by rotating the focus ring.

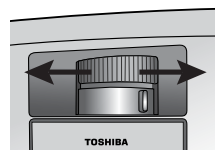
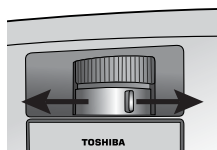
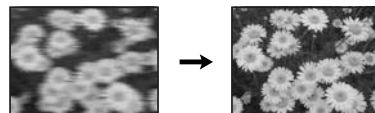
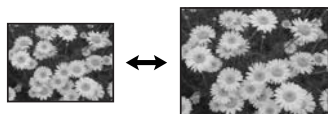

Optimizing the image

To optimize the image, use the remote control or on-screen menus. For the operation of on-screen menus, please refer to [p.26](#).

The following steps are optional. You do not need to follow every step. It depends on the image quality you desire.

Note

- Note that a lamp characteristics may rarely cause the brightness to fluctuate slightly.
- A lamp is consumable item. If used for extended periods, images will appear dark, and the lamp could burn out. This is characteristic of a lamp, and is not malfunction. (The lifetime of the lamp depends on conditions of use.)
- The DMDTM is made using extremely advanced technology, but there may be black spots (pixels that do not light) or bright spots (pixels that are constantly lit) on the panel. Please note that these are not malfunctions.

1. Selecting a picture mode

Select a picture mode on the remote control (or in the **Picture > Load Settings** menu). The following four modes are available for each input, with preset values suitable for various projection purposes:

- Dynamic
- Standard
- Theater 1
- Theater 2

You also can customize the picture settings by adjusting the functions in the Picture menu, and save those settings as USER MEMORY 1, 2, or 3. For more information, refer to [p.27](#).

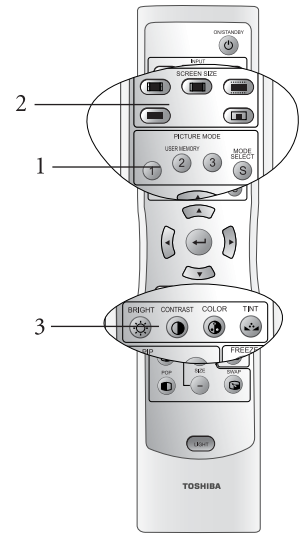

2. Selecting a Screen Size

The aspect ratio is the ratio of image width to image height. HDTV and most DVDs are 16:9, which is the default for this projector. Most TV shows are 4:3.

Change the image ratio using the SCREEN SIZE buttons on the remote control (or in the **Display > Screen Size** menu). Select an aspect ratio to suit the format of the video signal. The following five aspect ratios are available:

In the pictures below, the black portions are active areas and the white portions are inactive areas.

<p>1. Full: Scales an image so that it is displayed in the center of the screen in 16:9 aspect ratio. This mode is best for squeeze-signal video images.</p>	<p>4. Theater Wide®: A 4:3 aspect ratio image is enlarged NON-linearly in horizontal direction to accommodate 16:9 full-screen display. This stretches only the right and left sides of the image; the central part is unchanged. This mode is best for 4:3-signal video images displayed on a wide screen.</p>
<p>2. 4:3: Scales an image so that it is displayed in the center of the screen in 4:3 aspect ratio. This mode is best for 4:3-signal video images displayed on a 4:3 size screen.</p>	<p>5. Through: Projects the input signal in its original size (without any scaling), with the image displayed at the center of the screen.</p>
<p>3. Zoom: Enlarges an image with letterbox format to display it in full-screen format in 16:9 aspect ratio. The upper and lower portions of the image are cropped. Use this setting for Cinemascope and Vista video wide-screen formats.</p>	

Notes

Using these functions to change the size of the displayed image (i.e. changing the height/width ratio from the original) for purpose of public display or commercial gain may infringe on copyright laws.

3. Other adjustments

You can adjust Brightness, Contrast, Color, and Tint settings in the **Picture** menu or with the remote control. Refer to [p.26](#) for more information.

 Some picture adjustments are available only when certain input ports are in use. Adjustments that are not available are not shown on the screen.

Personalizing the projector menu display

The on-screen display (OSD) menu can be set according to your preferences.

- The **Language** feature in the **Setup** menu allows you to choose the language for on-screen menus.
- The **Background Color** in the **Options** menu allows you to choose a grey, black, or blue.
- The **OSD Off (Secs)** feature in the **Options** Menu allows you to set the length of time the OSD (in seconds) that the OSD will remain on-screen after your last button press.
- The **Sleep Timer (Min)** feature in the **Options** menu allows you to set the length of time (in minutes) before the projector will perform auto-shutdown.
- The **OSD Position H** and **OSD Position V** features in the **Options** menu allows you to adjust the on-screen position of the OSD.

Saving and loading the video memory

- Press the PICTURE MODE selection buttons on the remote control (or **MEMORY ▲** on the projector) to recall the settings directly.
- There are 3 user memories stored according to your preference.
- For information about saving user memories, refer to [p.29](#).

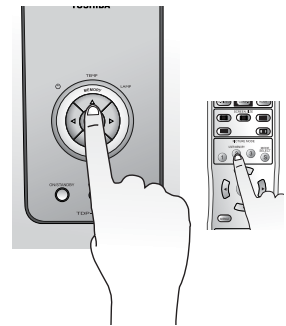

Using PIP (Picture-In-Picture) and POP (Picture-On-Picture) functions

There are two groups of inputs classified according to their display modes:

Video Group: Video, and S-Video inputs.

Graphic Group: Component 1, Component 2 (BNC), GBRHV (BNC), and HDMI™ inputs.

The PIP function allows the projector to display one input from the Graphic Group within one input from the Video Group (Graphic on Video), or display one input from Video Group within one input from the Graphic Group (Video on Graphic).



The POP function allows the projector to display one input from the Graphic Group and one input from the Video Group side by side (Video by Graphic or Graphic by Video).

If you want to view two images from 2 different input signals at the same time, refer to the following steps.

1. Select one input source by pressing one of the INPUT buttons on the remote control to display the first image.
2. Press the **PIP** or **POP** button on the remote control.

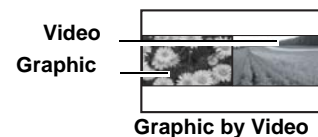

3. Select the second signal input from the **Display > PIP** or **Display > POP** menu.
4. You can press the **SWAP** button on the remote control repeatedly to switch the corresponding positions of the two windows, .
5. Between the two images, the bigger one of PIP or the left one of POP is always the active window. You can change the input signal settings in the active window only.
6. To adjust the size of the PIP window, press + or -.
7. To adjust the position of the PIP window, press the ARROW buttons (▲/◀/▼/▶).
8. To turn off the PIP or POP function, push **PIP** or **POP** button again.

PIP ---

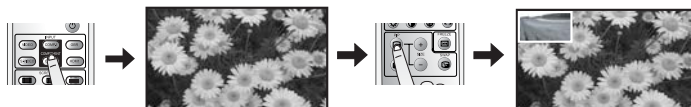

POP ---

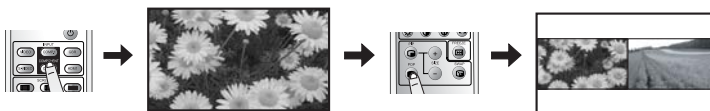

- If the selected input signal is not available, the image will be black.
- If you are using this function on commercial video software or on a broadcast or cable broadcast except for the purpose of your private viewing and listening, it may infringe the copyright protected by the copyright laws.
- When the PIP/POP function is activated, some of the Faroudja functions may not be available.

Pausing the picture

To pause the picture, press the **FREEZE** button on the remote control. Pressing the **FREEZE** button again cancels the freeze function.

- The icon  will appear while Freeze is in effect.
- Even if an image is frozen on the screen, the pictures are running on the video or other device. If the connected devices have active audio output, you will still hear the audio even though the image is frozen.
- Using the Freeze function on commercial video software or on a TV or cable broadcast for any purpose other than your private viewing may be prohibited under the Copyright Laws of the United States and other countries, and may subject you to civil and criminal liability.

Turning the power off

Follow the steps below.

1. Press the **ON/STANDBY** button on the projector or remote control. A confirmation message will appear. To turn off the projector, press **ON/STANDBY** again.
 2. The Power indicator light will flash green and the fans will run for about two minutes to cool the lamp. The projector will not respond to any commands until the cooling process is complete.
 3. The Power indicator light will be a solid (non-flashing) orange when the cooling process has finished and fans stop.
 4. If the projector will not be used for an extended period, turn off the main power switch and unplug the power cord from the power outlet.
- If you accidentally press the **ON/STANDBY** button and do not want to turn off the power, wait until the confirmation message disappears.

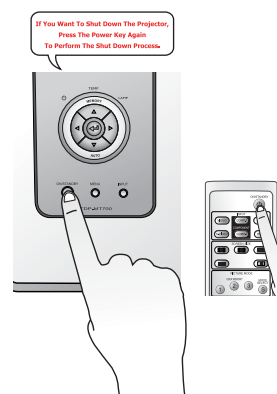

Menus

Menu structure

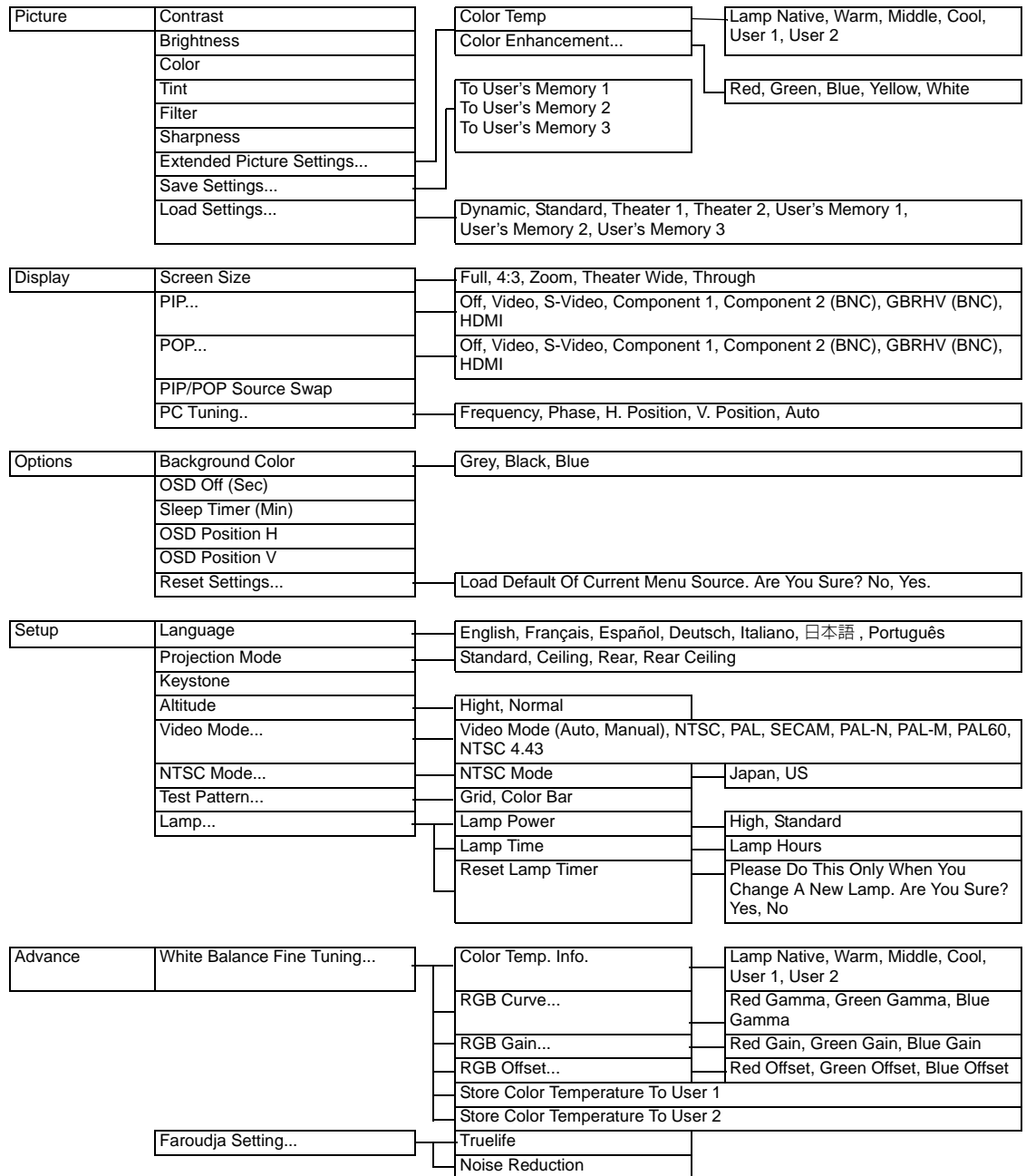

Using the menus

The projector is equipped with on-screen display (OSD) menus for making various adjustments and settings. There are several OSD languages provided for your selection. Refer to [p.28](#) for more information about the available languages. The following example describes how to correct the keystone distortion.

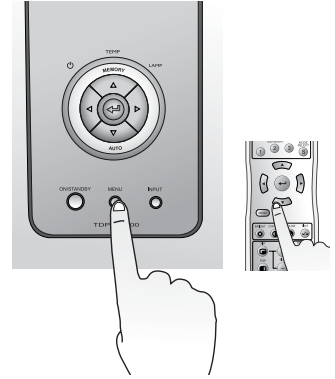

1. Press the **MENU** button to display the on-screen menu.



2. Use **◀** or **▶** to highlight **Setup** and then press **MENU**.



3. Use **▲** or **▼** to select **Keystone**.



4. Adjust the keystone values by pressing **◀** or **▶**.



5. Press the **MENU** button twice* to save the settings and close the OSD.

*The first press leads you back to the submenu and the second press closes the on-screen menu.

Picture menu



The functions provided in this menu allow you to manually adjust image quality. Before making adjustments, try one of the default modes (Dynamic, Standard, Theater 1, or Theater 2). These modes have preset values for various lighting environments and presentation purposes.

1. **Contrast:** Adjusts the degree of difference between dark and light in the image. The higher the number, the greater the contrast.

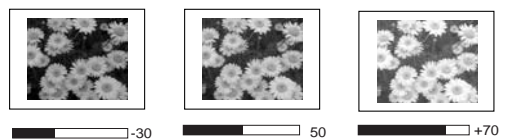

2. **Brightness:** Adjusts the brightness of the image. The higher the number, the brighter the image. The lower the value, the darker the image. Adjust this control so the black areas of the image appear as black as possible and that the detail in the dark areas is visible.



3. **Color:** Increases or decreases the color intensity of the image. The higher the value, the more vivid and brighter the color.
4. **Tint:** Adjusts the color tones of the image. The higher the value, the more greenish the picture becomes. The lower the value, the more purplish the picture becomes.
5. **Filter:** Turns the video and data filters on or off. Filters can reduce picture noise to produce a sharper image. The higher the setting, the less the noise.
6. **Sharpness:** Adjusts the picture sharpness. The higher the number, the sharper the picture.
7. **Extended Picture Setting**
 - **Color Temp:** You can choose a preferred color temperature from among Lamp Native, Warm, Middle, Cool, User 1, and User 2. Refer to [p.29](#) for more information about storing the color temperature to User 1 and 2.
 - **Color Enhancement**
 - Red:** Adjusts red hues independently. The higher the setting, the greater the intensity of red color in the image.
 - Green:** Adjusts green hues independently. The higher the setting, the greater the intensity of green color in the image.
 - Blue:** Adjusts blue hues independently. The higher the setting, the greater the intensity of blue color in the image.
 - Yellow:** Adjusts yellow hues independently. The higher the setting, the greater the intensity of yellow color in the image.
 - White:** Adjusts white peaking.
8. **Save Settings:** There are three video memories in which users can store settings, including all of the items in the **Picture** menu. Each input source can store up to 3 sets of User Memories.
 - To store the settings:
 - i.) Adjust the items in the **Picture** menu to your desired values.
 - ii.) Select **Save Settings** and then press .
 - iii.) Select To User's Memory 1, To User's Memory 2, or To User's Memory 3 and press  to store the settings.
 - iv.) To close the OSD, press **MENU**.
9. **Load Settings:** Loads the settings from one of three User Memories or one of four default settings (Dynamic, Standard, Theater 1, or Theater 2).

Display menu

Use this menu to set the way that the projector displays the picture.

1. **Screen Size:** Selects the aspect ratio for displaying different video signals. [p.22](#)
2. **PIP:** Selects a second input signal for displaying a second image.
3. **POP:** Selects a second input signal for displaying a second image.
4. **PIP/POP Source Swap:** Toggles the active window between the two images. (You can make adjustments to the active window only.)
5. **PC Tuning:** The following settings are only available when a PC or RGB signal is selected.
 - **Frequency:** Adjusts the frequency of the sampling clock that captures the input signal.
 - **Phase:** Adjusts the phase of the sampling clock.
 - **H. Position:** Adjusts the horizontal position of the image.
 - **V. Position:** Adjusts the vertical position of the image.
 - **Auto:** Adjusts the phase, and frequency automatically.

Options menu

Use this menu to adjust the global settings for the projector.

1. **Background Color:** Allows you to choose the color of the background screen that will display when there is no input signal detected.
2. **OSD Off (Secs):** Sets the length of time the OSD will remain active after your last button press. The range is from 5 to 60 seconds.
3. **Sleep Timer (Min):** Sets the auto-shutdown timer. The timer can be set to a value between 10 minutes and 3 hours.
4. **OSD Position H:** Adjusts the horizontal position of the OSD.
5. **OSD Position V:** Adjusts the vertical position of the OSD.
6. **Reset Settings:** Returns all settings to the factory preset values.

Setup menu

Use this menu to adjust basic image setup functions.

1. **Language:** Sets the language for the OSD menus. There are seven languages available, English, French, Spanish, German, Italian, Japanese, and Portuguese.
2. **Projection Mode:** The projector can be installed on a ceiling or behind a screen, or with one or more mirrors. You can choose from four settings. Contact your dealer for the ceiling mounting bracket if you need to install the projector on a ceiling. [p. 15](#)
3. **Keystone:** Corrects for trapezoidal distortion resulting from the angle of projection. It can provide correction of up to ± 12 degrees.
4. **Altitude:** Set the Altitude to High when you use the projector in an area higher than 3000 feet in altitude or when the ambient temperature is higher than 40°C (100°F).
Note: Operating the projector in "High" mode may cause louder fan noise because of increased fan speed necessary to improve overall cooling system and performance.
If the projector is used in any extreme environment (including those listed above), the projector may begin auto shut-down to prevent overheating. If this happens, try setting the Altitude feature to High. If this does not solve the problem, shut down the projector.
Note: This projector was not designed to operate in all harsh or extreme environments.
5. **Video Mode:** When you set the Video Mode to **Auto**, the projector will automatically identify the input signal type. If it fails, set the Video Mode to **Manual** and select a system from the list.
6. **NTSC Mode:** If your residential area is using the NTSC system, set the your location as Japan or US.
7. **Test Pattern:** Use the **Display** menu **Test Pattern** feature when installing the projector without an input signal, to help you adjust the image size and focus. The test pattern will display in the aspect ratio setting of the Screen Size.
8. **Lamp**
 - Lamp Power: Select **High** lamp power to project brighter images.

 **Using the High lamp power setting will decrease the life of the lamp faster than using the Standard setting.**

- Lamp Time: Displays [**Lamp Time**] as a measure of when the lamp time should be replaced. (Cannot be used as a counter of guaranteed lamp time.) When the displayed time approaches 2,000 hours, consult with a store about getting TLPLMT70 replacement lamp (sold separately) prepared.
- Reset Lamp Timer: Resets the lamp timer. This should only be done after the lamp has been replaced.

Advanced menu

1. **White Balance Fine Tuning:** Adjusts the white color.
 - Color temperature information: shows the current color temperature.

*About color temperatures:

There are many different shades that are considered to be “white” for various purposes. One of the common methods of representing white color is known as the “color temperature”. A white color with a low color temperature appears to be reddish white. A white color with a high color temperature appears to have more blue in it.

- RGB Curve...--- Adjusts the display characteristic of Red, Green, and Blue.
- RGB Gain... --- Adjusts the contrast levels of Red, Green, and Blue.
- RGB Offset... --- Adjusts the brightness levels of Red, Green, and Blue.

To store Color Temperature to User 1 and 2:

- i.) Open the **Advanced** menu, select **White Balance Fine Tuning > RGB Gain**, and press .
- ii.) Press **▲** or **▼** to select the item to be changed and then adjust the value with the **◀** or **▶** button.
- iii.) Press **MENU** to save the settings and close the menu.
- iv.) Repeat steps ii and iii to set RGB Offset and RGB Curve values.
- v.) Select and enter “Store Color Temperature to User 1” or “Store Color Temperature to User 2” to save the your settings.
- vi.) Press **MENU** to save the settings and close the menu.

To make the color temperature higher:

Set the value of **B Gain** higher, and the value of **R Gain** lower.

To make the color temperature lower:

Set the value of **R Gain** higher, and the value of **B Gain** lower.

2. Faroudja Setting

- **Truelife:** Enhances uneven edges, for example, without highlighting outlines on skins.
- **Noise Reduction:** Reduces electrical image noise. The higher the setting, the less the noise.

Additional information

Care of the projector

To care for your projector, clean the lens and projector case on a regular basis, following the instructions below.

 **Never remove any parts of the projector except the user-replaceable lamp. Contact your dealer if other parts need replacing.**

Cleaning the lens



WARNING

- Request cleaning and maintenance of a ceiling-mounted unit from your projector dealership. Attempting to clean/replace the lamp at a high site by yourself may cause you to drop down, thus resulting in injury.

Clean the lens whenever you notice dirt or dust on the surface.



CAUTION: HOT SURFACE! Before cleaning the lens, turn the projector off, unplug the power cord, and allow the projector to cool for at least 45 minutes.

1. Use a canister of compressed air to remove dust (available from building hardware or photographic suppliers).
2. If there is stubborn dirt or smudge marks, use a photographic lens brush or a clean, soft lens cloth (moistened with lens cleaner, if necessary) to gently wipe the lens surface.

 **NEVER touch the lens with your bare hands or rub the lens with abrasive materials (products such as paper towels can damage the lens coating). ALWAYS use a photographic lens brush or lens cleaning cloth and solution.**

NEVER attempt to clean the lens while the projector is on or while it is still hot from previous use.

Cleaning the projector case



CAUTION: HOT SURFACE! Before cleaning the lens, turn the projector off, unplug the power cord, and allow the projector to cool for at least 45 minutes.

1. To remove dirt or dust, wipe the case with a soft, dry, lint-free cloth.
2. If the soiling is severe, dip the cloth in a neutral detergent diluted in water, wring well, and gently wipe off the dirt, then finish up by wiping with a dry cloth.

 **Never use wax, alcohol, benzene, thinner, or other chemical detergents. These products can damage the case.**

Storing the projector

If you need to store the projector for an extended time, follow these guidelines:

1. Make sure the temperature and humidity of the storage area are within the recommended range for the projector. Please refer to the Specifications page in this manual or consult your dealer.
2. Retract the adjuster feet.
3. Remove the batteries from the remote control.
4. Pack the projector in its original packing (preferred) or equivalent packing materials.

Transporting the projector

Ship the projector in its original packing (preferred) or equivalent packing materials. If you carry the projector yourself, use a protective, non-abrasive carrying case.

About lamp

The product's light source is a mercury lamp that lights at increased internal pressure. Be sure to fully understand the following characteristics of the lamp and handle it with extreme care.

- The lamp may burst with a loud noise due to impact or deterioration, or fail to light at the expiration of its life.
- How long it takes before the lamp bursts or the life expires may vary greatly by lamp. Some may explode shortly after first use.
- Burst is likely to happen if the lamp is used after the replacement period has elapsed.
- When the lamp bursts, the broken pieces of glass may get inside the product or be released outside from the openings for ventilation.
- When the lamp bursts, a slight amount of mercury gas enclosed in the lamp along with glass dust may be released from the openings for ventilation.

■ Immediately replace the lamp when a sign appears on the screen.

- When the replacement time approaches, a message will appear on the screen.
- The risk of explosion will increase if the lamp is continuously used without being replaced.
- Frequently check the used hours and prepare spares when the replacement time approaches. (Refer to "Lamp Time" on [p. 28](#) .)

■ When the lamp is broken

- If glass components, including a lamp and a lens, should break, handle the broken pieces with care to avoid injury and contact your dealer for repair service.
- In the event of lamp burst, unplug the product from the wall outlet, leave and completely ventilate the room. Then, thoroughly clean the area around the projector and discard any edible items placed in that area.
- When the lamp bursts, consult a doctor if glass dust or mercury gas gets into your eyes or you breathe it.

Replacing the lamp



CAUTION: HOT SURFACE! The lamp may be very hot after use. Before replacing the lamp, turn off the projector, unplug the power cord, and allow the projector to cool for at least 45 minutes.

 **The lamp unit contains mercury. Disposal of mercury may be regulated due to environmental considerations. Dispose of the used lamp unit by the approved method for your area. Contact your local authorities or www.eiae.org.**

A lamp is consumable supplies. If used for extended periods, images will appear dark, and the lamp could burn out. This is characteristic of a lamp, and is not malfunction. (The lifetime of the lamp depends on condition of use.) If this happens, replace it with a new one.



WARNING

- If the projector is mounted on the ceiling, it is recommended to use your Toshiba dealership when the lamp has to be exchanged.
- When replacing, always use lamp "TLPLMT70" (sold separately).



CAUTION

- If you have been using the projector, the lamp will be very hot, and may cause burn injuries. Wait for the lamp to cool (for at least 45 minutes) before replacing it.
- If the lamp should break, please handle with care to avoid injury due to broken pieces and contact your dealer for repair service.

1. Turn off the power and unplug the power cord. Turn off all connected devices and disconnect all other cables.

2. Loosen the screws on the lamp cover.

 **The lamp door is on the side of the projector.**

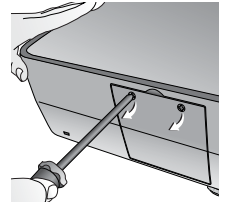

3. Remove the lamp cover.

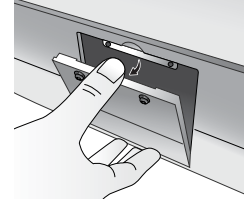

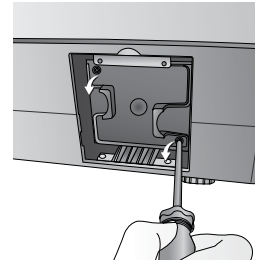

4. Loosen the screws that hold the lamp to the projector. It is strongly recommended that you use a magnetic-head screwdriver to prevent the screws from dropping inside the projector.



5. Slowly pull the lamp straight out of the projector.

 **Pulling it too quickly may cause the lamp to break and scatter broken glass in the projector. To reduce the risk of injuries to fingers and damage to internal components, use caution when removing lamp glass that has shattered.**

 **Do not place the lamp in locations where water might splash on it, where children can reach it, near or above heat sources, or near flammable materials.**

 **Do not insert your hands into the projector after the lamp is removed. Touching the optical components inside the projector can cause color unevenness and distortion of the projected images.**

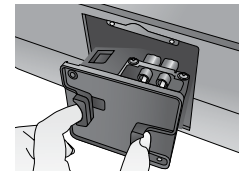

6. Insert a new lamp. Make sure it is securely in place.

7. Tighten the screws securing the lamp box.

8. Reinstall the lamp cover.

9. Tighten the screws on the lamp cover.

 **Do not over-tighten the screws.**

 **Loose screws may cause a bad connection, which could result in malfunction.**

10. Turn the power on. Open the **Setup > Lamp > Reset Lamp Timer** menu to reset the lamp time.

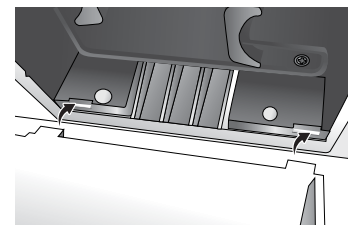

 **Do not turn the power on with the lamp cover removed.**

 **Whenever the lamp is replaced, reset the total lamp operation time.**

 **Do not reset the lamp time if the lamp is not replaced, as this could cause damage.**

Indicator lights

The front of the projector has three lights that indicate its status. Check the following for information about the indicator lights. If an abnormal condition is indicated, turn off the projector and contact your dealer.

When the projector is in a normal state:

POWER	TEMP	LAMP	State	Remark
Orange	Off	Off	Standby mode.	---
Flashing Orange	Off	Off	The projector is powering up.	Cannot turn off the projector.
Green	Off	Off	The projector is under normal operation.	---
Flashing Green	Off	Off	(1) The projector needs 110 seconds to cool down, as it was abnormally shut down without the normal cooling down process. Or (2) The projector needs to cool down for 110 seconds after the power is turned off.	Cannot turn on the projector.

When the projector is in an abnormal state:

POWER	TEMP	LAMP	State	Remark
Orange	Off	Red	(1) The lamp has exceeded its usage life. Or (2) The lamp is not properly attached or is damaged.	Solution: <ul style="list-style-type: none"> • Install a new lamp. • Please contact your dealer for assistance.
Orange	Red	Off	The internal temperature is too high. <ul style="list-style-type: none"> • The intake ventilation or the exhaust ventilation is blocked. • The projector may be in a poorly ventilated location. • The ambient temperature may be too high. 	Solution: <ul style="list-style-type: none"> • Make sure the ventilation holes are not blocked. • Relocate the projector. • Stop using the projector until the ambient temperature falls within the specified range. The maximum operating temperature is specified as 35°C (95°F).
Orange	Flashing Red	Flashing Red	The fans are not working.	Solution: <ul style="list-style-type: none"> • Make sure the power supply is stable. • Check if there is an object stuck in the fans. • Contact your dealer.

Troubleshooting

Problem	Cause	Remedy
The projector does not turn on.	There is no power from the power cord.	Plug the power cord into the AC inlet on the rear of the projector, and plug the power cord into to a power outlet. If the power outlet has a switch, make sure it is switched on. p. 20
	The power switch is not in the ON position.	Put the power switch in the ON position. p. 20
	Attempting to turn the projector on again during the cooling process.	Wait until the cooling-down process is completed.
	The lamp cover is not securely attached.	Correctly attach the lamp cover. p. 31
No picture.	The video source is not turned on or connected correctly.	Turn the video source on and check that the signal cable is connected correctly. p. 18
	The projector is not correctly connected to the input source device.	Check the connection. p. 18
	The input signal has not been correctly selected.	Select the correct input signal with the INPUT buttons on the remote control or INPUT on the projector. p. 20
Image is unstable.	The connection cables are not securely connected to the projector or the signal source.	Correctly connect the cables to the appropriate terminals. p. 18
Picture is blurred.	The projection lens is not correctly focused.	Adjust the focus of the lens using the focus ring. p. 21
	The projector and the screen are not aligned properly.	Adjust the projection angle and direction as well as the height of this unit if necessary. p. 21
	The lens cap is still attached to the lens	Remove the lens cap. p. 20
Remote control does not work correctly	The batteries are out of power.	Replace both of the batteries with new ones. p. 11
	There is an obstacle between the remote control and the projector.	Remove the obstacle. p. 13
	You are too far away from the projector.	Stand within 8 meters (26.2 feet) of the projector. p. 13

Specifications

Optical characteristics

Projection system	Single-chip DLP™ system.
DMD chip	0.8 in. DMD 720P (1280 x 720)
Lens	1.35-times zoom ratio, F/# 2.4 ~ 2.8, f = 24 ~ 32
Projection size	37 to 300 in. (0.94 m to 7.62 m)
Lamp	250W

Electrical characteristics

Color system	NTSC / PAL-M / PAL-N / PAL 60 / SECAM
Resolution	XGA, SVGA, VGA, Macintosh®, 1080i, 720p, 576p, 576i, 480p, 480i
Max. number of display colors	16,770,000 colors (full color display)

Input

Video, S-Video, Component (Y/ CB/ CR, Y/ PB/ PR)

RS-232C, RGBHV, HDMI™

General characteristics

Weight	12 lbs (5.65 kg)
Power	AC 100 - 240V, 4.0 A, 50 / 60 Hz (Automatic)
Power consumption	Max 320 W
Operating temperature	5 °C to 35 °C (41°F to 95°F) (0 ~ 3000 feet)
Operating humidity	10% to 90% (without condensation)
Storage temperature	-10°C to 60°C (14°F to 140°F)
Storage humidity	10% to 90%

Note

- This model complies with the above specifications.
- Designs and specifications are subject to change without notice.
- This model may not be compatible with features and/or specifications that may be added in the future.

■ Separately sold product

Replacement Lamp Model Model TLPLMT70

Dimensions

14.41 in. W x 5.28 in. H x 12.24 in. D (366 mm W x 134 mm H x 311 mm D)

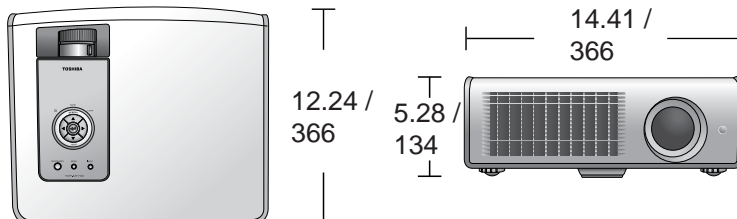

Unit: in / mm

Control terminal

Pin assignment

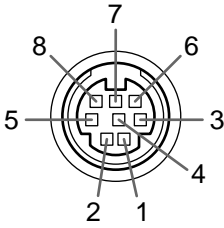

Mini DIN 8 pin connector

Pin No.	Signal Name	Description
1	RD	Receiving data
2	CTS	Consent to send
3	DSR	Data set ready
4	GND	Signal ground
5	RTS	Request to send
6	12V trigger	Screen trigger. The projector outputs 12 Voltage after power-on.
7	TX	Sending data
8	NC	No connection

Interface format

1 Communication method

RS-232C, 9600bps, No Parity, Data Length: 8 bits;
Stop Bit Length: 1 bit

2 Communication format

Command (5Byte)	CR (0Dh)
-----------------	----------

Only 1 command valid per communication.

If commands are to be sent consecutively, wait for the response from the projector before sending the next command.

Main Commands

Item	Command
Power on/off	X001X
Full	X061X
4:3	X062X
Zoom	X063X
Theater Wide	X064X
Through	X065X
Video	X131X

Item	Command
S-Video	X132X
GBR-HD	X133X
HDMI™	X134X
Component 1	X139X
Component 2	X140X

 Contact your dealer for control cable and other commands.