FCC Warning

This equipment has been tested and found to comply with the limits for a Class B digital device, pursuant to part 15 of the FCC Rules. These limits are designed to provide reasonable protection against harmful interference in a residential installation. This equipment generates, uses and can radiate radio frequency energy and, if not installed and used in accordance with the instructions, may cause harmful interference to radio communications. However, there is no guarantee that interference will not occur in a particular installation. If this equipment does cause harmful interference to radio or television reception, which can be determined by turning the equipment off and on, the user is encouraged to try to correct the interference by one or more of the following measures:

- Reorient or relocate the receiving antenna.
- Increase the separation between the equipment and receiver.
- Connect the equipment into an outlet on a circuit different from that to which the receiver is connected.
- Consult the dealer or an experienced radio/TV technician for help.

Canada

This Class B digital apparatus complies with Canadian ICES-003.
Cet appareil numérique de la classe B est conforme à la norme NMB-003 du Canada.

Safety Certifications

UL, CUL, TÜV, NOM, IRAM, GOST

Declaration of Conformity

Manufacturer: Toshiba Corporation

1-1, Shibaura 1-Chome, Minato-ku, Tokyo, Japan

We declare under our sole responsibility that the TDP-MT5 projector conforms to the following directives and norms:

EMC Directive 89/336/EEC, Amended by 93/68/EEC

EMC: EN 55022

EN 55024

EN 61000-3-2

EN 61000-3-3

Low Voltage Directive 73/23/EEC, Amended by 93/68/EEC

Safety: EN 60950: 1992 + A1 + A2 + A3 + A4: 1997

November, 2001

Trademarks

Apple, Macintosh, and PowerBook are trademarks or registered trademarks of Apple Computer, Inc. IBM and PS/2 are trademarks or registered trademarks of International Business Machines, Inc. Microsoft, PowerPoint, and Windows are trademarks or registered trademarks of Microsoft Corporation. Digital Light Processing is a trademark or registered trademark of Texas Instruments. Faroudja is a trademark or registered trademark of Faroudja Laboratories, Inc.

TABLE OF CONTENTS

Safety Instructions	iii
Introduction	I
Image Resolution	1
Compatibility	1
Unpacking the Projector	1
Usage Guidelines	4
If You Need Assistance	4
Setting up the Projector	5
Connecting the Enhanced Connectivity Module	7
Connecting a Video Device	9
To watch regular TV	11
To watch a DVD or VHS tape	15
To watch HDTV	19
To play a video game	21
To connect a camcorder	21
Turning Off the Projector	22
Connecting a Computer	23
Displaying your Computer Source	24
Turning Off the Projector	26
Using the Projector	27
Basic Image Adjustment	27
Adjusting the Projector	27
Using the Remote Control	29
Using the Keypad and Remote Buttons	30
Using the On-Screen Menus	33
Display Menu	34
Audio Menu	36
Image Menu for Video Sources	37
Image Menu for Computer Sources	42
Color Management Menu	44
Control Menu	45
Advanced Menu	46
Language Menu	47
Status Menu	48



Maintenance & Troubleshooting	49
Cleaning the Lens	49
Replacing the Projection Lamp	49
Cleaning the Projection Lamp Filter Screens	52
Replacing the Batteries in the Remote Control	53
Troubleshooting	54
Appendix	61
Specifications	61
Accessories	62
Audio/video inputs on the Enhanced Connectivity Module	63
Projected Image Size	64
Index	67

SAFETY INSTRUCTIONS

It is important you read this instruction Manual (USER'S GUIDE) before using your DLP Projector to insure its proper and safe operation.

All of the Safety Instructions that are contained in this Manual must be read carefully and must be fully understood before you attempt to use your DLP Projector in order to avoid potential hazards that could cause bodily injury or property damage, or could result in damage to your DLP Projector.

There are two categories of Safety Instructions included in this manual:

- Product Warnings, (i.e. what must never be done to assure avoiding those hazards that could cause bodily injury or property damage);
- User Directions, (i.e. what must always be done to assure the safe use of your DLP Projector).

The Safety Instructions contained in this Manual have been categorized in accordance with the seriousness of the potential hazards through the use of Signal Words. Those Signal Words, and their intended meanings, are as follows:

WARNING: Indicates that a failure to observe the Safety Instructions could result in serious bodily injury.

CAUTION: Indicates that a failure to observe the Safety Instructions could result in minor bodily injury or property damage.

NOTE: Designates important information that relates to activities and/or conditions that might result in damage to your DLP and/or voiding of the Toshiba limited warranty.

Safe Use And Operation Of Your DLP Projector

WARNING

- Never look directly into the projector lens when the lamp is turned on. The projector light could cause injury to your eyes.

WARNING

- Never attempt to replace the lamp before turning off the projector and unplugging the power cord. Always wait 30 minutes or more after the projector is turned off and unplugged before opening the lamp door. Failure to follow these instructions could result in burns, electric shock and/or other serious bodily injury.

WARNING

- Never use a power cord other than the one provided with your DLP projector. Always use a Toshiba authorized power cord. Failure to use a Toshiba authorized power cord could result in fire and/or electric shock.
- Never attempt to modify or alter the power cord or plug. If the plug will not fit into the available outlet, always have a proper outlet installed by a qualified electrician. Improper connection can result in the risk of electric shock and/or fire.
- Never use a power cord or plug if it has been damaged or worn. The use of damaged or worn power cords or plugs could result in electric shock, burns or fire.
- Never connect or disconnect the power cord or plug with wet hands. Connecting or disconnecting the power cord to a power source with wet hands could result in an electric shock.
- Always unplug the power cord and plug from the power source before attempting any cleaning of your DLP Projector in order to avoid the risk of electric shock. Always use a soft dry cloth to clean the equipment, after it has been unplugged.

CAUTION

- Always locate the power cord so that it will not be stepped on, tripped over, or otherwise subjected to damage or stress.
- Never place heavy objects on a power cord as this could damage result in damage to the cord.

-
- Never bend or twist a power cord, and never pull on a power cord in an attempt to remove the power cord plug from a socket. Always grasp the plug directly when unplugging the power cord in order to avoid damaging the power cord.
 - Always ensure the power plug pins are clean and free of dust or other foreign material by wiping the pins with a clean dry cloth. Dust or other foreign material accumulation on the power plug pins could cause fire.
 - Always disconnect the power cord from the power source when it is not in use.

NOTE

- Never allow any repairs or service to your DLP Projector by anyone other than an authorized Toshiba Service representative unless specifically instructed in this manual. Repair or service by an unauthorized person will void the Toshiba limited warranty.
- Never expose your projector to prolonged exposure to smoke. This could result in damage to your projector.
- Never set containers containing water or any other liquid on your DLP Projector. Spilled liquids could damage your projector.
- Always transport your DLP Projector in a Toshiba-approved carrying case; refer to your Toshiba dealer for more information.

WARNING

- Never block or restrict ventilation openings in your DLP Projector in any manner. Always ensure good ventilation. Blocking or impairing ventilation openings could result in fire and/or serious bodily injury and/ or damage to your projector.
- Never use a ceiling mount that is not authorized by Toshiba. The use of an unauthorized ceiling mount could impair or block ventilation openings.

- Never place your DLP Projector on a tablecloth or other soft surface. Placing your DLP Projector on a tablecloth or other soft surface could block or impair ventilation openings resulting in fire, bodily injury, and/or damage to the projector.
- Always thoroughly and immediacy clean the area around your projector in the unlikely event the projector lamp breaks. Never eat any food or other consumable items located in the area.

INTRODUCTION

The Toshiba TDP-MT5 multimedia projector is specifically designed for home theater applications. It generates crisp, clear images using Digital Light Processing™ (DLP) technology and Faroudja™ video processing. It is easy to connect, easy to use, easy to transport, and easy to maintain.

Image Resolution

The projector has a Dual Mode DMD that provides two resolutions: 848x480 for 16:9 format and 800x600 for 4:3 format (see page 9 for more information on video formats).

For computer sources, the SVGA resolution of the TDP-MT5's projected image is 800x600. The projector is compatible with screen resolutions up to 1024x768. If your computer's screen resolution is higher than 1024x768, reset it to a lower resolution before you connect the projector.

Compatibility

The projector is compatible with a wide variety of computers and video devices, including:

- Most standard VCRs, DVD players, HDTV sources, camcorders and laser disc players.
- IBM-compatible computers, including laptops, up to 1024x768 resolution.
- Apple® Macintosh® and PowerBook® computers up to 1024x768 resolution.

Unpacking the Projector

The projector comes with the items shown in Figure 1. Check to make sure all are included.

If you are experienced in setting up presentation systems, use the *Quick Start* card that was included in the shipping box. For complete details on connecting and operating the projector, refer to this User's Guide.

NOTE: The TDP-MT5 automatically expands 640x480 computer images to 800x600. You can display these images at their native resolutions by using the Resize feature. See "Resize" on page 42 for more information.

NOTE: The projector is compatible with 1080i, 1035i, and 720P HDTV formats.

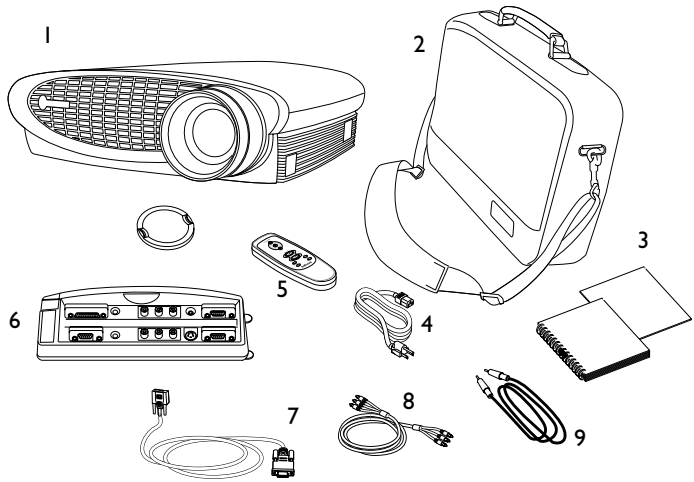

FIGURE I

Shipping box contents

- | | |
|--------------------------------------|---------------------------------|
| 1. Projector + lens cap | 6. Enhanced Connectivity module |
| 2. Soft carry case | 7. Computer cable |
| 3. User's Guide and quick start card | 8. Audio/Video (A/V) cable |
| 4. Power cord | 9. S-video cable |
| 5. Remote control | |

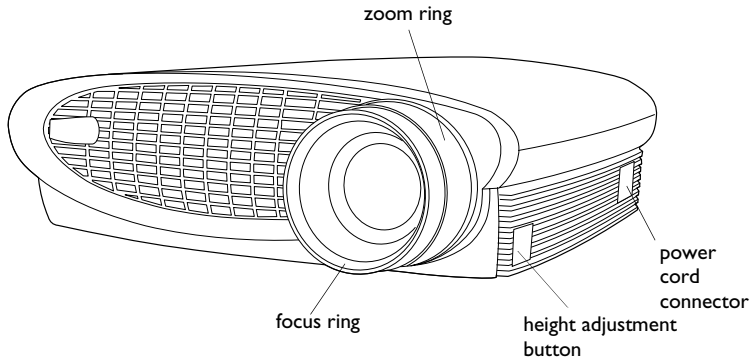

FIGURE 2

Front view of projector

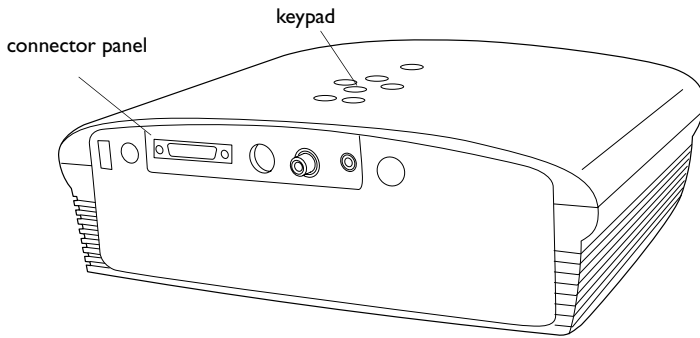

FIGURE 3

Back view of projector

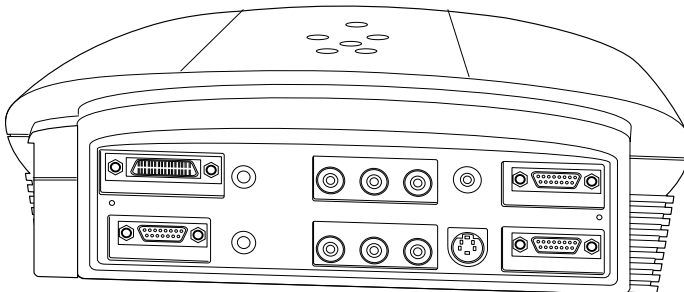

FIGURE 4

Back view of projector with Enhanced Connectivity Module attached

If You Need Assistance

The first place to look for help is in this manual. Be sure to check the guidelines in "Troubleshooting" on page 54. Please contact your Toshiba dealer for details.

SETTING UP THE PROJECTOR

There are a number a factors to consider when determining where to set up the projector, including the size and shape of your screen, the location of your power outlets, the distance between the projector and the rest of your equipment. But here are some general guidelines.

- 1 Position the projector on a flat surface at a right angle to the screen.
 - The projector must be within 10 feet (3 m) of your power source and within 6 feet (1.8 m) of your video device (unless you purchase extension cables).
 - If you are installing the projector on the ceiling, refer to the installation guide that comes with the Ceiling Mount Kit for more information. To turn the image upside down, see “Ceiling Project” on page 46. Toshiba recommends use of an authorized Toshiba ceiling mount. The Ceiling Mount Kit is sold separately.
- 2 Position the projector the desired distance from the screen.
 - The distance from the lens of the projector to the screen, the zoom setting, and the video format determine the size of the projected image. Figure 5 shows three projected image sizes in 16:9 format. For more information about image sizes at different distances and formats, see “Projected Image Size” on page 64.

NOTE: To ensure adequate cable access, do not place the projector within 6 inches (.15m) of a wall or other object.

NOTE: The projector must be at least 5.6 feet (1.7 m) from the projection screen.

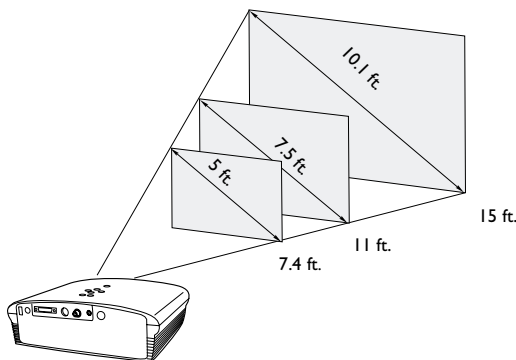

FIGURE 5

Projected image size at minimum zoom

The image exits the projector at a given angle. This image offset is 125.5% when the projector is in 16:9 mode (the default mode). This means that if you have an image 10' high, the bottom of the image will be 2.55' above the center of the lens.

The value is 113.7% for 4:3 mode.

WARNING: *Never place your Projector on a tablecloth or other soft surface. Placing your Projector on a tablecloth or other soft surface could block or impair ventilation openings resulting in fire bodily injury, and/or damage to the projector. Never use a ceiling mount that is not authorized by Toshiba. The use of an unauthorized ceiling mount could block or impair ventilation openings. Always thoroughly and immediately clean the area around your projector in the unlikely event the projector lamp breaks. Never eat any food or other consumable items located in the area.*

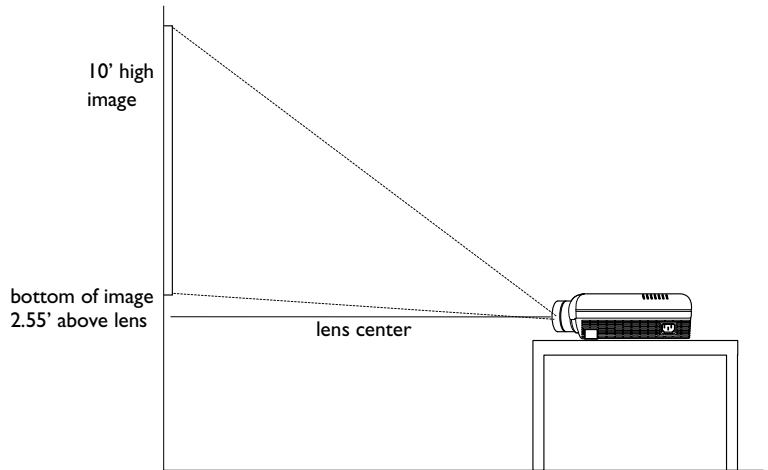

FIGURE 6

Projection angle in 16:9 mode

- 3** Make sure the projector is unplugged and your equipment is turned off.

Connecting the Enhanced Connectivity Module

The connector panel on the back of the projector looks like this:

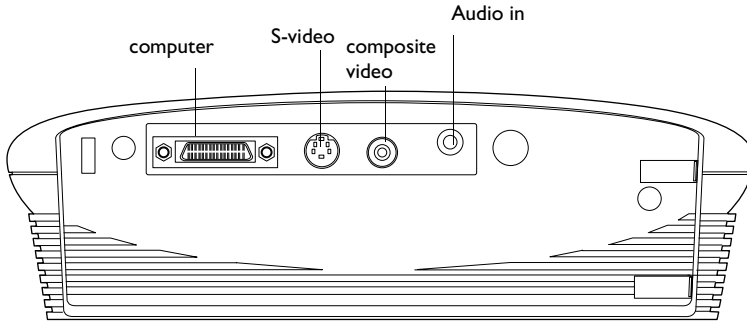

NOTE: Before you continue, make sure the projector is unplugged and your equipment is turned off.

FIGURE 7

Connector panel

The projector ships with an enhanced connectivity module. When you attach it to the back of the projector, it looks like this:

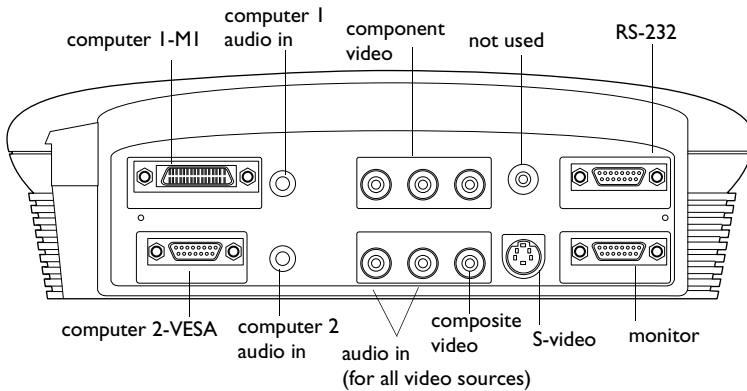

FIGURE 8

Connector panel with enhanced connectivity module attached

This module adds all the connectivity you need for your home theater applications.

NOTE: *If you have turned Auto Source off (page 45), you may need to press the source button on the keypad more than once to display an active source. The sources switch in this order: PC 1-Analog, PC 1-Digital, PC 2-Analog, Video 3-Component, Video 1 S-Video, and Video 2-Composite.*

The module connects to the projector via the projector's computer connector. Slide the tabs in the module into the grooves on the back of the projector, then press the computer connector into the projector. To remove the module, press down all the way on the textured lever on the top left of the module to release the latch, then slide the module off.

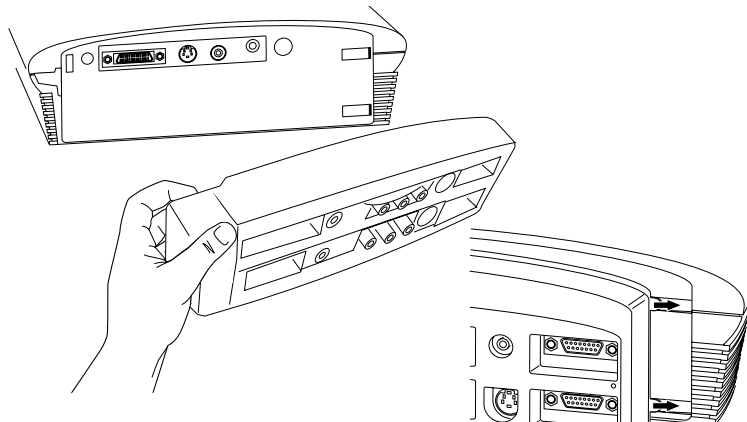

FIGURE 9

Connecting the connectivity module to the projector

CAUTION: *: Always unplug your projector before proceeding to connect the connectivity module to the projector.*

The module provides two computer and three video inputs (see page 63 for a list of sources and audio/video connectors). The module also provides monitor out (used to display images on your desktop computer's monitor as well as on the projection screen), and RS-232 input (to control the projector from an LCD control panel).

NOTE: *Monitor out is only available for analog computer, 480p, and HDTV sources.*

Connecting a Video Device

You can connect VCRs, DVD players, camcorders, digital cameras, video games, HDTV receivers, and TV tuners to the projector. There is an audio input. You can connect the audio directly to the projector to get sound from the 3-watt onboard speaker, or you can connect it to your stereo's receiver to get sound from your own speakers.

Before connecting your projector, you should decide which screen aspect you want to project. Screen aspect is the ratio of the image width to image height. TV screens are usually 1.33:1, also known as 4:3. HDTV and most DVDs are 1.78:1, or 16:9. If you're projecting onto a screen, the size/shape of the screen may answer this question for you. If you are projecting onto a blank wall, you don't have the screen size restriction. What you plan to project will also help you choose between 4:3 and 16:9. Most regular TV shows are 4:3, most movies are 16:9.

If you select 4:3 and play TV, the image will fill the screen. If you select 16:9 and play HDTV, the image will fill the screen. However, if you select 4:3 and play a 16:9 DVD, the image may be compressed horizontally or have black bars along the top and bottom (see Figure 10). If you select 16:9 and play regular TV, the image may be stretched horizontally or have black bars along the sides. You will make this selection later, using the onscreen menus (page 35), but for now, you just need to know which format you'll use most often.

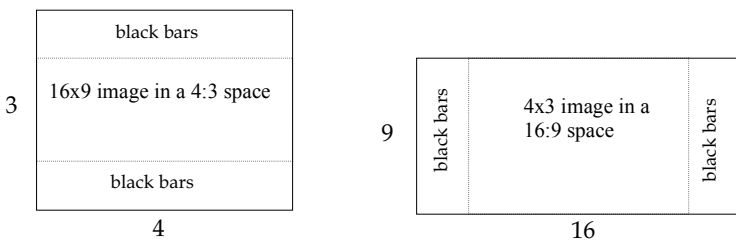

FIGURE 10

4:3 and 16:9 screen aspects

You can connect the projector to most video devices that can output video. You cannot directly connect the coaxial cable that enters your house from a cable or satellite company, the signal must pass through a tuner first. Examples of tuners are digital cable boxes, VCRs, digital video recorders, and satellite TV boxes.

Basically, any device that can change channels is considered a tuner.

The next step is to figure out what type of connectors/output the equipment you want to connect has. If there is more than one output, select the highest quality one. Component video has the best quality, followed by S-video, then composite video.

Here is a list of possible input signals and the connectors they should be connected to on the projector:

Input Signal	Connector	Connector Label on Projector	Source name on Screen
Standard Broadcast TV (not HDTV), via cable, digital cable, satellite TV, DirectTV	Composite video	video 2	Video 2-Composite
	S-video	video 1	Video 1-S-video
	Component Video	video 3	Video 3-Component
HDTV	Component video	video 3	Video 3-Component
	VGA	PC 2	PC2-Analog
	DVI	PC 1	PC1-Analog or PC1-Digital
DVD	Composite video	video 2	Video 2-Composite
	S-video	video 1	Video 1-S-video
	Component Video	video 3	Video 3-Component
VCR	Composite video	video 2	Video 2-Composite
	S-video	video 1	Video 1-S-video
Video Camera	Composite video	video 2	Video 2-Composite
	S-video	video 1	Video 1-S-video
Video Game	Composite video	video 2	Video 2-Composite
	S-video	video 1	Video 1-S-video

Here are the connection cables included with the projector:

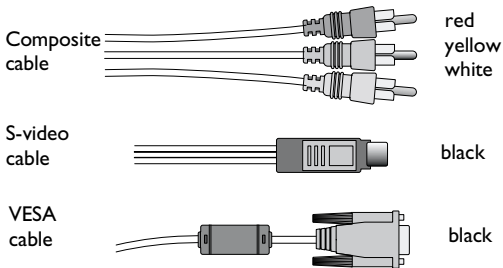

FIGURE 11

Cables included with the projector

To watch regular TV

Determine the cables you'll need (refer to the table on page 10 if necessary). This depends on what type of output is coming from the tuner (remember, you cannot directly connect the coaxial cable that enters your house from a cable or satellite company, the signal must pass through a tuner first.) Also, determine if you want the sound to come out of the projector or out of your own audio system. You can connect the audio directly to the projector to get sound from the 3-watt onboard speaker, or you can connect it to your stereo's receiver to get sound from your own speakers.

NOTE: *If needed, you can purchase longer cables at your local electronics store.*

If your TV tuner has S-video output:

- 1 Plug one end of the S-video cable to the "S-video out" connector on your tuner (Figure 12). This connector may be labeled "To Monitor."
- 2 Plug the other end of the cable into the S-video connector (labeled video 1) on the projector.

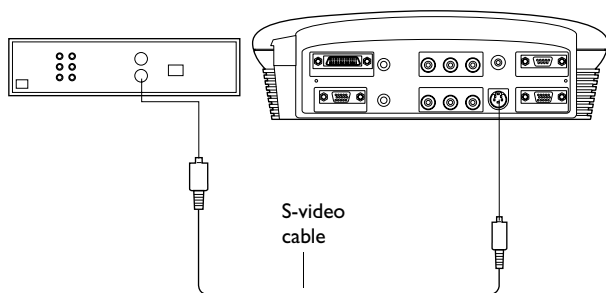

FIGURE 12

Connecting the projector to a TV tuner using the S-video cable

- 3 If you want sound from the projector's speaker, plug the A/V cable's white connector into the left "audio out" connector on your video device. Plug the cable's red connector into the right "audio out" connector on the video device (Figure 13).
- 4 Plug the A/V cable's other white connector into the white "audio L" connector on the projector. Plug the cable's other red connector into the red "audio R" connector on the projector. The yellow connectors on the A/V cable remain unused.

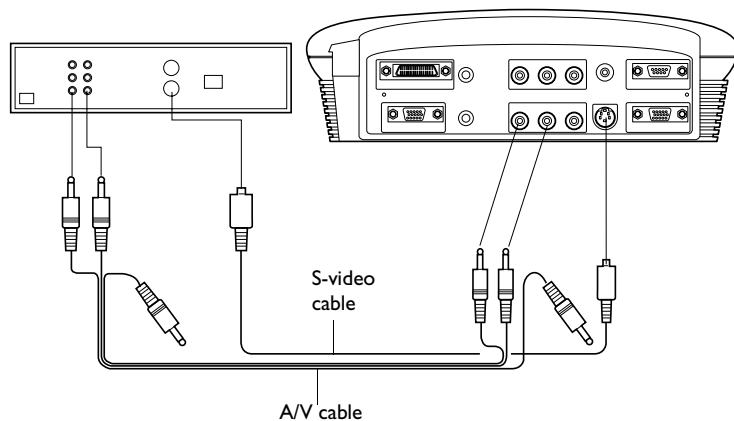

FIGURE 13

Connecting the projector to a TV tuner using the S-video cable and the A/V cable

- 5** Plug the power cord into the side of the projector, then plug it into your electrical outlet. A surge-protected power strip is recommended.
 - The LED on the top of the projector (Figure 24 on page 30) lights green.

Now you are ready to turn on the equipment and watch TV.

- 6** Remove the projector's lens cap.
- 7** Turn on the lamp by pressing the green **power** button on the keypad or remote.
 - A tone sounds when you press the button, and the LED blinks green while the software initializes. When initialization is complete, the LED lights solid green and the startup screen appears.

8 Turn on your TV tuner.

- The TV image should display on the projection screen. If it doesn't, press the **source** button on the keypad or the **video** button on the remote to display your TV image (press the button until "S-video" appears in the corner). You can select a default source to determine which source the projector examines first during power-up for active video; see "Default Source" on page 45.
- If necessary, adjust the height of the projector. See page 28.
- If necessary, adjust the zoom or focus of the image by turning the rings around the lens. See page 27.
- If you are projecting on a 4:3 screen, change the screen aspect to 4:3. See page 35.
- If necessary, make adjustments to the image using the projector's on-screen menus. To open the menus, press the **menu/select** button on the keypad or remote, then select the Display or Image sub-menu. For more information about the menus, see page 33.
- If the image is not square, use the keystone buttons on the remote to adjust the image's shape. See page 31.
- If you connected the audio cables to the projector, use the **volume** buttons on the keypad to adjust the volume. If you connected the audio cables from your video device to your receiver, use the receiver's volume control.

The projector is compatible with these major broadcast video standards: NTSC, NTSC 4.43, PAL, PAL-M, PAL-N, PAL-60, and SECAM. It automatically adjusts to optimize its performance for the incoming video. The input signals for SECAM, PAL-M, PAL-N, and PAL 60 video are similar to other video signals and cannot be automatically detected, therefore they must be chosen manually.

If your TV tuner has composite video output:

- 1 Plug the A/V cable's round yellow connector into the composite "video-out" connector on your video device (Figure 14). This connector may be labeled "To Monitor."
- 2 Plug the other yellow connector into the yellow composite connector (labeled video 2) on the projector.

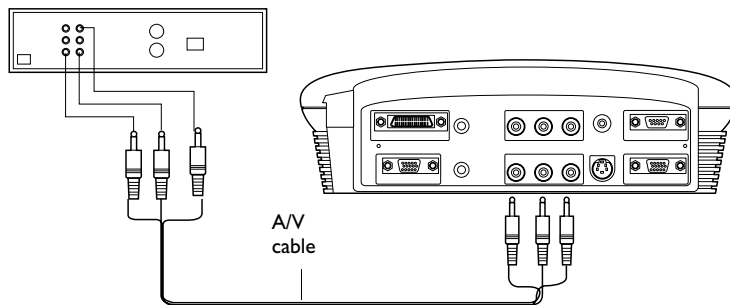

FIGURE 14

Connecting the projector to a TV tuner using the audio video (A/V) cable

- 3 If you want sound from the projector's speakers, plug the A/V cable's white connector into the left "audio out" connector on your video device. Plug the cable's red connector into the right "audio out" connector on the video device.
- 4 Plug the A/V cable's other white connector into the white "audio L" connector on the projector. Plug the cable's other red connector into the red "audio R" connector on the projector.
- 5 Follow steps 5-8 starting on page 12.

If your TV tuner has component video output:

Connect the component cables (not included) and audio cables to the appropriate connectors (labeled video 3) on the projector and on your video device. Your local electronics store should carry these cables.

To watch a DVD or VHS tape

Determine the cables you'll need. This depends on what type of output is coming from the video device. Also, determine if you want the sound to come out of the projector or out of your own audio system. You can connect the audio directly to the projector to get sound from the 3-watt onboard speaker, or you can connect it to your stereo's receiver to get sound from your own speakers.

If your video device has S-video output:

- 1 Plug one end of the S-video cable to the "S-video out" connector on your tuner (Figure 15). This connector may be labeled "To Monitor."
- 2 Plug the other end of the cable into the S-video connector (labeled video 1) on the projector.

NOTE: If needed, you can purchase longer cables at your local electronics store.

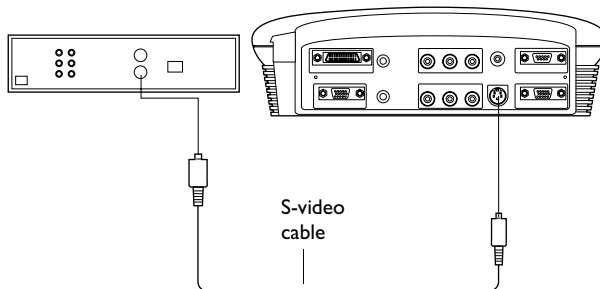

FIGURE 15

Connecting the projector to a video player using the S-video cable

- 3 If you want sound from the projector's speaker, plug the A/V cable's white connector into the left "audio out" connector on your video device. Plug the cable's red connector into the right "audio out" connector on the video device (Figure 13).
- 4 Plug the A/V cable's other white connector into the white "audio L" connector on the projector. Plug the cable's other red connector into the red "audio R" connector on the projector. The yellow connectors on the A/V cable remain unused.

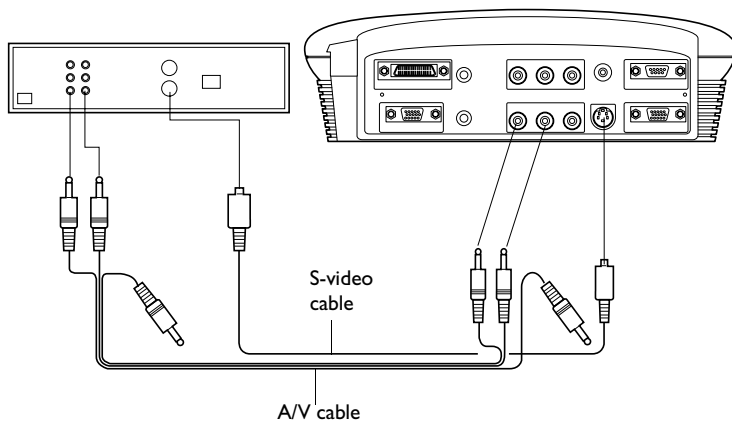

FIGURE 16

Connecting the projector to a video player using an S-video cable and the A/V cable

- 5** Plug the power cord into the side of the projector, then plug it into your electrical outlet. A surge-protected power strip is recommended.
 - The LED on the top of the projector (Figure 24 on page 30) lights green.

Now you are ready to turn on the equipment and watch a DVD or tape.

- 6** Remove the projector's lens cap.
- 7** Turn on the lamp by pressing the green **power** button on the keypad or remote.
 - A tone sounds when you press the button, and the LED blinks green while the software initializes. When initialization is complete, the LED lights solid green and the startup screen appears.

8 Plug in and turn on your video device.

- The video image should display on the projection screen. If it doesn't, press the **source** button on the keypad or the **video** button on the remote to display your video image. You can select a default source to determine which source the projector examines first during power-up for active video; see "Default Source" on page 45.
- If necessary, adjust the zoom or focus of the image by turning the rings around the lens. See page 27.
- If you are projecting on a 4:3 screen, change the screen aspect to 4:3. See page 35.
- If the image is not square, use the keystone buttons on the remote to adjust the image's shape. See page 31.

9 Insert the tape or disk you want to play, then start playing it. Some DVD start automatically, some require you to select Play Movie from the start menus screen.

- Select a different resize option, if desired. The choices are standard, widescreen letterbox, enhanced widescreen, and native. See page 42.
- If you connected the audio cables to the projector, use the **volume** buttons on the keypad to adjust the volume. If you connected the audio cables from your video device to your receiver, use the receiver's volume control.
- If necessary, make adjustments to the image using the projector's on-screen menus. To open the menus, press the **menu/select** button on the keypad or remote, then select the Display or Image sub-menu. For more information about the menus, see page 33.

If your video device has composite video output:

- 1 Plug the A/V cable's round yellow connector into the composite "video-out" connector on your video device (Figure 17). This connector may be labeled "To Monitor."
- 2 Plug the other yellow connector into the yellow composite connector (labeled video 2) on the projector.

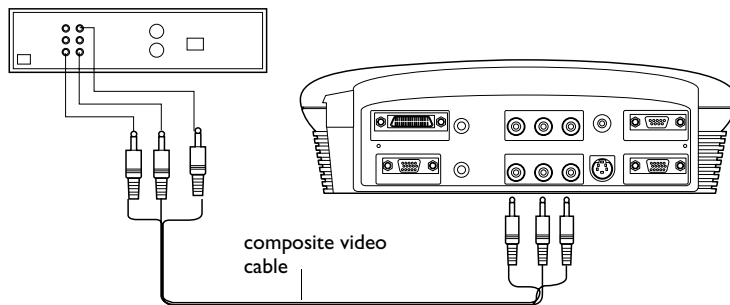

FIGURE 17

Connecting the projector to a video player using the audio video (A/V) cable

- 3 If you want sound from the projector's speaker, plug the A/V cable's white connector into the left "audio out" connector on your video device. Plug the cable's red connector into the right "audio out" connector on the video device.
- 4 Plug the A/V cable's other white connector into the white "audio L" connector on the projector. Plug the cable's other red connector into the red "audio R" connector on the projector.
- 5 Follow steps 5-10 starting on page 16.

To watch HDTV

Determine the cables you'll need. This depends on what type of output is coming from the tuner (remember, you cannot directly connect the coaxial cable that enters your house from a cable or satellite company, the signal must pass through a tuner first.) Also, determine if you want the sound to come out of the projector or out of your own audio system. You can connect the audio directly to the projector to get sound from the 3-watt onboard speaker, or you can connect it to your stereo's receiver to get sound from your own speakers.

If your HDTV tuner has a 15-pin VGA output:

- 1 Plug one end of the VESA cable to the VGA connector on your HDTV source (Figure 18). This connector may be labeled "To Monitor."
- 2 Plug the other end of the cable into the VESA connector (labeled PC 2) on the projector.

NOTE: If needed, you can purchase longer cables at your local electronics store.

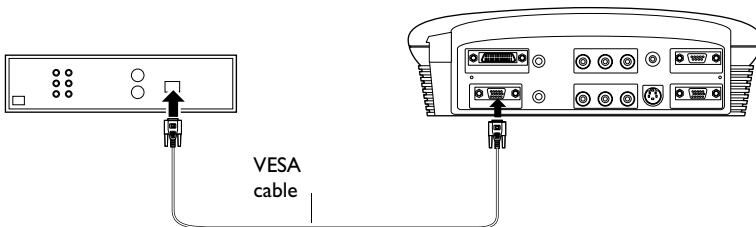

FIGURE 18

Connecting the projector to an HDTV source using the VESA cable

- 3 If you want sound from the projector's speaker, plug the A/V cable's white connector into the left "audio out" connector on your tuner. Plug the cable's red connector into the right "audio out" connector on the tuner.
- 4 Plug the A/V cable's other white connector into the white "audio L" connector on the projector. Plug the cable's other red connector into the red "audio R" connector on the projector. The yellow connectors on the A/V cable remain unused.

- 5 Plug the power cord into the side of the projector, then plug it into your electrical outlet. A surge-protected power strip is recommended.
 - The LED on the top of the projector (Figure 24 on page 30) lights green.

Now you are ready to turn on the equipment and watch HDTV.

- 6 Remove the projector's lens cap.
- 7 Turn on the lamp by pressing the green **power** button on the keypad or remote.
 - A tone sounds when you press the button, and the LED blinks green while the software initializes. When initialization is complete, the LED lights solid green and the startup screen appears.
- 8 Turn on your HDTV tuner.
 - The HDTV image should display on the projection screen. If it doesn't, press the **source** button on the keypad or the **video** button on the remote to display your HDTV image. You can select a default source to determine which source the projector examines first during power-up for active video; see "Default Source" on page 45.
 - If necessary, adjust the zoom or focus of the image by turning the rings around the lens. See page 27.
 - If you are projecting on a 4:3 screen, change the screen aspect to 4:3. See page 35.
 - If necessary, make adjustments to the image using the projector's on-screen menus. To open the menus, press the **menu/select** button on the keypad or remote, then select the Display or Image sub-menu. For more information about the menus, see page 33. If you want to return to the factory default settings, choose reset in the Advanced menu.
 - If the image is not square, use the keystone buttons on the remote to adjust the image's shape. See page 31.
 - If you connected the audio cables to the projector, use the **volume** buttons on the keypad to adjust the volume. If you connected the audio cables from your video device to your receiver, use the receiver's volume control.

If your HDTV tuner has a DVI or component output:

For DVI, connect an optional DVI cable into the connector labeled "PC 1". For component, connect an optional component video cable into the connector labeled "video 3". Follow the instructions in the previous section to connect and display these sources.

To play a video game

To play a game from a video machine:

Connect your equipment as described in "Connecting a Video Device" on page 9.

To play a video game from a computer:

Connect your equipment as described in "Connecting a Computer" on page 23.

To connect a camcorder

Connect your equipment as described in "Connecting a Video Device" on page 9.

Turning Off the Projector

If you want to turn off the projector for a short period of time, press the **standby** button on the keypad or remote. This blanks the screen for fifteen minutes, but keeps the projector running. (You can change the amount of time the projector stays in standby mode; see page 45 for details.) After 15 minutes, the lamp goes out. To exit standby mode, press the **standby** button again. (It may take several seconds for the projection lamp to reach full power and project the image again.) See page 32 for details on standby mode.

NOTE: *Lamp life will be extended if you turn the power off, then wait 1 minute while the lamp cools before unplugging the projector. The Lamp LED will light green when the lamp has cooled.*

To turn off the projector, press the **power** button (you can cancel the shutdown by pressing the **power** button again within 10 seconds). The lamp turns off and the LED blinks amber for a minute while the fans continue to run to cool the lamp. When the lamp has cooled, the LED lights green and the fans stop. Unplug the power cord to completely power off the projector.

Connecting a Computer

The projector ships with an analog VESA computer cable. If your computer has a digital output, you can order the optional digital M1 computer cable. Using a digital source generates the highest quality and brightest image possible.

- 1 Plug one end of the computer cable into the PC 2 connector on the projector.
- 2 Plug the other end of the computer cable into the video connector on your computer. If you are using a desktop computer, you need to disconnect your monitor cable from your computer first.

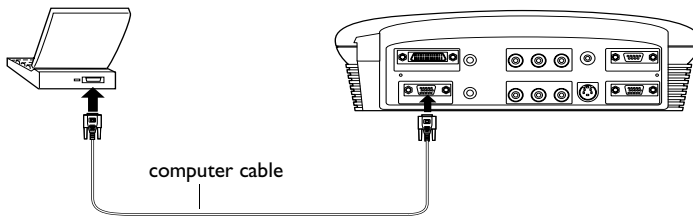

FIGURE 19

Connecting the projector to a computer

NOTE: Many laptop computers do not automatically turn on their external video port when a secondary display device such as a projector is connected. Refer to your computer manual for the command that activates the external video port.

Do you want to play your computer's audio on the projector?

- 1 Plug either end of an audio cable (not included) into the audio connector on your computer.
- 2 Plug the other end of the audio cable into the "audio in" connector on the projector.

Do you want to display the image on your desktop computer's monitor as well as on the projection screen?

- 1 Plug the monitor's cable into the "monitor out" connector on the projector.

Now you're ready to power up the projector and your computer.

WARNING: Never use a power cord other than the one provided with your LCD Projector. Always use a Toshiba authorized power cord. Failure to use a Toshiba authorized power cord could result in fire and/or electric shock.

Displaying your Computer Source

- 1 Remove the lens cap.
- 2 Plug the power cord into the side of the projector, then plug it into your electrical outlet. A surge-protected power strip is recommended.
 - The LED on the top of the projector (Figure 24 on page 30) lights green.
- 3 Turn on the lamp by pressing the green **power** button on the keypad or remote.
 - A tone sounds when you press the button, and the LED blinks green while the software initializes. When initialization is complete, the LED lights solid green and the startup screen appears.
- 4 Turn on your computer.
 - a The first time you connect a particular computer to the projector, the computer recognizes the projector as “new hardware” and the Add New Hardware Wizard appears. Follow these instructions to use the Wizard to load the correct driver (which was installed with your Windows operating system).

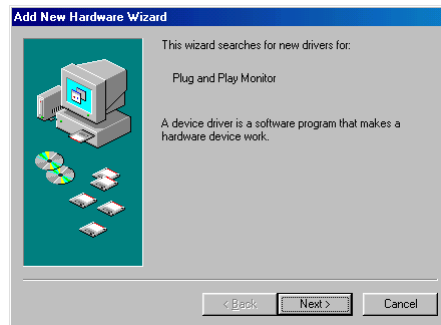

Click Next. Make sure “Search for the best driver” is selected, then click Next.

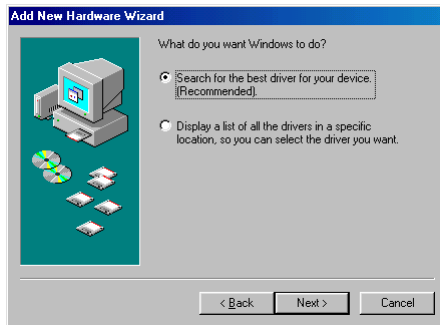

Uncheck any checked boxes, then click Next. Windows automatically locates the driver. If this driver has been removed, reload the driver using your Windows operating system CD.



When Windows finds the driver, you are ready to install it. Click Next.



Click Finish when installation is complete.

NOTE: *With some computers, the order in which you power up the equipment is very important. Most computers should be turned on last, after all other peripherals have been turned on. Refer to your computer's documentation to determine the correct order.*

5 The computer image should display on the projection screen. If it doesn't, press the **source** button on the keypad or the **data** button on the remote to display your computer's image. Make sure your laptop's external video port is activated; see your computer's user guide for details.

- If necessary, make adjustments to the image using the projector's on-screen menus. To open the menus, press the **menu/select** button on the keypad or remote, then select the **Display** or **Image** sub-menu. For more information about the menus, see page 33. You may need to adjust the screen aspect (page 35) or the degamma (page 44).

Turning Off the Projector

If you want to turn off the projector for a short period of time, press the **standby** button on the keypad or remote. This blanks the screen for fifteen minutes, but keeps the projector running. (You can change the amount of time the projector stays in standby mode; see page 45 for details.) After 15 minutes, the lamp goes out. To exit standby mode, press the **standby** button again. (It may take several seconds for the projection lamp to reach full power and project the image again.) See page 32 for details on standby mode.

NOTE: *Lamp life will be extended if you turn the power off, then wait 1 minute while the lamp cools before unplugging the projector. The Lamp LED will light green when the lamp has cooled.*

To turn off the projector, press the **power** button. The lamp turns off and the LED blinks amber for a minute while the fans continue to run to cool the lamp. When the lamp has cooled, the LED lights green and the fans stop. Unplug the power cord to completely power off the projector.

USING THE PROJECTOR

This section describes how to use and make adjustments to the projector. It also provides a reference to the keypad and remote buttons and the options available from the on-screen menus.

Basic Image Adjustment

- 1 If the image doesn't display completely, zoom the image (page 27), adjust the height of the projector (page 28), choose a different screen aspect (page 35) or choose a different resize option (page 42). Be sure the projector is at a 90 degree angle to the screen.
- 2 If the image is out of focus, rotate the focus ring (page 27).
- 3 If the image is not square, adjust the keystone (page 31).
- 4 If the colors don't look right, adjust the brightness, contrast, tint, color, or sharpenss (page 34) or the color space or gain (page 44).

Adjusting the Projector

To focus the image, rotate the focus ring (Figure 20) until the image is clear. To zoom the image, rotate the zoom ring. This adjusts the image size. You can also zoom in on part of the image, see page 32.

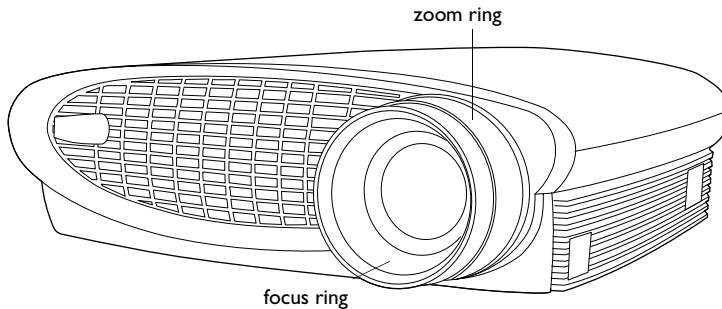

NOTE: To obtain the best overall focus quality, open the menu and focus on the text. This will ensure that the best overall image quality is achieved.

FIGURE 20

Focus ring and zoom ring

The projector is equipped with a self-locking, quick-release elevator foot and button.

To raise the projector:

- 1 Press and hold the elevator button (Figure 21).
- 2 Raise the projector to the height you want, then release the button to lock the elevator foot into position.

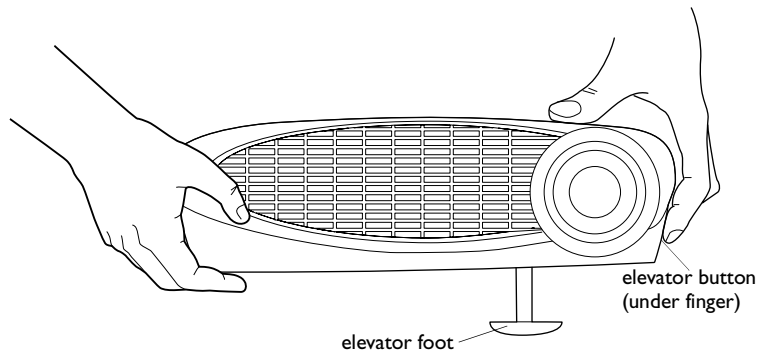

FIGURE 21

Adjusting the height of the projector

- 3 If necessary, turn the leveling knob to adjust the angle of the projected image.

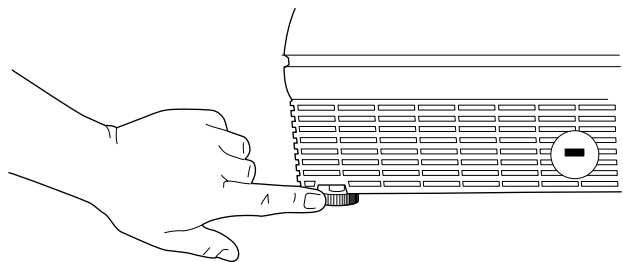

FIGURE 22

Turning the leveling knob

Using the Remote Control

Install the 2 AAA batteries in the remote. See page 53 if you need help.

Point the remote control at the projection screen or at the front or back of the projector. The range for optimum operation is about 25 feet. If you point the remote at the projection screen, the distance to the screen and back to the projector must be less than or equal to 25 feet. For best results, point the remote directly at the projector.

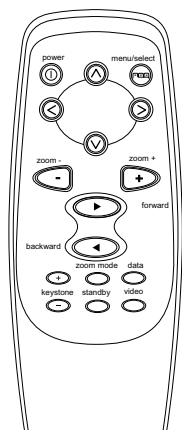

FIGURE 23

Remote control

Using the Keypad and Remote Buttons

While the menus are displayed, the volume, source, and standby buttons on the keypad act as menu navigation buttons. See “Using the On-Screen Menus” on page 33 for details.

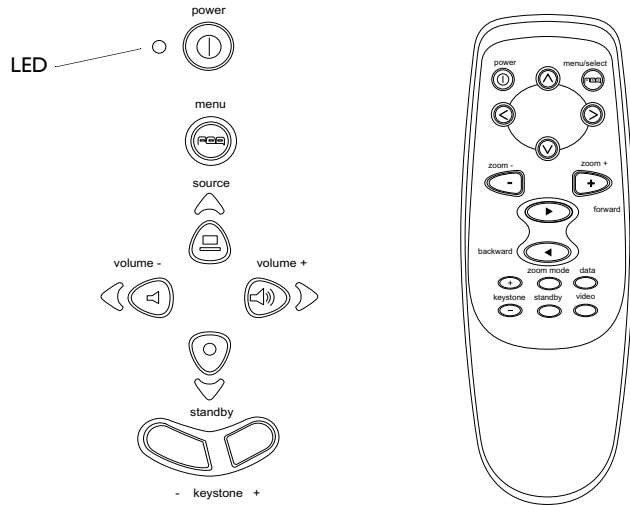

FIGURE 24

Keypad and remote buttons

NOTE: If you have turned Auto Source off (page 45), you may need to press the source button more than once to display an active source. The sources switch in this order: PC 1-Analog, PC 1-Digital, Video 3-Component HDTV, Video 3-Component, Video 1 S-Video, Video 2-Composite, PC 2-Component, and PC 2-Analog.

Menu/select

Press the **menu/select** button to open the on-screen menus. Press **menu/select** again (while Exit is highlighted) to close the menus. (The menus automatically close after 30 seconds if no buttons are pressed.) When you close the menus, the projector saves any changes you made. For more information about the on-screen menus, see page 33.

Source (keypad only) or Data and Video (remote only)

When you have more than one source (computer and video) connected to the projector, select between them by pressing the **source** button on the keypad or the **data** or **video** button on the remote.

Keystone + -

Use this feature to adjust the image vertically and make a squarer image.

- I Press the **keystone +** button to reduce the upper part of the image, and press the **keystone -** button to reduce the lower part. You can also adjust keystone from the Display menu (see page 34 for details on the menu).

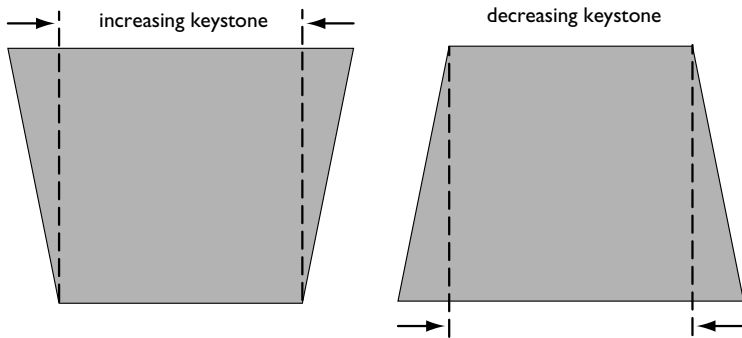

FIGURE 25

Adjusting the keystone

Forward/back buttons (remote only)

These buttons are not used with video sources.

These buttons act like the page up and page down buttons on your computer's keyboard. You can use them to advance through a slide show in PowerPoint™ presentations. To use this feature, you must purchase an optional M1-DA cable and connect the USB connector on the that cable to the computer.

Up/down/left/right arrow buttons (remote only)

Use these buttons to navigate through and make adjustments to the on-screen menus. See "Using the On-Screen Menus" on page 33 for details.

Power button

This turns the lamp on and off. See page 12 for startup instructions and see page 22 for shutdown instructions.

Zoom mode

This activates the zoom feature. When you press this button, the zoom icon appears in the lower right corner of the screen. Press the **zoom +** button to zoom in on part of the image, press the **zoom -** button to zoom out. When the image is zoomed, you can use the up/down/left/right arrow buttons to display a different part of the zoomed image (pan the image). Press **zoom mode** again to exit the mode and return the image to normal size.

You can also turn Zoom mode on using the Image menu and zoom and pan the image using the keystone buttons and arrows on the keypad. See page 42 for details.

Zoom +/-

This allows you to zoom in and out on a part of the image.

Standby

When you press **standby**, the display and audio turn off and a blank screen is displayed for 15 minutes. You can change the amount of time the projector stays in standby mode; see page 45 for details. The LED lights amber while the projector is in standby.

- If you press **standby** again within 15 minutes, the projector returns to normal operations immediately. The LED changes from amber to green.
- If you don't press **standby** again, the lamp turns off after 15 minutes. The LED blinks amber and the fans run while the projector cools down, then the projector shuts off and the LED lights solid green.

Volume (keypad only)

To increase the volume, press **volume +** . To decrease the volume, press **volume -** .

Using the On-Screen Menus

The projector has menus that allow you to make image adjustments and change a variety of settings. Most of these adjustments aren't available directly from the keypad.

To open the on-screen menus, press the **menu/select** button on the keypad or remote. (The menus automatically close after 30 seconds if no buttons are pressed.) This displays the Main menu and changes the volume, source, and standby buttons on the keypad to menu navigation and adjustment buttons (the arrow LEDs around the buttons light green to indicate the change). Press the corresponding buttons to move the cursor up and down, or use the arrow buttons on the remote. The selected menu item is highlighted.

NOTE: Some menu items may be grayed out (dimmed) at certain times. This indicates the item is not applicable to your setup or the item is not enabled until another selection is made.

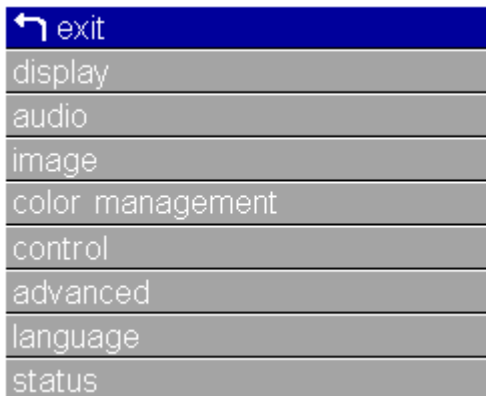

FIGURE 26

Main menu

To change a menu setting, use the up and down arrow buttons to move the cursor up and down to the item you want to change (the selected item is highlighted), then press **menu/select**. When an item is selected, its button appears depressed to provide a visual indication of selection. Use the left and right arrows to adjust the setting or turn it on and off. Press **menu/select** when you are done. Press the up and down arrows to move to another setting. When you have completed your adjustments, navigate to Exit, then press **menu/select**. You are returned to the top of the Main menu. Press **menu/select** again to exit the Main menu, or navigate to another submenu.

Display Menu

To access the Display menu settings, press the **menu/select** button to display the Main menu, press the down arrow to highlight Display, then press **menu/select** again to access the Display menu.



FIGURE 27

Display menu

Keystone

This option helps to keep the image square as the angle of projection is changed. Use this feature to adjust the image vertically and make a squarer image. See page 31 for details on keystone adjustments.

- I Press the down button to highlight Keystone, then press **menu/select**. Use the left and right arrows to adjust the keystone setting. Press **menu/select** to accept your changes.

Brightness

Adjusting the brightness changes the intensity of the image.

- I Use the up and down arrows to highlight Brightness, press **menu/select**, use the arrows to adjust the brightness, then press **menu/select** to accept your changes.

Contrast

The contrast controls the degree of difference between the lightest and darkest parts of the picture. Adjusting the contrast changes the amount of black and white in the image.

- I Use the up and down arrows to highlight Contrast, press **menu/select**, use the arrows to adjust the contrast, then press **menu/select** to accept your changes.

Tint

The tint adjusts the red-green color balance in the projected image.

- I Use the up and down arrows to highlight Tint, press **menu/select**, use the arrows to adjust the tint, then press **menu/select** to accept your changes.

NOTE: The color setting applies to video sources only. The tint setting applies to NTSC video sources only.

Color

The color setting adjusts a video image from black and white to fully saturated color.

- I Use the up and down arrows to highlight Color, press **menu/select**, use the arrows to adjust the color, then press **menu/select** to accept your changes.

Sharpness

This setting adjusts sharpness of a video image.

- I Use the up and down arrows to highlight Sharpness, press **menu/select**, use the arrows to cycle through the options soft, med-soft, medium, med-hard, and hard, then press **menu/select** to accept your selection.

Screen Aspect

This setting adjusts display format of a video image.

- I Use the up and down arrows to highlight Screen Aspect, press **menu/select**, use the arrows to choose between 4:3 and 16:9, then press **menu/select** to accept your selection.

Blank screen

Blank Screen determines what color is displayed when there is no active source and when the projector is in standby.

- I Use the up and down arrows to highlight Blank screen, press **menu/select**, use the arrows to cycle through the options blue, black, and white, then press **menu/select** to accept your selection.

Audio Menu

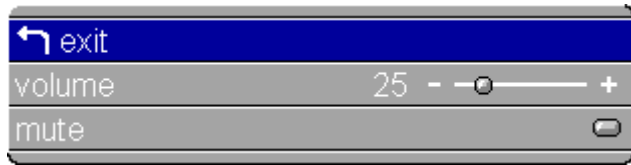

FIGURE 28

Display menu

Volume

You can also adjust the volume directly from the projector's keypad.

- I Use the up and down arrows to highlight Volume, press **menu/select**, use the arrows to adjust the volume, then press **menu/select** to accept your changes.

Mute

This mutes the sound.

- I Use the up and down arrows to highlight Mute, press **menu/select**, use the left or right arrow to turn mute on and off (a green dot indicates a feature is on), then press **menu/select** to accept your changes.

Image Menu for Video Sources

To access the Image menu settings, press the **menu/select** button to display the Main menu, press the down arrow to highlight Image, then press **menu/select** again to access the Image menu.

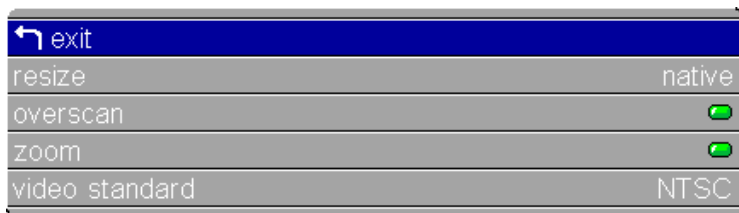

FIGURE 29

Image menu for video sources

Resize

Resize allows you to select from among four different re-sizing options. The goal is to show the most detail on the screen while preserving the ratio of width to height. Often, the terms “wide-screen letterbox” or “letterbox” or “enhanced for widescreen” or “anamorphic” appear on the back of DVDs. Check for these terms, then see the following table for guidelines for which resize option to select for which setup. Following the table is a description of the Resize options.

NOTE: *Your viewing preferences may vary from those listed. Cycle through the resize options and pick the one you like the best.*

Table 1: Resize options for various setups

If you have this source	and this screen aspect	choose this resize option	to get this image
standard TV	4:3	standard	full screen
standard TV	16:9	standard	4:3 image with side bars
VHS tape	4:3	standard	full screen
VHS tape	16:9	standard	4:3 image with side bars
DVD in standard	4:3	standard	full screen
DVD in standard	16:9	standard	4:3 image with side bars
DVD in widescreen letterbox	4:3	widescreen letterbox	16:9 image with top/bottom bars
DVD in widescreen letterbox	16:9	widescreen letterbox	full screen
DVD in enhanced widescreen/anamorphic	4:3	enhanced widescreen	16:9 image with top/bottom bars
DVD in enhanced widescreen/anamorphic	16:9	enhanced widescreen	full screen
HDTV	4:3	enhanced widescreen	16:9 image with top/bottom bars
HDTV	16:9	enhanced widescreen	full screen

The default Resize option is **Enhanced Widescreen**, which preserves the 16:9 aspect ratio and is designed to be used with content that is Enhanced for Widescreen TVs.

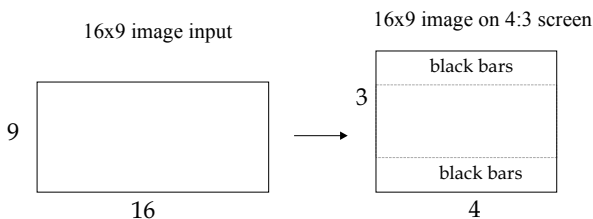

FIGURE 30

16:9 input on 4:3 screen with Resize set to Enhanced Widescreen

Widescreen Letterbox preserves the 16:9 aspect ratio. If you have a 16:9 source and screen, the image fills the screen (Figure 31). If you have a 16:9 source and a 4:3 screen, the image is placed in a 4:3 space, so black bars appear at the top and bottom of the image.

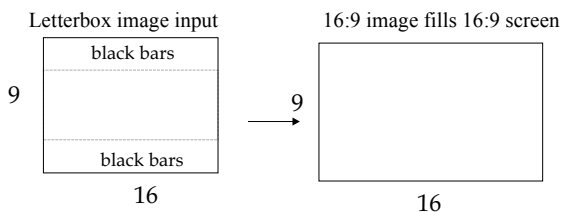

FIGURE 31

16:9 input on 16:9 screen with Resize set to Widescreen Letterbox

NOTE: A source that says “Anamorphic” means the same as “Enhanced for widescreen”.

NOTE: A source that says “Widescreen” usually means the same as “Widescreen Letterbox”.

Standard resizes the image from its original version to fit a standard 4:3 aspect ratio screen. If you have a 4:3 source and screen, the image fills the screen. If you have a 4:3 source on a 16:9 screen, the image is placed in a 16:9 space, so black bars appear at the sides of the image.

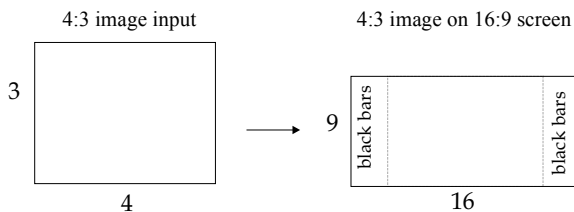

FIGURE 32

4:3 input on 16:9 screen with Resize set to Standard

Native displays the image with no resizing.

Highlight **Resize**, press **menu/select**, use the left or right arrow buttons to cycle through the options, then press **menu/select** to select.

Overscan

This option crops all the edges of the image to remove noise generated on the edges by your source.

Zoom

This allows you to enter zoom mode without using the remote. Highlight **Zoom**, press **menu/select**, use the left or right arrow buttons to turn zoom mode on, then press **menu/select**. Exit the menus to use the zoom feature. The zoom icon appears in the lower right corner. Use the **keystone +** button to zoom in and use the **keystone -** button to zoom out. Use the keypad navigation buttons on the keypad to pan the zoomed image. To exit zoom mode, either turn the feature off in the Image menu or press the **zoom mode** button on the remote.

Video Standard

When Video is set to Auto, the projector attempts to pick the video standard (NTSC, NTSC 4.43, PAL, PAL-M, PAL-N, PAL 60 or SECAM) automatically based on the input signal it receives. (The video standard options may vary depending on your region of the world.) The input signals for SECAM, PAL-M, PAL-N, and PAL 60 video are similar to other video signals and cannot be automatically detected, therefore they must be chosen manually. If the projector is unable to detect the correct standard, the colors might not look right or the image might appear “torn.” If this happens, manually select a video standard. Highlight **Video standard**, press **menu/select**, use the left or right arrows to cycle through the options, then press **menu/select** to select.

Image Menu for Computer Sources

To access the Image menu settings, press the **menu/select** button to display the Main menu, press the down arrow to highlight Image, then press **menu/select** again to access the Image menu.

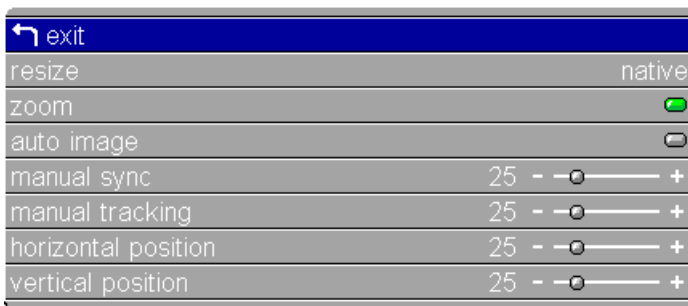

FIGURE 33

Image menu for computer sources

Resize

Resize allows you to select from among four different re-sizing options. The default is **Enhanced Widescreen**, which preserves the aspect ratio of the original theater version and is designed to be used with content that is Enhanced for Widescreen TVs. This option yields more detail than Widescreen Letterbox. **Widescreen Letterbox** also preserves the 16x9 aspect ratio of the original theater version, but the image is placed in a 4x3 space, so black bars appear at the top and bottom of the image. **Standard** resizes the image from its original version to fit a standard 4x3 aspect ratio screen. **Native** displays the image with no resizing.

Highlight **Resize**, press **menu/select**, use the left or right arrow buttons to cycle through the options, then press **menu/select** to select.

Zoom

This allows you to enter zoom mode without using the remote. Highlight **Zoom**, press **menu/select**, use the left or right arrow buttons to turn zoom mode on, then press **menu/select**. Exit the menus to use the zoom feature. The zoom icon appears in the lower right corner. Use the **keystone +** button to zoom in and use the **keystone -** button to zoom out. Use the keypad navigation buttons on the keypad to pan the zoomed image. To exit zoom mode, either turn the feature off in the Image menu or press the **zoom mode** button on the remote.

Auto Image

The projector automatically adjusts tracking, signal synchronization and vertical and horizontal position for most computers. If you want to adjust these features manually, you must turn off **Auto image** first.

Highlight **Auto image**, press **menu/select**, then press the left or right arrow buttons to turn this feature off and on.

Manual Sync

The projector adjusts signal synchronization automatically for most computers. But if the projected computer image looks fuzzy or streaked, try turning **Auto image** off then back on again. If the image still looks bad, try adjusting the signal synchronization manually:

- 1 Turn Auto Image off.
- 2 Highlight Manual sync, press **menu/select**, use the arrow buttons to adjust Manual sync until the image is sharp and free of streaks, then press **menu/select**.

Manual Tracking

The projector adjusts tracking automatically to match the video signal from your computer. However, if the display shows evenly spaced, fuzzy, vertical lines or if the projected image is too wide or too narrow for the screen, try turning **Auto Image** off then back on again. If the image is still bad, try adjusting the tracking manually:

- 1 Turn Auto image off.
- 2 Highlight Manual tracking, press **menu/select**, use the arrow buttons to adjust Manual tracking until the fuzzy vertical bars are gone, then press **menu/select**.

Horizontal/Vertical Position

Follow these steps to manually adjust the position:

- 1 Turn Auto image off.
- 2 Highlight Horizontal position, press **menu/select**, use the arrow buttons to adjust the Horizontal position, then press **menu/select**. Repeat for Vertical position, if necessary.

Positioning adjustments are saved when you turn off the projector.

NOTE: *The Manual Sync, Manual Tracking, Horizontal Position and Vertical Position options are available only for analog computer sources. The projector sets these options automatically for digital computer and video sources, with no manual override.*

Color Management Menu

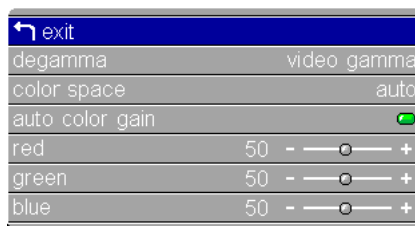

FIGURE 34

Color Management menu

NOTE: Your viewing preferences may vary. Cycle through the degamma options and pick the one you like the best.

Degamma

Degamma tables contain preset color configurations optimized for the type of source. You can select a degamma table that has been specifically tuned for either computer, video, or film input. Highlight **Degamma**, press **menu/select**, use the left or right arrows to cycle through the options, then press **menu/select** to select.

Color Space Standard

This option applies to computer and component video sources (it won't appear in the menu for S-video or composite video sources). It allows you to select a color space that has been specifically tuned for your video input. When Auto is selected, the projector automatically determines the standard. Choose RGB for computer sources, choose either SMPTE240, REC709, or REC601 for component video sources.

Highlight **Color Space Standard**, press **menu/select**, use the left or right arrows to cycle through the options, then press **menu/select** to select.

Auto Color Gain

When this feature is On, the projector automatically sets the red, green, and blue color gains for each source. When it is off, you can manually adjust the color gains.

Red, Green, Blue

To manually adjust the color gains:

- 1 Turn Auto Color Gain off.
- 2 Highlight Red, Green, or Blue, press **menu/select**, use the arrow buttons to adjust the gain, then press **menu/select**.

The settings are saved for each source.

Control Menu

To access the Control menu settings, press the **menu/select** button to display the Main menu, press the down arrow to highlight Control, then press **menu/select** again to access the Control menu.

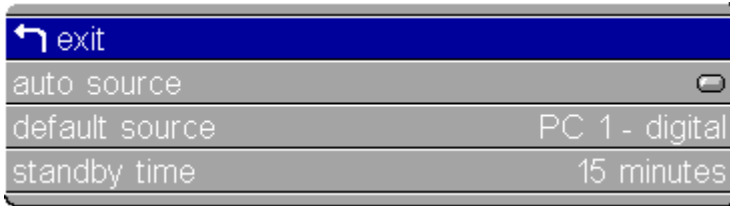

FIGURE 35

Control menu

Auto Source

When this feature is On, the projector automatically finds the active source, checking the default source first. When this feature is Off, the projector defaults to the source selected in Default Source. To display another source, you must manually select one by pressing the **source** button on the keypad or the **data** or **video** button on the remote.

Highlight **Auto source**, press **menu/select**, then press the left or right arrow buttons to turn this feature off and on.

Default Source

This determines which source the projector checks first for active video during power-up. Select among PC 1-Analog, PC 1-Digital, PC 2-Analog, Video1 S-Video, Video 2-Composite, Video 3-Component HDTV, and Video 3-Component.

Highlight **Default source**, press **menu/select**, use the left or right arrows to cycle through the options, then press **menu/select** to select.

Standby Time

This option lets you select how long the lamp stays on and the blank screen is displayed when the projector enters standby mode before the projector turns off. Select among 1, 5, 10, 15 and 30 minutes and 1 and 2 hours by clicking the left or right arrow buttons and cycling through the options.

Advanced Menu

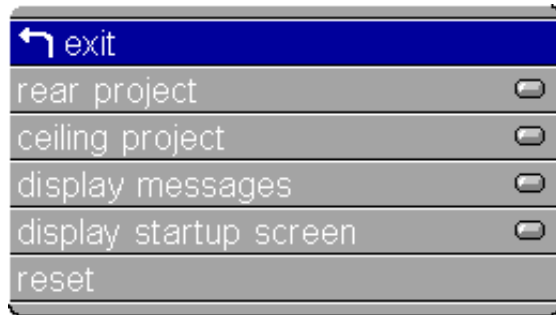

FIGURE 36

Advanced menu

Rear Project

When you turn **Rear Project** on, the projector reverses the image so you can project from behind a translucent screen.

Highlight **Rear Project**, press **menu/select**, then press the left or right arrow buttons to turn this feature off and on.

Ceiling Project

When you turn **Ceiling Project** on, the projector turns the image upside down for ceiling-mounted projection. Highlight **Ceiling Project**, press **menu/select**, then press the left or right arrow buttons to turn this feature off and on.

Display Messages

This setting toggles between On and Off. When this feature is On, status messages such as “No signal detected” or “Standby Active” appear in the lower-right corner of the screen.

Display Startup Screen

This setting toggles between On and Off. When this feature is On, the startup screen appears when the projector starts up and remains until an active source is detected. When it is off, a plain blue, black or white screen is displayed instead of the startup screen.

Reset

Highlight Reset then press **menu/select** to reset the options in the menus (except Language, Video Standard, Ceiling and Rear Project, Screen Aspect, Video Standard, and Standby Time) to their original settings.

Language Menu



FIGURE 37

Language menu

You can display the on-screen menus in English, French, German, Spanish, Portuguese, Chinese, Japanese, or Korean.

- 1 Press the **menu/select** button to display the Main menu, press the arrow buttons to highlight Language, then press **menu/select** again to access the Language menu.
- 2 Press the arrow buttons to highlight the desired language, then press **menu/select**. Press **menu/select** to exit this menu and return to the Main menu.

Status Menu

This is a read-only menu for informational purposes. To display the Status menu, highlight Status from the Main menu, then press **menu/select**.

↶ exit	
lamp hours used	39
video standard	NTSC
source	video 2 - composite
software version	1013101310

FIGURE 38

Status menu

Lamp Hours Used

Indicates how many hours the current lamp has been in use. The counter starts at zero hours and counts each hour the lamp is in use. Replace the bulb when the brightness is no longer acceptable. See “Replacing the Projection Lamp” on page 49 for details.

Video Standard

Shows the video standard being displayed.

Computer Resolution (computer sources only)

Shows the resolution of the computer being displayed.

Source

Indicates the active source, PC 1-Analog, PC 1-Digital, PC 2-Analog, PC 2-Component, Component HD, Video1 S-Video, Video 2-Composite, and Video 3-Component.

Software Version

Indicates the projector’s software version. This information is useful when contacting Technical Support.

MAINTENANCE & TROUBLESHOOTING

This section describes how to:

- clean the lens
- replace the projection lamp
- clean the projection lamp filter screens
- replace the batteries in the remote
- troubleshoot the projector

Cleaning the Lens

Follow these steps to clean the projection lens:

- 1 Apply a non-abrasive camera lens cleaner to a soft, dry cloth.
 - Avoid using an excessive amount of cleaner, and don't apply the cleaner directly to the lens.
 - Abrasive cleaners, solvents or other harsh chemicals might scratch the lens.
- 2 Lightly wipe the cleaning cloth over the lens in a circular motion.
- 3 If you don't intend to use the projector immediately, replace the lens cap.

Replacing the Projection Lamp

The lamp hour counter in the Status menu counts the number of hours the lamp has been in use. After 1,980 hours of use, the message "Change Lamp" temporarily appears on the screen when the projector is turned on. Change the lamp within the next 20 hours. After 2,000 hours, the lamp will not light. You can order new lamp modules from your Toshiba dealer. See "Accessories" on page 62 for information.

Follow these steps to replace the projection lamp:

- 1 Turn off the projector and unplug the power cord.
- 2 Wait 30 minutes to allow the projector to cool thoroughly.

WARNING: Never attempt to replace the lamp before turning off the projector and unplugging the power cord. Always wait 30 minutes or more after the projector is turned off and unplugged before opening the lamp door. Failure to follow these instructions could result in burns, electric shock and/or serious bodily injury.

- 3 Invert the projector on a soft flat surface, then push the ridge on the lamp door toward the back (Figure 39). The arrow on the lamp door should point to the unlock icon on the bottom of the projector. Lift the door up.

WARNING: Be extremely careful when removing the lamp module. In the unlikely event that the bulb ruptures, small glass fragments may be generated. The lamp module is designed to contain these fragments, but use caution when removing the lamp module.

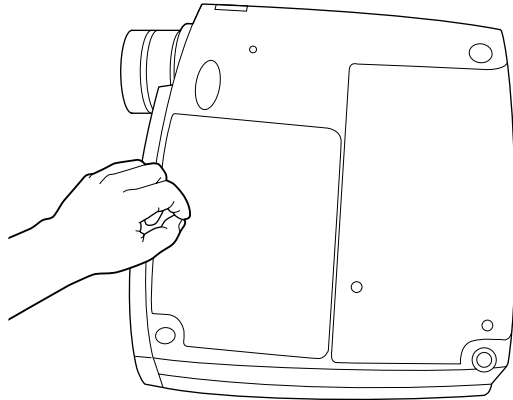

FIGURE 39

Removing the lamp door

- 4 Loosen the two non-removable screws on the outside of the module (Figure 40).

CAUTION: Never operate the projector with the lamp door open or removed. This disrupts the air flow and causes the projector to overheat.

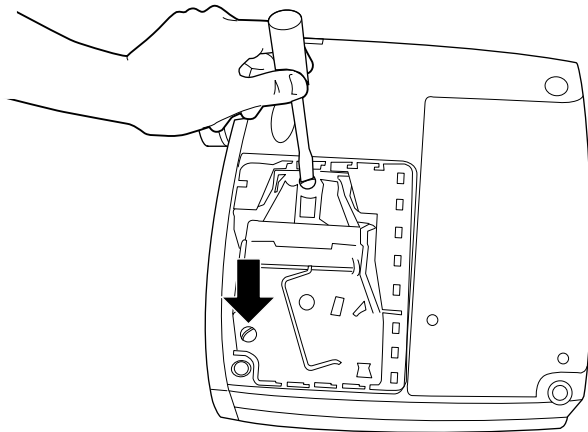

FIGURE 40

Loosening the screws on the lamp module

-
- 5 Lift and grasp the metal bail wire and lift the module out (Figure 41). Dispose of the lamp module in an environmentally proper manner.

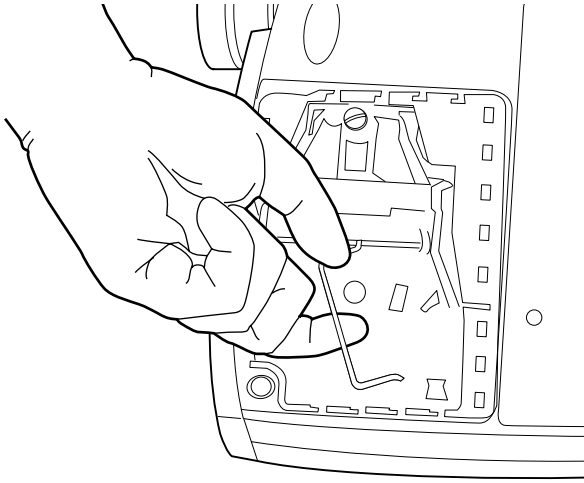

FIGURE 41

Removing the lamp module

- 6 Install the new lamp module, being sure to align the connectors properly.
- 7 Push the module in until it is flush with the bottom case of the projector.
- 8 Tighten the screws on the outside of the module.
- 9 Replace the lamp door by inserting the hooks on the lamp door into the slots on the projector and pressing the lamp door into place. The arrow on the lamp door should point to the lock icon on the bottom of the projector. If the lamp door does not fit properly or bulges out, remove the door and reseat the lamp module.
- 10 Plug in the power cord and press the green **power** button to turn the projector back on.
- 11 To reset the lamp hour counter in the Status window, press and hold the **volume -** button, then press the **source** button (while still holding down the **volume -** button) for 5 seconds. Verify that the counter was reset by viewing the counter in the Status window.

WARNING: Do not drop the lamp module or touch the glass bulb! The glass may shatter and cause injury.

Cleaning the Projection Lamp Filter Screens

In dirty or dusty environments, the dust filter screens on the lamp module can become clogged, causing high temperatures inside the lamp module. These high temperatures can cause premature lamp failure. Routine maintenance to remove dust and dirt from the screens lowers the lamp operating temperature and prolongs lamp life. To maximize lamp life you may want to clean the screen every 250 hours.

- 1** Remove the lamp module. Refer to “Replacing the Projection Lamp” on page 49 for instructions.
- 2** Examine the dust filter screens on each side of the lamp module. If necessary, use a vacuum cleaner set on low power to clean the screens. Then use a cotton swab dipped in isopropyl alcohol to lightly wipe each screen. After you've wiped each screen, blow away any remaining contaminants.

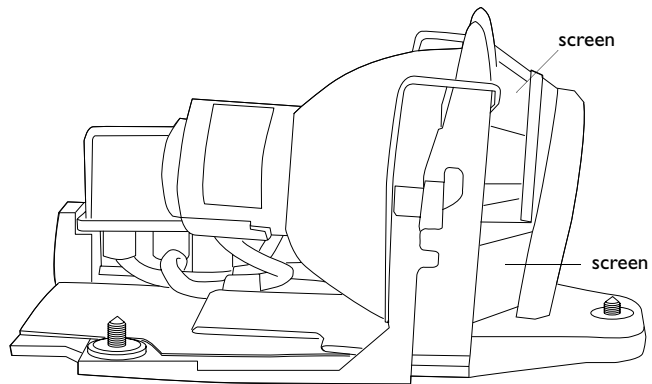

FIGURE 42

Lamp module screens

- 3** Before you replace the lamp, use the vacuum cleaner to clean the lamp housing in the projector.
- 4** Replace the lamp and lamp door.

Replacing the Batteries in the Remote Control

The life of the batteries depends on how often and how long you use the remote. Symptoms of low battery charge include erratic responses when using the remote and a reduced range of operation.

Follow these steps to replace the batteries:

- 1** Turn the remote face down in your hand.
- 2** Push the tab on the battery door toward the top of the remote and lift the door off.
- 3** Remove the old batteries and dispose of them in an environmentally proper manner.
- 4** Install two new AAA alkaline batteries. Make sure you install each in the correct direction.
- 5** Insert the hooks on the battery door into the remote and press the tab to re-install the door.

Troubleshooting

The LED on top of the projector tells you the state of the projector.

Table 2: LED behavior and meaning

LED color/behavior	Meaning
solid green	the projector is plugged in, or the projector has been turned on and the software has initialized
blinking green	the power button has been pressed and the software is initializing
solid amber	the projector is in standby mode
blinking amber	the projector is powering down, the fans are running to cool the lamp
fast blinking amber	indicates fan or lamp failure

The following tables list possible symptoms and remedies to situations you may encounter. The first table details potential problems with the projector, the next one with potential problems with a video source, and finally one with potential problems with a computer sources.

Table 3: Problem with the projector

Symptom	Remedy
The projector is not running (LED is not lit green)	Make sure that the power cord is properly connected to a fully functional AC electrical outlet. Make sure that the power cord is also properly connected to the projector. If the projector is plugged into a power strip, make sure the power strip is turned on
The projector is not running (LED is lit green)	Make sure the projector has been turned on by pressing the power button on the remote or keypad
Projector is running (LED lit green), but nothing appears on projection screen	Make sure you have removed the lens cap on the projection lens at the front of the projector
Projector is running (LED blinking series of 3 fast amber), but nothing appears on projection screen	Check the projector's lamp to ensure that it is securely connected in the lamp module. Make sure the lamp door is installed. Make sure the lamp has not been in use for over 2,000 hours. The lamp automatically shuts off at 2,000 hours. See "Replacing the Projection Lamp" on page 49.
Only the start-up screen displays	Verify that the cables are connected correctly. Make sure that the cables do not have any bent pins. Verify that the proper input source is connected and selected. See "Source (keypad only) or Data and Video (remote only)" on page 30. If you are watching TV, make sure the projector is connected to a tuner. Attach the source to a TV. If there is no image on the TV, the problem is with the source, not the projector.

Table 3: Problem with the projector

<p>No sound</p>	<p>Adjust volume on the keypad. Turn off “mute” in the menu. See page 36. Verify audio/input connections. Adjust audio source.</p>
<p>Lamp seems to be getting dimmer</p>	<p>The lamp begins to lose brightness when it has been in use for a long time. Replace the lamp as described in “Replacing the Projection Lamp” on page 49</p>
<p>Lamp shuts off</p>	<p>A minor power surge may cause the lamp to shut off. Unplug the projector, wait at least a minute, then plug it back in. Make sure the vents are not blocked. The lamp screens may be clogged. Avoid smoking around the projector. Clean the screens. See page 52. Make sure the lamp has not been in use for over 2000 hours. The lamp automatically shuts off after 2000 hours. See page 49.</p>

Table 4: Problem with a video image

Symptom	Remedy
Image is out of focus	Turn the projection lens to focus the image. Make sure the projection screen is at least 5.6 feet (1.7 m) from the projector. Check the projection lens to see if it needs cleaning.
Image isn't centered on the screen	Move the projector to reposition the image. Adjust the height. Be sure the projector is at a 90 degree angle to the screen.
Image is too wide or narrow for screen	Adjust the zoom or projector placement. Adjust the screen aspect. Adjust the resize option.
Image is not square	Adjust the keystone. See page 31.
Image is noisy	Turn Overscan on. See page 41.
Color or text not being projected	You might need to adjust the brightness up or down until the text is visible. Refer to "Brightness" on page 34 for more information.
Image and menus are reversed left to right	Rear projection mode is probably turned on. Turn Rear Projection off in the Controls menu. The image should immediately return to forward projection. See "Rear Project" on page 46.
Image and menus are upside down	Ceiling mode is probably turned on. Turn Ceiling off in the Controls menu. See "Ceiling Project" on page 46.
Projected colors don't match the video device's color	Adjust the brightness, tint and/or contrast from the Display menu. See "Brightness" on page 34, "Tint" on page 35 and "Contrast" on page 35. Adjust the color space. See page 44.
Image appears "torn"	The wrong video standard may be selected. See "Video Standard" on page 41.

Table 5: Problem with a computer image

Symptom	Remedy
Only the start-up screen displays	<p>Verify that the cables are connected correctly. Make sure that the cables do not have any bent pins.</p> <p>Verify that the proper input source is connected and selected. See “Source (keypad only) or Data and Video (remote only)” on page 30.</p> <p>You might need to turn everything off and power up the equipment again in the proper order. Refer to your computer’s documentation to determine the correct order.</p> <p>Make sure your laptop’s external video port is turned on. See your computer’s manual for details.</p> <p>Make sure your computer’s video board is installed and configured correctly. If you’re using Windows 98, Open “My Computer” icon, the Control Panel folder and then the Display icon. Click the Settings tab. Verify that the Desktop area is set to 1280x1024 or less.</p>
Image isn’t centered on the screen	<p>Move the projector to reposition the image. Adjust the height.</p> <p>Be sure the projector is at a 90 degree angle to the screen.</p> <p>Reposition the image using the menu. Refer to “Horizontal/Vertical Position” on page 43.</p>
The screen resolution is not right	<p>Make sure the computer’s video card is set for a resolution of no greater than 1280x1024.</p>

Table 5: Problem with a computer image

<p>Image is “noisy” or streaked</p>	<p>Try these steps in this order.</p> <ol style="list-style-type: none">1 Deactivate the screen saver on your computer.2 Turn Auto Image off and then back on again. See “Auto Image” on page 43.3 Turn Auto Image off and adjust the synchronization and tracking manually to find an optimal setting. See “Manual Sync” on page 43 and “Manual Tracking” on page 43. <ul style="list-style-type: none">•The problem could be with your computer’s video card. If possible, connect a different computer.
<p>Projected colors don’t match the computer or video player’s color</p>	<p>Just as there are differences in the displays of different monitors, there are often differences between the computer image and the projected image. Adjust the brightness, tint and/or contrast from the Display menu. See “Brightness” on page 34, “Tint” on page 35 and “Contrast” on page 35.</p>

Before calling your Toshiba dealer for assistance, please have the following information available:

- the model name of your projector
- the projector’s serial number (located on the bottom label)

APPENDIX

Specifications

The projector must be operated and stored within the temperature and humidity ranges specified.

Temperature

Operating	50 to 104° F (10 to 40° C) at sea level 50 to 95° F (10 to 35° C) at 10,000 feet
Non-operating	-4 to 158° F (-20 to 70° C)

Altitude

Operating	0 to 10,000 feet (3,048 meters)
Non-operating	0 to 20,000 feet (6,096 meters)

Humidity

Operating and non-oper.	10% to 95% relative humidity, non-condensing
-------------------------	--

Dimensions

10.4 x 11.1 x 3.3 inches (264 x 283 x 85 mm)
with module 10.4 x 12.1 x 3.3 inches (264 x 307 x 85 mm)

Weight

6.1 lbs. (2.8 kg) unpacked
with module 6.7 lbs. (3.0 kg)

Optics

Focus Range	5.6 - 33 feet (1.7-10 m)
-------------	--------------------------

Lamp

Type	220-watt SHP lamp
------	-------------------

Input Power Requirements

100-120VAC 5A; 50/60Hz
200-240VAC 3A; 50Hz



Accessories

Standard Accessories (ship with the projector)

Quick Start card

User's Guide

Soft Case

Shipping Box

VESA Computer Cable 6 ft (1.8 m)

Audio/Video Cable 6 ft (1.8 m)

S-Video Cable 13 ft (4 m)

Remote

Projection Lamp Module (included in projector)

Lens Cap

Enhanced Connectivity Module

NOTE: Use only Toshiba-approved accessories. Other products have not been tested with the projector.

Power Cords (one ships with projector, type depends on country)

North American Power Cord

Australian Power Cord

UK Power Cord

European Power Cord

Danish Power Cord

Swiss Power Cord

Audio/video inputs on the Enhanced Connectivity Module

Source	Video	Audio
Computer 2 VESA*	VESA Single-ended analog RGB (HD-15)	mini jack
Computer 1 M1-DA	M1-DA Single-ended analog or digital	mini jack
Component Video	Base-band or HDTV component video (RCA)	Left and right line-level (2 RCAs)
Composite Video*	Base-band composite video (RCA)	Left and right line-level (2 RCAs)
S-Video*	S-video Y/C (4-pin circular)	Left and right line-level (2 RCAs)

*indicates cable included with the projector

Projected Image Size

NOTE: Use the graph and table to help you determine projected image sizes.

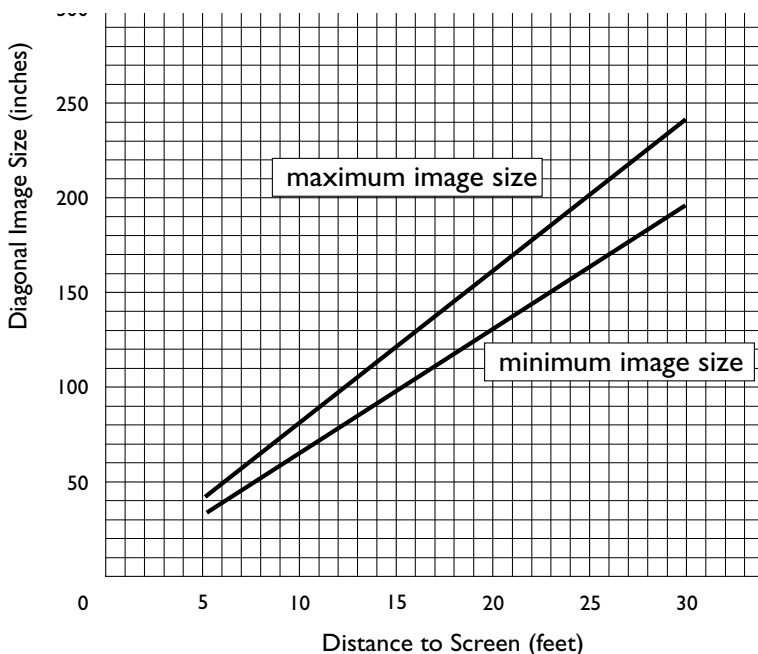

FIGURE 43

Projected image size for 16:9 aspect ratio

*Table 6:
Range of distance to the screen for a given screen size for 16:9 aspect ratio*

Diagonal Screen Size (inches)	Image Width (inches)	Distance to screen	
		Maximum distance (feet)	Minimum Distance (feet)
60	52.2	9.1	7.4
72	62.6	10.9	8.8
84	73.1	12.7	10.3
90	78.3	13.6	11.0
100	87	15.2	12.3
120	104.4	18.2	14.7



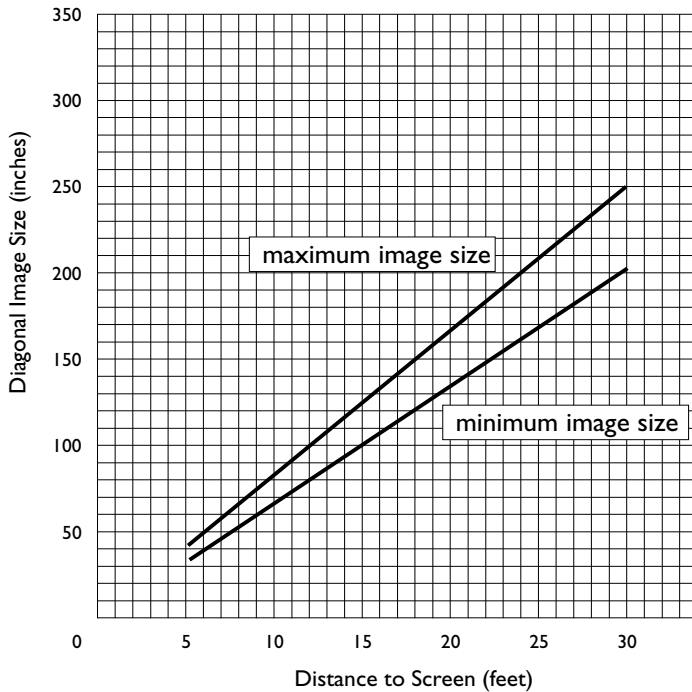

FIGURE 44

Projected image size for 4:3 aspect ratio

Table 7:

Range of distance to the screen for a given screen size for 4:3 aspect ratio

Diagonal Screen Size (inches)	Image Width (inches)	Distance to screen	
		Maximum distance (feet)	Minimum Distance (feet)
60	48	8.9	7.2
72	58	10.7	8.7
84	67	12.5	10.1
90	72	13.4	10.9
100	80	14.9	12.1
120	96	17.9	14.5



INDEX

A

- accessories, ordering 62
- adjusting
 - brightness 34
 - color 35
 - color gain 44
 - contrast 35
 - height of the projector 28
 - keystone 34
 - tint 35
 - volume 32
- Advanced menu options
 - Ceiling Project 46
 - Display Messages 46
 - Display Startup Screen 46
 - Rear projection 46
 - Reset 47
- altitude limits 61
- assistance. See Technical Support
- audio cable, connecting 11, 14, 15, 18, 19, 23
- Audio menu options
 - Mute 36
 - Volume 36
- Auto color gain 44
- auto image 43
- auto source 45

B

- brightness, adjusting 34
- buttons on keypad
 - Menu/select 30
 - Power 32
 - Source 30
 - Standby 32
 - Volume 32

C

- cables
 - audio 11, 14, 15, 18, 19, 23
 - computer cable 2, 23
 - ordering 62
 - power 62
- cases, ordering 62
- ceiling projection 46
- centering the image 28, 43
- cleaning the lamp filter screens 52
- cleaning the projection lens 49
- Color Management menu options
 - Auto color gain 44
 - Degamma 44
- Color space standard 44
- color, adjusting 35
- colors
 - not displayed 57
- compatibility
 - IBM-compatible 1
 - Macintosh 1
- computers
 - compatible 1
 - connecting 23
- connecting
 - audio cable 11, 14, 15, 18, 19, 23
 - computers 23
 - power cord 12, 16, 19, 24
 - video device 9
- contrast, adjusting 35
- Control menu options
 - Auto source 45
 - Default Source 45
 - Standby Time 45

D

- Default Source 45
- Degamma 44
- Display menu options
 - Blank screen 35
 - Brightness 34
 - Color 35
 - Contrast 35
 - Keystone 34
 - Screen Aspect 35
 - Sharpness 35
 - Tint 35
- Display Messages 46
- Display Startup Screen 46
- displaying on-screen menus 30

E

- elevator button/foot 28

F

- focusing the image 27
- forward/back buttons 31
- fuzzy lines 43

H

- HDTV 1, 35
- height adjustment 28

I

- IBM-compatible computers 1
- image
 - adjusting 24, 27
 - centering 43
 - focusing 27
 - fuzzy lines 43
 - resolution 1
 - reversed 46
 - size 5, 64
 - zooming 27
- Image menu options
 - Auto Image 43
 - Horiz. Position 43
 - Manual Sync 43
 - Manual Tracking 43
 - Overscan 41
 - Resize 37, 42
 - Video Standard 41
 - Zoom 41, 42

K

- keypad 30

L

- lamp
 - cleaning filter screens 52
 - ordering 62
 - replacing 49
- lamp hour counter 48, 49, 51
- Language menu 47
- language, selecting for menus 47
- laptop computers
 - compatibility 23
 - connecting 23
- LED 30, 32
- lens
 - cap 62
 - cleaning 49

M

M1-DA analog computer cable 2
Macintosh computers
 compatibility 1
menus. See on-screen menus
mute 36

N

NTSC video 41

O

on-screen menus
 changing language of 47
 displaying 33
overscan 41

P

PAL video 41
Power button 12, 16, 20, 24, 32
power cord
 connecting 12, 16, 19, 24
 ordering 62
power up sequence 26, 58
PowerPoint slides, advancing with the
 remote 31
project from behind the screen 46
project from the ceiling 46

R

rear projection 46
remote control
 advancing PowerPoint slides
 with 31
 replacing the batteries 53
 using 29, 30
replacing projection lamp module 49
re-positioning the image on the screen
 43
resetting adjustments 47
resetting the lamp hour counter 51
resizing the image 37, 42
resolution 1
RS-232 control 8

S

safety guidelines iii
Screen Aspect 35
sharpness 35
Source button 30
specifications 61
standby 22, 26, 32
standby time 45
Status menu 48

T

Technical Support
 information to have on hand
 before you call 59
temperature limits 61
tint, adjusting 35
troubleshooting 54
turning off the projector 22, 26
turning on the projector 24

V

vertical lines displayed 43
video resize 41
video standards 41
Volume buttons 32
volume, adjusting 32

W

widescreen video 42

Z

Zoom mode 32
zooming the image 27, 32, 41, 42

