

***myprojectorlamps.com***

**The most trusted, dependable name  
in projector lamp sales.**



<http://www.myprojectorlamps.com>



<http://www.myprojectorlamps.ca>



<http://www.myprojectorlamps.eu>

The following projector manual has not been modified or altered in any way.

# TAXAN

DATA PROJECTOR

# U6-112

# U6-132

# U6-232

USER'S MANUAL

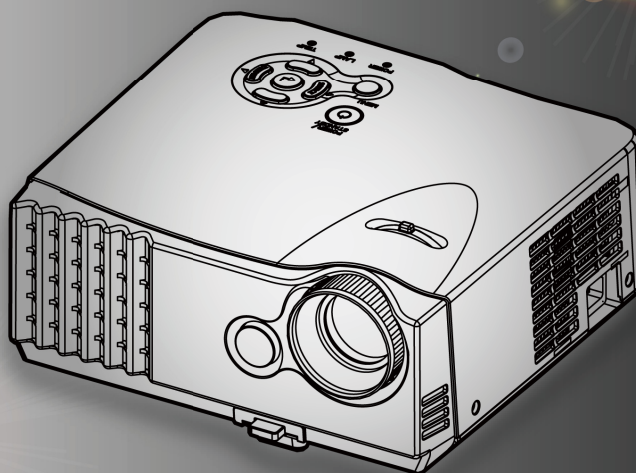

## Regulation & safety notices

This appendix lists the general notices of your Projector.

### *FCC notice*

This device has been tested and found to comply with the limits for a Class B digital device pursuant to Part 15 of the FCC rules. These limits are designed to provide reasonable protection against harmful interference in a residential installation. This device generates, uses, and can radiate radio frequency energy and, if not installed and used in accordance with the instructions, may cause harmful interference to radio communications.

However, there is no guarantee that interference will not occur in a particular installation. If this device does cause harmful interference to radio or television reception, which can be determined by turning the device off and on, the user is encouraged to try to correct the interference by one or more of the following measures:

- Reorient or relocate the receiving antenna.
- Increase the separation between the device and receiver.
- Connect the device into an outlet on a circuit different from that to which the receiver is connected.
- Consult the dealer or an experienced radio/television technician for help.

### *Notice: Shielded cables*

All connections to other computing devices must be made using shielded cables to maintain compliance with FCC regulations.

### *Caution*

Changes or modifications not expressly approved by the manufacturer could void the user's authority, which is granted by the Federal Communications Commission, to operate this product.

## ***Operation conditions***

This device complies with Part 15 of the FCC Rules. Operation is subject to the following two conditions:

1. this device may not cause harmful interference, and
2. this device must accept any interference received, including interference that may cause undesired operation.

## ***Notice for Canadian users:***

This Class B digital apparatus complies with Canadian ICES-003.

## ***Remarque à l'intention des utilisateurs canadiens***

Cet appareil numérique de la classe B est conforme à la norme NMB-003 du Canada.

## ***Declaration of Conformity for EU countries***

EMC Directive 89/336/EEC (including amendments)

Low Voltage Directive 73/23/EEC (amended by 93/68/EEC)



R & TTE Directive 1999/EC (if product has RF function)

# Table of Contents

Table of Contents .....	1
Usage Notice .....	2
Safety Information .....	2
Precautions .....	3
Eye safety Warning .....	5
Introduction .....	6
Product Features .....	6
Package Overview .....	7
Product Overview .....	8
Main Unit .....	8
Control Panel .....	9
Connection Ports .....	10
Wireless Remote Control .....	11
Installation .....	12
Connecting the Projector .....	12
Powering On/Off the Projector .....	13
Powering On the Projector .....	13
Powering Off the projector .....	14
Warning Indicator .....	14
Adjusting the Projected Image .....	15
Adjusting the Projector Image Height .....	15
Adjusting the Projector Zoom / Focus .....	16
Adjusting Projected Image Size .....	16
User Controls .....	17
Control Panel & Remote Control .....	17
Remote Control Range .....	20
On-Screen Display Menus .....	21
How to operate .....	21
Menu Tree .....	22
Picture (Computer Mode/ Video Mode) .....	23
View (Computer Mode/ Video Mode) .....	25
Audio .....	27
Language .....	28
Setting .....	29
Lamp Setting .....	31
Appendices .....	32
Troubleshooting .....	32
Replacing the lamp .....	36
Compatibility Modes .....	37
Ceiling Mount Installation .....	39
Important .....	40
Specification .....	41

# Usage Notice

## Safety Information

	The lightning flash with arrowhead within an equilateral triangle is intended to alert the user to the presence of uninsulated "dangerous voltage" within the product's enclosure that may be of sufficient magnitude to constitute a risk of electric shock to persons.
	The exclamation point within an equilateral triangle is intended to alert the user to the presence of important operating and maintenance (servicing) instructions in the literature accompanying the appliance.

**WARNING:** TO REDUCE THE RISK OF FIRE OR ELECTRIC SHOCK, DO NOT EXPOSE THIS APPLIANCE TO RAIN OR MOISTURE. DANGEROUS HIGH VOLTAGES ARE PRESENT INSIDE THE ENCLOSURE. DO NOT OPEN THE CABINET. REFER SERVICING TO QUALIFIED PERSONNEL ONLY.

### Class B emissions limits

This Class B digital apparatus meets all requirements of the Canadian Interference-Causing Equipment Regulations.

### Important Safety Instruction

1. Read these instructions -before using this projector.
2. Keep these instructions -for future reference.
3. Follow all instructions.
4. Install in accordance with the manufacturer's instructions

#### **A. Do not block any ventilation openings**

To ensure reliable operation of the projector and to protect it from overheating, put the projector in a position and location that will not interfere with its proper ventilation. For example, do not place the projector on a bed, sofa, carpet, or similar surface that may block the ventilation openings. Do not put it in an enclosure, such as a bookcase or a cabinet that may keep air from flowing through its ventilation openings.

**B. Do not use this projector near water or moisture.** To reduce the risk of fire or electric shock, do not expose the projector to rain or moisture.

**C. Do not install near any heat sources,** such as radiators, heaters, stoves or other apparatus (including amplifiers) that produce heat.

5. Clean only with a dry cloth.
6. Only use attachments/accessories specified by the manufacturer.
7. Refer all servicing to qualified service personnel. Servicing is required when the projector has been damaged in any way:

- Such as power cable or plug is damaged.
- Liquid has been spilled or objects have fallen into the apparatus.
- The projector has been exposed to rain or moisture, does not operate normally, or has been dropped.

Do not attempt to service this projector yourself. Opening or removing covers may expose you to dangerous voltages or other hazards. Please call to an authorized service center near you.

8. Do not let objects or liquids enter the projector -as they may touch dangerous voltage points or short-out parts that could result in a fire or electric shock.
9. See projector enclosure for safety related markings.
10. The projector should not be adjusted or repaired by anyone except properly qualified service personnel.

## Precautions

Follow all warnings, precautions and maintenance as recommended in this user's guide to maximize the life of your unit.



Do not look into the projector's lens when the lamp is on. The bright light may hurt your eyes.



To reduce the risk of fire or electric shock, do not expose this product to rain or moisture.



Please do not open or disassemble the product as this may cause electric shock.



When changing the lamp, please allow unit to cool down, and follow all changing instructions.



This product will detect the life of the lamp itself. Please be sure to change the lamp when it shows warning messages.



Reset the "Lamp Timer Reset" function from the On Screen Display "Lamp Setting" menu after replacing the lamp module (Refer to page 31).



When switching the projector off, please ensure the projector completes its cooling cycle before disconnecting power.



Turn on the projector first and then the signal sources.



Do not use lens cap when projector is in operation.



When the lamp reaches the end of its life, it will burn out and may make a loud popping sound. If this happens, the projector will not turn back on until the lamp module has been replaced. To replace the lamp, follow the procedures listed under "Replacing the Lamp". (See page 36)

# Usage Notice

## *Do:*

- ☺ Turn off the product before cleaning.
- ☺ Use a soft cloth moistened with mild detergent to clean the cabinet of the unit.
- ☺ Disconnect the power plug from AC outlet if the product is not being used for a long period of time.

## *Don't:*

- ☹ Block the slots and openings on the unit provided for ventilation.
- ☹ Use abrasive cleaners, waxes or solvents to clean the unit.
- ☹ Use under the following conditions:
  - In extremely hot, cold or humid environments.
  - In areas susceptible to excessive dust and dirt.
  - Near any appliance that generates a strong magnetic field.
  - In direct sunlight.



## Eye Safety Warnings

- ❑ Avoid staring directly into the projector beam at all times.
- ❑ Minimize standing facing into the beam. Keep your back to the beam as much as possible.
- ❑ A stick or laser pointer is recommended to avoid the need for the user to enter the beam.
- ❑ When projector is used in a classroom, adequately supervise students when they are asked to point out something on the screen.
- ❑ In order to minimize the lamp power needed, use room blinds to reduce ambient light levels.

## Product Features

U6-112 - SVGA single chip 0.55" DLP® projector.

U6-132 / U6-232 - XGA single chip 0.55" DLP® projector.

Outstanding features include:

- Single chip Dark Chip2™ DLP® technology
- NTSC3.58/NTSC4.43/PAL/PAL-M/PAL-N/SECAM and HDTV compatible (480i/p, 576i/p, 720p, 1080i)
- Multi-Auto functions: Auto detection, Auto image and Auto saving the adjustments
- Full function remote control
- User friendly multilingual on screen display menu
- Advanced digital keystone correction and high quality full screen image re-scaling
- User friendly control panel
- Built-in one speaker with 2 Watt amplifier
- SXGA compression and XGA, VGA, re-sizing (U6-112)
- SXGA+, SXGA compression and SVGA, VGA, re-sizing (U6-132/U6-232)
- Mac compatible

# Introduction

## Package Overview

This projector comes with all the items shown below. Check to make sure your unit is complete. Contact your local reseller immediately if anything is missing.



Projector with lens cap

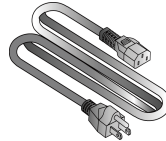

Power Cable 1.8m

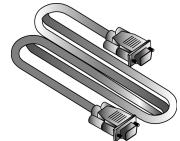

RGB Signal Cable 1.8m

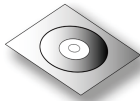

User's Manual (CD-ROM)



Quick Start Card



Wireless Remote Controller



Carrying Case



2 x AAA Batteries



❖ Due to the difference in applications for each country, some regions may have different accessories.

# Introduction

## Product Overview

### Main Unit

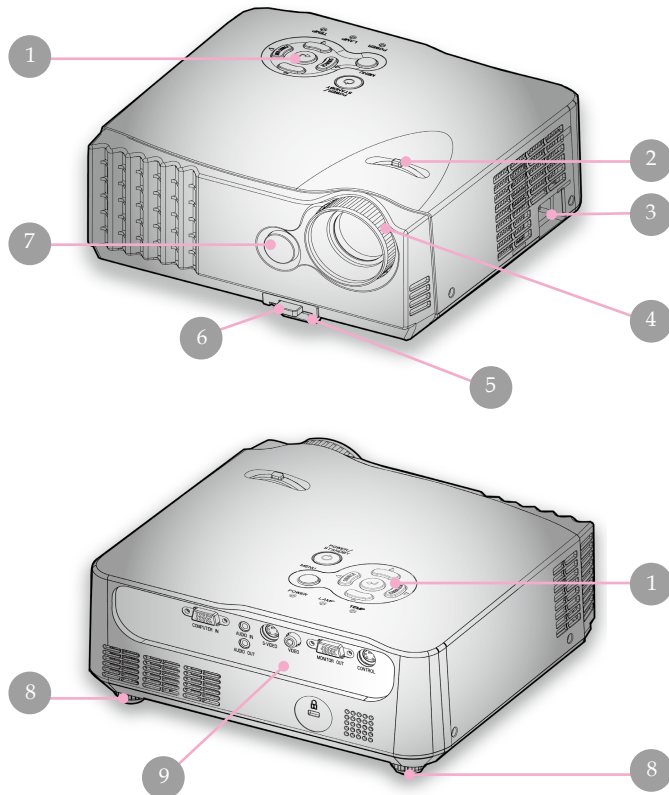

1. Control Panel
2. Zoom Lever
3. Power Socket
4. Focus Ring
5. Adjuster
6. Adjuster Button
7. Remote Control Sensor
8. Tilt Adjuster
9. Connection Ports

# Introduction

## Control Panel

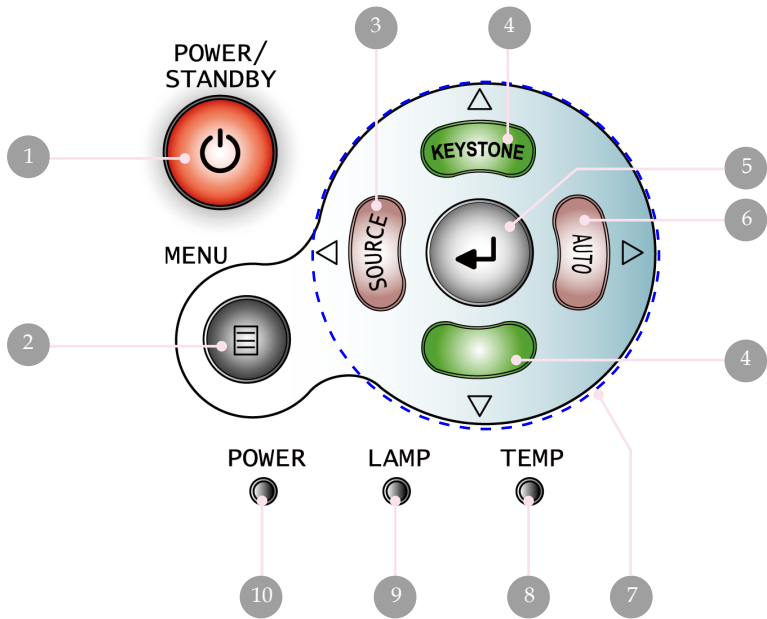

1. Power/Standby Button
2. Menu Button
3. Source Button
4. Keystone Correction Button
5. Enter Button
6. Auto Button
7. Four Directional Select Keys Buttons
8. Temp Indicator
9. Lamp Indicator
10. Power Indicator

# Introduction

## Connection Ports

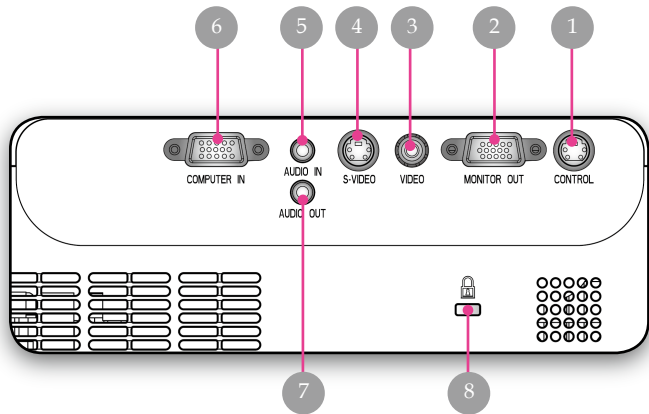

1. Control(RS232) Connector
2. Monitor Loop-through Output Connector
3. Composite Video Input Connector
4. S-Video Input Connector
5. Audio Input Connector
6. PC Analog signal/SCART RGB/HDTV/Component Video Input Connector
7. Audio Output Connector
8. Kensington™ Lock Port

# Introduction

## Wireless Remote Control

- 
1. Power
  2. Infrared Transmitter
  3. Menu
  4. Aspect
  5. Volume +/-
  6. Computer Source
  7. S-Video Source
  8. Video
  9. Auto
  10. Four Directional Select Keys
  11. D-Zoom
  12. Mute
  13. Freeze
  14. Picture Mute
  15. Quick Color Adjustment
  16. Keystone Correction
  17. Enter
- 

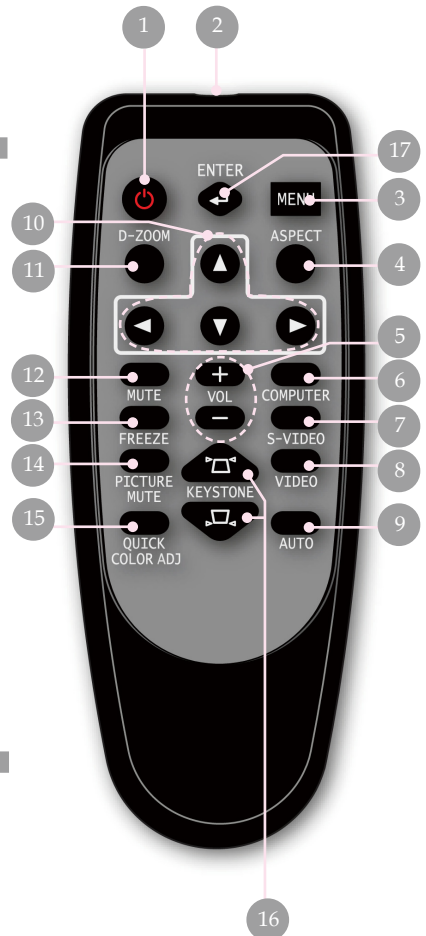

## Connecting the Projector

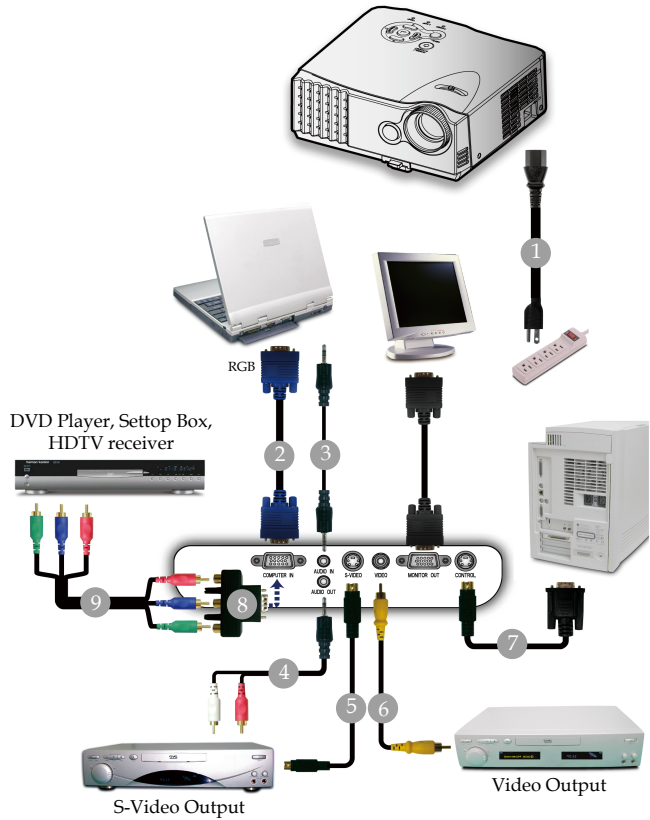

Due to the difference applications for each country, some regions may have different accessories.

- 1.....Power Cable
- 2.....RGB Signal Cable
- 3..... Audio IN Cable (Commercially Available)
- 4..... Audio Out Cable (Commercially Available)
- 5..... S-Video Cable (Commercially Available)
- 6.....Composite Video Cable (Commercially Available)
- 7.....RS232 Cable (Commercially Available)
- 8.....D-15 to RCA Adapter for YPbPr (Commercially Available)
- 9.....3 RCA Component Cable (Commercially Available)



## Powering On/Off the Projector

### Powering On the Projector

1. Remove the lens cap. ❶
2. Ensure that the power cable and RGB signal cable are securely connected. The Power LED will flash green.
3. Turn on the lamp by pressing “Power/Standby” button on the control panel. ❷ And the Power LED will turn green. The first time you use the projector, you can select your preferred language from quick menu after the startup screen display.
4. Turn on the power of the connected equipment (computer, notebook, video player, etc.). The projector will detect your source automatically.

❖ *If you connected multiple sources at the same time, press the “Source” button on the control panel or direct source key on the remote control to switch between inputs.*



❖ Turn on the projector first and then the signal sources.

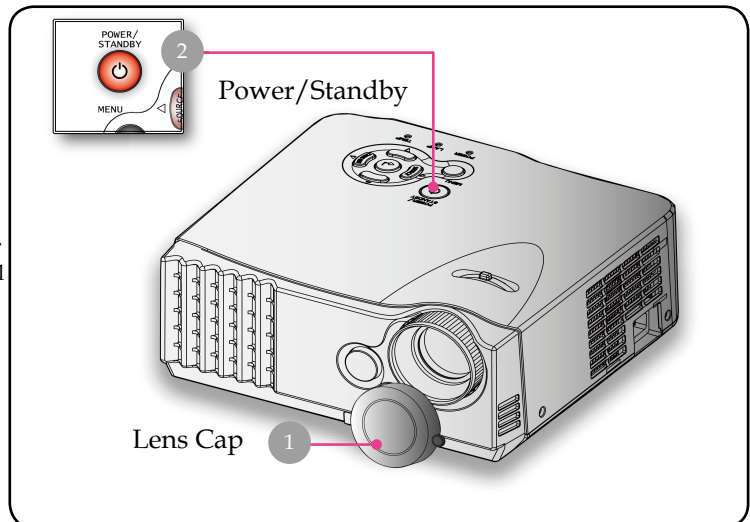

## Powering Off the Projector

1. Press the “Power/Standby” button to turn off the projector lamp, you will see a message

Press the POWER/STANDBY button again to power off.

displayed on the projector’s screen. Press the “Power/Standby” button again to confirm, otherwise the message will disappear after 25 seconds.

2. The cooling fans continue to operate for about 60 seconds for cooling. When the Power LED begins flashing, the projector has entered standby mode.

If you wish to turn the projector back on, you must wait until the projector has completed the cooling cycle and has entered standby mode. Once in standby mode, simply press “Power/Standby” button to restart the projector.

3. Disconnect the power cable from the electrical outlet and the projector.
4. Do not turn on the projector immediately following a power off procedure.

## Warning Indicator

- ❖ When the “LAMP” indicator lights solid red, the projector will automatically shut itself down. Please contact your local reseller or an authorized service center.
- ❖ When the “TEMP” indicator lights solid red for about 15 seconds, it indicates the projector has been overheated. The projector will automatically shut itself down. Under normal conditions, the projector can be switched on again after it has cooled down. If the problem persists, you should contact your local reseller or an authorized service center.
- ❖ When the “TEMP” indicator flashes red, it indicates the fan failed. Please contact your local reseller or an authorized service center.

## Adjusting the Projected Image

### Adjusting the Projector Image Height

The projector is equipped with an adjuster for adjusting the image height.

To raise the image:

1. Press the adjuster button **1**.
2. Raise the image to the desired height angle **2**, then release the button to lock the adjuster into position.
3. Use **3** to fine-tune the display angle.

To lower the image:

1. Press the adjuster button.
2. Lower the image, then release the button to lock the adjuster into position.
3. Use **3** to fine-tune the display angle.

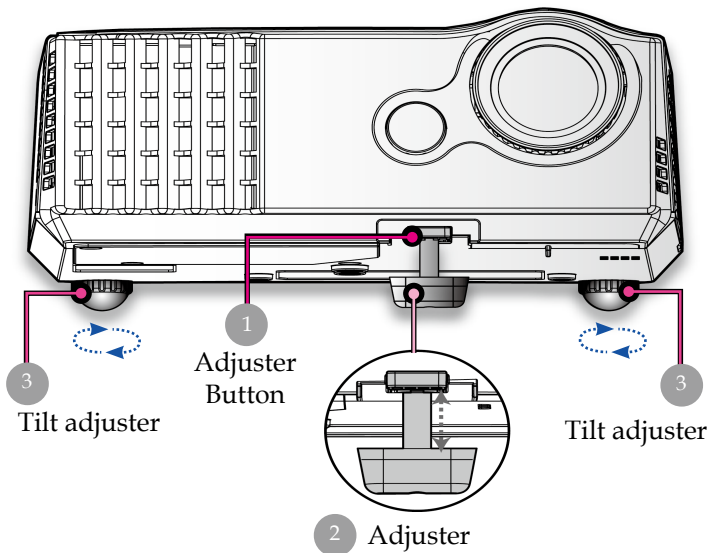

# Installation

## Adjusting the Projector Zoom / Focus

You may turn the zoom lever to zoom in or out. To focus the image, rotate the focus ring until the image is clear. The projector will focus at distances from 4.92 to 38.75 feet (1.5 to 11.8 meters) with mechanical travel.

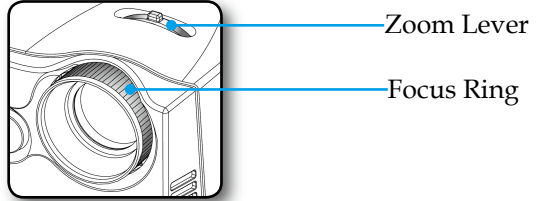

## Adjusting Projection Image Size



- ❖ There is a tolerance of  $\pm 5\%$  due to design values.
- ❖ This table uses the lens apex and lens center as references and requires that the projector be in a horizontal condition (with front and rear adjuster fully withdrawn)

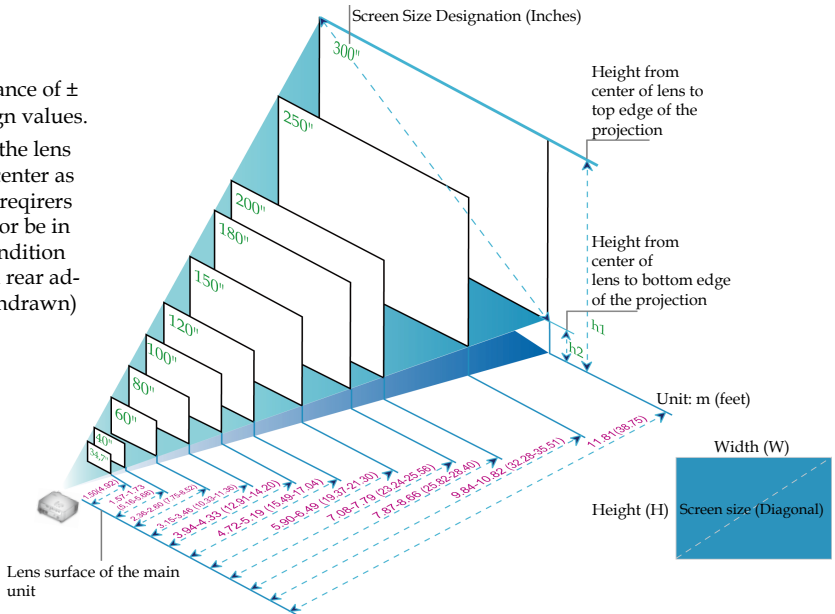

screen size designation (inch)	screen size W x H				projection distance				h1		h2	
					(m)		(feet)					
	(m)	(feet)	wide	tele	wide	tele	(m)	(feet)	(m)	(feet)		
34.7	0.70	0.53	2.31	1.73	-	1.50	-	4.92	0.61	1.99	0.08	0.26
40	0.81	0.61	2.66	2.00	1.57	1.73	5.16	5.68	0.70	2.30	0.09	0.30
60	1.22	0.91	4.00	2.99	2.36	2.60	7.75	8.52	1.05	3.43	0.14	0.45
80	1.63	1.22	5.35	4.00	3.15	3.46	10.33	11.36	1.40	4.60	0.18	0.60
100	2.03	1.52	6.66	4.99	3.94	4.33	12.91	14.20	1.75	5.73	0.23	0.75
120	2.44	1.83	8.00	6.00	4.72	5.19	15.49	17.04	2.10	6.90	0.27	0.90
150	3.05	2.29	10.00	7.51	5.90	6.49	19.37	21.30	2.63	8.64	0.34	1.13
180	3.66	2.74	12.00	8.99	7.08	7.79	23.24	25.56	3.15	10.34	0.41	1.35
200	4.06	3.05	13.32	10.01	7.87	8.66	25.82	28.40	3.51	11.51	0.46	1.50
250	5.08	3.81	16.66	12.50	9.84	10.82	32.28	35.51	4.38	14.38	0.57	1.88
300	6.10	4.57	20.00	15.00	11.81	-	38.75	-	5.26	17.26	0.69	2.26

## Control Panel & Remote Control

There are two ways for you to control the functions: Remote Control and Control Panel.

### Control Panel

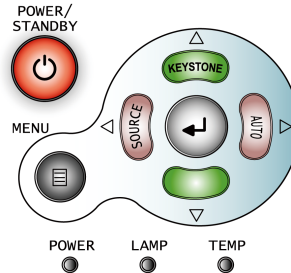

#### Using the Control Panel

##### Power/Standby (⏻)

- ▶ Refer to the “Power On/Off the Projector” section on pages 13-14.

##### Source ◀

- ▶ Press “Source” to choose Computer, Component-p, Component-i, Composite, S-video source.

##### Menu (☰)

- ▶ Press “Menu” to launch the on screen display (OSD) menu. To exit OSD, press “Menu” again.

##### Keystone ▲ / ▼

- ▶ Adjusts image distortion caused by tilting the projector ( $\pm 15$  degrees).

##### Four Directional Select Buttons

- ▶ Use ▲ ▼ ◀ ▶ to select items or make adjustments to your selection.

##### Enter (↵)

- ▶ Confirm your selection of items.

##### Auto ▶

- ▶ Automatically synchronizes the projector to the input source.

# User Controls

## Remote Control



### Using the Remote Control

#### Power

- ▶ Refer to the “Power On/Off the Projector” section on pages 13-14.

#### Menu

- ▶ Press “Menu” to launch the on screen display (OSD) menu. To exit OSD, press “Menu” again.

#### Aspect

- ▶ Display the “Aspect Ratio” section of the OSD menu to select the desired aspect ratio.

#### Computer

- ▶ Press “Computer” to choose RGB signal.

#### S-Video

- ▶ Press “S-Video” to choose S-Video signal.

#### Video

- ▶ Press “Video” to choose Composite video signal.





#### Auto

- ▶ Automatically synchronizes the projector to the input source.

#### Enter

- ▶ Confirm your selection of items.

#### Four Directional Select Buttons

- ▶ Use     to select items or make adjustments to your selection.

#### Volume + / - (Vol+/Vol-)

- ▶ Increases/decreases speaker volume.

#### Keystone

- ▶ Adjusts image distortion caused by tilting the projector ( $\pm 15$  degrees).

#### Quick Color Adj.

- ▶ Select the display mode from PC, Graphic, Presentation and Custom (Computer mode) or PC, movie and Custom. (Video mode)

#### Picture Mute

- ▶ Press “Picture Mute” to hide image, press again to restore display of the image.

# User Controls

## Freeze

- ▶ Press “Freeze” to pause the screen image.

## Mute

- ▶ Momentarily turns off the audio.

## D-Zoom (Digital Zoom)

- ▶ Press “D-Zoom” button to zoom in of an image.

## Remote Control Range

Point the infrared transmitter of the remote control toward the remote control sensor located at the front of the main unit and operate.

Reception of the remote control signal should generally be possible within the range illustrated below.

If you operate from the rear position of projector, point the infrared transmitter of the remote control toward the screen.

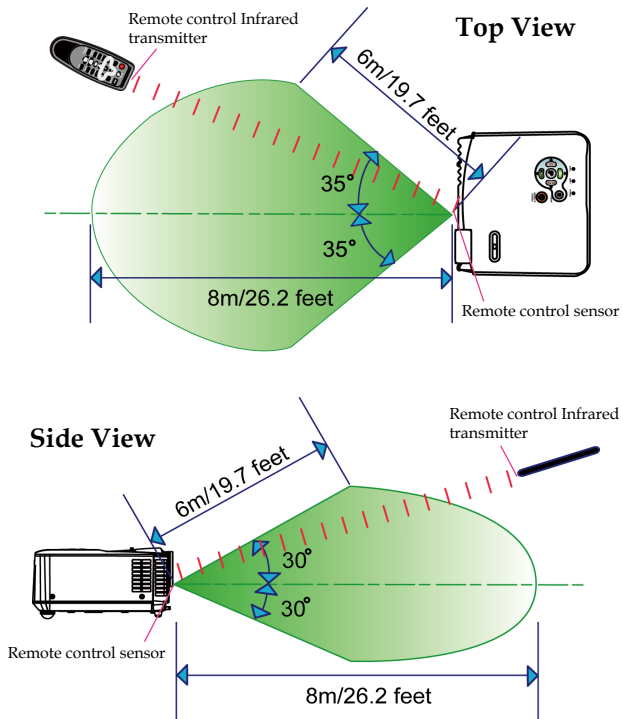

- NOTE** □ Exposure of the main unit's remote control sensor or the remote control infrared transmitter to bright light or the obstruction of the signal by an obstacle located in the pathway may prevent operation.
- The remote control will not function when the battery is exhausted.



## On Screen Display Menus

The projector has multilingual On Screen Display (OSD) menus that allow you to make image adjustments and change a variety of settings. The projector will automatically detect the source.

### How to operate

1. To open the OSD menu, press “Menu” on the Remote Control or Control Panel.
2. When OSD is displayed, use ◀ ▶ keys to select any item in the Main Menu. While making a selection on a particular page, press ▼ or “Enter” key to enter Sub Menu.
3. Use ▲ ▼ keys to select the desired item and adjust the settings by ◀ ▶ key.
4. Select the next item to be adjusted in the sub menu and adjust as described above.
5. Press “Menu” to confirm, and the OSD menu will return to the Main Menu.
6. To exit, press “Menu” again. The OSD menu will close and the projector will automatically save the new settings.

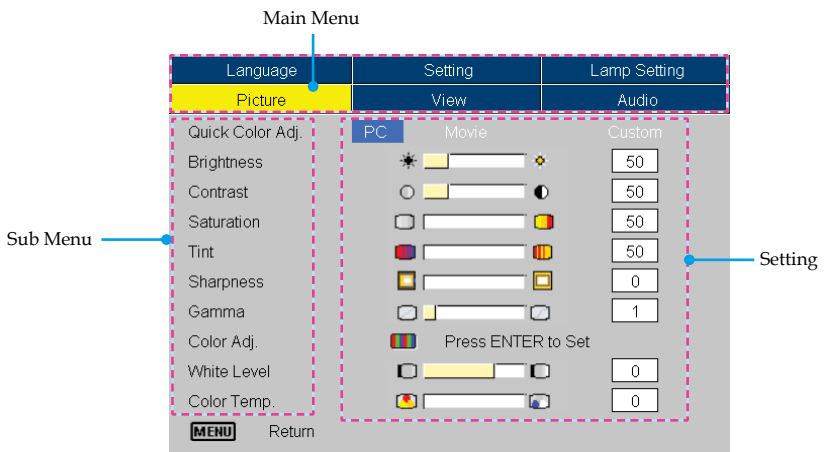

# User Controls

## Menu Tree

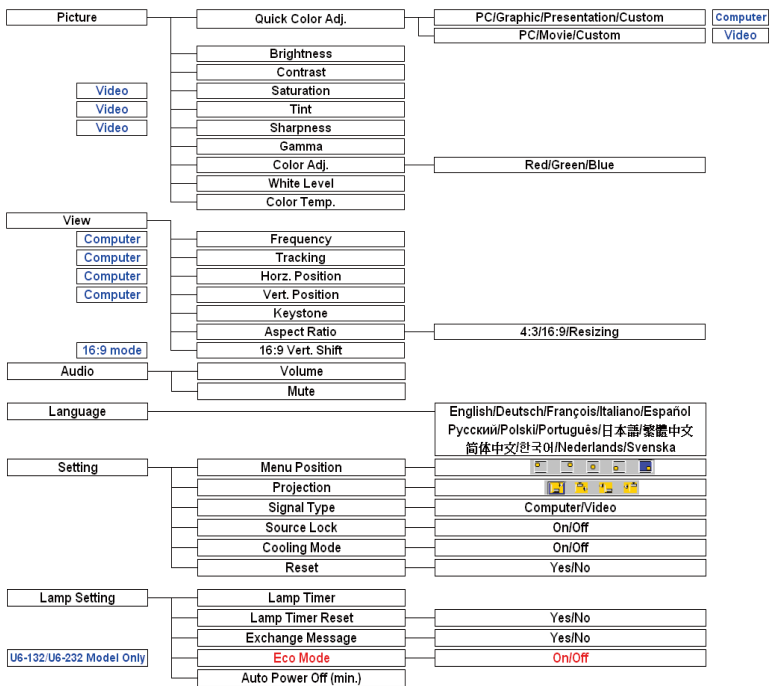

# User Controls

Language	Setting	Lamp Setting
Picture	View	Audio
Quick Color Adj.	PC Movie Custom	
Brightness		50
Contrast		50
Saturation		50
Tint		50
Sharpness		0
Gamma		1
Color Adj.	Press ENTER to Set	
White Level		0
Color Temp.		0
Return		

## Picture (Computer / Video Mode)

### Quick Color Adj.

There are many factory presets optimized for various types of images.

- ▶ PC: For computer or notebook.
- ▶ Graphic/Movie: For home theater. (best color reproduction)
- ▶ Presentation: For the daylight use. (maximum brightness)
- ▶ Custom : Memorize user's settings.

### Brightness

Adjust the brightness of the image.

- ▶ Press the ◀ to darken image.
- ▶ Press the ▶ to lighten the image.

### Contrast

The contrast controls the degree of difference between the lightest and darkest parts of the picture. Adjusting the contrast changes the amount of black and white in the image.

- ▶ Press the ◀ to decrease the contrast.
- ▶ Press the ▶ to increase the contrast.

### Saturation

Adjusts a video image from black and white to fully saturated color.

- ▶ Press the ◀ to decrease the amount of color in the image.
- ▶ Press the ▶ to increase the amount of color in the image.



"Saturation" function is not supported under Computer mode.

# User Controls

Language	Setting	Lamp Setting
Picture	View	Audio
Quick Color Adj.	PC Movie Custom	
Brightness		50
Contrast		50
Saturation		50
Tint		50
Sharpness		0
Gamma		1
Color Adj.	Press ENTER to Set	
White Level		0
Color Temp.		0
<b>MENU</b> Return		

## Picture (Computer / Video Mode)



“Tint” and “Sharpness” function are not supported under Computer mode.

### Tint

Adjusts the color balance of red and green.

- ▶ Press the ◀ to increase the amount of green in the image.
- ▶ Press the ▶ to increase the amount of red in the image.

### Sharpness

Adjusts the sharpness of the image.

- ▶ Press the ◀ to decrease the sharpness.
- ▶ Press the ▶ to increase the sharpness.

### Gamma

This allows you to choose a gamma table that has been fine-tuned to bring out the best image quality for the input.

### Color Adj.

Press “Enter” to adjust the red, green and blue colors.

Color Adj.		
Red		50
Green		50
Blue		50
Exit		

### White Level

Use the white peaking control to set the white peaking level of DLP chip. 0 stands for minimal peaking, and 10 stands for maximum peaking. If you prefer a stronger image, adjust towards the maximum setting. For a smooth and more natural image, adjust towards the minimum setting.

### Color Temp.

Adjust the color temperature. At higher temperature, the screen looks colder; at lower temperature, the screen looks warmer.

# User Controls

Language	Setting	Lamp Setting
Picture	View	Audio
Frequency	<input type="checkbox"/> <input type="text" value="50"/> <input type="checkbox"/>	50
Tracking	<input type="checkbox"/> <input type="text" value="50"/> <input type="checkbox"/>	50
Horz. Position	<input type="checkbox"/> <input type="text" value="50"/> <input type="checkbox"/>	50
Vert. Position	<input type="checkbox"/> <input type="text" value="50"/> <input type="checkbox"/>	50
Keystone	<input type="checkbox"/> <input type="text" value="50"/> <input type="checkbox"/>	50
Aspect Ratio	<input type="checkbox"/> <input type="text" value="16:9"/> <input type="checkbox"/>	16:9
16:9 Vert. Shift	Press ENTER to Set	

**MENU** Return

## View (Computer / Video Mode)



### NOTE

"Frequency", "Tracking", "Horz. Position" and "Vert. Position" function are not supported under Video mode.

### Frequency

"Frequency" changes the display data frequency to match the frequency of your computer's graphic card. If you experience a vertical flickering bar, use this function to make an adjustment.

### Tracking

"Tracking" synchronizes the signal timing of the display with the graphic card. If you experience an unstable or flickering image, use this function to correct it.

### Horz.Position (Horizontal Position)

- ▶ Press the ◀ to move the image left.
- ▶ Press the ▶ to move the image right.

### Vert. Position (Vertical Position)

- ▶ Press the ◀ to move the image down.
- ▶ Press the ▶ to move the image up.

### Keystone

Adjust image distortion caused by tilting projector. (±15 degrees)

# User Controls





Original Pixel



Resizing

## Aspect Ratio

Use this function to choose your desired aspect ratio.

- ▶  4:3 : The input source will be scaled to fit the projection screen.
- ▶  16:9 : The input source will be scaled to fit the width of the screen.
- ▶  Resizing: When a 4:3 image is bigger than a 16:9 screen, select the “Resizing” mode to fit the image onto the screen without changing the projection distance.

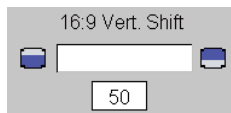

## 16:9 Vert. Shift

Adjust the image position to up or down, when you select the aspect ratio to 16:9.

- ▶ Press the ◀ to move the image down.
- ▶ Press the ▶ to move the image up.



16:9 Vert. Shift: Image Position at Resizing mode will also be moved accordingly.

# User Controls

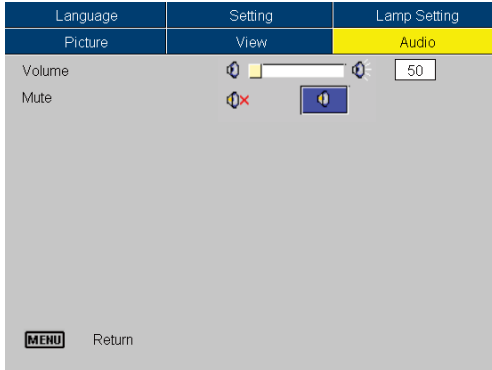

## Audio

### Volume

- ▶ Press the ◀ to decrease the volume.
- ▶ Press the ▶ to increase the volume.

### Mute

- ▶ Choose the left icon to turn mute on.
- ▶ Choose the right icon to turn mute off.

# User Controls

Picture	View	Audio
Language	Setting	Lamp Setting
English		Portugués
Deutsch		日本語
François		繁體中文
Italiano		简体中文
Español		한국어
Русский		Nederlands
Polski		Svenska

**MENU** Return

## Language

### Language

Choose the multilingual OSD menu. Use the ▲ or ▼ key to select your preferred language.

Press “Enter” to finalize the selection.



# User Controls

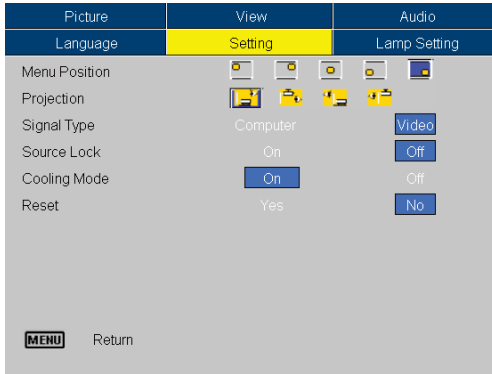

## Setting

### Menu Position

Choose the menu position on the display screen.

### Projection

- ▶  Front-Desktop

The factory default setting.

- ▶  Rear-Desktop

When you select this function, the projector reverses the image so you can project behind a translucent screen.

- ▶  Front-Ceiling

When you select this function, the projector turns the image upside down for ceiling-mounted projection.

- ▶  Rear-Ceiling

When you select this function, the projector reverses and turns the image upside down at same time. You can project from behind a translucent screen with ceiling mounted projection.

### Signal Type

Select signal type Computer or Video sources.

# User Controls

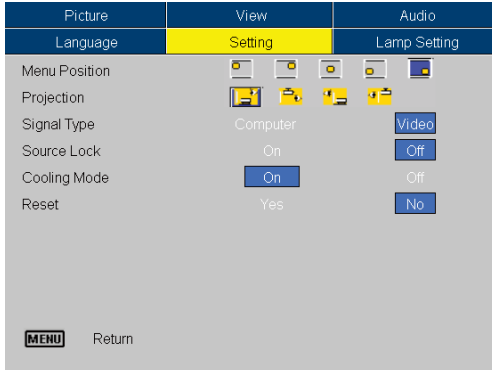

## Setting

### Source Lock

When this function is turned off, the projector will search for other signals if the current input signal is lost. When this function is turned on, it will search specified connection port.





### Cooling Mode

Choose "On" to turn on cooling mode. Operates the fans at full speed continuously to allow for proper high altitude cooling of the projector.

### Reset

Choose "Yes" to return the display parameters on all menus to the factory default settings.

# User Controls

Picture	View	Audio
Language	Setting	Lamp Setting
Lamp Timer	 <input type="text" value="50"/> 	<input type="text" value="50"/>
Lamp Timer Reset	Yes	No
Exchange Message	<input type="button" value="Yes"/>	No
Eco Mode	<input type="button" value="On"/>	Off
Auto Power Off (min.)	 <input type="text" value="180"/> 	<input type="text" value="180"/>

 Return

## Lamp Setting

### Lamp Timer

Display the cumulative lamp operating time.

### Lamp Timer Reset

Reset the lamp timer after replacing a new lamp.

### Exchange Message

Choose this function to show or to hide the warning message when the exchange message is displayed. The message will show up 30 hours before end of lamp life.



“Eco Mode” function is not supported for U6-112 Model.

### ECO Mode

Choose “On” to dim the projector lamp which will lower power consumption and extend the lamp life by up to 130%. Choose “Off” to return to normal mode.

### Auto Power Off (min)

Sets the interval of power-off of the system, if there is no signal input. (In minutes)

## Troubleshooting

If you experience trouble with the projector, refer to the following information. If the problem persists, please contact your local reseller or an authorized service center.

### **Problem: No image appears on screen**

- ▶ Ensure all the cables and power cables are correctly and securely connected as described in the “Installation” section.
- ▶ Ensure the pins of connectors are not crooked or broken.
- ▶ Check if the projection lamp has been securely installed. Please refer to the “Replacing the lamp” section.
- ▶ Make sure you have removed the lens cap and the projector is switched on.
- ▶ Ensure that the “Picture Mute” feature is not turned on.

### **Problem: Left or right edge of the image is missing or the image is unstable or noisy**

- ▶ Press “Auto” on the remote control or on control panel.
- ▶ If you are using a PC:

#### For Windows 3.x:

1. In the Windows Program Manager, double click the “Windows Setup” icon in the Main group.
2. Verify that your display resolution setting is less than or equal to 1280 x 1024 (U6-112) or 1400 x 1050 (U6-132/U6-232).

#### For Windows 95, 98, 2000, XP:

1. From the “My Computer” icon, open the “Control Panel” folder, and double click the “Display” icon.
2. Select the “Settings” tab.
3. Click on the “Advanced Properties” button.

**If the projector is still not projecting the whole image, you will also need to change the monitor display you are using. Refer to the following steps.**

4. Verify the resolution setting is less than or equal to 1280 x 1024 (U6-112) and 1400 x 1050 (U6-132/U6-232) resolution.

5. Select the “Change” button under the “Monitor” tab.
  6. Click on “Show all devices.” Next, select “Standard monitor types” under the SP box; choose the resolution mode you need under the “Models” box.
- ▶ If you are using a Notebook:
1. First, follow the steps above to adjust resolution of the computer.
  2. Press the toggle output settings. Example: [Fn]+[F4]

Compaq ⇒	[Fn]+[F4]	Hewlett Packard ⇒	[Fn]+[F3]
Dell ⇒	[Fn]+[F8]	FUJITSU ⇒	[Fn]+[F10]
Gateway ⇒	[Fn]+[F4]	NEC ⇒	[Fn]+[F4]
IBM ⇒	[Fn]+[F7]	Toshiba ⇒	[Fn]+[F5]

Mac Apple:  
System Preference ⇒ Display ⇒ Arrangement ⇒ Mirror display

- ▶ If you experience difficulty changing resolutions or your monitor freezes, restart all equipment including the projector.

## **Problem: The screen of the Notebook or PowerBook computer is not displaying a presentation**

- ▶ If you are using a Notebook PC:  
Some Notebook PCs may deactivate their own screens when a second display device is in use. Each has a different way to be reactivated. Refer to your computer’s documentation for detailed information.

## **Problem: Image is unstable or flickering**

- ▶ Use “Tracking” to correct it. (See page 25)
- ▶ Change the monitor color setting on your computer.

## **Problem: Image has vertical flickering bar**

- ▶ Use “Frequency” to make an adjustment. (See page 25)
- ▶ Check and reconfigure the display mode of your graphic card to make it compatible with the product.

## **Problem: Image is out of focus**

- ▶ Adjust the Focus Ring on the projector lens.

# Appendices

- ▶ Make sure the projection screen is between distance 4.92 to 38.75 feet (1.5 to 11.8 meters) from the projector. (See page 16)

**Problem: The image is stretched when displaying 16:9 DVD**  
The projector automatically detects 16:9 DVD and adjusts the aspect ratio by digitizing to full screen with 4:3 default setting.

If the image is still stretched, you will also need to adjust the aspect ratio by referring to the following:

- ▶ Please select 4:3 aspect ratio type on your DVD player if you are playing a 16:9 DVD.
- ▶ If you can't select 4:3 aspect ratio type on your DVD player, please select 4:3 aspect ratio in the on screen menu.

**Problem: Image is reversed**

- ▶ Select "Setting → Projection" from the OSD and adjust the projection direction. (See page 29)

**Problem: Lamp burns out or makes a popping sound**

- ▶ When the lamp reaches its end of life, it will burn out and may make a loud popping sound. If this happens, the projector will not turn on until the lamp module has been replaced. To replace the lamp, follow the procedures in the "Replacing the Lamp". (See page 36)

**Problem: LED lighting message**

Message	Power-LED (Green)	Temp-LED	Lamp-LED
Standby State (Input power cord)	Flashing	○	○
Lamp lighting	☀	○	○
Power on	☀	○	○
Power off (Cooling)	☀	○	○
Error (Lamp fail)	○	○	☀
Error (Thermal fail)	☀	☀	○
Error (Fan fail)	○	Flashing	○
Error (Over Temp.)	○	☀	○
Error (Lamp Breakdown)	○	○	☀



Steady light ⇒ ☀  
No light ⇒ ○

## Problem: Message Reminders

▶ Fan failed:

Fan Fail.

Projector will automatically turn off soon.

▶ Overheated:

Projector Overheated.

Projector will automatically turn off soon.

▶ Replacing the lamp:

Lamp is approaching the end of its useful life in full power operation.

Replacement suggested!

## Replacing the lamp

The projector will detect the lamp life itself. It will show you a warning message

Lamp is approaching the end of its useful life in full power operation.  
Replacement suggested!



Warning: Lamp compartment is hot!  
Allow it to cool down before changing lamp!

When you see this message, change the lamp as soon as possible.

Make sure the projector has been cooled down for at least 30 minutes before changing the lamp.

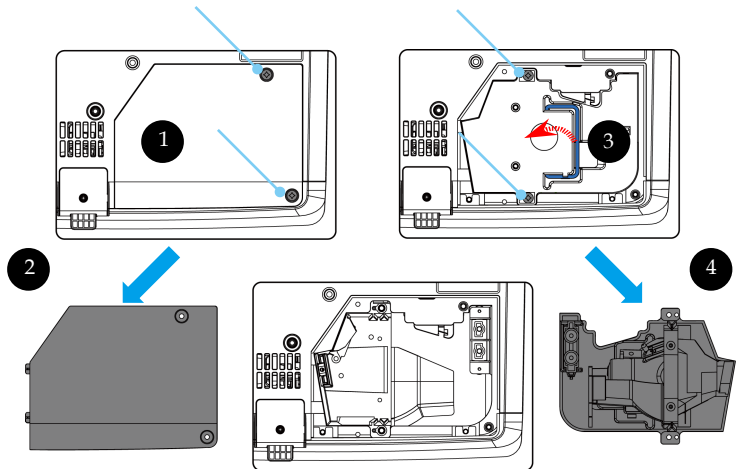

Warning: To reduce the risk of personal injury, do not drop the lamp module or touch the lamp bulb. The bulb may shatter and cause injury if it is dropped.

### Lamp Replacing Procedure:

1. Turn off the projector by pressing the Power/Standby button.
2. Allow the projector to cool down at least 30 minutes.
3. Disconnect the power cord.
4. Use a screwdriver to remove the 2 screws from the cover. ❶
5. Push up and remove the cover. ❷
6. Remove the 2 screws from the lamp module. ❸
7. Pull out the lamp module. ❹

To replace the lamp module, reverse the previous steps.



# Appendices

## Compatibility Modes (U6-112)

Mode	Resolution	(ANALOG)	
		V.Frequency (Hz)	H.Frequency (kHz)
VESA VGA	640 x 350	70	31.5
VESA VGA	640 x 350	85	37.9
VESA VGA	640 x 400	85	37.9
VESA VGA	640 x 480	60	31.5
VESA VGA	640 x 480	72	37.9
VESA VGA	640 x 480	75	37.5
VESA VGA	640 x 480	85	43.3
VESA VGA	720 x 400	70	31.5
VESA VGA	720 x 400	85	37.9
VESA SVGA	800 x 600	56	35.2
VESA SVGA	800 x 600	60	37.9
VESA SVGA	800 x 600	72	48.1
VESA SVGA	800 x 600	75	46.9
VESA SVGA	800 x 600	85	53.7
VESA XGA	1024 x 768	60	48.4
VESA XGA	1024 x 768	70	56.5
VESA XGA	1024 x 768	75	60.0
VESA XGA	1024 x 768	85	68.7
* VESA SXGA	1152 x 864	70	63.8
* VESA SXGA	1152 x 864	75	67.5
* VESA SXGA	1280 x 1024	60	63.98
* VESA SXGA	1280 x 960	60	60.0
MAC LC 13"	640 x 480	66.66	34.98
MAC II 13"	640 x 480	66.68	35
MAC 16"	832 x 624	74.55	49.725
* MAC 19"	1024 x 768	75	60.24
* MAC	1152 x 870	75.06	68.68
MAC G4	640 x 480	60	31.35
* i MAC DV	1024 x 768	75	60
* i MAC DV	1152 x 870	75	68.49



Remark :  
 "\*" compressed  
 computer image.

# Appendices

## Compatibility Modes (U6-132/U6-232)

Mode	Resolution	(ANALOG)	
		V.Frequency (Hz)	H.Frequency (kHz)
VESA VGA	640 x 350	70	31.5
VESA VGA	640 x 350	85	37.9
VESA VGA	640 x 400	85	37.9
VESA VGA	640 x 480	60	31.5
VESA VGA	640 x 480	72	37.9
VESA VGA	640 x 480	75	37.5
VESA VGA	640 x 480	85	43.3
VESA VGA	720 x 400	70	31.5
VESA VGA	720 x 400	85	37.9
VESA SVGA	800 x 600	56	35.2
VESA SVGA	800 x 600	60	37.9
VESA SVGA	800 x 600	72	48.1
VESA SVGA	800 x 600	75	46.9
VESA SVGA	800 x 600	85	53.7
VESA XGA	1024 x 768	60	48.4
VESA XGA	1024 x 768	70	56.5
VESA XGA	1024 x 768	75	60.0
VESA XGA	1024 x 768	85	68.7
* VESA SXGA	1152 x 864	70	63.8
* VESA SXGA	1152 x 864	75	67.5
* VESA SXGA	1152 x 864	85	77.1
* VESA SXGA	1280 x 1024	60	63.98
* VESA SXGA	1280 x 1024	75	79.98
* VESA SXGA+	1400 x 1050	60	63.98
MAC LC 13"	640 x 480	66.66	34.98
MAC II 13"	640 x 480	66.68	35
MAC 16"	832 x 624	74.55	49.725
MAC 19"	1024 x 768	75	60.24
* MAC	1152 x 870	75.06	68.68
MAC G4	640 x 480	60	31.35
i MAC DV	1024 x 768	75	60
* i MAC DV	1152 x 870	75	68.49
* i MAC DV	1280 x 960	60	60.0



Remark :

"\*" compressed computer image.

## Ceiling Mount Installation

1. To prevent damaging your projector, please use the ceiling mount package for installation.
2. If you wish to use a third party ceiling mount kit, please ensure the screws used to attached a mount to the projector met the following specifications:

- ▶ **Screw type: M3**
- ▶ **Maximum screw length: 10mm**
- ▶ **Minimum screw length: 8mm**



Please note that damage resulting from incorrect installation will invalidate the warranty.



### Warning:

1. If you buy the ceiling mount from other company, please ensure that there is at least 10cm distance between the bottom cover of the projector and the ceiling.
2. Don't install the projector near the air condition and the heater, avoid flowing into the projector directly that caused it shot down.

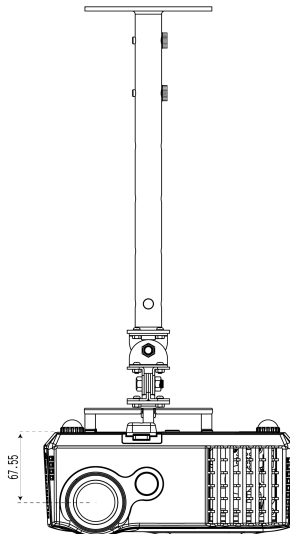
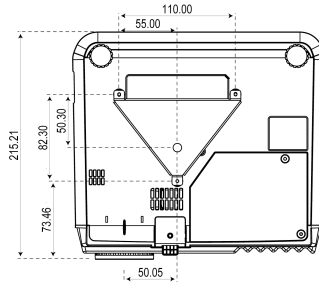

## Important

- ❑ DLP® and DLPlogo are registered trademarks of Texas Instruments Incorporated.
- ❑ VGA and XGA are registered trademarks of International Business Machines Corporation.
- ❑ SVGA is a registered trademark of Video Electronics Standards Association.
- ❑ Microsoft and Windows are registered trademarks of Microsoft Corporation.
- ❑ Macintosh is registered trademark of Apple Computer Inc.
- ❑ Adobe® Acrobat® Reader is a registered trademark of Adobe Systems Incorporated.

**Note that even in the absence of explanatory notes, serious attention is paid to the trademarks of the various companies and to the product trademarks.**

# Appendices

SPECIFICATION			
	U6-112	U6-132	U6-232
<b>Optical</b>			
Method of Projection	DLP® (single DLP® chip)		
DLP® chip	0.55 inch 800 X 600	0.55 inch 1024 X 768	0.55 inch 1024 X 768
Lamp	180 W high pressure mercury lamp	200 W high pressure mercury lamp	230 W high pressure mercury lamp
Projection Lens	Manual zoom: (X 1.1) Manual focus: F=2.35 - 2.47 f =21.8 - 23.8 mm 0.86 - 0.94 inch		
Image Size	Minimum: 34.7 inch at projection distance of 1.5 m (4.92 feet) (tele) Maximum: 300 inch at projection distance of 11.8 m (38.75) (wide)		
Light Output	1,800 lm	2,000 lm	2,500 lm
Contrast Ratio	2000:1 (full on/off)		
<b>Electrical</b>			
Input (Video)	NTSC3.58, NTSC4.43, PAL, PAL-N, PAL-M, PAL 60, SECAM, YCbCr ( NTSC, PAL ), YPbPr ( 480p, 576p, 1080i, 720p )		
Input (Computer)	Horizontal		
	31.5 - 68.7kHz	31.5 - 80.0kHz	31.5 - 80.0kHz
	Vertical		
	56 - 85Hz	56 - 85Hz	56 - 85Hz
Color Reproduction	Full color (16.77 million colors)		
Resolution	VGA (640 X 480) expansion/true	VGA (640 X 480) expansion/true	
	SVGA (800 X 600) true	SVGA (800 X 600) expansion/true	
	XGA (1024 X 768) compression	XGA (1024 X 768) true	
	SXGA (1280 X 1024) compression	SXGA (1280 X 1024) compression	
	-	SXGA+ (1400 X 1050) compression	
Input Current	2.8 A	2.8 A	3.5 A
Power Requirement	AC 100V ~ 240V, 50/60Hz		
Power Consumption	250 W	255 W (195 W in eco mode)	300 W (230 W in eco mode)
<b>Mechanical</b>			
Dimensions	238mm(W) X 93 mm(H) X 209 mm(D) 9.4 inch(W) X 3.7 inch(H) X 8.2 inch(D) (not including protrusion)		
Weight	2.0 kg (4.4 lbs)		
Environment	5 - 35 °C (32 - 95 °F) / humidity 0 ~ 80%		



Specifications and design are subject to change without notice.

# **KAGA COMPONENTS CO.,LTD.**

2-2-9, Hongo, Bunkyo-ku  
TOKYO 113-0033, JAPAN  
[www.taxan.co.jp/projector/](http://www.taxan.co.jp/projector/)  
email: [supportmail@kgcompo.co.jp](mailto:supportmail@kgcompo.co.jp)