

myprojectorlamps.com

**The most trusted, dependable name
in projector lamp sales.**



<http://www.myprojectorlamps.com>



<http://www.myprojectorlamps.ca>



<http://www.myprojectorlamps.eu>

The following projector manual has not been modified or altered in any way.

TAXAN

DATA PROJECTOR User's Manual

KG-PS100S KG-PS120X KG-PS125X

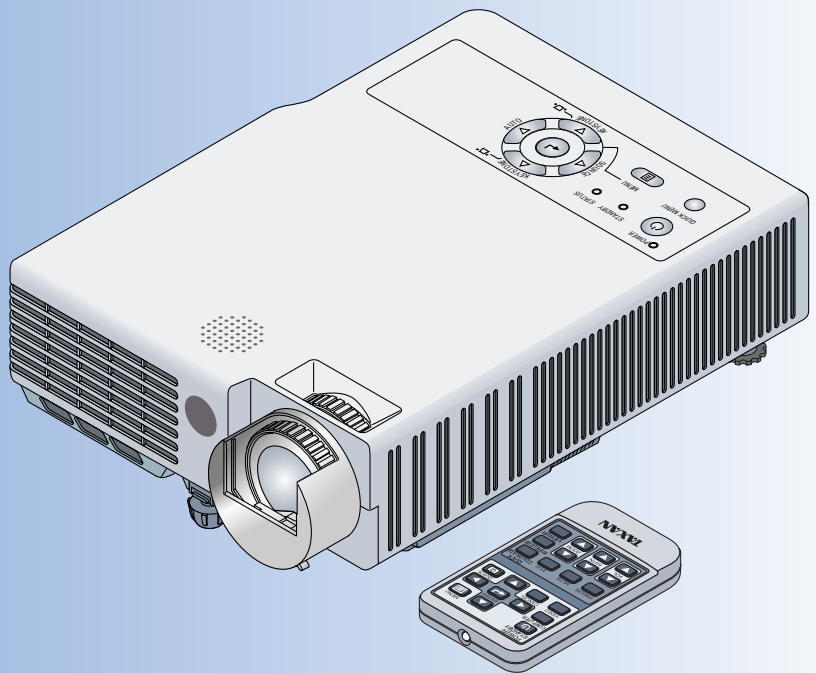

IMPORTANT

- * DLP® (Digital Light Processing) and DLP® chip are registered trademarks of Texas Instruments Incorporated (U.S.A.).
- * VGA and XGA are trademarks or registered trademarks of International Business Machines Corporation (U.S.A.).
- * S-VGA is a registered trademark of Video Electronics Standards Association.
- * Microsoft, Windows, and PowerPoint are registered trademarks of Microsoft Corporation (U.S.A. and other countries).
- * Macintosh is a trademark of Apple Computer Inc. (U.S.A.).

Note that even in the absence of explanatory notes, serious attention is paid to the trademarks of the various companies and to the product trademarks.

DECLARATION OF CONFORMITY

This device complies with Part 15 of the FCC Rules. Operation is subject to the following two conditions. (1) This device may not cause harmful interference, and (2) this device must accept any interference received, including interference that may cause undesired operation.

U.S. Responsible Party:	PLUS Vision Corp. of America
Address:	9610 SW Sunshine Court Suite 500 Beaverton, OR 97005
Tel. No.:	(503) 748 8700

Type of Product:	Projector
Equipment Classification:	Class B Peripheral
Models:	KG-PS100S, KG-PS120X

*We hereby declare that the equipment specified above
conforms to the technical standards as specified in the FCC Rules.*



IMPORTANT SAFETY INFORMATION

Precautions

Please read this manual carefully before using your KAGA COMPONENTS Data Projector and keep the manual handy for future reference.

This user's manual covers models KG-PS100S, KG-PS120X, and KG-PS125X.

The projection distance is the same in these models, but the inclusion of functions that can use Image Viewer and Wireless Network depends on the model.

See the table below for details.

This manual describes the full complement of functions of the KG-PS125X model.

Model Name	Wireless Network	Image Viewer	Display Resolution
KG-PS125X	○	○	1024 × 768 (XGA)
KG-PS120X	—	—	1024 × 768 (XGA)
KG-PS100S	—	—	800 × 600 (S-VGA)

○ : Function included — : Function not included

Note that when a function is applicable to a certain model, **Applicable Model: KG-PS * * * *** will be cited at the location of the description.



CAUTION

TO PREVENT SHOCK, DO NOT OPEN THE CABINET. NO USER-SERVICEABLE PARTS INSIDE. REFER SERVICING TO QUALIFIED KAGA COMPONENTS SERVICE PERSONNEL.



This symbol warns the user that uninsulated voltage within the unit may have sufficient magnitude to cause electric shock. Therefore, it is dangerous to make any kind of contact with any part inside of this unit.



This symbol alerts the user that important literature concerning the operation and maintenance of this unit has been included. Therefore, it should be read carefully in order to avoid any problems.

The above cautions are given on the bottom of the product.

WARNING

TO PREVENT FIRE OR SHOCK, DO NOT EXPOSE THIS UNIT TO RAIN OR MOISTURE. DO NOT USE THIS UNIT'S GROUNDED PLUG WITH AN EXTENSION CORD OR IN AN OUTLET UNLESS ALL THREE PRONGS CAN BE FULLY INSERTED. DO NOT OPEN THE CABINET. THERE ARE HIGH-VOLTAGE COMPONENTS INSIDE. ALL SERVICING MUST BE DONE BY QUALIFIED KAGA COMPONENTS SERVICE PERSONNEL.

Applicable Model: KG-PS100S/KG-PS120X

RF Interference

WARNING

This equipment has been tested and found to comply with the limits for a Class B digital device, pursuant to Part 15 of the FCC Rules. These limits are designed to provide reasonable protection against harmful interference in a residential installation. This equipment generates, uses and can radiate radio frequency energy and, if not installed and used in accordance with the instructions, may cause harmful interference to radio communications. However, there is no guarantee that interference will not occur in a particular installation. If this equipment does cause harmful interference to radio or television reception, which can be determined by turning the equipment off and on, the user is encouraged to try to correct the interference by one or more of the following measures:

- Reorientate or relocate the receiving antenna.
- Increase the separation between the equipment and receiver.
- Connect the equipment into an outlet on a circuit different from that to which the receiver is connected.
- Consult the dealer or an experienced radio/TV technician for help.

DOC Compliance Notice

This Class B digital apparatus meets all requirements of the Canadian Interference-Causing Equipment Regulations.

Hg: Lamp in This Product Contains Mercury. Dispose of Lamp According to Local, State or Federal Law.

IMPORTANT SAFETY INFORMATION

Applicable Model: KG-PS125X

WARNING

This is a class A product. In a domestic environment this product may cause radio interference in which case the user may be required to take adequate measures.

RF Interference

WARNING

The Federal Communications Commission does not allow any modifications or changes to the unit EXCEPT those specified by KAGA COMPONENTS in this manual. Failure to comply with this government regulation could void your right to operate this equipment.

This equipment has been tested and found to comply with the limits for a Class A digital device, pursuant to Part 15 of the FCC Rules. These limits are designed to provide reasonable protection against harmful interference when the equipment is operated in a commercial environment. This equipment generates, uses, and can radiate radio frequency energy and, if not installed and used in accordance with the instruction manual, may cause harmful interference to radio communications. Operation of this equipment in a residential area is likely to cause harmful interference in which case the user will be required to correct the interference at his own expense.

You are cautioned that changes or modifications not expressly approved by the party responsible for compliance could void your authority to operate the equipment.

DOC Compliance Notice

This Class A digital apparatus meets all requirements of the Canadian Interference-Causing Equipment Regulations.

IMPORTANT SAFETY INFORMATION

Important Safeguards

These safety instructions are to ensure the long life of the unit and to prevent fire and shock. Please read them carefully and heed all warnings.

Installation

- For best results, use the unit in a darkened room.
- Place the unit on a flat, level surface in a dry area away from dust and moisture.
- Do not place the unit in direct sunlight, near heaters or heat radiating appliances.
- Exposure to direct sunlight, smoke or steam can harm internal components.
- Handle the unit carefully. Dropping or jarring can damage internal components.
- Do not place heavy objects on top of the unit.

Power Supply

- The unit is designed to operate on a power supply of 100 - 240 V 50/60 Hz AC. Ensure that your power supply fits these requirements before attempting to use the unit.
- Handle the power cable carefully and avoid excessive bending. A damaged cord can cause electric shock or fire.
- Disconnect the power cable (main's lead) from the power outlet after using the unit. Before disconnecting the power cable, make sure that the STANDBY indicator lights in amber (not blinking or in green).

Cleaning

- Disconnect the power cable (main's lead) from the unit.
- Clean the cabinet of the unit periodically with a damp cloth. If heavily soiled, use a mild detergent. Never use strong detergents or solvents such as alcohol or thinner.
- Use a blower or lens paper to clean the lens, and be careful not to scratch or mar the lens.
- Clean the ventilation slots and speaker grills on the unit periodically using a vacuum cleaner. If accumulated dust blocks the ventilation slots, the unit will overheat, which may cause the unit to malfunction. Use a soft brush attachment when using the vacuum cleaner. Do not use a hard attachment, such as a crevice tool, to prevent the damage to the unit.

Lamp Replacement

- Be sure to replace the lamp when the Status indicator comes on. If you continue to use the lamp after 2000 hours of usage, the lamp will turn off.

Fire and Shock Precautions

- Ensure that there is sufficient ventilation and that vents are unobstructed to prevent the buildup of heat inside the unit. Allow at least 10 cm (4 inches) of space between the unit and walls.
- Prevent foreign objects such as paper clips and bits of paper from falling into the unit. Do not attempt to retrieve any objects that fell into the unit. Do not insert any metal objects such as a wire or screwdriver into the unit. If something should fall into the unit, immediately disconnect the power cable from the unit and have the object removed by a qualified KAGA COMPONENTS service person.
- Do not place any liquids on top of the unit.

Carrying around

When carrying the unit around, please use the storage case that comes with it and, to protect the lens from scratches, always shut the Iris Lens Cover. Also, do not subject the unit to strong mechanical shock.

CAUTION – HOT!

The area around the exhaust vents is hot during and immediately after image projection.

To avoid burns, keep your hands away from this area.

Wait until the exhaust vents area cools off before touching it.

Do not look into the lens while the unit is on. Serious damage to your eyes could result.

Major Features

■ High-brightness, lightweight projector with wireless network presentation and PC-less presentation functions

The synergy of DLP® technology and the unique optical design raises the efficiency of light usage. One DLP® chip reproduces the three primary colors (red, green, and blue) required in the expression of color. These factors have enabled the achievement of high brightness together with compact size and light weight. Also, by employing wireless LAN technology, wireless presentations can be made without having an RGB cable connection with the PC. Using the Image Viewer function enables image files that have been saved on SD memory cards or USB memory devices to be presented without carrying around a personal computer. (*1)

*1. For details, refer to the “Image Viewer / Wireless Network” section.

■ Sharp, clear picture

The DLP® display system affords RGB color fidelity and inconspicuous gaps between the individual dots, thereby permitting the display of small characters and diagrams with distinct clarity.

■ Advanced Color Wheel (ACW) allows for further enhancement of color reproduction

KAGA COMPONENTS' unique ACW preserves brightness, while allowing for superlatively enhanced color reproduction and astoundingly clear picture quality attainable only with DLP® technology.

■ High contrast ration of 2000:1

DLP® technology employed in this projector makes possible an astonishing 2000:1 high contrast ratio.

By widening the difference of brightness between black and white, you can see a degree of sharpness that is greater than just the brightness based on specifications.

■ Great moving image playback capabilities using the same principles as DLP® Cinema

KAGA COMPONENTS DLP® type projectors have the same makings as the DLP® Cinema used in movie theaters. Because of their extremely fast response, even images with much movement – sports, movies – play smoothly without blurring.

■ Security lock function

The lock can be set so that a password must be input when the projector is started up. Without the correct password, no operations other than turning the power on and off can be performed. This function effectively protects the projector from unauthorized use.

■ Powerful functions for presentations

A wide variety of easy-to-set functions have been built into the projector, from a digital keystone correction function (used when making settings) that corrects picture distortion, to an auto adjustment function that automatically identifies the PC signal.

There is also a built-in “Presentation Timer” function for further presentation convenience.

■ Beautiful reproduction of high-quality images from DVD

Faithful reproduction of color tones gives rise to the display of natural images. High-quality images such as those from DVD and digital high-definition television broadcasts bring out the display capabilities that are an essential strength of the DLP® display system projector.

Table of Contents

IMPORTANT SAFETY INFORMATION	E-2
Major Features	E-5
Table of Contents	E-6
Checking the Supplied Accessories	E-8
Names of the Main Unit Parts	E-10
Names of the Remote Control Parts	E-12
Preparing the Remote Control	E-13
Button Battery Replacement	E-13
Remote Control Range	E-13
The Procedure Up to Projecting to the Screen	E-14
Placement Guide	E-15
Screen Size and Projection Distance	E-15
Connecting Personal Computers and Video Equipment	E-16
Connections with Personal Computer	E-16
Connect the projector's COMPUTER IN connector using the included RGB signal cable.	E-16
To Output the External Output Signal of a Notebook Computer	E-17
Connections with Composite Signals	E-18
Video Equipment with VIDEO Connectors	E-18
Video Equipment with S-VIDEO Connectors	E-18
Connections with Component Signals	E-19
When the Video Equipment Has a YCbCr Connector or YPbPr Connector	E-19
Connections with the AUDIO Jack	E-20
Power Cable Connections and Switching the Power On/Off	E-21
Operating	E-21
Finishing	E-23
Adjustment of the Projection Screen	E-24
Adjustment of the Projection Screen	E-24
Making Adjustments with the Adjusters	E-25
General Operation	E-26
Input Selection	E-26
Automatic Adjustment	E-26
Selection of Aspect Ratio	E-27
Freezing a Moving Picture	E-28
Cancelling Video and Audio Temporarily	E-28
Eco Mode	E-28
Quick Color Adj.	E-28
Keystone Manual Adjustment	E-29
Adjustment of the Volume	E-29
Enlargement of the Image and Video Movement	E-30
Protecting the Projector with the Security Lock	E-31
Using the Quick Menu	E-33
Menu Operation Method	E-34
Performing Menu Operations	E-36
List of Item Names Offering Input Selection and Adjustments/Settings	E-39
Image	E-41
Brightness / Contrast / Color / Tint / Sharpness	E-41
Picture Adj. / Fine Picture / H Position / V Position	E-41
Reset	E-42
Color	E-43
Quick Color Adj.	E-43
Gamma	E-43
Color Temp.	E-44
White Level	E-44
Color Space	E-44
White Balance	E-45

Table of Contents

View	E-46
Aspect Ratio	E-46
Filter	E-46
Vertical Flip / Horizontal Flip	E-47
Keystone	E-47
Auto Keystone	E-47
Setup	E-48
Auto Source	E-48
Auto Power Off	E-48
Menu Position	E-48
Eco Mode	E-49
Input Format	E-49
Presentation Timer	E-50
Volume	E-50
Option	E-51
Language	E-51
On Screen	E-51
Background	E-51
Startup Screen	E-52
Security Lock	E-52
Network Password	E-52
Info	E-53
Status	E-53
Factory Default	E-53
Lamp Timer Reset	E-53
Resolution / Frequency	E-54
Lamp Timer	E-54
When an Indicator is Lit or Flashing	E-55
Troubleshooting	E-56
Cleaning	E-57
Replacing the Lamp Cartridge	E-58
Specifications	E-61
Table of Supported Frequency	E-64
Cabinet Dimensions	E-65

Checking the Supplied Accessories

Remove the main unit and the accessories from the box and check that the following items are included.

Wireless remote control unit (with wireless LAN) (includes one button battery) [1]

Applicable Projector: KG-PS125X

This controls the projector. Please remove the transportation insulation sheet at time of purchase. (See Page E-13.)

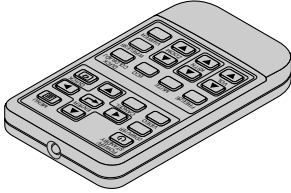

RGB signal cable (Mini D-sub 15-pin, 2 m / 6.6 feet) [1]

This is used in making connections with a personal computer. See Page E-16 about connections.

No. M01800500

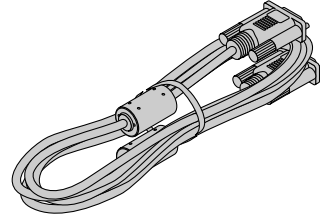

Wireless remote control unit (without wireless LAN) (includes one button battery) [1]

Applicable Projector: KG-PS100S/KG-PS120X

This controls the projector. Please remove the transportation insulation sheet at time of purchase. (See Page E-13.)

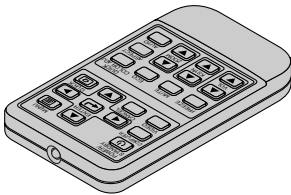

Audio conversion adapter (Mini plug / RCA pin plug, 15 cm / 0.5 feet) [1]

This cable is used with equipment whose audio connector is of the phono pin type. Connections are described on Page E-20.

No. M01800600

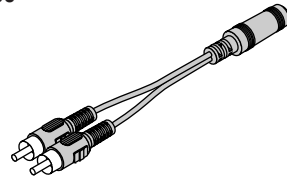

SD wireless LAN card [1]

Applicable Projector: KG-PS125X

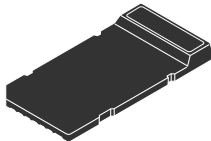

Power cable (1.8 m / 5.9 feet) [1]

This power cable supplies power to the unit. See Page E-21 about connections.

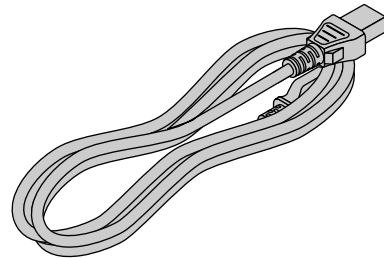

Ferrite cores [3]

These ferrite cores are attached to power cable, video cable and S-video cable.

Mounting → See Pages E-18, 21.

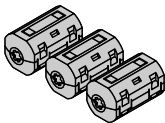

“WARNING”

Handling the cables supplied with this product, will expose you to lead, a chemical known to the State of California to cause birth defects or other reproductive harm. Wash hands after handling.

Checking the Supplied Accessories

Storage case (for projector and accessories) [1]

This case is designed to hold the projector itself and its accessories.

Use it when storing the projector.

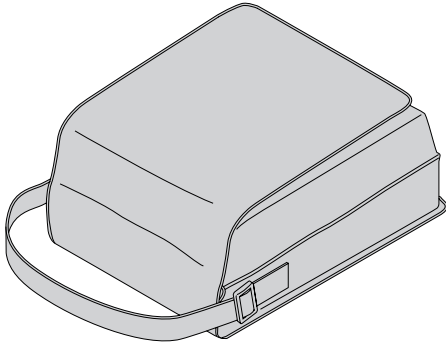

HOW TO PUT THE PROJECTOR INTO THE STORAGE CASE

Close the lens cover, then place the projector in the case with the lens facing upward.

Place the accessories in the storage pocket.

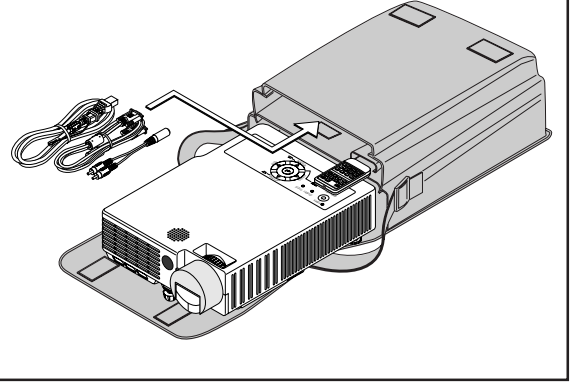

User's Manual (CD-ROM edition) [1]

User's Manual (Simplified Edition) [1]

Security Sheet [1]

Security Label [1]

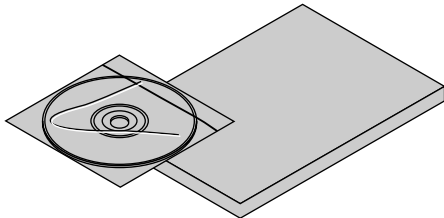

Names of the Main Unit Parts

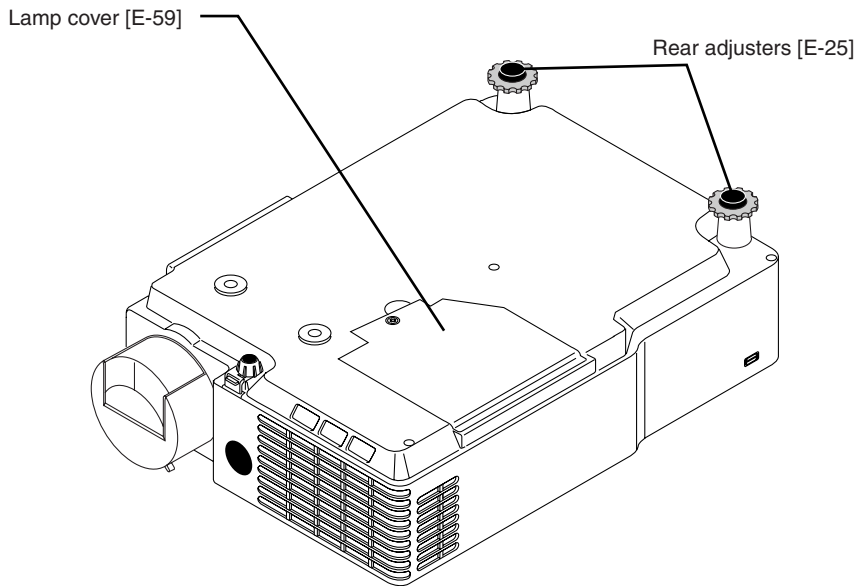
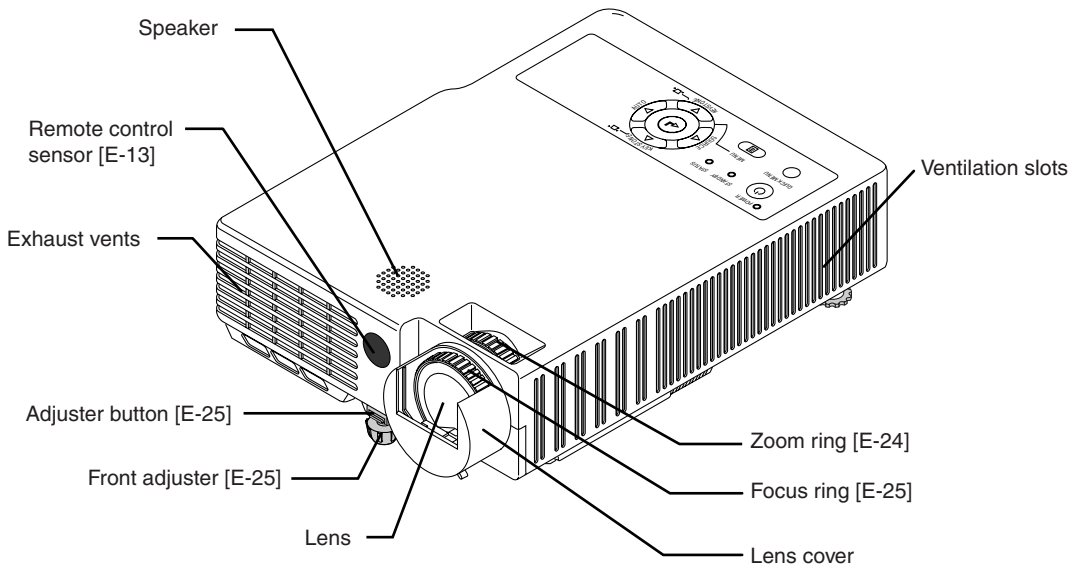

Names of the Main Unit Parts

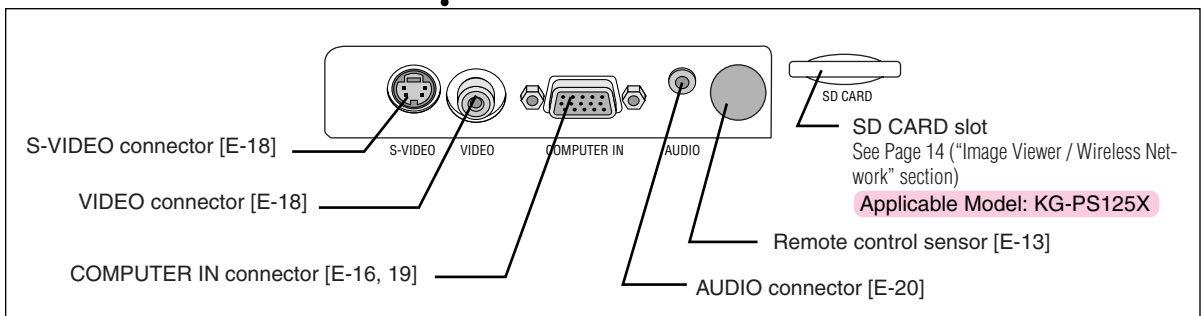
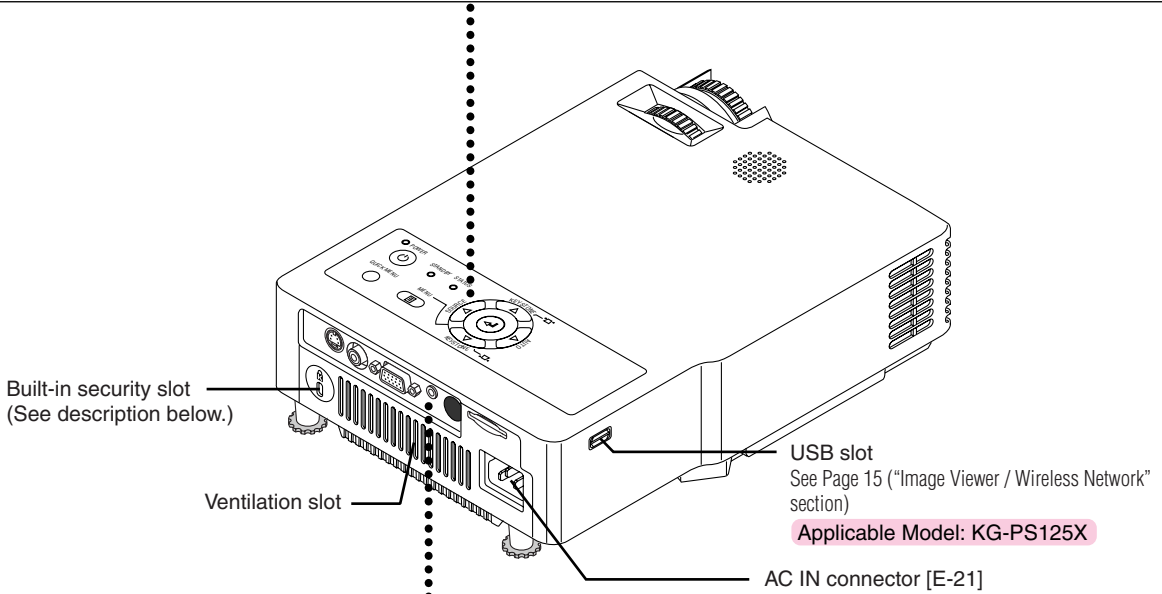
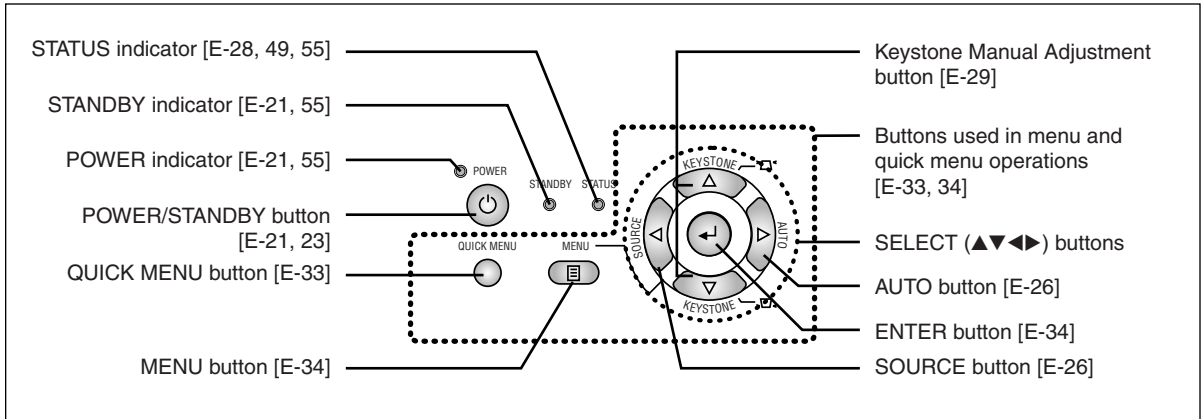

Built-in Security Slot

This security slot supports the MicroSaver Security System manufactured by Kensington Microware Inc.

Names of the Remote Control Parts

Two types of remote control are available for this projector, and both types are described. See the description of the remote control (and the drawing) for the type supplied with the projector.

Precautions

Handling of the Remote Control

- * Do not drop the remote control or handle it inappropriately.
- * Do not expose the remote control to water or other liquids. Should the remote control become wet, wipe it dry immediately.
- * Try to avoid use in hot and/or humid locations.
- * Please keep button battery out of the reach of children. If a battery is swallowed, promptly obtain the medical care of a doctor.
- * Remove the battery from the remote control when it is not going to be used for a long period.
- * Some operations (such as menu operations) are available only through the use of the remote control and attention should be given to its careful handling.

Names of the Remote Control Parts

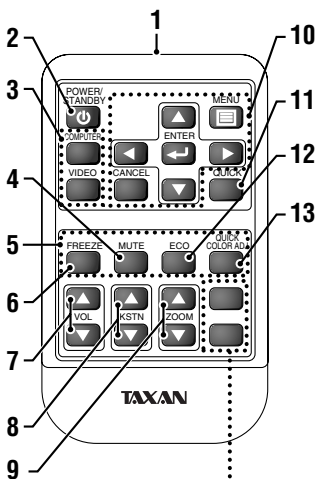

1. Infrared transmitter [E-13]
2. POWER/STANDBY button [E-21, 23]
This button is used to switch ON the power and set the unit to the STANDBY mode.
3. Buttons used for input selection [E-26]
COMPUTER button and VIDEO button (Video / S-Video)
4. MUTE button [E-28]
(Temporarily cancels the video and audio)
5. Input buttons [E-31]
(Used for the security lock.)
6. FREEZE button [E-28]
(Freezes moving pictures)
7. VOL button [E-29]
(Volume adjustment)
8. KSTN button [E-29]
(Keystone correction adjustment)
9. ZOOM button [E-30]
(Digital zoom adjustment)
10. SELECT Buttons [E-34]
The , , and buttons are the select (, , and buttons.
11. QUICK button [E-33]
(Displays a simplified menu)
12. ECO button [E-28]
(Selection of lamp mode)
13. QUICK COLOR ADJ button [E-28]

The function of the buttons below will differ depending on the model.

Applicable Model: KG-PS125X

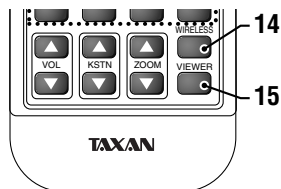

14. WIRELESS button
See "Image Viewer / Wireless Network" section.
15. VIEWER button
See "Image Viewer / Wireless Network" section.

Applicable Model: KG-PS100S/KG-PS120X

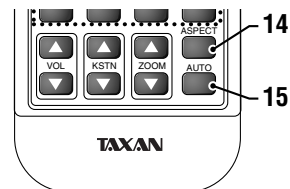

14. ASPECT button [E-27]
(Selects the vertical and horizontal ratio of the screen)
15. AUTO button [E-20]
(Automatic adjustment of the RGB moving image)

Preparing the Remote Control

Button Battery Replacement

Using the remote control for the first time

The battery compartment is fitted with a transportation insulation sheet at the time of shipping. Pull out the sheet and remove it. The remote control is now ready for use.

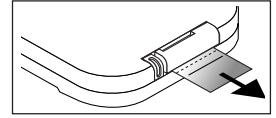

Replacement Method

1 (A) With the knob pressed to the right side, (B) draw out the battery case.

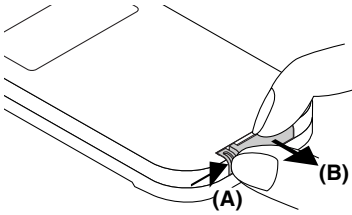

2 Remove the old battery and install a new button battery with (+) side facing upward in the battery holder.

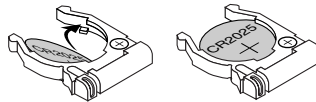

Purchase a CR2025 type battery for replacement.

3 Insert the battery holder into the remote control and push in until the battery holder closes with a “click” sound.

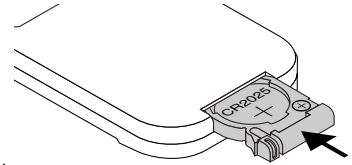

CAUTION

Danger of explosion if battery is incorrectly replaced.

Replace only with the same or equivalent type (CR2025) recommended by the manufacturer.

Dispose of used batteries according to your local regulations.

CAUTION

DISPOSE OF USED BATTERIES ACCORDING TO THE INSTRUCTIONS.

Remote Control Range

Point the infrared transmitter of the remote control toward the remote control sensor located at the front or rear of the main unit and operate.

Reception of the remote control signal should generally be possible within the range illustrated below.

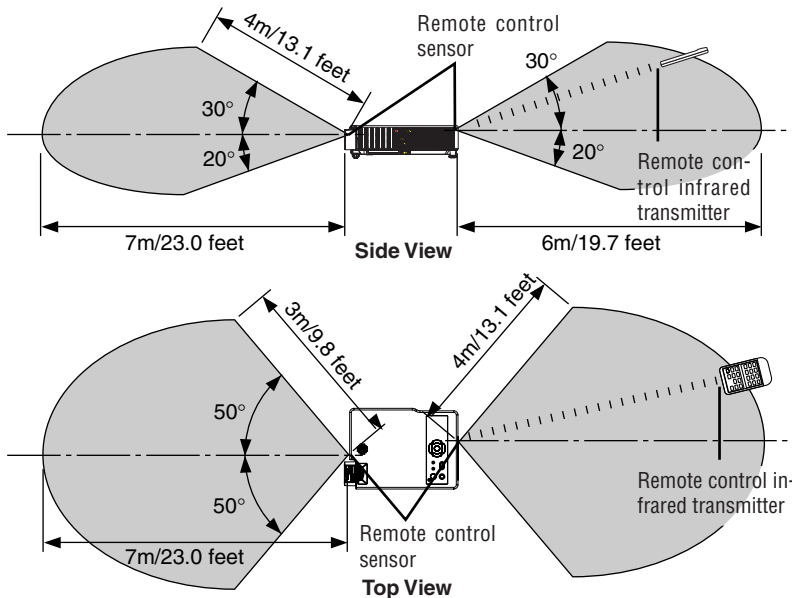

Note

* Exposure of the main unit's remote control sensor or the remote control infrared transmitter to bright light or the obstruction of the signal by an obstacle located in the pathway may prevent operation.

* To prevent operational difficulties with the sensor when the projector is installed suspended, install the projector 1.5 m or further from fluorescent lighting.

* The remote control will not function when the battery is exhausted.

The Procedure Up to Projecting to the Screen

Perform setup adjustments in the following order.

1 Position the projector

Determine the locations to set up the screen and the projector.
See "Placement Guide" on Page E-15.

2 Connect the video equipment and personal computer

Connect your equipment to the projector.

When making connections with the personal computer's RGB connector, see "Connections with Personal Computer" on Page E-16.

When making connections with the video equipment's video connector or an S-video connector, see "Connections with Composite Signals" on Page E-18.

When making connections with the video equipment's YCbCr connector or YPbPr connector, see "Connections with Component Signals" on Page E-19.

When playing the audio through the built-in speaker of the projector, see "Connections with the AUDIO Jack" on Page E-20.

3 Open the lens cover

4 Connect the power cable and switch on the projector power

See "Operating" on Page E-21.
See "Finishing" on Page E-23.

5 When selecting the language of menu displays, etc.

(Only when the power is first switched on following purchase)

See "When [Menu Language Select] is Displayed Upon Switching On the Power" on Page E-22.

6 Switching on the power of the personal computer and video equipment

7 Properly adjust the projection image to the screen

See "Adjustment of the Projection Screen" on Page E-24.

8 Selecting input equipment

See "Input Selection" on Page E-26.

9 Adjust the screen or video image

Adjust the image to the optimum condition as required.
See the Table of Contents for the adjustment items.

About DLP® projectors

Though careful attention is paid to providing optimum quality, please note that with DLP® type projectors, in rare cases there may be black spots or bright spots among the picture elements.

Note:

* Please purchase a screen.

* A component cable, which is commercially available, is required to connect a DVD player or other equipment having YCbCr connectors.

* A component cable, which is commercially available, is required to connect high definition (HD) video equipment or other equipment having YPbPr connectors.

Placement Guide

- Use this information as a guide to find out about the screen size when the projector is placed at a certain location, or to find out the approximate size of a screen that will be required.
- The projection distance over which focussing is adjustable is 1.20 m (3.9 feet) to 11.78 m (38.65 feet). The projector should be placed within this range.

Screen Size and Projection Distance

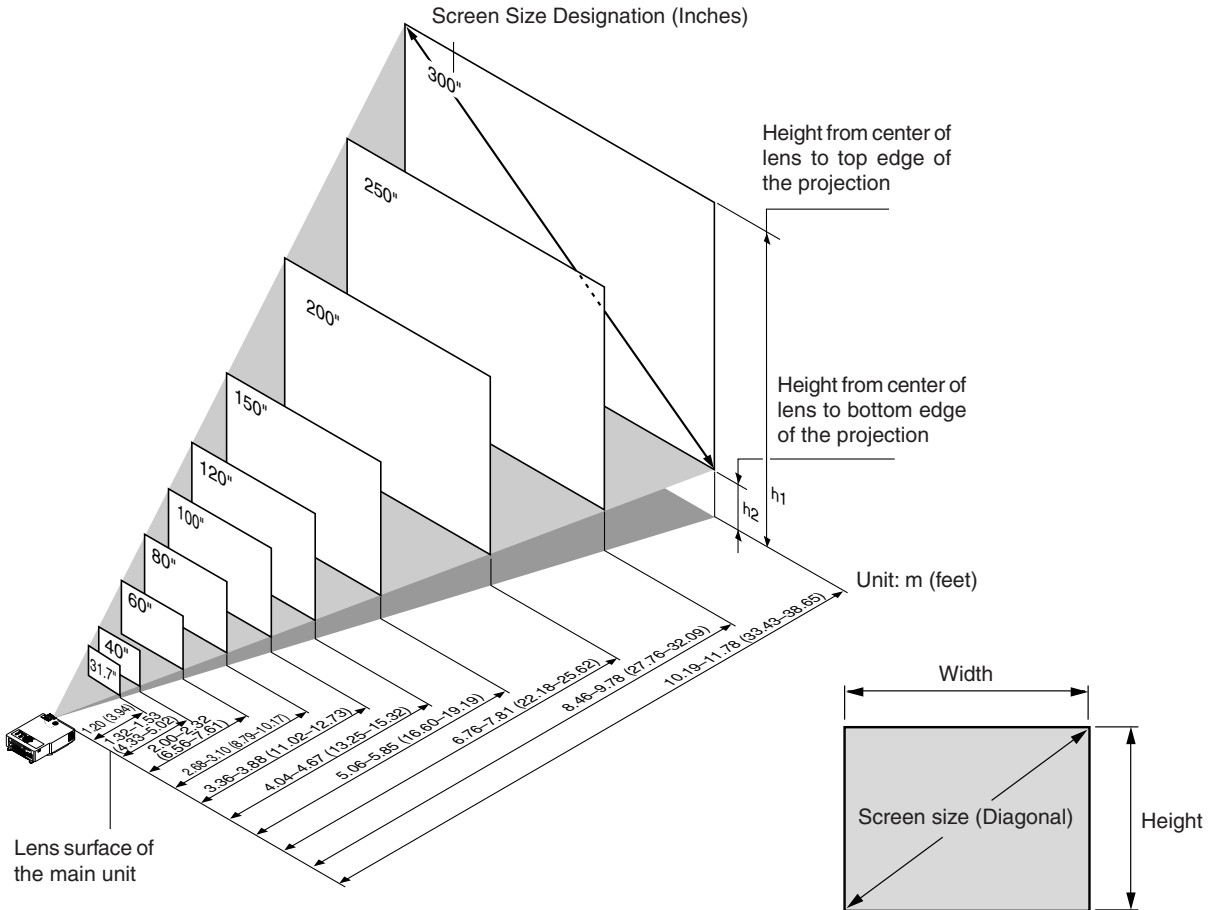

Screen Size Designation (Inches)	Screen Size Width x Height		Projection Distance		Height h1		Height h2	
	(m)	(feet)	(m)	(feet)	(m)	(feet)	(m)	(feet)
31.7"	0.64 × 0.48	2.11 × 1.59	— — 1.20	— — 3.94	0.54	2.09	0.06	0.20
40"	0.81 × 0.61	2.67 × 2.00	1.32 – 1.53	4.33 – 5.02	0.67	2.20	0.06	0.20
60"	1.22 × 0.91	4.00 × 3.00	2.00 – 2.32	6.56 – 7.61	1.00	3.30	0.09	0.30
80"	1.63 × 1.22	5.33 × 4.00	2.68 – 3.10	8.79 – 10.17	1.35	4.43	0.13	0.43
100"	2.03 × 1.52	6.67 × 5.00	3.36 – 3.88	11.02 – 12.73	1.68	5.52	0.16	0.52
120"	2.44 × 1.83	8.00 × 6.00	4.04 – 4.67	13.25 – 15.32	2.02	6.62	0.19	0.62
150"	3.05 × 2.29	10.00 × 7.50	5.06 – 5.85	16.60 – 19.19	2.53	8.29	0.24	0.79
200"	4.06 × 3.05	13.33 × 10.00	6.76 – 7.81	22.18 – 25.62	3.36	11.02	0.31	1.02
250"	5.08 × 3.81	16.67 × 12.50	8.46 – 9.78	27.76 – 32.09	4.20	13.78	0.39	1.28
300"	6.10 × 4.57	20.00 × 15.00	10.19 – 11.78	33.43 – 38.65	5.04	16.54	0.47	1.54

* There is a tolerance of $\pm 5\%$ due to design values.

* This table uses the lens apex and lens center as references and requires that the projector be in a horizontal condition (with front and rear adjusters fully withdrawn).

Connecting Personal Computers and Video Equipment

Connecting this unit with a personal computer permits presentation data to be projected as a large screen display at conferences, lectures, and on other occasions. Furthermore, connecting this unit to a DVD player or other video equipment source in combination with an audio/video amplifier and speaker system will allow you to enjoy convincing home theater.

Connections with Personal Computer

Please check the following before making connections with the personal computer.

- An appropriate resolution for the KG-PS100S is 800 x 600 dots (S-VGA), and the maximum displayable resolution is XGA (1024 x 768 dots).
An appropriate resolution for the KG-PS120X/KG-PS125X is 1024 x 768 dots (XGA), and the maximum displayable resolution is S-XGA (1280 x 1024 dots).
Change to a displayable resolution at the PC side. See “Table of Supported Frequencies” on Page E-64.
- The setting method for the personal computer will differ depending on the specific model. Please read the personal computer instruction manual or the on-line help information, or contact the manufacturer of your personal computer.

Connect the projector's COMPUTER IN connector using the included RGB signal cable.

- When making connections with the COMPUTER IN connector of the projector, please make the connection via the supplied RGB signal cable.
- The projector has been set to “Auto” at the factory; however, if it does not project, please change the input setting to “Computer” using the menu sequence of [Setup] → [Input Format] → [Computer].
See “Input Format” on Page E-49.

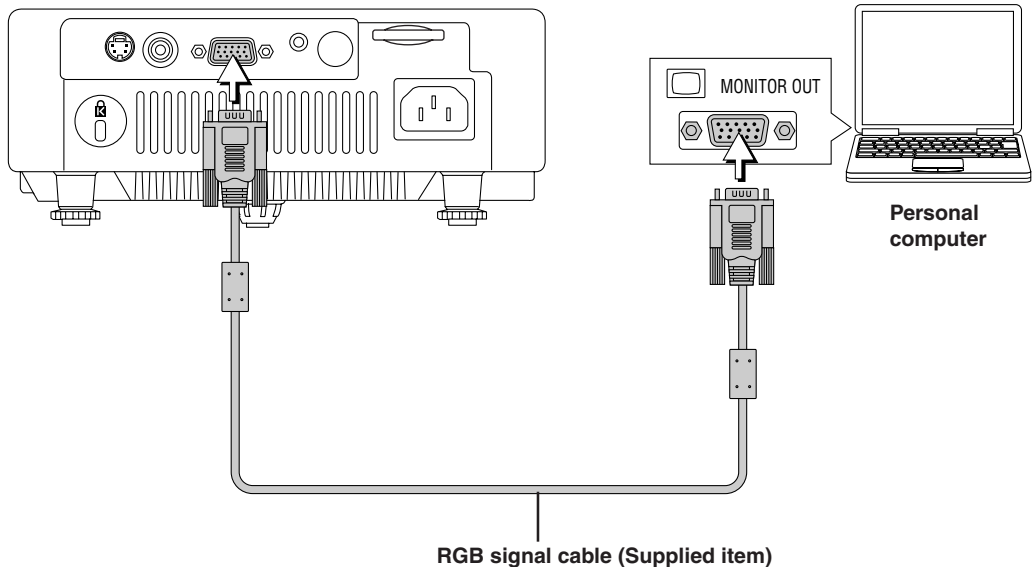

Note:

- * Before making connections, check the power of the projector and the equipment to be connected is switched off.
- * When projection will be with a notebook computer connected, knowledge will be required for the cable connection and notebook computer startup procedure as well as the operation that follows startup. Please consult the instruction manual of your notebook computer or the on-line help.

To Output the External Output Signal of a Notebook Computer

When projection will be with a notebook computer connected, knowledge will be required for the cable connection and notebook computer startup procedure as well as the operation that follows notebook startup. Please consult the instruction manual of your notebook computer or the on-line help while performing the following procedure.

- 1** Check whether a signal is being sent from the notebook computer to the projector.
An indication appearing on the liquid crystal display of the notebook computer does not necessarily mean that an external output signal is being output.
REFERENCE: When “Resolution” or “Frequency” is not displayed under “Info.” on the menu of the projector, this means that the external output signal is not being output from the personal computer. See “Resolution/Frequency” on Page E-64.

- 2** Should a sign not be output from the notebook computer, please try the operation described below.
For an IBM PC/AT compatible computer, press the [Fn] key plus any one of the [F1] to [F10] keys. (See the table below.)

Manufacturer	Model	Key
DELL	All computers	Fn + F8
EPSON	All computers	Fn + F8
FUJITSU	All computers	Fn + F10
MITSUBISHI	All computers	Fn + F5
IBM	All computers	Fn + F7
NEC	All computers	Fn + F3
Panasonic	All computers	Fn + F3
SHARP	All computers	Fn + F5
SONY	All computers	Fn + F7
SOTEC	All computers	Fn + F3–F5
TOSHIBA	All computers	Fn + F5
HITACHI	All computers	Fn + F7

Note: Table information is current to December 2006.

Note:

When the liquid crystal display of the notebook computer and the projector are displayed at the same time, the projected image might not be correct even though the liquid crystal display shows a correct indication. Should this occur, stop the simultaneous display of the notebook computer and try the mode with external output only. Try an operation such as that described in aforementioned Step 2 and try closing the liquid crystal panel which might result in external output only.

Connections with Composite Signals

Video Equipment with VIDEO Connectors

- Connect to the projector's VIDEO connector using a commercially available video cable.
- The input setting of the VIDEO connector has been set to "Auto" at the factory; however, if the projector does not project, please change the input setting to "Your Country's Television Broadcast System" using the menu sequence of [Setup] → [Input Format] → [Video].
See "Input Format" on Page E-49.

Video Equipment with S-VIDEO Connectors

- Connect to the projector's S-VIDEO connector using a commercially available S-Video cable.
- The input setting of the S-VIDEO connector has been set to "Auto" at the factory; however, if the projector does not project, please change the input setting to "Your Country's Television Broadcast System" using the menu sequence of [Setup] → [Input format] → [S-Video].
See "Input Format" on Page E-49.

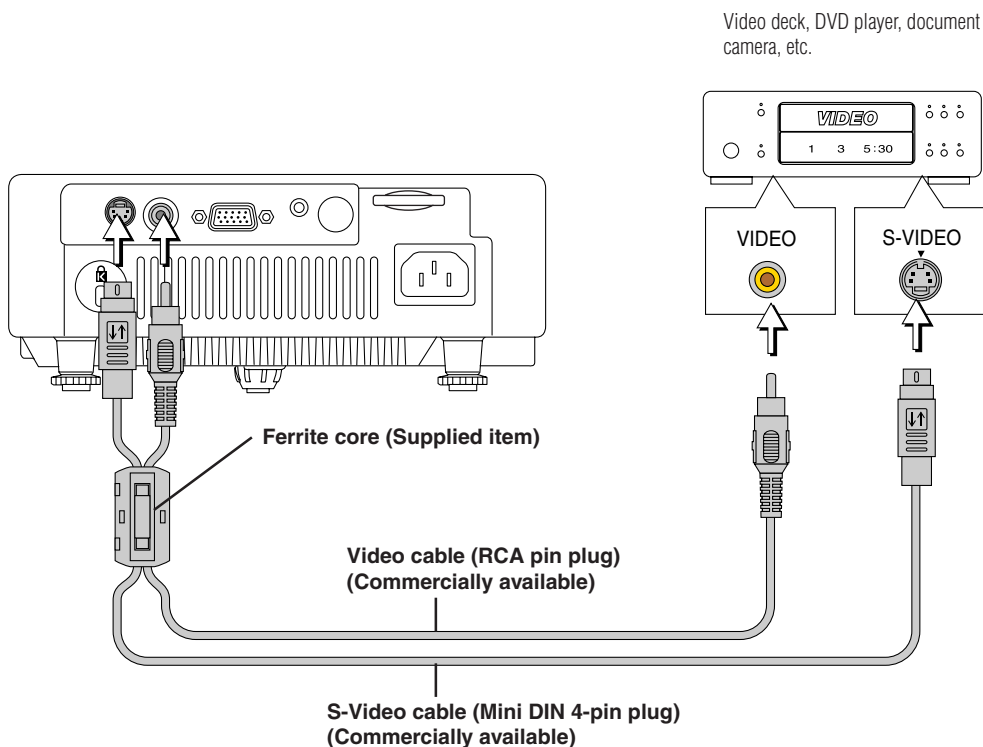

Attaching the Ferrite Core

Gather the commercially-available video cable and S-video cable as illustrated in the diagram and attach the supplied ferrite core.

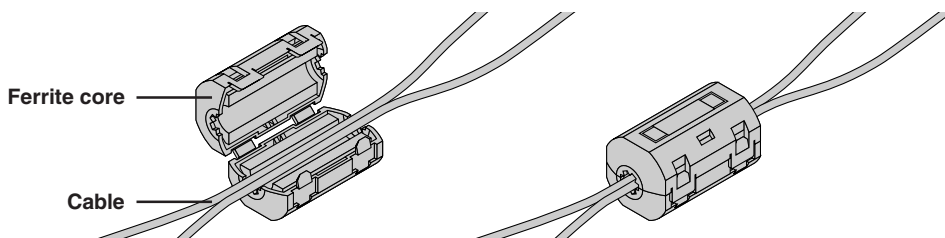

Connections with Component Signals

When the Video Equipment Has a YCbCr Connector or YPbPr Connector

- The projector has been set to “Auto” at the factory; however, if it does not project, please change the input setting to “Component” using the menu sequence of [Setup] → [Input Format] → [Computer]. See “Input Format” on Page E-49.
- When projecting the YCbCr signal or YPbPr signal, if the color of the overall image strongly leans toward being greenish or another color, change the setting under the menu of [Color] → [Color Space]. See “Color Space” on Page E-44.

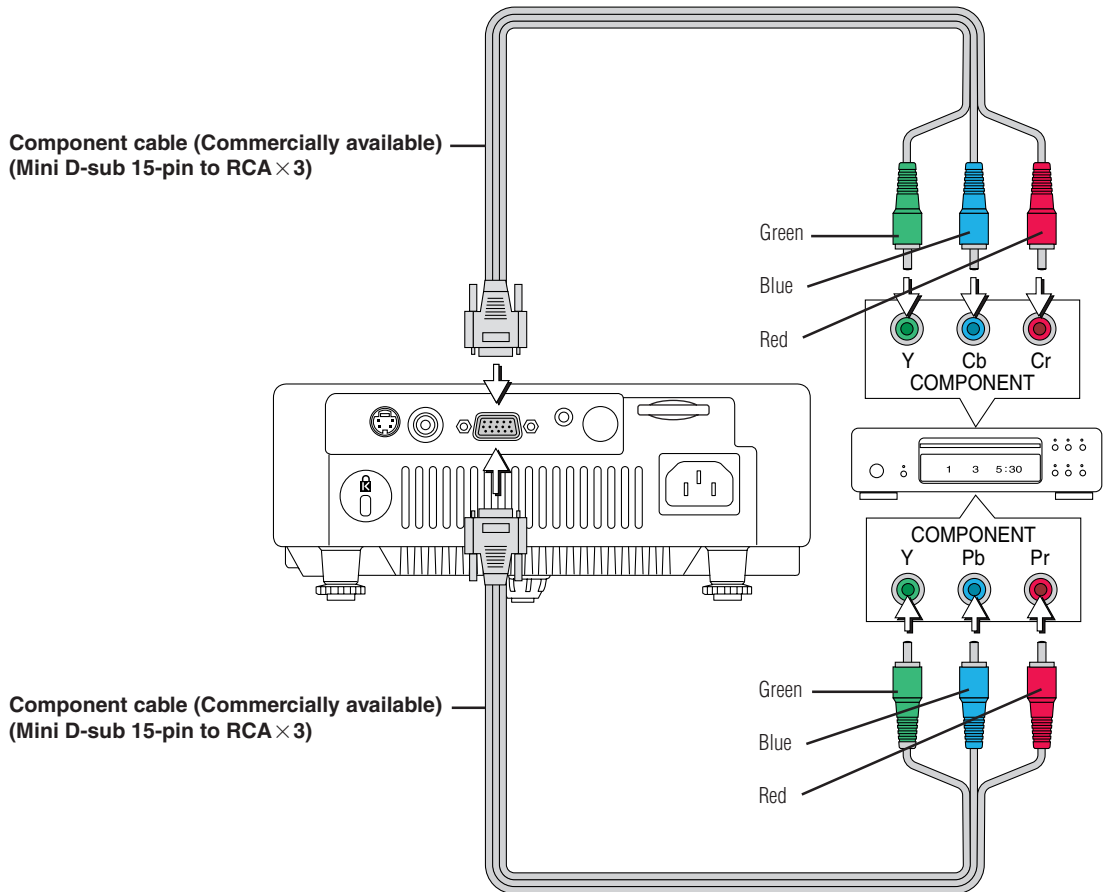

Connections with the AUDIO Jack

- * Connect to the projector's AUDIO jack using a commercially available audio cable. When the audio jack of the equipment that is to be connected is of the RCA phono type, make connection via the supplied audio conversion adapter.
- * The built-in speaker of the projector provides monaural audio. To enjoy convincing audio reproduction, please connect the audio output of the video equipment to your audio system.
- * The built-in speaker outputs the audio of the equipment connected to the AUDIO jack. The built-in speaker outputs the audio of the equipment connected to the AUDIO connector. Note that audio will not be output unless a video signal is input.

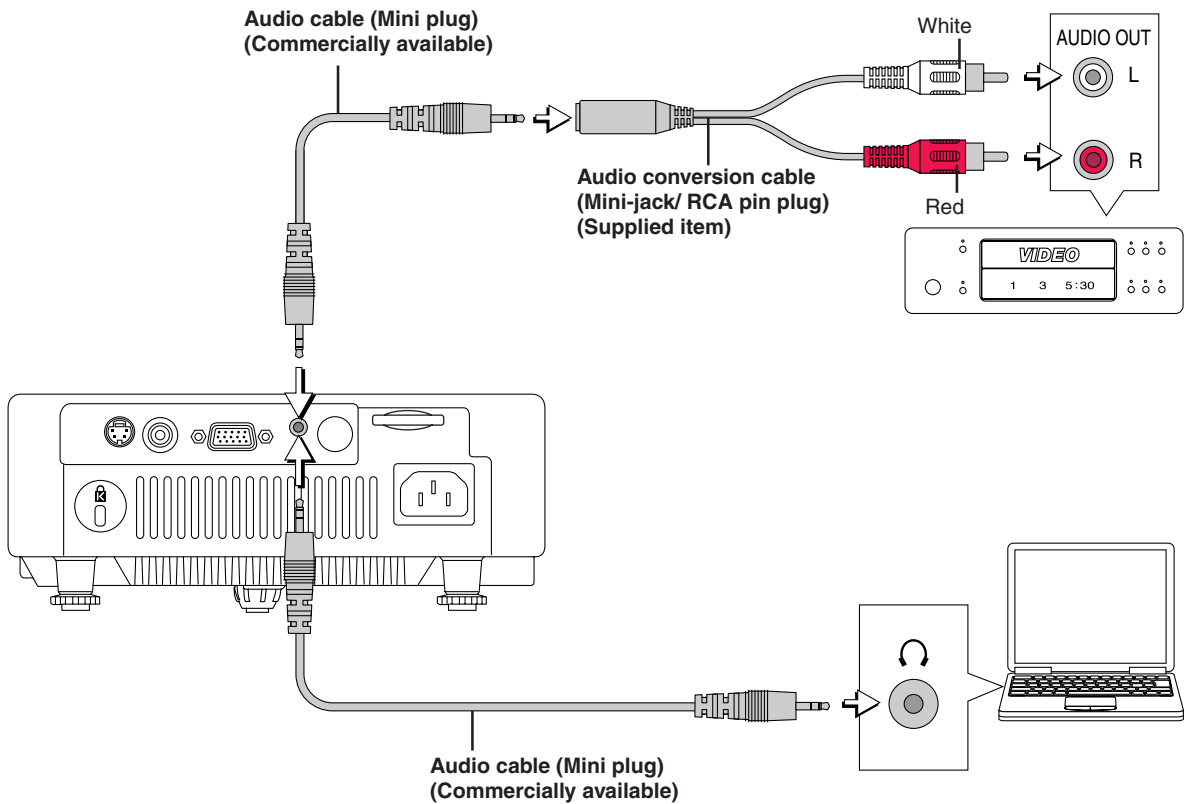

Power Cable Connections and Switching the Power On/Off

There is an order in which the power cable is connected and the power is switched on/off.

Operating

- 1** Connect the AC IN connector of the projector and the power outlet using the supplied power cable. The STANDBY indicator will light in green, and the unit will enter the standby mode.

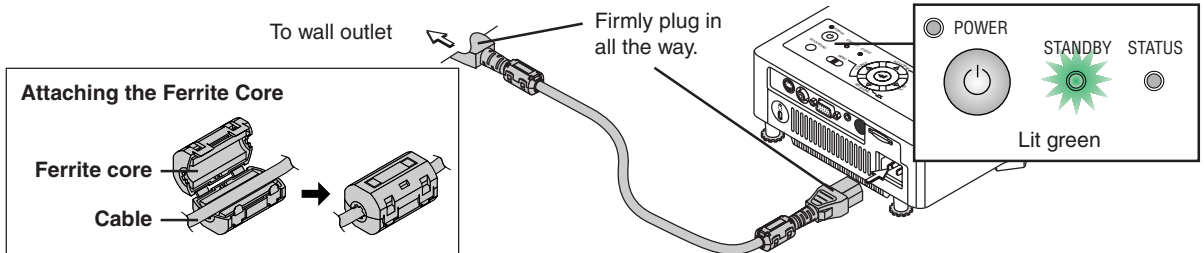

Note:

- When the power plug will be unplugged from the power outlet, please place the projector near the power outlet so that it may be reached easily.
- The included power cable is exclusively for use with this product. Never use it with other products.
- Press the POWER/STANDBY button after the STANDBY indicator is lit in green.

- 2** ① Turn the lens cover clockwise.

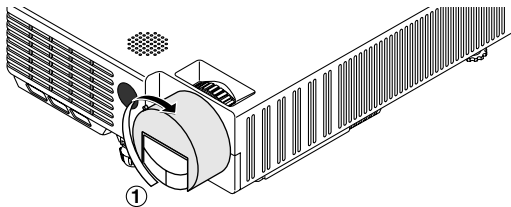

- ② When the lens cover stops with a click, the projector is ready for projection.

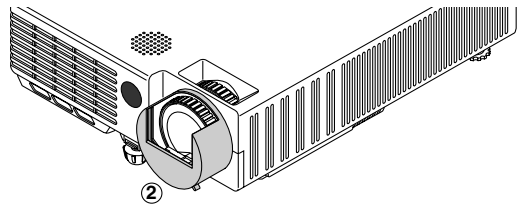

- 3** Switch on the projector power
Press the POWER/STANDBY button.



The first time the power is switched on after purchase, [Menu Language Select] will be displayed. See Page E-22 for information about language selection.

- When the power is turned on, the POWER indicator starts flashing green, then stops flashing after about 60 seconds. If the STATUS indicator lights green at this time, the lamp mode is set to "Eco". See E-28 and 49 for instructions on selecting.

Note:

While the POWER indicator is blinking, the power cannot be switched off. Check that the POWER indicator is lit steadily, then switch off the power.

- If the power does not come on, see "When the STATUS Indicator is Lit or Flashing" on Page E-55.

If the "Password" input window is displayed: See E-32.

A password is set for this projector. The projector cannot be used unless the correct password is input. To turn off the power: See E-23.

The projector is now capable of regular projection.

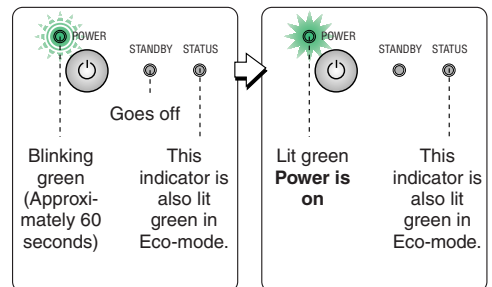
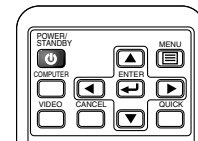

Note:

The image can be muted quickly by closing the lens cover while the image is being projected.

- 4** Switch on the power of the connected equipment

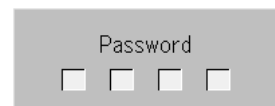

When [Menu Language Select] is Displayed Upon Switching On the Power

The first time the power is switched on after purchase, [Menu Language Select] will be displayed. Follow the procedure described below and select the display language of the projector.

If the image is blurred, turn the focus ring counterclockwise or clockwise to focus it. See Page E-25.

- 1 Press the SELECT (▲▼) buttons of the Remote control and align the deep blue cursor with [English].

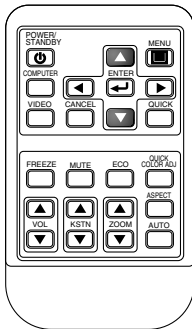

- 2 Press the ENTER button to set. This will set the language and [Menu Language Select] will close.

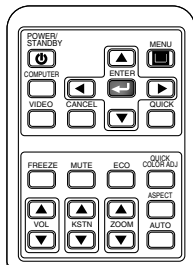

This completes the selection of the display language.

Menu Language Select	
Please select a menu language.	English
Выберите язык меню.	Русский
Wählen Sie bitte die Menü Sprache aus.	Deutsch
S'il vous plaît choisir la langue de menu.	Français
Per favore di scegliere la lingua di menu.	Italiano
Escoja por favor el idioma de menú.	Español
Välj menyn språken.	Svenska
메뉴언어를 선택하십시오	한국어
请选择项目单语言	中文
メニュー言語を選択して下さい。	日本語
Select "▲" "▼" & "ENTER"	

Menu Language Select		Cursor
Please select a menu language.	English	
Выберите язык меню.	Русский	
Wählen Sie bitte die Menü Sprache aus.	Deutsch	
S'il vous plaît choisir la langue de menu.	Français	
Per favore di scegliere la lingua di menu.	Italiano	
Escoja por favor el idioma de menú.	Español	
Välj menyn språken.	Svenska	
메뉴언어를 선택하십시오	한국어	
请选择项目单语言	中文	
メニュー言語を選択して下さい。	日本語	
Select "▲" "▼" & "ENTER"		

Caution:

[Menu Language Select] will not appear the next time the power is switched on. Should a change of language become necessary, see "Language" on Page E-51.

Finishing

1 Switch off the power of the connected equipment

2 Switch off the power of the projector

Press the POWER/STANDBY button.

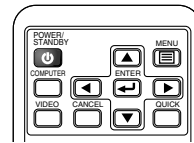

The message display appears. One more press of the POWER/STANDBY button as described in the message will switch off the projection screen and cause the projector to enter the power-off operation.

Note:

* The operation can be cancelled by pressing a button other than the POWER/STANDBY button.

The POWER indicator will change to a blinking green, then go off about 90 seconds later, and the STANDBY indicator will light steadily.

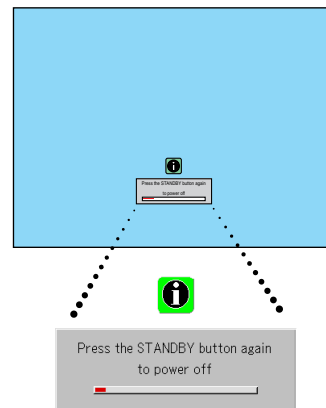
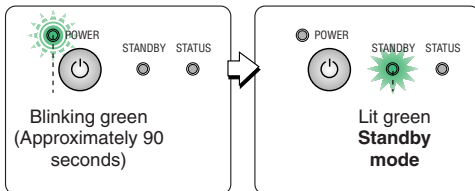

3 Unplug the power cable

When the Quick Off function is not used, check that the STANDBY indicator is lit and then unplug the power cable. The STANDBY indicator will go off when the power cable is unplugged.

Note:

* When the power cable is disconnected from the power outlet, to provide cooling, the fan will start to turn again and cool the lamp. (This is not a malfunction.)
 * Do not put the projector into a bag or other enclosure while the cooling fan is turning.

4 ① Turn the lens cover counterclockwise until it stops.
 ② The lens cover will stop with a click.

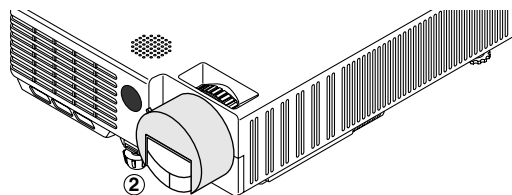
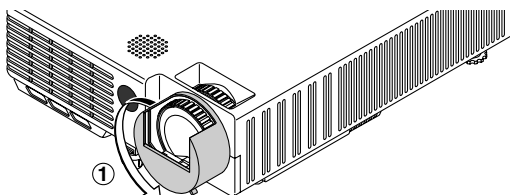

Unplug & Go function

Even when the power cable is unplugged soon after switching off the power, the cooling fan (powered by the internal power supply) will continue to turn and cool the lamp.

- It may be more difficult to turn the lamp back on if it has been cooled with the power cord unplugged.
- Do not place the projector in a bag, etc., while the cooling fan is turning.

Adjustment of the Projection Screen

Switch on the power of the connected equipment and make the adjustments with the video signal being input to the projector.

Adjustment of the Projection Screen

1 Turn the zoom ring to adjust the screen size of the projection image.

Adjust the image to match the desired screen size. When outside of the adjustment range, move the projector to the rear or forward.

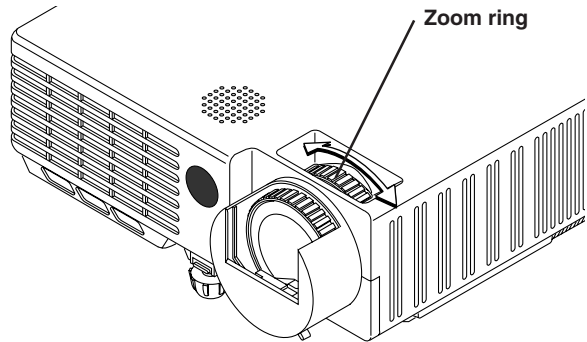

2 Adjust the projection image to the screen.

Check that the screen is set level and vertically.

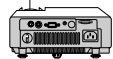
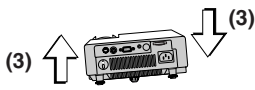
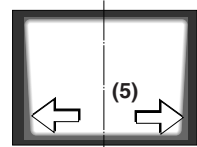
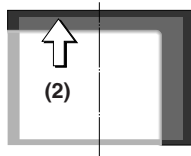

- (1) If the image is shifted to the left or right, move the main unit horizontally. (Align the center of the screen and the center of the projector lens.)
- (2) If the image is shifted vertically, move the image up or down with the front adjuster. See "Making Adjustments with the Adjusters" on Page E-25.
- (3) If the image is slanted, adjust by turning the right or left rear adjuster. See "Making Adjustments with the Adjusters" on Page E-25.
- (4) A projection image such as that illustrated in the diagram is the result of the projector not being perpendicular to the screen. Set the projector so that it is pointing straight toward the screen.
- (5) The vertical keystone distortion of the projection screen will be corrected automatically. (Auto Keystone Function)
 - An automatic adjustment will be made approximately 2 seconds after the projection angle has been fixed. When the adjustment is completed, the [Auto Keystone Complete] message will be displayed for about 1.5 seconds.
 - To make fine adjustments after the automatic adjustment, see "Keystone Manual Adjustment" on Page E-29.

Auto Keystone Function

Keystone distortion arises when the projector is on a slant in the vertical orientation. This projector has an "Auto Keystone" function that detects the vertical slanting and corrects it automatically.

This function is disabled when [Auto Keystone] of the on-screen menu is set to "OFF". See "Auto Keystone" on Page E-47.

Conditions for Automatic Correction

- Automatic correction will operate in the range of 2 to 12 degrees in the upward direction, and 2 to 18 degrees in the downward direction.
- Correction is performed only while the image is being projected.

Note:

Correction might not be possible when the screen surface is on a slant, or when the ambient temperature of the projector is extremely high or low.

3 Turn the focus ring and adjust the focus of the screen

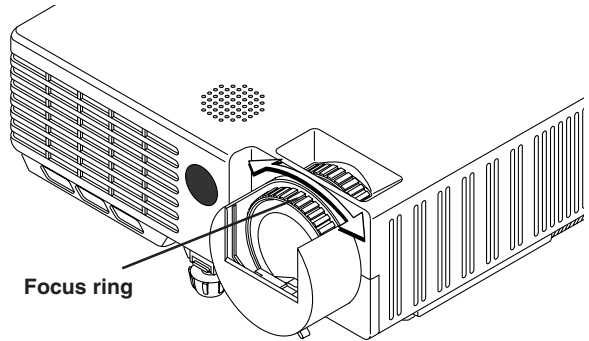
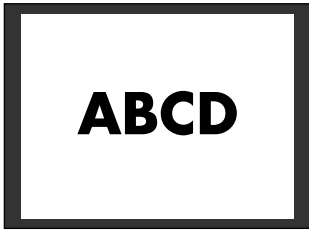

Making Adjustments with the Adjusters

Raising the projection image

While viewing the projection image, (1) press and hold the front adjuster buttons located at the left and right and, (2) raise the projector to align the image with the screen, then release your fingers.

Turn the left and right front adjusters for fine adjustment. Adjust so that there is no shaking of the projector.

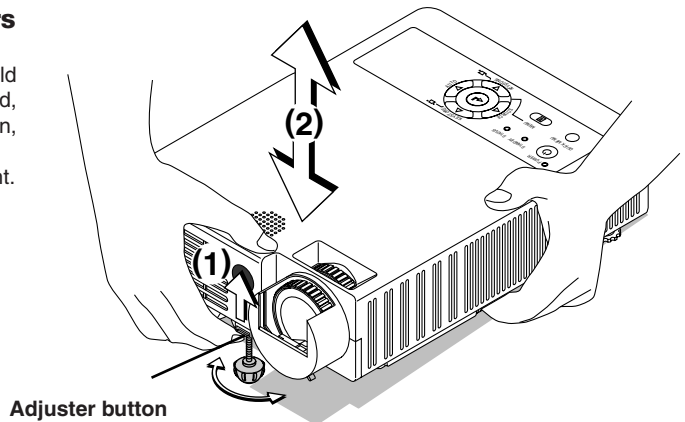

Lowering the projection image

Lower the front adjuster using the operation described above. To lower the projection screen further, turn the rear adjusters.

Fine adjustments are made by turning the rear adjusters. Make adjustments so that there is no rattling.

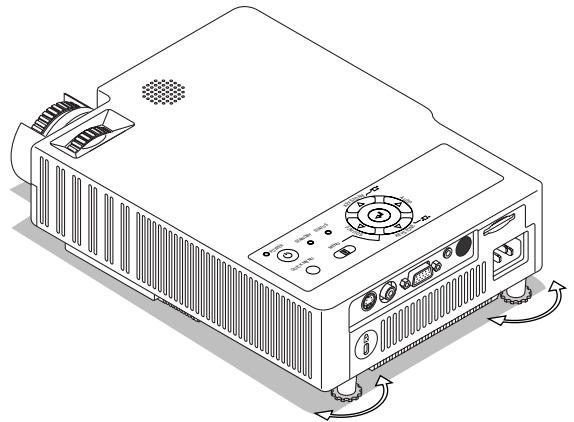

Note:

When the projector has a rear installation is used, the orientation of the projection will need to be changed. Please see "Vertical Flip / Horizontal Flip" on Page E-47.

General Operation

This section describes the use of direct operation with the main unit or remote control buttons.

For information about operation using the menu, see “Menu Operation Method” on Page E-34 and the various items on Pages E-41 to E-54.

Input Selection

This operation selects the input signal to be projected.

Main unit operation: Press the SOURCE button.

(It will not function while the menu or the quick menu is displayed.)

Each press of the SOURCE button on the main unit permits the selection of an input source. Press the ENTER button to set the selected input source.

Applicable Model: KG-PS100S/KG-PS120X

Applicable Model: KG-PS125X

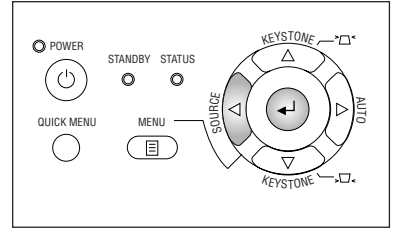

Remote control operation: Press the desired input selection button.

COMPUTER button ... Switches the Computer input.

VIDEO button The input switches between Video and S-Video each time the button is pressed.

When Auto Source is On

When an input signal is not present at the selected source, the projector automatically selects the next source that has an input signal.

When Auto Source is Off

The projector switches to the selected source regardless of whether an input signal is present.

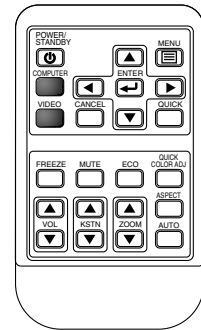

Note:

* When you do not operate source selection, the projector will assume the input selection condition that was previously used.

* See “Auto Source” on Page E-48 for information about the Auto Source on and off conditions.

Automatic Adjustment

This function automatically adjusts the position shift, screen size, vertical stripes, and color infidelity of the projected analog RGB input signal.

Normally automatic adjustment is performed at the time of signal selection.

Main unit operation/Remote control operation: Press the AUTO button.

(This will not function while the menu or the quick menu is displayed.)

A press of the AUTO button starts the automatic adjustment.

Note:

* If the display position is shifted, vertical lines appear on the picture, or the projection is not good even after using automatic adjustment, please perform image adjustment manually. See “Picture Adj. / Fine Picture / H Position / V Position” on Page E-41.

* When the image extends beyond the boundaries of the screen or is smaller than the screen, set “Aspect Ratio” to “Auto”. See “Selection of Aspect Ratio” on Page E-27 and “Aspect Ratio” on Page E-46.

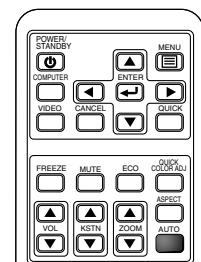
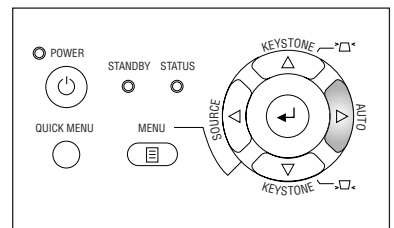

(KG-PS100S/KG-PS120X remote control)

Selection of Aspect Ratio

This function selects horizontal and vertical picture proportions of the input signal.

Press the ASPECT button while viewing the projected image and select the aspect ratio.

Personal Computer Signal

Each press of the ASPECT button advances the selection one step in the sequence of Auto → Direct → Real, and then repeats.

- Auto Automatically enlarges or reduces the image to project a full screen in a ratio of 4:3
- Direct Maintains the aspect ratio and projects a picture of the maximum displayable size
- Real Projects the input signal without pixel conversion.

Note:
The KG-PS125X projector uses menu operations to make this selection. The content of the operation is the same. See "Aspect Ratio" on Page E-46.

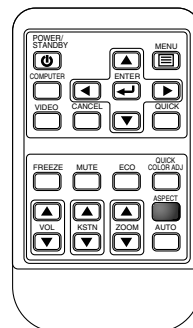

(KG-PS100S/
KG-PS120X
remote control)

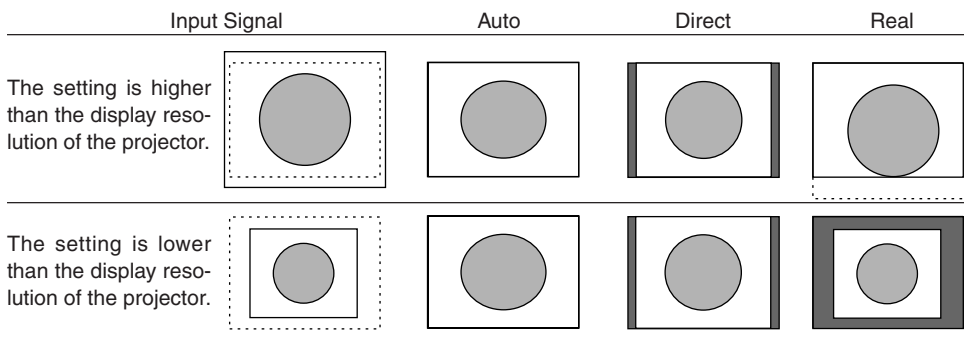

Video Signals / Component Signals

Each press of the ASPECT button advances the selection one step in the sequence of Auto → Wide → Zoom, and then repeats.

- Auto While maintaining the aspect ratio, projects a full screen so that no portions extend beyond the boundaries of the screen. The top and bottom of the 16:9 image becomes black.
- Wide Projects to fill the full width with the entire image at 16:9. (This feature is used to project a squeezed image in a proper aspect ratio.)
- Zoom Projects only the 4:3 portion within 16:9 image to fill the screen. (Portion that extend off screen is cut.)

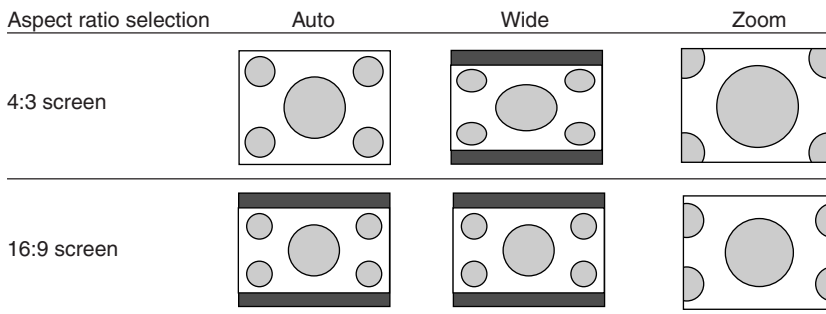

Note:
When selection has been made for the "Real" setting of the personal computer signal (i.e., when the input signal and the projector display resolution are high) and the "Zoom" setting of the video signal, pressing the SELECT (▲▼◀▶) buttons on the remote control will permit movement of the display position. Note that there will not be any movement when the menu or the quick menu is displayed.

General Operation

Freezing a Moving Picture

This function is used to stop and view a moving picture. Note that the input image continues to advance even though the picture there is a still picture condition.

A press of the FREEZE button changes the screen to a still picture. A further press returns the screen to a moving picture.

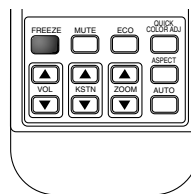

Canceling Video and Audio Temporarily

This function is used to cancel the video and audio at the same time.

A press of the MUTE button will blank the picture and the sound, and the screen will take on the background color that has been set. Another press will cause a return to the original conditions.

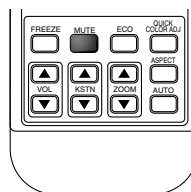

Eco Mode

Use this if the picture is projected on a small screen and the picture is too bright or when projecting images in dark rooms.

Pressing the ECO button will set the Eco mode.

On (STATUS indicator is lit green)

The lamp's brightness is reduced to approximately 80%, extending the lamp's service life.

Off (STATUS indicator is off)

The lamp brightness is set to 100% and the screen is bright.

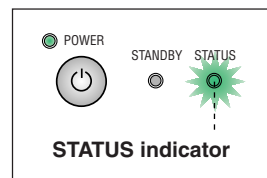

Note:

Frequent switching this mode can degrade the lamp.

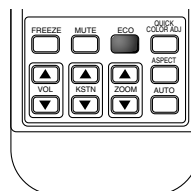

Quick Color Adj.

This function selects the preset color mode.

* The preset color mode will differ depending on the input source.

Press the QUICK COLOR ADJ button and select the setting details with the SELECT (◀▶) buttons.

Selection of the setting details can also be made with each press of the QUICK COLOR ADJ button.

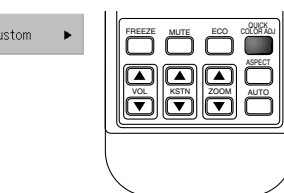

Input Source	Color Mode	Description
Computer Wireless Viewer	Standard	Selection of the standard (default setting).
	Color priority	Selection of color priority.
	Brightness priority	Selection of brightness priority.
	Blackboard mode	Selects the optimum colors when the projection surface is a blackboard.
	Custom	Allows the selection and adjustment of the gamma, color temperature, and white level adjustment items.
Component Video S-Video	Standard	Selection of the standard (default setting).
	Movie mode	Selection of color priority best suited to movies.
	Blackboard mode	Selects the optimum colors when the projection surface is a blackboard.
	Custom	Allows the selection and adjustment of the gamma, color temperature, and white level adjustment items.

Note:

When an item other than Custom is selected with Quick Color Adj., the gamma, color temperature, and white level adjustment items are displayed in gray, and selection and adjustment are not possible.

Keystone Manual Adjustment

Use this to adjust for trapezoidal (keystone) distortion of the projected image. The projector has both an automatic and a manual keystone adjustment function. The manual adjustment will be described here.

Adjustment Method

- (1) Press the (▲▼) buttons of the projector, or the (▲▼) KSTN buttons of the remote control and set the left and right sides so that they are parallel.

The keystone adjustment display appears when one of the buttons is pressed.

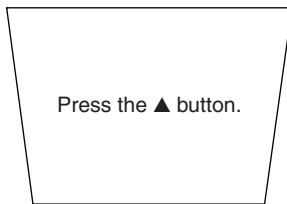

- (2) To exit the display immediately, press the CANCEL button of the remote control.

The display will close when there has not been an operation in about 10 seconds.

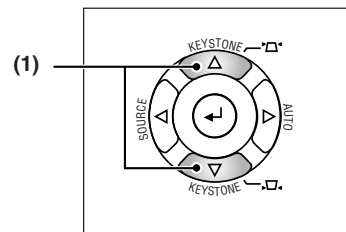

(Projector button)

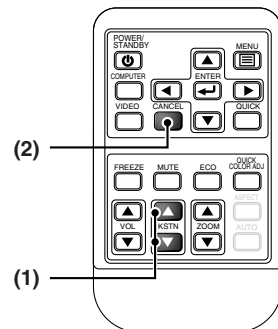

Note:

- * Screen examples have been drawn in an exaggerated style for the purpose of description.
- * Please note that depending on the projected picture and the projection conditions, it may not be possible to eliminate keystone distortion completely.
- * When the Auto Keystone function is OFF, the keystone adjustment settings will be maintained even when the power has been turned off.
- * See "Adjustment of the Projection Screen" on Page E-24 for information about the Auto Keystone function.
- See "Auto Keystone" on Page E-47 for information about turning Auto Keystone ON and OFF.
- Also see "Keystone" on Page E-47 for information about making manual adjustments using the on-screen menu.
- * When Wireless Viewer is selected with model KG-PS125X, the keystone function will not operate with the main unit button.

Adjustment of the Volume

This function adjusts the volume of the built-in speaker.

- (1) Press the ▲ or ▼ VOL button to adjust the volume.

The volume adjustment display appears when one of the buttons is pressed.



The ▲ button increases the volume and the ▼ button decreases the volume.

- (2) Press the CANCEL button to immediately close the display.

The display will close when there has not been an operation in about 10 seconds.

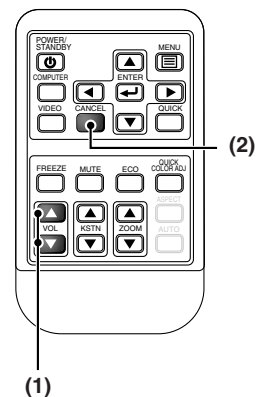

Note:

- * Adjustment of the volume will not produce any sound unless an image is being projected.

Enlargement of the Image and Video Movement

This function digitally enlarges the personal computer image and video image.

(1) Press the ZOOM button to enlarge the image.

The zoom display appears when the ZOOM button is pressed.



Each press of the ▲ button enlarges the image and each press of the ▼ button makes the image smaller (returning it to 1:1).

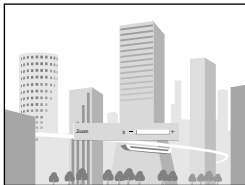

(No enlargement)

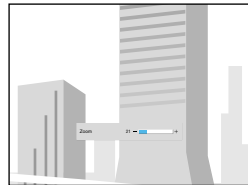

(Approximately 2 times enlargement)

(2) Pressing the SELECT (▲▼◀▶) buttons on the remote control at the time of the zoom operation will cause the display position to move.

(There will not be any movement when zoom is at 0.)

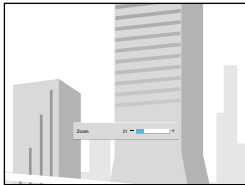

(Approximately 2 times enlargement)

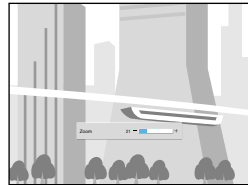

(Movement)

(3) Press the CANCEL button to immediately close the display.

The display will close when there has not been an operation in about 10 seconds.

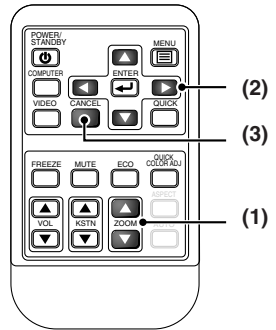

Note:

After magnifying the image, be sure to use the ZOOM button to bring the gauge value back to "0".

The image can also be moved in the following circumstances.

- When "Aspect Ratio" is set to "Real" by the signal of the personal computer, and the input resolution is higher than the display resolution of the projector.
- When "Aspect Ratio" is set to "Zoom" by the video signal.

Note:

- * Zoom and image movement functions are cancelled when the input is switched.
- * The greater the zoom enlargement, the less distinct the image will appear. The reason for this is that the dots are being digitally corrected so that they are not conspicuous.
- * Movement of the screen will not be possible when the menu screen is being displayed.

Protecting the Projector with the Security Lock

A password can be registered and the security lock set in order to protect the projector from unauthorized use.

Registering the password

The password is registered using the menus. For instructions on operating the menus, see “Menu Operation Method” on E-34.



- (1) Select “Security Lock” in the “Option” menu and set it to “Enable”.
The menu closes and the password registration display appears.



- (2) Register using the (four) input buttons.

Be sure to input a 4-digit number.

Example: Registering the password “3221”

Supposing that the input buttons are substituted by number buttons, the substitution will be:

- FREEZE button “1”
- MUTE button “2”
- ECO button “3”
- QUICK COLOR ADJ button “4”

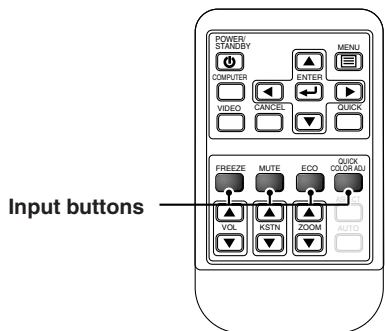

- (1) When input button “ECO” is pressed, an “★” (asterisk) is entered for the first digit.
Continuing, pressing the “MUTE” “MUTE” “FREEZE” input buttons will enter asterisks in the remainder of the four digits.

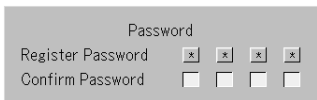
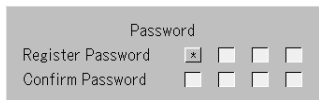

- (2) Input the password again. An “★” appears when the input number matches. If there is a mistake, the asterisks turn off. Start over from step (1) above.
If the password matches, the password registration display closes.

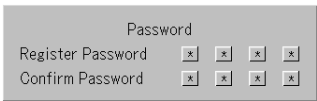
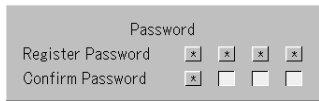

Note:
To cancel the number you have input, press the CANCEL button.
The asterisks disappear and the display returns to the input standby mode at the first place.
To cancel the password registration mode, press the CANCEL button again. The “Password” display turns off.

This completes password registration.
The “Password” input display appears the next time the power is turned on.

Note:
The numbers you have input are not displayed. Be sure to write down the password and store it in a safe place.

General Operation

If the password input display appears when the power is turned on

When a password has been registered, the “Password” input window appears on the projected image when the power is turned on. The projector continues projecting this image until the correct password is input. At this time, only the POWER/STANDBY button (power off) works. Use the procedure described below to input the registered password. For instructions on registering the password, see E-31.

Register using the (four) input buttons.

Be sure to input the registered 4-digit number.

Example: To input the password “3221”

When input button “ECO” is pressed, an “★” (asterisk) is entered for the first digit.



Continuing, pressing the “MUTE” “MUTE” “FREEZE” input buttons will enter asterisks in the remainder of the four digits.

If the password matches, the window turns off and the projector can be used normally.

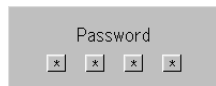

[Password input window]

Canceling the password/Changing the password

The password is canceled and changed using the menus. For instructions on operating the menus, see “Menu Operation Method” on E-34.

Canceling the password

Select “Security Lock” in the “Option” menu and set it to “Disable”.

This clears the password and disables the security lock.

The password input display no longer appears when the power is turned on.

Changing the password

After setting “Security Lock” to “Disable” as described above, set it back to “Enable”. The menu closes and the password registration display appears.

Register the new password. See “Registering the password” on E-31.

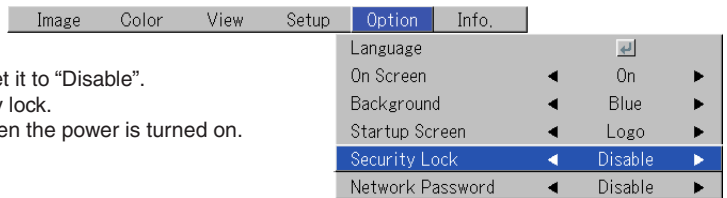

Using the Quick Menu

This function permits frequently used adjustments to be performed quickly.

Note that the Quick Menu will not be displayed unless the signal of the connected equipment is input. Please select the input that you wish to adjust.

Main unit operation

- (1) Press the QUICK MENU button to display the quick adjustment display. Further presses cause the adjustment display to change in sequence. Press the SELECT ▲ or ▼ button to switch to the desired adjustment display.
- (2) Press the SELECT ◀ or ▶ button to adjust.

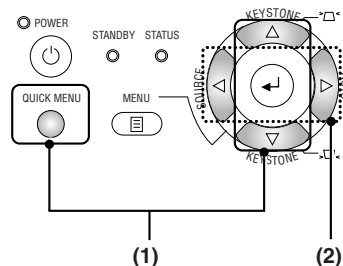

Remote control operation

- (1) A press of the QUICK MENU button brings up the quick adjustment display. Further presses cause the adjustment display to change in sequence. The adjustment display can be selected with use of either the SELECT ▲ or ▼ button.
- (2) Press the cursor ◀ or ▶ button to make the adjustment.
- (3) To close the display immediately, press the CANCEL button. In the absence of operations for a period of about 10 seconds, the display will close automatically.

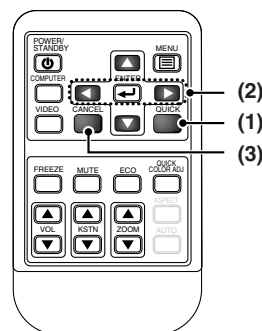

Content of Adjustments and Settings

Example: Brightness adjustment display

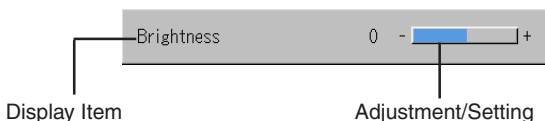

Brightness	Adjusts the brightness of the image. See page E-41.
Contrast	Adjusts the contrast of the image. See page E-41.
Keystone	Corrects (vertical) keystone distortion of the screen. See page E-47.
Volume	This function adjusts the volume of the built-in speaker. See page E-29.
Presentation timer	Sets the time of the presentation timer. See page E-50.
Quick Color Adj.	Select the preset color mode. See page E-43.

Menu Operation Method

- This section describes only the menu operation method. Please see this item should you need information while performing menu operations.
- For information about a menu function, adjustment, or setting, please see one of the pages containing such descriptions.
- Adjustments and settings are made by projecting an image and adjusting to an optimum condition.
- The remote control should be pointed toward the remote control sensor of the projector and operated.
- To return the various items that have been changed via the menu to their standard values (i.e., default values at time of shipping from the factory), see “Factory Default” on Page E-53. (Some items will not return to their initial values.)
- The adjustment/setting items and contents will differ depending on the input selection and the adjustment/setting items that can be used with the input signal are displayed on the menu.

Names and Functions of Buttons Used for Menu Operations

(Remote Control)

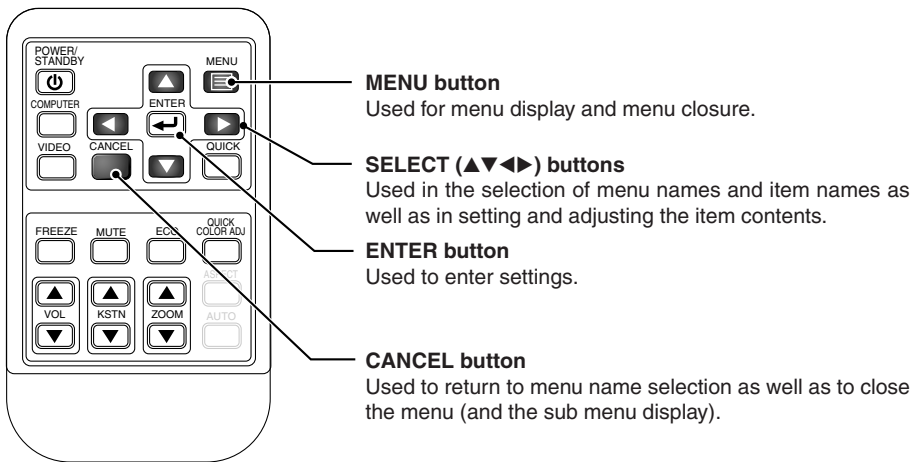

(Main Unit)

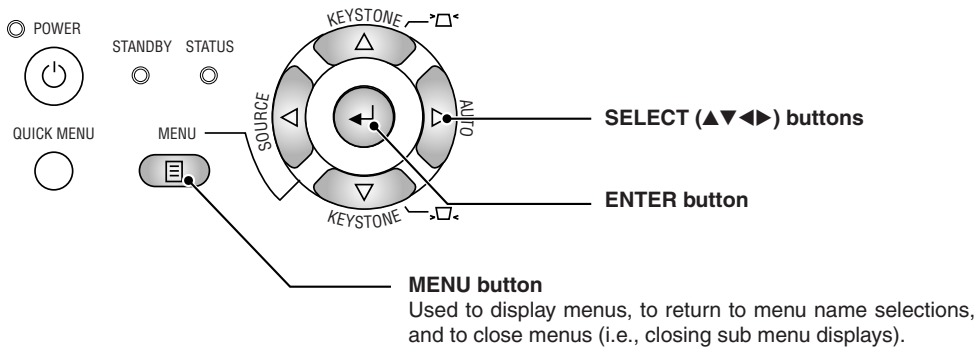

Menu Screen Names and Functions

Menu Name

This is the title of the menu.
There is a change to the title screen when the menu is selected.
The cursor moves to the selected menu name.

Cursor (Deep Blue)

This permits setting/adjustment of the item located at the cursor position.

Item Name

This is the name of the adjustment or setting.

Icon: A press of the ENTER button (the  button on the main unit) will display the sub menu or the setting details.

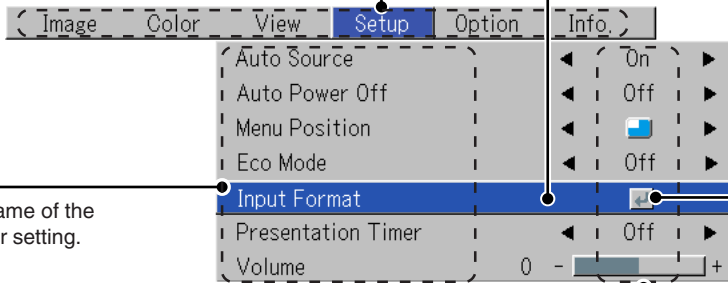

Adjustment Bar and Settings Contents

Adjustment Bar: The increases and decreases in bar length express the adjustment condition.

Setting Contents: Displays the contents that have been set.

Adjustment Bar

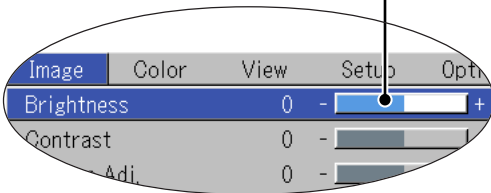

Sub menu

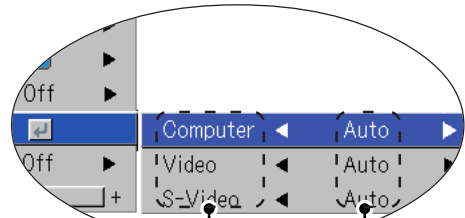

Item Name

Settings Contents

Performing Menu Operations

- Only “Setup”, “Options” and “Info.” can be selected when no signal is being input.
- The menu display will close if, after pressing a button, the next button operation is not made within 30 seconds.
- The adjustment and the setting values are stored even when the power is switched off or the plug is disconnected from the power outlet.

(Note that some items are not stored.)

Preparation Switch on the power of the connected equipment, start the play operation or another operation, and input the signal to the projector.

Select the input that you wish to adjust.

The menu display of the description diagram depicts an example in which the “Keystone” item name is selected.

Menu Display

1 Press the MENU button to display the menu

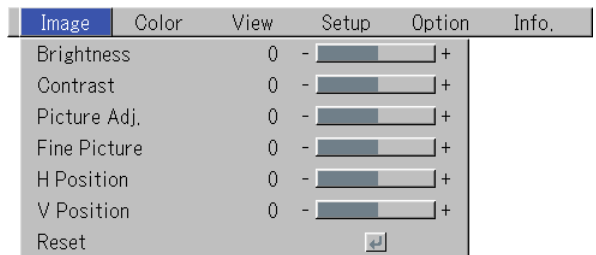
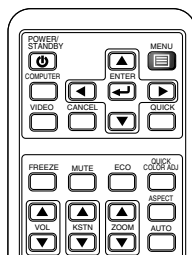

The menu name that existed when the menu was closed previously will be displayed.

Selection of the Menu Name

2 Press the SELECT (◀▶) button to select the menu name

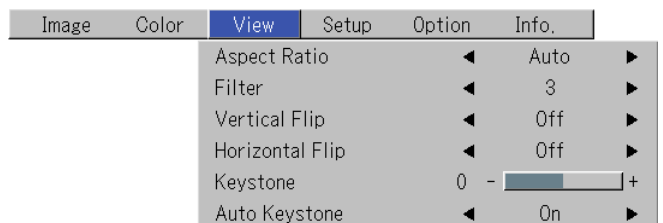
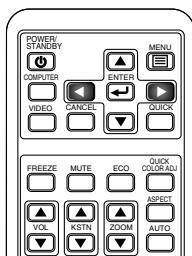

Each press of the SELECT ▶ button advances the selection one step in the sequence of “Color” → “View” → “Setup” → “Option” → “Info.” → “Image”. Each press of the SELECT ◀ button causes a return of one step.

The cursor moves to the selected menu name.

Note:

Please check that the cursor of the item name has disappeared at the time of menu name selection.
Press the CANCEL button to make the cursor disappear.

Displaying the Cursor

3 Press the SELECT ▼ button to display the item name selection cursor.

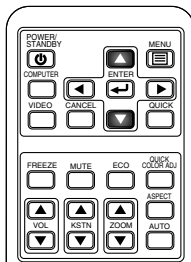

Image	Color	View	Setup	Option	Info.
		Aspect Ratio	◀	Auto	▶
		Filter	◀	3	▶
		Vertical Flip	◀	Off	▶
		Horizontal Flip	◀	Off	▶
		Keystone	0 -		+
		Auto Keystone	◀	On	▶

This condition allows selection of the item name.

Selection of the Item Name

4 Press the SELECT (▲▼) button to align the cursor with the item name

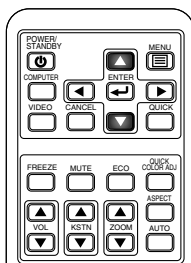

Image	Color	View	Setup	Option	Info.
		Aspect Ratio	◀	Auto	▶
		Filter	◀	3	▶
		Vertical Flip	◀	Off	▶
		Horizontal Flip	◀	Off	▶
		Keystone	0 -		+
		Auto Keystone	◀	On	▶

Items for which the Icon Is Displayed

Press the ENTER button to display the submenu.

Press the SELECT (▲▼) button and align the cursor with the desired item name.

There are also some items for which the setting display or the verification display will appear. Please see the various item descriptions.

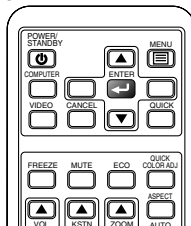

Auto Source	◀	On	▶
Auto Power Off	◀	Off	▶
Menu Position	◀		▶
Eco Mode	◀	Off	▶
Input Format	◀		▶
Presentation Timer	◀	Off	▶
Volume	0 -		+

Computer	◀	Auto	▶
Video	◀	Auto	▶
S-Video	◀	Auto	▶

Sub menu

Making Adjustments/Settings

5 Press the SELECT (◀▶) button and make the adjustment (or setting) while viewing the image
When a button is pressed, the image will also change.

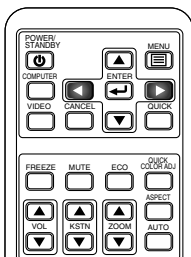

Image	Color	View	Setup	Option	Info.
		Aspect Ratio	◀	Auto	▶
		Filter	◀	3	▶
		Vertical Flip	◀	Off	▶
		Horizontal Flip	◀	Off	▶
		Keystone	0 -		+
		Auto Keystone	◀	On	▶

Adjustment display: Each press of the button results in a change of 1 point and continued presses cause changes to proceed in order.

Setting display: The setting contents display changes with each press of the button.

Closing the Menu

6 Press the MENU button and close the menu display

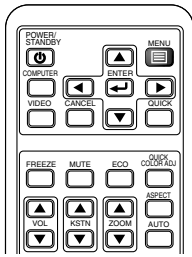

Selecting Another Menu Name with Remote Control Operation

When a sub menu is displayed, press the CANCEL button or the MENU button to close the sub menu. Press the CANCEL button or the MENU button again to delete the cursors of the various items.

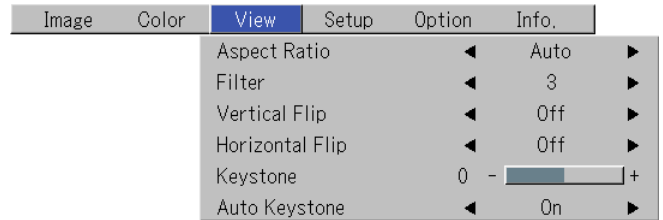
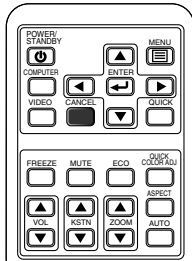
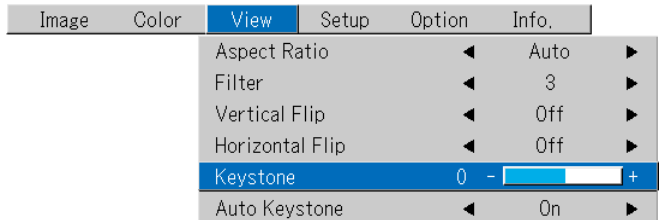

Press the SELECT (◀▶) button and select the menu name. (Menu names cannot be selected when the item name cursor is displayed.)

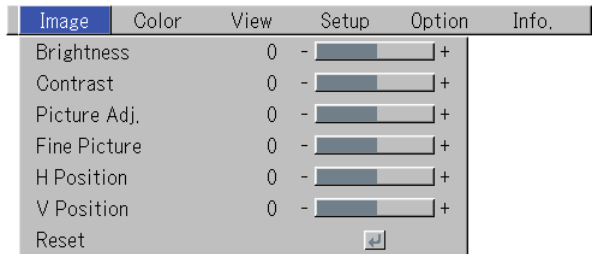
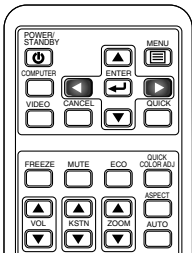

Note:

A press of the QUICK button while the menu is displayed will close the menu and display the quick menu. A press of the MENU button while the quick menu is displayed will close the quick menu and display the menu.

List of Item Names Offering Input Selection and Adjustments/Settings

The item names that can be adjusted/set will differ depending on the input signal.

[Example of Menu Display Items at the Time of Input Signal Computer Selection]

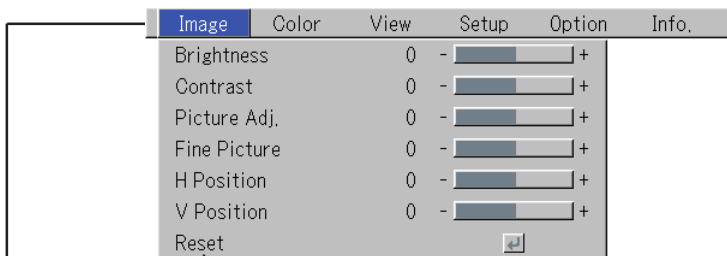

Menu name	Item Name	Sub Menu Item Name	Input Terminal		COMPUTER IN				Reference Page
			Input Signal	Component	Computer	Video	S-Video	Wireless	
Image	Brightness		○	○	○	○	○	○	E-41
	Contrast		○	○	○	○	○	○	E-41
	Color				○	○			E-41
	Tint		○		○	○			E-41
	Sharpness				○	○			E-41
	Picture Adj.			○					E-41
	Fine Picture			○					E-42
	H Position			○					E-42
	V Position			○					E-42
	Reset			○	○	○	○	○	E-42
Color	Quick Color Adj.		○	○	○	○	○	○	E-43
	Gamma		○	○	○	○	○	○	E-43
	Color Temp.		○	○	○	○	○	○	E-44
	White Level		○	○	○	○	○	○	E-44
	Color Space		○						E-44
	White Balance			○					E-45
View	Aspect Ratio		○	○	○	○	○	○	E-46
	Filter		○	○	○	○	○	○	E-46
	Vertical Flip		○	○	○	○	○	○	E-47
	Horizontal Flip		○	○	○	○	○	○	E-47
	Keystone		○	○	○	○	○	○	E-47
	Auto Keystone		○	○	○	○	○	○	E-47

* "Tint" can be adjusted only in the NTSC system composite/S signal input mode, or in the component signal input mode.

Menu Operation Method

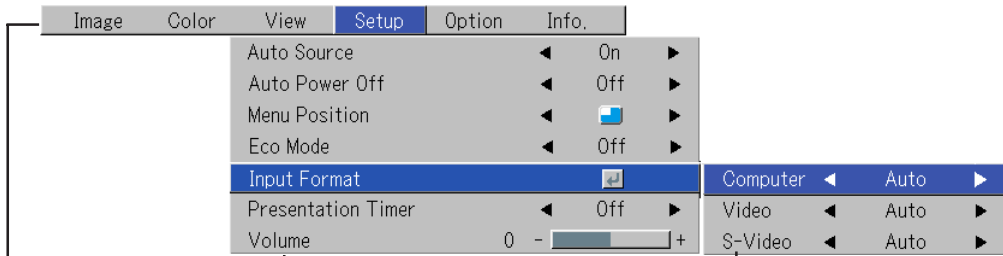

Menu name	Item Name	Sub Menu Item Name	Input Terminal						Reference Page	
			Component	Computer	Video	S-Video	Wireless	Viewer		
Setup	Auto Source		<input type="checkbox"/>	<input type="checkbox"/>	<input type="checkbox"/>	<input type="checkbox"/>	<input type="checkbox"/>	<input type="checkbox"/>	E-48	
	Auto Power Off		<input type="checkbox"/>	<input type="checkbox"/>	<input type="checkbox"/>	<input type="checkbox"/>	<input type="checkbox"/>	<input type="checkbox"/>	E-48	
	Menu Position		<input type="checkbox"/>	<input type="checkbox"/>	<input type="checkbox"/>	<input type="checkbox"/>	<input type="checkbox"/>	<input type="checkbox"/>	E-48	
	Eco Mode		<input type="checkbox"/>	<input type="checkbox"/>	<input type="checkbox"/>	<input type="checkbox"/>	<input type="checkbox"/>	<input type="checkbox"/>	E-49	
	Input Format	Computer		<input type="checkbox"/>	<input type="checkbox"/>	<input type="checkbox"/>	<input type="checkbox"/>	<input type="checkbox"/>	<input type="checkbox"/>	E-49
		Video		<input type="checkbox"/>	<input type="checkbox"/>	<input type="checkbox"/>	<input type="checkbox"/>	<input type="checkbox"/>	<input type="checkbox"/>	E-49
		S-Video		<input type="checkbox"/>	<input type="checkbox"/>	<input type="checkbox"/>	<input type="checkbox"/>	<input type="checkbox"/>	<input type="checkbox"/>	E-49
	Presentation Timer		<input type="checkbox"/>	<input type="checkbox"/>	<input type="checkbox"/>	<input type="checkbox"/>	<input type="checkbox"/>	<input type="checkbox"/>	E-50	
Volume		<input type="checkbox"/>	<input type="checkbox"/>	<input type="checkbox"/>	<input type="checkbox"/>	<input type="checkbox"/>	<input type="checkbox"/>	E-50		
Option	Language		<input type="checkbox"/>	<input type="checkbox"/>	<input type="checkbox"/>	<input type="checkbox"/>	<input type="checkbox"/>	<input type="checkbox"/>	E-51	
	On Screen		<input type="checkbox"/>	<input type="checkbox"/>	<input type="checkbox"/>	<input type="checkbox"/>	<input type="checkbox"/>	<input type="checkbox"/>	E-51	
	Background		<input type="checkbox"/>	<input type="checkbox"/>	<input type="checkbox"/>	<input type="checkbox"/>	<input type="checkbox"/>	<input type="checkbox"/>	E-51	
	Startup Screen		<input type="checkbox"/>	<input type="checkbox"/>	<input type="checkbox"/>	<input type="checkbox"/>	<input type="checkbox"/>	<input type="checkbox"/>	E-52	
	Security Lock		<input type="checkbox"/>	<input type="checkbox"/>	<input type="checkbox"/>	<input type="checkbox"/>	<input type="checkbox"/>	<input type="checkbox"/>	E-52	
	Network Password		<input type="checkbox"/>	<input type="checkbox"/>	<input type="checkbox"/>	<input type="checkbox"/>	<input type="checkbox"/>	<input type="checkbox"/>	E-52	
	Info.	Status		<input type="checkbox"/>	<input type="checkbox"/>	<input type="checkbox"/>	<input type="checkbox"/>	<input type="checkbox"/>	<input type="checkbox"/>	E-53
Factory Default			<input type="checkbox"/>	<input type="checkbox"/>	<input type="checkbox"/>	<input type="checkbox"/>	<input type="checkbox"/>	<input type="checkbox"/>	E-53	
Lamp Timer Reset			<input type="checkbox"/>	<input type="checkbox"/>	<input type="checkbox"/>	<input type="checkbox"/>	<input type="checkbox"/>	<input type="checkbox"/>	E-53	
Resolution			<input type="checkbox"/>	<input type="checkbox"/>	<input type="checkbox"/>	<input type="checkbox"/>	<input type="checkbox"/>	<input type="checkbox"/>	E-54	
Frequency			<input type="checkbox"/>	<input type="checkbox"/>	<input type="checkbox"/>	<input type="checkbox"/>	<input type="checkbox"/>	<input type="checkbox"/>	E-54	
Lamp Timer			<input type="checkbox"/>	<input type="checkbox"/>	<input type="checkbox"/>	<input type="checkbox"/>	<input type="checkbox"/>	<input type="checkbox"/>	E-54	

Image

- Perform this operation while projecting the picture for which the adjustment/setting will be made.
- Select the menu name “Image”.
See “Menu Operation Method” on Page E-34 for information about performing menu operations. The item name display will differ depending on the input signal. See “List of Item Names Offering Input Selection and Adjustments/Settings” on Page E-39.

Brightness / Contrast / Color / Tint / Sharpness

Picture qualities such as brightness and contrast will change depending on the whether the room is bright or dark. Please adjust to suit your preference.

Select the desired item name and then adjust with the SELECT (◀▶) buttons.

Item Name	SELECT ◀ Button	SELECT ▶ Button
Brightness	Darker	Brighter
Contrast	Less contrast	More contrast
Color	Less dense color	Denser color
Tint	More red	More green
Sharpness	Softer image	Sharper image

Note:

- * The adjustment values of the adjustable items are stored according to input source.
- * “Tint” can only be adjusted when inputting NTSC composite/S-Video signals or component signals.

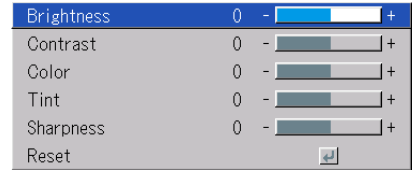

Picture Adj. / Fine Picture / H Position / V Position

Usually, automatic adjustment is performed at the time of signal selection, but when automatic adjustment is not effective, these adjustments can be performed.

Note:

When the image extends beyond the boundaries of the screen or is smaller than the screen, check that the “View” → “Aspect Ratio” setting is set to “Auto”. See “Aspect Ratio” on Page E-46.

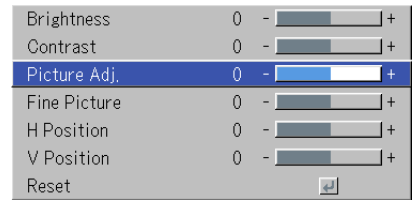

Picture Adj. (Picture Adjustment)

Adjust this when bright and dark vertical bands appear on the screen.

Select the “Picture Adj.” item name and adjust with the SELECT (◀▶) buttons so that the vertical bands disappear and brightness becomes uniform across the screen.

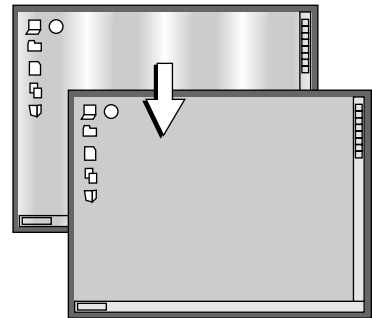

Image

Fine Picture

Adjust this when the picture shows a lack of color fidelity or flickering.

Select the "Fine Picture" item name and adjust with the SELECT (◀▶) buttons so that the lack of color fidelity or the flickering disappears.

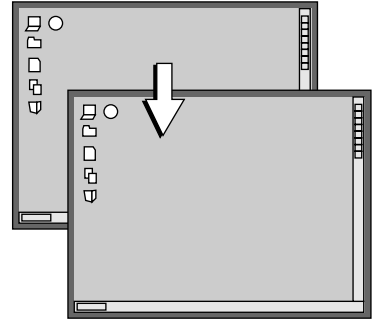

H Position

Adjust this when the picture is shifted to the left or right.

Select the "H Position" item name and adjust with the SELECT (◀▶) buttons.

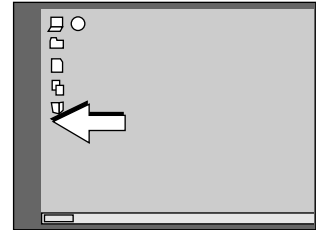

V Position

Adjust this when the picture is shifted up or down.

Select the "V Position" item name and adjust with the SELECT (◀▶) buttons.

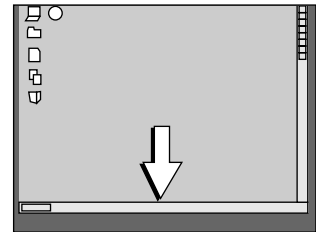

Reset

This function resets (i.e., returns to the standard settings) the adjustment/setting value of the "Image" menu name.

A press of the ENTER button forces the reset.

Brightness	0	-	+
Contrast	0	-	+
Picture Adj.	0	-	+
Fine Picture	0	-	+
H Position	0	-	+
V Position	0	-	+
Reset			

Note:

- * The item name "Fine Picture" at the time of RGB input will not be reset.
- * "Reset" of the menu name "Image" can be reset for each input source.
- * To reset the adjustments/settings of all the menu items (while noting that there are some items that cannot be reset), see "Factory Default" on Page E-53.

Color

- Do the following operation while displaying the image you want to adjust or set.
- Select the menu name “Color”.

See “Menu Operation Method” on Page E-34 for information about performing menu operations. The item name display will differ depending on the input signal. See “List of Item Names Offering Input Selection and Adjustments/Settings” on Pages E-39.

Quick Color Adj.

This function selects the preset color mode.

* The preset color mode will differ depending on the input source.

Press the QUICK COLOR ADJ button and select the setting details with the SELECT (◀▶) buttons.

Selection of the setting details can also be made with each press of the QUICK COLOR ADJ button.

Quick Color Adj.	◀	Custom	▶
Gamma	◀	Normal	▶
Color Temp.	◀	Normal	▶
White Level	◀	Low	▶
White Balance			

Input Source	Color Mode	Description
Computer Wireless Viewer	Standard	Selection of the standard (default setting).
	Color priority	Selection of color priority.
	Brightness priority	Selection of brightness priority.
	Blackboard mode	Selects the optimum colors when the projection surface is a blackboard.
	Custom	Allows the selection and adjustment of the gamma, color temperature, and white level adjustment items.
Component Video S-Video	Standard	Selection of the standard (default setting).
	Movie mode	Selection of color priority best suited to movies.
	Blackboard mode	Selects the optimum colors when the projection surface is a blackboard.
	Custom	Allows the selection and adjustment of the gamma, color temperature, and white level adjustment items.

Note:

When an item other than Custom is selected with Quick Color Adj., the gamma, color temperature, and white level adjustment items are displayed in gray, and selection and adjustment are not possible.

Gamma

Gamma corrects the proportion of change of the dark portions from the bright portions of the input signal.

Set this to reproduce natural color tone or to distinctly project a personal computer picture in a bright conference room.

Select the “Gamma” item name and select the setting contents with the SELECT (◀▶) buttons.

- Normal Correction with standard settings
- Natural Corrects for natural color tones
- Real Corrects with emphasis on brightness

Quick Color Adj.	◀	Standard	▶
Gamma	◀	Normal	▶
Color Temp.	◀	Normal	▶
White Level	◀	Low	▶
White Balance			

Note:

When an item other than Custom is selected with Quick Color Adj., the gamma, color temperature, and white level adjustment items are displayed in gray, and selection and adjustment are not possible.

Color

Color Temp.

The screen color is affected by the color of the illumination and other extraneous light.

This function adjusts the white, which is the reference color for video equipment, and improves the quality of color reproduction. Adjustment can also be used to enhance skin colors.

Select the item name "Color Temp." and select the setting contents with the SELECT (◀▶) buttons.

Low Produces warm whites (reddish)
Medium Produces warm whites (yellowish)
Normal Produces the white of sunlight
High Produces cool whites (bluish)

Note:

When an item other than Custom is selected with Quick Color Adj., the gamma, color temperature, and white level adjustment items are displayed in gray, and selection and adjustment are not possible.



White Level

When projecting, this function is used to emphasize the whites of text or diagrams on the personal computer.

Select the item name "White Level" and use the SELECT (◀▶) buttons to select the setting contents.

Select the desired degree of white level from among "Low", "Medium", and "High".

Note:

When an item other than Custom is selected with Quick Color Adj., the gamma, color temperature, and white level adjustment items are displayed in gray, and selection and adjustment are not possible.



Color Space

Set this function when a component signal (YPbPr) is projected and the image is extremely red or extremely green.

Select the item name "Color Space" and use the SELECT (◀▶) buttons to select a color space setting that provides a normal image.

Selection contents at the time of YPbPr input

BT.709, SMPTE240

Note:

* When the component signal undergoes conversion processing to red, green, and blue which express the image of the projector, the correct color cannot be reproduced unless a system compliant with the color difference conversion system of the input signal is used. Color Space serves to make this selection.

* The color space can only be adjusted with high definition TVs.



White Balance

This function automatically adjusts the black level and the white level of the Computer input signal to suit the personal computer.

- 1 Select the item name [White Balance] and press the ENTER button.

The display will change to [Input Black Signal].

- 2 The screen background color of the connected personal computer will be set to black.
3. Press the ENTER button. The display will change to [Adjusting Black] and the black level will be adjusted.

Quick Color Adj.	◀	Standard	▶
Gamma	◀	Normal	▶
Color Temp.	◀	Normal	▶
White Level	◀	Low	▶
White Balance			▶

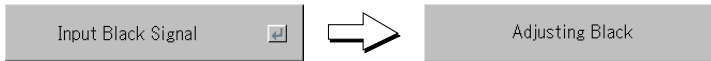

- 4 The adjustment of the black level is completed and the display changes to [Input White Signal].
- 5 The screen background color of the connected personal computer will be set to white.
- 6 Press the ENTER button. The display will change to [Adjusting White] and the white level will be adjusted.

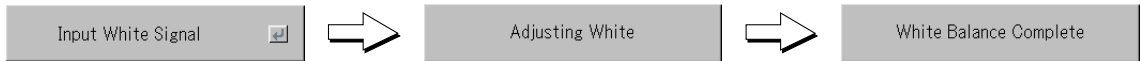

[White balance complete] is displayed for a while and the adjustment is completed.

View

- Perform this operation while projecting the picture for which the adjustment/setting will be made.
- Select the menu name “View”.
See “Menu Operation Method” on Page E-34 for information about performing menu operations. The item name display will differ depending on the input signal. See “List of Item Names Offering Input Selection and Adjustments/Settings” on Page E-39.

Aspect Ratio

This function sets the horizontal and vertical picture proportions of the input signal.

Select the item name “Aspect Ratio” and select the setting contents with the SELECT (◀▶) buttons.

Personal Computer Signal

- Auto Automatically enlarges or reduces the image to project a full screen in a ratio of 4:3
- Direct Maintains the aspect ratio and projects a picture of the maximum displayable size
- Real Projects the input signal without pixel conversion

Video Signals

- Auto While maintaining the aspect ratio, projects a full screen so that no portions extend beyond the boundaries of the screen. The top and bottom of the 16:9 image becomes black.
- Wide Projects to fill the full width with the entire image at 16:9. (This feature is used to project a squeezed image in a proper aspect ratio.)
- Zoom Projects only the 4:3 portion within 16:9 image to fill the screen. (Portion that extend off screen is cut.)

See “Selection of Aspect Ratio” on Page E-27 for diagrams of projection screen images that correspond to the input signals.

Note:

Please note that using this monitor for the purpose of commercial gain or the attraction of public attention in a venue such as a coffee shop or hotel and projecting a 4:3 screen in wide mode or leaving a squeezed screen as a compressed image raises concern about the infringement of the copyright holder's rights which are protected by copyright law.

Aspect Ratio	◀	Auto	▶
Filter	◀	3	▶
Vertical Flip	◀	Off	▶
Horizontal Flip	◀	Off	▶
Keystone	0	- [Slider] +	
Auto Keystone	◀	On	▶

Filter

This function sets the sharpness when the input signal is adjusted to the resolution of the projector and enlarged or reduced.

Select the item name “Filter” and select the setting contents with the SELECT (◀▶) buttons.

Smaller numerical values result in a sharper picture and larger values result in a softer picture. Please select your desired setting value.

Aspect Ratio	◀	Auto	▶
Filter	◀	3	▶
Vertical Flip	◀	Off	▶
Horizontal Flip	◀	Off	▶
Keystone	0	- [Slider] +	
Auto Keystone	◀	On	▶

Vertical Flip / Horizontal Flip

In selecting the method of projecting to the screen, these functions are set when the projector is in a rear screen installation.

Select the item name “Vertical Flip” or “Horizontal Flip” and select the setting contents with the SELECT (◀▶) buttons.

Aspect Ratio	◀	Auto	▶
Filter	◀	3	▶
Vertical Flip	◀	Off	▶
Horizontal Flip	◀	Off	▶
Keystone	0	—	+
Auto Keystone	◀	On	▶

“Vertical Flip” Off
“Horizontal Flip” Off



“Vertical Flip” Off
“Horizontal Flip” On



“Vertical Flip” On
“Horizontal Flip” On



“Vertical Flip” On
“Horizontal Flip” Off



Keystone

Keystone distortion will occur when the projector and screen are on an angle (in the vertical orientation). The Keystone function is used to manually adjust this distortion.

Select the item name “Keystone” and correct the keystone distortion using the SELECT (◀▶) buttons.

Aspect Ratio	◀	Auto	▶
Filter	◀	3	▶
Vertical Flip	◀	Off	▶
Horizontal Flip	◀	Off	▶
Keystone	0	—	+
Auto Keystone	◀	On	▶



Note:

- * The menus and other on-screen displays cannot be adjusted.
- * Please note that depending on the projected picture and the projection conditions, it may not be possible to eliminate keystone distortion completely.
- * When the Auto Keystone function is OFF, the keystone adjustment settings will be maintained even when the power has been turned off.
- * See “Adjustment of the Projection Screen” on Page E-24 for information about the Auto Keystone function.
See “Keystone Manual Adjustment” on Page E-29 for information about manual adjustment using the projector and the remote control.

Auto Keystone

Auto Keystone is set to provide an automatic adjustment of the keystone distortion.

Select the item name “Auto Keystone” and set with the SELECT (◀▶) buttons.

On provides automatic adjustment.

Off does not provide automatic adjustment.

Aspect Ratio	◀	Auto	▶
Filter	◀	3	▶
Vertical Flip	◀	Off	▶
Horizontal Flip	◀	Off	▶
Keystone	0	—	+
Auto Keystone	◀	On	▶

Note:

- See “Adjustment of the Projection Screen” on Page E-24 for information about the Auto Keystone function.
- See “Manual Adjustment of Keystone” and the aforementioned “Keystone” on Page E-29 for information about manual adjustment using the buttons of the projector and the remote control.

Setup

- Select menu name “Setup”.

See “Menu Operation Method” on Page E-34 for information about performing menu operations. The item name display will differ depending on the input signal. See “List of Item Names Offering Input Selection and Adjustments/Settings” on Page E-39.

Auto Source

The Auto Source function automatically detects the input signal when the power supply is switched on and when the input is switched.

Select the item name “Auto Source” and select the setting contents with the SELECT (◀▶) buttons.

On Switches on the automatic detection function
Off Switches off the automatic detection function



Applicable Model: KG-PS125X

Signal Detection Order When On

The sequence of Computer → Video → S-Video → [Wireless] → [Viewer] is searched repeatedly.

When a signal is detected, the search is stopped and the image is projected.

Auto Power Off

This function switches off the projector power automatically when the input of the projector enters a no-signal condition.

Select item name “Auto Power Off” and select the setting contents with the SELECT (◀▶) buttons.

On The power is switched off when there is no signal.
Off The power is not switch off even when there is no signal.

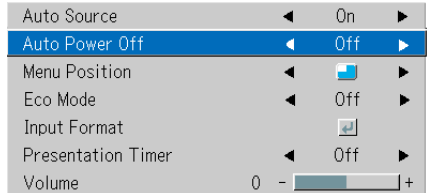

Operation when Function is On

- The “No Signal Power Off” display appears when a no-signal condition continues for approximately 10 seconds. The power is switched off about 5 minutes after this.
- If a signal is input during the appearance of the display and an operation button other than the POWER/STANDBY button is pressed, the display is closed and the function is cancelled.

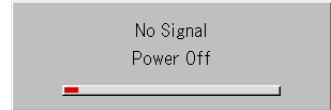

Note:

Some video decks and other equipment output a blue background or other video when playback ends. When this happens, a signal is being input to the projector and Auto Power Off is not activated.

Menu Position

This function sets the display position of the menu.

Select item name “Menu Position” and select the setting contents with the SELECT (◀▶) buttons.

- Displays on the left side
- Displays on the right side

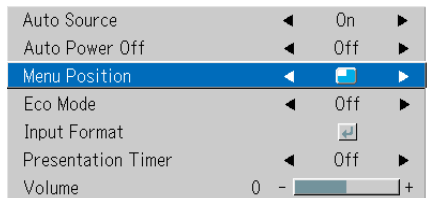

Setup

Eco Mode

Use this if the picture is projected on a small screen and the picture is too bright or when projecting images in dark rooms.

Select the item name "Eco Mode" and select the setting contents with the SELECT (◀▶) buttons.

On The lamp's brightness is reduced to approximately 80%, extending the lamp's service life.
(STATUS indicator is green)

Off The lamp brightness is set to 100% and the screen is bright.
(STATUS indicator is off)

Note:

Frequent switching this mode can degrade the lamp.

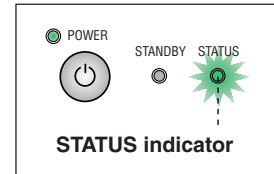
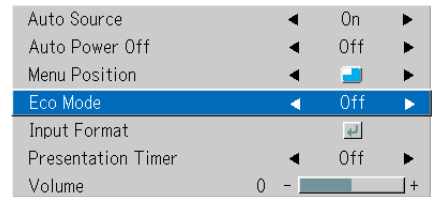

Input Format

This function is used in setting the input signals of the input connectors.

Normally, this should be set to Auto. When identification is not possible with Auto, make the setting.

Select the item name "Input Format", press the ENTER button, and the sub menu will open.

Select the connector that is to be changed, and select the setting contents with the SELECT (◀▶) buttons.

[Computer]

This is the signal setting for the COMPUTER IN connector.

Auto Automatically identifies the signal.

Computer ... Analog RGB signal is set.

Component . Component signal is set.

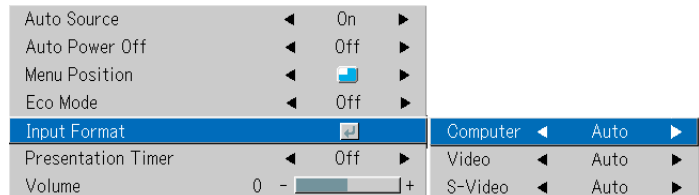

[Video] and [S-Video]

[Video] is the color system setting for the VIDEO connector and [S-Video] is the color system setting for the S-VIDEO connector.

Auto Automatic identification.

NTSC Fixed to the NTSC system.

PAL Fixed to the PAL system.

SECAM Fixed to the SECAM system.

NTSC 4.43 .. Fixed to the NTSC 4.43 system.

PAL M Fixed to the PAL M system.

PAL N Fixed to the PAL N system.

PAL 60 Fixed to the PAL 60 system.

Setup

Presentation Timer

The presentation is given while checking the timer displayed on the screen.

The gauge display allows the remaining time to be known at a glance.

Select the item name "Presentation Timer" and select the setting contents with the SELECT (◀▶) buttons.

Setting contents: Off, 10 min., 20 min., 30 min., 40 min., 50 min., 60 min.

To start the timer...

Press the MENU button and open the menu.

The timer display will appear at the lower right and the timer will start.



[Timer Display]

The blue gauge indicates the remaining time. When the gauge disappears, the time is up.

The gauge continues to be displayed when the timer is stopped.



- Press the ENTER button to restart the timer. The timer will start with the same time setting.
- Press the CANCEL button to close the timer display. The timer setting will return to "Off".

Moving the Position of the Timer Display

The SELECT (▲▼◀▶) buttons on the remote control permit movement within the movable range of the timer display.

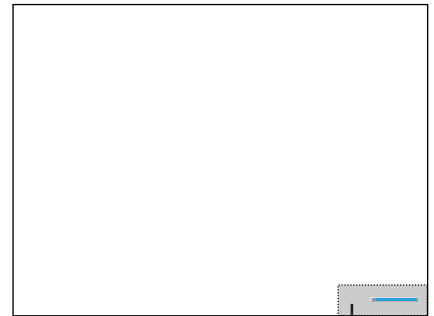
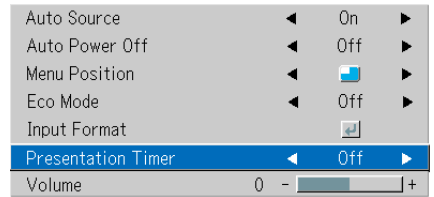

Movable Range of the Timer Display

Note:

* The timer display will be closed while the menu or the quick menu is displayed, and while a message is displayed; however, the timer will still be operating at such times. Also, the timer will not be displayed unless a signal is being input.

* While the presentation timer is being displayed, screen movement will not be possible in the zoom mode.

Volume

This function adjusts the volume of the built-in speaker.

Select the item name [Volume] and adjust the sound level with the SELECT (◀▶) buttons.



Option

- **Select menu name “Option”.**

See “Menu Operation Method” on Page E-34 for information about performing menu operations. The item name display will differ depending on the input signal. See “List of Item Names Offering Input Selection and Adjustments/Settings” on Page E-39.

Language

This function sets the language that is displayed on screen in the messages and menu displays.

Select item name “Language” and press the ENTER button to open the Language sub menu.

Select the language with the SELECT (▲▼) buttons.

Language		English
On Screen	◀ On ▶	Русский
Background	◀ Blue ▶	Deutsch
Startup Screen	◀ Logo ▶	Français
Security Lock	◀ Disable ▶	Italiano
Network Password	◀ Disable ▶	Español
		Svenska
		한국어
		中文
		日本語

On Screen

This function switches on/off the messages displayed with a black frame such as the input signal information and the aspect ratio.

Select item name “On Screen” and select the setting contents with the SELECT (◀▶) buttons.

On The message is displayed.

Off The message is not displayed.

Note:

Even when set to off, messages that are not in a black frame will be displayed.

Language	
On Screen	◀ On ▶
Background	◀ Blue ▶
Startup Screen	◀ Logo ▶
Security Lock	◀ Disable ▶
Network Password	◀ Disable ▶

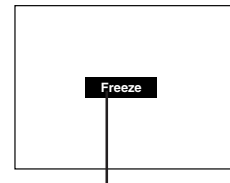

Example of a display when the FREEZE button is pressed

Background

This function sets the screen color when the input source is no-signal.

Select item name “Background” and select the setting contents with the SELECT (◀▶) buttons.

Blue Sets a blue screen when there is no signal

Black Sets a black screen when there is no signal

Language	
On Screen	◀ On ▶
Background	◀ Blue ▶
Startup Screen	◀ Logo ▶
Security Lock	◀ Disable ▶
Network Password	◀ Disable ▶

Option

Startup Screen

This is the selection of whether or not to display the logo screen at startup time.

Select item name “Startup Screen” and select the setting contents with the SELECT (◀▶) buttons.

Logo Displays the logo.

Blank Does not display the logo.

Note:

When “Logo” is selected at the startup screen, the “TAXAN” logo is displayed.

Language		
On Screen	◀	On ▶
Background	◀	Blue ▶
Startup Screen	◀	Logo ▶
Security Lock	◀	Disable ▶
Network Password	◀	Disable ▶

Security Lock

A password can be registered and the security lock set in order to prevent unauthorized use of the projector.

For instructions on using the security function, see “Protecting the Projector with the Security Lock” on E-31.

Select item name “Security Lock” and select the setting contents with the SELECT (◀▶) buttons.

Disable The security lock is disabled.

The projector can be operated without inputting the password.

Enable The security lock is enabled.

The security lock is activated when the power is turned on, and the password must be input in order to operate the projector.

Language		
On Screen	◀	On ▶
Background	◀	Blue ▶
Startup Screen	◀	Logo ▶
Security Lock	◀	Disable ▶
Network Password	◀	Disable ▶

Network Password

Applicable Model: KG-PS125X

For details, refer to the “Image Viewer / Wireless Network” section.

Language		
On Screen	◀	On ▶
Background	◀	Blue ▶
Startup Screen	◀	Logo ▶
Security Lock	◀	Disable ▶
Network Password	◀	Disable ▶

Info.

- **Select menu name “Info.”**

See “Menu Operation Method” on Page E-34 for information about performing menu operations. The item name display will differ depending on the input signal. See “List of Item Names Offering Input Selection and Adjustments/Settings” on Page E-39.

Status

This displays information about the equipment.

Select item name “Status” and press the ENTER button.

There is a change to the status display.

Press the CANCEL button to return to the menu.

Display Contents:

Projector model, firmware version, and the internet home page address of KAGA COMPONENTS.

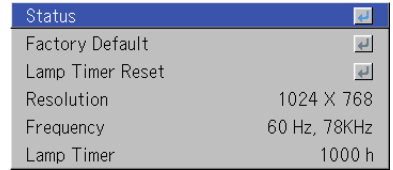

Status	
Factory Default	
Lamp Timer Reset	
Resolution	1024 X 768
Frequency	60 Hz, 78KHz
Lamp Timer	1000 h

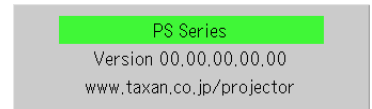

Factory Default

This function returns the adjustments and settings of all the input sources to the standard factory default values.

Select item name “Factory Default” and press the ENTER button.

There is a change to the display [Press “ENTER” to Factory Default Set].

Press the ENTER button to initialize.

To cancel, press the CANCEL button and there will be a return to the menu.

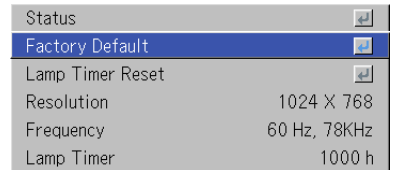

Status	
Factory Default	
Lamp Timer Reset	
Resolution	1024 X 768
Frequency	60 Hz, 78KHz
Lamp Timer	1000 h

Press “ENTER” to FactoryDefault Set

Items that are not set to the factory default:

Vertical Flip / Horizontal Flip, Language and Lamp Timer and Security Lock.

Lamp Timer Reset

This function resets the lamp timer. Be sure to perform the reset operation when the lamp cartridge has been replaced.

Select item name “Lamp Timer Reset” and press the ENTER button.

There is a change to the display “Press “ENTER” to Lamp Timer Reset”.

Press the ENTER button to initialize.

To cancel, press the CANCEL button and there will be a return to the menu.

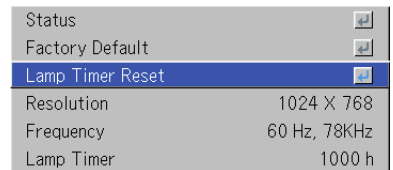

Status	
Factory Default	
Lamp Timer Reset	
Resolution	1024 X 768
Frequency	60 Hz, 78KHz
Lamp Timer	1000 h

Press “ENTER” to LampTimer Reset

Info.

Resolution / Frequency

This function displays the resolution and frequency of the detected input signal.

Status	
Factory Default	
Lamp Timer Reset	
Resolution	1024 X 768
Frequency	60 Hz, 78KHz
Lamp Timer	1000 h

Lamp Timer

This displays the lamp timer.

This projector has an Eco mode function. The lamp life will differ between Normal mode and Eco mode.

Lamp Life

Use only in Normal mode: approx. 2000 hours

Use only in Eco mode: approx. 3000 hours

* Lamp life will differ when there has been switching between the modes.

Status	
Factory Default	
Lamp Timer Reset	
Resolution	1024 X 768
Frequency	60 Hz, 78KHz
Lamp Timer	1000 h

- **When Lamp Life Has Been Reached**

"Replace the Lamp Cartridge" is displayed on the screen for 10 seconds in a 1-minute interval.

Please replace the lamp with a new one.

See "Replacing the Lamp Cartridge" on Page E-58 for information about lamp cartridge replacement.

- **When Over 100 Hours Have Elapsed Since Reaching Lamp Life (Including Eco Mode)**

[Warning!! System Shutdown] is displayed for 10 seconds and the power is switched off. Pressing the POWER/STANDBY button under this condition will not switch on the power. Please replace the lamp cartridge.

When an Indicator is Lit or Flashing

The indicators on the projector's control panel light or flash to notify of problems, as described below. An indicator is also used to notify you of the currently set power mode. See "Power Cable Connections and Switching the Power On/Off" on page E-21.

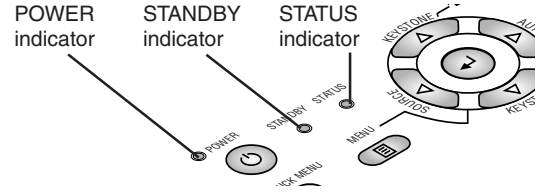

Indicator status	What you should do
<p>When the power is on (Lit green)</p> <p>Lit red</p> <p>Standby mode (Lit green)</p>	<p>It is time to replace the lamp.</p> <p>Replace with a new lamp cartridge.</p>
<p>Lit red</p> <p>Blinks green for 60 seconds (then, lit green)</p>	<p>The lamp has reached the end of its service life. The power will no longer turn on.</p> <p>The projector can be used for 100 hours after the lamp has reached the end of its service life.</p> <p>Replace with a new lamp cartridge.</p>
<p>Blinks red (1 second on/1 second off)</p> <p>Lit green</p>	<p>The lamp cover is open.</p> <p>The lamp cover is not properly mounted. Mount it properly.</p>
<p>Blinks red (0.5 seconds on/0.5 seconds off)</p> <p>Lit green</p>	<p>The temperature is abnormally high.</p> <ul style="list-style-type: none"> The temperature protector has been activated. If the room temperature is high, move the projector to a cool place. If the projector's internal temperature is high, check the cooling fan's ventilation slots and clean them if they are clogged. When the temperature protector is activated, the power turns off and in some cases will not turn back on immediately. In this case wait about 90 seconds, then try again.
<p>Lit green</p> <p>Blinks red (0.5 seconds on/0.5 seconds off)</p> <p>Lit green</p>	<p>The fan has stopped.</p> <p>Unplug the power cable and contact a store that sells the KG-PS100S/KG-PS120X/KG-PS125X for repairs.</p>
<p>Blinks red quickly (0.1 seconds on/0.1 seconds off)</p> <p>Lit green</p>	<p>The lamp will not light.</p> <p>Wait at least 90 seconds, then turn the power back on. If the problem persists, unplug the power cable and contact a store that sells the KG-PS100S/KG-PS120X/KG-PS125X for repairs.</p>

Should an indicator be in a condition other than normal or flash at a rate other than the aforementioned, disconnect the power cable and contact your store of purchase.

Thermal Protector

If the temperature within the projector becomes abnormally high, the thermal protector will be activated and will switch off the power of the projector.

Should this happen, please take the following actions.

1. Switch off the power and disconnect the power plug from the wall outlet.

2. Check the following matters and take the required measures.

When the projector is being used in a location that has a high ambient temperature, set it up again in a cool location. Check the outflow and intake holes and clean them if they are obstructed.

3. Wait about 60 minutes until the temperature of the projector drops.

If after having performed the above matters, the problem still has not been solved, please contact your store of purchase.

Troubleshooting

Check the following matters before requesting servicing.

Problem	Check	Reference Page
Power does not turn on	<ul style="list-style-type: none"> Is the power cord plugged into a power outlet? Is the lamp cover properly mounted? Is the projector's temperature high? To protect the projector, the power cannot be turned on when the projector's temperature is abnormally high. Has the lamp reached the end of its service life? Depending on the timing with which the power cord is plugged in (the power is turned on), it may happen that the POWER indicator (LED) does not light and the power does not turn on. This is not a malfunction. If this happens, unplug the power cord then plug it back in. 	<p>E-21 E-60 E-55</p> <p>E-55 —</p>
No image is produced	<ul style="list-style-type: none"> Is a connected input selected? Is the cable properly connected to the input terminal? When a computer is connected, are signals being output from the computer? Does the signal being input have a frequency usable with this projector? Are the brightness and contrast adjusted to the minimum? Is the STATUS indicator lit a steady red or flashing red? When the component signal of the DVD player is connected with the COMPUTER IN connector and the image is not output, is [Input Settings] of the COMPUTER IN connector properly selected? For a Computer input, has the picture been properly adjusted? 	<p>E-26 E-16–19 E-54 E-64 E-41 E-55 E-50</p> <p>E-41, 42</p>
Image is distorted	<ul style="list-style-type: none"> Is the projector properly installed? For trapezoidal (keystone) distortion, perform keystone adjustment. Please note that depending on the projected picture and the projection conditions, it may not be possible to eliminate keystone distortion completely. 	<p>E-25 E-29, 47</p>
Image is out of focus	<ul style="list-style-type: none"> Is the lens properly focused? Are the screen and projector installed at the proper distance? Does the projection distance exceed the focusing range? Is there condensation on the lens, etc.? If the projector is moved from a cool storage area to a warm place and the power is turned on, condensation may form on the lens or internal optical parts. If this happens, wait until the condensation has evaporated before using the projector. 	<p>E-24 E-15 E-15 —</p>
Image is not in proper position and is not displayed properly	<ul style="list-style-type: none"> For a computer input, are the horizontal and vertical positions properly adjusted? Does the input signal have a compatible resolution and frequency? Check the computer's resolution. 	<p>E-42 E-64</p>
Video image is crushed	<ul style="list-style-type: none"> If the image is crushed in the horizontal or vertical direction or if it is not displayed over the entire screen, select a different aspect ratio. 	E-27
Colors of the overall image are strange	<ul style="list-style-type: none"> When a component signal is being input, is the color space setting proper? For a composite input, is the tint properly adjusted? 	<p>E-44 E-41</p>
Characters flicker or colors are offset for RGB inputs	<ul style="list-style-type: none"> From the menu, select "Image" and adjust the "Picture Adj." and "Fine Picture". 	E-41, 42
Cannot select the menu name	<ul style="list-style-type: none"> Other than [Settings], [Option] and [Information], selection will not be possible unless a signal is being input to the projector and the image/picture is projected. 	—
Remote control unit does not operate	<ul style="list-style-type: none"> Are the remote control unit's batteries worn? Replace with new batteries. Is there an obstacle between the remote control unit and the projector's remote control signal sensor? Is the remote control unit outside of range? Are you pointing the remote control unit's transmitter towards the projector's remote control signal sensor? Is the projector located near fluorescent lighting? 	<p>E-13 E-13</p> <p>E-13 E-13</p> <p>E-13</p>
STATUS indicator is lit red or flashing red	<ul style="list-style-type: none"> See "When an indicator is lit or flashing". 	E-55

Cleaning

- Be certain to disconnect the power plug from the power outlet before cleaning.
- Do not spray or otherwise expose the projector, lens, or screen to volatile substances such as insecticides. Do not leave rubber or vinyl products in contact with the projector for long periods. Doing so could cause them to undergo qualitative changes or the coatings may peel, etc.

Cleaning a Soiled Projector Main Unit

- Wipe with a lint-free, soft, dry cloth.
When very dirty, wipe with a cloth that has been moistened with a diluted neutral detergent, then finish with a dry cloth. If a chemically-treated cloth is going to be used, please follow any written warnings.
- Do not wipe with thinner, benzene, or other solvents. Doing so could cause them to undergo qualitative changes or the coatings may peel, etc.
- When removing the dust of the outflow and intake holes, use the brush attachment on a vacuum cleaner to clean out the dust. Avoid using the vacuum directly without attaching the adapter as well as the use of a nozzle adapter.
- Do not scratch or otherwise hit the projector body with your nails or other hard object, since this will cause scratches.

Dirty Lens

- Clean using the same method you would use to clean a camera lens: Use a commercial blower for camera use or cleaning paper for eye glasses. Be careful not to scratch the lens at this time.

Dust of the Intake and Outflow Holes

Dust that collects in the intake and outflow holes will obstruct the ventilation and cause the internal temperature to rise which could cause damage. Clean this area carefully. As a guideline, clean at least every 100 hours of usage.

- Switch off the power, check that the STANDBY indicator has changed to a steadily lit green, then unplug the power cable.
- Clean out the holes from the outside using a vacuum cleaner. Use the brush adapter of the vacuum cleaner to do this. Avoid using the vacuum directly without attaching the adapter as well as the use of a nozzle adapter.

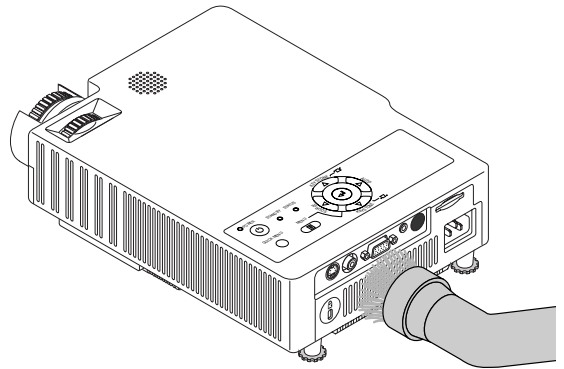

Cleaning the Inside of the Projector

Cleaning of the inside of the projector is required about once a year. Failure to clean over a long period while dust has collected inside the projector could cause a fire or breakdown. Do not clean the inside of the projector by yourself. Please be sure to contact your dealer.

Replacing the Lamp Cartridge

- The lamp that is used as a light source in the projector has a limited service life. The rated service life of the lamp is about 2000 hours (when used in normal mode only). This could be shortened depending on conditions of use and other factors.
Note that lamp life will be extended when the projector is often used in Eco mode. (The rated service life of the lamp means the average value of lamp life for lamps that have been manufactured over a long period, and it is derived from test conditions at this company.)
- When the life of the lamp is exceeded, the STATUS indicator lights a steady red and the message [Replace the Lamp Cartridge] is displayed on the screen. When this occurs, it is time to replace the lamp cartridge. Follow the procedure described on Pages E-59 and E-60 and replace the lamp cartridge.
- If the projector is used another 100 hours after the lamp's service life is reached, the power is set to the standby mode and no longer turns on.
- Contact a store that sells the KG-PS100S/KG-PS120X/KG-PS125X for a replacement lamp. Indicate you need a KG-LPS1230 replacement lamp for the KG-PS100S/KG-PS120X/KG-PS125X (order code 000-155).

CAUTION

- Replacement of the lamp cartridge is performed after switching off the power, waiting for the cooling fan to stop, disconnecting the power plug from the power outlet, and then leaving the projector for about 60 minutes before replacement is started. Replacement of the lamp cartridge during operation or immediately after operation stops will cause burns because of the high temperature.
- Do not remove any screws other than those specified.
- Do not touch the lamp with bare hands. Doing so could shorten the life of the lamp.
- If lamp has reached the end of its usable life, the lamp bulb may shatter. When this happens, an explosive sound can be heard and pieces of glass may be scattered in the lamp cartridge. Do not touch them as the pieces of glass may cause injury. If this happens, contact your dealer or the store the projector was purchased.

Replacing the Lamp Cartridge

Preparations: Turning the projector upside-down on top of a soft cloth, etc., so that it does not get scratched makes it easier to replace the lamp cartridge. Turn the projector right-side up after replacing the lamp cartridge.

1 Unplug the power cord.

2 Turn the projector upside-down.

3 Remove the lamp cover.

(1) Loosen the lamp cover locking screw by turning it counterclockwise until it turns freely. (The screw will not come out.)

(2) Pull in the direction of the arrow and remove.

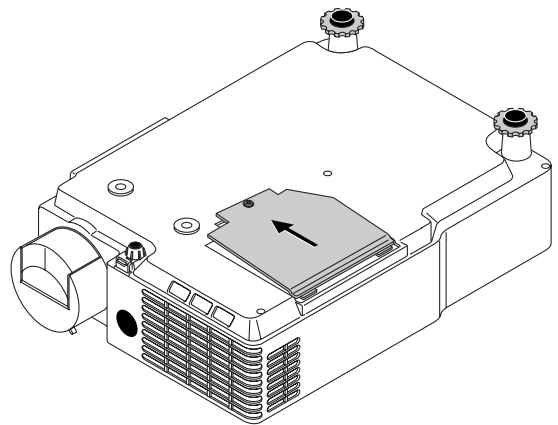
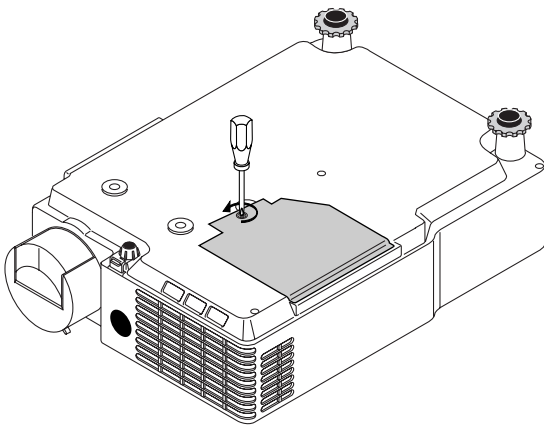

4 Remove the lamp cartridge.

(1) Loosen the 2 screws of the lamp cartridge by turning them counterclockwise until they turn freely. (The screws will not come out.)

(2) Grasp the handles of the lamp cartridge and pull upward to remove the cartridge.

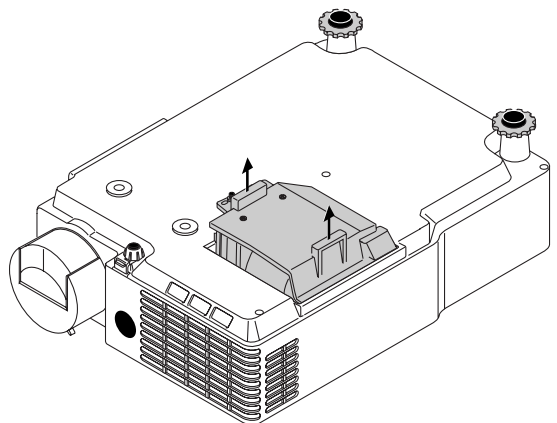
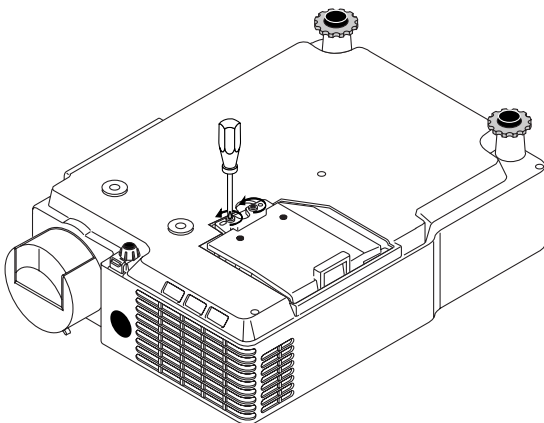

Replacing the Lamp Cartridge

5 Mount the new lamp cartridge.

(1) Slowly push in the lamp cartridge. (Align it with the screw holes of the main unit.)

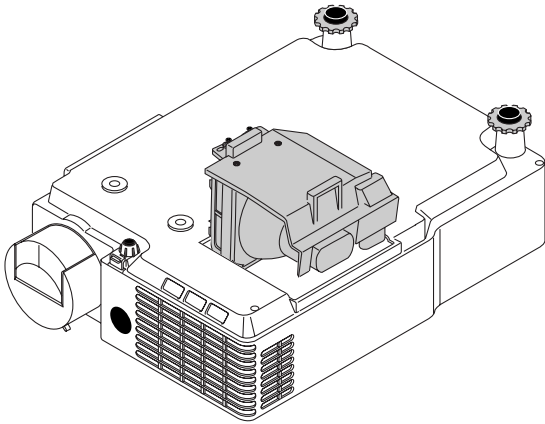

(2) Firmly press down on the specified location, then tighten the 2 screws of the lamp cartridge by turning them clockwise.

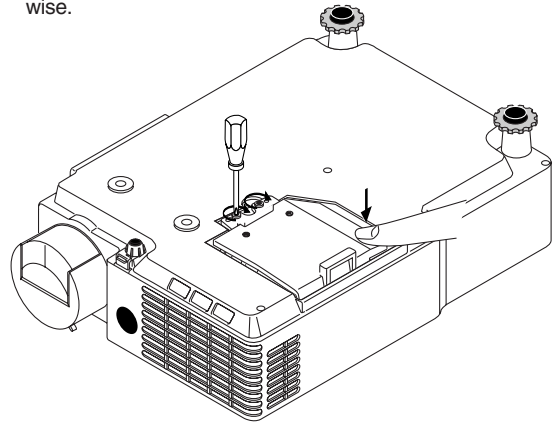

6 Mount the lamp cover.

(1) Insert the edge of the lamp cover into the main unit, then close the lamp cover.

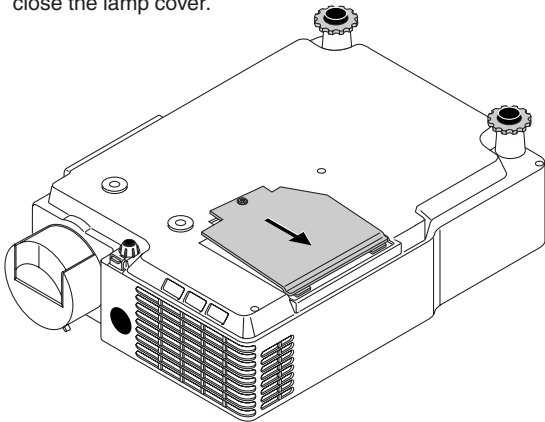

(2) Tighten the screw of the lamp cover by turning it clockwise.

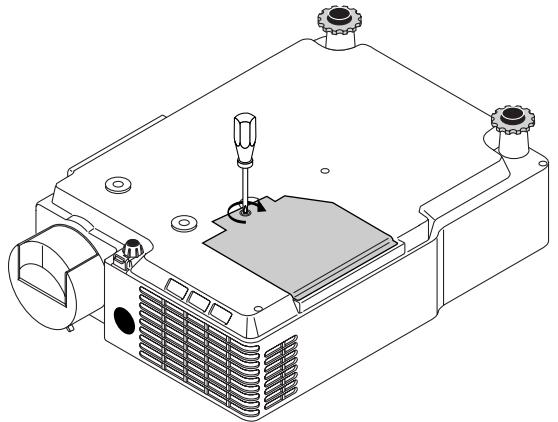

7 Reset the Lamp Timer.

Connect the power cable, switch on the power, and then reset.

Select [Info.] → [Lamp Timer Reset] on the menu and press the ENTER button. There is a change to the initialization verification display. Press the ENTER button again. See "Lamp Timer Reset" on Page E-53.

Note:

After reaching the lamp service life, if the lamp is used for more than another 100 hours, it will not be possible to switch on the power. Should this happen, while the projector is in the standby mode, simultaneously holding down the projector's SOURCE button and AUTO button for more than 5 seconds will clear the lamp timer. Checking that the STATUS indicator is out will show that the lamp timer has been cleared. Contact a store that sells the KG-PS100S/KG-PS120X/KG-PS125X for a replacement lamp. Indicate you need a KG-LPS1230 replacement lamp for the KG-PS100S/KG-PS120X/KG-PS125X (order code 000-155).

Specifications

Model KG-PS100S

Optical

Method of projection : DLP® (single DLP® chip)
DLP® chip 0.55 inches 800 × 600 dots
Lamp 230 W high pressure mercury lamp
Projection lens : Manual zoom (× 1.15), Manual focus F = 2.45 – 2.62, f = 18.7 – 21.5 mm
Image size Minimum 31.7 inch (at projection distance of 1.20 m / 3.9 feet telephoto)
Maximum 300 inch (at projection distance of 10.19 m / 33.43 feet wide)
Light Output Standard mode: 2500 lm
Contrast Ratio 2000:1 (Full on/off)

Electrical

Inputs Video (NTSC/NTSC4.43/PAL/PAL-N/PAL-M/PAL60/SECAM/YCbCr(NTSC, PAL)/YPbPr(480p, 576p, 1080i, 720p)): (automatic or manual switching)
RGB (Horizontal :15 to 80 kHz, Vertical 50 to 85 Hz)
Color Reproduction Full color (16,770,000 colors)
Resolution VGA (640 × 480) expansion/true, S-VGA (800 × 600) true
XGA (1024 × 768) compression
Input Current 2.8 A
Power Requirement 100 - 240 V AC, 50/60 Hz
Power Consumption 280 watts (240 watts in eco mode)

Mechanical

Dimensions Excluding Stand 195 mm (W) × 58 mm (H) × 262 mm (D) (when stored, not including projecting parts)
7.7 in.(W) × 2.3 in.(H) × 10.3 in.(D) (when stored, not including projecting parts)
Weight Approximately 1.8 kg / 4.0 lbs
Operational Temperatures Data projector: 5° to 35°C (41° to 95°F), 30 to 85% humidity

- Specifications and design are subject to change without notice.

Specifications

Model KG-PS120X

Optical

Method of projection : DLP® (single DLP® chip)
DLP® chip 0.55 inches 1024 × 768 dots
Lamp 230 W high pressure mercury lamp
Projection lens : Manual zoom (× 1.15), Manual focus F = 2.45 – 2.62, f = 18.7 – 21.5 mm
Image size Minimum 31.7 inch (at projection distance of 1.20 m / 3.9 feet telephoto)
Maximum 300 inch (at projection distance of 10.19 m / 33.43 feet wide)
Light Output Standard mode: 2500 lm
Contrast Ratio 2000:1 (Full on/off)

Electrical

Inputs Video (NTSC/NTSC4.43/PAL/PAL-N/PAL-M/PAL60/SECAM/YCbCr(NTSC, PAL)/YPbPr(480p, 576p, 1080i, 720p)): (automatic or manual switching)
RGB (Horizontal :15 to 80 kHz, Vertical 50 to 85 Hz)
Color Reproduction Full color (16,770,000 colors)
Resolution VGA (640 × 480) expansion/true, S-VGA (800 × 600) expansion/true
XGA (1024 × 768) true, S-XGA (1280 × 1024) compression
Input Current 2.8 A
Power Requirement 100 - 240 V AC, 50/60 Hz
Power Consumption 280 watts (240 watts in eco mode)

Mechanical

Dimensions Excluding Stand 195 mm (W) × 58 mm (H) × 262 mm (D) (when stored, not including projecting parts)
7.7 in.(W) × 2.3 in.(H) × 10.3 in.(D) (when stored, not including projecting parts)
Weight Approximately 1.8 kg / 4.0 lbs
Operational Temperatures Data projector: 5° to 35°C (41° to 95°F), 30 to 85% humidity

- Specifications and design are subject to change without notice.

Specifications

Model KG-PS125X

Optical

Method of projection : DLP® (single DLP® chip)
DLP® chip 0.55 inches 1024 × 768 dots
Lamp 230 W high pressure mercury lamp
Projection lens : Manual zoom (× 1.15), Manual focus F = 2.45 – 2.62, f = 18.7 – 21.5 mm
Image size Minimum 31.7 inch (at projection distance of 1.20 m / 3.9 feet telephoto)
Maximum 300 inch (at projection distance of 10.19 m / 33.43 feet wide)
Light Output Standard mode: 2500 lm
Contrast Ratio 2000:1 (Full on/off)

Electrical

Inputs Video (NTSC/NTSC4.43/PAL/PAL-N/PAL-M/PAL60/SECAM/YCbCr(NTSC, PAL)/YPbPr(480p, 576p, 1080i, 720p)): (automatic or manual switching)
RGB (Horizontal :15 to 80 kHz, Vertical 50 to 85 Hz)
Color Reproduction Full color (16,770,000 colors)
Resolution VGA (640 × 480) expansion/true, S-VGA (800 × 600) expansion/true
XGA (1024 × 768) true, S-XGA (1280 × 1024) compression
Input Current 3.0 A
Power Requirement 100 - 240 V AC, 50/60 Hz
Power Consumption 300 watts (260 watts in eco mode)

Mechanical

Dimensions Excluding Stand 195 mm (W) × 58 mm (H) × 262 mm (D) (when stored, not including projecting parts)
7.7 in.(W) × 2.3 in.(H) × 10.3 in.(D) (when stored, not including projecting parts)
Weight Approximately 1.8 kg / 4.0 lbs
Operational Temperatures Data projector: 5° to 35°C (41° to 95°F), 30 to 85% humidity

- Specifications and design are subject to change without notice.

Table of Supported Frequency

The projector automatically identifies the signal input from the computer and selects the optimum resolution as shown on the table below.

Manual adjustments may be required for some input signals. See "Picture Adj. / Fine Picture / H Position / V Position" on page E-41, 42.

Signal	Resolution	Frequency		Video	Component	Digital	Analog
		Horizontal (kHz)	Vertical (Hz)				
VIDEO(NTSC)	—	15.734	60.0	○	○	—	—
VIDEO(PAL/SECAM)	—	15.625	50.0	○	○	—	—
PC/AT	640 × 350	31.5	70.1	—	—	—	○
	640 × 400	31.5	70.1	—	—	—	○
	720 × 350	31.5	70.0	—	—	—	○
	720 × 400	31.5	70.0	—	—	—	○
VESA	640 × 350	37.9	85.1	—	—	—	○
	640 × 400	37.9	85.1	—	—	—	○
	720 × 400	37.9	85.0	—	—	—	○
	640 × 480	31.5	60.0	—	—	—	○
	640 × 480	37.9	72.8	—	—	—	○
	640 × 480	37.5	75.0	—	—	—	○
	640 × 480	43.3	85.0	—	—	—	○
	800 × 600	35.2	56.3	—	—	—	○
	800 × 600	37.9	60.3	—	—	—	○
	800 × 600	46.9	75.0	—	—	—	○
	800 × 600	48.1	72.2	—	—	—	○
	800 × 600	53.7	85.1	—	—	—	○
	1024 × 768	48.4	60.0	—	—	—	○
	1024 × 768	56.5	70.1	—	—	—	○
	1024 × 768	60.0	75.0	—	—	—	○
	1024 × 768	68.7	85.0	—	—	—	○
1280 × 1024	64.0	60.0	—	—	—	○	
Apple Macintosh	640 × 480	35.0	66.7	—	—	—	○
	823 × 624	49.7	74.5	—	—	—	○
	1024 × 768	60.2	74.9	—	—	—	○
	1152 × 870	68.7	75.1	—	—	—	○
HDTV (1080i)	1920 × 1080	33.8	60.0	—	○	—	—
	1920 × 1080	28.1	50.0	—	○	—	—
(720p)	1280 × 720	45.0	60.0	—	○	—	—
EDTV (576p)	720 × 576	31.3	50.0	—	○	—	—
	(480p)	720 × 480	31.5	60.0	—	○	—
SDTV (576i)	720 × 576	31.3	50.0	—	○	—	—
	(480i)	720 × 480	31.5	60.0	—	○	—

* The model name for XGA is KG-PS120X/KG-PS125X and SVGA is KG-PS100S.

* The projector does not support the ADC connector on Apple Macintosh.

○ : Supported frequency
 — : Not supported frequency

KG-PS120X/KG-PS125X

The display resolution is 1024 × 768 dots. When displaying a signal with resolutions other than 1024 × 768 dots such as 1280 × 1024, sizes of characters or lines may be uneven.

KG-PS100S

The display resolution is 800 × 600 dots. When displaying a signal with resolutions other than 800 × 600 dots such as 1024 × 768, sizes of characters or lines may be uneven.

Cabinet Dimensions

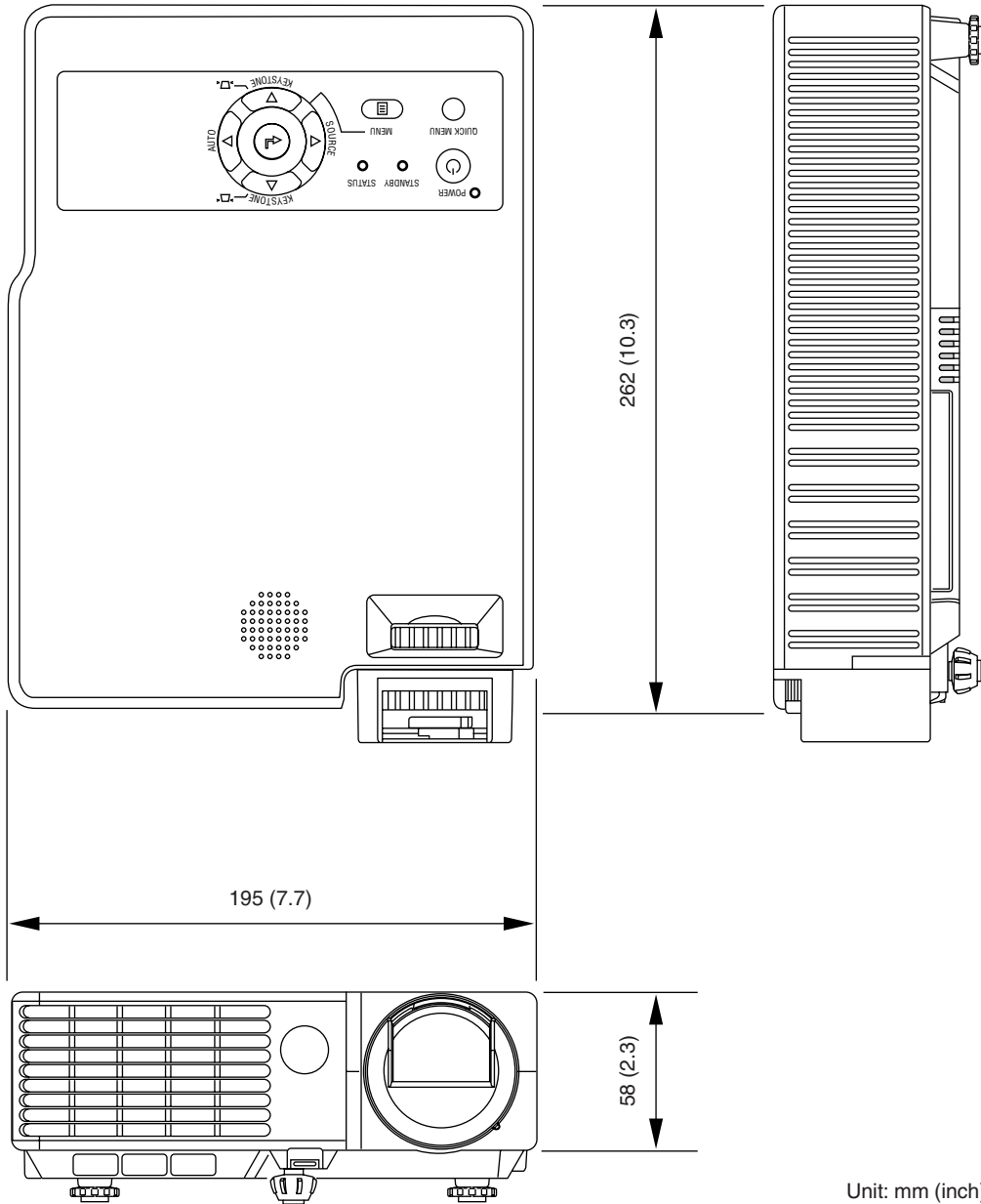

Unit: mm (inch)

KAGA COMPONENTS CO.,LTD.
2-2-9, Hongo,Bunkyo-ku, TOKYO 113-0033, JAPAN
www.taxan.co.jp/projector
supportmail@kgcompo.co.jp