

myprojectorlamps.com

**The most trusted, dependable name
in projector lamp sales.**



<http://www.myprojectorlamps.com>



<http://www.myprojectorlamps.ca>



<http://www.myprojectorlamps.eu>

The following projector manual has not been modified or altered in any way.

4-091-169-12(1)

GRAND WEGA

OPERATING INSTRUCTIONS
KF-50XBR800
KF-60XBR800

To prevent fire or shock hazard, do not expose the LCD Projection TV to rain or moisture.

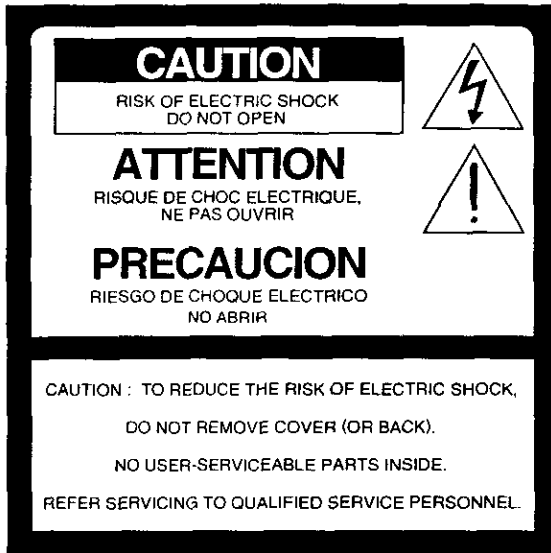

This symbol is intended to alert the user to the presence of uninsulated “dangerous voltage” within the product’s enclosure that may be of sufficient magnitude to constitute a risk of electric shock to persons.



This symbol is intended to alert the user to the presence of important operating and maintenance (servicing) instructions in the literature accompanying the appliance.

CAUTION

To prevent electric shock, do not use this polarized AC plug with an extension cord, receptacle or other outlet unless the blades can be fully inserted to prevent blade exposure.

Note on Caption Vision

This television receiver provides display of television closed captioning in accordance with §15.119 of the FCC rules.

This reminder is provided to call the CATV system installer’s attention to Article 820-40 of the NEC that provides guidelines for proper grounding and, in particular, specifies that the cable ground shall be connected to the grounding system of the building, as close to the point of cable entry as practical.

Use of this television receiver for other than private viewing of programs broadcast on UHF, VHF, transmitted by cable companies or satellite for the use of the general public may require authorization from the broadcaster/cable company and/or program owner.

RECOMMENDATIONS

This equipment has been tested and found to comply with the limits for a Class B digital device pursuant to Part 15 of the FCC Rules. These limits are designed to provide reasonable protection against harmful interference in a residential installation. This equipment generates, uses, and can radiate radio frequency energy and, if not installed and used in accordance with the instructions, may cause harmful interference with radio communications. However, there is no guarantee that interference will not occur in a particular installation. If this equipment does cause harmful interference to radio or television reception, which can be determined by turning the equipment off and on, the user is encouraged to try to correct the interference by one or more of the following measures:

- Reorient or relocate the receiving antennas.
- Increase the separation between the equipment and receiver.
- Connect the equipment into an outlet on a circuit different from that to which the receiver is connected.
- Consult the dealer or an experienced radio/TV technician for help.

You are cautioned that any changes or modifications not expressly approved in this manual could void your warranty and your authority to operate this equipment.

This document is for the remote control RM-Y912.
 MODEL: KF-50XBR800, KF-60XBR800
 Please keep this notice with the instruction manual.

Operate the LCD Projection TV only on 120 V AC. The plug is designed, for safety purposes, to fit into the wall outlet only one way. If you are unable to insert the plug fully into the outlet, contact your dealer.

If any liquid or solid object should fall inside the cabinet, unplug the LCD Projection TV immediately and have it checked by qualified service personnel before operating it further.

If you will not be using the LCD Projection TV for several days, disconnect the power by pulling the plug itself. Never pull on the cord.

For details concerning safety precautions, see "Important Safeguards" on page 4.

To prevent internal heat buildup, do not block the ventilation openings.

Do not install the LCD Projection TV in a hot or humid place, or in a place subject to excessive dust or mechanical vibration.

Avoid operating the LCD Projection TV at temperature below 41°F (5°C).

If the LCD Projection TV is transported directly from a cold to a warm location, or if the room temperature changes suddenly, the picture may be blurred or show poor color. In this case, please wait a few hours to let the moisture evaporate before turning on the LCD Projection TV.

To obtain the best picture, do not expose the screen to direct illumination or direct sunlight. It is recommended to use spot lighting directed down from the ceiling or to cover the windows that face the screen with opaque drapery. It is desirable to install the LCD Projection TV in a room where the floor and walls are not of a reflective material.



As an ENERGY STAR® Partner, Sony Corporation has determined that this product meets the ENERGY STAR® guidelines for energy efficiency.

ENERGY STAR® is a U.S. registered mark.

TruSurround and the (●) symbol are trademarks of SRS Labs, Inc.

TruSurround technology is incorporated under license from SRS Labs, Inc.

BBE and BBE Symbol are trademarks of BBE Sound, Inc. and are licensed by BBE Sound, Inc. under U.S. Patent No. 4,638,258 and 4,482,866.

Pour prévenir les chocs électriques, ne pas utiliser cette fiche polarisée avec un prolongateur, une prise de courant ou une autre sortie de courant, sauf si les lames peuvent être insérées à fond sans en laisser aucune partie à découvert.

The model and serial numbers are located at the rear of the LCD Projection TV, below the Sony logo, on the sticker, and also on the TV box (white label). Record these numbers in the spaces provided below. Refer to them whenever you call upon your Sony dealer regarding this product.

Model No. _____

Serial No. _____

- 1) Read these instructions.
- 2) Keep these instructions.
- 3) Heed all warnings.
- 4) Following all instructions.
- 5) Do not use this apparatus near water.
- 6) Clean only with dry cloth.
- 7) Do not block any ventilation openings. Install in accordance with the manufacturer's instructions.
- 8) Do not install near any heat sources such as radiators, heat registers, stoves, or other apparatus (including amplifiers) that produce heat.
- 9) Do not defeat the safety purpose of the polarized or grounding-type plug. A polarized plug has two blades with one wider than the other. A grounding type plug has two blades and a third grounding prong. The wide blade or the third prong are provided for your safety. If the provided plug does not fit into your outlet, consult an electrician for replacement of the obsolete outlet.
- 10) Protect the power cord from being walked on or pinched particularly at plugs, convenience receptacles, and the point where they exit from the apparatus.
- 11) Only use attachments/accessories specified by the manufacturer.
- 12) Use only with the cart stand, tripod, bracket, or table specified by the manufacturer, or sold with the apparatus. When a cart is used, use caution when moving the cart/apparatus combination to avoid injury from tip-over.
- 13) Unplug this apparatus during lightning storms or when unused for long periods of time.
- 14) Refer all servicing to qualified service personnel. Servicing is required when the apparatus has been damaged in any way, such as power-supply cord or plug is damaged, liquid has been spilled or objects have fallen into the apparatus, the apparatus has been exposed to rain or moisture, does not operate normally, or has been dropped.
- 15) Apparatus shall not be exposed to dripping or splashing and no objects filled with liquids, such as vases, shall be placed on the apparatus.

For your protection, please read these instructions completely, and keep this manual for future reference.

Carefully observe and comply with all warnings, cautions and instructions placed on the set or described in the operating instructions or service manual.

Important

To guard against injury, the following basic safety precautions should be observed in the installation, use and servicing of the set.

Warning

Check for Voltage

This set should be operated only from the type of power source indicated on the serial/model plate. If you are not sure of the type of electrical power supplied to your home, consult your dealer or local power company. For those sets designed to operate from battery power, refer to the operating instructions.



Grounding or Polarization

This set is equipped with a polarized AC power cord plug (a plug having one blade wider than the other), or with a three-wire grounding type plug (a plug having a third pin for grounding). Follow the instructions below:

For the set with a polarized AC power cord plug

This plug will fit into the power outlet only one way. This is a safety feature. If you are unable to insert the plug fully into the outlet, try reversing the plug. If the plug still fails to fit, contact your electrician to have a suitable outlet installed. Do not defeat the safety purpose of the polarized plug by forcing it in.



Alternate Warning for the set with a three-wire grounding type AC plug

This plug will only fit into a grounding-type power outlet. This is a safety feature. If you are unable to insert the plug into the outlet, contact your electrician to have a suitable outlet installed. Do not defeat the safety purpose of the grounding plug.

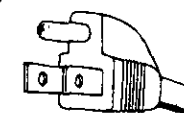

Do not overload wall outlets, extension cords or convenience receptacles beyond their capacity, since this can result in fire or electric shock.

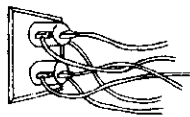

Always turn the set off when it is not being used. When the set is left unattended and unused for long periods of time, unplug it from the wall outlet as a precaution against the possibility of an internal malfunction that could create a fire hazard.



If a snapping or popping sound from a TV set is continuous or frequent while the TV is operating, unplug the TV and consult your dealer or service technician. It is normal for some TV sets to make occasional snapping or popping sounds, particularly when being turned on or off.

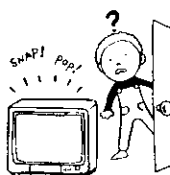

Object and Liquid Entry

Never push objects of any kind into the set through the cabinet slots as they may touch dangerous voltage points or short out parts that could result in a fire or electric shock. Never spill liquid of any kind on the set.



Attachments

Do not use attachments not recommended by the manufacturer, as they may cause hazards.

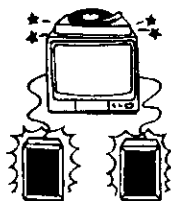

Cleaning

Clean the cabinet of the LCD Projection TV with a dry soft cloth. To remove dust from the screen, wipe it gently with a soft cloth. Stubborn stains may be removed with a cloth slightly dampened with solution of mild soap and warm water. Never use strong solvents such as thinner or benzene for cleaning.



If the picture becomes dark after using the LCD Projection TV for a long period of time, it may be necessary to clean the inside of the LCD Projection TV. Consult qualified service personnel.

The screen surface has a special coating to reduce a picture displayed by reflecting. If you clean the screen surface in the wrong way, the screen may be damaged. To clean the screen, do as follows:

Clean the screen with a soft cloth, such as the supplied cleaning cloth or a glass cleaning cloth. To remove hard contamination, use the supplied cleaning cloth or a glass cleaning cloth moistened with a solution of mild detergent and water. Do not use any type of abrasive pad, alkaline cleaner, acid cleaner, scouring powder, chemical cloth, or solvent such as alcohol, benzene or thinner, as these may scratch the screen's coating.

Do not use power-line operated sets near water — for example, near a bathtub, washbowl, kitchen sink, or laundry tub, in a wet basement, or near a swimming pool, etc.

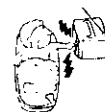

Do not place the set on an unstable cart, stand, table or shelf. The set may fall, causing serious injury to a child or an adult and serious damage to the set. Use only a cart or stand recommended by the manufacturer for the specific model of LCD Projection TV. An appliance and cart combination should be moved with care. Quick stops, excessive force, and uneven surfaces may cause the appliance and cart combination to overturn.



The slots and openings in the cabinet and in the back or bottom are provided for necessary ventilation. To ensure reliable operation of the set, and to protect it from overheating, these slots and openings must never be blocked or covered.

Never cover the slots and openings with a cloth or other materials.



Never block the slots and openings by placing the set on a bed, sofa, rug or other similar surface.



Never place the set in a confined space, such as a bookcase or built-in cabinet, unless proper ventilation is provided.



Do not place the set near or over a radiator or heat register, or where it is exposed to direct sunlight.



Power-Cord Protection

Do not allow anything to rest on or roll over the power cord, and do not place the set where the power cord is subject to wear or abuse.



Antennas

Outdoor Antenna Grounding

If an outdoor antenna is installed, follow the precautions below. An outdoor antenna system should not be located in the vicinity of overhead power lines or other electric light or power circuits, or where it can come in contact with such power lines or circuits.

WHEN INSTALLING AN OUTDOOR ANTENNA SYSTEM, EXTREME CARE SHOULD BE TAKEN TO KEEP FROM CONTACTING SUCH POWER LINES OR CIRCUITS AS CONTACT WITH THEM IS ALMOST INVARIABLY FATAL.

Be sure the antenna system is grounded so as to provide some protection against voltage surges and built-up static charges.

Section 810 of the National Electrical Code (NEC) in USA and Section 54 of the Canadian Electrical Code in Canada provides information with respect to proper grounding of the mast and supporting structure, grounding of the lead-in wire to an antenna discharge unit, size of grounding conductors, location of antenna discharge unit, connection to grounding electrodes, and requirements for the grounding electrode.

Refer to section 54-300 of Canadian Electrical Code for Antenna Grounding.

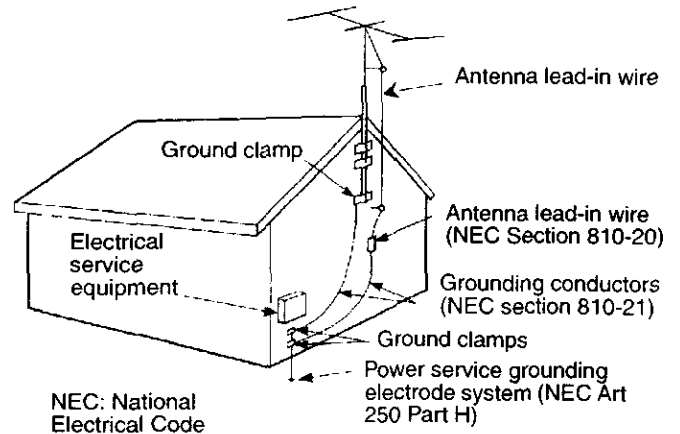





Lightning

For added protection for this television receiver during a lightning storm, or when it is left unattended and unused for long periods of time, unplug it from the wall outlet and disconnect the antenna. This will prevent damage to the receiver due to lightning and power-line surges.

Service

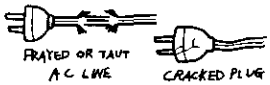
When Service is Required

Unplug the set from the wall outlet and refer servicing to qualified service personnel under the following conditions:

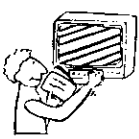
- 1. When the power cord or plug is damaged or frayed. 
- 2. If liquid has been spilled into the set. 
- 3. If the set has been exposed to rain or water. 
- 4. If the set has been subject to excessive shock by being dropped, or the cabinet has been damaged. 
- 5. If the set does not operate normally when following the operating instructions. Adjust only those controls that are specified in the operating instructions. Improper adjustment of other controls may result in damage and will often require extensive work by a qualified technician to restore the set to normal operation. 

When the set exhibits a distinct change in performance, it indicates a need for service.

Warning

Do not attempt to service the set by yourself since opening the cabinet may expose you to dangerous voltage or other hazards. Refer all servicing to qualified service personnel.



Replacement Parts

When replacement parts are required, be sure the service technician certifies in writing that he has used replacement parts specified by the manufacturer that have the same characteristics as the original parts.

Unauthorized substitutions may result in fire, electric shock or other hazards.

Service Check

Upon completion of any service or repairs to the set, ask the service technician to perform routine safety checks (as specified by the manufacturer) to determine that the set is in safe operating condition, and to so certify. When the set reaches the end of its useful life, improper disposal could result in a picture tube implosion. Ask a qualified service technician to dispose of the set.



General Safety

Be careful when moving the LCD Projection TV

When you place the LCD Projection TV in position, be careful not to drop it on your foot or fingers.

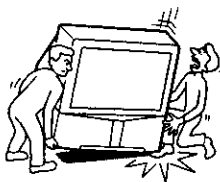

Watch your footing while installing the LCD Projection TV.

Carry the LCD Projection TV in the specified manner

If you carry the LCD Projection TV in a manner other than the specified manner and without the specified number of persons, it may drop and a serious injury may be caused. Be sure to follow the instructions mentioned below.

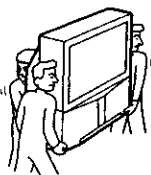

- Carry the LCD Projection TV with the specified number of persons (see page 18).
- Do not carry the LCD Projection TV holding the speaker grill.
- Hold the LCD Projection TV tightly when carrying it.

Warning about LCD Projection TV

Although the LCD projection TV is made with high-precision technology, black dots may appear or bright points of light (red, blue, or green) may appear constantly on the LCD screen. This is a structural property of the LCD panel and is not a malfunction.

— If direct sunlight or other strong illumination shines on the screen, part of the screen appears white due to reflections from behind the screen. This is a structural property of the LCD Projection TV.

— Do not expose the screen to direct illumination or direct sunlight.

— The picture quality may be affected by your viewing position. If you view the TV close to you, you may suffer from eye fatigue.

— For the best picture quality, install your LCD projection TV according to the operating instructions.

— Sit at least 1.8 m (approx. 6 ft.) for KF-50XBR800 or 2.2 m (approx. 7 ft.) for KF-60XBR800 away from your LCD projection TV, and within 60° of the vertical viewing area, and 130° of the horizontal viewing area.

— When installing your LCD Projection TV against a wall, keep it at least 10 cm (4 inches) from the wall.

Projection lamp

— Your LCD projection TV uses a projection lamp as its light source. When the projection lamp wears out after using the LCD projection TV for a long period of time, the screen image becomes dark, or no image will appear on the display. If the lamp replacement indicator of the front panel blinks in red, replace the lamp with a new one (not supplied). In some cases, the lamp bursts inside the lamp unit noisily, but the lamp unit is securely designed so that the pieces of broken glass remain inside the lamp unit. (See “Replacing the Lamp” on page 13.)

Cooling fan

— This LCD projection TV uses a cooling fan to prevent the internal temperature from heating up. You might hear the noise from the cooling fan, depending on the place you install the LCD projection TV.

Contents

Getting Started

Presenting the Sony LCD Projection TV	9
Using This Manual.....	10
Enjoying Your LCD Projection TV	11
Replacing the Lamp	13

Getting and Using the LCD

Contents	17
Inserting Batteries into the Remote Control	17
Carrying Your LCD Projection TV	18
To Prevent the LCD Projection TV from Falling Down.....	19
When Installing Your LCD Projection TV Against a Wall.....	19
Recommended Viewing Area.....	20
LCD Projection TV Controls and Connectors.....	21
Connector Types	24
Basic Connections (Connecting Cable TV or Antenna).....	25
Connecting a VCR and Cable	29
Connecting a VCR and Cable Box	30
Connecting Two VCRs for Tape Editing	32
Connecting a Satellite Receiver.....	33
Connecting a Satellite Receiver with a VCR.....	34
Connecting an Audio Receiver	36
Connecting a DVD Player with Component Video Connectors	37
Connecting a DVD Player with A/V Connectors ..	38
Connecting a Digital TV Receiver with component connectors	39
Connecting a Digital TV Receiver with DVI-HDTV connector.....	40
Connecting a Camcorder	41
Connecting Two VCRs for Tape Editing	42
Using the CONTROL S Feature	43
Setting Up the LCD projection TV Automatically.....	44

Using the Features

Using the Remote Control	45
Watching the TV.....	47

Watching Digital TV	49
Using Favorite Channels.....	50
Using Twin View™.....	51
Using the Freeze Function	54
Using Scrolling Channel Index.....	55
Using Wide Screen Mode	57
Using the Memory Stick Picture Viewer.....	58

Menus

Overview.....	66
Using the Video Menu.....	67
Using the Audio Menu.....	69
Using the Screen Menu.....	71
Using the Channel Menu	73
Using the Parent Menu	75
Using the Setup Menu	79

Additional

Programming the Remote Control.....	82
Operating Other Components with Your LCD Projection TV Remote Control.....	84
Notes on Using Memory Stick Media	86
Troubleshooting.....	87
Flashing Indicators on the Front of the Monitor....	90
Specifications.....	91

Thank you for purchasing the Sony LCD Projection TV.
This manual is for models KF-50XBR800 and KF-60XBR800.

Features

Some of the features that you will enjoy with your new LCD projection TV include:

- **HD-Monitor:** Enables you to receive the 1080i, 720p, 480p and 480i digital TV format signals.
By using the HD/DVD IN jacks, you can connect a DTV (digital television) receiver to view DTV programs.
- **DRC™ (Digital Reality Creation) Multifunction UI:** Unlike conventional line doublers, the DRC feature converts frames reproduced every 1/60th of a second in real time, minimizing the blur or ghost of the motion images (for NTSC signals only).
- **CineMotion™:** Using the reverse 3-2 pull down technology, the CineMotion feature allows you to obtain a smooth picture movement when playing back movies or other video sources on film.
- **Twin View™:** Using Multi-Image Driver (MID-X), Twin View allows you to watch two programs side by side with the ability to zoom in on one picture and listen to the program in the selected window. You can watch pictures from two different sources (1080i, 720p, 480p or 480i) simultaneously.
- **Memory Stick® Picture Viewer:** Allows you to view on your LCD Projection TV screen digital images that are stored on Memory Stick media.
- **Parental Control:** V-Chip technology allows parents to block unsuitable programming for younger viewers.
- **Digital Visual Interface (DVI):** Can accommodate a copy-protected digital connection (HDCP*) to other devices (such as digital set-top boxes) that have compatible interfaces. The DVI-HDTV input terminal is compliant with the EIA-861 standard and is not intended for use with personal computers.

* High-bandwidth Digital Content Protection

(Continued)

Component Video Inputs: Offers the best video quality for DVD (480p, 480i) and Digital Set-top box (1080i, 720p, 480p, 480i) connections.

S-VIDEO Inputs: Provides a high-quality image for connected equipment.

Favorite Channel Preview: Preview up to eight favorite channels without leaving the current channel.

Scrolling Channel Index: Allows you to view and choose channels from scrolling pictures without leaving the current channel.

Wide Screen Mode: Allows you to watch 4:3 normal broadcasts in wide screen mode (16:9 aspect ratio).

Auto Wide: Allows you to select the wide screen mode automatically.

We recommend that you carefully review the contents of the following three sections in the order shown to ensure that you fully understand the operation of your new LCD projection TV.

1 Installing and Connecting the LCD Projection TV

This section guides you through your initial setup. It shows you how to install your LCD projection TV, to connect your new components and to connect the antenna and cable.

2 Using the Features

This section shows you how to begin using your new LCD projection TV. It also shows you how to use your remote control functions.

3 Using the menus

This section teaches you how to access on-screen menus and adjust your LCD projection TV settings.

Instructions in this manual are written for the remote control. Similar controls are also found on the LCD projection TV console.

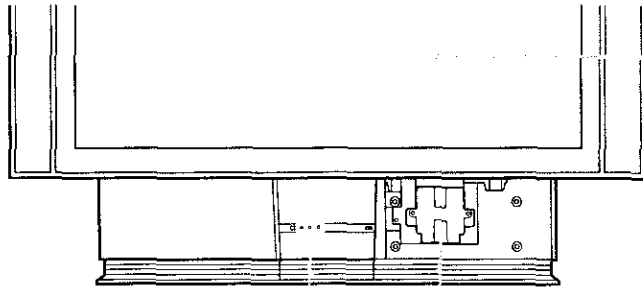

Indicators Projection lamp Screen

Indicators

The indicators show the current status of your LCD projection TV. If the LAMP indicator flashes, see “Flashing Indicators on the Front of the Monitor” on page 90.

Screen

To minimize screen reflection, its surface has a special coating. Read the instructions “Use of the Cleaning Cloth” on page 12 carefully before cleaning.

Inappropriate cleaning methods could damage the finishing.

Projection lamp

Your LCD projection TV uses a projection lamp as its light source. Note the following:

- After turning on your LCD projection TV, it may take a while before the picture appears (1 minute or less).
- When the projection lamp wears out, the screen image becomes dark. Replace the lamp with a new Sony XL-2000U replacement lamp (not supplied).
- ✎ Be sure to attach the lamp cover securely; otherwise, your LCD projection TV will not turn on. For details on lamp replacement, see “Replacing the Lamp” on page 13.
- ✎ The light emitted from the lamp is quite bright when your LCD projection TV is in use. To avoid eye discomfort or injury, do not look into the housing when the power is on.

Notes on the LCD Projection TV

When watching TV

- Be sure not to allow sunlight or light from a lamp to shine directly onto the screen.
- The screen surface is easily scratched. Do not rub, touch, or tap it with a sharp or abrasive object (see “Use of the Cleaning Cloth” below).

When moving the TV

- If your LCD projection TV is transported directly from a cold to a warm location, is placed in a humid room, or if the room temperature changes suddenly, the picture may be blurred or show poor color. This is because moisture has condensed on the lenses inside. If this happens, leave the power on and let the moisture evaporate before using your LCD projection TV.

When going to sleep or going out

- Turn off the main power on the front of your LCD projection TV before going to sleep or going out. Disconnect the AC plug if idle for more than 7 days.

When turning off the power

- Be sure to turn off the power switch on the main unit or on the remote control. After turning off the power, the fan will continue to blow for about two minutes. Be sure to wait for several minutes after turning the power off when unplugging from the outlet or switching the breaker off.

Use of the Cleaning Cloth

To remove dust from the front of the screen, wipe with the supplied Cleaning Cloth.

- ✎ Do not use any type of abrasive pad, alkaline cleaner, scouring powder, window cleaners or solvent such as alcohol or benzene. Otherwise, this type of contact may result in a damaged screen.
- ✎ To clean the screen, please use the supplied Cleaning Cloth lightly moistened with water diluted mild detergent solution. Do not apply heavy press when cleaning.
- ✎ The supplied Cleaning Cloth is washable with warm water and a mild detergent solution, and can be used repeatedly.

The projection lamp has a limited life which illuminates the picture.

If the screen becomes dark, the color looks unusual, or the LAMP indicator on the front of the LCD projection TV flashes, it is time to replace the lamp with a new one (not supplied).



Electric appliances can cause fire or high temperature, resulting in injury or death. Be sure to follow the instructions below.

- Use a Sony XL-2000U replacement lamp (not supplied) for replacement. Failure to do so may damage the LCD projection TV.
- Do not remove the lamp for any purpose other than replacement. Failure to do so may cause fire or a skin burn.
- Before replacing the lamp, turn the power off on the main unit, then several minutes later, unplug the power cord. (The cooling fan will continue to blow for about two minutes after turning the power off.)
- Before replacing the lamp, let it cool down completely, as the surface of the lamp remains extremely hot for at least 30 minutes after the power has been turned off.
- Do not leave the removed lamp near flammable materials or within the reach of children.
- Do not pour water onto the removed lamp, or put any object inside the lamp. Doing so may cause the lamp to burst.
- Do not put flammable materials and metal objects inside the lamp receptacle of the LCD projection TV after removing the lamp. Doing so may cause fire or electrical shock. Also, be sure not to touch the receptacle, because it may cause a skin burn.
- Mount the new lamp securely, otherwise the screen may become dark, or it may cause a fire.
- Do not touch the glass with your fingers on the new lamp.

Collecting the used lamp

For environmental conservation, Sony collects the used lamps. Please put the used lamp in the lamp box and give it to your Sony dealer where you bought the lamp.

- ✎ Do not touch the front glass of a new lamp or the glass of the lamp receptacle. This may reduce picture quality or lamp life.

(Continued)

1 Turn off the power switch on the LCD projection TV and after several minutes, unplug the power cord.
(The cooling fan will continue to blow for about two minutes after turning the power off.)

2 Do not touch the front glass of a new lamp or the glass of the lamp receptacle. This may reduce picture quality or lamp life.

3 Unplug the power cord after turning off the main power. Wait at least 30 minutes to allow the lamp to cool down before replacing it. Take the new lamp out of the box.

4 Remove the front panel.

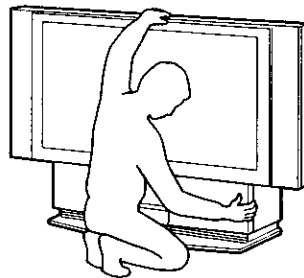

Hold the LCD projection TV firmly so that it does not move.

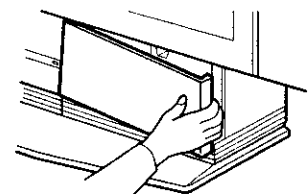
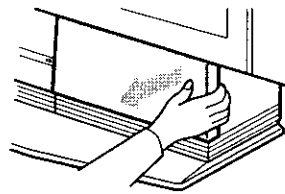

Grasping the right end of the front panel with your fingers, pull the panel towards you.

5 Loosen the screw with a coin or similar object to remove the lamp cover.

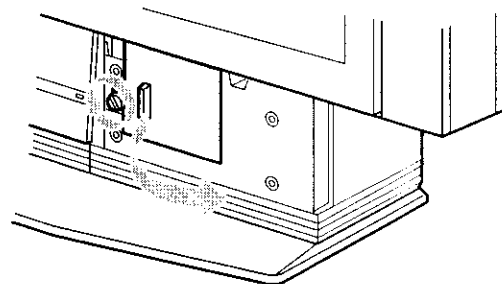

Loosen the two screws that secure the lamp, then pull out the lamp. The lamp is very hot immediately after use. Never touch the front glass of the lamp or the surrounding parts.

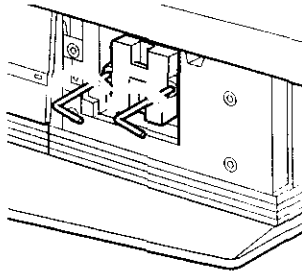

Loosen the two screws with the hex key supplied with the lamp.

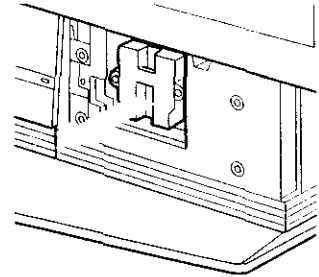

Hold the handle and pull straight out.

After it has cooled, place the removed lamp into the empty box of the replacement lamp. Never put the removed lamp into a plastic bag.

Mount the new lamp. Be sure to attach the new lamp securely.

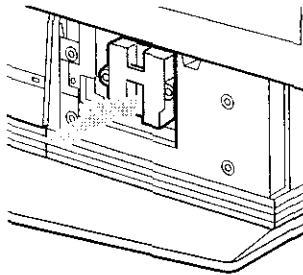

Mount the new lamp securely into the lamp receptacle.

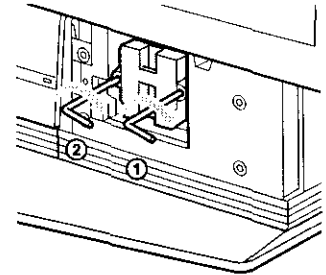

Tighten the two screws securely in the order of ① to ②, as shown in the illustration using the supplied hex key.

Mount the lamp cover and tighten the screw. Make sure that the lamp cover is mounted securely, otherwise the power will not turn on.

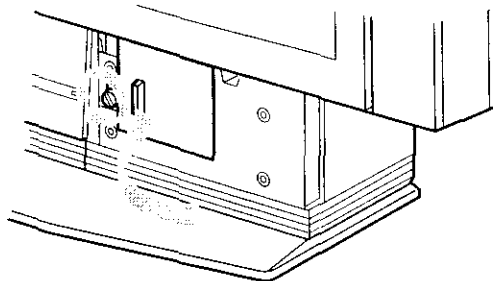

Match the projection of the right side of the lamp cover with the hole of the unit, and replace the lamp cover as it was.

If the lamp cover is not mounted securely, the self-diagnostic function works and the STAND BY indicator flashes for three times (See page 90).

(Continued)

- Mount the front panel in the order of ① to ②, as shown in the illustration.

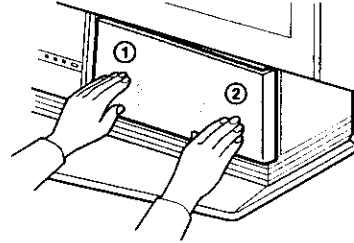

- ✎ Consult your Sony dealer for a Sony XL-2000U replacement lamp.
- ✎ Take great care when replacing the lamp or plugging in/unplugging the connecting cords. If you handle them roughly, the LCD projection TV may fall or be moved, and the TV stand or floor surfaces may be scratched.

The box contains your new LCD projection TV, a remote control and two AAA batteries. No peripheral cables are included. If you intend to add additional equipment to your LCD projection TV, please check the hookup instructions for your desired setup before you begin. You may need to purchase cables and/or splitters to complete the hookup properly.

Inserting Batteries into the Remote Control

Insert two size AAA batteries (supplied) by matching the + and – on the batteries to the diagram inside the battery compartment.

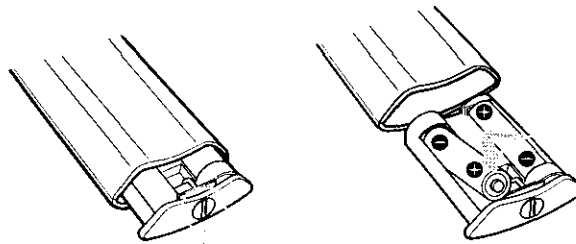

Coin Lock

- ✎ Remove the batteries to avoid damage from possible battery leakage whenever you anticipate that the remote control will not be used for an extended period.
- ✎ Handle the remote control with care. Avoid dropping it, getting it wet, or placing it in direct sunlight, near a heater, or where the humidity is high.
- ✎ Your remote control can be programmed to operate most video equipment. (See “Programming the Remote Control” on page 82.)

Carrying your LCD Projection TV

Carrying the LCD projection TV requires at least two people. Do not grasp the pedestal or the front panel of the LCD projection TV, otherwise these parts might break off.

When moving the LCD projection TV, support the screen bottom with one hand while grasping the top part with the other hand, as shown in the illustration below.

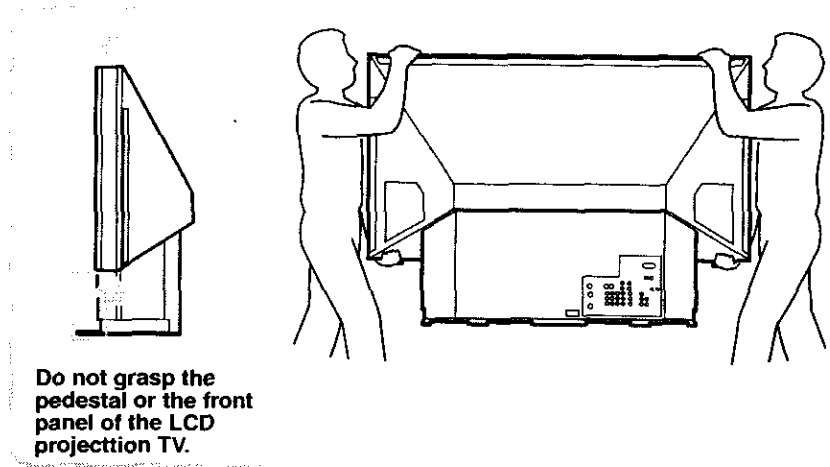

Pay special attention to children around the LCD projection TV. If children should climb onto or push the LCD projection TV or its stand, it may fall down.

As a protective measure, secure the LCD projection TV as follows.

Using the LCD projection TV stand with support belts

- 1 Mount the two brackets with the screws (supplied) to the upper rear sides of the LCD projection TV (left and right sides).
- 2 Pass a strong cord or chain (not supplied) through each bracket and then secure it to a wall or a pillar, etc.

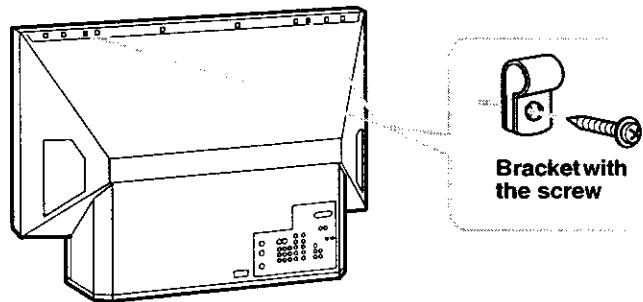

Using the LCD projection TV stand with support belts

- 2 You can also use the LCD projection TV stand SU-GW1 (not supplied) with support belts.

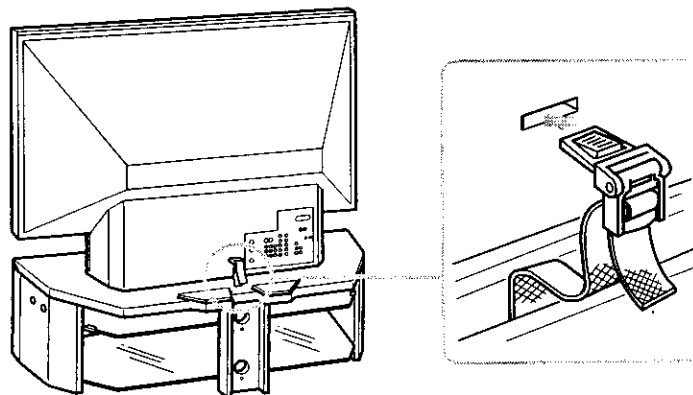

After Installation: Your LCD Projection TV Against a Wall

Keep your LCD projection TV at least 10 cm (4 inches) from the wall.

The picture quality may be affected by your viewing position.

For the best picture quality, install your LCD projection TV within the areas shown below.

Sit at least 1.8 m (approx. 6 ft.) for KF-50XBR800 or 2.2 m (approx. 7 ft.) for KF-60XBR800 away from your LCD projection TV, and within 60° of the vertical viewing area, and 130° of the horizontal viewing area.

Horizontal Viewing Area

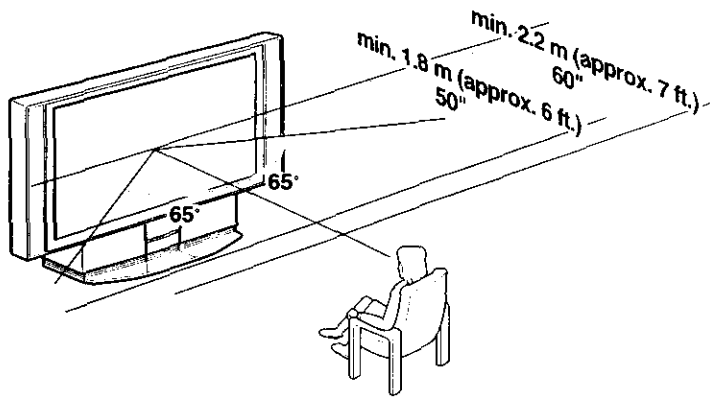

Vertical Viewing Area

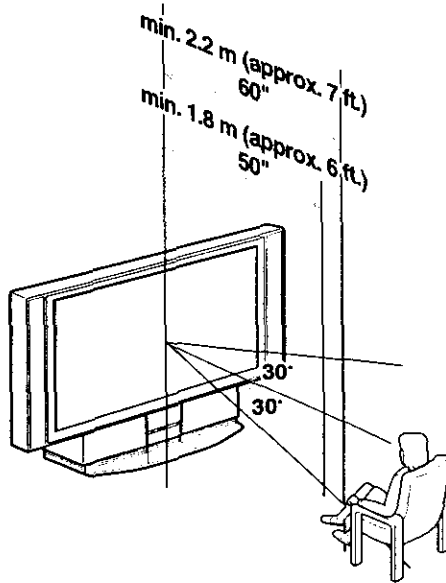

Front Panel Menu Controls

The front panel menu controls allow access to the on-screen menus without the use of a remote control. Pressing MENU brings up the on-screen menus. The arrow buttons move the on-screen cursor in the menus and by pressing the  button selects the menu item.

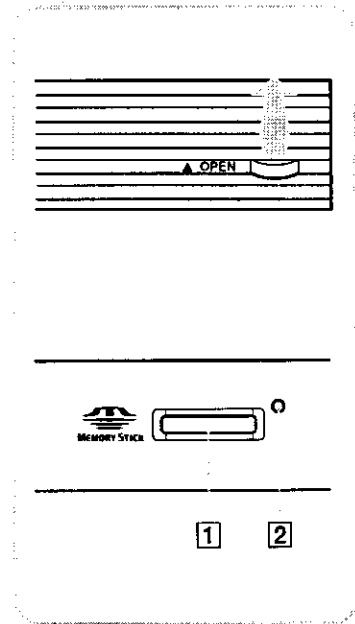
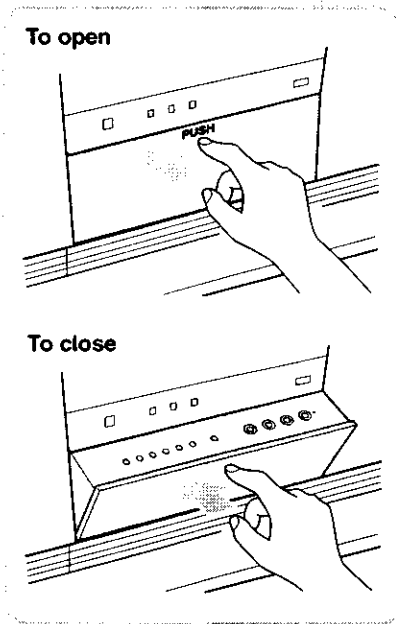
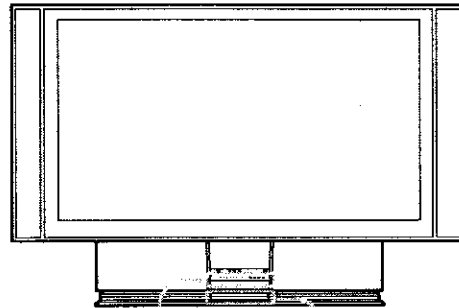
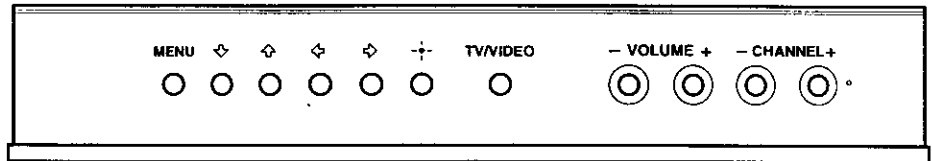

(Continued)

- 1 MEMORY STICK Memory Stick insertion slot. For details, see “Inserting and Removing a Memory Stick” on page 60.
- 2 MEMORY STICK ACCESS LED When lit, indicates that the Memory Stick is being read. (Do not remove the Memory Stick when the indicator is lit.)

**LCD Projection TV
Rear and Side Panel
Connectors**

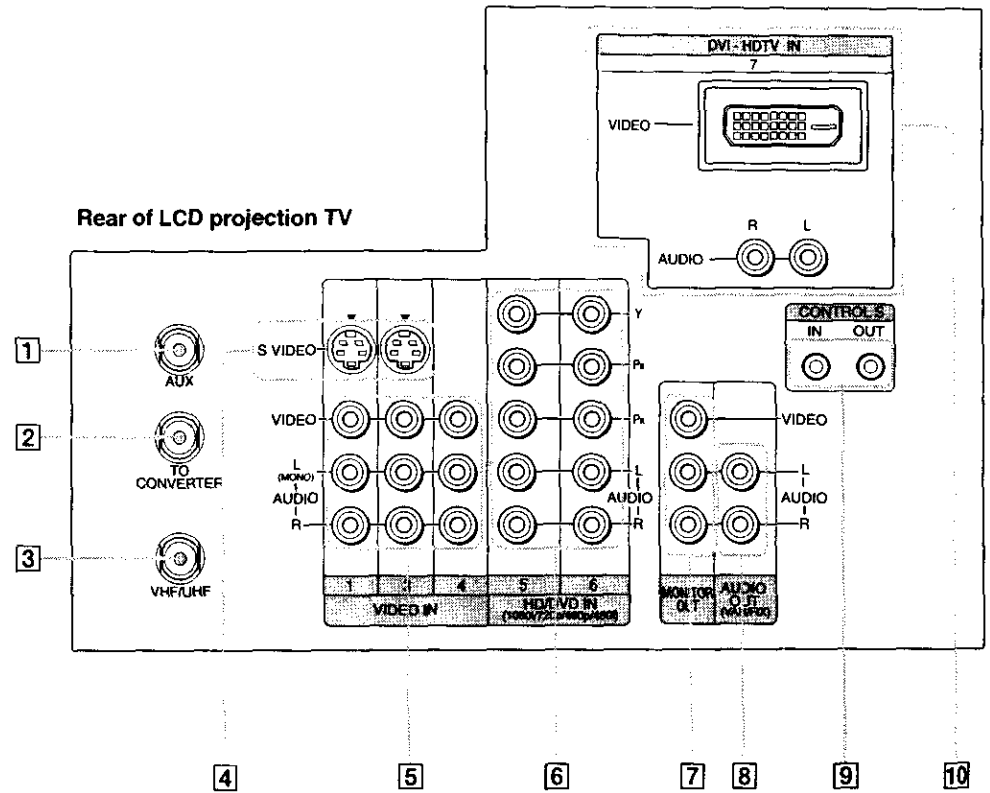

Left side of LCD projection TV

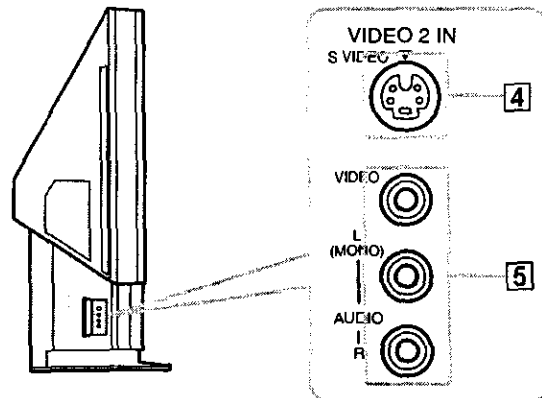

- 1** **AUX** Allows you to view local and cable channels if your cable provider does not feature local channels. You can switch between local and cable channels easily by pressing **ANT** on the remote control. Devices connected to the **AUX** input cannot be viewed in **Twin View**.
- 2** **TO CONVERTER** This is a **VHF/UHF OUT** jack that lets you set up your LCD projection TV to switch between scrambled channels (through a cable box) and normal cable channels (**CATV**). Use this jack instead of a splitter to get better picture quality when switching between scrambled and unscrambled cable channels.
- 3** **VHF/UHF (Primary RF input)** Connects to your **VHF/UHF** antenna or cable.
- 4** **S VIDEO (Rear and side)** Connects to the **S VIDEO OUT** jack of your **VCR** or other **S VIDEO**-equipped video component. Provides better picture quality than the **VHF/UHF** jacks or the **Video IN** jack.
- 5** **VIDEO/ (L/R) AUDIO (Rear and side)** Connects to the audio and video **OUT** jacks on your **VCR** or other video component. A fourth video input (**VIDEO 2**) is located on the side panel of the LCD projection TV.
- 6** **HD/DVD IN (1080i, 720p, 480p, 480i)** Connects to your **DVD** player's or **Digital Set-top box's** component video (**Y, PB, PR**) and audio (**L/R**) jacks.
- 7** **MONITOR OUT** Lets you record the program you are watching to a **VCR**. When two **VCRs** are connected, you can use the TV as a monitor for tape-to-tape editing (not available with **480p, 720p, or 1080i** when the input is set to **VIDEO 5-7**).
- 8** **AUDIO OUT (VAR/FIX) L (MONO)/R** Connects to the left and right audio inputs of your audio or video component.
- 9** **CONTROL S IN/OUT** To control other Sony equipment with the LCD projection TV's remote control, connect the **CONTROL S IN** jack of the equipment to the **CONTROL S OUT** jack on the LCD projection TV with the **CONTROL S** cable.
To control the LCD projection TV with a remote control for another Sony product, connect the **CONTROL S OUT** jack of the equipment to the **CONTROL S IN** jack on the LCD projection TV with the **CONTROL S** cable.
- 10** **DVI-HDTV VIDEO AUDIO R/L (VIDEO 7 IN)** Can accommodate a copy-protected digital connection (**HDCP***) to other devices (such as digital set-top boxes) that have compatible interfaces. The **DVI-HDTV** input terminal is compliant with the **EIA-861** standard and is not intended for use with personal computers. See the instruction manual that came with your equipment for details about connecting and using it with the LCD projection TV.

* High-bandwidth Digital Content Protection

You may find it necessary to use some of the following connector types during set up.

TV CABLE

Standard TV cable and antenna cable

Plug Type



Screw-on Type



VIDEO CABLE

High quality video cable for enhanced picture quality



VIDEO CABLE



Video - Yellow

Audio (Left) - White

Audio (Right) - Red

Some DVD Players are equipped with the following three video connectors:

Y - Green

P_B (C_B, C_b or B-Y) - Blue



P_R (C_R, C_r or R-Y) - Red

CONTROL S CABLE

CONTROL S connections are exclusive to Sony products and allow greater control of all Sony equipment.



Connecting Directly to Cable or an Antenna

The connection you choose depends on the cable found in your home. Newer homes are equipped with standard coaxial cable (see ); older homes probably have 300-ohm twin lead cable (see ); other homes may contain both (see ).

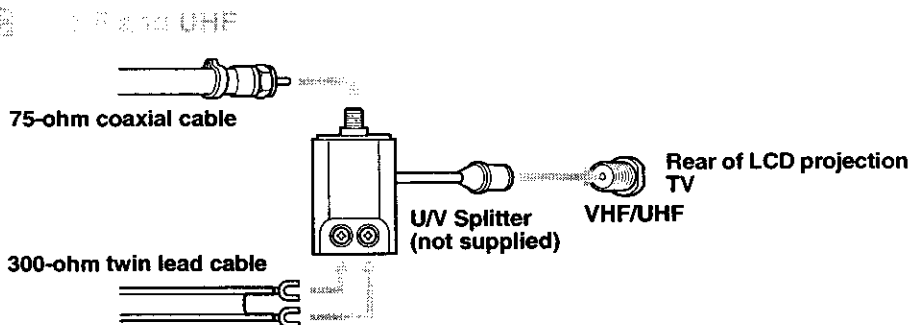
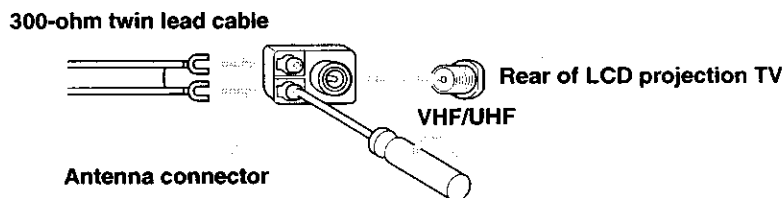
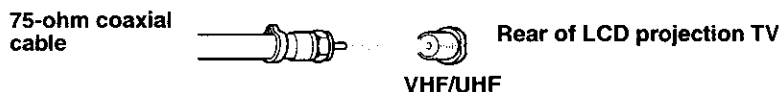

 It is highly recommended to connect the antenna using a 75-ohm coaxial cable to get optimum picture quality. A 300-ohm twin lead cable can be easily affected by radio noise and the like, resulting in signal deterioration. If you use a 300-ohm twin lead cable, keep it away as far as possible from the LCD projection TV.

 Do not use an indoor antenna because it is especially susceptible to radio noise.

Cable and Antenna

If your cable provider does not feature local channels, you may find this set up convenient.

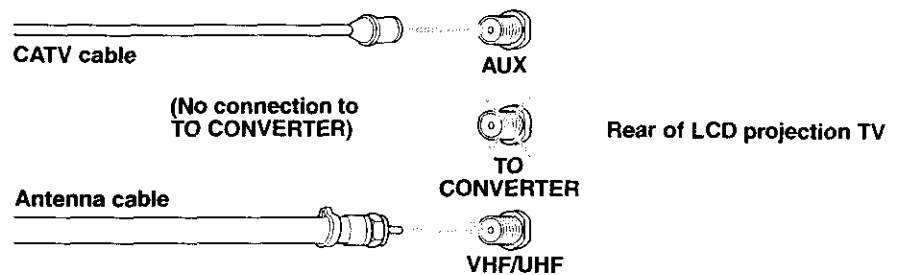

Select CABLE or antenna (ANT) mode by pressing ANT on the remote control.

- To receive channels with an antenna, you need to turn your Cable to OFF (see page 73) and perform the Auto Program function (see page 73).

Cable Box Connections

Cable Box and Cable

This is the preferred basic cable TV hookup to use if:

- ❑ Your cable TV company scrambles some channels, but not all of them (pay channels vs. regular cable channels) and you need to use a cable box, and
- ❑ You want to enjoy the Twin View feature.

With this setup you can:

- ❑ Use the LCD projection TV remote control to change channels using your cable box when the signal is scrambled.
- ❑ Use the LCD projection TV remote control to change channels using your LCD projection TV when the signal is not scrambled. (Your LCD projection TV's tuner provides a better signal than the cable box.)
- ❑ Use the Twin View feature. (When all channels are routed through your cable box, only one channel is sent to the LCD projection TV, so you can not use the Twin View or Channel Index features for your cable box.)
- Connect the Cable TV cable to the LCD projection TV's VHF/UHF jack.
- Using a coaxial cable, connect the LCD projection TV's TO CONVERTER jack to the cable box's IN jack. The LCD projection TV's internal converter allows you to switch between unscrambled signals coming straight into the LCD projection TV and scrambled signals coming in through the cable box, eliminating the need for an external splitter.

Using a coaxial cable, connect the cable box's OUT jack to the LCD projection TV's AUX jack.

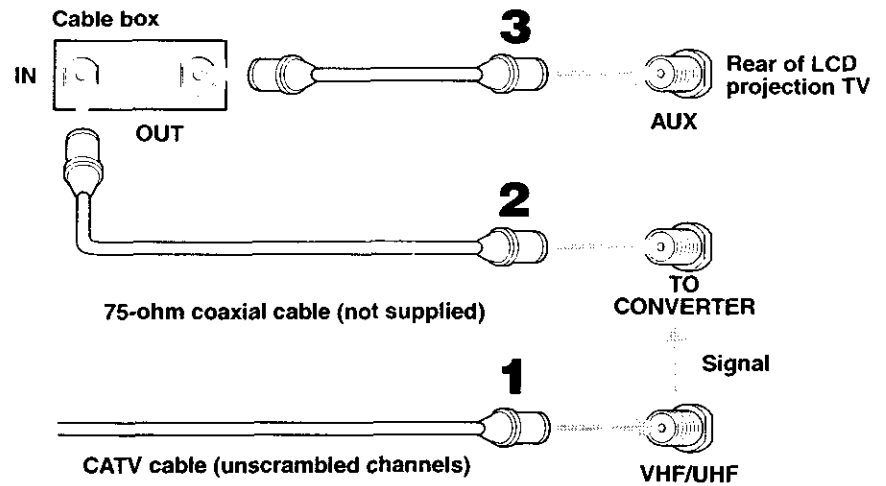

Pressing ANT on the remote control switches between the channels coming in through the cable box (scrambled) and those coming directly to the TV (unscrambled).

Use this hookup if:

- You subscribe to a cable TV system that uses scrambled or encoded signals requiring a cable box to view all channels, and
- You do not intend to hook up any other audio or video equipment to your LCD projection TV.

When all channels are routed through your cable box, only one unscrambled channel is sent to the LCD projection TV, so you cannot use the Twin View feature. If some channels are scrambled, but others are not, consider using the hookup on page 26 instead.

- Connect the coaxial connector from your cable service to the cable box's IN jack.
- Using a coaxial cable, connect the cable box's OUT jack to the LCD projection TV's VHF/UHF jack.

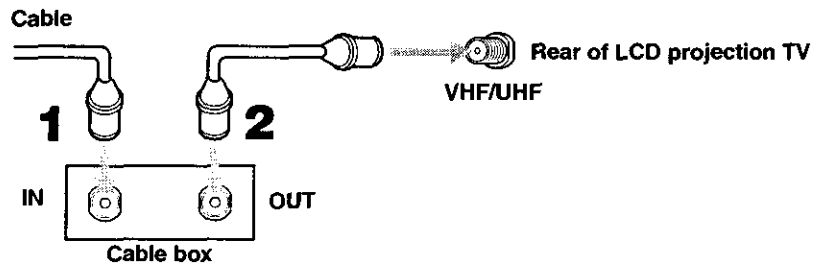

Also, set Cable to ON in the Channel menu (see page 73).

- Your Sony remote control can be programmed to operate your cable box (see "Programming the Remote Control" on page 82).
- To change channels using the cable box, set your LCD projection TV to channel 3 or 4 depending on the cable box channel output. If you will be controlling all channel selection through your cable box, consider using the Channel Fix feature to set your LCD projection TV to channel 3 or 4 (see page 73).
- Setting the Channel Fix feature in the Channel menu (see "Using the Channel Menu" on page 73), ensures that you do not accidentally switch the channels using your LCD projection TV.

Use this hookup if:

- 1 You have cable TV that does not require a cable box.
- 2 Connect the cable TV cable to the VCR's IN jack.
- 3 Using a coaxial cable, connect the VCR's OUT jack to the LCD projection TV's VHF/UHF jack.
- 4 Using AUDIO and S VIDEO cables, connect the VCR's Audio and S Video OUT jacks to the LCD projection TV's AUDIO and S VIDEO IN jacks.

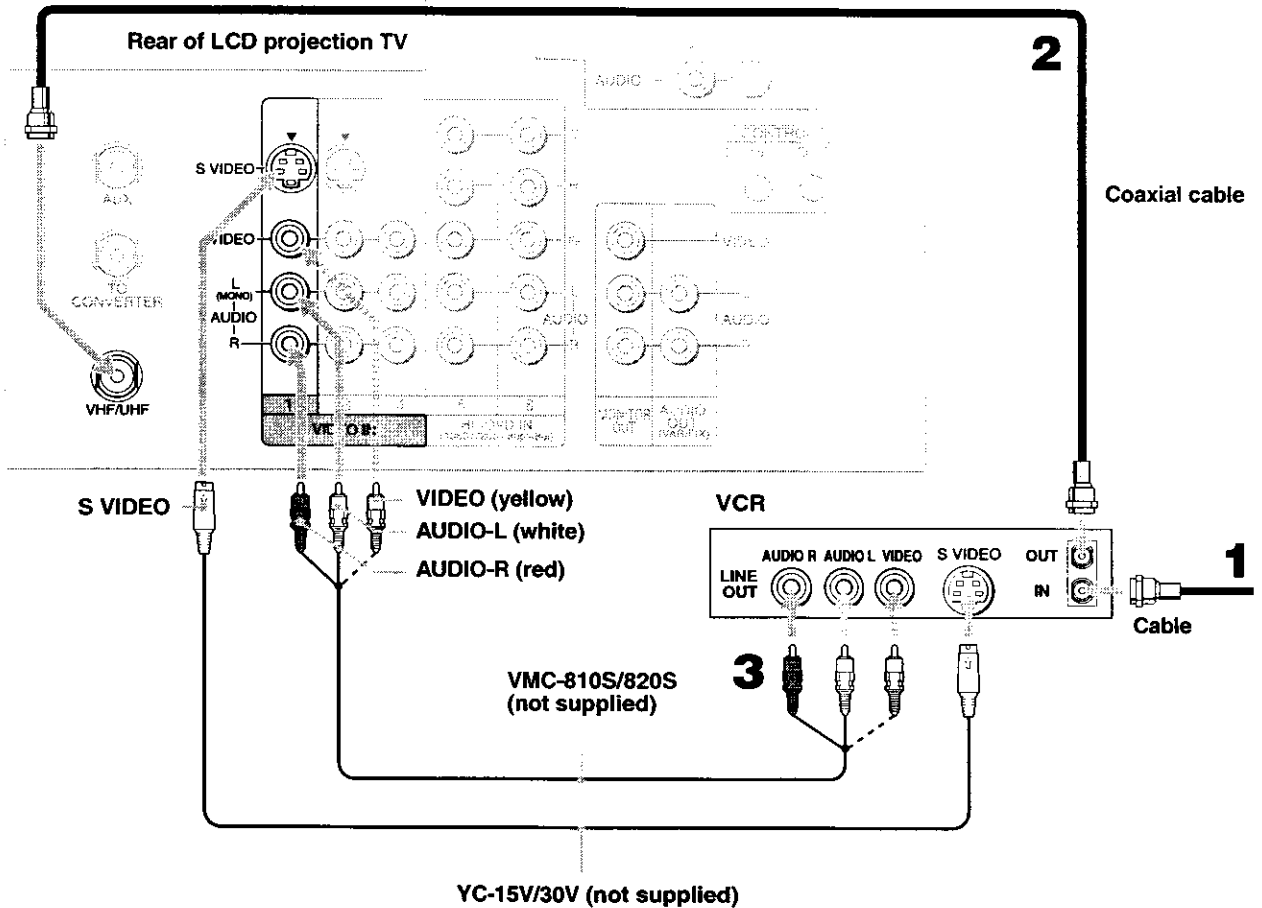

⚠ If your VCR is not equipped with S VIDEO, use a VIDEO cable (yellow) instead of the S VIDEO cable.

Connecting a Cable Box to the LCD Projection TV

Use this hookup if:

Your cable TV company scrambles some channels, but not all of them (pay channels vs. regular cable channels) and you need to use a cable box, and

You want to enjoy the Twin View feature.

With this setup you can:

Use the LCD projection TV remote control to change channels on your cable box when the signal is scrambled. To program your Sony remote control to operate your cable box, see “Programming the Remote Control” on page 82.

Use the LCD projection TV remote control to change channels using your LCD projection TV when the signal is not scrambled. Your LCD projection TV’s tuner provides a better signal than the cable box.

Use the Twin View feature. (When all channels are routed through your cable box, only one signal is sent to the LCD projection TV, so you cannot use the Twin View feature.)

Follow these steps to connect a cable box to the LCD projection TV.

- 1 Connect the Cable TV cable to the LCD projection TV’s VHF/UHF jack.
 - 2 Using a coaxial cable, connect the LCD projection TV’s TO CONVERTER jack to the cable box’s IN jack. The LCD projection TV’s internal converter allows you to switch between unscrambled signals coming straight into the LCD projection TV and scrambled signals coming in through the cable box, eliminating the need for an external splitter.
 - 3 Using a coaxial cable, connect the cable box’s OUT jack to the VCR’s IN jack.
 - 4 Using AUDIO and S VIDEO cables, connect the VCR’s AUDIO and S VIDEO OUT jacks to the LCD projection TV’s AUDIO and S VIDEO IN jacks.
 - 5 Using a coaxial cable, connect the VCR’s OUT jack to the LCD projection TV’s AUX jack.
-  To view scrambled channels, set your LCD projection TV to AUX 3 or 4 (depending on your cable box output). Change channels using your cable box.

VMC-810S/820S
(not supplied)

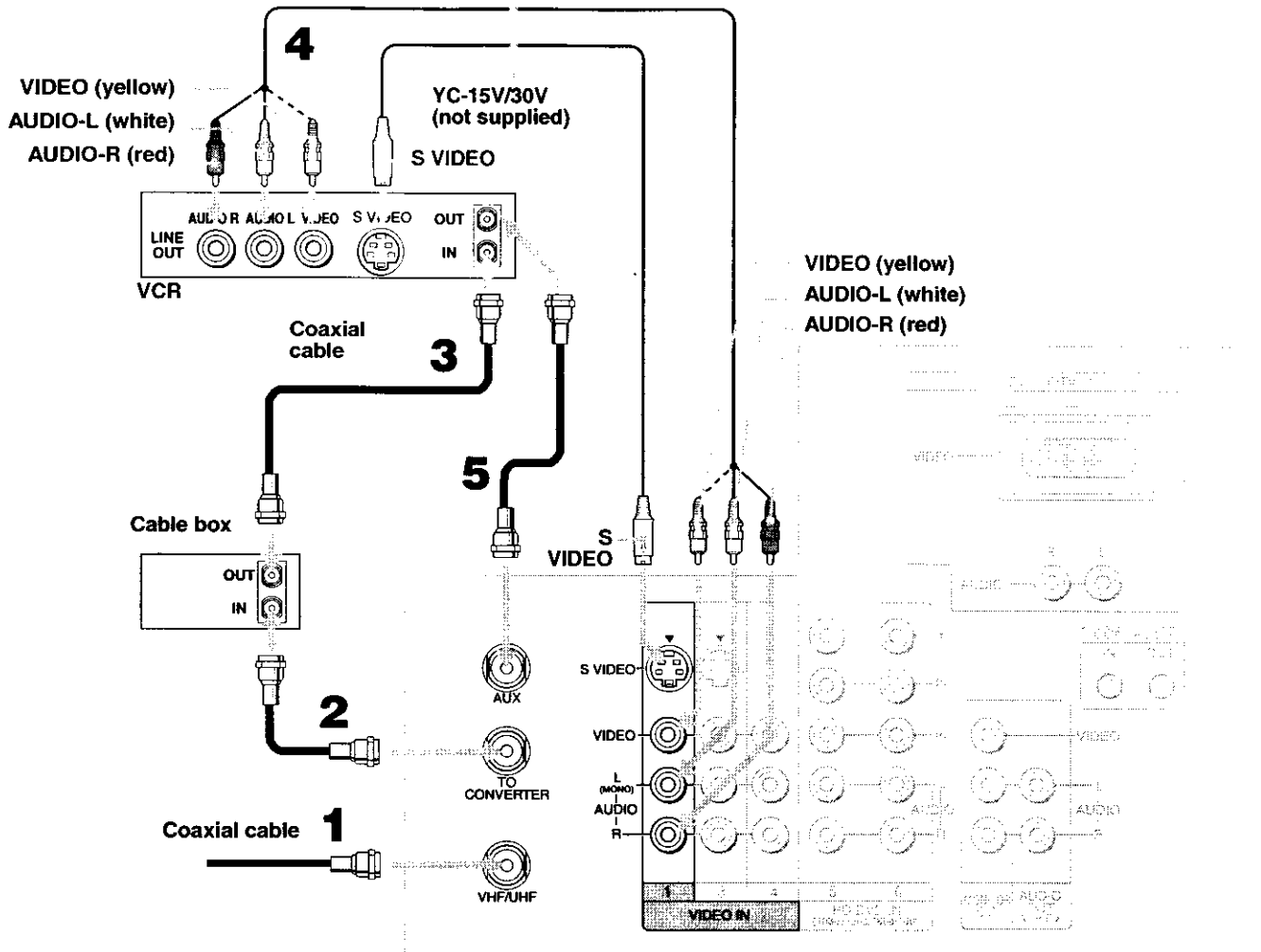

Rear of LCD projection TV

- ☞ If your VCR is not equipped with S VIDEO, use a VIDEO cable (yellow) instead of the S VIDEO cable.
- ☞ You will not be able to change channels on the VCR. Set your LCD projection TV and VCR to channel 3 or 4, depending on your cable box channel output.
- ☞ Pressing ANT on the remote control switches between the channels coming in through the cable box (scrambled) and those coming directly to the LCD projection TV (unscrambled).

If you connect two VCRs, you can record from one VCR to the other while using your LCD projection TV to monitor what is being recorded.

Connect the VCRs and LCD projection TV as follows:

- Using AUDIO and VIDEO cables, connect the playback VCR's Audio and Video OUT jacks to the recording VCR's Audio and Video IN jacks.
- Using AUDIO and VIDEO cables, connect the recording VCR's AUDIO and Video OUT jacks to the LCD projection TV's AUDIO and VIDEO IN jacks.

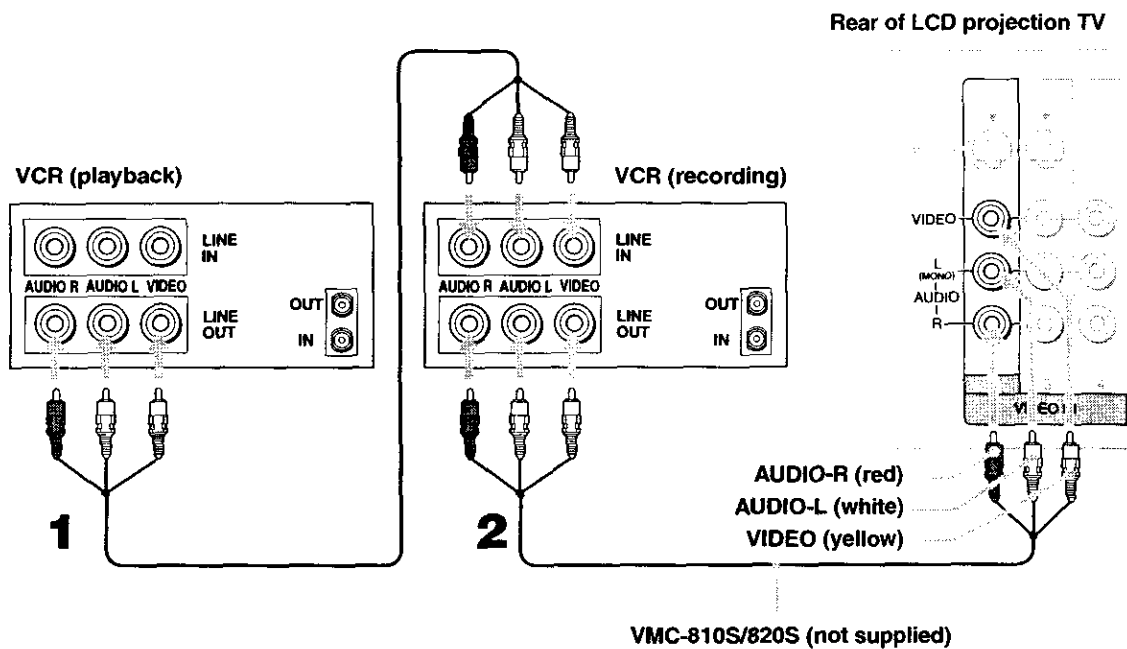

- To perform tape editing, set the LCD projection TV to the video input intended for playback by pressing TV/VIDEO on the remote control.
- You may need to change the video input on your VCR. Consult your VCR's operating manual for instructions.
- If your VCRs have an S VIDEO jack: For best picture quality, use an S VIDEO connection instead of the yellow video cable on your combined A/V cable.
Using an S VIDEO cable, connect the playback VCR's S VIDEO OUT jack to the recording VCR's S VIDEO IN jack. S VIDEO does not provide audio, so audio cables must be connected to provide sound.
- You cannot record signals from equipment connected to the Y, P_B, P_R input.

Connect the satellite antenna cable to the satellite receiver's SATELLITE IN jack.

Using AUDIO and S VIDEO cables, connect the satellite receiver's AUDIO and S VIDEO OUT jacks to the LCD projection TV's AUDIO and S VIDEO IN jacks.

Connect a coaxial cable from your cable or antenna to the LCD projection TV's VHF/UHF jack.

 If your satellite receiver is not equipped with S VIDEO, use a VIDEO cable (yellow) instead of the S VIDEO cable.

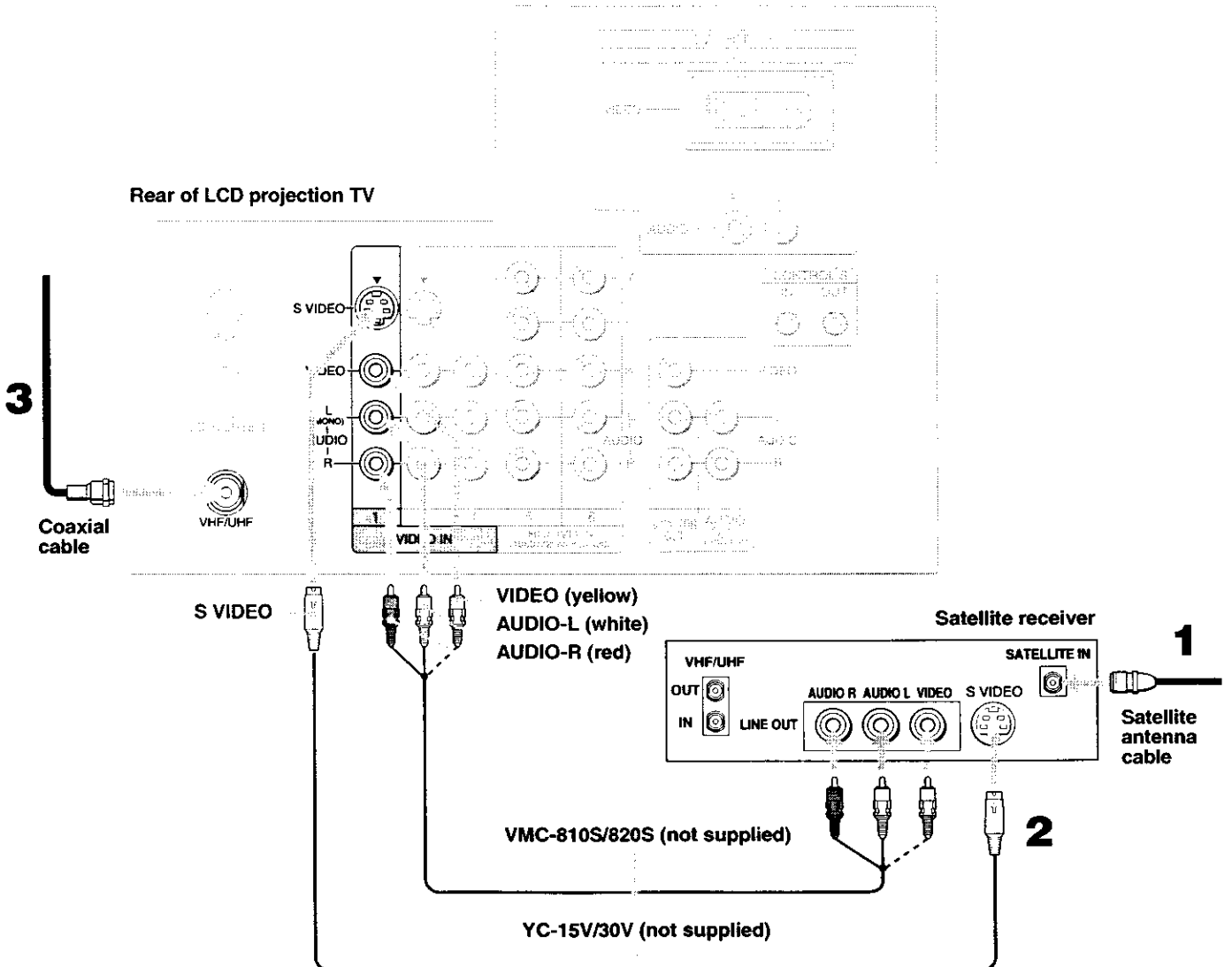

Connect the satellite antenna cable to the satellite receiver's SATELLITE IN jack.

Connect the CATV cable to the VCR's VHF/UHF IN jack.

Using a coaxial cable, connect the VCR's OUT jack to the LCD projection TV's VHF/UHF jack.

Using AUDIO and S VIDEO cables, connect the satellite receiver's AUDIO and S VIDEO OUT jacks to the VCR's AUDIO and S VIDEO IN jacks.

Using AUDIO and S VIDEO cables, connect the VCR's AUDIO and S VIDEO OUT jacks to the LCD projection TV's AUDIO and S VIDEO IN jacks.

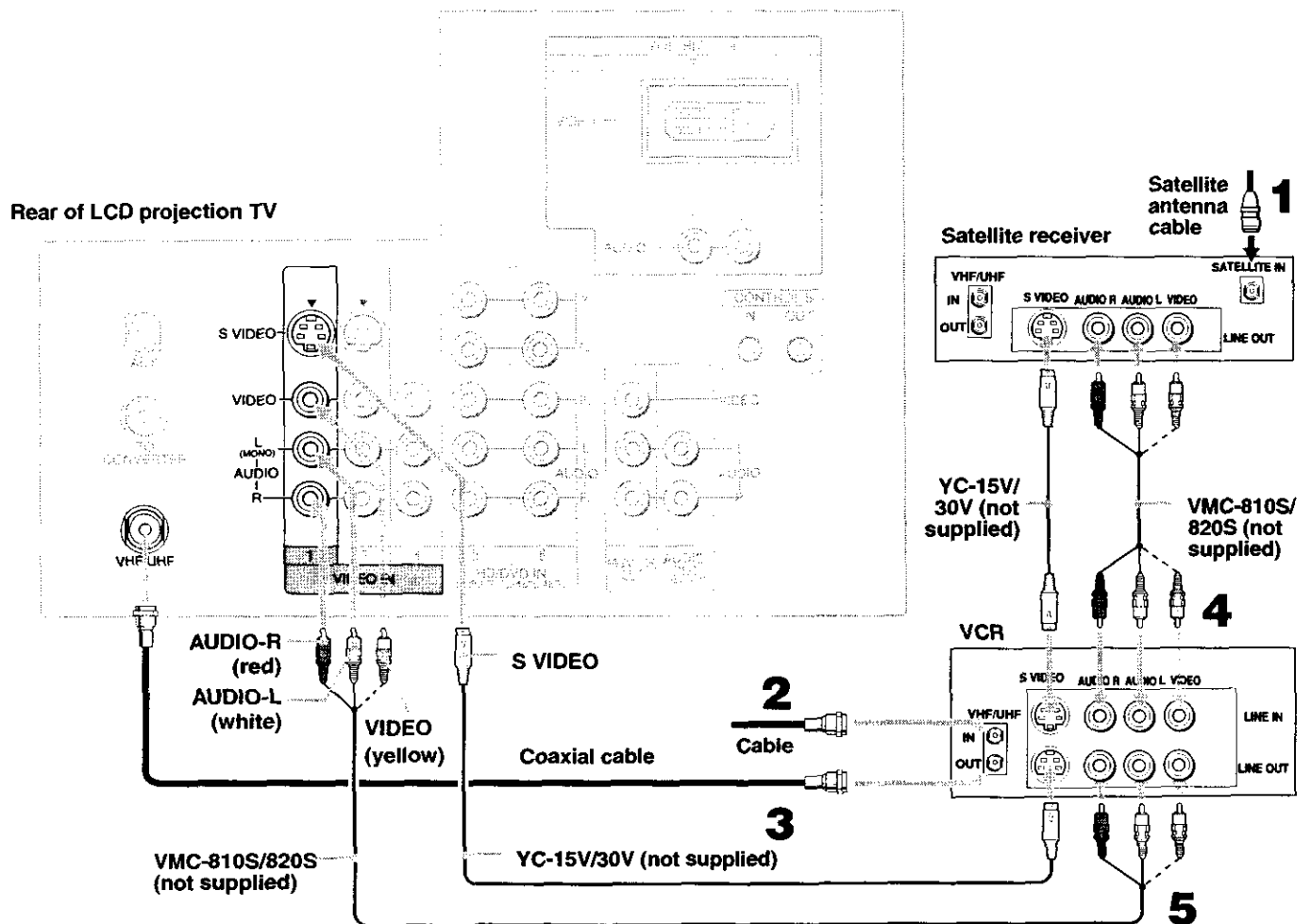

- ✎ Be sure your VCR's video input is set correctly. Consult your VCR's operating manual for instructions.
- ✎ Use TV/VIDEO to select
 - VIDEO 1 to watch satellite TV or the VCR (your VCR must be turned on).
 - VHF/UHF to watch cable TV.
- ✎ If your VCR or satellite receiver is not equipped with S VIDEO, use a VIDEO cable (yellow) instead of the S VIDEO cable.

Using audio cables, connect the LCD projection TV's AUDIO OUT (VAR/FIX) jacks to the audio receiver's audio LINE IN jacks.

Rear of LCD projection TV

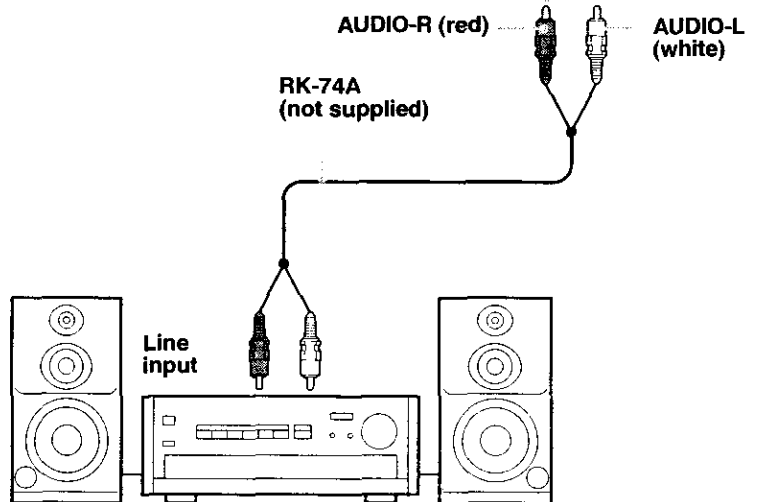
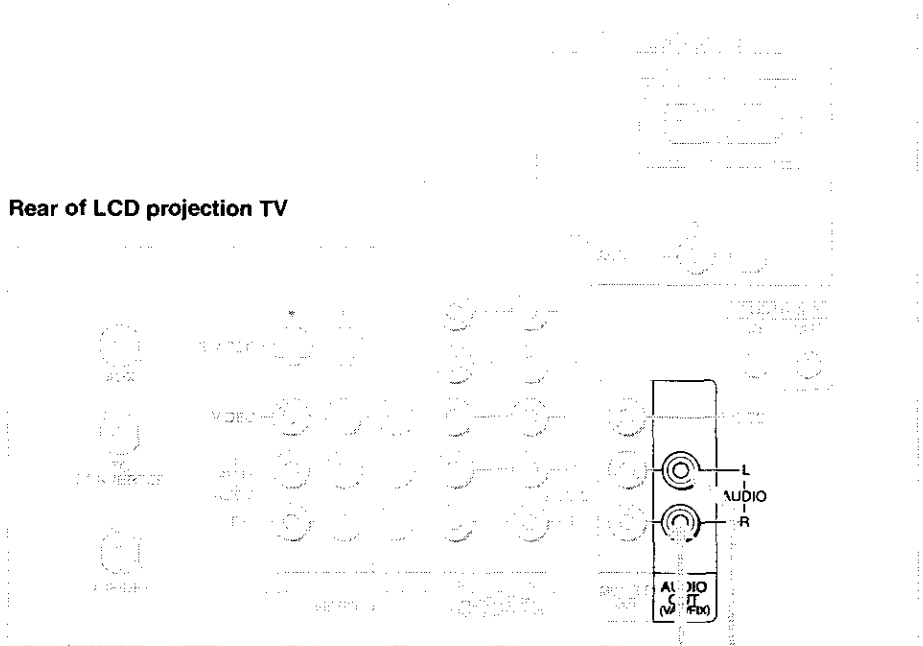

This is the preferred hookup to use if:

- Your DVD player has component (Y, B-Y, R-Y) jacks.

Using three separate component video cables, connect the DVD player's Y, B-Y and R-Y jacks to the Y, PB and PR jacks on the LCD projection TV. Use the HD/DVD IN 5 or 6 connections.

The Y, B-Y and R-Y jacks on your DVD player are sometimes labeled Y, CB and CR, or Y, PB and PR. If so, connect the cables to like colors.

Using an audio cable, connect the DVD player's Audio OUT jacks to the LCD projection TV's AUDIO IN jacks. Be sure to use the same row of inputs that you used for the video connection (HD/DVD IN 5 or 6).

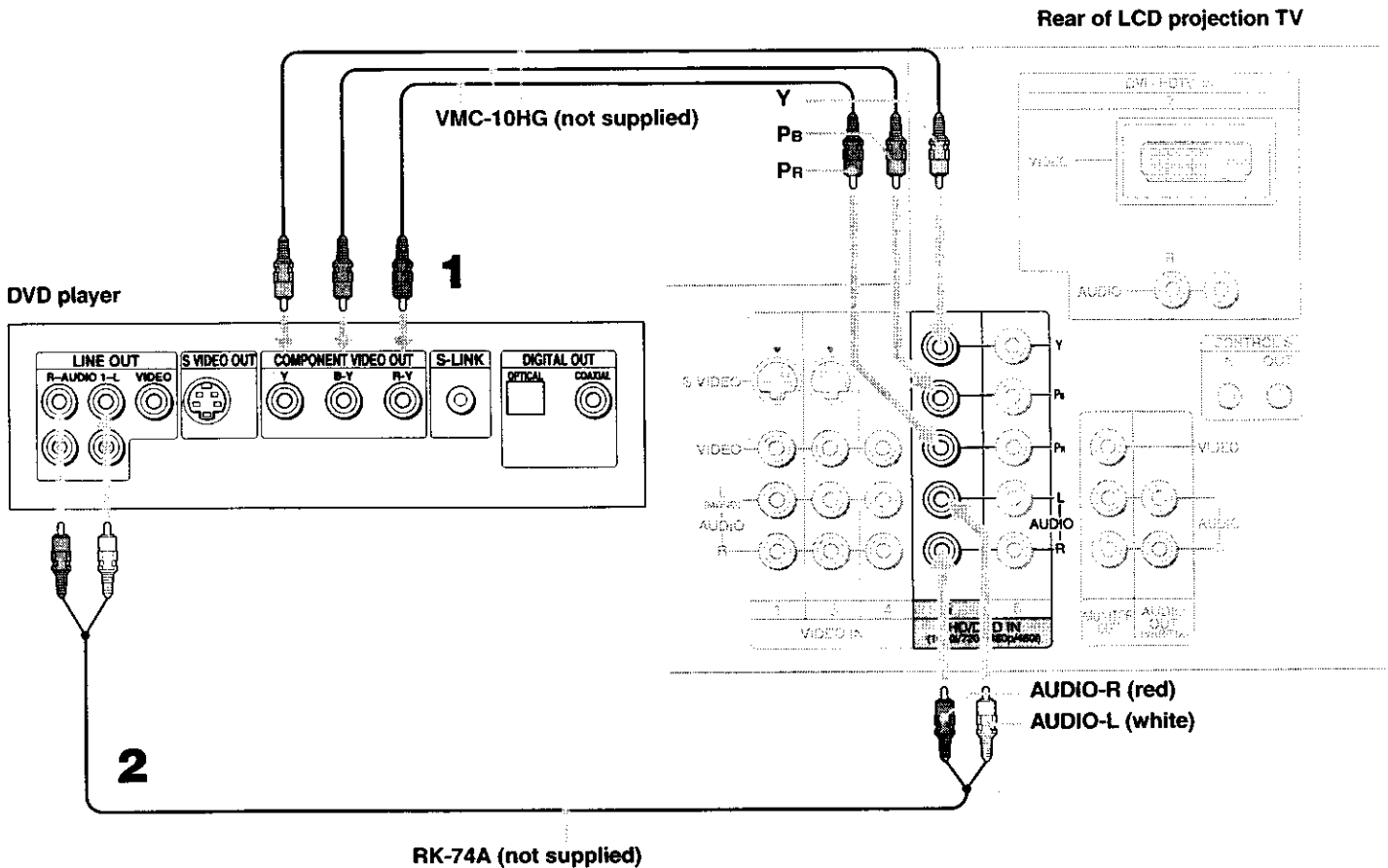

To take advantage of the Wide Screen modes, set the TV's aspect ratio to 16:9 on your DVD player. For details, refer to the operating instructions supplied with your DVD player.

Use this hookup if:

Your DVD player does not have component (Y, PB, PR) jacks.

- ✎ If your DVD player has video component output connectors: for best picture quality use the connection described on page 37.

Using audio cables, connect the DVD player's Audio OUT jacks to the LCD projection TV's AUDIO IN jacks.

Using an S VIDEO cable, connect the DVD player's S VIDEO jack to the LCD projection TV's S VIDEO jack.

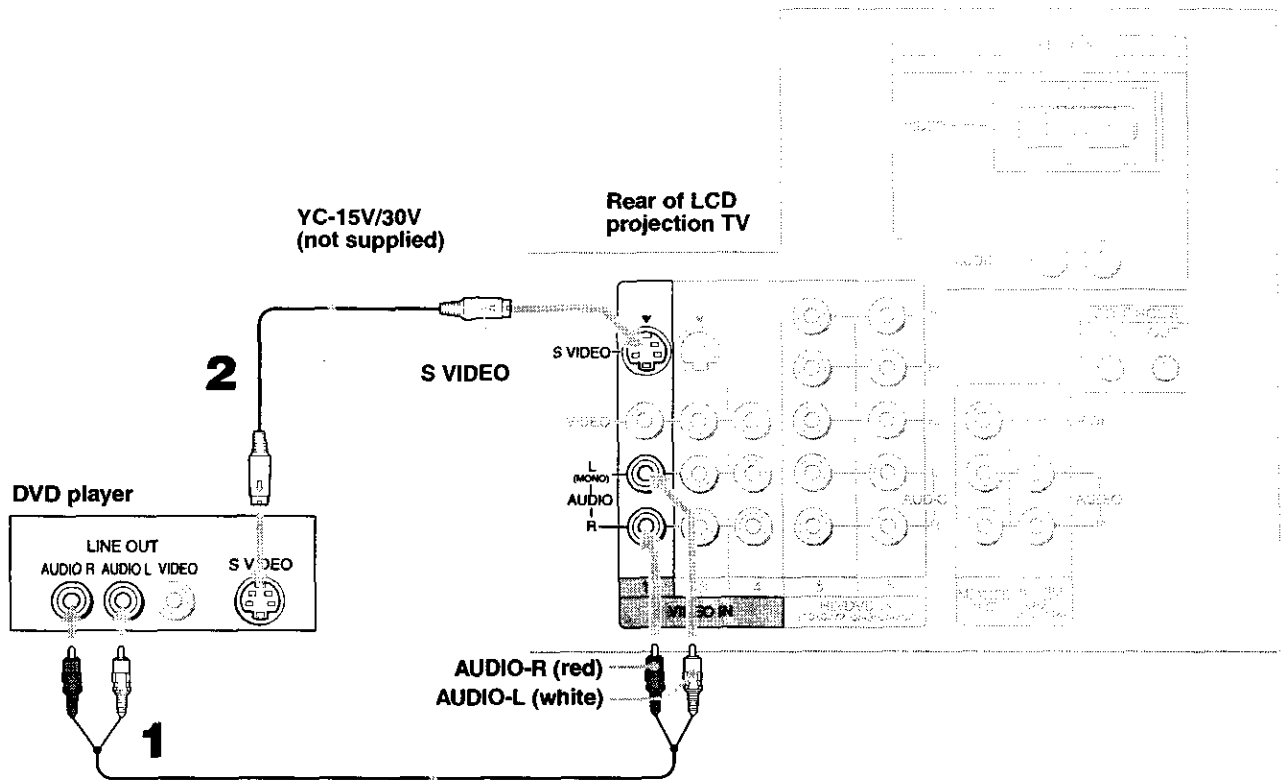

RK-74A (not supplied)

- ✎ To take advantage of the Wide Screen modes, set the TV's aspect ratio to 16:9 on your DVD player. For details, refer to the operating instructions supplied with your DVD player.
- ✎ Use TV/VIDEO on the remote control to switch between the VCR, DVD player and cable TV inputs.
- ✎ If your VCR is not equipped with S VIDEO, use a VIDEO cable (yellow) instead of the S VIDEO cable.

Be sure to read the Set-top box manual.

Using three separate component video cables, connect the Digital TV Set-top box's Y, P_B and P_R jacks to the LCD projection TV.

- ⚠ The Y, P_B and P_R jacks do not provide audio, so audio cables must be connected to provide sound.
- ⚠ Component video connection is necessary to view 480i, 480p, 720p, and 1080i formats. You may also use the S VIDEO or Composite Video connections, however, component video (Y, P_B, P_R) will provide the best picture quality for all format types.

Using an audio cable, connect the Digital TV Set-top box's Audio OUT jacks to the LCD projection TV's AUDIO IN jacks.

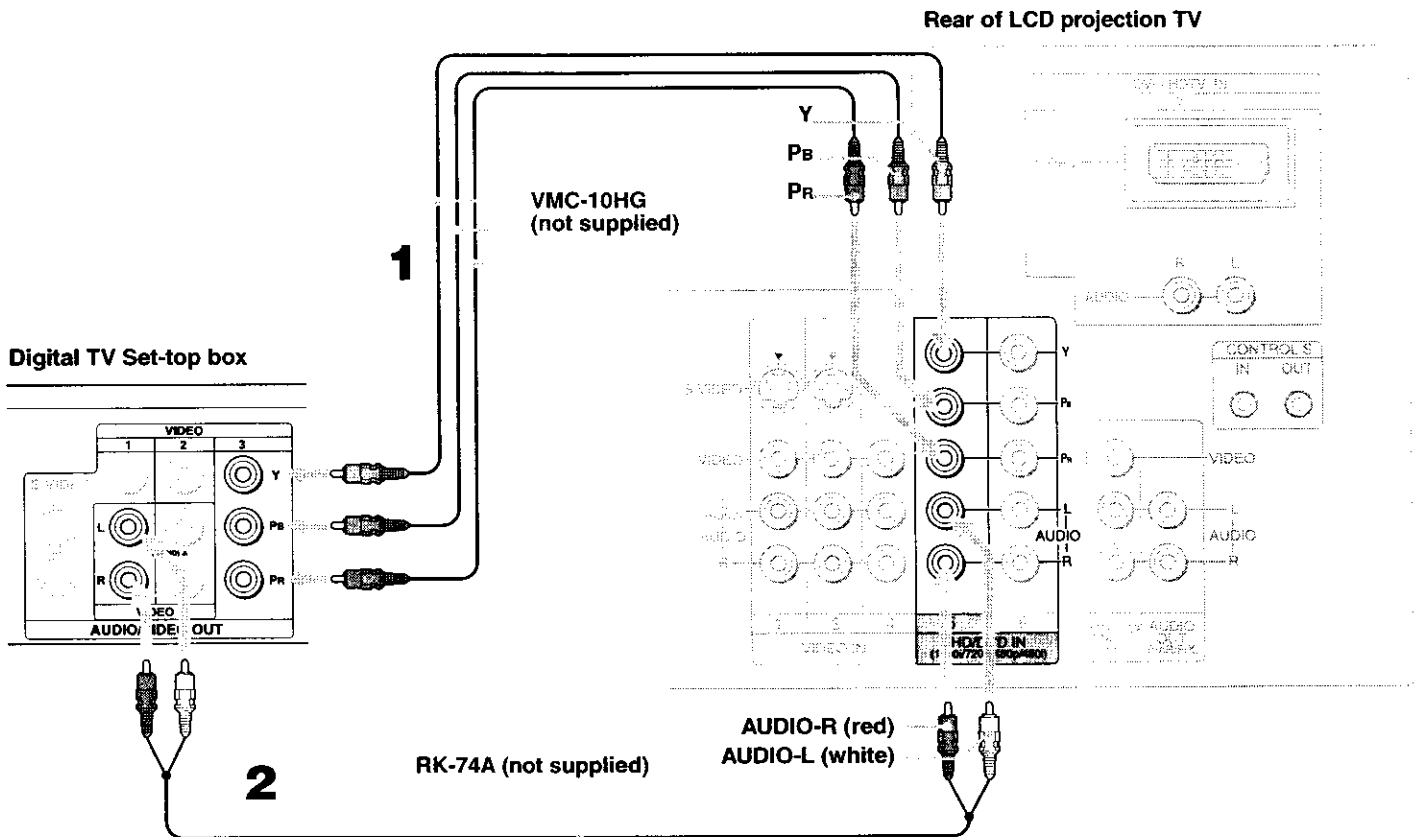

⚠ You cannot record the signal from any equipment connected into the Y, P_B and P_R connectors.

⚠ This LCD projection TV is not compatible with digital TV receivers configured with RGB or VGA output connectors.

Disconnect all power sources before making any connections.

Be sure to read the Set-top box manual.

Using a DVI-D single link cable, connect the Digital TV Set-top box's DVI-HDTV connector to the LCD projection TV.

⚠ The DVI-HDTV VIDEO connector does not provide audio, so audio cables must be connected to provide sound.

Using an audio cable, connect the Digital TV Set-top box's Audio OUT jacks to the LCD projection TV's DVI-HDTV AUDIO jacks.

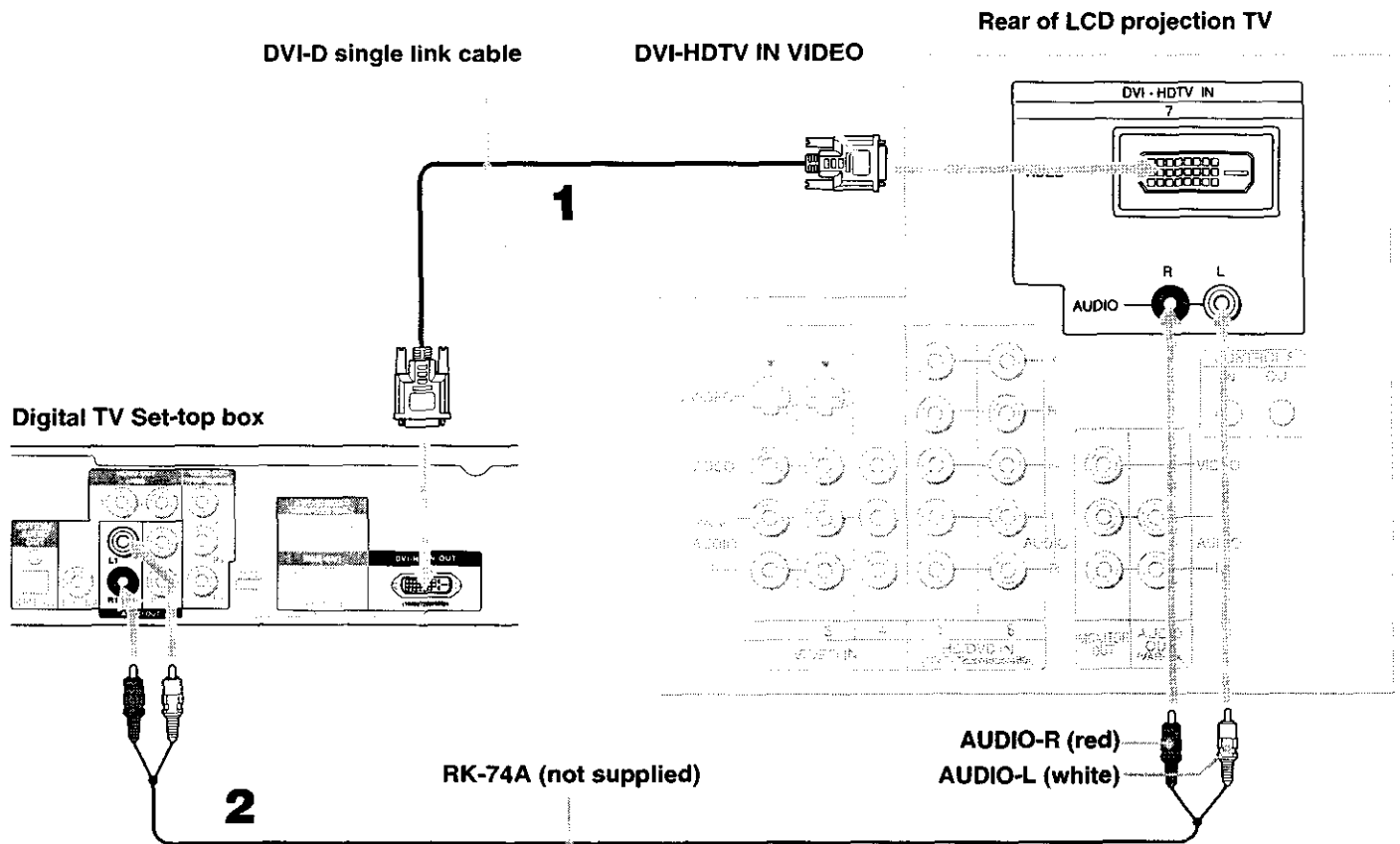

For easy connection of the camcorder, the LCD projection TV has side Audio and Video inputs (shown below). However, if you prefer, you can also connect the camcorder to the LCD projection TV's rear Audio and Video IN jacks.

Using AUDIO and S VIDEO cables, connect the camcorder's Audio and S VIDEO OUT jacks to the LCD projection TV's AUDIO and S VIDEO IN jacks.

- If you have a mono camcorder, connect its left audio output to the LCD projection TV's AUDIO L (MONO) jack.
- If your camcorder is not equipped with S VIDEO, use a VIDEO cable (yellow) instead of the S VIDEO cable.

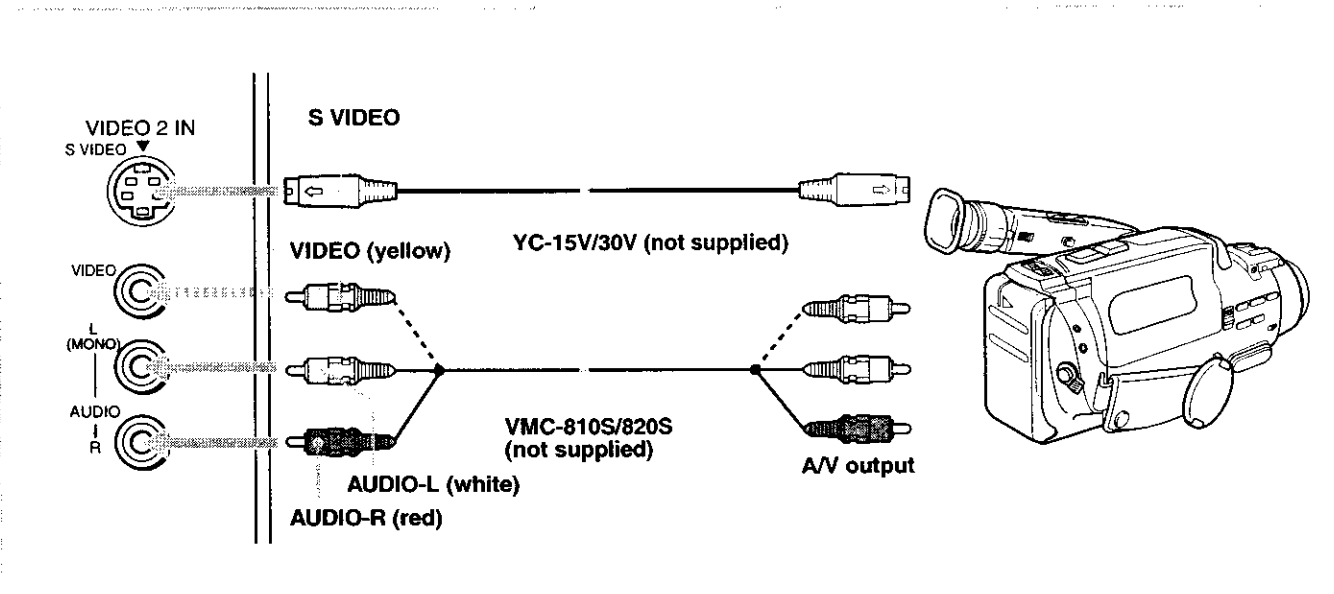

Connecting two VCRs lets you record from one VCR to the other. By connecting them as shown below, you can view (monitor) what is being recorded.

Using the AUDIO and VIDEO cable, connect the AUDIO and VIDEO IN jacks to the playback VCR's AUDIO and VIDEO OUT jacks.

Using the AUDIO and VIDEO cable, connect the MONITOR OUT jacks to the recording VCR's AUDIO and VIDEO IN jacks.

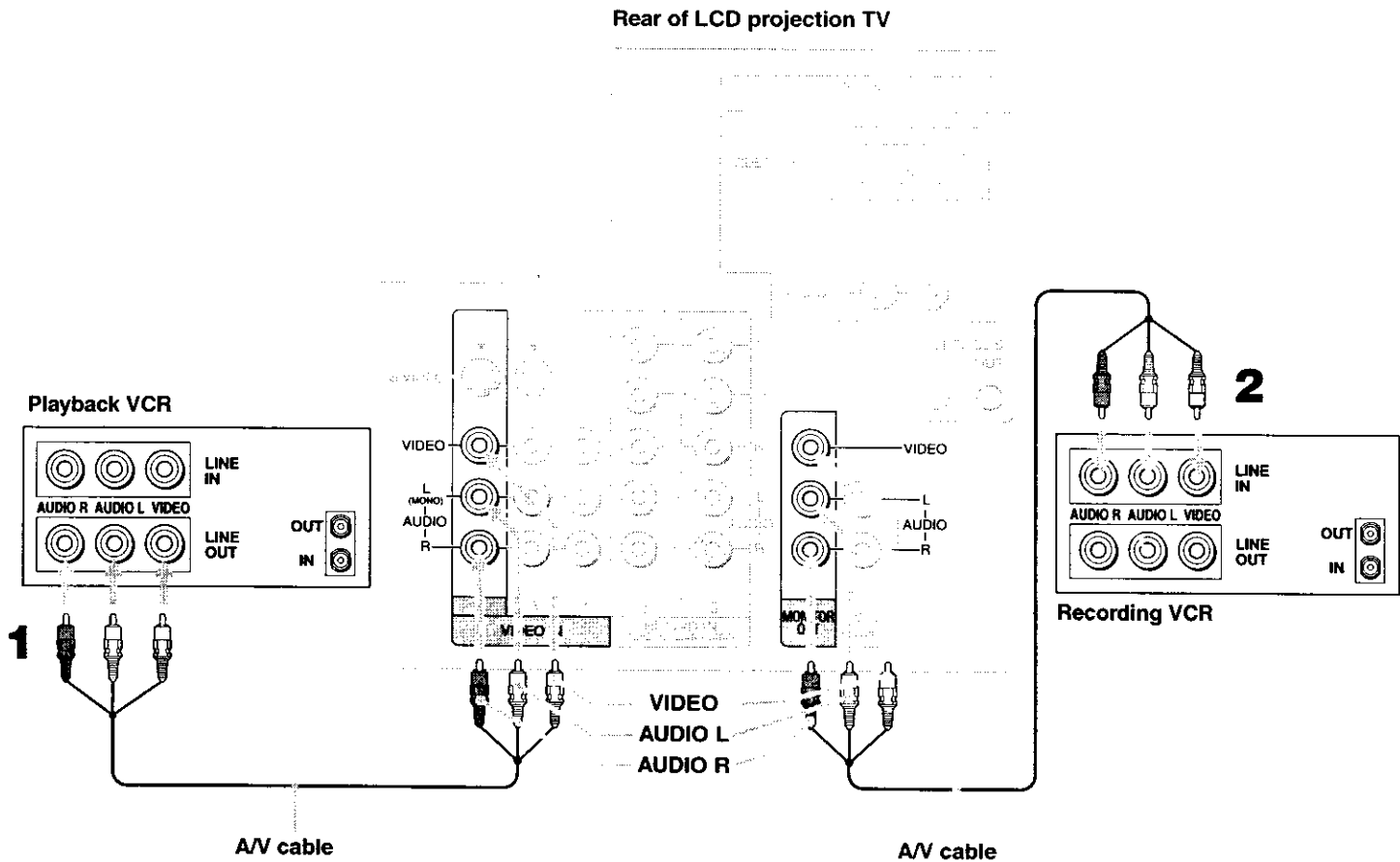

⚠ When the playback VCR is equipped with the S VIDEO OUT jack, connect the S VIDEO jack to the playback VCR's S VIDEO OUT jack.

CONTROL S allows you to control your LCD projection TV system and other Sony equipment with one remote control. In addition to allowing you to control multiple devices with one remote control, the CONTROL S feature allows you to always point your remote control at your LCD projection TV, instead of having to point it at the other equipment, which might be hidden or out of direct line of sight.

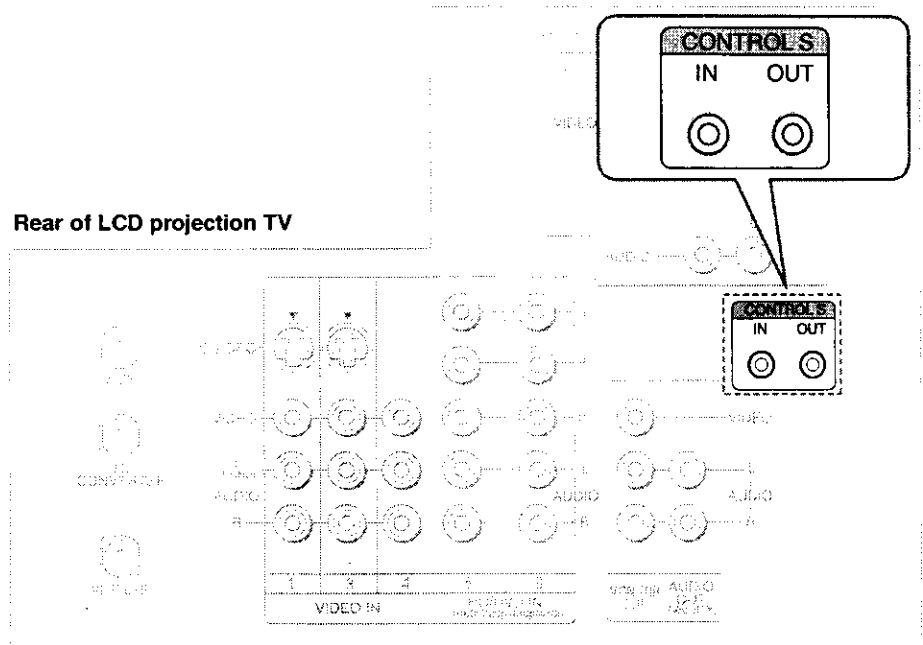

After you finish connecting your LCD projection TV, you can run Auto Setup to set up your channels. The Auto Setup screen appears when you turn your LCD projection TV on for the first time after installing it. If you do not want to set up the channels at this time, you can do it later by using the Auto Program feature in the Channel menu (see page 73).

 The Auto Setup feature does not apply for installations that use a cable box for all channel selection.

Using Auto Setup

- 1 Press POWER on the front panel of your LCD projection TV or on the remote control to turn on the LCD projection TV.
- 2 Press FUNCTION on the remote control until the TV indicator lights up.
- 3 Press CH+ on your LCD projection TV to run Auto Setup, or press CH- to exit. If you use the channel buttons on your remote control, be sure to use .

LCD projection TV front panel

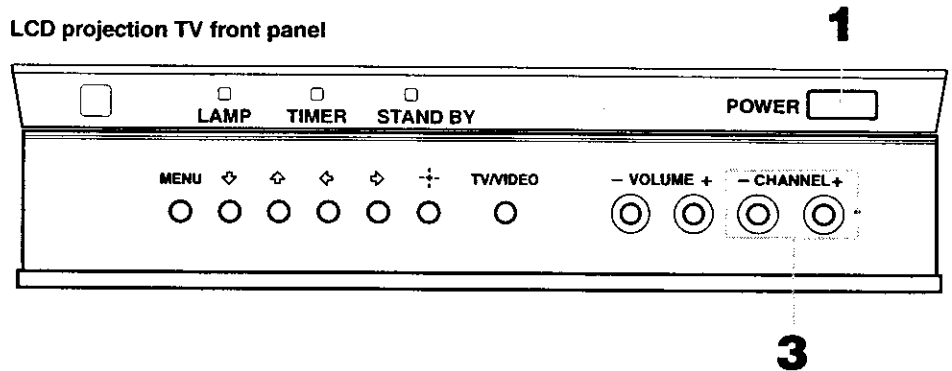

 You can run Auto Program by selecting it in the Channel menu, as described on page 73.

The following table describes the buttons on the remote control that are for more advanced functions.

Button Descriptions

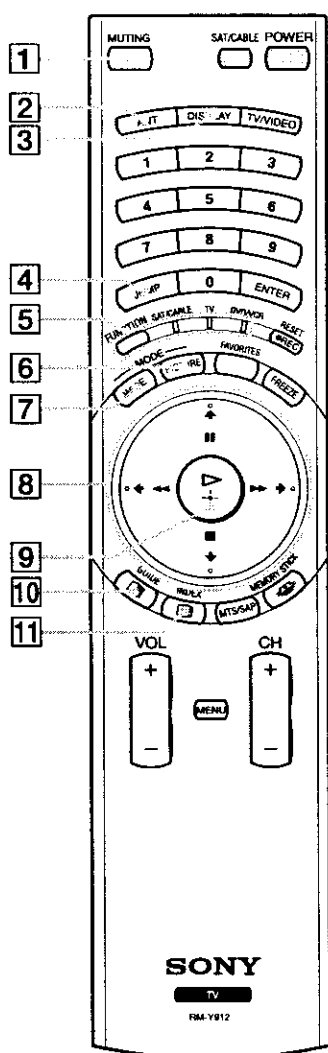

- | | | |
|-----------|---------------------|---|
| 1 | MUTING | Press to mute the sound. Press again or press VOL + to restore the sound. |
| 2 | ANT | Changes between the VHF/UHF input and the AUX input. |
| 3 | DISPLAY | Press once to display the current time and channel label (if set) and channel number. Press again to turn Display off. See page 81 for details on setting the time. |
| 4 | JUMP | Press to jump back and forth between two channels. The LCD projection TV alternates between the current channel and the last channel that was selected. |
| 5 | FUNCTION | Select the equipment (TV, SAT/CABLE, DVD/VCR) that you want to operate. The indicator lights up momentarily when pushed to show which device the remote control is operating. |
| 6 | PICTURE MODE | Press repeatedly to step through the available video picture modes: Vivid, Standard, Pro and Mild. Also available in the Video menu. For details, see "Selecting Video Options" on page 67. |
| 7 | WIDE MODE | Press to step through the wide screen modes: Wide Zoom, Normal, Full and Zoom. For details, see "Using Wide Screen Mode" on page 57. |
| 8 | | When the menu is displayed, move the on-screen cursor. |
| | | : Pause
■ : Stop
◀◀ : Rewind
▶▶ : Fast-Forward |
| 9 | | ▷: Playback |
| | | ◄◄ : When the menu is displayed, select the item. |
| 10 | | Turns on/off Twin View. For details, see "Using Twin View™" on page 51. |
| | GUIDE | Displays the program guide of your satellite. |
| 11 | | INDEX
Press to enter the Scrolling Channel Index mode. You can view and select from all receivable channels scrolling on the screen without leaving the current one. |

(Continued)

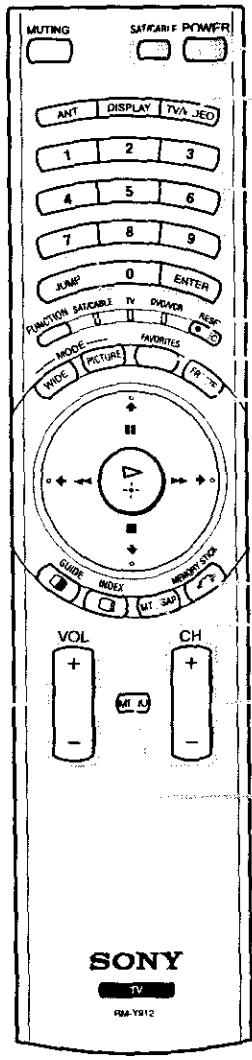

12

- 13
- 14
- 15
- 16
- 17
- 18
- 19
- 20
- 21
- 22

- 12 VOL +/-
- 13 POWER buttons (GREEN)
- 14 TV/VIDEO
- 15 0 - 9 and ENTER
- 16 ● REC RESET
- 17 FAVORITES
- 18 FREEZE
- 19 MEMORY STICK 
- 20 MTS/SAP
- 21 CH +/-
- 22 MENU

Adjusts the volume.

Turn on and off the LCD projection TV and other audio/video equipment you have programmed into the remote control. For instructions, see "Programming the Remote Control" on page 82.

Cycles through the video equipment connected to your LCD projection TV's video inputs: TV, VIDEO 1, VIDEO 2, VIDEO 3, VIDEO 4, VIDEO 5, VIDEO 6 and VIDEO 7.

Press 0 - 9 to select a channel, the channel changes after 2 seconds. Press ENTER to select immediately.

Record

Press when in a menu to reset the settings to the factory defaults.

Displays the Favorite Channels list. For details, see "Using Favorite Channels" on page 50.

Freezes the window picture. Press again to restore the picture.

Press to display the Memory Stick Menu. For details, see "Using the Memory Stick Picture Viewer" on page 58

Press to scroll through the Multi-channel TV Sound (MTS) options: Stereo, Auto SAP, and Mono.

Scan through channels.

To scan rapidly through the channels, press and hold down CH+ or CH-.

Press to display the LCD projection TV on-screen menu. Press again to exit from the menu.

Buttons for LCD Projection TV Operations

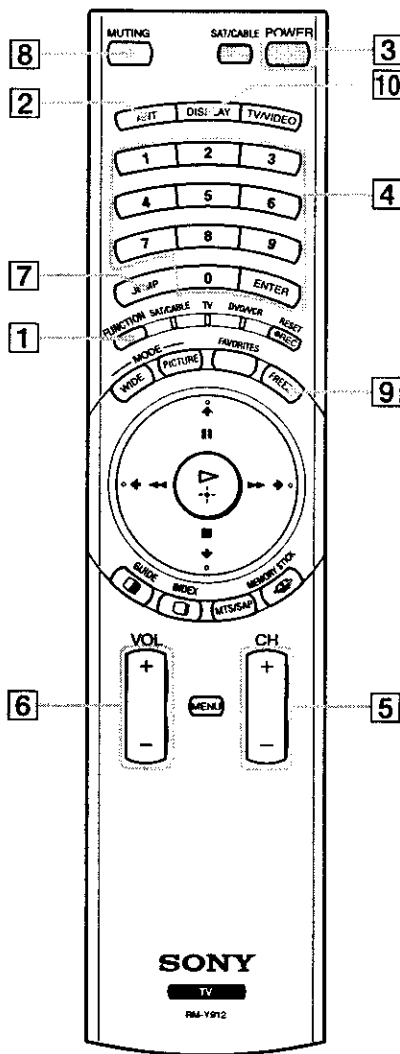

Many TV features can be accessed directly through the remote control. The following will explain the function of some of the buttons found on your remote control.

1) FUNCTION

Press until the TV indicator lights up.

This activates the remote control for use with the LCD projection TV.

2) ANT—(AUX)

Press to change between the VHF/UHF input and the AUX input.

3) POWER

Turns the LCD projection TV on and off. If a video input indication (e.g., VIDEO 1, VIDEO 2) appears on the screen, press TV/VIDEO or CH +/– until a channel number appears.

4) 0-9 and ENTER

Use for direct channel selection. Press 0-9 to select a channel (for example, to select channel 10, press 1 and 0). The channel will change after 2 seconds, or you can press ENTER for immediate selection.

5) CH +/-

Press to scan through the channels (+ up or – down).

6) VOL +/-

Press to adjust the volume (+ up or – down).

7) JUMP

Press to alternate or jump back and forth between two channels. The LCD projection TV will jump between the current channel and the last channel selected.

8) MUTING

Press to mute the sound. “MUTING” will appear on the screen and will dim three seconds later. To restore the sound, press again or press VOL +.

9) FREEZE

This is useful when you need to copy down information that appears on the LCD projection TV’s screen (see “Using the Freeze Function” on page 54).

10) DISPLAY

Press to display the channel number, current time and channel label (if set).

To turn the display off, press DISPLAY again.

(Continued)

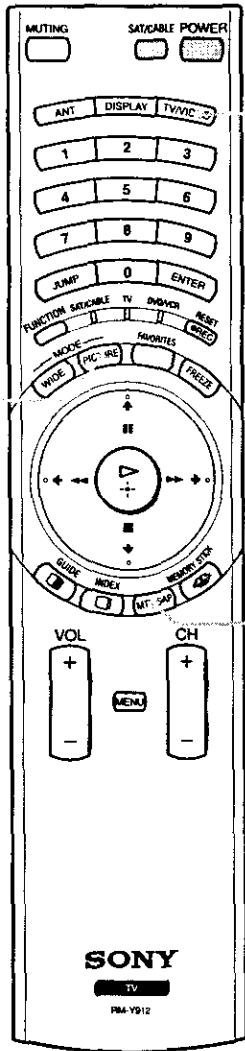

13

11

Press repeatedly to scroll through available video inputs: TV, VIDEO 1, VIDEO 2, VIDEO 3, VIDEO 4, VIDEO 5, VIDEO 6 and VIDEO 7.

If you select Skip as a Video Label in the Setup menu, your LCD projection TV will skip the video input you selected (see "Video Label" on page 80).

Press to scroll through the Multi-channel TV Sound (MTS) options (see "MTS" on page 69).

Press PICTURE MODE repeatedly to directly choose one of four different video modes that best suits the program you are watching.

Vivid: Select for enhanced picture contrast and sharpness.

Standard: Select to display a standard picture for normal viewing environments.

Pro: Select to display a picture with minimum enhancements.

Mild: Select to smooth the outline of digital image.

When you select each mode, you can also adjust the picture quality (such as Brightness, Color, etc.) to suit your taste. For details, see "Mode" on page 67.

12

When you have connected the DTV receiver, you can enjoy digital TV programs. This LCD projection TV is capable of receiving the 1080i, 720p, 480p and 480i digital TV formats.

Connect the DTV receiver to HD/DVD IN 5 or 6 on the LCD projection TV (for details, see page 39).





Press TV/VIDEO to select HD/DVD IN 5 or 6.

Select a digital channel on the DTV receiver. For details, see the Operating Manual of the DTV receiver.

Adjust the volume of the LCD projection TV as necessary.

The Favorite Channel feature lets you select programs from a list of favorite channels that you preset.

Creating a List of Favorite Channels

- 1 Press MENU to display the Menu.
- 2 Press ◀ or ▶ to highlight the Channel icon and press .
- 3 Press  to select Favorite Channels.
- 4 Press ▲ or ▼ to highlight a Favorite Channel number (1-8) and press .
- 5 Press ▲ or ▼ to highlight a channel you want to assign to the Favorite Channel number. A preview of the highlighted channel appears in the upper right of the screen.
Press  to select that channel as a Favorite Channel.
- 6 To add more channels to your favorites list, repeat steps 4-5.
To clear a Favorite Channel, press ▲ or ▼ to highlight the channel you want to clear. Press  and then press RESET.
- 7 Press MENU to exit the Menu.
- 8 For details on using the Channel Menu, see page 73.

Displaying a List of Favorite Channels

- 1 Press FAVORITES.
The Favorite Channel options appear.



- 2 Press ▲ or ▼ to highlight the channel you want to watch. The program of that channel appears in the preview window. Press  to select.
- 3 When the remote control mode is set to other than TV mode, you can display the Favorite Channels. However, you cannot select the channel by using ▲ or ▼.
- 4 To assign Channel Labels (e.g., ABC, HBO, MTV, etc.) to channel numbers, as shown at right, use the Channel Label feature in the Channel Menu (see page 74).



Twin View enables you to watch two programs at the same time. You can also change the size of both the left and right pictures.

Activating Twin Pictures



- 1. Make sure your LCD projection TV is tuned to a working channel.

2. Press .



- 3. Press  again (or press ).

Activating the Picture

Although two pictures appear on the screen at the same time, only one picture is active. Change the picture size by using the  or  button. For an active picture, you can:

- 1. Change channels.
- 2. Adjust the volume.
- 3. Switch the input sources from VHF/UHF to cable by pressing ANT or TV/VIDEO to switch the video input.

- 4. Press .



Press .

 Hookups that affect your ability to use Twin View:

- If you are viewing all channels through the cable box, the Twin View feature will not work. The cable box only unscrambles one signal at a time, so the right picture will be the same as the left picture.
- You can watch a scrambled cable channel and another video source. Be sure your DVD player, VCR or satellite receiver are connected to one of the VIDEO IN 1-7 and AUX inputs on the rear of the LCD projection TV. Pictures from equipment connected to HD/DVD IN 5 and 6, DVI-HDTV IN 7, and AUX will only appear in the left picture, not in the right.

 The active picture is highlighted in cyan.

 Viewing Twin View

If you use a cable box to view all channels, the same channel appears in both windows because the cable box unscrambles only one channel at a time.

If you use a cable box, you can view the cable box output in one window and view a different source (such as a VCR or DVD player) in the second window by using the TV/VIDEO button.

Sources connected to the AUX, VIDEO 5, VIDEO 6, and VIDEO 7 inputs display in the left window, but not the right.

If you are viewing a 4:3 source and a 16:9 enhanced source (such as a DVD) side by side, the 4:3 source appears larger.

Twin View does not display channels that are blocked by parental settings (see page 75).

Changing the Picture Size

The zoom feature lets you change the size of the left and right pictures.

Press ← to activate the left picture (if not already activated).

Press ↑ to enlarge the picture and ↓ to reduce the picture.

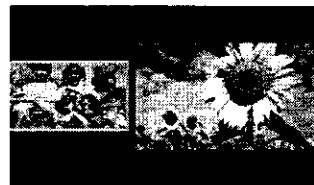
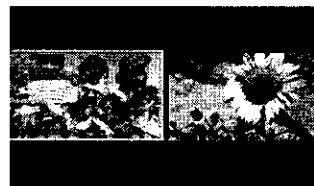

Press → to activate the right picture (if not already activated).

Press ↑ to enlarge the picture and ↓ to reduce the picture.

📌 When you adjust the twin screen sizes, the LCD projection TV memorizes the change. The next time you use the Twin View function, the memorized sizes appear.

The **FREEZE** button allows you to temporarily capture a program's picture. You can use this feature to write down information such as phone numbers, recipes, etc.

How to Use the FREEZE Button

- 1 When the program information you want to capture is displayed, press **FREEZE**.
- 2 The LCD projection TV switches to Twin View mode and displays the "frozen" picture on the right, while the current program continues on the left.



- 3 To cancel and return to normal viewing, press **FREEZE**.
- 4 Freeze feature is not available if you are already in Favorite Channel (see page 50), Twin View™ (see page 51), or Channel Index (see page 55) mode.

Scrolling Channel Index allows you to view and select from all receivable channels scrolling on the screen without leaving the current channel.





 Scrolling Channel Index will not function when Parental Lock is activated.

Procedure for Scrolling Channel Index

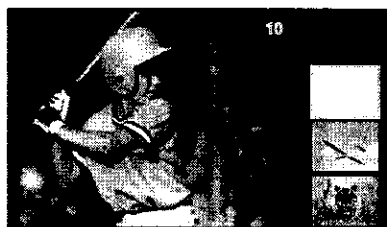



1 Press .

The current channel will be reduced in size and displayed on the left in normal motion picture format. The first channel is briefly displayed on the bottom-right side of the screen, then frozen. It scrolls up and the next channel appears on the bottom-right, and the process is repeated with the other channels.



2 Press  and  so that the channel you wish to view is displayed in the cyan frame, and press .
To return to scrolling, press  and  again.



 To change the direction of scrolling, press  or  once.
To increase scrolling speed, hold pressing  or .

3 To enlarge the selected channel into the left frame, press  again.
The selected channel will be displayed in normal motion picture, and the sound also switches to this channel.

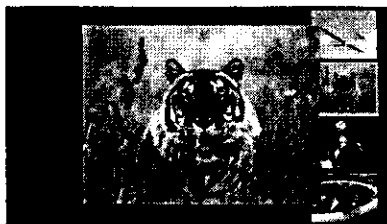

(Continued)

Press  .
The selected channel will be enlarged for normal viewing.



Press  again to resume normal viewing.

Wide Screen Mode lets you watch 4:3 normal broadcasts in several Wide Screen Modes (16:9 aspect ratio).

Press **WIDE MODE** repeatedly to toggle through the following Screen Mode settings.

You can also access the Screen Mode settings in the Screen menu. For details, see page 71.



Wide Zoom

Wide Zoom enlarges the 4:3 picture to fill the 16:9 screen, keeping the original image as much as possible.



Normal

Normal returns the 4:3 picture to its original size.



Full

Full Mode stretches the 4:3 picture horizontally only, to fill the 16:9 screen.



Zoom

Zoom Mode enlarges the 4:3 picture horizontally and vertically to an equal aspect ratio that fills the 16:9 screen. Useful for watching Letterbox movies.

When you change channels or inputs, the Screen Mode settings revert to Wide Zoom (or the 4:3 Default setting in the Wide menu). To retain the current Screen Mode setting as channels and inputs are changed, set 4:3 Default to Off. For details, see page 72.

About Memory Stick

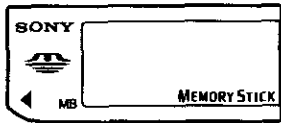

Memory Stick (sold separately) is a new, compact, portable, and versatile Integrated Circuit recording medium with a data capacity that exceeds that of a floppy disk. Memory Stick is specially designed for exchanging and sharing digital data among Memory Stick compatible products such as digital cameras and digital video cameras. Because it is removable, Memory Stick can also be used for external data storage.

 You cannot write to Memory Stick media using the LCD projection TV.

Memory Stick technology allows you to view on your TV screen digital (jpeg) images that are stored on Memory Stick media. You can choose from an index of the images stored on the Memory Stick, or you can run a slideshow of those images. You can also customize the features of the slideshow by selecting the length of time that each image is displayed, toggling the display of file information, and rotating each image.

For more information about the using Memory Stick media, see "Notes on Using Memory Stick Media" on page 86.

Supported Image Types

This LCD projection TV's Memory Stick viewer can display only still images that have been recorded on Memory Stick media by Sony brand digital still and video cameras.

 The LCD projection TV's Memory Stick viewer is compatible with Memory Sticks up to and including 128MB. It is not compatible with Memory Sticks that exceed 128MB.

Recorded images must also meet the following specifications:

Compression format: JPEG

File name format: DCF compliant

 JPEG stands for "Joint Photographic Experts Group," which is the organization that implemented this format. DCF stands for "Design Rules for Camera File Systems," which are specifications established by the Japan Electronic Industry Development Association (JEIDA).

Most Sony brand digital still and video cameras automatically record still images using DCF compliant directory and file names, as shown in the following example:

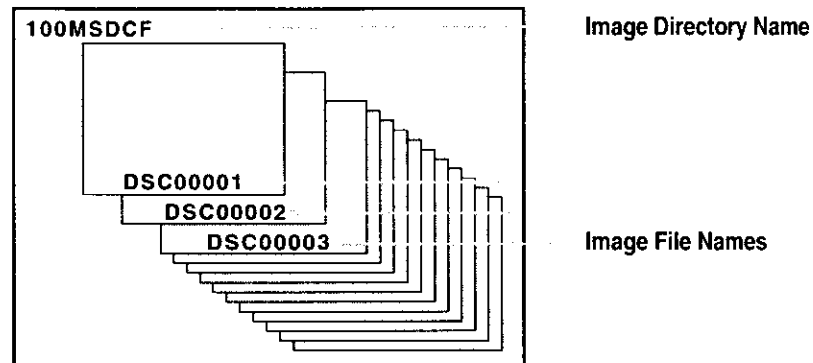

Do not rename directories. If the names are changed, the still images cannot be displayed on your LCD projection TV.

Unsupported Image Types

This LCD projection TV's Memory Stick viewer cannot display any of the following:

- Images recorded on digital still cameras and digital video cameras that are not Sony brand
- Images recorded using products that are not DCF compliant, including the following Sony products:

Digital still	DSC-D700, DSC-D770
Digital video cameras	DCR-TRV900/DSR-PD100A
- Images stored on a Memory Stick that has a capacity that exceeds 128MB
- Images stored in TIFF or any other non-JPEG compression format
- Images in directories that were modified or renamed on a computer
- Images with less than 16 horizontal and/or vertical lines per dot
- Images with more than 4096 horizontal and/or vertical lines per dot
- Movie clips

Inserting and Removing a Memory Stick

Locate the Memory Stick slot (see pages 21-22) and insert the Memory Stick into the Memory Stick slot as illustrated below.

When inserted properly, it should slide in with little resistance and click into place.

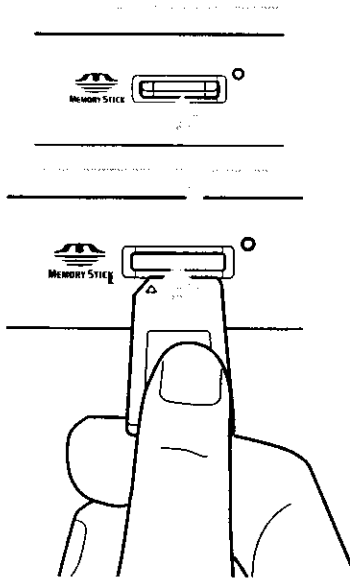

 Be sure to insert the Memory Stick in the correct direction. If the Memory Stick is forced in the wrong way, it may become damaged.

Insert only Memory Stick media into the Memory Stick slot. Attempting to insert other objects into the slot may damage the LCD projection TV.

Check that the Memory Stick indicator is off. (When the light is on, this indicates that the LCD projection TV is reading data from the Memory Stick.)

- Push the Memory Stick gently into the slot, and then release it. The Memory Stick media is ejected.

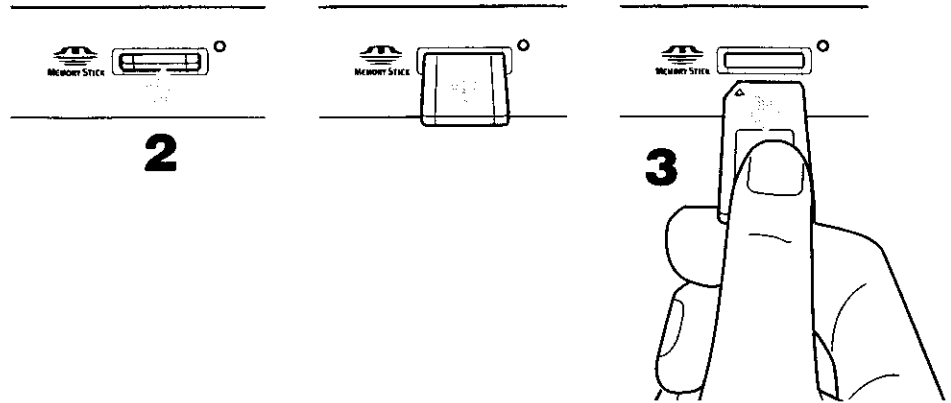

- Pull the Memory Stick completely out of the slot.

- When removing the Memory Stick, do not attempt to just pull it from its slot.

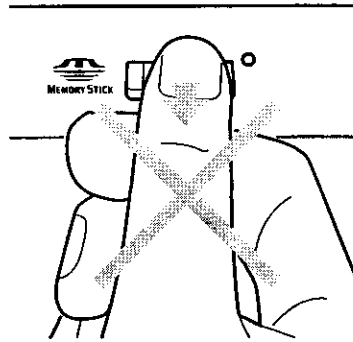

- To protect small children from injury from Memory Stick Media, remove all Memory Stick media from the LCD projection TV's Memory Stick slot and store it in a safe location when it is not in use.

Displaying the Memory Stick Menu

- When the remote control mode is set to other than TV mode, you can display the Memory Stick Menu. However, you cannot select the menu item by using $\uparrow/\downarrow/\leftarrow/\rightarrow$ or \odot .

- Insert a Memory Stick that contains the images you want to view. For details, see page 60.

Press MEMORY STICK on the remote control. The Memory Stick Menu appears.

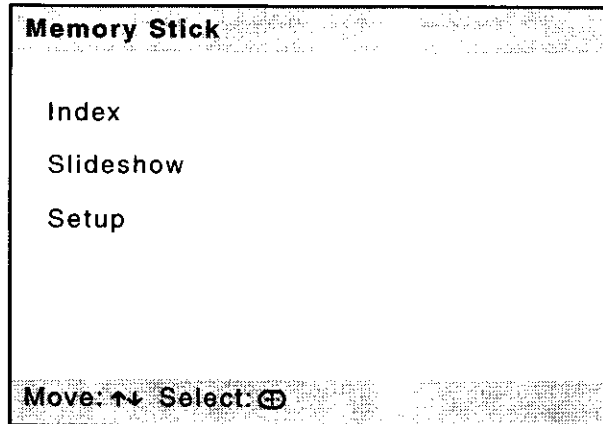

To select an option, press **↑** or **↓** to highlight the option and press **⊕**.

Option	Description
Index	Displays an index of thumbnail images that are on the Memory Stick. For details, see "Using the Memory Stick Index" on page 62.
Slideshow	Displays a slideshow of images that are on the Memory Stick. For details, see "Using the Memory Stick Slideshow" on page 64.
Setup	Allows you to change slideshow options and rotate images. For details, see "Changing the Memory Stick Setup Options" on page 64.

To exit the Memory Stick Menu, press **CH +/-**, **TV/VIDEO**, **ANT**, or use the **0-9** buttons and **ENTER** (or wait 3 seconds) to select a channel.

Memory Stick functions are not available while using Twin View, Freeze or Favorite Channel functions.

Using the Memory Stick Index

The Memory Stick Index lets you view images that are on the Memory Stick in an index of thumbnail images.

There is no audio signal available while viewing images on Memory Stick.

Insert a Memory Stick that contains the images you want to view. For details, see page 60.

Press **MEMORY STICK** on the remote control. The Memory Stick Menu appears.

- Press \uparrow or \downarrow to highlight Index and press \odot . The Memory Stick Index appears.

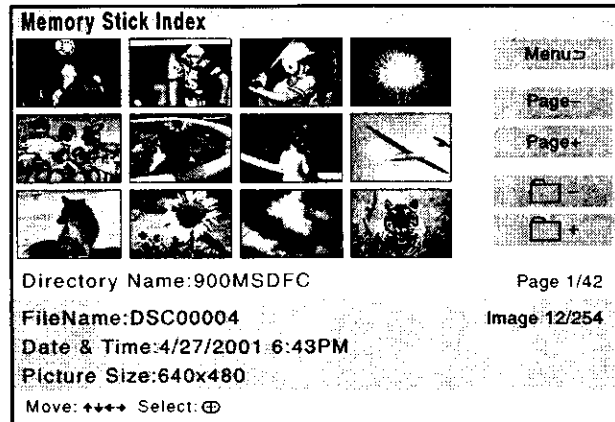

The selected image is highlighted in yellow

Information about the selected image

- The Page and folder (\square) buttons are available only if the Memory Stick contains more images or folders than can be displayed on one screen.
- Press \uparrow \downarrow \leftarrow \rightarrow to highlight an image and press \odot to select the image. Selecting an image displays that image at full size. While an image is displayed full size, you can do any of the following:

Display the previous image

Press \leftarrow .

Display the next image

Press \rightarrow . If you press \rightarrow while viewing the last image, the first image is displayed. If you press \leftarrow while viewing the first image, the last image is displayed.

Display the Memory Stick Index

Press \odot .

Larger images will take longer to display on screen.

- To return to the Memory Stick Menu, press the arrow button to Menu \supset and press \odot .

- If a blank square appears instead of a thumbnail image, this indicates that the image does not support a thumbnail view. Selecting the icon, however, displays the full-size image on the screen. It could also indicate that both the thumbnail and full-size images are corrupted or not supported.

Using the Memory Stick Slideshow

The Memory Stick Slideshow lets you watch a slideshow of the images that are on the Memory Stick.

1. Insert a Memory Stick that contains the images you want to view. For details, see page 60.
2. Press **MEMORY STICK** on the remote control. The Memory Stick Menu appears.
3. Press **▲** or **▼** to highlight Slideshow and press **⊙**. The slideshow starts.
4. To end the slideshow, press **⊙**. The Memory Stick Menu is displayed.

Changing the Memory Stick Setup Options

1. Press **MEMORY STICK** on the remote control. The Memory Stick Menu appears.
2. Press **▲** or **▼** to highlight Setup and press **⊙**. The Memory Stick Setup Menu appears.

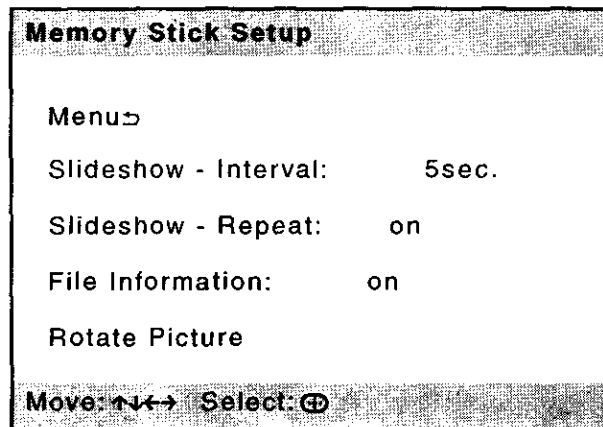

3. Press the arrow button to highlight an option and press **⊙**

Option	Description
Menu	Returns to the Memory Stick Menu.
Slideshow - Interval	Decrease or increase the length of time that each image is displayed: 5 seconds, 10 seconds, 1 minute, 5 minutes, or 15 minutes.
Slideshow - Repeat	Select On to set the slideshow to repeat after displaying all the images recorded on the Memory Stick. Select Off to not repeat the slideshow.
File Information	Select On to show file information of each image while that image is being displayed.
Rotate Picture	Displays the Rotate Picture screen. For details, see "Using the Rotate Picture Screen" on page 65.

- Press \rightarrow (or press $\left(\frac{\oplus}{\ominus}\right)$), and then \uparrow or \downarrow to change setting.
- Press $\left(\frac{\oplus}{\ominus}\right)$ to enter the setting, and then \leftarrow .
- To exit the Memory Stick Setup Menu, press the arrow button to Menu \rightarrow and press $\left(\frac{\oplus}{\ominus}\right)$.

Using the Rotate Picture Screen

The Rotate Picture Screen lets you rotate an image from an index of thumbnails.

-  You cannot rotate images if the LOCK switch on the Memory Stick is on. To rotate the images, first set the LOCK switch to off.

- In the Memory Stick Setup Menu, press \uparrow or \downarrow to highlight Rotate Picture and press $\left(\frac{\oplus}{\ominus}\right)$. The Rotate Picture screen appears.

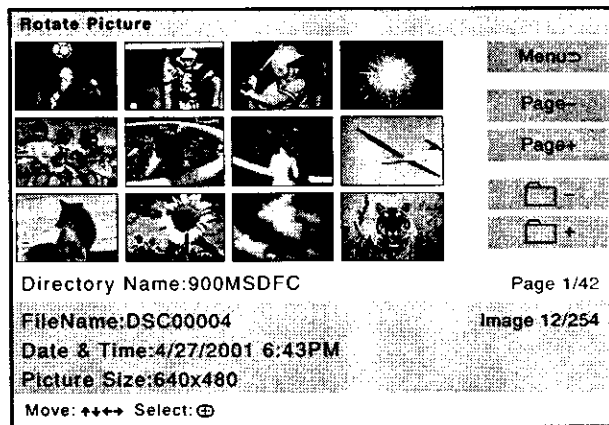

-  The Page and folder (\square) buttons are available only if the Memory Stick contains more images or folders than can be displayed on one screen.

- Press \uparrow \downarrow \leftarrow \rightarrow to highlight an image that you want to rotate.
- Press $\left(\frac{\oplus}{\ominus}\right)$ to rotate an image 90 degrees in a clockwise direction.
- To return to the Memory Stick Setup Menu, press the arrow button to highlight Menu \rightarrow and press $\left(\frac{\oplus}{\ominus}\right)$.

-  If a blank square appears instead of the thumbnail image, this indicates that the image does not support a thumbnail view and cannot be rotated.

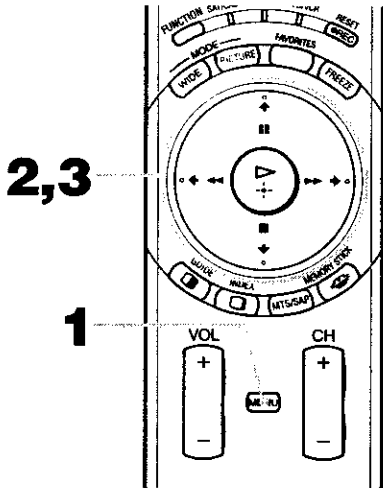

Press MENU to display the menu screen.

Press ◀ or ▶ to highlight the desired menu icon and press to select it.

Use the arrow button to scroll through the features.

See the specific menu page for instructions on moving through the menu.

To end the menu session

Press MENU again.

To end the menu session and return to another

Press ↑ to return to the menu icons.



Press ◀ or ▶ to choose the next menu icon and press to select it.

The menu gives you access to the following features:

Menu Icon	Description	Page
	Allows you to make adjustments to your picture settings. It also allows you to customize the Picture Mode based on the type of program you are viewing.	67
	Offers enhanced audio options such as listening to second audio programming (SAP), or customizing the Effect of the sound on your LCD projection TV.	69
	Allows you to set the wide screen mode, adjust the vertical center in wide mode, and set the 4:3 Default mode.	71
	Allows you to set up a Favorite Channel list, run the Auto Program function, and more.	73
	Lets you control the viewing of programs based on their ratings.	75
	Provides several options for setting up your channels, labeling your Video inputs, and selecting the language of the on-screen menus.	79



Press MENU.

Press ◀ or ▶ to highlight the Video icon  and press .

Use the arrow button to scroll through the features.

Press  to select a feature. That feature's adjustment appears.

Use the arrow button to make the desired adjustments.

Press  to select/set.

Press MENU to exit the menu screen.

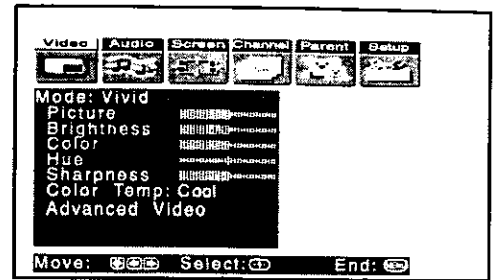



To restore the factory default settings for Picture, Brightness, Color, Hue, Sharpness and Color Temp:

- Press RESET on the remote control when in the Video menu.

Selecting Video Options

The Video menu includes the following options.

Option	Description
Mode	Vivid Select for enhanced picture contrast and sharpness.
Customized picture viewing	Standard Recommended for Normal viewing conditions.
	Pro Select to display a picture with minimum enhancements.
	Mild Select to smooth the outline of digital image.
	 You can alter the Video menu settings (Picture, Brightness, Color, etc.) for each Mode.
	 To quickly and easily change from one Video Mode to another, use PICTURE MODE on the remote control.
Picture	Adjust to increase picture contrast and deepen the color or decrease picture contrast and soften the color.
Brightness	Adjust to brighten or darken the picture.
Color	Adjust to increase or decrease color intensity.
Hue	Adjust to increase or decrease the green tones.
Sharpness	Adjust to sharpen or soften the picture.
Color Temp	Choose from three color temperatures:
White intensity adjustment	Cool Select to give the white colors a blue tint.
	Neutral Select to give the white colors a neutral tint.
	Warm Select to give the white colors a red tint.

(Continued)

Advanced
Video

- CineMotion** Obtains a smooth picture movement that approaches the original film-like quality when reproducing movies or other video sources on 24 frame per second films.
- On** The LCD projection TV automatically detects the signal type of a film and processes it appropriately.
- Off** Select to turn off the CineMotion mode.

⚠ When the Video Mode is set to Mild (page 67), you cannot set CineMotion to On.

- DRC Palette** Allows you to customize the level of detail (Reality) and smoothness (Clarity) for up to three input sources. For example, you can create one Custom setting to optimize your cable input's picture, and create another to optimize your DVD player's picture. You can switch among the three Custom settings.

- 1 Press the arrow button to highlight Custom 1, Custom 2, or Custom 3 and then press . The DRC palette appears.

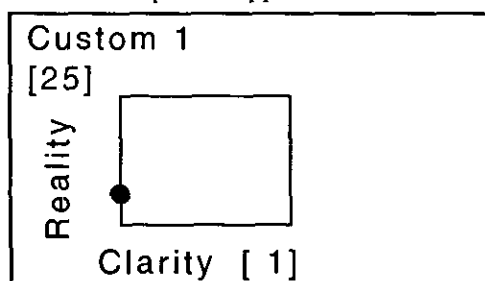

- 2 Press the arrow button to adjust the position of the marker (●). As you move the ● higher along the Reality axis, the picture becomes more detailed. As you move the ● to the right along the Clarity axis, the picture becomes smoother.
- 3 To save the setting, press .

To return the Custom options to the default factory settings, press the **RESET** button.

⚠ Advanced Video is unavailable when you have selected Mild picture mode, or you are watching 1080i, 720p and 480p sources with Video 5 to 7 inputs.



1. Press MENU.
2. Press ◀ or ▶ to highlight the Audio icon  and press (P+).
3. Use the arrow button to scroll through the options.
4. Press (P+) to select an option. That option's settings appear.
5. Use the arrow button to scroll through the settings.
6. Press (P+) to select the desired setting.
7. Press MENU to exit the menu screen.



8. Press RESET on the remote control when in the Audio menu.

Selecting Audio Options

The Audio menu includes the following options:

Treble		Adjust to increase or decrease higher-pitched sounds.
Bass		Adjust to increase or decrease lower-pitched sounds.
Balance		Adjust to emphasize left or right speaker balance.
Steady Sound	Auto	Select to stabilize the volume.
	Off	Select to turn off Steady Sound.
Effect	TruSurround	Select for surround sound (for stereo programs only).
	Simulated	Adds a surround-like effect to mono programs.
	Off	Normal stereo or mono reception.
MTS <i>Enjoy stereo, bilingual and mono programs</i>	Stereo	Select for stereo reception when viewing a program broadcast in stereo.
	Auto SAP	Select to automatically switch the LCD projection TV to second audio programs when a signal is received. (If no SAP signal is present, the LCD projection TV remains in Stereo mode.)
	Mono	Select for mono reception. (Use to reduce noise during weak stereo broadcasts.)

(Continued)

Speaker	On	Select to turn on the LCD projection TV speakers.
	Off	Select to turn off the LCD projection TV speakers and listen to the LCD projection TV's sound only through your external audio system speakers.
Audio Out <i>Easy control of volume adjustments</i>	Variable	The LCD projection TV's speakers are turned off, but the volume output from your audio system can still be controlled by the LCD projection TV's remote control.
	Fixed	The LCD projection TV's speakers are turned off and the volume, bass and treble output of the LCD projection TV is fixed. Use your audio receiver's volume control to adjust the volume through your audio system.



- 1 Press MENU.
- 2 Press **←** or **→** to highlight the Screen icon  and press **⏏**.
- 3 Use the arrow button to scroll through the features.
- 4 Press **⏏** to select a feature. That feature's options appear.
- 5 Use the arrow button to scroll through the options.
- 6 Press **⏏** to select the desired option.
- 7 Press MENU to exit the menu screen.

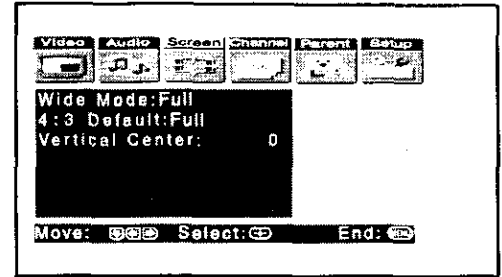



Selecting Screen Options

The Screen menu includes the following options:

-  To change from one Wide Mode to another, use WIDE MODE on the remote control.

Option	Description	
Wide Mode	Wide Zoom	
Select a Screen Mode to use for 4:3 sources.	Normal	Select to return the 4:3 picture to normal mode.
	Full	Select to enlarge the 4:3 picture horizontally only, to fill the wide screen.
	Zoom	Select to enlarge the 4:3 picture horizontally and vertically to an equal aspect ratio that fills the wide screen.

-  Wide Mode is unavailable while in Twin View (page 51), Freeze (page 54), or Channel Index (page 55) mode.

-  Wide mode is unavailable when you are watching 720p and 1080i sources, and when viewing photos from your memory stick media.

4:3 Default <i>Select the default Screen Mode to use for 4:3 sources.</i>	Wide Zoom	Select to enlarge the 4:3 picture, to fill the 16:9 screen, keeping the original image as much as possible.
	Normal	Select to return the 4:3 picture to normal mode.
	Full	Select to enlarge the 4:3 picture horizontally only, to fill the wide screen.
	Zoom	Select to enlarge the 4:3 picture horizontally and vertically to an equal aspect ratio that fills the wide screen.
	Off	Select to continue using the current Screen Mode setting when the channel or input is changed.



The 4:3 Default functions only when the LCD projection TV receives 480i and 480p signals.

If 4:3 Default is set to anything but Off, the Wide Mode setting changes only for the current channel. When you change channels (or inputs), Wide Mode is automatically replaced with the 4:3 Default setting. To retain the current Wide Mode setting as channels and inputs are changed, set 4:3 Default to Off.

Vertical Center Allows you to move the position of the picture up and down in the window. (Available only in Wide Zoom and Zoom modes.) Press **▲** or **▼** to choose a position and press **⊕**.



Press MENU.

Press ◀ or ▶ to highlight the Channel icon  and press .

Use the arrow button to scroll through the features.

Press  to select a feature. That feature's options appear.

Use the arrow button to scroll through the options.

Press  to select the desired option.

Press MENU to exit the menu screen.

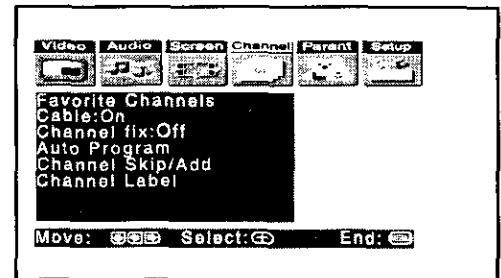

Selecting Channel Options

The Channel menu includes the following options:



Favorite Channels		Let you set up a list of your favorite channels. For details, see "Using Favorite Channels" on page 50..
Cable	On	Select if you are receiving cable channels with a CATV cable.
	Off	Select if you are using an antenna.
		 You should run Auto Program after changing the Cable setting.
Channel Fix	2-6	"Fix" your LCD projection TV's channel setting to 3 or 4 and use the cable box, VCR or satellite receiver to change channels. Select one of these settings if you have connected the device to the VHF/UHF jack.
<i>Useful when you have a cable box or satellite receiver connected</i>	AUX 2-6	Same as 2-6, except you select one of these settings if you have connected the device to the AUX jack (see page 23).
	Video 1	Use when connecting a cable box. TV output should be connected through the cable box.
Auto Program		Automatically programs the LCD projection TV for all receivable channels.

Channel Skip/Add

Removes and adds viewable channels.

Use the arrow button to scroll through the channels until you find the channel you want to skip/add.

1 Press  to select it.

2 Press  or  to toggle between "Add" and "Skip."



3 Press  to select.

4 Channels that you set to be skipped can be accessed only with the 0-9 buttons.



Channel Label

Allows you to assign labels (such as station call letters) to channel numbers. You can label up to 20 channels.

1 Press the arrow button to highlight Channel and press .

2 Press  or  to scroll through the channel numbers (1-125). Then press  to select the channel number that you want to assign a label.

3 Press the arrow button to highlight Label and press .

4 Press  or  to scroll through the label characters (A-Z, 0-9, etc.). Then press  to select the highlighted character.

5 Repeat to add up to 5 characters to the label.



6 To assign labels to more channels, repeat steps 1-4.

7 Press  to return to the Channel Menu, or press **MENU** to exit the Menus.

8 Channel Label is not available (grayed out) when watching the AUX and VIDEO inputs.



The Parent Menu allows you to set up the TV to block programs according to their content and rating levels.

- 1 Press MENU.
 - 2 Press **←** or **→** to highlight the Parent icon  and press **⏏**.
 - 3 Use the 0-9 buttons on the remote control to enter a four-digit password.
 - 4 If this is the first time you are creating this password, confirm the password by entering it again. (The Parent Menu options appear.)
 - 5 Press **↑** **↓** **←** **→** to change settings. Press **⏏** to select the changed setting.
 - 6 Press MENU to exit the Menu.
-  You need your password for any future access into the Parent Menu. If you lose your password, see "Lost password" on page 88.

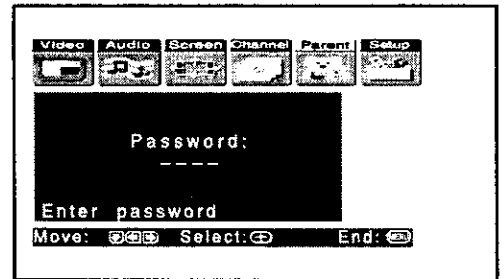

Selecting Parent Options

The Parent Menu includes the following options:

Option	Default	Description
Parental Lock	Off	Parental lock is off. No programs are blocked from viewing.
<i>Turn ratings on/off and select a rating system</i>	Child	Maximum ratings permitted are: US: TV-Y, TV-G, G Canada: C, G, TV-Y
	Youth	Maximum ratings permitted are: US: TV-PG, PG Canada: C8+, PG, 8 ans+, TV-PG
	Y. Adult	Maximum ratings permitted are: US: TV-14, PG-13 Canada: 14+, 13 ans+, TV-14
	Custom	Select to set ratings manually. US: See page 77 for details. Canada: See page 78 for details.

(Continued)

1 If you are not familiar with the Parental Guideline rating system, you should select Child, Youth, or Young Adult to help simplify the rating selection. To set more restrictive ratings, select Custom.

2 For descriptions of Child, Youth, and Young Adult ratings, see page 77.

Change Password

For changing your password.

Select Country

U.S.A. Select to use USA ratings (see page 77).

Canada Select to use Canadian ratings (see page 78).

Set Parental Lock to OFF when in the Parent menu.

Parental Control

- 1 Select Change Password option when in the Parent menu using the arrow button, and press .
- 2 Enter a new four-digit password using the 0-9 buttons.
- 3 Confirm the new password by entering it again.
- 4 Press MENU to exit the menu screen.

Viewing Blocked Programs

You can view a blocked program by entering the password.

- 1 Press ENTER when tuned to a blocked program.
- 2 Enter your password using the 0-9 buttons.
Parental Control will be canceled temporarily until you turn your LCD projection TV off.

Selecting Custom Rating Options

If you selected U.S.A. as the country of residence on page 76, the Custom Rating Menu includes the following options. (If you selected Canada, see page 78.)

- To ensure maximum blocking capability, the age-based ratings should be blocked.

Movie Rating	G	All children and General Audience.
	PG	Parental Guidance suggested.
	PG-13	Parental Guidance for children under 13.
	R	Restricted viewing, parental guidance is suggested for children under 17.
	NC-17 and X	No one 17 and under allowed.
TV Rating	Age-Based Options	
<i>Block programs by their rating, content or both</i>	TV-Y	All children.
	TV-Y7	Directed to older children.
	TV-G	General Audience.
	TV-PG	Parental Guidance suggested.
	TV-14	Parents Strongly cautioned.
	TV-MA	Mature Audience only.
	Content-Based Options	
	FV	Fantasy Violence.
	D	Suggestive Dialogue.
	L	Strong Language.
	S	Sexual situations.
	V	Violence.
Unrated	Block	Blocks all programs and movies that are broadcast without a rating.
<i>Block programs or movies that are broadcast without a rating</i>	Allow	Allows programs and movies that are broadcast without a rating.
		If you select "Block," please be aware that the following programs may be blocked: emergency broadcasts, political programs, sports, news, public service announcements, religious programs and weather.

 The content ratings will increase depending on the level of the age-based rating. For example, a program with a TV-PG V (Violence) rating may contain moderate violence, while a TV-14 V (Violence) rating may contain more intense violence.





If you selected Canada as the country of residence on page 76, the Custom Rating Menu includes the following options. (If you selected U.S.A., see page 77.)

English Rating	C	All children.
	C8+	Children 8 years and older.
	G	General programming.
	PG	Parental Guidance.
	14+	Viewers 14 and older.
	18+	Adult programming.
French Rating	G	General programming.
	8 ans+	Not recommended for young children.
	13 ans+	Not recommended for ages under 13.
	16 ans+	Not recommended for ages under 16.
	18 ans+	Programming restricted to adults.
USA Rating	See "TV Rating" on page 77 for details.	



Setup Menu

How to Use the Setup Menu

- 1 Press MENU.
- 2 Press ◀ or ▶ to highlight the Setup icon  and press .
- 3 Use the arrow button to scroll through the features.
- 4 Press  to select a feature. That feature's options appear.
- 5 Use the arrow button to scroll through the options.
- 6 Press  to select the desired option.
- 7 Press MENU to exit the menu screen.

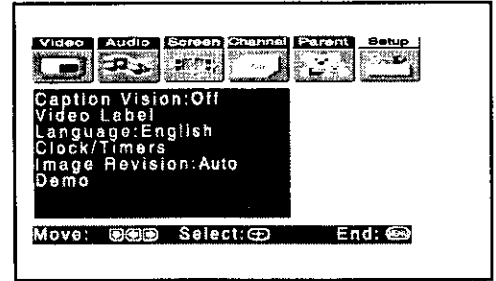





Selecting Setup Options

The Setup menu includes the following options:

Option	Description
Caption Vision	Allows you to select from three closed caption modes (for programs that are broadcast with closed captioning).
CC1, CC2, CC3, CC4	Displays a printed version of the dialog or sound effects of a program. (Should be set to CC1 for most programs.)
Text1, Text2, Text3, Text4	Displays network/station information presented using either half or the whole screen (if available). For closed captioning, set to CC1.
Info	Displays the program name and the time remaining in the program (if the broadcaster offers this service). Displays when the channel is changed or the DISPLAY button is pressed.
Off	Turns off Caption Vision.

(Continued)

Video Label

Allows you to label the audio/video components you connected to the LCD projection TV so you can identify them when using TV/VIDEO. When in the Setup menu's Video Label feature, press  or  to highlight an input to label, then press  to select it. Use the arrow button to scroll through the labels. Press  to select the component you connected to each of the input jacks on the back of your LCD projection TV. Select "Skip" if you do not have a component connected to a particular set of input jacks.

Video 1/2/3/4

VHS, DVD, Receiver, Satellite, Cable Box, 8mm, DTV, Game, LD, Web, Beta, Skip

Video 5/6/7

DVD, Satellite, Cable Box, DTV, HD, Skip

If you select "Skip," your LCD projection TV skips this connection when you press TV/VIDEO.

 When you select "Receiver" on Video Label, your LCD projection TV's input is fixed (for Video 1 only).

Language

Select to display all on-screen menus in your language of choice: English, Español, Français.

Clock/Timers

Select to set the clock and to program your TV to turn on and off at two scheduled viewing times.

Timer 1

You can use the Timers to program the

Timer 2

TV to turn on and off and tune to a specific channel at two scheduled viewing times.

Timer 1 and Timer 2 are not available to be set until you set the Current Time.

Press **▲** or **▼** to highlight Timer 1 or Timer 2. To set the timer, press **▶**.

Press **▲** or **▼** to highlight one of the following options, then press **⊕**.

Program

Select to set the Timer by day, time, duration, and channel.

Off

Select to turn off the Timer. (Your previous settings are saved.)

If you selected **Program** in step 2, press **▲** and **▼** to set the day(s), hour, minute, duration, and channel number. Press **⊕** or press **▶** to confirm each setting and move to the next setting.

Press **◀** to go back to the previous setting.

Press **MENU** to exit the Menu. An LED on the front panel will light, indicating the timer has been set.

 To go directly to programming Timer 1 or 2, press **⊕** instead of pressing **▶**.

Current Time

 Press **⊕** to select **Current Time**.

 Press **▲** and **▼** to set the current time (day, hour, and minute). Press **⊕** (or press **▶**) to confirm each setting and move to the next setting. Press **◀** to go back the previous setting.

 Press **MENU** to exit the Menu.

Image Revision

Adjusts the Image on your LCD projection TV.

Auto: (Factory setting) Automatically adjust double images or ghosts.

0-3 (manual): Select the value with which double images or ghosts are improved.

Demo

Runs a demonstration of on-screen Menus.

If you have video equipment that you want to control with the LCD projection TV's remote control, use the following procedures to program the remote control.

 The equipment must have infrared (IR) remote capability in order to be used with the remote control.

From the "Manufacturer's Codes" listed on page 83, select the three-digit code number for the manufacturer's code for your component. If more than one code number is listed, start with the number listed first. Use the code number to complete the following procedure.

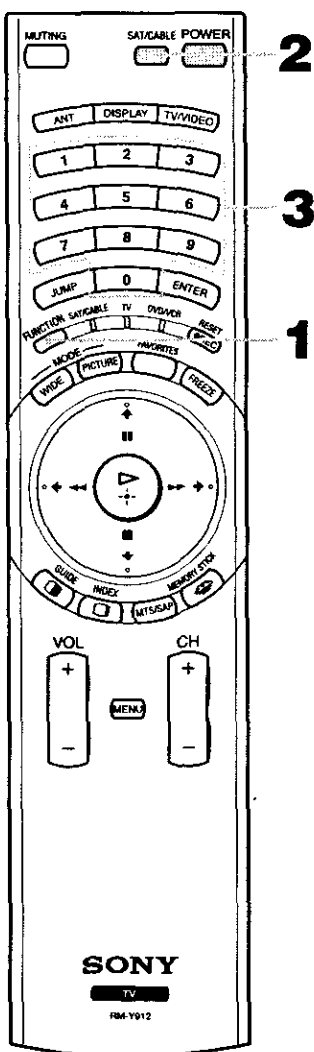

1 Press **FUNCTION** repeatedly to select your desired input.

2 Press **SAT/CABLE** for five seconds.
The indicator of the selected input flashes.

3 Input the three-digit manufacturer's code number.

 When no code number is input for 30 seconds or invalid or incorrect numbers are input, the remote control is reset to the normal TV remote control mode.

Tip

— If more than one code number is listed, try entering them one by one until you come to the correct code for your component.

— If you enter a new code number, the code number you previously entered at that setting is erased.

— In some rare cases, you may not be able to operate your component with the Sony remote control. In this case, use the component's own remote control unit.

Sony	301	Minolta	305, 304	Wards	327, 328, 335, 331, 332
Admiral (M. Ward)	327	Mitsubishi/ MGA	323, 324, 325, 326	Yamaha	314, 330, 336, 337
Aiwa	338, 344	Multitech	325, 338, 321	Zenith	331
Audio Dynamic	314, 337	NEC	314, 336, 337		
Broksonic	319, 317	Olympic	309, 308	Sony	751
Canon	309, 308	Optimus	327	Panasonic	753
Citizen	332	Panasonic	308, 309, 306, 307	Pioneer	752
Craig	302, 332	Pentax	305, 304	RCA	755
Criterion	315	Philco	308, 309	Toshiba	754
Curtis Mathes	304, 338, 309	Philips	308, 309, 310		
Daewoo	341, 312, 309	Pioneer	308		
DBX	314, 336, 337	Quasar	308, 309, 306	Hamlin/Regal	222, 223, 224, 225, 226
Dimensia	304	RCA/ PROSCAN	304, 305, 308, 309, 311, 312, 313, 310, 329	Jerrold/G. I.	201, 202, 203, 204, 205, 206, 207, 208, 218
Emerson	319, 320, 316, 317, 318, 341	Realistic	309, 330, 328, 335, 324, 338	Oak	227, 228, 229
Fisher	330, 335	Sansui	314	Panasonic	219, 220, 221
Funai	338	Samsung	322, 313, 321	Pioneer	214, 215
General Electric	329, 304, 309	Sanyo	330, 335	Scientific	209, 210, 211
Go Video	322, 339, 340	Scott	312, 313, 321, 335, 323, 324, 325, 326	Atlanta	
Goldstar	332	Sharp	327, 328	Tocom	216, 217
Hitachi	306, 304, 305, 338	Shintom	315	Zenith	212, 213
Instant Replay	309, 308	Signature 2000 (M. Ward)	338, 327		
JC Penney	309, 305, 304, 330, 314, 336, 337	SV2000	338	Sony	801
JVC	314, 336, 337, 345, 346, 347	Sylvania	308, 309, 338, 310	General	802
Kenwood	314, 336, 332, 337	Symphonic	338	Electric	
LXI (Sears)	332, 305, 330, 335, 338	Tashiro	332	Hitachi	805
Magnavox	308, 309, 310	Tatung	314, 336, 337	Hughes	804
Marantz	314, 336, 337	Teac	314, 336, 338, 337	Panasonic	803
Marta	332	Technics	309, 308	RCA/ PROSCAN	802, 808
Memorex	309, 335	Toshiba	312, 311	Toshiba	806, 807

Operating a VCR

Press FUNCTION until the DVD/VCR indicator lights up.

Turn on/off	SAT/CABLE (POWER)
Change channels	CH +/-
Record	▶ and REC simultaneously
Play	▶
Stop	■
Fast forward	▶▶
Rewind the tape	◀◀
Pause	(press again to resume normal playback)
Search the picture forward or backward	▶▶ or ◀◀ during playback (release to resume normal playback)

Operating a DVD Player

Press FUNCTION until the DVD/VCR indicator lights up.

Turn on/off	SAT/CABLE (POWER)
Play	▶
Stop	■
Pause	(press again to resume normal playback)
Step through different tracks of an audio disc	▶▶ to step forward or ◀◀ to step backward
Step through different chapters of a video disc	CH+ to step forward or CH- to step backward

Operating a Cable Box

Press **FUNCTION** until the SAT/CABLE indicator lights up.

Turn on/off	SAT/CABLE (POWER)
Select Cable Box	SAT/CABLE (FUNCTION)
Select a channel	0-9 buttons, ENTER
Change channels	CH +/-
Back to previous channel	JUMP

Operating a Satellite Receiver

Press **FUNCTION** until the SAT/CABLE indicator lights up.

Turn on/off	SAT/CABLE (POWER)
Select Satellite Receiver	SAT/CABLE (FUNCTION)
Select a channel	0-9 buttons, ENTER
Change channels	CH +/-
Back to previous channel	JUMP
Display channel number	DISPLAY
Display DBS menu	MENU
Select item	

Memory Stick Precautions

When using Memory Stick media, follow these precautions:

- ❑ To avoid permanent damage to still image data, do not turn off the TV or remove Memory Stick media from the insertion slot while data is being read (as indicated by the Memory Stick indicator light being on).
- ❑ Avoid touching the terminal of Memory Stick media or bringing it into contact with a metal object.
- ❑ Do not drop, bend, or submit Memory Stick media to external shock.
- ❑ Do not disassemble or modify Memory Stick media.
- ❑ Avoid getting liquid on Memory Stick media.
- ❑ Apply labels only within the designated label area.



- ❑ To avoid permanent damage to still image data, do not use or store Memory Stick media in a location subject to:
 - ❑ High temperature (such as near a heater or inside a hot car)
 - ❑ High humidity
 - ❑ Direct sunlight
 - ❑ Corrosive substances
 - ❑ Magnetic fields
 - ❑ Excessive dust
 - ❑ Static electricity or electric noise
- ❑ Store and carry Memory Stick media in its original case to ensure protection of stored data.
- ❑ Save a backup of stored data.

If, after reading these operating instructions, you have additional questions related to the use of your Sony television, please call our Customer Information Services Center at 1-800-222-SONY (7669) (U.S. residents only) or (416) 499-SONY (7669) (Canadian residents only).

No picture
(screen not lit),
no sound

Make sure the LCD projection TV's power cord is connected securely to the wall outlet.
Push the power button on the front of the LCD projection TV.
Check to see if the TV/VIDEO setting is correct: when watching TV, set to TV, and when watching connected equipment, set to VIDEO 1, 2, 3, 4, 5, 6 or 7.
Try another channel. It could be station trouble.
The Parental Control feature is activated (see "Using the Parent Menu" on page 75).
If your LCD projection TV's power is on, and LAMP (red) indication is flashing, the lamp for the light source burns out. Replace it with new Sony XL-2000U replacement lamp (see page 13).
If your LCD projection TV does not turn on, and a red light keeps flashing, your LCD projection TV may need service. Call your local Sony Service Center.

Remote control
does not operate

Batteries could be weak. Replace the batteries.
Press FUNCTION until the TV indicator lights up when operating your LCD projection TV.
Make sure the LCD projection TV's power cord is connected securely to the wall outlet.
Locate the LCD projection TV at least 3-4 feet away from fluorescent lights.
Check the orientation of the batteries.

Dark, poor or no
picture (screen lit),
good sound

Adjust the Picture setting in the Video menu (see page 67).
Adjust the Brightness setting in the Video menu (see page 67).
Check antenna/cable connections.
It is strongly recommended to connect the antenna using a 75-ohm coaxial cable to get optimum picture quality. A 300-ohm twin lead cable can be easily affected by radio noise and the like, resulting in signal deterioration. If you use a 300-ohm twin lead cable, keep it away as far as possible from the LCD projection TV.
Do not use an indoor antenna because it is especially susceptible to radio noise (see page 25).

Good picture,
no sound

Press MUTING so that "MUTING" disappears from the screen (see page 45).
Make sure Speaker is set to ON in the Audio menu (see page 70).
Check the MTS setting in the Audio menu (see "MTS" on page 69).

Cannot receive digital channels
(when a DTV receiver is
connected)

Check the connections between the DTV receiver and the LCD projection TV (see page 39).
Check your local listings to find out if you can receive digital broadcasts in your area.

Cannot receive upper channels
(UHF) when
using an antenna

Change Cable to OFF (see page 73).
Use Auto Program in the Channel menu to add receivable channels that are not presently in TV memory (see page 73).

No color	Adjust the Color settings in the Video menu (see page 67).
Only snow and noise appear on the screen	Check the Cable setting in the Channel menu (see "Cable" on page 73). Check the antenna/cable connections. Make sure the channel is broadcasting programs. Press ANT to change the input mode (see page 47).
Dotted lines or stripes	Adjust the antenna. Move the LCD projection TV away from noise sources such as cars, neon signs, or hair-dryers.
LCD projection TV is fixed to one channel	Use Auto Program in the Channel menu to add receivable channels that are not presently in TV memory (see page 73). Check your Channel Fix settings (see page 73).
Double images, ghosts, or merged colors	Use a highly directional outdoor antenna or a cable (when the problem is caused by reflections from nearby mountains or tall buildings). Set the Image Revision to an appropriate value. The default setting is Auto. If ghosts, doubled images, or merged colors appear with Auto, select the best value from 0 to 3 (see page 81).
Cannot operate menu	If the item you want to choose appears in gray, you cannot select it. Turn the LCD projection TV's power off and on again.
Cannot receive any channels when using cable TV	Use Auto Program in the Channel menu to add receivable channels that are not presently in TV memory (see page 73). Check your cable settings. Make sure Cable is set to ON in the Channel menu (see page 73).
Cannot gain enough volume when using a cable box	Increase the volume of the cable box using the cable box's remote control. Then press FUNCTION until the TV indicator lights up and adjust the LCD projection TV's volume.
Channel Index does not display all available channels	Make sure Cable is set to ON in the Channel menu (see "Cable" on page 73). Use Auto Program in the Channel menu to add receivable TV channels that are not presently in TV memory (see page 73).
Cannot receive channels Unable to select a channel	Use Auto Program in the Channel menu to add receivable TV channels that are not presently in TV memory (see page 73).
Lost password	In the password screen (see page 75), enter the following master password: 4357. The master password clears your previous password; it cannot be used to temporarily unblock channels.
Cannot change channels with the remote control	Be sure you have not inadvertently switched your LCD projection TV from channel 3 or 4 setting if you are using another device to change channels. If you are using another device to control channels, be sure the "function" button for that device has been pressed, or the slide switch is set correctly. For example, if you are using your cable to control channels, be sure to press SAT/CABLE.
Cannot cycle through the other video equipment connected to the LCD projection TV	Be sure the Video Label feature has not been set to Skip (see page 80).

There is a black box on the screen	You have selected a text option in the Setup menu and no text is available. (see page 79 to reset Setup selections) To turn this feature off, select OFF in the Caption Vision option. If you were trying to get closed captioning, select CC1 instead of Text 1-4 .
There is no twin picture or it is just static	Be sure your twin picture is set to a video source/channel that has a program airing. You may be tuned to a video input with nothing connected to it. Try cycling through your video inputs using TV/VIDEO . Twin View is not set to receive a signal from the AUX input. If you have connected a VCR , DVD player or satellite receiver to the AUX input on the LCD projection TV , it will not show in the second picture.
You get the same program in the window picture as in the main picture	Both may be set to the same channel. Try changing channels in either the main picture or the window picture. You may be running all your channels through a cable box. The cable box will only unscramble one signal at a time, so you cannot use the Twin View feature. If possible, run a direct cable to your LCD projection TV 's VHF/UHF input (this will only work if your cable system provides an unscrambled signal.)
You cannot get anything but TV channels in your second picture	Be sure the video label has not been set to skip your video inputs. See the Setup menu on page 80.
Some video sources do not appear when you press TV/VIDEO	Ensure that Video Label is not set to "Skip" (see "Video Label" on page 80).
Image does not display	Make sure the image is supported by the LCD projection TV (see page 58). Make sure the Memory Stick is inserted properly (see page 60). Memory Stick functions are not available while using Twin View, Freeze or Favorite Channel functions.
Blank square appears instead of a thumbnail image	This indicates that the image does not support a thumbnail view. Selecting the icon, however, displays the full-size image on the screen. It could also indicate that both the thumbnail and full-size images are corrupted or not supported
Cannot rotate image, no thumbnail appears	Be sure the LOCK switch on the Memory Stick is set to off. If a blank square appears instead of the thumbnail image, this indicates that the image does not support a thumbnail view and cannot be rotated.
Cannot hear audio while using Memory Stick	There is no audio available while using Memory Stick.
Image file name does not appear; instead, dashes (---) appear	Dashes appear instead of the file name if the image was recorded using equipment that is not DCF -compliant. Dashes also appear if a DCF -compliant file was renamed.

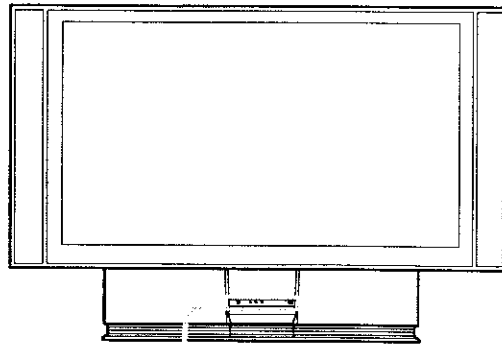

The **STAND BY** (red) and/or **LAMP** (red) indicators indicate the conditions of the LCD projection TV and warnings by lighting or flashing, as follows.

The **STAND BY** indicator lights.

- ↳ The lamp for the light source is ready to turn on.

The **STAND BY** indicator flashes.

- ↳ The lamp cover is not attached securely. When you correct, the **STAND BY** indicator goes out and the LCD projection TV enters the standby mode (see page 13).

The **LAMP** indicator flashes.

- ↳ The lamp for the light source burns out.
Replace it with new one (see page 13).

If the LCD projection TV is not recovered after correcting the problems, contact with qualified Sony personnel.

Projection System	3 LCD Panels, 1 lens projection system	
LCD Panel	1.35 inch TFT LCD panel Approx. 3.15 million dots (1,049,088 pixels)	
Projection Lens	High Performance, large diameter hybrid lens F2.4	
Antenna	75 ohm external terminal for VHF/UHF	
Lamp	UHP lamp, 100W XL-2000U	
Television System	NTSC, American TV Standard	
Screen Size (measured diagonally)	KF-50XBR800: 50 inches, KF-60XBR800: 60 inches	
Channel Coverage		
VHF	2-13	
UHF	14-69	
CATV	1-125	
Power Requirements	120V, 60 Hz	
Number of Inputs/Outputs		
DVI-HDTV	1 terminal, 3.3 V T.M.D.S., 50 ohms The DVI-HDTV input terminal is compliant with the EIA-861 standard and is not intended for use with personal computers.	
Video (IN)	4	1 Vp-p, 75 ohms unbalanced, sync negative
S Video (IN)	3	Y: 1 Vp-p, 75 ohms unbalanced, sync negative C: 0.286 Vp-p (Burst signal), 75 ohms
Audio (IN)	6	500 mVrms (100% modulation) Impedance: 47 kilohms
AUDIO (VAR/FIX)	1	500 mVrms at the maximum volume setting (Variable) 500 mVrms (Fixed) Impedance (output): 2 kilohms
MONITOR OUT	1	Video: 1 Vp-p 75 ohms unbalanced, Sync negative Audio: 500 mVrms (100% modulation) Impedance (output): 1 kilohms
CONTROL S (IN/OUT)	1	minijacks
Component Video Input	2 (Y, P _B , P _R)	Y: 1.0 Vp-p, 75 ohms unbalanced, sync negative P _B : 0.7 Vp-p, 75 ohms P _R : 0.7 Vp-p, 75 ohms
RF Inputs	2	
Converter	1	
Speaker Output	15 W × 2	
Dimensions (W × H × D)	KF-50XBR800: 1,376 × 964 × 415 mm (54 1/4 × 38 × 16 3/8 inches) KF-60XBR800: 1,618 × 1,103 × 542 mm (63 3/4 × 43 1/2 × 21 3/8 inches)	
Mass	KF-50XBR800: 50 kg (110 lb 4 oz), KF-60XBR800: 66 kg (145 lb 8 oz)	
Power Consumption		
In Use	220 W	

In Standby	Under 1 W
Supplied Accessories	
Remote Control	RM-Y912
AAA Batteries	2 supplied for remote control
Cleaning Cloth	1
Hex key wrench	1
Brackets with screws	2
Optional Accessories	
TV Stand	SU-GW1
Lamp	XL-2000U
AV Cable	VMC-810/820/830 HG
Audio Cable	RKC-515HG
Control S Cable	RK-G69HG
Component Video Cable	VMC-10/30 HG
AV Receiver	STR-V555ES or equivalent
Memory Stick media	8MB (MSA-8A), 16MB (MSA-16A), 32MB (MSA-32A), 64MB (MSA-64A), 128MB (MSA-128A)

Design and specifications are subject to change without notice.

Activating a Twin View screen **51**
Adding channels to the channel list **73**
Adjusting audio, Steady Sound **69**
ANT button **45**
Antenna, connecting **25**
Audio menu **66, 69**
Audio receiver, connecting **36**
Audio/Video cable **24**
Auto Program (channel setup) **44, 73**
Auto Setup **44, 73**
AV receiver, connecting to MONITOR OUT **23**

Balance, adjusting **69**
Bass, adjusting **69**
Batteries, inserting in remote **17**
Bilingual audio **69**
Brightness, adjusting **67**

Cable

connecting **25–28**
setting ON/OFF **73**
with VCR, connecting **29**

Cable box

connecting with VCR **30**
using with TV remote control **85**

Camcorder, connecting **41**

Caption Vision **79**

CATV. See Cable.

Channel list, adding channels **73**

Channel menu **66, 73**

Channel Skip/Add **74**

Channels

Auto Program **73**
creating labels **74**
setting up **44**

CineMotion **68**

Cleaning Cloth **12**

Closed caption modes **79**

Color temperature, adjusting **68**

Color, adjusting **67**

Connecting

Audio receiver **36**

Cable box **26–28, 30–31**

Cable or antenna **25**

Camcorder **41**

Digital TV Receiver **39**

DVD player **37, 38**

Satellite receiver **33–35**

VCR **30–32, 34**

Connector Types **24**

Contents of box **17**

CONTROL S **43**

Digital TV

connecting **39**

watching **49**

Digital TV program **49**

Digital TV receiver, connecting **39**

DISPLAY button **45**

Display, turning off **45**

DRC (Digital Reality Creation) Mode, described **9**

DVD player

using with TV remote control **84**

with A/V connectors, connecting **38**

with component video connectors, connecting **37**

Enlarging pictures, in Twin View **53**

Favorite Channel

described **10**

setting up **73**

using **50**

FAVORITES button **46**

Features **9**

FREEZE button **46**

Freeze, using **47, 54**

Front Panel Controls **21**

FUNCTION button **45**

Hookups **25**

Hue, adjusting **67**

Image Revision **81**
Inputs, labeling **80**
Installation of the projection TV **25–43**

JUMP button **45**
Jump, using **47**

Label
Channels **74**
video inputs **80**
Lamp, replacing **13–16**

Memory Stick
Index **62**
indicator (LED) **22**
inserting **60**
insertion slot **22**
Menu **61**
precautions **86**
Rotate Picture **65**
Setup Options **64**
Slideshow **64**
supported and unsupported Images **58**

MEMORY STICK button **46**

MENU button **46**

Menus
Audio **66, 69**
Channel **66, 73**
Screen **71**
Setup **66, 79**
Timer **81**
Video **66, 67**

MODE
Mild **48**
Movie **48**
Standard **48**
Vivid **48**

MTS/SAP button **46**
MTS/SAP, using **48**
Muting, using **47**

Parental control, described **9**
Password, changing **76**
Picture contrast, adjusting **67**
PICTURE MODE button **45**

Picture size, adjusting in Twin View **53**
POWER buttons (GREEN) **46**
Presetting channels **44**
Problems, troubleshooting **87–90**

Ratings
setting **76**
viewing blocked programs **76**
Rear panel controls and connections **23**

Remote control
Function of buttons **47**
inserting batteries **17**
programming **82–83**

Remote control, operating other components with
Cable box **85**
DVD player **84**
Satellite receiver **85**
VCR **84**

Removing channels from the channel list **74**

RESET button **46**

Resetting
Audio options **69**
Video options **67**

S Video cable **24**
SAT/CABLE function button **45**
SAT/CABLE power button **46**
Satellite receiver
connecting **33**
using with TV remote control **85**

Screen menu **71**
Setting up channels **44**
Setup menu **66, 79**
Sharpness, adjusting **67**
Specifications **91–92**
Steady Sound
adjusting **69**
Surround sound **69**

Timer
set current **81**
Timer menu **81**
Timer setting **81**
Treble, adjusting **69**
Troubleshooting **87–90**
TV function button **45**

TV power button **46**

TV/VIDEO button **46**

Twin View™

activating a picture **51**

described **9**

using **51**

VCR

using with TV remote control **84**

with cable box, connecting **30**

with cable, connecting **29**

with satellite receiver, connecting **34**

Video inputs, labeling **80**

Video menu **66, 67**

Video Modes, selecting **67**

Viewing area, recommended **20**

VOL +/- button **46**

W

WIDE MODE button **45**

Z

Zoom feature, with Twin View **53**

<http://www.sony.net/>
Printed in the U.S.A

