

LCD Projection TV



Operating Instructions _____

GB

- ⚠ Before operating the TV, please read the “Safety Information” section of this manual.
Retain this manual for future reference.

KF-55E200A
KF-50E200A
KF-42E200A

BRAVIA



Introduction

Thank you for choosing this Sony product.
Before operating the TV, please read this manual
thoroughly and retain it for future reference.

Trademark information

- Manufactured under license from BBE Sound, Inc.
Licensed by BBE Sound, Inc. under one or more of the
following US patents: 5510752, 5736897. BBE and BBE
symbol are registered trademarks of BBE Sound, Inc.
- TruSurround XT, SRS and  symbol are trademarks
of SRS Labs, Inc.
- TruSurround XT technology is incorporated under license
from SRS Labs, Inc.
- This TV incorporates High-Definition Multimedia
Interface (HDMI™) technology. HDMI, the HDMI logo
and High-Definition Multimedia Interface are trademarks
or registered trademarks of HDMI Licensing LLC.
- BRAVIA, Steady Sound, Digital Reality Creation and
CineMotion are trademarks of Sony Corporation.

BBE[®]
DIGITAL

SRS [®]
TruSurround XT



Table of Contents

Safety Information	4
Overview of the remote	7
Overview of the TV buttons and indicators	9

Start-up Guide

1: Installing the TV	11
Recommended Viewing Area.....	11
Carrying Your TV	11
Preventing the TV from Toppling Over.....	12
Installing the TV against a wall	12
2: Inserting batteries into the remote.....	13
3: Connecting an antenna/VCR	14
4: Switching on the TV	15
5: Selecting the language.....	16
6: Auto-programming the TV	16

Watching TV

Watching TV.....	18
TOOLS operation (for TV).....	20
Viewing pictures from connected equipment	21
TOOLS operation (for connected equipment).....	21
Twin Picture function	22

Using MENU Functions

Navigating through menus	23
Overview of the Settings menu options.....	24
Picture menu	26
Picture Mode	26
Display Mode	26
Reset	26
Advanced Iris	27
Picture/Brightness/Color/Hue	27
Color Temperature	27
Sharpness	27
Noise Reduction	28
DRC Mode	28
DRC Palette	28
Advanced Video	28
Sound menu	29
Sound Mode	29
Reset	29
Treble/Bass/Balance	29
Steady Sound	29

Volume Level	30
Effect	30
BBE	30
Speaker	30
Audio Out	30
Screen menu	31
Wide Mode	31
Auto Wide	31
4:3 Default	31
Display Area	32
Screen Shift	32
Vertical Size	32
Auto Adjustment	32
Phase/Pitch	32
Horizontal Center/Vertical Center	32
Program menu.....	33
Auto Program	33
Manual Program	33
1Digit Direct	34
Program Label	34
Program Block	34
Program Sorting	35
Setup menu	36
Game Mode	36
Power Management	36
Video Label	36
Language	36
Video2(Component)	37
Image Shift	37
Cooling Mode	37
Lamp Replacement	37
Cinema Drive	37
Color System	38
Initial Reset	38
Timer menu	39
Sleep Timer	39
On Timer	39

Using Optional Equipment

Connecting optional equipment	40
Programming the remote.....	43
Using other equipment with the remote.....	44

Additional Information

Replacing the lamp.....	46
Specifications	48
Troubleshooting.....	50
Index.....	54

Safety Information

To prevent fire or shock hazard, do not expose the LCD projection TV to rain or moisture. Dangerously high voltages are present inside the LCD projection TV. Do not open the cabinet. Refer servicing to qualified personnel only.

For general safety:

- Do not expose the LCD projection TV to rain or moisture.

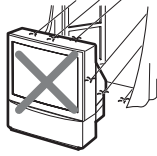

- Do not open the rear cover.



- This set should be operated only from the type of power source indicated on the serial/model plate. If you are not sure of the type of electrical power supplied to your home, consult your dealer or local power company.

For safe installation:

- Never cover the slots and openings with a cloth or other materials.

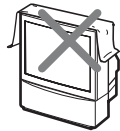

- Do not block the ventilation openings.
- Do not use power-line operated sets near water — for example, near a bathtub, washbowl, kitchen sink, swimming pool, etc.
- Do not install the LCD projection TV in hot, humid or excessively dusty places.

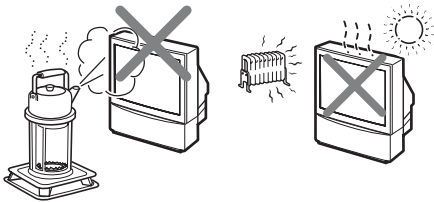

- Do not allow anything to rest on or roll over the power cord, and do not place the set where the power cord is subject to wear or abuse.
- Do not install the LCD projection TV where it may be exposed to mechanical vibrations.
- Avoid operating the LCD projection TV at temperatures below 5°C.

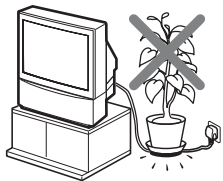

- If the LCD projection TV is transported directly from a cold to a warm location, or if the room temperature has changed suddenly, the picture may be blurred or show poor color. This is because moisture has condensed on the mirror or lenses inside. If this happens, let the moisture evaporate before using the LCD projection TV.
- Do not install the appliance in a confined space, such as a bookcase or built-in cabinet.

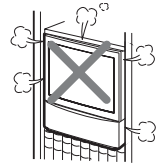

- Do not place the set on an unstable cart, stand, table or shelf. The set may fall, causing serious injury to a child or an adult and serious damage to the set. Use only a stand recommended by the manufacturer for the specific model of LCD projection TV. An appliance and cart combination should be moved with care. Quick stops, excessive force, and uneven surfaces may cause the appliance and cart combination to overturn.

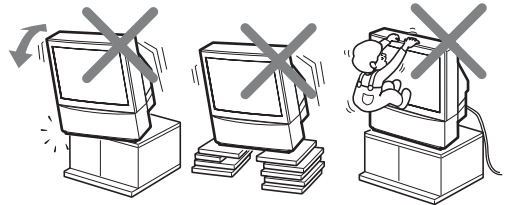

- When the set exhibits a distinct change in performance, it indicates a need for service.
- The TV should be installed near an easily accessible power outlet.

For safe operations:

- Do not operate the LCD projection TV on anything but 220-240 V AC, 50/60 Hz.
- Do not operate the LCD projection TV if any liquid or solid object falls in it — have it checked immediately.

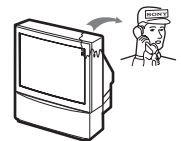

- Never push objects of any kind into the set through the cabinet slots as they may touch dangerous voltage points or short out parts that could result in a fire or electric shock. Never spill liquid of any kind on the set.
- Leave enough space between the LCD projection TV or furniture and an outlet so that you can plug in/out easily.
- Unplug the AC power cord during lightning storm.

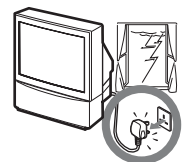
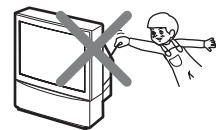

- Do not keep the LCD projection TV plugged in if you are not going to use it for several days. Even if your LCD projection TV is turned off, it is still connected to AC power when plugged into an outlet.

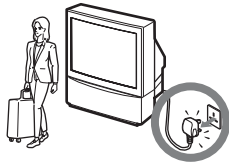

- Do not pull the power cord to disconnect the LCD projection TV. Pull it out by the plug.

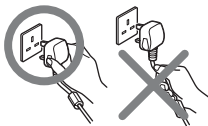

- Do not plug in too many appliances to the same power jack. Do not damage the power cord.

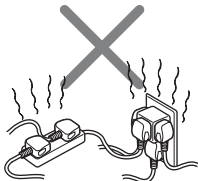

- Do not place any objects on the LCD projection TV. The apparatus shall not be exposed to dripping or splashing and that no objects filled with liquids, such as vases, shall be placed on the apparatus.

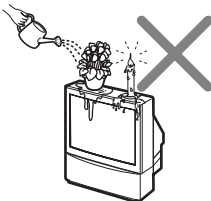

- To prevent fire, keep inflammable objects or naked lights (e.g. candles) away from the LCD projection TV.
- If a snapping or popping sound from a TV set is continuous or frequent while the TV is operating, unplug the TV and consult your dealer or service technician. It is normal for some TV sets to make occasional snapping or popping sounds, particularly when being turned on or off.
- Give careful consideration to the environment when disposing of batteries.
- Do not unplug or switch off the AC power outlet directly when the LCD projection TV is on.
- Always switch off by pressing  (power) on the remote or the projection TV first to ensure proper lamp cooling process.

When not in use

- If you will not be using the TV set for several days, the TV set should be disconnected from the outlet for environmental and safety reasons.
- The TV set is not disconnected from the outlet when the TV set is switched off.
- To disconnect the TV set completely, pull the plug from the outlet. However, some TV sets may have features which need the TV set to be left in standby to work correctly.

The instructions in this manual will inform you if this applies.

Carry the LCD projection TV in the specified manner

If you carry the LCD projection TV in a manner other than the specified manner and without the specified number of persons, it may drop and a serious injury may be caused. Be sure to follow the instructions mentioned below.

- Carry the LCD projection TV with the specified number of persons (see page 11).

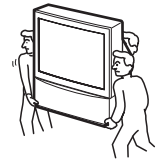

- Do not carry the LCD projection TV holding the speaker grill.
- Hold the LCD projection TV tightly when carrying it.
- Before carrying the LCD projection TV, disconnect any accessories or cables.
- Do not carry the LCD projection TV holding the screen edges.

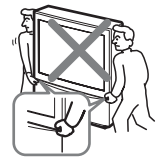

Caution

Do not use the LCD projection TV at altitudes higher than 4,000 m, as doing so might cause malfunctions.

Cleaning

Clean the rear cover area of the LCD projection TV regularly. Dust in rear cover area may cause a problem with the cooling system of the LCD projection TV set.

- To remove hard contamination, use a cloth moistened with a solution of mild detergent and water. Do not use a spray cleaning solution directly to the TV. It should only be used to moisten the cleaning cloth.
- Clean the cabinet of the LCD projection TV with a dry soft cloth. To remove dust from the screen, wipe it gently with a soft cloth. Stubborn stains may be removed with a cloth slightly dampened with a solution of mild soap and warm water. Never use strong solvents such as thinner or benzene for cleaning. If picture brightness decreases over time, it may be necessary to clean the inside of the LCD projection TV. Consult qualified service personnel.
- Unplug the AC power cord when cleaning this unit. If not, it may result in electric shock.
- Do not rub, touch, or tap the surface of the screen with sharp or abrasive items, like a ball point pen or a screw driver. This type of contact may result in a scratched screen.

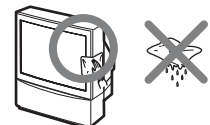

Continued

About the LCD projection TV

- Although the LCD projection TV is made with high-precision technology, black dots may appear or bright points of light (red, blue, or green) may appear constantly on the screen. This is a structural property of the panel and is not a malfunction.
- When High contrast non-moving images such as station logos and channel numbers are displayed for a long period of time, there may be some image retention on the screen. This is only a temporary condition. Turning off the power for a while or letting the TV run on another channel will eliminate the retained image.
- If direct sunlight or other strong illumination shines on the screen, part of the screen may appear white due to reflections from behind the screen. This is a structural property of the LCD projection TV.
Do not expose the screen to direct illumination or sunlight.

About the AC power cord

The shape of AC plug varies, depending on the regions.

Projection lamp

- Your LCD projection TV uses a projection lamp as its light source. It is time to replace the lamp with a new one (not supplied) when:
 - the message, “Projection lamp is nearing end of life. Please replace the lamp.” appears on the screen,
 - the lamp replacement indicator on the front panel blinks in red,
 - screen images become dark,
 - no image appears on the display after prolonged use.
- In rare instances, the bulb may pop inside the lamp unit, but the lamp unit is designed to contain all of broken glass pieces inside the lamp unit. (See “Replacing the lamp” on page 46.)
- When the lamp eventually burns out, you may hear a noticeable pop sound. This is normal and is inherent in this type of lamp.
- This television’s lamp contains mercury and should be disposed of properly. Consult your local authorities regarding safe disposal. If the lamp is broken during use, a small amount of mercury may be released. In this situation, move away from the product and ventilate the area. In case of accidental contact or inhalation, or if you feel unwell, consult a physician promptly.

Cooling fan

This LCD projection TV uses a cooling fan. You may hear some fan noise (depending on the placement of the LCD projection TV), which may be more noticeable during the night, or when ambient noise is particularly low.

Disposal of Old Electrical & Electronic Equipment (Applicable in the European Union and other European countries with separate collection systems)



This symbol is on the remote control and lamp.



Overview of the remote

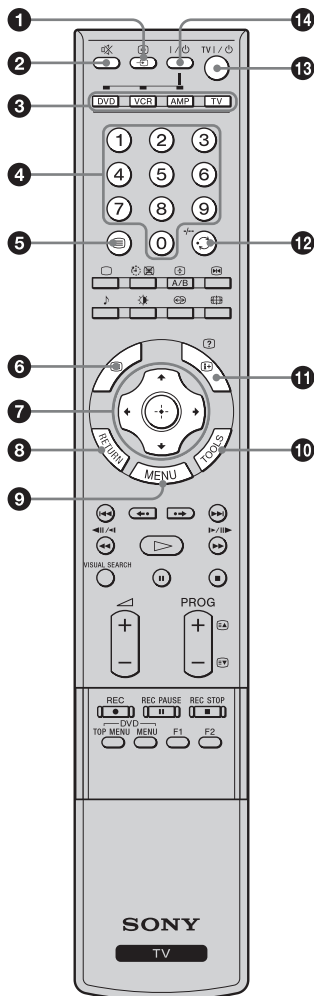

- 1** – **Input select / Text hold**
 In TV mode: Selects the input source from equipment connected to the TV jacks (page 21).
 In Text mode: Holds the current page (page 19).
- 2** – **Muting (page 18)**
 Mutes the sound.
- 3** **Function buttons (page 43)**

 - Selects the connected equipment you want to operate with this remote. The button of the equipment which the remote can operate lights up when operation buttons are pressed.
 - Used to program the remote to operate Sony video/audio equipment.
- 4** **Number buttons**
 In TV mode: Selects channels (page 18).
 In Text mode: Enters the three-digit page number to select the page (page 19).
- 5** – **Text (page 19)**
 Displays Text.
- 6**
 This button does not work with this model.
- 7** (page 23)
 Selects the item and setting when operating the TV menu.
- 8** **RETURN**
 Returns to the previous page when operating the TV menu.
- 9** **MENU (page 23)**
 Displays the TV menu which includes TV List, External Inputs, and Settings.
- 10** **TOOLS (page 20, 21)**
 Enables you to access various viewing options and change/make adjustments according to the source and screen mode.
- 11** – **Info / Text reveal**
 In TV mode: Displays information such as current channel number and screen mode (page 18).
 In Text mode: Reveals hidden information (e.g., answers to quizzes) (page 19).
- 12** – **Previous channel (page 18)**
 Returns to the previous channel watched (for more than five seconds).
 When operating DVD, it works as the “Execute” button (page 44).
- 13** – **TV standby (page 18)**
 Switches off the TV temporarily. The (standby) indicator on the front of the TV lights up. Press again to switch on the TV from the standby mode.
- 14** – **Power (page 44)**
 Switches the VCR, DVD, or audio equipment connected to the TV on or off.

Continued

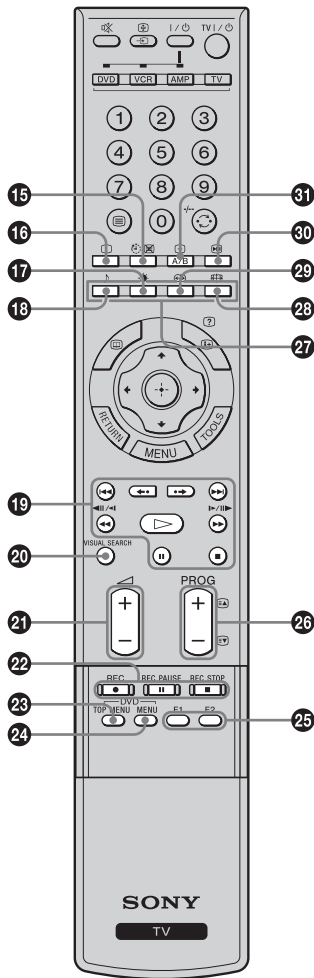

- 15** – **Sleep Timer (page 39)**
In TV mode: Activates Sleep Timer (page 39).
In Text mode: Stands by the Text page (page 19).
- 16** – **TV mode (page 19, 21)**
Exits Text mode, or returns to TV mode.
- 17** – **Picture mode (page 26)**
Selects the picture mode.
- 18** – **Sound mode (page 29)**
Selects the sound mode.
- 19** **DVD/VCR operating buttons (page 44)**
Operates the connected DVD and VCR.
- 20** **VISUAL SEARCH (page 45)**
Works with connected equipment which has the visual search function.
- 21** – **Volume (page 18)**
Adjusts the volume.
- 22** **DVD/VCR record buttons (page 44)**
REC: Records the source
REC PAUSE: Pauses recording
REC STOP: Stops recording
- 23** **DVD TOP MENU (page 44)**
Displays the top menu of the connected DVD equipment.
- 24** **DVD MENU (page 44)**
Displays the menu of a DVD.
- 25** **F1/F2 (page 45)**
Selects the function of connected equipment.
- 26** **PROG +/-/▲/▼ (page 18)**
In TV mode: Selects the next (+) or previous (-) channel (page 18).
In Text mode: Selects the next (+) or previous (-) page (page 19).
- 27** **Colored buttons**
In Text mode: Used for Fasttext (page 19).
- 28** – **Screen mode (page 20)**
Selects the type of the wide mode.
- 29** – **Surround (page 30)**
Selects the surround sound effect.
- 30** – **Picture Freeze (page 19)**
Freezes the current picture to display it on the left screen.
- 31** **A/B/□ – Text enlarge**
In TV mode: Switches the sound between stereo and mono, or languages in bilingual programs (page 18).
In Text mode: Switches the text size (page 19).

Tip

The PROG+, ▷ (Play), A/B and number 5 buttons have tactile dots. Use the tactile dots as references when operating the TV.

Overview of the TV buttons and indicators

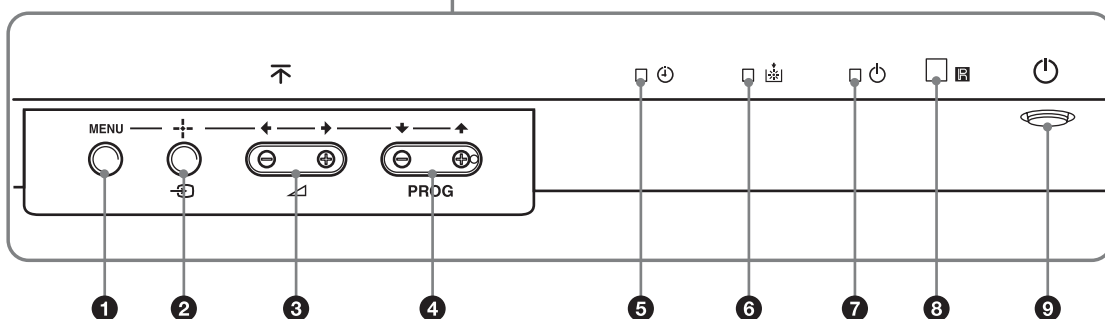
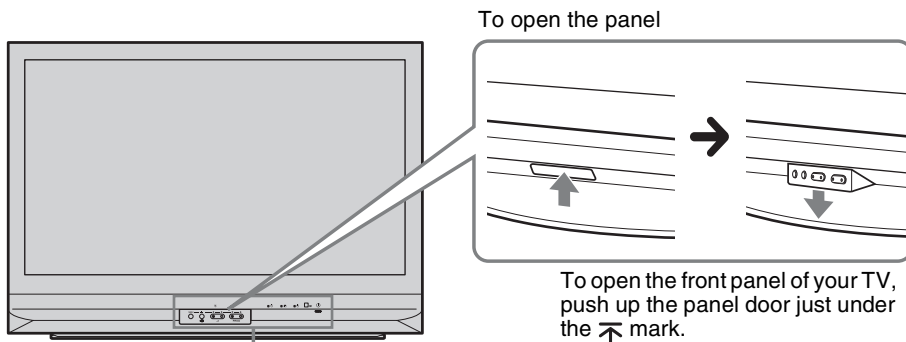

1 MENU (page 23)

Displays the TV menu.



Confirms the selection or setting.
Selects the video equipment connected to the TV's video inputs.

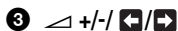

Increases (+) or decreases (-) the volume.
In TV menu: Moves through the options left (←) or right (→).

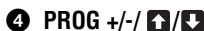

In TV mode: Selects the next (+) or previous (-) channel.
In TV menu: Moves through the options up (↑) or down (↓).

5  indicator (page 39)

Lights up in amber when the Sleep Timer/On Timer is set.

6  indicator

Flashes up in red when the lamp for the light source has burned out.

7  indicator

Flashes in green when the light source is preparing to turn on. Lights up in green when the TV is switched on.
Lights up in red when the TV is in standby mode. When the lamp door or the lamp itself is not securely attached, the red indicator will continue to flash in intervals of three blinks at a time (page 47).

8 Remote control sensor

Point the remote here.

9  (page 15)

Switches the TV on or off.

Continued

Projection Lamp

Your TV uses a projection lamp as its light source. As with any lamp, it has lifespan and needs to be replaced when the message, “Projection lamp is nearing end of life. Please replace the lamp.” appears on the screen, the lamp indicator flashes, or the screen becomes darker.

Notes

- After turning on your TV, it may take a while (1 minute or less) before the picture appears.
- When the projection lamp wears out, the screen goes dark. Replace the lamp with a new Sony XL-2400 replacement lamp (not supplied). How to replace the lamp, see page 46.
- After lamp is replaced, please set the “Lamp Replacement” option in the Setup Settings (page 37).

Warning

The light emitted from the lamp is quite bright when your TV is in use. To avoid eye discomfort or injury, do not look into the light housing when the power is on.

1: Installing the TV

Recommended Viewing Area

Your viewing position may affect the picture quality. For the best picture quality, install your TV within the areas shown below.

Model	Viewing distance
KF-42E200A	min. 1.8 m
KF-50E200A	min. 2.0 m
KF-55E200A	min. 2.1 m

Horizontal Viewing Area

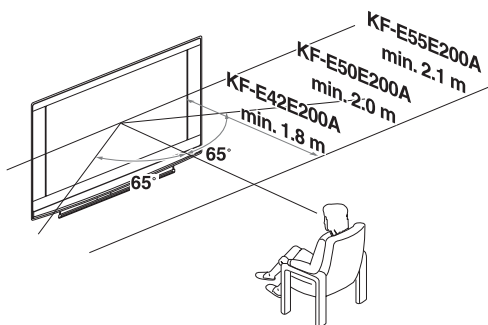

Vertical Viewing Area

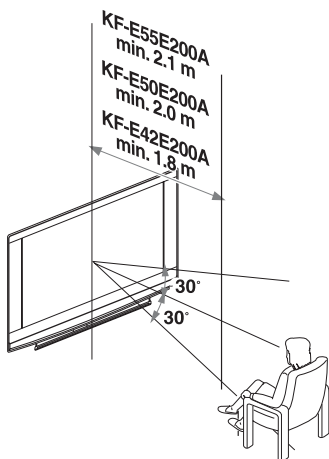

Carrying Your TV

Carrying the TV requires at least two people. Do not hold by the pedestal or the front panel of the TV. Doing so may cause these parts to break off.

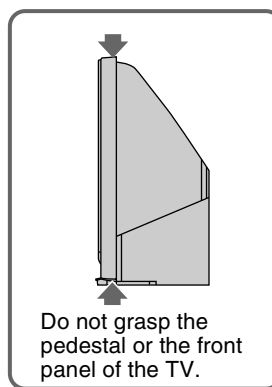

When moving the TV, place one hand in the hole on the lower portion of the TV while grasping the top with the other hand, as shown in the illustration below.

KF-42E200A

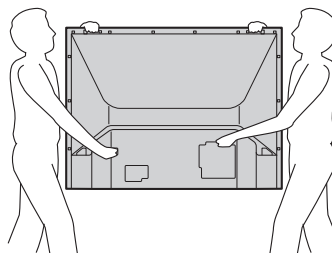

KF-50E200A/KF-55E200A

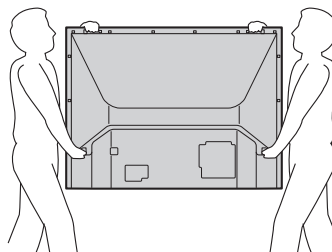

If you have connected cables and cords, be sure to unplug them before moving the TV.

Notes

- To ensure the safety of children and the TV, keep children away from the TV during installation. Climbing on or pushing the TV or its stand may cause it to fall and damage the TV.
- When installing your TV against a wall, keep your TV at least 10 cm away from the wall to provide proper ventilation.

Continued

Preventing the TV from Toppling Over

As a protective measure, secure the TV as follows.

Using the TV stand with support belts

Sony strongly recommends using the TV stand SU-RG11S (for KF-42E200A)/SU-RG11M (for KF-50E200A)/SU-RG12L (for KF-50E200A, KF-55E200A) with a support belt designed for your TV.

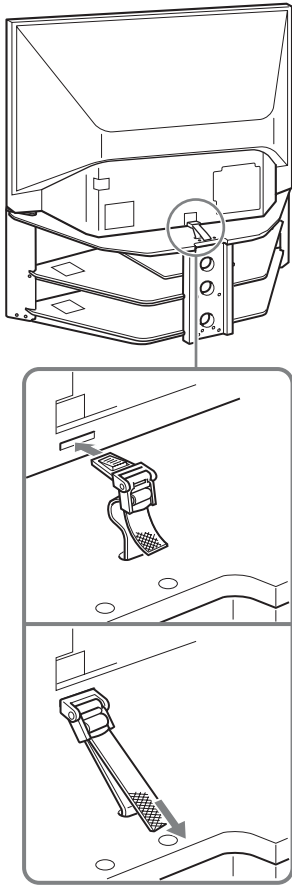

Note

When using the SU-RG11S for KF-42E200A (not supplied)/SU-RG11M for KF-50E200A (not supplied)/SU-RG12L for KF-50E200A, KF-55E200A (not supplied) stand for your TV, you must use the support belt.

Installing the TV against a wall

Keep the TV at least 10 cm away from the wall to provide proper ventilation.

Blocking the ventilation opening of the cooling fan may damage the TV.

Allow this much space

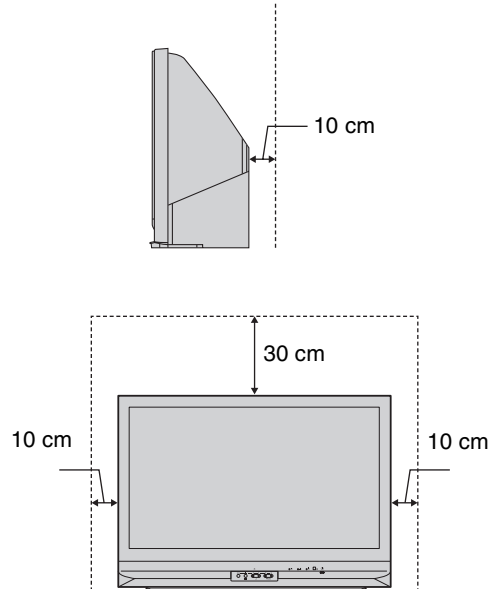

Never install the TV as follows

Air circulation is blocked

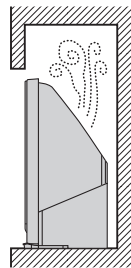

Warm air is blown to ventilation openings

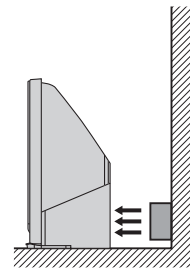

2: Inserting batteries into the remote

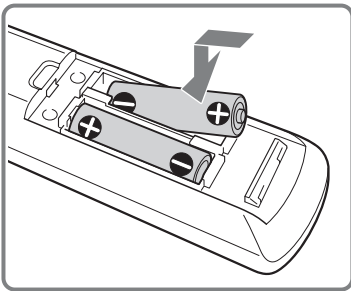
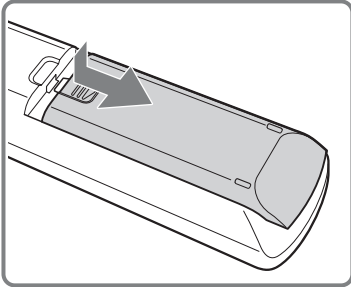

Notes

- Observe the correct polarity when inserting batteries.
- Dispose of batteries in an environmentally friendly way. Certain regions may regulate disposal of the battery. Please consult your local authority.
- Do not use different types of batteries together or mix old and new batteries.
- Handle the remote with care. Do not drop or step on it, or spill liquid of any kind onto it.
- Do not place the remote in a location near a heat source, or in a place subject to direct sunlight, or in a damp room.

3: Connecting an antenna/VCR

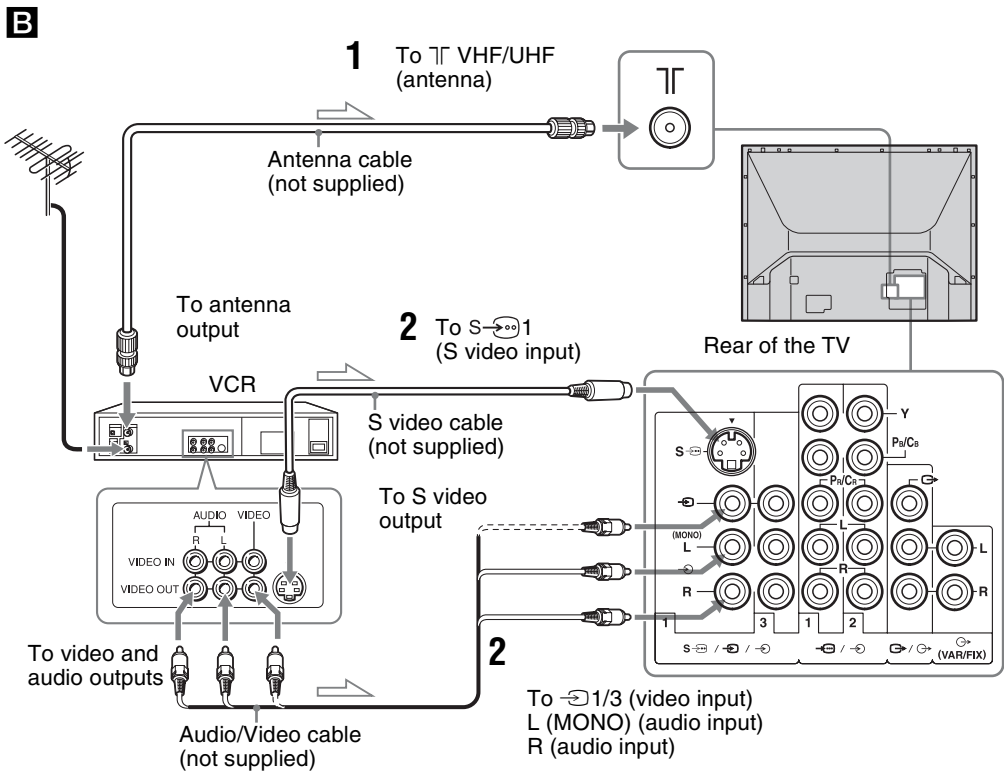
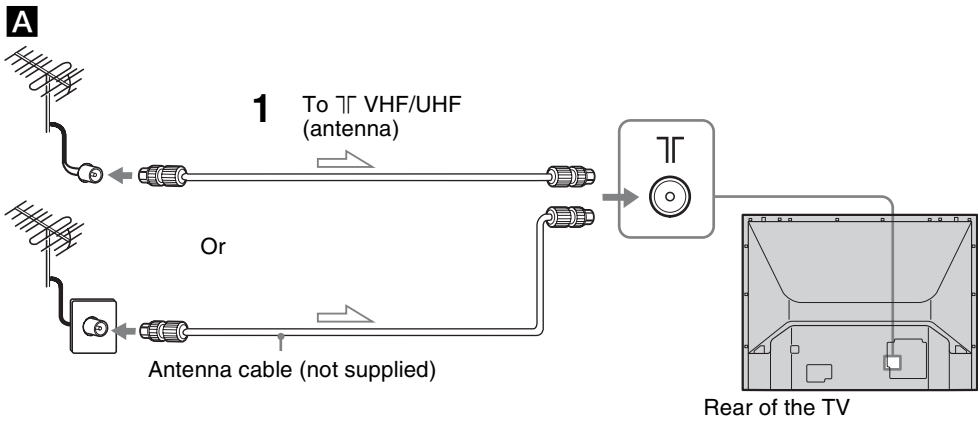

⇒ Signal flow

- 1 Connect your antenna with the antenna cable (not supplied).

If connecting to an antenna only (A)

Connect the male plug to the 7 VHF/UHF (antenna) jack on the rear of the TV.

Notes

- Note that one end of the cable has a male plug fitted while the other end is fitted with a female jack.
- Do not connect the power cord until all other connections are complete; otherwise, a minimal current leakage through the antenna and/or other terminals to the ground could occur.

If connecting to a VCR with an antenna (B)

Connect your antenna to the input jack on your VCR.

Notes

- If you connect a monaural VCR, connect the yellow plug to VIDEO (the yellow jack) and the black plug to AUDIO-L (MONO) (the white jack).
- If you connect a VCR to the 7 VHF/UHF (antenna) jack, preset the signal output from the VCR to the program number 0 on the TV.
- If the S video cable is connected to this TV and the VCR, the S video signal is automatically selected.

- 2 Connect your VCR.

Connect the output jack on your VCR to the input jack on the rear of the TV.

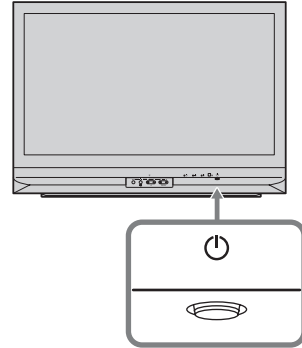

4: Switching on the TV



- 1 Connect the AC power cord to the AC power jack (220-240 V AC, 50/60 Hz).

- 2 Press  on the TV (front side).

When you switch on the TV for the first time, the language menu appears on the screen, then go to “5: Selecting the language” on page 16.

When the TV is in standby mode ( indicator on the front of the TV is red), press TV  on the remote to switch on the TV.

5: Selecting the language

When you switch on the TV for the first time, the language menu appears on the screen.

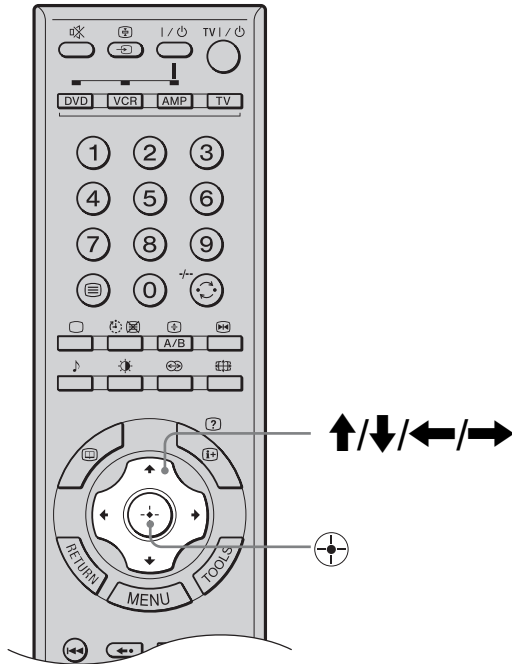

Press **↑/↓/←/→** to select the language displayed on the menu screens, then press **+**.



The message confirming that the TV starts auto program appears on the screen, then go to "6: Auto-programming the TV".

6: Auto-programming the TV

After selecting the language, a message confirming that the TV starts auto program appears on the screen. You must tune the TV to receive channels (TV broadcasts). Do the following to search and store all available channels.

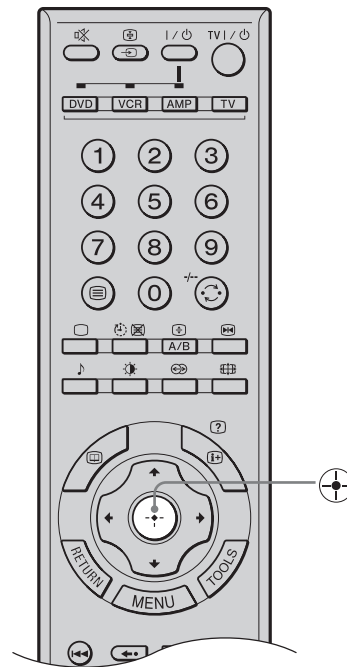

Press **+** to select "Yes".

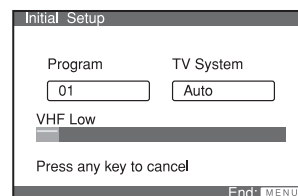
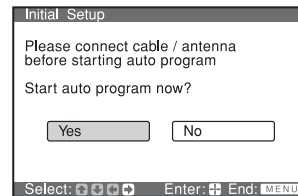

The TV starts searching for all available channels. This may take some time. Do not press any buttons on the TV or remote until it is completed. Once all available channels have been stored, the TV returns to normal operation, displaying the channel stored on channel number 1.

Tip

If you press any of the buttons during auto-programming, auto-programming operation is canceled. To perform auto-programming again, activate “Initial Reset” in the “Setup” menu (page 38).

When a message appears for you to confirm the antenna connections

No channels are found. Check all the antenna connections and press  to start auto-program again.

To change the order in which the channels are stored on the TV

See page 35.

Watching TV

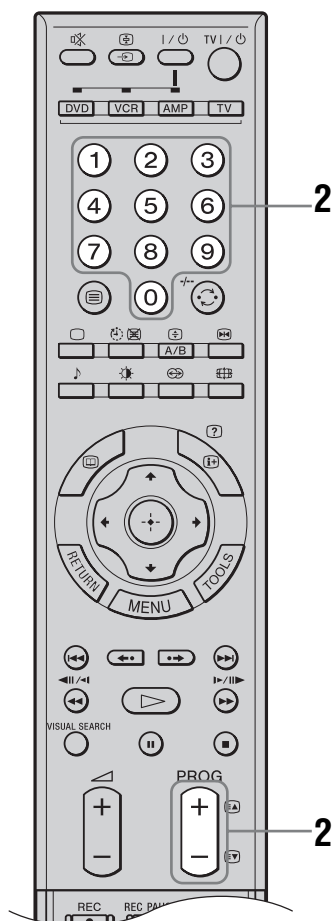
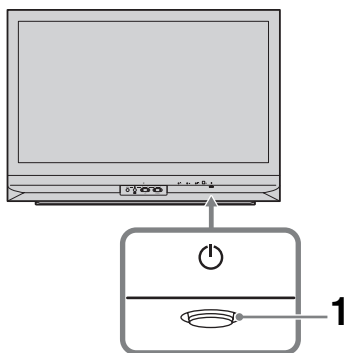

1 Press on the TV (front side) to switch on the TV.

When the TV is in standby mode (indicator on the front of the TV is red), press TV on the remote to switch on the TV.

2 Press the number buttons or PROG +/- to select a TV channel.

To select one-digit channel numbers, press 0 and the channel number.

Tips

- If you press the number button without pressing 0 to select a one-digit channel, you must wait for two seconds until receiving the channel.
- You can have one-digit channels selected immediately when you press the number buttons after setting “IDigit Direct” to “On” (page 34).

Additional operations

To	Do this
Turn off the TV temporarily (Standby mode)	Press TV .
Turn off the TV	Press on the front side of the TV.
Adjust the volume	Press + (increase) /- (decrease).
Mute the sound	Press . Press again to restore.
Return to the previous channel watched (for more than five seconds)	Press /-/-.
Select the surround sound effect	Press . For details, see page 30.
Switch the TV automatically to the standby mode after a specified time period – Sleep	Press . For details, see page 39.
Switch the sound between stereo and mono, or languages in bilingual programs	Press A/B/.
Display the on-screen information	Press / .

To access Text

Press . Each time you press , the display changes cyclically as follows:

Text → Text over the TV picture (mix mode) → No Text (exit the Text service)

To select a page, press the number buttons or PROG +/-.

To hold a page, press / .

To reveal hidden information, press / .

To change the text size, press A/B/ .

To have a Text page stand by while watching a TV program, press / .

To return to normal TV mode, press .

Tips

- Ensure that the TV is receiving a good signal, or some text errors may occur.
- Some TV channels broadcast a Text service. For information on the use of the service, select the index page (usually Text page 100).
- When four colored items appear at the bottom of the Text page, Fastext is available. Fastext allows you to access pages quickly and easily. Press the corresponding colored button to access the page.

To enjoy stereo or bilingual programs

Switches the sound of NICAM or A2 (German) stereo system.

Press A/B/ repeatedly until you receive the sound you want.

The sound will be indicated on the screen as follows.

Broadcasting	On-screen display
NICAM stereo	NICAM (stereo sound) ↑ Mono (regular sound)
NICAM bilingual	NICAM Main (main sound) ← ↓ NICAM Sub (sub sound) ↓ Mono (regular sound) —
NICAM monaural	NICAM Main (main sound) ↑ Mono (regular sound)
A2 (German) stereo	Mono (regular sound) ↑ Stereo (stereo sound)
A2 (German) bilingual	Main (main sound) ↑ Sub (sub sound)

Tips

- NICAM is receivable in following countries/regions. Hong Kong, Singapore, New Zealand, Malaysia, Thailand, etc.
- A2 (German) is receivable in following countries/regions. Australia, Malaysia, Thailand, etc.

Notes

- If the signal is very weak, the sound becomes monaural automatically.
- If the stereo sound is noisy when receiving a NICAM program, select “Mono”. The sound becomes monaural, but the noise is reduced.

If the sound of a monaural program is noisy or distorted

Press A/B/ to change the on-screen display from “Auto” to “Mono”.

Notes

- The “Mono” or “Auto” setting is memorized for each program position.
- You cannot receive a stereo broadcast signal when “Mono” is selected for the program position.

Picture Freeze

Freezes the TV picture (e.g. to make a note of a telephone number or recipe).

- 1 Press on the remote control.
- 2 Press again to return to normal TV mode.

Continued

To change the screen mode manually to suit the broadcast

Press  repeatedly to select Wide Zoom, Normal, Full or Zoom.

Wide Zoom*

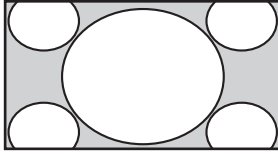

Enlarges the center portion of the picture. The left and right edges of the picture are stretched to fill the 16:9 screen.

Normal

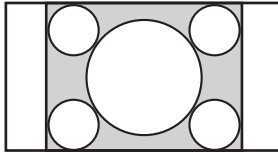

Displays the 4:3 picture in its original size. Side bars are shown to fill the 16:9 screen.

Note

You cannot select “Normal” when input signals are 720p/1080i/PC input (XGA/WXGA).

Full

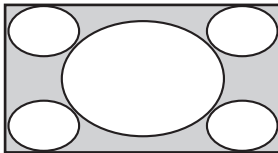

Stretches the 4:3 picture horizontally, to fill the 16:9 screen.

Zoom*

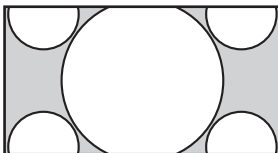

Displays cinemascopic (letter box format) broadcasts in the correct proportions.

* Parts of the top and bottom of the picture may be cut off.





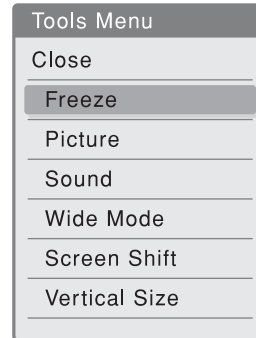

Tip

Alternatively, you can set “Auto Wide” to “On”. The TV will automatically select the best mode to suit the broadcast (page 31).

TOOLS operation (for TV)

You can access the following options quickly by pressing TOOLS. Available items differ depending on the screen mode and source.



Item	You can
Close	Close the Tools Menu.
Freeze	Freeze the screen (page 19).
Picture	Adjust picture (page 26).
Sound	Adjust sound (page 29).
Wide Mode	Select the screen mode (page 20).
Screen Shift	Adjust the screen position by pressing  /  /  /  (page 32).
Vertical Size	Adjust the picture size in vertical direction by pressing  /  (page 32). This menu appears only when the Zoom mode is selected.

Viewing pictures from connected equipment

Switch on the connected equipment, then press repeatedly until the correct input symbol (see below) appears on the screen.

On Screen Display	Input jacks
Video 1 or Video 1	Video : 1 (Rear) or Audio : 1 (Rear) L(MONO)/R
Video 2 or Video 2	Video : 2 (Side) Video : 2 (Side) Y, P _B /C _B , P _R /C _R Audio : 2 (Side) L(MONO)/R
Video 3	Video : 3 (Rear) Audio : 3 (Rear) L(MONO)/R
HD/DVD 1	Video : 1 (Rear) Y, P _B /C _B , P _R /C _R Audio : 1 (Rear) L/R
HD/DVD 2	Video : 2 (Rear) Y, P _B /C _B , P _R /C _R Audio : 2 (Rear) L/R
HDMI	Video/Audio : (Rear) HDMI IN Audio : (Rear) L/R
PC	Video : (Rear) PC (RGB) Audio : (Rear) PC

To return to normal TV mode, press .

Note

To view the picture from the component input on the side panel, select “Auto” in “Video2(Component)” in “Setup” menu (page 37).

TOOLS operation (for connected equipment)

You can access the following options quickly by pressing TOOLS. Available items differ depending on the screen mode and source.

For video input

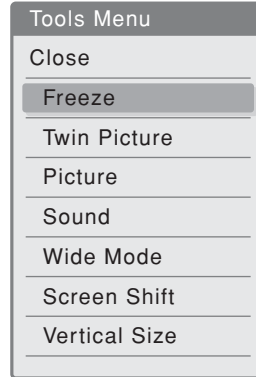

Item	You can
Close	Close the Tools Menu.
Freeze	Freeze the screen (page 19).
Twin Picture	Display two screens (page 22).
Full Screen (Appears in Twin Picture mode and Freeze mode)	Returns to Full Screen.
Picture	Adjust picture (page 26).
Sound	Adjust sound (page 29).
Wide Mode	Select the screen mode (page 20).
Screen Shift	Adjust the screen position by pressing / / / (page 32).
Vertical Size	Adjust the picture size in vertical direction by pressing / (page 32). This menu appears only when the Zoom mode is selected.

Continued

For PC input

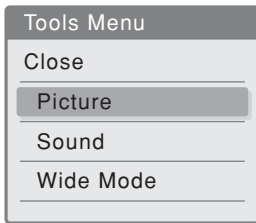

Item	You can
Close	Close the Tools Menu.
Picture	Adjust picture (page 26).
Sound	Adjust sound (page 29).
Wide Mode	Select the screen mode.

Twin Picture function

You can view two pictures (external input and TV program) on the screen simultaneously. This function is available when you view the picture from connected equipment.

Connect the optional equipment (page 40), and make sure that images from the equipment appear on the screen (page 21).

Notes

- This function is not available for a PC input source.
- You cannot change the window screen size of either picture.

Press **↑/↓** to select “Twin Picture” from the Tools menu, then press **+**. The picture from the connected equipment is displayed on the left and the TV program is displayed on the right.

To return to normal TV mode, press RETURN.

Tips

- You can also return to normal TV mode by selecting “Full Screen” from the Tools menu.
- You can hear the audio from the picture framed in green. You can switch the picture to hear the sound from the other picture by pressing **←/→**.
- You can switch the input source from the connected equipment by pressing **↶** on the left screen.
- You can select other TV channels by pressing the number buttons or PROG+/- on the right screen.



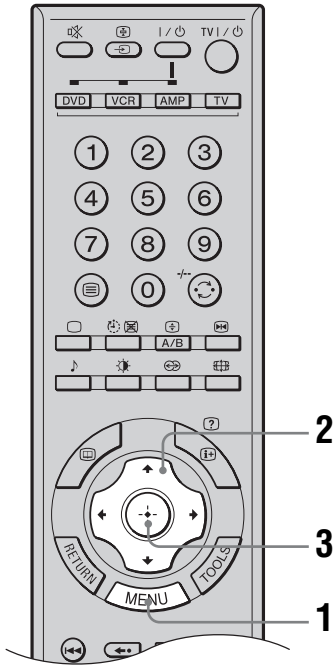

Navigating through menus

“MENU” allows you to enjoy various convenient features of this TV. You can easily select channels or inputs sources and change the settings for your TV.





1 Press  to display the menu.



Icon	Description
	TV List Assigns a channel name of your choice up to five letters or numbers (page 34).
	External Inputs <ul style="list-style-type: none"> • Selects equipment connected to your TV. To watch the desired external input, select the input source, then press . • Assigns a label to your equipment or skip unused inputs (page 36).
	Settings Displays the Settings menu where most of the advanced settings and adjustments are performed (page 24).
	Note The options you can adjust vary depending on the situation. Unavailable options are grayed out or not displayed.

2 Press  to highlight the option.

3 Press  to confirm a selected option. To exit the menu, press .

Overview of the Settings menu options

The following options are available in each menu.
Also, see page in parentheses for details of each menu.

Options for TV and video input

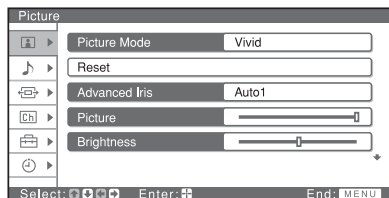

1 Picture

- Picture Mode (26)
- Reset (26)
- Advanced Iris (27)
- Picture/Brightness/Color/Hue (27)
- Color Temperature (27)
- Sharpness (27)
- Noise Reduction (28)
- DRC Mode (28)
- DRC Palette (28)
- Advanced Video (28)
 - Reset/Black Corrector/Gamma/Clear White/Live Color

2 Sound

- Sound Mode (29)
- Reset (29)
- Treble/Bass/Balance (29)
- Steady Sound (29)
- Volume Level (30)
- Effect (30)
- BBE (30)
- Speaker (30)
- Audio Out (30)

3 Screen

- Wide Mode (31)
- Auto Wide (31)
- 4:3 Default (31)
- Display Area (32)
- Screen Shift (32)
- Vertical Size (32)

4 Program

- Auto Program (33)
- Manual Program (33)
 - Program/TV System/Fine/Skip/VHF Low/VHF High/UHF
- 1Digit Direct (34)
- Program Label (34)
- Program Block (34)
- Program Sorting (35)

5 Setup

- Game Mode (36)
- Video Label (36)
- Language (36)
- Video2(Component) (37)
- Image Shift (37)
- Cooling Mode (37)
- Lamp Replacement (37)
- Cinema Drive (37)
- Color System (38)
- Initial Reset (38)

6 Timer

- Sleep Timer (39)
- On Timer (39)

Options for PC input

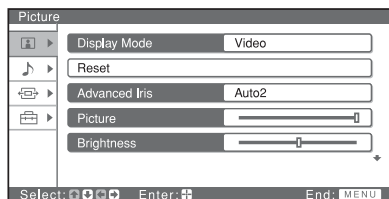

1 Picture

- Display Mode (26)
- Reset (26)
- Advanced Iris (27)
- Picture/Brightness (27)
- Color Temperature (27)

2 Sound

- Sound Mode (29)
- Reset (29)
- Treble/Bass/Balance (29)
- Effect (30)
- Speaker (30)
- Audio Out (30)

3 Screen

- Wide Mode (31)
- Auto Adjustment (32)
- Phase/Pitch (32)
- Horizontal Center/Vertical Center (32)

4 Setup

- Power Management (36)
- Video Label (36)
- Language (36)
- Image Shift (37)
- Cooling Mode (37)
- Lamp Replacement (37)

PC input signal compatibility chart

Signal	Resolution Horizontal (Pixel) × Vertical (Line)	Horizontal frequency (kHz)	Vertical frequency (Hz)	VESA standard
VGA	640 × 480	31.5	60	-*
	720 × 400	31.5	70	-*
SVGA	800 × 600	37.9	60	✓
XGA	1024 × 768	48.4	60	✓
WXGA	1280 × 768	47.4	60	✓
	1280 × 768	47.8	60	✓

* Corresponding to the VGA signal

Tips

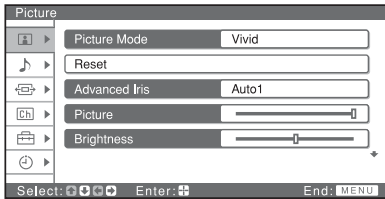

- This TV's PC input does not support Sync on Green or Composite Sync.
- This TV's PC input does not support interlaced signals.
- When signals of a type of other than those in the above chart are input to this TV, the message "Unsupported Signal" is displayed.
- XGA and WXGA signals will be down-converted and displayed at an equivalent resolution level of SVGA signal.

Picture menu





You can select the options listed below on the Picture menu.

To select options

- 1 Press .
- 2 Press \uparrow/\downarrow to select , then press \oplus .
- 3 Press \uparrow/\downarrow to select , then press \oplus .
- 4 Press \uparrow/\downarrow to highlight the option, then press \oplus .

Tip

The available options differ depending on the “Picture Mode” setting and input source.

-  indicates the available options for TV.
-  indicates the available options for video input.
-  indicates the available options for PC input.

Picture Mode

Selects the picture mode.

Press \uparrow/\downarrow to select one of the following picture modes, then press \oplus .

Vivid: Enhanced picture contrast and sharpness.

Standard: Standard picture settings recommended for home entertainment.

Custom: Professional monitor-like appearance settings.

Tip

You can also change the picture mode by pressing  repeatedly.

Display Mode

Selects the optimum display mode for video or text source.

Press \uparrow/\downarrow to select one of the following display modes, then press \oplus .

Video: Optimized to view video images.

Text: Optimized to view text, charts, or tables.

Reset

Resets the picture settings, except the “Advanced Video” setting, to the factory settings.

Press \leftarrow/\rightarrow to select “Ok”, then press \oplus .

Advanced Iris TV Video PC

By selecting the iris option, you can obtain the best brightness and contrast suited for your TV viewing.

Press **↑/↓** to select one of the following, then press **⊕**.

Auto1*: Recommended option for viewing programs that have larger variation in brightness from scene to scene.

Auto2*: Recommended option for viewing programs that have less variation in brightness from scene to scene.

High: With this option, the screen has maximum level of brightness. It is suitable for TV viewing in a brightly lit room.

Medium: With this option, the brightness is about the standard level.

Low: With this option, the screen is dimmed but contrast is at a maximum. It is suitable for TV viewing in a room with low lighting.

* Automatically detects the brightness of the screen.

These options are best suited for programs such as movies that often change between bright scenes and low light setting scenes.

Notes

- You cannot select an option other than “Auto1” when “Picture Mode” in the “Picture” menu is set to “Vivid”.
- You cannot select “Auto1” or “Auto2” when “Display Mode (only appears for PC input)” in the “Picture” menu is set to “Text”.

Picture/Brightness TV Video PC **/Color/Hue** TV Video

“Picture” increases picture contrast (the color becomes deeper), or decreases it (the color becomes softer).

“Brightness” brightens or darkens the picture.

“Color” increases or decreases color intensity.

“Hue” increases or decreases the green tone.

1 Press **⊕** to select the option.

2 Press **↑/↓** to set the level, then press **⊕**.

Tip

“Hue” cannot be adjusted on PAL or SECAM color system.

Color Temperature TV Video PC

Changes the color tone of the picture.

Press **↑/↓** to select one of the following, then press **⊕**.

Cool: Gives the white colors a blue tint.

Neutral: Gives the white colors a neutral tint.

Warm1/Warm2: Gives the white colors a red tint. Warm2 is redder than Warm1.

Tip

“Warm1/Warm2” only appears and can be adjusted if “Picture Mode” is set to “Custom”.

Sharpness TV Video

Sharpens or softens the picture.

Press **←/→** to set the level, then press **⊕**.

Noise Reduction

Reduces the picture noise (snowy picture) in a weak broadcast signal.

Press **↑/↓** to select one of the following, then press **⊕**.

Auto: Automatically reduces the picture noise.

High/Medium/Low: Modifies the effect of the noise reduction.

Off: Turns off the noise reduction feature.

Note

This option cannot be used in Twin Picture, Picture Freeze mode.

DRC Mode

Selects the density adjustment according to the source.

Press **↑/↓** to select one of the following, then press **⊕**.

High Density: Creates a high-resolution picture with four times density. Recommended for high quality sources such as DVD.

Progressive: Recommended for moving pictures.

Off: Deactivates the DRC Mode.

Notes

- This option cannot be used in Twin Picture, Picture Freeze mode.
- This option cannot be used for 480p, 576p, 720p, and 1080i sources.
- This option cannot be used when “Game Mode” is “On” (page 36).

DRC Palette

Allows you to customize the level of detail (Reality) and smoothness (Clarity) using the DRC palette displayed on the screen.

Press **↑/↓** to adjust Reality, or **←/→** to adjust Clarity, then press **⊕**.

Notes

- This option cannot be used in Twin Picture, Picture Freeze mode.
- This option cannot be used for 480p, 576p, 720p, and 1080i sources.
- This option cannot be used when “Noise Reduction” is “Auto” (page 28).
- This option cannot be used when “DRC Mode” is “Off” (page 28).
- This option cannot be used when “Game Mode” is “On” (page 36).

Advanced Video

You can adjust the following options.

“Reset” resets the settings of the options in “Advanced Video” to the factory settings.

“Black Corrector” enhances the contrast performance.

“Gamma” adjusts light and dark balance.

“Clear White” emphasizes the whiteness of the picture.

“Live Color” improves the vividness of colors.

1 Press **↑/↓** to select an option, then press **⊕**.

2 Press **↑/↓** to select a setting, then press **⊕**.

Black Corrector: High/Medium/Low/Off

Gamma: Max/High/Medium/Low/Off

Clear White: High/Low/Off

Live Color: High/Medium/Low/Off

Tip

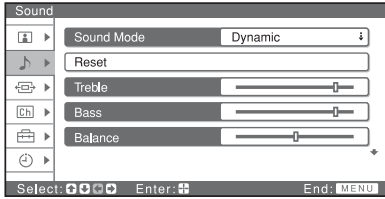

This option cannot be selected when “Picture Mode” is set to “Vivid” or “Standard”.

Sound menu



You can select the options listed below on the Sound menu.

To select options

- 1 Press .
- 2 Press \uparrow/\downarrow to select , then press \oplus .
- 3 Press \uparrow/\downarrow to select , then press \oplus .
- 4 Press \uparrow/\downarrow to highlight the option, then press \oplus .

 indicates the available options for TV.

 indicates the available options for video input.

 indicates the available options for PC input.

Note

You cannot operate the Sound menu when headphones are connected.

Sound Mode

Selects the sound effects.

Press \uparrow/\downarrow to select one of the following sound effects, then press \oplus .

Dynamic: Enhances treble and bass.

Standard: For standard sound. Recommended for home entertainment.

Custom: Flat response. Also allows you to store your preferred settings.

Tip

You can also change the sound mode by pressing  repeatedly.

Reset

Resets the sound settings, except the “Sound Mode” setting, to the factory settings.

Press \uparrow/\downarrow to select “Reset”, then press \oplus .

Treble/Bass/Balance

Adjusts higher-pitched sounds (Treble), adjusts lower-pitched sounds (Bass), and emphasizes left or right speaker balance (Balance).

1 Press \oplus to select the option.

2 Press \leftarrow/\rightarrow to set the level, then press \oplus .



Steady Sound

Keeps a constant volume level even when volume level gaps occur (e.g., advertisements tend to be louder than programs).

Press \uparrow/\downarrow to select “On”, then press \oplus .

Volume Level

Decreases or increases the sound level.

Press / to set the level, then press .

Effect

Provides the surround sound effect.

Press / to select one of the following sound effects, then press .

TruSurround XT: Adds a surround effect based on TruSurround technology (for stereo programs only).

Dialog Clarity: Adds a sound effect that makes the human voice clearer.

Simulated: Adds a surround-like effect to mono programs.



Off: For normal stereo or mono reception.

Tips

- The simulated function is using SRS 3D Mono.
- You can also select the surround sound effect by pressing  repeatedly.

BBE

Gives sound impact by compensating for the phase effects in speakers.

Press / to select one of the following, then press .



High: The sound is reproduced with more impact.

Low: The sound is reproduced with impact.

Off: For normal stereo or mono reception.

Speaker

Switches the TV's internal speakers on/off.



Press / to select "On" or "Off", then press .

On: The sound of the TV is output through the TV's speakers.

Off: No sound is output through the TV's speakers. Select "Off" when you want to hear the sound only through the external audio equipment connected to the audio output jacks .

Audio Out

Sets the method used to adjust the volume from the connected audio system. This option can be selected only when "Speaker" is set to "Off".

Press / to select one of the following, then press .

Variable: The audio output level from the connected audio system can be controlled by the TV's remote.





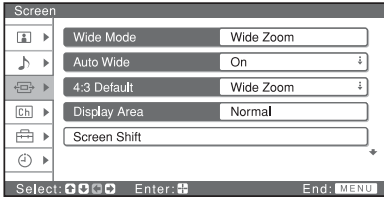



Fixed: The audio volume is fixed on the TV. Adjust the volume (and the audio settings) on the audio system.

Screen menu



You can select the options listed below on the Screen menu.

To select options

- 1 Press .
- 2 Press  to select , then press .
- 3 Press  to select , then press .
- 4 Press  to highlight the option, then press .

 indicates the available options for TV.

 indicates the available options for video input.



 indicates the available options for PC input.

Note

You cannot operate the Screen menu in Twin Picture or Picture Freeze mode.

Wide Mode

Selects the wide mode manually. For details about the wide mode, see page 20.

Press  to select “Wide Zoom”, “Normal”, “Full” or “Zoom” (see page 20 for details), then press .

Note



You cannot select “Normal” when input signals are 720p/1080i/PC input (XGA/WXGA).

Tip

You can also select the wide mode manually by pressing  repeatedly.

Auto Wide

Automatically changes the screen format according to the broadcast signal.

Press  to select “On”, then press .

To keep your setting, select “Off”.

Note



You cannot change “Auto Wide” setting when input signals are 720p/1080i.

Tip

Even if you have selected “On” or “Off” in “Auto Wide”, you can always modify the format of the screen by pressing  repeatedly.

4:3 Default

Sets the way to enlarge the 4:3 picture to fill the 16:9 screen.

Press  to select one of the following, then press .

Wide Zoom: Enlarges the 4:3 picture to fill the 16:9 screen, keeping the original image as much as possible.

Normal: Returns the 4:3 picture to its original size.

Full: Enlarges the 4:3 picture horizontally only.

Zoom: Displays cinematic (letter box format) broadcasts in the correct proportions.

Off: Continues using the current Wide Mode setting when the channel or input is changed.

Note

You cannot select “Normal” when input signals are 720p/1080i.

Display Area **TV** **Video**

Enlarges the screen slightly.

Press **↑/↓** to select “-1”, or “-2” to enlarge more, then press **+**.

To restore the original size, select “Normal”.

Screen Shift **TV** **Video**

Adjusts the screen position horizontally and vertically, however, vertical adjustment is available only in Zoom mode.

Press **↑/↓** to adjust the vertical position, or **←/→** to adjust the horizontal position, then press **+**.

Tip

You can access this option quickly by pressing TOOLS.

Vertical Size **TV** **Video**

Adjusts the vertical size of the picture in Zoom mode.

Press **↑/↓** to adjust the size, then press **+**.

Tip

You can access this option quickly by pressing TOOLS.

Auto Adjustment **PC**

Adjusts the display position of the picture automatically.

Press **←** to select “Ok”, then press **+**.

To cancel this operation, select “Cancel”.

Phase/Pitch **PC**

“Phase” adjusts the phase to reduce flickering of the screen.

“Pitch” adjusts the pitch to make unwanted vertical stripes disappear.

1 Press **+** to select the option.

2 Press **↑/↓** to improve the screen appearance, then press **+**.

Horizontal Center/Vertical Center **PC**

“Horizontal Center” adjusts the horizontal position of the picture.

“Vertical Center” adjusts the vertical position of the picture.

1 Press **+** to select the option.

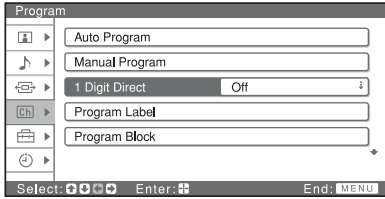

2 Press **↑/↓** to adjust the position, then press **+**.

Program menu



You can select the options listed below on the Program menu.

To select options

- 1 Press .
- 2 Press \uparrow/\downarrow to select , then press \oplus .
- 3 Press \uparrow/\downarrow to select , then press \oplus .
- 4 Press \uparrow/\downarrow to highlight the option, then press \oplus .

 indicates the available options for TV.

Auto Program

Tunes in all the available channels.

Usually you do not need to perform this operation because the channels are already tuned in when the TV is first installed (page 16). However, this option allows you to repeat the process (e.g., to retune the TV after moving house, or to search for new channels that have been launched by broadcasters).

Follow the operation of “6: Auto-programming the TV” (page 16).

When all available channels have been tuned in, the TV returns to normal operation.

Manual Program

Allows you to preset, adjust, skip, and tune in channels manually.

Press \uparrow/\downarrow to select one of the following options, then press \oplus .

Option	Description
Program	Presets channels manually.
TV System	<ol style="list-style-type: none"> 1 Press \uparrow/\downarrow to select “Program”, then press \oplus. 2 Press \uparrow/\downarrow to select the program number you want to manually tune in, then press \leftarrow. 3 Press \uparrow/\downarrow to select “TV System”, then press \oplus. 4 Press \uparrow/\downarrow to select the best received TV broadcast systems, then press \leftarrow. Repeat the procedure above to preset other channels manually. 5 Press .
Fine	<p>Fine-tunes the selected program number manually if you feel that a slight tuning adjustment will improve the picture quality. (Normally, fine tuning is performed automatically.)</p> <p>Press \uparrow/\downarrow to adjust the fine tuning, then press \oplus.</p> <p>To restore automatic fine tuning, select “Auto”.</p>

Continued

Option	Description
Skip	Skips unused channels when you press PROG +/- to select channels. (You can still select a skipped channel using the number buttons.) Press ↑/↓ to select "On", then press ⊕ . To restore a skipped channel, select "Off".
VHF Low/ VHF High/ UHF	Tunes in a channel manually. Press ←/→ until the desired channel's broadcast appears on the TV screen, then press ⊕ . Tip The frequency range indication (VHF Low, VHF High, or UHF) switches automatically as you keep pressing ←/→ . Note If the TV reception is not satisfactory, adjust the above options.

1Digit Direct TV

Setting "1Digit Direct" to "On", you can switch the channel to the one assigned to a number button as soon as you press the button. To enjoy the benefit of this feature, assign the channels you frequently watch to the program positions which are equivalent to the number buttons using "Program Sorting" (page 35).

Press **↑/↓** to select "On", then press **⊕**.

Tip

If there are many two-digit channels and you select them using the number buttons, select "Off".

Program Label TV

Assigns a channel name of your choice up to five letters or numbers. The name will be displayed briefly on the screen when the channel is selected.

- 1 Press **↑/↓** to select the channel you want to name.
- 2 Press **←/→** to select the position to input a character, **↑/↓** to select the desired letter or number.
- 3 Repeat the procedure in step 2 until the name is complete, then press **⊕**.







Program Block TV

Blocks an individual channel from being watched.

- 1 Press **↑/↓** to select the channel you want to block, then press **⊕**.
- 2 Press **↑/↓** to select "Block", then press **⊕**.
To watch the channel, select "Allow".

Program Sorting

Channels are assigned to the program positions sequentially when they are tuned in during auto-programming. “Program Sorting” allows you to replace the channel assigned to a program position with another channel.

- 1** Press / to select the channel you want to assign to another program position, then press .
 - 2** Press / to select the program position you want to assign the channel to, then press .
- Repeat the procedure in steps 1 and 2 to reassign other channels, if required.

Setup menu

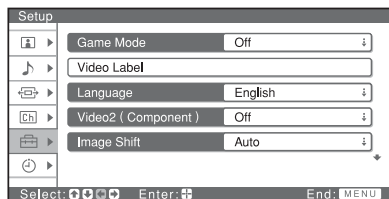

You can select the options listed below on the Setup menu.

To select options

- 1 Press .
- 2 Press to select , then press .
- 3 Press to select , then press .
- 4 Press to highlight the option, then press .

- indicates the available options for TV.
- indicates the available options for video input.
- indicates the available options for PC input.

Game Mode

The TV is optimized for playing games.

Press to select "On".

Power Management

Switches to standby mode when there is no signal input for 10 minutes.

Press to select "On", then press .

Tip

"TV will turn off soon" appears on the screen one minute before the TV switches to standby mode.

Video Label

Assigns a name (jack number or equipment type) to the equipment connected to the side and rear jacks. The name will be displayed briefly on the screen when the equipment is selected.

- 1 Press to select the jack you want to name, then press .
- 2 Press to select a desired name, then press .
- 3 Repeat steps 1 and 2 to name other jacks.

Tip

To make the jack that no equipment is connected not to be displayed, select "Skip" in step 2.

Language

Selects the language in which the menus are displayed.

Press to select the language, then press .

All menus will appear in the selected language.

Video2(Component) TV Video

Selects the type of the video jack to be used from those on the left side of the TV.

Press **↑/↓** to select one of the following, then press **+**.

Auto: Activates the component video jacks (Y, Pb/Cb, Pr/Cr), however, the composite video jack is selected when the component video jacks are not connected.

Off: Activates the composite video jack (**→**).

Image Shift TV Video PC

Corrects the image on your TV.

Before adjusting

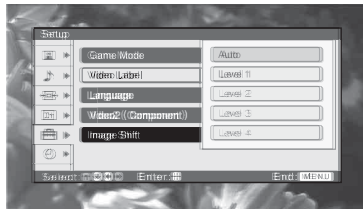

After adjusting



Auto (Factory setting): Automatically corrects double images.

Level 1-4: Aligns the images and improve the picture. The adjusted value tends to move strongly away from Level 1, and towards Level 4.

Cooling Mode TV Video PC

Selects "High" when you use the TV at an altitude of 1,500 m or higher.

Select "Normal" to use the TV at normal altitudes.

Press **↑/↓** to select "High", then press **+**.

Lamp Replacement TV Video PC

Selects this option after you replace the lamp.

When the lamp nears the end of its life, a message appears every time you switch on the TV.

Press **←/→** arrow to select "Yes", then Press **+**.

Follow the on-screen procedure.

Notes

- Depending on environmental and other conditions, such as frequency of use, some lamps may burn out before the lamp replacement message appears on the screen.
- Until you set the Lamp Replacement option, a message announcing that the lamp is at the end of its life will appear every time you switch on the TV.

Cinema Drive TV Video

Provides an optimized display by automatically detecting the film content. Moving pictures will appear clearer and more natural-looking.

Press **↑/↓** to select "Auto", then press **+**.

Tip

You can select this option for NTSC system pictures only.

Color System **TV** **Video**

Sets the color system of the TV to that of the source you want to play back.

Press **↑/↓** to select the color system, then press **⊕**.

Usually select “Auto” so that an appropriate color system for the source is selected automatically.

Initial Reset **TV** **Video**

Resets all the manual settings to the factory settings.









Press **←** to select “Ok”, then press **⊕**. Repeat this operation once more.

Timer menu



You can select the options listed below on the Timer menu.

To select options

- 1 Press .
- 2 Press  to select , then press .
- 3 Press  to select , then press .
- 4 Press  to highlight the option, then press .



indicates the available options for TV.





indicates the available options for video input.



indicates the available options for PC input.



Sleep Timer

Sets a period of time after which the TV automatically switches itself into standby mode.

Press  to select the desired time period in minute (“15M”/“30M”/“45M”/“60M”/“90M”/“120M”), then press .

The  (Timer) indicator on the TV (front side) lights up in amber.

Tips

- You can set the sleep timer by pressing  repeatedly.
- If you switch off the TV and switch it on again, “Sleep Timer” is reset to “Off”.
- “TV will turn off soon” appears on the screen one minute before the TV switches to standby mode.
- If you press , the remaining time in minutes before the TV switches to standby mode is displayed on the screen.

On Timer



Sets a time when the TV automatically switches itself on.

1 Press  to select “Timer Set”, then press .

2 Press  to select “On”, then press .

The  (Timer) indicator on the TV (front side) lights up in amber.

3 To set the time, press  to select “Time”, then press .

4 Set the hour using , then press .

5 Set the minute using , then press .

Tips

- To cancel the on-timer setting, select “Off” in step 2.
- You can set the on-timer in 10-minute increment for up to 12 hours later.
- If the TV is not operated for two hours after it is turned on by the on-timer, the TV automatically switches itself to standby mode.

Connecting optional equipment

You can connect a wide range of optional equipment to your TV.
Connect the cables, matching the colors of the plugs with those of the jack.

Connecting to the side/rear of the TV

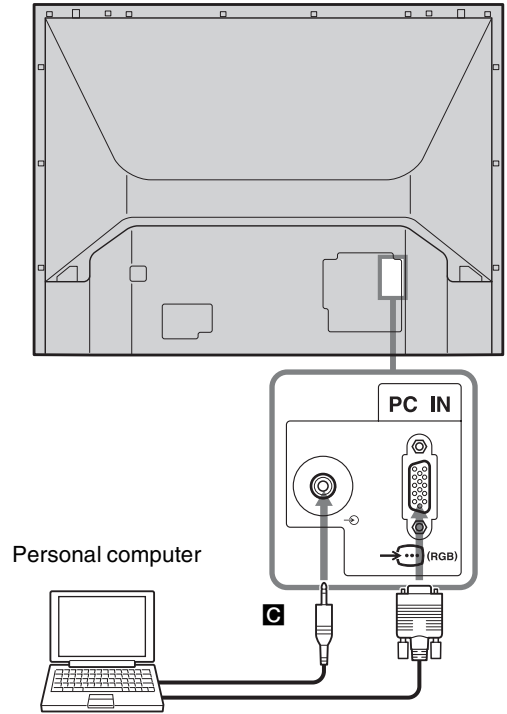
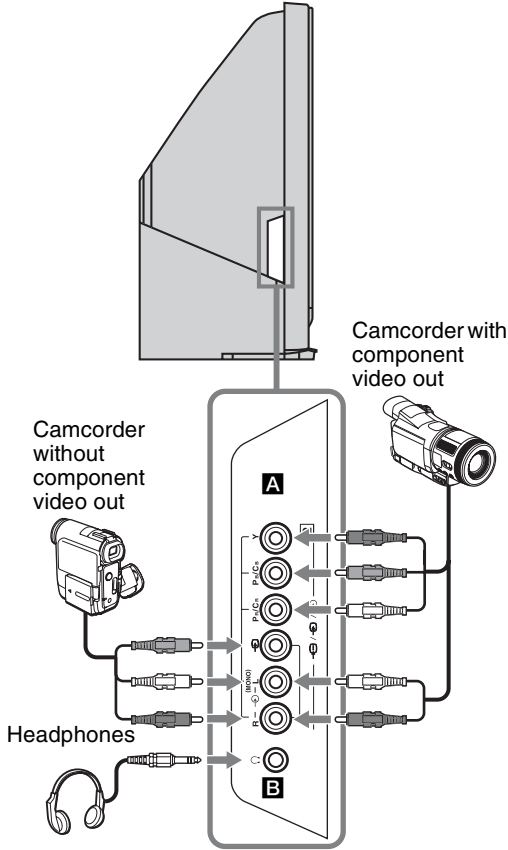

To connect	Do this
Camcorder or video game equipment A	Connect to the video jack → 2, or component jack → 2, and the audio jacks → 2. If you connect mono equipment, connect it to the L(MONO) jack → 2 (page 41).
Headphones B	Connect to the → jack to listen to sound from the TV on headphones.

Note

To see the image from Component input on the side panel, select "Auto" in "Video2(Component)" in "Setup" menu (page 37).

To connect	Do this
Personal computer C	Connect to the PC Input jack RGB and the audio jack → (RGB) on the rear of the TV.

Connecting to the rear of the TV

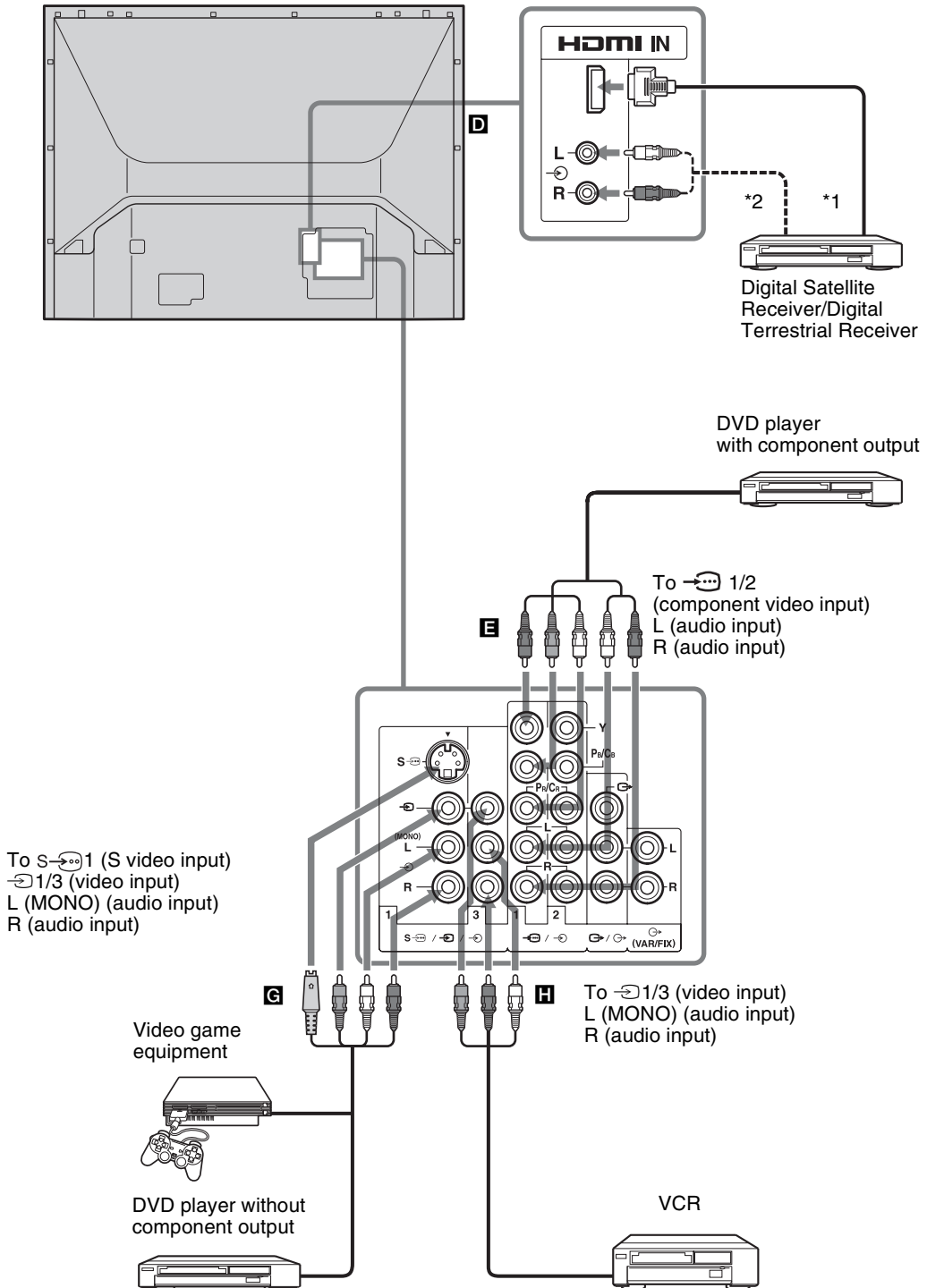







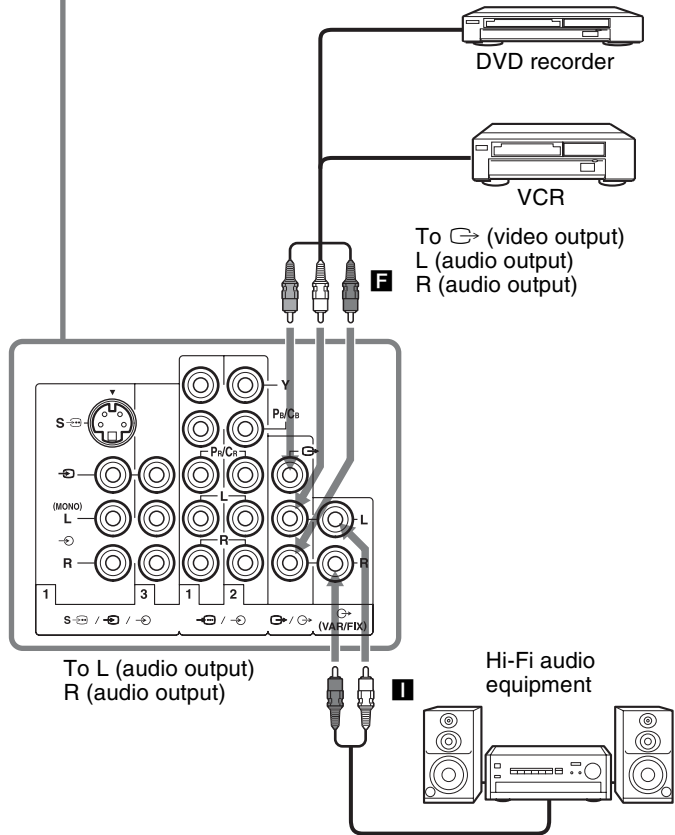
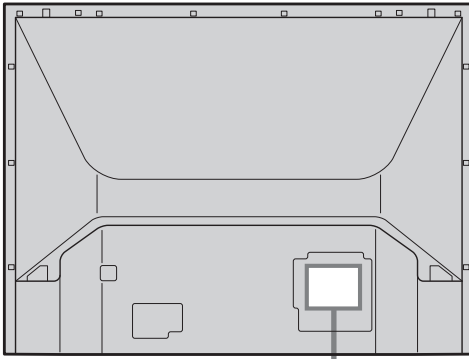



*1 Use an HDMI cable, HDMI-to-DVI cable, or adaptor (not supplied).

*2 When using an HDMI cable, it is not necessary to connect the audio cable. When using an HDMI-to-DVI cable or an adaptor, it is necessary to connect the audio cable.

Continued



To connect	Do this
Digital satellite receiver or digital terrestrial receiver D	<p>Connect only to the HDMI IN jack. The digital video and audio signals are input from the digital receiver.</p> <p>Tip If the digital receiver has an HDMI jack, connecting via an HDMI cable will provide the best results.</p> <p>Notes</p> <ul style="list-style-type: none"> When using an HDMI-to-DVI cable or an adaptor, be sure to connect the DVI output connector first; then connect to the HDMI jack on the TV. The HDMI jacks only support the following video inputs: 480i, 480p, 576i, 576p, 720p and 1080i. To connect a PC, use the PC IN jacks. Be sure to use only an HDMI cable that bears the HDMI logo.
DVD player with component output E	<p>Connect to the component jack  1, 2 and the audio jacks  1, 2. For better picture quality, component connection is recommended if your DVD player has a component output.</p>
DVD recorder or VCR F	<p>Connect to the video output jacks  to record the image from the TV. Connect to the audio output jacks  to record to the sound from the TV on the DVD recorder or VCR. To turn off the sound of the TV speakers, set "Speaker" to "Off" (page 30).</p>
Video game equipment, VCR, or DVD player without component output G H	<p>Connect to the S video jack  1 or the video jack  1, 3 and the audio jacks  1, 3. To avoid picture noise, do not connect the camcorder to the video jack  1 and the S video jack  1 at the same time. If you connect mono equipment, connect to the L (MONO) jack  1, 3.</p>
Hi-Fi audio equipment I	<p>Connect to the audio output jacks  to listen to the sound from the TV on the Hi-Fi audio equipment. To turn off the sound of the TV speakers, set "Speaker" to "Off" (page 30).</p>

Programming the remote

If you have Sony VCRs/DVDs and Sony DVD Home Theater Systems/Amplifiers, do the following procedure to program the remote so that you can operate them using this remote.

Note

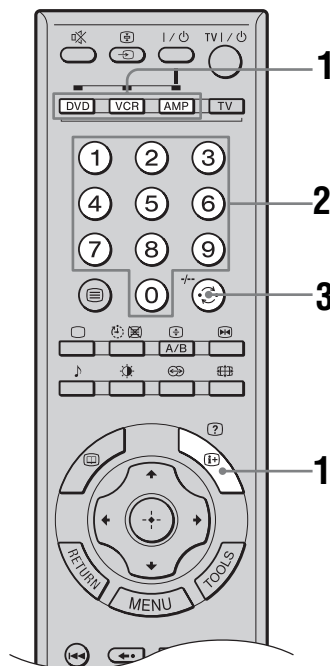

Before you start, look up the three-digit code for your equipment on page 44. For equipment that has more than one code, try with the first code number.



- 1 Press and hold the DVD, VCR, or AMP function button you want to program on the remote and press the  button simultaneously.

The selected function button (DVD, VCR, or AMP) will flash.

- 2 Enter the three-digit code using the number buttons while the function button is lit. (approximately 10 seconds)

- 3 Press  or  to complete the programming.

When the programming is done successfully, the selected function button will flash twice slowly, and if not, will flash five times quickly.

Continued

To check if the code works

Aim the remote to the equipment, then press . If the equipment responds, the programming is completed. If not, try the next code listed.

Equipment's codes

Equipment	Code
VCR	001*, 002, 003, 004
DVD	101*, 151, 201, 202, 203
Amplifier	301, 302, 303, 304, 401*, 402, 403, 451

* Factory setting

To set the remote to restore operation of the TV automatically

In the factory setting, the remote is set to operate a piece of equipment selected by one of the function buttons. The remote operates the equipment until another function button is pressed.

You can set the remote to operate the TV automatically if the remote has not been used to operate the other equipment for 30 seconds.

You can select either setting by the following operation.

Holding TV down, press and PROG- simultaneously.

When the remote returns to operate the TV, the TV button will light up.

When the remote is set to operate a different piece of equipment, all four function buttons will light up simultaneously.

Using other equipment with the remote

To operate other connected equipment, first program the necessary code.

Note

Some functions cannot be operated with the TV's remote depending on the equipment. In that case, use the remote supplied with the equipment.

To operate a VCR

To	Press
activate the remote to operate VCR the VCR	
turn on/off	
change channels	PROG+/-
record	REC ●

To	Press
stop recording	REC STOP ■
pause recording	REC PAUSE (press again to resume recording)
play	
stop	■
fast forward	
rewind the tape	
pause	(press again to resume normal playback)
search the picture forward or backward	or during playback (release to resume normal playback)

To operate a DVD player

To	Press
activate the remote to operate DVD the DVD	
turn on/off	
play	
stop	■
pause	(press again to resume normal playback)
step through different tracks of the disc	to fast reverse, or to fast forward the disc during playback
step through different chapters of the disc	to step forward, or to step backward
select a track directly	0-9, /-/-
display the top menu	DVD TOP MENU
display the disc menu	DVD MENU
operate the DVD menu	,
select the SYSTEM MENU	

To operate a 5.1ch DVD AV System (DAV)

To	Press
activate the remote to operate DVD the DVD	
turn on/off	
display the top menu	DVD TOP MENU
display the disc menu	DVD MENU

To	Press
play	
stop	
pause	(press again to resume normal playback)
search the picture forward or backward	or during playback
specify the previous chapter/track	
specify the next chapter/track	
move highlight (cursor), and select	,
change volume	

To operate a DVD/VCR combo unit

To	Press
activate the remote to operate DVD or VCR the DVD or VCR	
turn on/off	
display the top menu (DVD)	DVD TOP MENU
display the disc menu (DVD)	DVD MENU
play	
stop	
pause	(press again to resume normal playback)
search the picture forward or backward	or during playback
replay (DVD)	
advance (DVD)	
move highlight (cursor), and select (DVD)	,
Record (VCR)	REC
stop recording (VCR)	REC STOP
pause recording (VCR)	REC PAUSE (press again to resume recording)
change channels (VCR)	PROG+/-, 0-9, /-/- (using tuner)
adjust tracking (VCR)	PROG+/- (during tape playback)

To operate an HDD/DVD combo unit

To	Press
activate the remote to operate DVD the HDD/DVD	
turn on/off	
select the HDD	F1
select the DVD	F2
play	
stop	
pause	(press again to resume normal playback)
search the picture forward or backward	or during playback
replay (DVD)	
advance (DVD)	
move highlight (cursor), and select	,
specify the previous chapter/track	
specify the next chapter/track	
Record	REC
stop recording	REC STOP
pause recording	REC PAUSE (press again to resume recording)
display the top menu (DVD)	DVD TOP MENU
display the disc menu (DVD)	DVD MENU
select the SYSTEM MENU	
search a scene from the chapter list	VISUAL SEARCH
select another input signal connected to the input	/

To operate an AV Receiver/amplifier

To	Press
activate the remote to operate AMP the amplifier	
turn on/off	
master volume	
select other input connected to the AV receiver/amplifier	/

Additional Information

Replacing the lamp

The projection lamp, which illuminates the picture, has a limited life.

If the screen becomes dark, the color looks unusual, "Projection lamp is nearing end of life. Please replace the lamp." appears on the screen, or the LAMP indicator on the front of the LCD projection TV flashes, it is time to replace the lamp with a new one (not supplied).

This television uses a replaceable lamp as its light source. Over time, the screen will gradually grow darker as the lamp ages. Although rare, the lamp may make a small pop and will no longer light up. The lamp should be replaced after about 8,000 hours, which is the standard amount of time it takes for the lamp brightness to be reduced by half. Because the actual lamp life will vary depending on the operating conditions and environment, 8,000 hours is an estimate, not a guarantee.

WARNING

Electric appliances can cause fire or high temperature, resulting in injury or death. Be sure to follow the instructions below.

- Use a Sony XL-2400 replacement lamp (not supplied) for replacement. Use of any other lamp may damage the LCD projection TV.
- Do not remove the lamp for any purpose other than replacement. Doing so may cause injury or fire.
- Do not put flammable materials and metal objects inside the lamp receptacle of the TV after removing the lamp. Doing so may cause fire or electrical shock. Do not touch the lamp receptacle once the lamp has been removed.
- When the lamp eventually burns out, you may hear a noticeable pop sound. This is normal and it is inherent to this type of lamp.
- In rare instances, the bulb may pop inside the lamp unit, but the lamp unit is designed to contain all of the broken glass pieces inside the lamp unit.

CAUTION

Disposing of the lamp

This product contains mercury. For disposal or recycling information, please contact your local authorities.

Handling of the lamp

- Do not leave the used lamp near flammable materials or within the reach of children.
- Do not pour water onto the used lamp or put any object inside the lamp. Doing so may cause the lamp to burst.

- 1 Turn off the power on the main unit. Wait several minutes, then unplug the power cord.
(The cooling fan will continue to blow for about two minutes after turning the power off.)
- 2 Wait at least 30 minutes after unplugging the power cord to allow the lamp to cool down before replacing it. To avoid being burned, do not touch the lamp receptacle once the lamp has been removed.
- 3 Take the new lamp out of the box. Do not touch the glass portion of the new lamp.

Notes

- Do not shake the lamp. Vibration can damage the lamp or shorten its life.
- Avoid touching the front glass of a new lamp or the glass of the lamp receptacle. This may reduce picture quality or lamp life.

- 4 Remove the outside lamp cover.

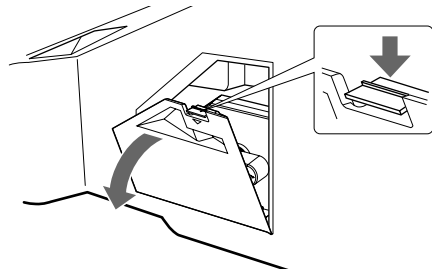

- 5 Remove the lamp door.

Turn the knob counterclockwise to OPEN and pull out the cover.

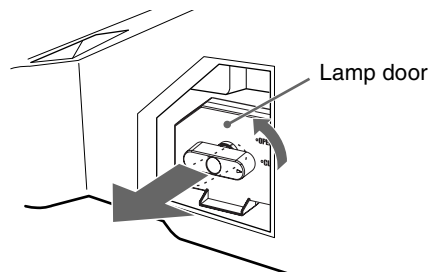

- 6** Pull out the lamp.
Hook a finger through the loop of the lamp handle and pull the handle upwards. Then pull the lamp straight out.

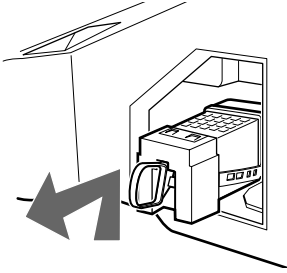

Notes

- The lamp is very hot immediately after use. Never touch the glass portion of the lamp or the surrounding parts.
- After the used lamp has cooled, place it into the empty box of the replacement lamp. Never put the used lamp into a plastic bag.

- 7** Put the new lamp into its place.
Mount the new lamp securely. Failure to do so may cause a fire or the screen to go dark.

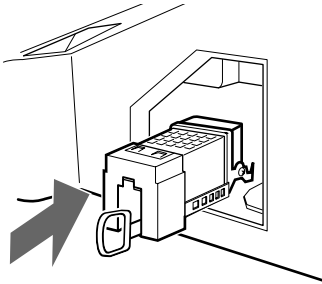

Note

If the lamp is not securely reattached, the self-diagnostic function may be triggered and the  indicator flashes three times (page 9).

- 8** Reattach the lamp door.
Turn the knob back to CLOSE and secure the cover.

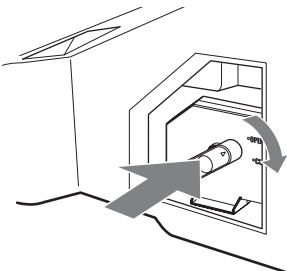

- 9** Put the outside lamp cover back in its place.

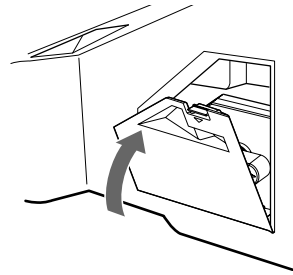

Notes

- Consult your Sony dealer for a Sony XL-2400 replacement lamp.
- Take great care when replacing the lamp or plugging in/unplugging the connecting cords. Rough handling may cause the TV to fall, damaging the TV, the TV stand and the floor.

- 10** Turn on the TV and set the Lamp Replacement in the Setup menu (page 37).

Specifications

Display Unit

Power Requirement:

220-240 V AC, 50/60 Hz

Projection System

3 LCD (Liquid Crystal Display) Panels, 1 lens projection system

LCD Panel

Size 0.73 inch TFT LCD panel
Resolution 1,280 pixels × 720 lines

Projection Lenses

High performance, large-diameter hybrid lens F2.4

Lamp

Ultra high pressure lamp, 100 W

Screen Size:

KF-55E200A: 55 inches (approx. 138.4 cm measured diagonally)

KF-50E200A: 50 inches (approx. 125.5 cm measured diagonally)

KF-42E200A: 42 inches (approx. 105.2 cm measured diagonally)

Power Consumption:

195 W

Standby Power Consumption:

1 W or less

Dimensions (w × h × d):

KF-55E200A:
Approx. 1,301 × 907 × 442 mm

KF-50E200A:
Approx. 1,184 × 827 × 408 mm

KF-42E200A:
Approx. 999 × 722 × 357 mm

Weight:

KF-55E200A: Approx. 36 kg

KF-50E200A: Approx. 31 kg

KF-42E200A: Approx. 27 kg

TV System

I, D/K, B/G, M

Color System

PAL, PAL60, SECAM, NTSC 4.43, NTSC 3.58

Antenna

75 ohm external terminal

Channel Coverage

B/G

VHF: E2 to E12 / UHF: E21 to E69 /

CATV: S01 to S03, S1 to S41

VHF: 0 to 12, 5A, 9A / UHF: 28 to 69 /

CATV: S01 to S03, S1 to S41(Australia only)

VHF: 1 to 11 / UHF: 21 to 69 /

CATV: S01 to S03, S1 to S41(New Zealand only)

I

UHF: B21 to B69 / CATV: S01 to S03, S1 to S41

D/K

VHF: C1 to C12, R1 to R12 / UHF: C13 to C57, R21 to R60 /

CATV: S01 to S03, S1 to S41, Z1 to Z39

M

VHF: A2 to A13 / UHF: A14 to A79 /

CATV: A8 to A2, A to W+4, W+6 to W+84

Terminals

S VIDEO 1 (4-pin mini DIN): 

Y: 1.0 Vp-p, 75 ohms unbalanced, sync negative

C: 0.286 Vp-p (Burst signal), 75 ohms

VIDEO/AUDIO IN 1/3: 

VIDEO: 

1 Vp-p, 75 ohms unbalanced, sync negative

AUDIO: 

500 mVrms

Impedance: 47 kilohms

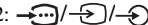
VIDEO/AUDIO IN 2: 

Y, Pb/Cb, Pr/Cr (Component video) :

Y : 1.0 Vp-p, 75 ohms unbalanced, sync negative

Pr/Cr : 0.7 Vp-p, 75 ohms

Pb/Cb : 0.7 Vp-p, 75 ohms

Signal format : 480i, 576i, 480p, 576p, 720p, 1080i

VIDEO: 

1 Vp-p, 75 ohms unbalanced, sync negative

AUDIO: 

500 mVrms

Impedance: 47 kilohms

HD/DVD IN 1/2: 

Y, Pb/Cb, Pr/Cr (Component video) :

Y : 1.0 Vp-p, 75 ohms unbalanced, sync negative

Pr/Cr : 0.7 Vp-p, 75 ohms

Pb/Cb : 0.7 Vp-p, 75 ohms

Signal format : 480i, 576i, 480p, 576p, 720p, 1080i

AUDIO: 

500 mVrms

Impedance: 47 kilohms

VIDEO/AUDIO OUT: 

VIDEO: 

1 Vp-p, 75 ohms unbalanced, sync negative

AUDIO: 

500 mVrms (100% modulation)

AUDIO OUT: 

More than 1 Vrms at the maximum volume setting
(Variable)

500 mVrms (100% modulation, Fixed)

PC IN :

VIDEO:  (RGB)

D-sub 15-pin, analogue RGB, 0.7 Vp-p, 75 ohms,
positive

AUDIO: 

Stereo minijack, 0.5 Vrms, 47 kilohms

See the PC Input Signal Compatibility Chart on page 25.

HDMI IN:

HDMI

Video: 480i, 480p, 576i, 576p, 720p, 1080i

Audio: Two channel linear PCM 32, 44.1 and
48 kHz, 16, 20 and 24 bits

AUDIO: 

500 mVrms (100% modulation)

Impedance: 47 kilohms

Headphones 

Stereo minijack

Impedance: 16 ohms

Sound Output

12 W + 12 W

Optional accessories

TV stand

KF-55E200A: SU-RG12L

KF-50E200A: SU-RG11M/SU-RG12L

KF-42E200A: SU-RG11S

Lamp Unit

XL-2400



Design and specifications are subject to change
without notice.

Troubleshooting

Check whether the  indicator is flashing in red.

When it is flashing





The self-diagnosis function is activated.



- 1 Measure how many times the  indicator flashes and stops flashing.
For example, the indicator flashes for two seconds, stops flashing for one second, and flashes for two seconds.
- 2 Press  on the TV (front side) to switch it off, disconnect the AC power cord, and inform your dealer or Sony service center of how the indicator flashes (duration and interval).

When it is not flashing

- 1 Check the items in the tables, below.
- 2 If the problem still persists, have your TV serviced by qualified service personnel.

Picture

Problem	Cause/Remedy
No picture (screen is dark) and no sound	<ul style="list-style-type: none">• Check the power cord, antenna, and VCR connection.• The TV is not turned on. Press  on the TV (front side).• If the  indicator lights up in red, press TV .
No picture or no menu information from equipment connected to the video input jack	<ul style="list-style-type: none">• Check that the optional equipment is on and press / repeatedly until the correct input symbol is displayed on the screen.• Check the connection between the optional equipment and the TV.
Distorted picture	<ul style="list-style-type: none">• Check if any connected optional equipment is installed in front of the TV or beside the TV. When installing optional equipment, leave some space between the optional equipment and the TV.• When changing channels, turn off any equipment connected to the video input jack on the rear of the TV.• Broadcast signals are too strong. Turn off or disconnect the booster if it is in use.
Double images or ghosting	<ul style="list-style-type: none">• Check antenna/cable connections.• Check the antenna location and direction. Contact a Sony dealer for advice.• Set Image Shift to an appropriate value. The default setting is Auto. If doubled images appear with Auto, select the best value from 1 to 4 (see page 37).• Broadcast signals are reflected by nearby mountains or building. Use the fine tuning (“Fine”) function (page 33). Otherwise, use a highly direction antenna.• Use of a booster is inappropriate. Turn off or disconnect the booster if it is in use.
Snowy picture and noisy sound	<ul style="list-style-type: none">• The antenna connection is loose or the antenna cable is damaged. Check the cable and connection on the TV, VCR, and on the wall (page 14).• Channel presetting is inappropriate or incomplete. Perform “Manual Program” in the “Program” menu to preset the channel again (page 33).• The antenna type is inappropriate. Check the antenna type (VHF/UHF). Contact a Sony dealer for advice.• The antenna direction needs adjustment. Adjust the antenna direction. Contact a Sony dealer for advice.• Signal transmission is low. Try using a booster.

Problem	Cause/Remedy
Only snow and noise appear on the screen	<ul style="list-style-type: none"> • Check if the antenna is broken or bent. • Check if the antenna has reached the end of its serviceable life (three to five years in normal use, one to two years at the seaside).
Picture noise (dotted lines or stripes)	<ul style="list-style-type: none"> • Keep the TV away from electrical noise sources such as cars, motorcycles, or hair-dryers, etc. • Make sure that the antenna is connected using the antenna cable (not supplied). • Keep the antenna cable away from other connecting cables. • Do not use a 300-ohm twin lead cable as interference may occur. • Adjust the antenna direction for the minimum interference. Contact a Sony dealer for advice.
Picture noise when viewing a TV channel	<ul style="list-style-type: none"> • Select “Manual Program” in the “Program” menu and adjust “Fine” to obtain better picture reception (page 33). • Select “Noise Reduction” in the “Picture” menu to reduce the noise in the picture (page 28).
Stripe noise during playback/recording of a VCR	<ul style="list-style-type: none"> • Video head interference. Keep your VCR away from the TV. • Leave a space of 30 cm between your VCR and the TV to avoid noise. • Avoid installing your VCR in front of the TV or beside the TV.
Good picture, but noisy sound	<ul style="list-style-type: none"> • The TV system setting is inappropriate. If the sound of all the channels are noisy, perform “Auto Program” in the “Program” menu to preset the channel again (page 33). If the sound of some channels is noisy, select the channel, then perform “Manual Program” in the “Program” menu, and select the appropriate TV system (“TV System”) (page 33).
Good picture, but no sound	<ul style="list-style-type: none"> • The volume level is too low. Press \triangleleft + to increase the volume level. • The sound is muted. Press MUTE, or \triangleleft + to cancel the muting. • The broadcast signal has a transmission problem. Press A/B until a better sound is heard. • “Speaker” is set to “Off”. Set to “On” in the “Sound” menu (page 30). • “Mono” is selected. Set to “Auto” by pressing A/B (page 19).
Some tiny black points and/or bright points on the screen	<ul style="list-style-type: none"> • The picture of a display unit is composed of pixels. Tiny black points and/or bright points (pixels) on the screen do not indicate a malfunction.
No color	<ul style="list-style-type: none"> • The color intensity setting is too low. Select “Color” in the “Picture” menu to adjust the color intensity (page 27). • The color system setting is inappropriate. Select “Color System” in the “Setup” menu to select a correct color system (page 38). Usually set this to “Auto”. • The antenna direction needs adjustment. Adjust the antenna direction. Contact a Sony dealer for advice. • Select “Reset” in the “Picture” menu to return to the factory settings (page 26).
Lines moving across the TV screen	<ul style="list-style-type: none"> • There is interference from external sources, e.g., heavy machineries, broadcast station nearby. Use the fine tuning (“Fine”) function (page 33).
No color or irregular color when viewing a signal from the Y, Pb/Cb, Pr/Cr jacks of  1, 2	<ul style="list-style-type: none"> • Check the connection of the Y, Pb/Cb, Pr/Cr jacks of  1, 2. • Make sure that the Y, Pb/Cb, Pr/Cr plugs of  1, 2 are firmly seated in their respective jacks.

Continued

Problem	Cause/Remedy
When displaying the Twin Picture, the quality of the sub screen picture is not as good as that of the main screen picture	<ul style="list-style-type: none"> The quality of the sub screen picture may be deteriorated depending on the combination of the input signals.
A white oval image appears on the screen	<ul style="list-style-type: none"> This is due to strong light reflecting off both the TV screen and reflections coming from behind the screens. Position your TV away from strong ambient light or sunlight, or lower any ambient lights.

Sound

Problem	Cause/Remedy
No sound, but good picture	<ul style="list-style-type: none"> Press \triangle +/- or M (Mute). Check that "Speaker" is set to "On" in the "Sound" menu (page 30).
Noisy sound	<ul style="list-style-type: none"> See the "Picture noise (dotted lines or stripes)" cause/remedy on page 51.
Low sound volume	<ul style="list-style-type: none"> "Mono" is selected. Set to "Auto" by pressing A/B (page 19). Check to see if the volume level is too low. Switch "Steady Sound" between "On" and "Off" in the "Sound" menu (page 29).
No stereo broadcast signal is received	<ul style="list-style-type: none"> The stereo reception setting is inappropriate. Press A/B until "Auto" appears on the screen (page 19).
Stereo broadcast sound switches on and off, or is distorted; The sound switches between stereo and monaural frequently	<ul style="list-style-type: none"> The antenna connection is loose or the antenna cable is damaged. Check the cable and connection on the TV, VCR, and on the wall (page 14). Adjust the antenna direction for the minimum interference. Contact a Sony dealer for advice. Signal transmission is low. Try using a booster. Otherwise, use the fine tuning ("Fine") function (page 33). The broadcast signal has a transmission problem. Press A/B until a better sound is heard (page 19).
No sound from the computer	<ul style="list-style-type: none"> Check the connection of the audio cable (page 40).

General

Problem	Cause/Remedy
The TV turns off automatically (the TV enters standby mode)	<ul style="list-style-type: none"> Check to see if the Sleep Timer function is activated (page 39). If the inside of TV becomes too warm, the TV automatically switches to standby mode. Check to ensure the ventilation slots are not blocked or clogged with dust.
Some input sources cannot be selected	<ul style="list-style-type: none"> Select "Video Label" in the "Setup" menu and cancel "Skip" of the input source (page 36).
No picture but "PC" indication appears when the TV is turned on.	<ul style="list-style-type: none"> The TV was set to the standby mode by the Power Management function (page 36). Select a channel.

Problem	Cause/Remedy
The remote does not function	<ul style="list-style-type: none"> • Check that the remote is set correctly for the equipment you are using (VCR, TV, or DVD). • If the remote does not operate the VCR or DVD even when the remote has been set correctly to VCR or DVD, enter the necessary code set as explained in “Programming the remote” (page 43). • Replace the batteries. • Check to see if the TV power is off.
The LAMP indicator blinks in red	<ul style="list-style-type: none"> • Replace the lamp (page 46).
“Projection lamp is nearing end of life. Please replace the lamp.” message appears	<ul style="list-style-type: none"> • It is time for you to replace the projection lamp used in you TV. Replace the lamp (page 46).
The TV does not turn on	<ul style="list-style-type: none"> • The TV cools down its projection lamp when the power is turned off. It takes up to two minutes for the picture to come back after the TV is turned on again. Wait for a while until the picture comes back. • If the “High Temperature Warning!” message appears, turn off the TV and wait until the TV’s projection lamp cools down (approximately 5 minutes). If the remote control still does not work, make sure to dust the ventilation slots on the rear of the TV and the cooling fan to provide adequate ventilation around the TV.
The wide screen mode changes spontaneously when “Auto Wide” is “On”	<ul style="list-style-type: none"> • During a transition between two programs, the TV detects the optimum wide screen mode. During this period, an irregular wide screen mode may appear. • The wide mode is switched automatically according to the revised signal with a Wide ID signal. • The Auto Wide feature stops working temporarily when you press ⏏, and resumes after a while. To fix in the manually selected wide screen mode, set “Auto Wide” to “Off” in the “Screen” menu (page 31).
“100” appears at the top of the screen after approximately 10 seconds and there is no teletext display	<ul style="list-style-type: none"> • The channel carries no Teletext broadcast.
Teletext display is incomplete (snowy picture or double images)	<ul style="list-style-type: none"> • Your area may not be able to receive Teletext. Teletext is displayed only in the area that is covered by Teletext services. • The antenna connection is loose or the antenna cable is damaged. Check the cable and connection on the TV, VCR, and on the wall (page 14). • The antenna direction needs adjustment. Adjust the antenna direction. Contact a Sony dealer for advice. • Signal transmission is too low. Try using a booster. Otherwise, use the fine tuning (“Fine”) function (page 33).
Cannot play shooting games	<ul style="list-style-type: none"> • Some shooting games which involve pointing a light beam at the TV screen with an electronic gun or rifle cannot be used with your TV. For details, see the instruction manual supplied with the video game software.
The TV cabinet creaks	<ul style="list-style-type: none"> • Changes in room temperature sometimes make the TV cabinet expand or contract, causing a noise. This does not indicate a malfunction.
Static discharge is felt when touching the TV cabinet	<ul style="list-style-type: none"> • This is the same static discharge that is felt when touching metal door handles or car doors especially when the air is dry, for example in winter. This does not indicate a malfunction.

Index

Numerics

1Digit Direct 34

4:3 Default 31

A

A/B button 8

Advanced Iris 27

Advanced Video 28

Antenna, connecting 14

Audio equipment 42

Audio Out 30

Auto Adjustment 32

Auto Program 16, 33

Auto Wide 31

B

Balance 29

Bass 29

Batteries, inserting into the remote 13

BBE 30

Brightness 27

C

Channels

 auto-programming 16

 selecting 18

 Skip 34

Cinema Drive 37

Color 27

Color System 38

Color Temperature 27

Colored buttons 8

Connecting

 an antenna/VCR 14

 optional equipment 40

Cooling Mode 37

D

Display Area 32

Display Mode 26

DRC Mode 28

DRC Palette 28

DVD MENU button 8

DVD TOP MENU button 8

E

Effect (sound) 30

F

Fastext 19

Fine 33

Full 20

Function buttons 7, 43

G

Game Mode 36

H

Headphones

 connecting 40

Horizontal Center 32

Hue 27

I

Image Shift 37

Info (i) button 7

Initial Reset 38

Input select (↔) button 7

L

Lamp (L) indicator 9

Lamp Replacement 37

Lamp, replacing 46

Language 36

M

Manual Program 33

MENU 23

MENU buttons 7

Mute (M) button 7

N

Noise Reduction 28

Normal 20

Number buttons 7, 18

O

On Timer 39

P

PC input signal compatibility 25

Personal computer 40

Phase 32

Picture 27

Picture Freeze 19

Picture menu 26

Picture Mode 26

Picture mode (P) button 8

Pitch 32

Power (P) indicator 9

Power (P) switch 9

Power Management 36

Previous channel (C/-/-) button 7

PROG +/- buttons 8, 9

Program Block 34

Program Label 34

Program menu 33

Program Sorting 35

R

Remote

 control sensor 9

 inserting batteries 13

 overview 7

 programming 43

Reset

 picture adjustment 26

 sound adjustment 29

S

Screen menu 31

Screen mode 20

Screen mode (S) button 8

Screen Shift 32

Setup menu 36

Sharpness 27

Skip 34

Sleep Timer 39

Sleep Timer (S) button 8

Sound menu 29

Sound Mode 29

Sound mode (S) button 8

Speaker 30

Specifications 48

Standby (S) indicator 9

Steady Sound 29

Support belt 12

Surround (S) button 8

T

Text 19

Text enlarge (E) button 8

Text hold (H) button 7

Text reveal (R) button 7

Timer (T) indicator 9

Timer menu 39

TOOLS 20, 21

Treble 29

TV mode (T) button 8

TV standby (I/S) button 7

TV System 33

Twin Picture 21, 22

U

UHF 34

V

VCR

 connecting 14

Vertical Center 32

Vertical Size 32

VHF High 34

VHF Low 34

Video Label 36

Video2(Component) 37

Volume (V) +/- buttons 8, 9

Volume Level 30

W

Wide Mode 31

Wide Zoom 20

Z

Zoom 20

HDMI

<http://www.sony.net/>



* 2 6 9 3 3 9 1 1 1 * (1)

Printed in Malaysia