

SONY[®]

2-593-962-11(3)

GRAND WEGA[™]

LCD Projection TV
HD-TV
Operating Instructions

KDF-E55A20
KDF-E60A20



Owner's Record

The model and serial numbers are located at the rear of the TV, below the Sony logo, on the sticker, and also on the TV box (white label). Record these numbers in the spaces provided below. Refer to them whenever you call upon your Sony dealer regarding this product.

Model No. _____

Serial No. _____

Contacting Sony

If, after reading the following instructions, you have additional questions related to the use of your Sony® TV, please call one of the following numbers.

Customers in the continental United States contact the Direct Response Center at:

1-800-222-SONY (7669)

or visit <http://www.sonystyle.com/tv/>

Customers in Canada contact the Customer Relations Center at:

1-877-899-SONY (7669)

or visit <http://www.sonystyle.ca/tv/>

WARNING

To reduce the risk of fire or electric shock, do not expose this apparatus to rain or moisture.

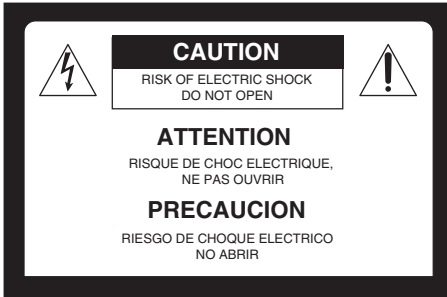

This symbol is intended to alert the user to the presence of uninsulated “dangerous voltage” within the product’s enclosure that may be of sufficient magnitude to constitute a risk of electric shock to persons.



This symbol is intended to alert the user to the presence of important operating and maintenance (servicing) instructions in the literature accompanying the appliance.

The apparatus shall not be exposed to dripping or splashing and no objects filled with liquids, such as vases, shall be placed on the apparatus.

CAUTION

To prevent electric shock, do not use this polarized AC plug with an extension cord, receptacle or other outlet unless the blades can be fully inserted to prevent blade exposure.

CAUTION

When using TV games, computers, and similar products with your projection TV, keep the brightness and contrast functions at low settings. If a fixed (non-moving) pattern is left on the screen for long periods of time at a high brightness or contrast setting, the image can be permanently imprinted onto the screen. Continuously watching the same program can cause the imprint of station logos onto the TV screen. These types of imprints are not covered by your warranty because they are the result of misuse.

Note on Caption Vision

This television receiver provides display of television closed captioning in accordance with §15.119 of the FCC rules.

NOTIFICATION

This equipment has been tested and found to comply with the limits for a Class B digital device, pursuant to Part 15 of the FCC Rules. These limits are designed to provide reasonable protection against harmful interference in a residential installation. This equipment generates, uses and can radiate radio frequency energy and, if not installed and used in accordance to the instructions, may cause harmful interference to radio communications. However, there is no guarantee that interference will not occur in a particular installation. If this equipment does cause harmful interference to radio or television reception, which can be determined by turning the equipment off and on, the user is encouraged to try to correct the interference by one or more of the following measures:

- ❑ Reorient or relocate the receiving antennas.
- ❑ Increase the separation between the equipment and receiver.
- ❑ Connect the equipment into an outlet on a circuit different from that to which the receiver is connected.
- ❑ Consult the dealer or an experienced radio/TV technician for help.

You are cautioned that any changes or modifications not expressly approved in this manual could void your warranty.

Safety

- ❑ The TV should be installed near an easily accessible power outlet.
- ❑ Operate the TV only on 120 V AC.
- ❑ The plug is designed, for safety purposes, to fit into the wall outlet only one way. If you are unable to insert the plug fully into the outlet, contact your dealer.
- ❑ If any liquid or solid object should fall inside the cabinet, unplug the TV immediately and have it checked by qualified service personnel before operating it further.
- ❑ If you will not be using the TV for several days, disconnect the power by pulling the plug itself. Never pull on the cord.
- ❑ For details concerning safety precautions, see “Important Safety Instructions” on page 3.

Installing

- ❑ The TV should be installed near an easily accessible power outlet.
- ❑ To prevent internal heat buildup, do not block the ventilation openings.

- ❑ Do not install the TV in a hot or humid place, or in a place subject to excessive dust or mechanical vibration.
- ❑ Avoid operating the TV at temperature below 41°F (5°C).
- ❑ If the TV is transported directly from a cold to a warm location, or if the room temperature changes suddenly, the picture may be blurred or show poor color. In this case, please wait a few hours to let the moisture evaporate before turning on the TV.
- ❑ To obtain the best picture, do not expose the screen to direct illumination or direct sunlight. It is recommended to use spot lighting directed down from the ceiling or to cover the windows that face the screen with opaque drapery. It is desirable to install the TV in a room where the floor and walls are not of a reflective material.
- ❑ See page 12 & 13 for more information on the installation.

Note

This digital television is capable of receiving analog basic, digital basic and digital premium cable television programming by direct connection to a cable system providing such programming. A security card provided by your cable operator is required to view encrypted digital programming. Certain advanced and interactive digital cable services such as video-on-demand, a cable operator's enhanced program guide and data-enhanced television services may require the use of a set-top box. For more information call your local cable operator.

This television also includes a QAM demodulator which should allow you to receive unscrambled digital cable television programming via subscription service to a cable service provider. Availability of digital cable television programming in your area depends on the type of programming and signal provided by your cable service provider.

Trademark Information



As an ENERGY STAR[®] Partner, Sony Corporation has determined that this product meets the ENERGY STAR[®] guidelines for energy efficiency.

ENERGY STAR[®] is a U.S. registered mark.

CableCARD[™] is a trademark of Cable Television Laboratories, Inc.

TruSurround XT, SRS and the (●)[®] symbol are trademarks of SRS Labs, Inc. TruSurround XT technology is incorporated under license from SRS Labs, Inc.

BBE and BBE Symbol are trademarks of BBE Sound, Inc. and are licensed by BBE Sound, Inc. under U.S. Patent No. 4,638,258 and 4,482,866.



This TV is manufactured under license from Dolby Laboratories. Dolby and the double-D symbol are trademarks of Dolby Laboratories.



This TV incorporates High-Definition Multimedia Interface (HDMI[™]) technology. HDMI, the HDMI logo and High-Definition Multimedia Interface are trademarks or registered trademarks of HDMI Licensing LLC.

WEGA, Grand WEGA, WEGA GATE, Steady Sound, Digital Reality Creation, CineMotion, PlayStation, and BN Smoother are trademarks of Sony Corporation.

TV STAND:

Use the following Sony appliance(s) only with the following TV STAND. Use with other TV STAND may cause instability and result in possible injury.

SONY APPLIANCE MODEL NO:

KDF-E55A20

KDF-E60A20

SONY TV STAND MODEL NO:

SU-GW12

Replacement Parts

See page 4 under "Service".

See page 76 for replacement lamp.

Important Safety Instructions

- 1) Read these instructions.
- 2) Keep these instructions.
- 3) Heed all warnings.
- 4) Follow all instructions.
- 5) Do not use this apparatus near water.



- 6) Clean only with dry cloth.



- 7) Do not block any ventilation openings. Install in accordance with the manufacturer's instructions.



- 8) Do not install near any heat sources such as radiators, heat registers, stoves, or other apparatus (including amplifiers) that produce heat.



- 9) Do not defeat the safety purpose of the polarized or grounding-type plug. A polarized plug has two blades with one wider than the other. A grounding type plug has two blades and a third grounding prong. The wide blade or the third prong are provided for your safety. If the provided plug does not fit into your outlet, consult an electrician for replacement of the obsolete outlet.



- 10) Protect the power cord from being walked on or pinched particularly at plugs, convenience receptacles, and the point where they exit from the apparatus.



- 11) Only use attachments/accessories specified by the manufacturer.



- 12) Use only with the cart, stand, tripod, bracket, or table specified by the manufacturer, or sold with the apparatus. When a cart is used, use caution when moving the cart/apparatus combination to avoid injury from tip-over.



- 13) Unplug this apparatus during lightning storms or when unused for long periods of time.



- 14) Refer all servicing to qualified service personnel. Servicing is required when the apparatus has been damaged in any way, such as power-supply cord or plug is damaged, liquid has been spilled or objects have fallen into the apparatus, the apparatus has been exposed to rain or moisture, does not operate normally, or has been dropped.



- Be sure to observe the TV's "For Safety" section on page 5.

Antennas

Outdoor Antenna Grounding

If an outdoor antenna is installed, follow the precautions below. An outdoor antenna system should not be located in the vicinity of overhead power lines or other electric light or power circuits, or where it can come in contact with such power lines or circuits.

WHEN INSTALLING AN OUTDOOR ANTENNA SYSTEM, EXTREME CARE SHOULD BE TAKEN TO KEEP FROM CONTACTING SUCH POWER LINES OR CIRCUITS AS CONTACT WITH THEM IS ALMOST INVARIABLY FATAL.

Be sure the antenna system is grounded so as to provide some protection against voltage surges and built-up static charges.

Section 810 of the National Electrical Code (NEC) in USA and Section 54 of the Canadian Electrical Code in Canada provides information with respect to proper grounding of the mast and supporting structure, grounding of the lead-in wire to an antenna discharge unit, size of grounding conductors, location of antenna discharge unit, connection to grounding electrodes, and requirements for the grounding electrode.

Antenna Grounding According to the NEC

Refer to section 54-300 of Canadian Electrical Code for Antenna Grounding.

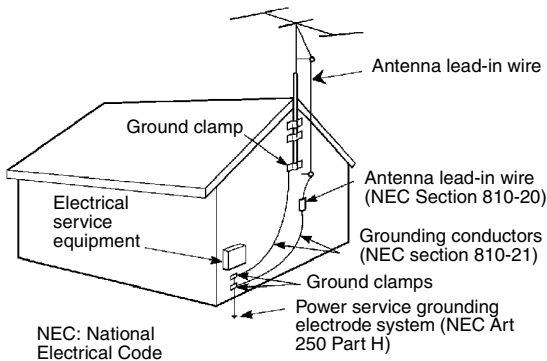

Cleaning

❑ Clean the rear cover area of the TV regularly. Dust in the rear cover area may cause a problem with the cooling system of the TV set.

❑ Clean the cabinet of the TV with a dry soft cloth. To remove dust from the screen, wipe it gently with a soft cloth. Stubborn stains may be removed with a cloth slightly dampened with solution of mild soap and warm water. Never use strong solvents such as thinner or benzine for cleaning. If the picture becomes dark after using the TV for a long period of time, it may be necessary to clean the inside of the TV. Consult qualified service personnel.



❑ Unplug the AC power cord when cleaning this unit. Cleaning this unit with a plugged AC power cord may result in electric shock.

On Contamination on the Screen Surface

The screen surface has a special coating to reduce reflections. To prevent screen damage, clean the screen as follows:

- ❑ Clean the screen with a soft cloth.
- ❑ To remove hard contamination, use a cloth moistened with a solution of mild detergent and water. Do not spray cleaning solution directly onto the TV. It should only be sprayed to moisten the cleaning cloth.
- ❑ Do not use any type of abrasive pad, alkaline cleaner, acid cleaner, scouring powder, chemical cloth, or solvent such as alcohol, benzene or thinner, as these may scratch the screen's coating.

Service

Damage Requiring Service

Do not attempt to service the set by yourself since opening the cabinet may expose you to dangerous voltage or other hazards.

Unplug the set from the wall outlet and refer servicing to qualified service personnel.



Replacement Parts

When replacement parts are required, be sure the service technician certifies in writing that he has used replacement parts specified by the manufacturer that have the same characteristics as the original parts.

Unauthorized substitutions may result in fire, electric shock or other hazards.

See "Replacing the Lamp" on page 76.

For Safety

Be Careful when Moving the TV

When you place the TV in position, be careful not to drop it on your foot or fingers.

Watch your footing while installing the TV.

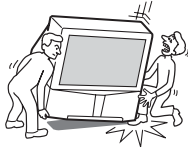

Carry the TV in the Specified Manner

If you carry the TV in a manner other than the specified manner and without the specified number of persons, it may drop and a serious injury may be caused. Be sure to follow the instructions mentioned below.



- ❑ Carry the TV with the specified number of persons (see page 12).
- ❑ Do not carry the TV holding the speaker grill.
- ❑ Hold the TV tightly when carrying it.
- ❑ Before carrying the TV, disconnect any accessories or cables.

About the LCD projection TV

Although the LCD projection TV is made with high-precision technology, black dots may appear or bright points of light (red, blue, or green) may appear constantly on the LCD screen. This is a structural property of the LCD panel and is not a defect.

Installation

- ❑ If direct sunlight or other strong illumination shines on the screen, part of the screen may appear white due to reflections from behind the screen. This is a structural property of the LCD projection TV. Do not expose the screen to direct illumination or direct sunlight.
- ❑ The picture quality may be affected by your viewing position. For the best picture quality, install your TV according to “Recommended Viewing Area” on page 13.
- ❑ When installing your TV against a wall, keep it at least 4 inches (10 cm) from the wall.

Projection Lamp

- ❑ Your TV uses a projection lamp as its light source. It is time to replace the lamp with a new one (not supplied) when:
 - the lamp replacement indicator on the front panel blinks in red,
 - screen images become dark,
 - no image appears on the display after prolonged use.
- ❑ In rare instances, the bulb may pop inside the lamp unit, but the lamp unit is designed to contain all of broken glass pieces inside the lamp unit. (see “Replacing the Lamp” on page 76)
- ❑ When the lamp eventually burns out, you may hear a noticeable pop sound. This is normal and is inherent in this type of lamp.

Cooling Fan

- ❑ This TV uses a cooling fan. You may hear the noise of fan running, depending on the placement of your TV. The noise may be more noticeable during the night or when the background noise level is low.

Contents

Introducing the Sony TV

Presenting the Sony TV	8
Package Contents	8
Features	8
Enjoying Your TV	10
Notes on the TV	10
Screen	10
Indicators	11
Projection Lamp	11
Installing the TV	12
Carrying Your TV	12
Take Precaution during Installation	13
To Prevent the TV from Falling	13
When Installing Your TV Against a Wall	13
Recommended Viewing Area	13
TV Front Panel and Connectors	14
Front Panel	14
Front and Rear Panel Connectors	15

Connecting the TV

Overview	17
Making Video and Audio Connections	17
About Using S VIDEO	18
About Using HDMI to DVI Adapter	18
Basic Connections	19
Cable System or VHF/UHF	20
Cable Box and Antenna	21
Cable Box	22
Satellite Receiver	23
Digital Cable Box	
Or Digital Satellite Receiver	24
Using CableCARD™ Device	25
About Using CableCARD™ Device	25
Activating CableCARD Service	25
Removing the CableCARD™ Device	26
Equipment with HDMI Connection	27
Equipment with DVI Connection	28
Equipment with Digital Audio (Optical)	29
Setting Up the TV Channel List	30
Using Initial Setup	30
Connecting Optional Equipment	31
VCR and Cable	32
VCR and Cable Box	33
Two VCRs for Tape Editing	35

DVD Player with Component	
Video Connectors	36
DVD Player with	
S VIDEO and Audio Connectors	37
Camcorder or PlayStation	38
Audio Receiver	39

Watching the TV

Overview	41
Inserting Batteries into the Remote Control	41
Button Descriptions	42
Programming the Remote Control	44
Manufacturer's Codes	45
Using Other Equipment with Your Remote	
Control	46
Special Buttons on the Remote Control	48
Using the GUIDE Button	48
Using the WIDE Button	50
Using the FREEZE Button	51
Using the JUMP Button	51

Introducing WEGA GATE

Overview of WEGA GATE	52
Using Favorites in WEGA GATE	54
Using Cable in WEGA GATE	54
Using Antenna in WEGA GATE	55
Using External Inputs in WEGA GATE	55
Using Settings in WEGA GATE	55

Using the Settings

Overview	56
Accessing the Video Settings	58
Selecting Video Options	58
Accessing the Audio Settings	60
Selecting Audio Options	60
Accessing the Screen Settings	62
Selecting Screen Options	62
Accessing the Channel Settings	64
Selecting Channel Options	64
Accessing the Parental Lock Settings	66
Selecting Parental Lock Options	66
Viewing Blocked Programs	67
Selecting Custom Rating Options	68

Accessing the Setup Settings	70
Selecting Setup Options.....	70
Programming Caption Vision	72
Accessing the Applications Settings.....	73
Selecting Applications Options	73

Other Information

Overview.....	75
Contacting Sony.....	75
Replacing the Lamp	76
How to Replace the Lamp	76
Troubleshooting	80
Remote Control.....	80
CableCARD™ Device	80
Video.....	81
Audio	82
Channels.....	82
General.....	83
Specifications.....	84
Optional Accessories	85

Index

Index	87
-------------	----

Introducing the Sony TV

Presenting the Sony TV

Thank you for purchasing this Sony's *HD* LCD Projection TV. This manual is for models KDF-E55A20 and KDF-E60A20.

Instructions in this manual are written for the remote control. Similar controls are also found on the TV console.

Package Contents

Along with your new TV, the packing box contains a remote control and two AA (R6) batteries. These items are all you need to set up and use the TV. Also included in the box are this operating manual and a Quick Setup Guide poster.

Features

Some of the features that you will enjoy with your new TV include:

- ❑ **WEGA GATE™**: WEGA GATE is a new feature that allows you to easily navigate to the most convenient TV functions: favorite channels, cable channels, antenna channels, external input list or settings.
- ❑ **WEGA Engine**: Delivers superb picture quality from any video source by minimizing the signal deterioration caused by digital-to-analog conversion and stabilizing the signal processing. This engine features unique Sony technology, including:
 - The first step in the digital processing system, Composite Component Processor (CCP-X), which enhances input signal-to-noise ratio by chroma decoder digital processing.
 - **DRC® (Digital Reality Creation)-MF V1**: Unlike conventional line doublers, the DRC Multifunction feature replaces the signal's NTSC waveform with the near-HD equivalent by digital mapping processing. The DRC Palette option lets you customize the level of detail (Reality) and smoothness (Clarity) to create up to three custom palettes.
- ❑ **Integrated HDTV**: You can watch digital television programs and enjoy the improved audio/video quality offered by these programs.
- ❑ **CableCARD™ slot**: Provides cable subscribers with access to digitally encrypted cable channels — without the need for a set-top box — that will enable you to receive not only standard definition but also high definition television. The CableCARD device, which is provided by your cable TV company, is inserted into the TV's rear panel CableCARD slot. After the service is activated with your cable TV company, the card replaces the need for a separate set-top box. (Check with your cable TV company about CableCARD service details, limitations, pricing, and availability. For more information about CableCARD device in this manual, see page 25.)

- ❑ **HDMI (High-Definition Multimedia Interface):** Provides an uncompressed, all-digital audio/video interface between this TV and any HDMI-equipped audio/video component, such as a set-top box, DVD player, and A/V receiver. HDMI supports enhanced, or high-definition video, plus multi-channel digital audio.
- ❑ **Component Video Inputs:** Offer the best video quality for DVD (480p, 480i) and digital set-top box (1080i, 720p, 480p, 480i) connections.
- ❑ **S VIDEO Inputs:** Provide a high-quality image from connected equipment.
- ❑ **CineMotion[®]:** Using the reverse 3-2 pull down technology, the CineMotion feature provides smoother picture movement when playing back movies or other video sources on film.
- ❑ **Steady Sound[®]:** Equalizes volume levels so there is consistent output between programs and commercials.
- ❑ **Wide Screen Mode:** Allows you to watch 4:3 normal broadcasts in wide screen mode (16:9 aspect ratio).
- ❑ **Favorite Channels:** Allows you to navigate a list of up to sixteen favorite channels without leaving the current channel.
- ❑ **Parental Control:** V-Chip technology allows parents to block unsuitable programming from younger viewers.

Enjoying Your TV

To enjoy your TV for years to come and maintain its original picture quality, you should perform periodic maintenance.

Notes on the TV

To enjoy clear picture

- ❑ Prevent sunlight or other light sources from shining directly on to the screen.
- ❑ The screen surface is easily scratched. Do not rub, touch, or tap it with sharp or abrasive objects (see “Cleaning” on page 4).

When not using the TV for a long period of time

- ❑ Unplug the AC power cord from the outlet if you anticipate not using the TV for more than a week.

When turning off the power

- ❑ The cooling fan will continue to operate for about two minutes. Allow several minutes before unplugging from the outlet or switching the breaker off.

On moisture condensation

- ❑ If your TV is moved directly from a cold to a warm location or is placed in a humid room, or if the room temperature changes suddenly, the picture may blur or show poor color. This is caused by moisture condensation on the lenses inside. Wait a few hours to let the moisture evaporate before turning on the TV. When the condensation has evaporated, the picture will return to normal.

Screen

To minimize reflection, the screen surface has a special coating. Inappropriate cleaning methods could damage the screen surface. Special care is required.

Cleaning the Screen Surface

Dust and dirt on the screen can affect the picture quality. To dust off the screen use a soft cloth. Be sure to follow the cleaning instruction on page 4 for stubborn stains and dirt.

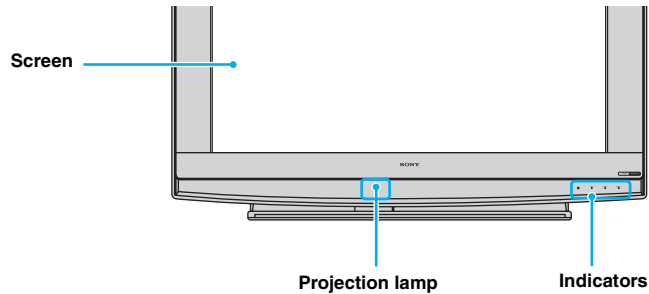

Indicators

The indicators show the current status of your TV. If there is a change in the condition or a problem with the TV, the indicators will flash or light up in the manner described below to let you know that it requires your attention.

<i>Indicator</i>	<i>Flashing because...</i>
POWER (green) flashing	The lamp for the light source is preparing to turn on. When it is ready, it turns on.
POWER (red) flashing	The lamp cover is not securely attached. The red indicator will continue to flash in intervals of 3 blinks at a time until the lamp cover is placed correctly. When the lamp cover is securely attached the TV will turn on with green indicator.
TIMER indicator is lit.	When one of the timer is set, the indicator will remain lit (will not flash) even when the TV is turned off.
LAMP indicator flashes.	The projection lamp has burned out. Replace it with a new one (see page 14).

Projection Lamp

How to replace the lamp, see page 76.

Your TV uses a projection lamp as its light source. As with any lamp, it has lifespan and needs to be replaced when the Lamp indicator flashes or the screen becomes darker. The projection lamp is located under the Control Panel cover as shown in the diagram above. Note the following:

- ❑ After turning on your TV, it may take a while (1 minute or less) before the picture appears.
- ❑ When the projection lamp wears out, the screen goes dark. Replace the lamp with a new Sony XL-2200 replacement lamp (not supplied).

⚠ The light emitted from the lamp is quite bright when your TV is in use. To avoid eye discomfort or injury, do not look into the light housing when the power is on.

Installing the TV

Carrying Your TV

Carrying the TV requires at least two people. Do not hold by the pedestal or the front panel of the TV. Doing so may cause these parts to break off.

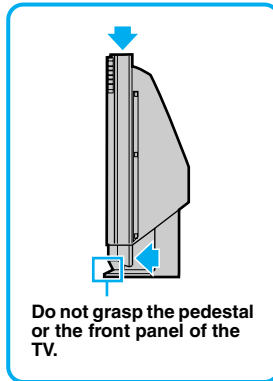

When moving the TV, place one hand in the hole on the lower portion of the TV while grasping the top with the other hand, as shown in the illustration below.

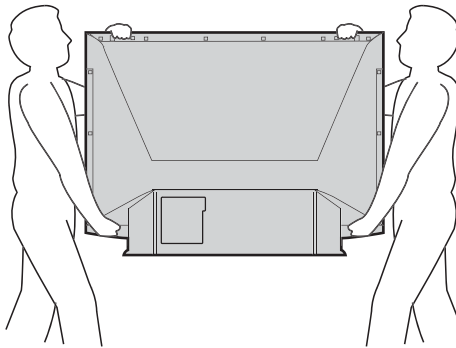

If you have connected cables and cords, be sure to unplug them before moving the TV.

Take Precaution during Installation

To ensure the safety of children and the TV, keep children away from the TV during installation. Climbing on or pushing the TV or its stand may cause it to fall and damage the TV.

To Prevent the TV from Falling

When using the SU-GW12 stand for your TV, you must use the support belt.

As a protective measure, secure the TV as follows.

Using the TV stand with support belts

- Sony strongly recommends using the TV stand SU-GW12 with a support belt designed for your TV.

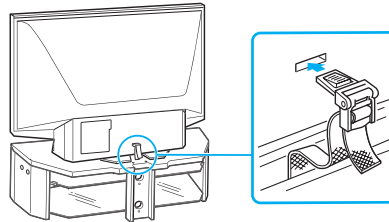

When Installing Your TV Against a Wall

Keep your TV at least 4 inches (10 cm) away from the wall to provide proper ventilation.

Recommended Viewing Area

Your viewing position may affect the picture quality.

For the best picture quality, install your TV within the areas shown below.

Model

KDF-E55A20

KDF-E60A20

Viewing distance

min. 6.8 ft. (approx. 2.1 m)

min. 7 ft. (approx. 2.2 m)

Horizontal Viewing Area

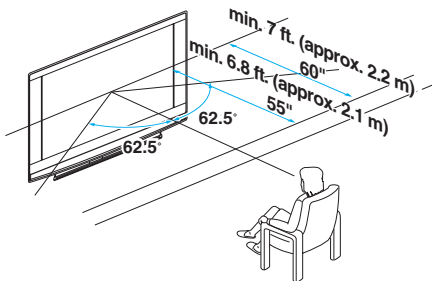

Vertical Viewing Area

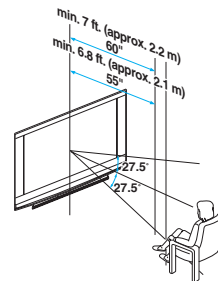

TV Front Panel and Connectors

Front Panel

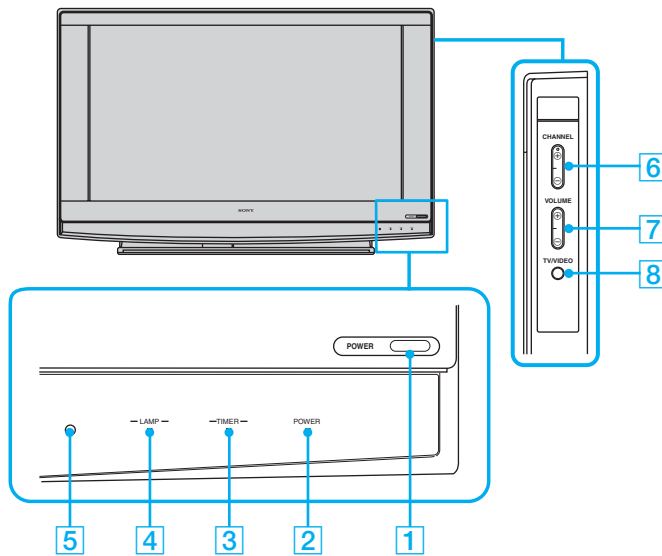

Item	Description
1 POWER	Press to turn on/off the TV.
2 POWER LED	Lights up in green when the TV set is turned on. The LED light does not light up when the main power is turned off. If the LED blinks continuously, this may indicate the display unit needs servicing (see “Contacting Sony” on page 75).
3 TIMER LED	When lit, indicates one of the timers is set. When the timer is set, this LED will remain lit even if the TV set is turned off. For details, see page 73.
4 LAMP LED	Lights up in red when the lamp for the light source has burned out. For details, see “Replacing the Lamp” on page 76.
5 (IR) Infrared Receiver	Receives IR signals from the remote control. Do not put anything near the sensor, as its function may be affected.
6 CHANNEL +/-	Press to scan through channels. To scan quickly through channels, press and hold either CHANNEL.
7 VOLUME +/-	Press to adjust the volume.
8 TV/VIDEO	Press to select among the TV’s tuner and other video equipment inputs.

 The CHANNEL + button has a tactile dot. Use the dot as a reference when operating the TV.

Front and Rear Panel Connectors

Front Panel of TV

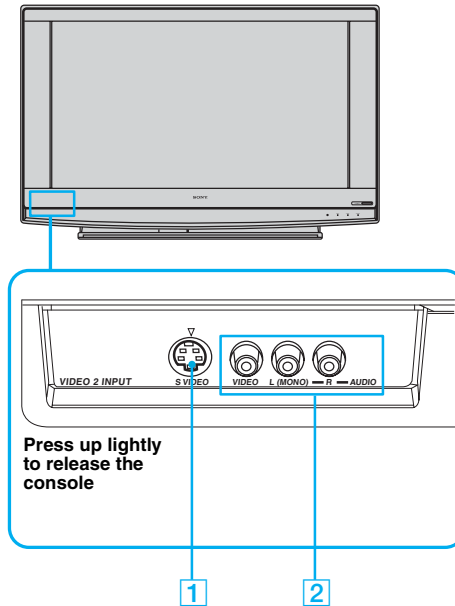

Connection	Description
1 S VIDEO (Front and rear)	Connects to the S VIDEO OUT jack of your VCR or other S VIDEO-equipped video component. Provides better picture quality than the Video IN jack.
2 VIDEO/ L(MONO)-AUDIO-R (Front and rear)	Connects to the audio and video OUT jacks on your VCR or other video component. A fourth video input (VIDEO 2) is located on the front panel of the TV.
3 HD/DVD IN (1080i/720p/480p/480i)	Connects to your DVD player's or digital set-top box's component video (YPbPr) and audio (L/R) jacks.
4 AUDIO OUT (VAR/FIX) L/R	Connects to the left and right audio inputs of your audio or video component.

AUDIO OUT jacks are operable only when the TV's Speaker is set to Off.

(Continued)

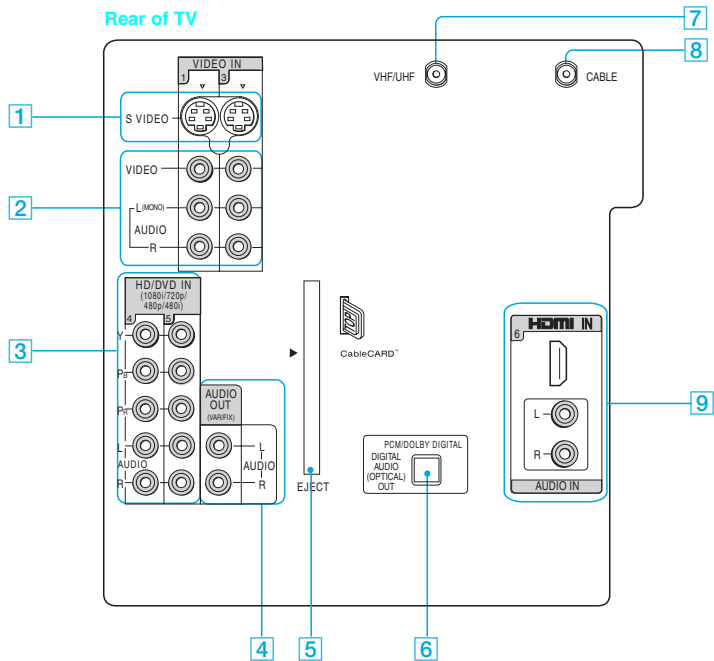

Connection	Description
5 CableCARD slot	CableCARD device provides cable subscribers with access to secure, digitally encrypted cable channels - without the need for a set-top box - that will enable you to receive not only standard definition but also high definition television. For more information, see page 25.
6 DIGITAL AUDIO (OPTICAL OUT) (PCM/DOLBY* DIGITAL)	Connects to the optical audio input of a digital audio component that is PCM/Dolby Digital compatible.
7 VHF/UHF	Connects to your VHF/UHF antenna.
8 CABLE	Connects to your cable signal. This CABLE input jack, in conjunction with the VHF/UHF input jack, lets you set up your TV to switch between scrambled channels (coming through a cable box) and unscrambled cable channels.
9 HDMI (VIDEO 6 IN)	HDMI (High-Definition Multimedia Interface) provides an uncompressed, all-digital audio/video interface between this TV and any HDMI-equipped audio/video component, such as a set-top box, DVD player, and A/V receiver. HDMI supports enhanced, or high-definition video, plus two-channel digital audio.

* Manufactured under license from Dolby Laboratories. “Dolby” and the double-D symbol are trademarks of Dolby Laboratories.

Connecting the TV







Overview

Your new LCD Projection TV can receive both analog and digital broadcasting signals from antenna, satellite and cable TV.

To display clear crisp pictures, you must connect your TV correctly and choose the correct display format (see Wide button on page 50). It is strongly recommended to connect the antenna using a 75-ohm coaxial cable to receive optimum picture quality signal. A 300-ohm twin lead cable can be easily affected by radio noise and the like, resulting in signal deterioration. If you use a 300-ohm twin lead cable, keep it as far away as possible from the TV.

Making Video and Audio Connections

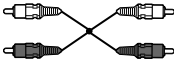
The signals that enter your TV and connected devices will need to output in the correct format using the suitable connections. Below are different types of video connectors available these days. Your TV comes with all types of connectors with the exception of the DVI connector but your cable box or satellite receiver may be equipped with this type. When connecting your TV, use the inputs that are available on your devices that provide the best video performance, as described below.

Best Video Performance	Connector Type	Separate Audio connection required
	 HDMI (High-Definition Multimedia Interface)	No
	 DVI (Digital Visual Interface) *	
	 Component	Yes
	 S VIDEO	 (not supplied)
	 Composite	
	 RF/Coaxial	No

* An adapter is necessary when connecting DVI equipped device to this TV, see page 18.

About Using S VIDEO



If the optional equipment you are connecting has an S VIDEO jack (shown at left), you can use an S VIDEO cable for improved picture quality (compared to an A/V cable). Because S VIDEO carries only the video signal, you also need to connect audio cables for sound, as shown below.

Example of an S VIDEO Connection

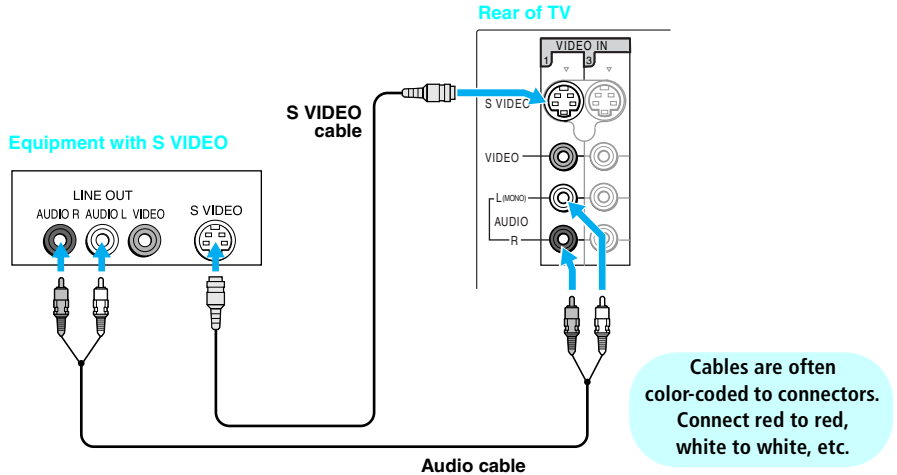

About Using HDMI to DVI Adapter

If you are connecting equipment with DVI connector with this TV, you will need to use an adapter. You can use an HDMI to DVI cable or an HDMI adapter (not supplied). Both are available at your local electronics store. When you use the adapter, you will also need to use separate audio cables for sound as DVI connector is for video signals only.



HDMI to DVI Cable



HDMI adapter

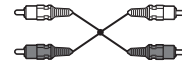

Audio cable

Basic Connections

The way in which you connect your TV will vary, depending on how your home receives a signal (antenna and satellite, cable, cable box) and whether or not you plan to connect a VCR.

<i>If You Are Connecting</i>	<i>See Page</i>
<i>Cable System or VHF/UHF</i>	20
<input type="checkbox"/> No cable box or VCR	
<i>Cable Box and Antenna</i>	21
<input type="checkbox"/> Cable box unscrambles only some channels (usually premium channels)	
<input type="checkbox"/> No VCR	
<i>Cable Box</i>	22
<input type="checkbox"/> Cable box unscrambles all channels	
<input type="checkbox"/> No VCR	
<i>Satellite Receiver</i>	23
<i>Digital Cable Box or Digital Satellite Receiver</i>	24

If you are connecting a VCR

- See the connections described on pages 32 and 33.

Cable System or VHF/UHF

For best results, use this connection if you:

- ❑ Have a cable and/or an antenna.
(This is convenient if you are using a separate rooftop antenna to receive additional channels that are not provided by your cable TV company.)
- ❑ Do not have a cable box or VCR. (If you have a cable box, see pages 21 to 22. If you have a VCR, see pages 32 and 33.)

Antenna System

Cable Type Connect As Shown

Cable TV (CATV) and Antenna

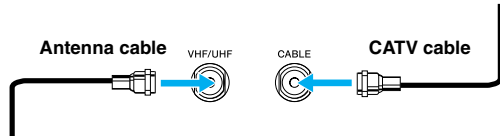

Notes on Using This Connection

To Do This... Do This ...

Switch the TV's input between the cable and antenna Press **ANT** to switch back and forth between the TV's VHF/UHF and CABLE inputs.

Do not use an indoor antenna, which is especially susceptible to radio noise.

Cable Box and Antenna

Before connecting a cable box, see “Using CableCARD Device” on page 25.

For best results, use this connection if:

- ❑ Your cable company scrambles some channels, such as premium channels (which requires you to use a cable box), but does not scramble all channels.
- ❑ You do not have a VCR. (If you have a VCR, see pages 32 and 33.)

With this connection you can:

- ❑ Use the TV’s remote control to change channels coming through the cable box to the TV’s cable input. (You must first program the remote control for your specific cable box; see “Programming the Remote Control” on page 44.)
- ❑ Use the TV’s remote control to change channels coming directly into the TV’s VHF/UHF input jack.

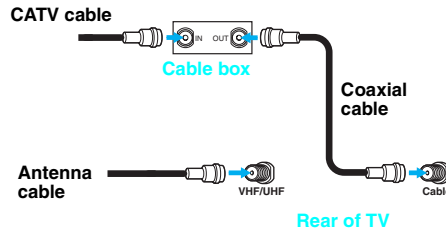

Notes on Using This Connection

To Do This ...	Do This ...
Use the cable box	Tune the TV to the channel the cable box is set to (usually channel 3 or 4) and then use the cable box to switch channels.
Set up the TV remote control to operate the cable box	Program the remote control. See “Programming the Remote Control” on page 44.
Activate the remote control to operate the cable box	Press SAT/CABLE (FUNCTION) once, and the SAT/CABLE indicator lights up.
Prevent the accidental switching of TV channels	When using the cable box, ensure that the TV remains tuned to the channel that the cable box is set to (usually channel 3 or 4).
Switch the TV’s input between the cable box and antenna	Press ANT to switch back and forth between the TV’s VHF/UHF (scrambled channels) and CABLE (unscrambled) inputs.

Cable Box

Before connecting a cable box, see "Using CableCARD Device" on page 25.

For best results, use this connection if:

- ❑ Your cable company scrambles all channels, which requires you to use a cable box.
- ❑ You do not have a VCR. (If you have a VCR, see pages 32 and 33.)

With this connection you can:

- ❑ Use the TV's remote control to change channels coming through the cable box to the TV's VHF/UHF jack. (You must first program the remote control for your specific cable box.)

To connect the cable box

- 1** Connect the CATV cable to the cable box's input jack.
- 2** Use a coaxial cable to connect the cable box's output jack to the TV's VHF/UHF jack.
- 3** Run Auto Program, as described in "Setting Up the TV Channel List" on pages 30.

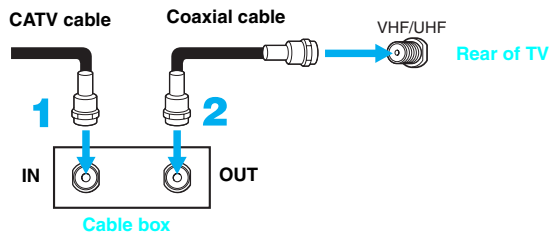

Notes on Using This Connection

To do this...	Do This ...
Use the cable box	Tune the TV to the channel the cable box is set to (usually channel 3 or 4) and then use the cable box to switch channels.
Set up the TV remote control to operate the cable box	Program the remote control. See "Programming the Remote Control" on page 44.
Activate the remote control to operate the cable box	Press SAT/CABLE (FUNCTION) once, and the SAT/CABLE indicator lights up.
Prevent the accidental switching of TV channels	When using the cable box, ensure that the TV remains tuned to the channel that the cable box is set to (usually channel 3 or 4).

Satellite Receiver

Disconnect all power sources before making any connections.

- 1** Connect the satellite antenna cable to the satellite receiver's SATELLITE IN jack.
- 2** Use A/V and S VIDEO cables to connect the satellite receiver's AUDIO and S VIDEO OUT jacks to the TV's AUDIO and S VIDEO IN jacks.
- 3** Use a coaxial cable to connect your cable to the TV's CABLE jack, or your antenna to the TV's VHF/UHF jack.

Rear of TV

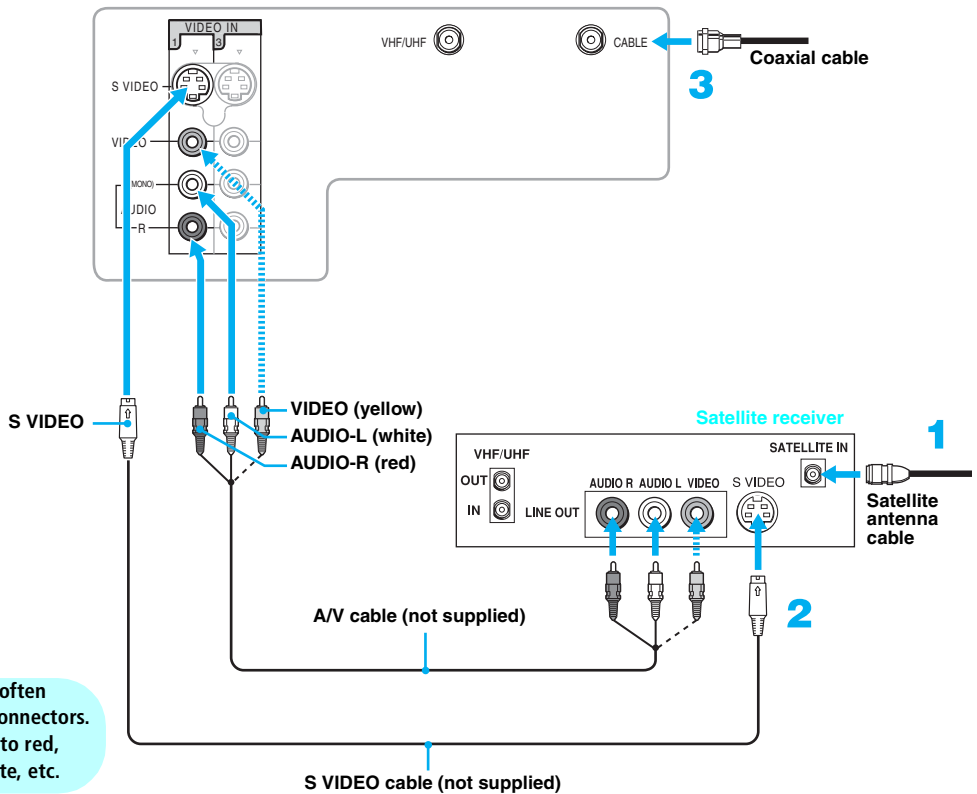

Cables are often color-coded to connectors. Connect red to red, white to white, etc.

If your satellite receiver is not equipped with S VIDEO, use a VIDEO cable (yellow) instead of the S VIDEO cable.

**Digital Cable Box
Or
Digital Satellite
Receiver**

Disconnect all power sources before making any connections.

- 1 Connect the RF coaxial cable from the CATV or Satellite dish to the INPUT of the digital cable box or digital satellite receiver.

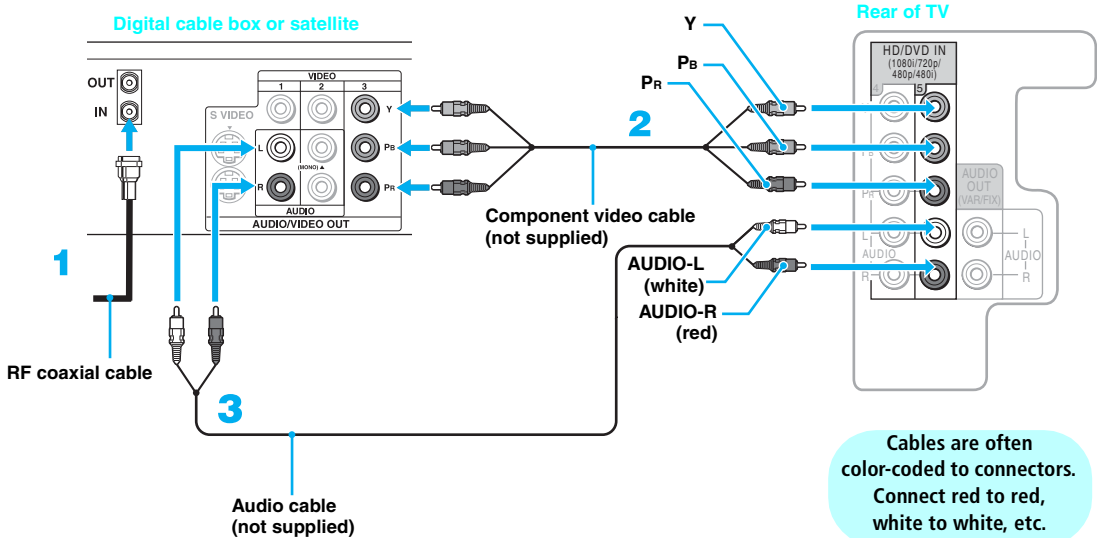

- 2 Use a component video cable to connect the YP_BP_R jacks of your digital cable box or digital satellite receiver to the TV's component jacks.

Component video (YP_BP_R) connection is necessary to view digital broadcastings in 1080i, 720p, 480i and 480p. This TV displays all format types of picture in a resolution of 1,368 dots x 768 lines.

- 3 Use an audio cable to connect the AUDIO OUT jack of the digital cable box or digital satellite receiver to the TV's AUDIO IN jacks.

The component Jacks (YP_BP_R) do not provide audio, so audio cables must be connected to provide sound.

Using CableCARD Device

The CableCARD device provides cable subscribers with access to digitally encrypted cable channels — without the need for a set-top box — that will enable you to receive not only standard definition but also high definition television. The CableCARD device, which is provided by your cable TV company, is inserted into the TV's rear panel CableCARD slot. After the service is activated with your cable TV company, the card replaces the need for a separate set-top box.

About Using CableCARD Device

If you are planning to use a separate cable box for digital cable TV services, you may be able to receive programming using this TV with the CableCARD device instead — except in the following circumstances:

- ❑ Your cable TV company does not provide CableCARD service in your viewing area.
- ❑ You want to access your cable TV company's interactive or advanced features (such as video-on-demand or, in some cases, pay-per-view). At this time, these services require a bidirectional link, which are only available through the use of a separate set-top box. CableCARD device is currently a unidirectional device only, and cannot provide these advanced services.

Check with your cable TV company for CableCARD service details, limitations, pricing, and availability, all of which are determined by your cable TV company — not Sony.

Activating CableCARD Service

Before you can use CableCARD service, you need to insert the CableCARD device (supplied by your cable TV company) and activate the service, as described below:

- 1 Insert the CableCARD device into the TV's CableCARD slot.

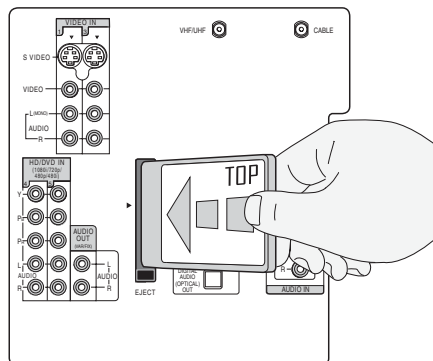

CAUTION: Inserting the CableCARD device incorrectly may result in permanent damage to the card and the TV.

(Continued)

 You can also access information about your CableCARD device in the Applications Menu (see page 74).

- 2** Gently push the card into the slot until it locks into place.
- 3** After 1-2 minutes, the CableCARD device setup screen is automatically displayed. This screen includes information your cable TV company will request before they can activate your service.
- 4** Follow the displayed instructions: Phone your cable TV company. A representative will guide you through the activation process.
- 5** After your CableCARD device is activated, your cable TV company will download the service information, including the channel list, to the CableCARD device. After the CableCARD device has acquired channels from your cable TV company, the TV tunes to the lowest available channel.

Removing the CableCARD Device

In the event you want to cancel your service, contact your cable TV company.

 Once the CableCARD device is removed, your TV will no longer decrypt digital cable TV programming services that require CableCARD device.

- 1** Push the eject button on the TV's CableCARD slot to release the card.

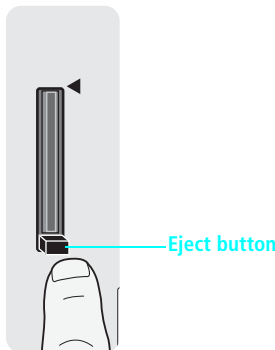

- 2** Pull the CableCARD device straight out of the slot to remove it.
- To install a different CableCARD device, follow the instructions in “Activating CableCARD Service” on page 25.

Equipment with HDMI Connection

Use this hookup if:

- Your equipment has a High-Definition Multimedia Interface (HDMI).

Disconnect all power sources before making any connections

Use an HDMI cable (not supplied) to connect the equipment's HDMI OUT jack to the TV's HDMI IN jack.

Use the HDMI IN 6 input connection.

 The HDMI jack provides both video and audio signals, so it is not necessary to connect the audio cable.

Equipment with HDMI output

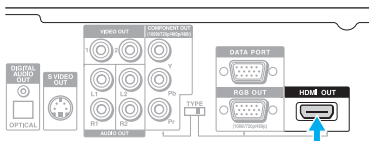

Rear of TV

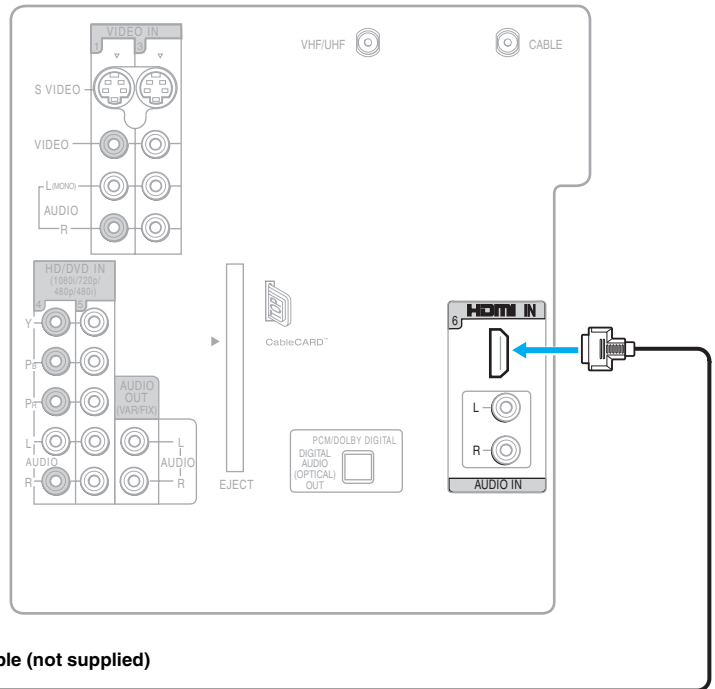

Equipment with DVI Connection

If you are connecting with DVI-HDTV output, you can connect to the TV's HDMI IN jack by using an HDMI-to-DVI cable or an adaptor (both not supplied).

Equipment with HDMI output

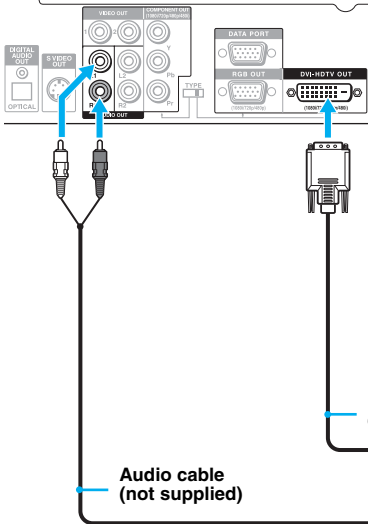

Rear of TV

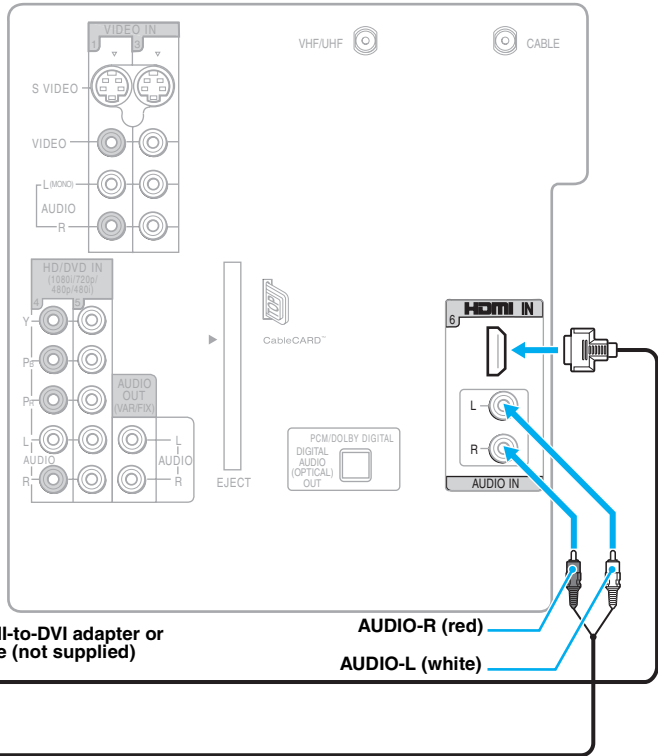

⚠ When using a DVI-HDMI cable or an adaptor, be sure to connect the DVI output connector first; then connect to the HDMI input on your TV.

Equipment with Digital Audio (Optical)

You can use the TV's DIGITAL AUDIO (OPTICAL) OUT jack to connect a digital audio device that is PCM/Dolby Digital compatible, such as an audio amplifier.

Use an optical audio cable to connect the device's OPTICAL IN jack to the TV's DIGITAL AUDIO (OPTICAL) OUT jack.

Rear of TV

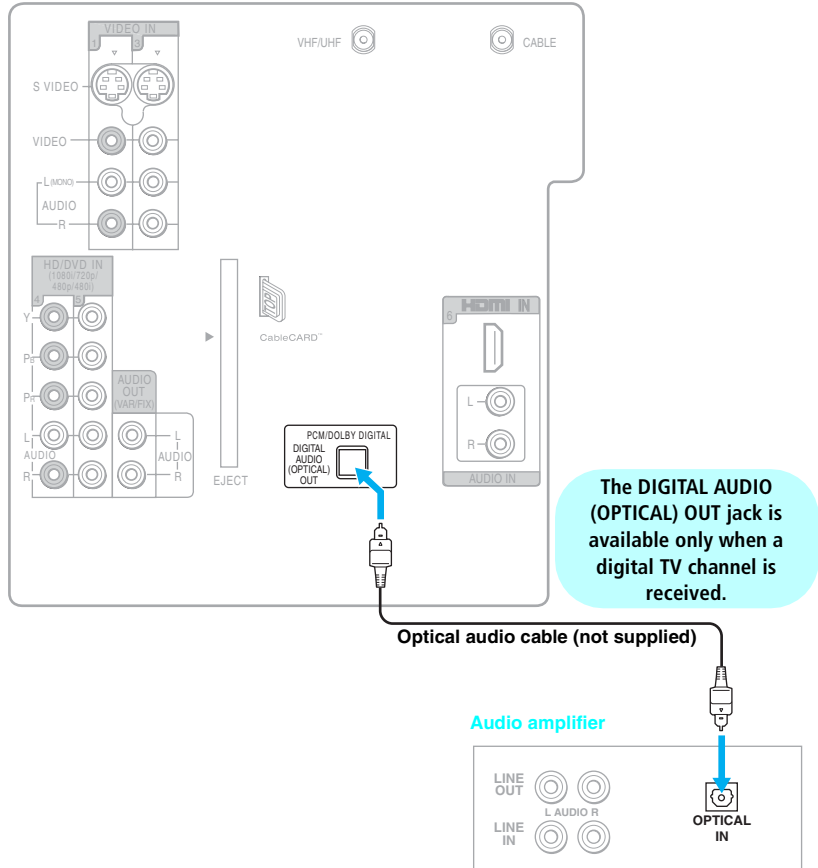







Setting Up the TV Channel List

After you finish connecting the TV, you can run the Initial Setup to create a list of available analog and digital channels. The Initial Setup screen appears when you turn on the TV for the first time after hooking it up. If you choose to set up the channels at a later time select the Auto Program option in the Channel menu to scan available channels (see below).

 The Auto Program feature does not apply for installations that use a cable box for all channel selection.

Using Initial Setup

To run Initial Setup the first time you turn on your TV

- 1 Press  to turn on the TV. The Initial Setup screen appears.
- 2 Press  or  to highlight the on-screen display language. Then press . The message “First please connect cable/antenna” appears. This may require 50+ minutes for completion and “Start auto program now?” appears.
- 3 Press  or  to highlight “Yes” then press .



Auto Program performed through Initial Setup will automatically create a list of receivable channels from both VHF/UHF antenna and cable TV channels if both sources are connected.

 Auto Program may take a while (20 to 50 minutes) to complete. A progress bar is displayed while available channels are being scanned. If you cancel the Auto Program before all receivable channels are scanned, you may want to perform the task later (see “To run Auto Program at a later time” below).

 If you selected “No” during the Initial Setup, the Initial Setup message will appear each time you turn on the TV until you complete the Auto Program as a reminder.

To run Auto Program at a later time

- 1 Select Settings in WEGA GATE, and then go to Channel settings.
- 2 Select Auto Program then select Start.

 Auto Program will create a list of receivable channels for the current input (UHF/VHF antenna or CABLE). You will be required to run Auto Program for each RF input to create a list of available channels from both inputs.

Connecting Optional Equipment

You can connect variety of optional equipment to your TV. This section provides some of the individual connections you can have. For multiple connections please refer to the Quick Setup Guide.

<i>If You Are Connecting</i>	<i>Page</i>
VCR and Cable	32
VCR and Cable Box	33
Two VCRs for Tape Editing	35
DVD Player with Component Video Connectors	36
DVD Player with S VIDEO and Audio Connectors	37
Camcorder or PlayStation	38
Audio Receiver	39

VCR and Cable

Use this hookup if:

- ❑ You have cable TV that does not require a cable box.

Disconnect all power sources before making any connections.

- 1** Connect the CATV cable to the single (input) jack of the splitter.
- 2** Use a coaxial cable to connect one of the output jack of the splitter to the TV's CABLE jack.
- 3** Use a coaxial cable to connect the splitter's other output jack to the VCR's input jack.
- 4** Use A/V and S VIDEO cables to connect the VCR's AUDIO and S VIDEO OUT jacks to the TV's AUDIO and S VIDEO IN jacks.

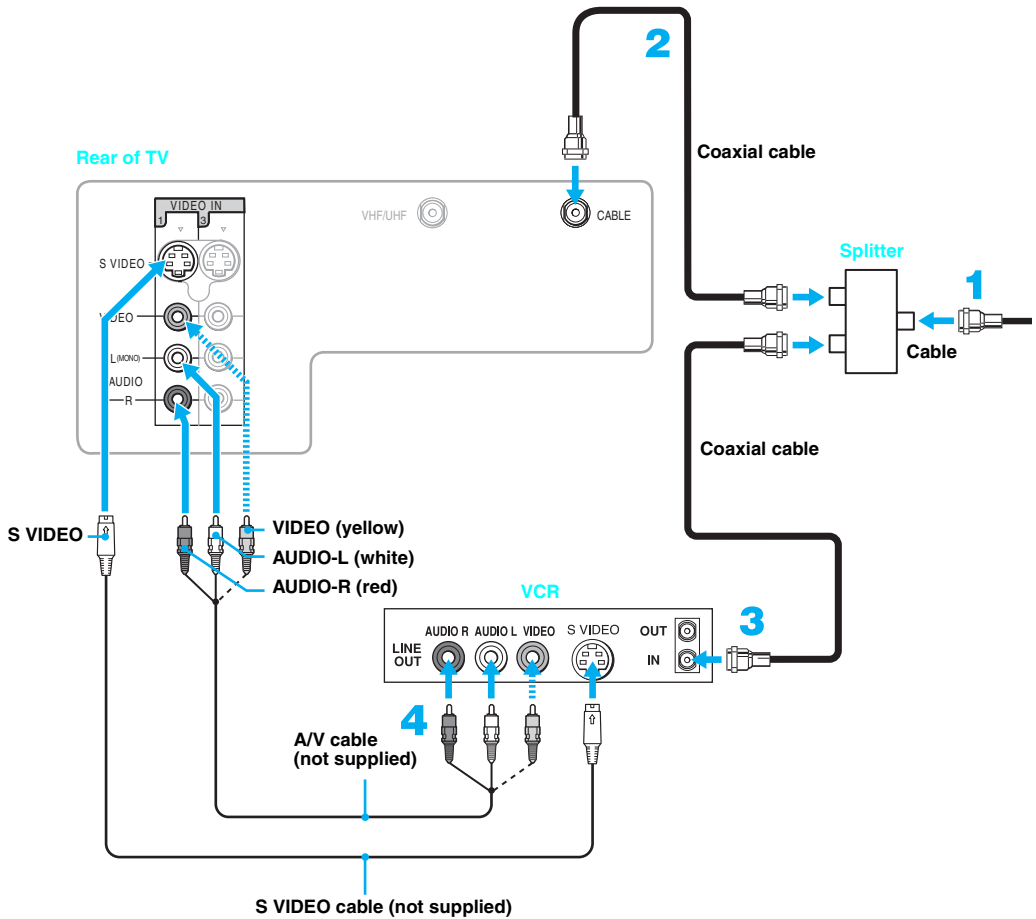

 If your VCR is not equipped with S VIDEO, use a VIDEO cable (yellow) instead of the S VIDEO cable.

VCR and Cable Box

Before connecting a cable box, see “Using CableCARD Device” on page 25.

Use this hookup if:

- ❑ Your cable TV company scrambles some channels, but not all of them (pay channels vs. regular cable channels) and you need to use a cable box.

With this setup you can:

- ❑ Use the TV’s remote control to change channels on your cable box when the signal is scrambled. To program your Sony remote control to operate your cable box, see “Programming the Remote Control” on page 44.
- ❑ Use the TV’s remote control to change channels on your TV when the signal is not scrambled. Your TV’s tuner provides a better picture quality than the output of your cable box.

Disconnect all power sources before making any connections.

- 1** Connect the CATV cable to the single (input) jack of the splitter.
- 2** Use a coaxial cable to connect one of the splitter’s two output jacks to the TV’s CABLE jack.
- 3** Use a coaxial cable to connect the splitter’s other output jack to the cable box’s input jack.
- 4** Use a coaxial cable to connect the cable box’s output jack to the VCR’s RF input jack.
- 5** Use an A/V cable to connect the cable box’s A/V output jacks to the TV’s A/V input jacks.
- 6** Use an A/V and S VIDEO cables to connect the VCR’s AUDIO and S VIDEO OUT jacks to the TV’s AUDIO and S VIDEO IN input jacks.
- 7** Run Auto Program, as described in “Setting Up the TV Channel List” on page 30.

 To view scrambled channels, tune the TV to the channel the cable box is set to (usually channel 3 or 4) and then use the cable box to switch channels.

(Continued)

Connecting the TV

Cables are often color-coded to connectors. Connect red to red, white to white, etc.

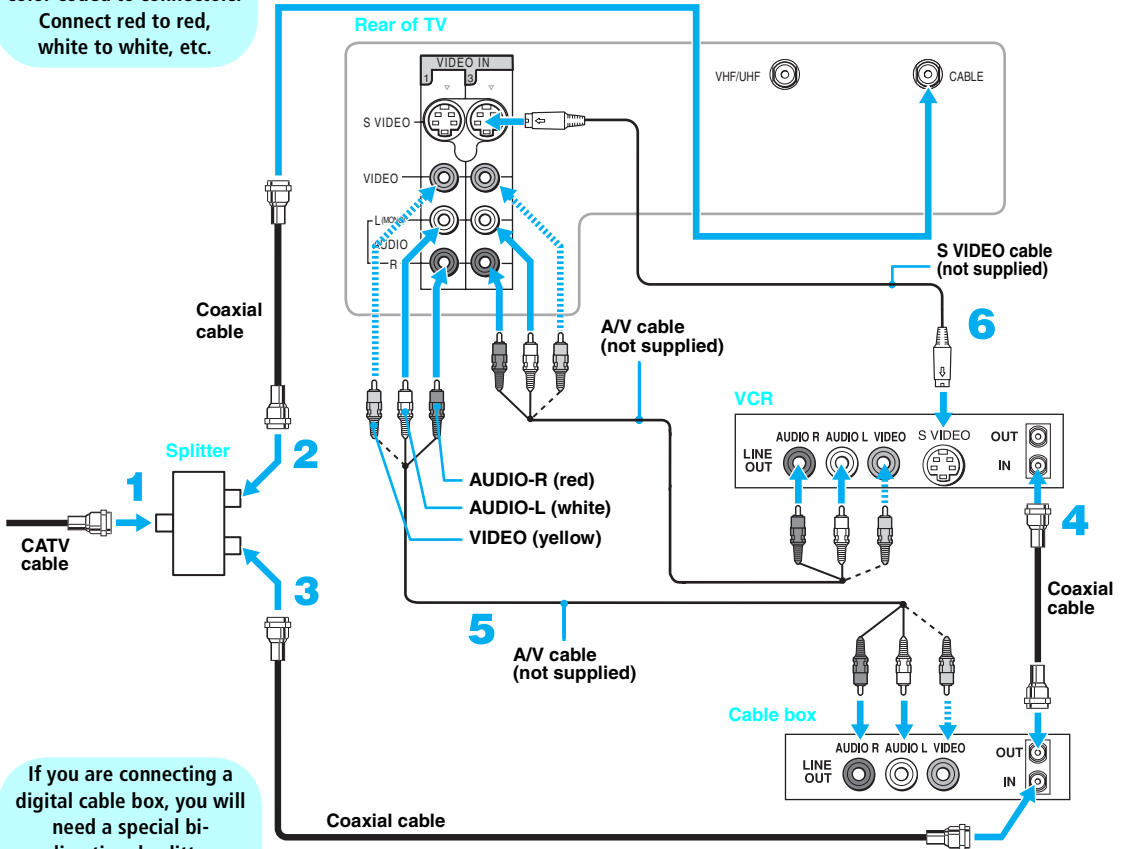

If you are connecting a digital cable box, you will need a special bi-directional splitter designed to work with your cable box.

 If your VCR is not equipped with S VIDEO, use a VIDEO cable (yellow) instead of the S VIDEO cable.

Two VCRs for Tape Editing



Using
S VIDEO jacks?
See page 18.

Cables are often
color-coded to connectors.
Connect red to red,
white to white, etc.

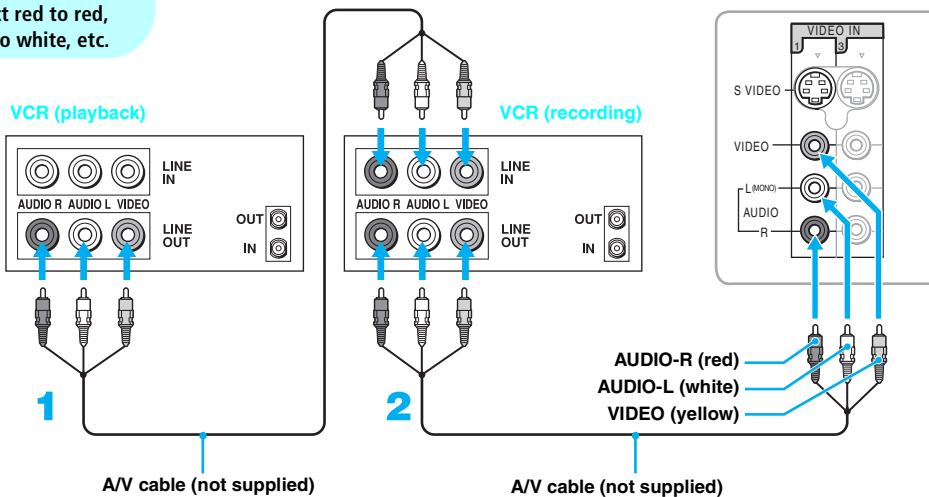

If you connect two VCRs, you can record from one VCR to the other while using your TV to monitor what is being recorded.

Disconnect all power sources before making any connections.

- 1 Use A/V cables to connect the playback VCR's AUDIO and VIDEO OUT jacks to the recording VCR's AUDIO and VIDEO IN jacks.
- 2 Use A/V cables to connect the recording VCR's AUDIO and VIDEO OUT jacks to the TV's AUDIO and VIDEO IN jacks.

- ✎ To perform tape editing, set the TV to the video input intended for playback by pressing TV/VIDEO on the remote control.
- ✎ You may need to change the video input on your VCR. Consult your VCR's operating manual for instructions.
- ✎ If your VCRs have S VIDEO jacks: For best picture quality, use an S VIDEO connection instead of the yellow video cable on your combined A/V cable.
Use an S VIDEO cable to connect the playback VCR's S VIDEO OUT jack to the recording VCR's S VIDEO IN jack. S VIDEO does not provide audio, so audio cables must be connected to provide sound.
- ✎ You cannot record signals from equipment connected to the YP_BP_R input.

DVD Player with Component Video Connectors

Cables are often color-coded to connectors. Connect red to red, white to white, etc.

Use this hookup if:

- Your DVD player has component (Y, B-Y, R-Y) jacks.

Disconnect all power sources before making any connections.

- 1 Use a component video cable to connect the DVD player's Y, B-Y and R-Y jacks to the TV's YPBPr jacks. Use the HD/DVD IN 4 or 5 connections.

 The Y, B-Y and R-Y jacks on your DVD player are sometimes labeled Y, C_B and C_R, or YP_BP_r. If so, connect the cables to like colors.

- 2 Use an audio cable to connect the DVD player's AUDIO OUT jacks to the TV's AUDIO IN jacks. Be sure to use the same row of inputs that you used for the video connection (HD/DVD IN 4 or 5).

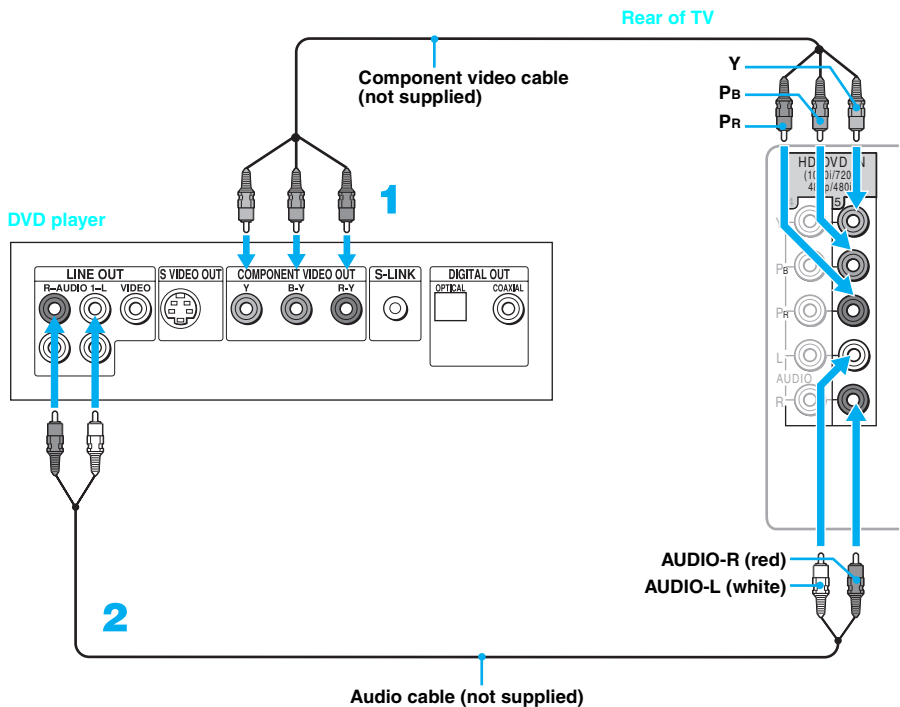

 To take advantage of the Wide Mode feature on your TV, set the DVD player's aspect ratio to 16:9. For details, refer to the operating instructions supplied with your DVD player.

DVD Player with S VIDEO and Audio Connectors

Cables are often color-coded to connectors. Connect red to red, white to white, etc.

Use this hookup if:

- Your DVD player does not have component (Y, B-Y, R-Y) jacks.

Disconnect all power sources before making any connections.

- 1** Use an audio cable to connect the DVD player's AUDIO OUT jacks to the TV's AUDIO IN jacks.
- 2** Use a S VIDEO cable to connect the DVD player's S VIDEO jack to the TV's S VIDEO jack.

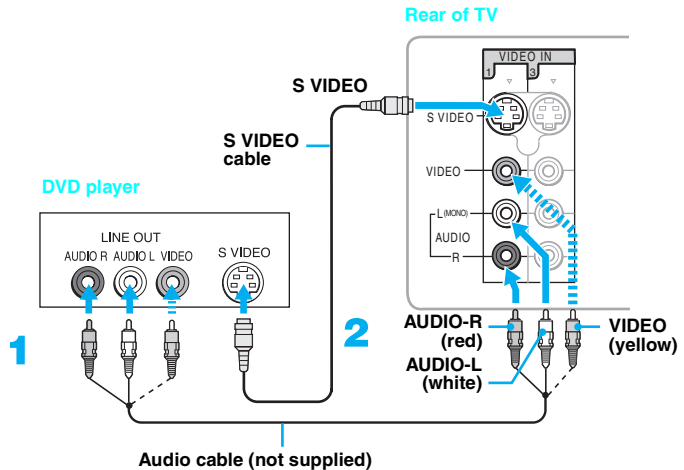

- ✎ If your DVD player is not equipped with S VIDEO, use a VIDEO cable (yellow) instead of the S VIDEO cable.
- ✎ To watch a DVD, press TV/VIDEO repeatedly to select the DVD input (VIDEO 1 in the illustration). If you have a non-Sony DVD player, and want to set up the TV remote control to operate the DVD player you must program the remote control. See “Programming the Remote Control” on page 44.
- ✎ To control DVD functions with the TV remote control, see “Operating a DVD Player or DVD Changer” on page 46.
- ✎ Label Video Inputs to easily identify equipment connected to the TV. See the instructions for setting up Video Labels on page 70.

Camcorder or PlayStation

Disconnect all power sources before making any connections.

For easy connection to a camcorder or PlayStation, the TV has front audio and video inputs (shown below).

Use A/V and S VIDEO cables to connect the camcorder or PlayStation's AUDIO and S VIDEO OUT jacks to the TV's AUDIO and S VIDEO IN jacks.

 If your camcorder is not equipped with S VIDEO, use a VIDEO cable (yellow) instead of the S VIDEO cable.

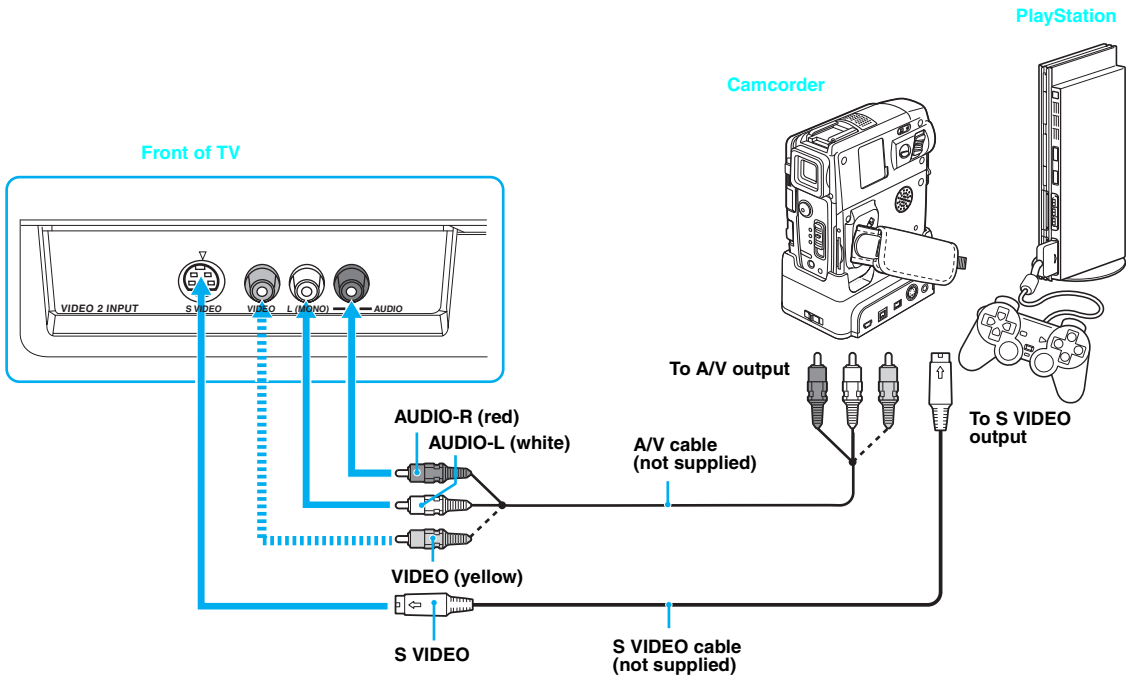

Audio Receiver

For improved sound quality, you may want to play the TV's audio through your stereo system (see page 61).

Disconnect all power sources before making any connections.

Use A/V cables to connect the TV's AUDIO OUT (VAR/FIX) jacks to the audio receiver's audio LINE IN jacks.

 AUDIO OUT jacks are operable only when the TV's Speaker is set to Off.

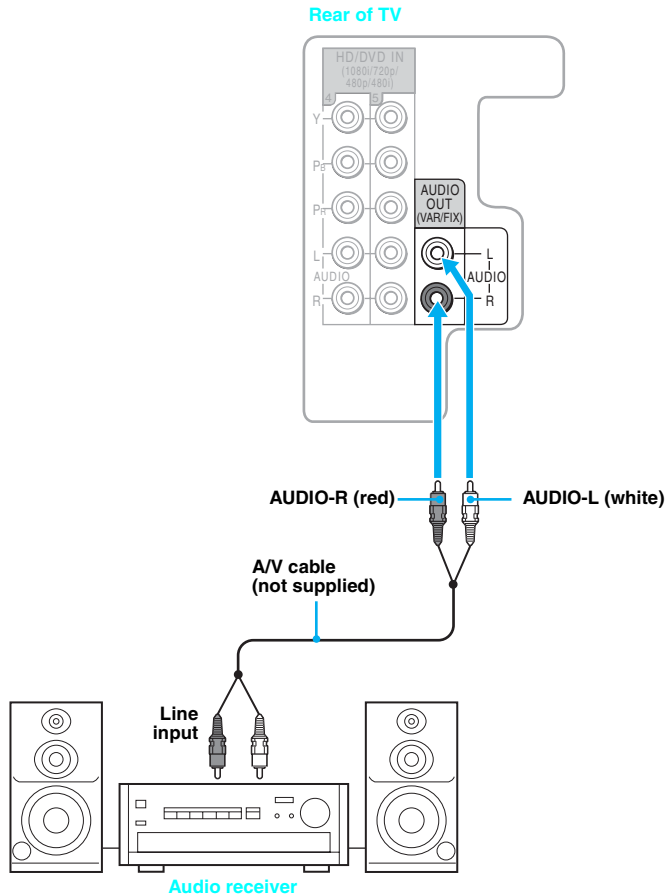

Watching the TV

Overview

The table on the next page describes the buttons on the remote control.

Topic	Page
Inserting Batteries into the Remote Control	41
Button Descriptions	42
Programming the Remote Control	44
Manufacturer's Codes	45
Using Other Equipment with Your Remote Control	46
Using Special Buttons	48

Inserting Batteries into the Remote Control

Insert two size AA (R6) batteries (supplied) by matching the **+** and **-** on the batteries to the diagram inside the battery compartment.

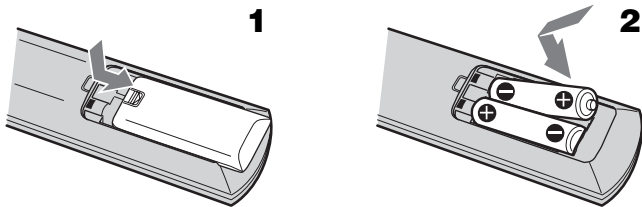

- ✎ To avoid possible damage from battery leakage, remove the batteries if you anticipate the remote control will not be used for an extended period.
- ✎ Handle the remote control with care. Avoid dropping it, getting it wet, or placing it in direct sunlight, near a heater, or in high humidity.
- ✎ Your remote control can be programmed to operate most video equipment. (See “Programming the Remote Control” on page 44.)

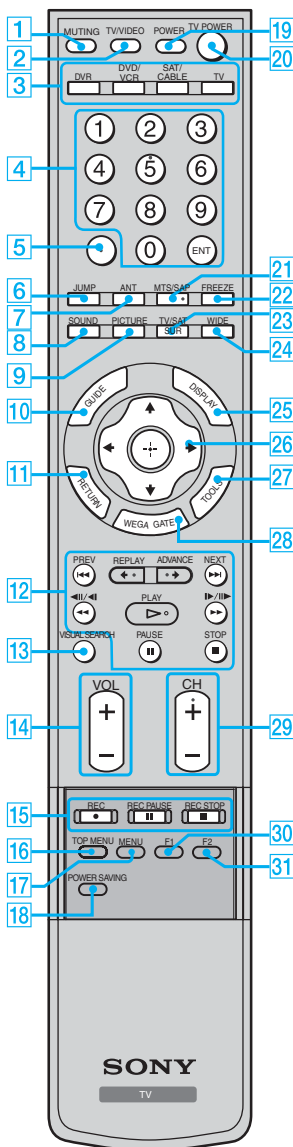

Button Descriptions



Button	Description
1 MUTING	Press to mute the sound. Press again or press VOL + to unmute.
2 TV/VIDEO	Press to cycle through the video equipment connected to your TV's video inputs.
3 FUNCTION Buttons	The FUNCTION button indicator lights up momentarily when pressed to show which external equipment the remote control is operating. When the remote control is set to operate the external equipment these buttons will operate the equipment you choose. You must first press one of these FUNCTION buttons to operate the corresponding equipment. See page 44 for "Programming the Remote Control".
4 0-9, ENT	Press 0-9 to select a channel: the channel changes after 2 seconds. Press ENT to change channels immediately.
5 .	Use . with 0-9 and ENT buttons to select digital channels (for example, 2.1). For details on selecting digital channels, see page 48.
6 JUMP	Press to jump back and forth between two channels. The TV alternates between the current channel and the last channel that was selected.
7 ANT	Press to change between the VHF/UHF input and the CABLE input.
8 SOUND	Press to cycle through different sound settings: Dynamic for enhanced treble and bass, Standard for spoken dialog and Custom for flat setting.
9 PICTURE	Press repeatedly to cycle through the available video picture modes: Vivid , Standard , Custom . The video picture modes can be also accessed in the Video menu. For details, see "Selecting Video Options" on page 58.
10 GUIDE	Press to display the TV's program guide.
11 RETURN	Press to return to normal viewing.
12 DVR, DVD/VCR Operating Buttons	When FUNCTION is switched on DVR or DVD/VCR , these buttons operate the video equipment you have programmed into the remote control. For details, see "Using Other Equipment with Your Remote Control" on page 46. ◀◀ PREVIEW : Press to replay the current program from the previous Chapter Mark (if any) or from the beginning of the live TV cache. ◀•REPLAY : Press to replay the current program for a set period of time. •▶ ADVANCE : Press to advance forward a set period of time when playing back a recorded program. ▶▶ NEXT : Press to advance forward to the next Chapter Mark (if any) or to live TV when playing back a recorded program. ◀◀ (fast reverse) : Press to play a program in fast rewind mode. ▶▶ PLAY : Press to play a program at a normal speed. ▶▶ (fast forward) : Press to play a program in fast forward mode. PAUSE : Press to pause playback. ■ STOP : Press to stop the playback of a recorded program.
13 VISUAL SEARCH	To be used only with your connected external equipment with visual search function. (Non-operable button for TV)
14 VOL +/-	Press to adjust the volume.

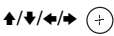
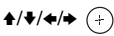

The **5** button, **CH +** button, **MTS/SAP** button and **PLAY** button have a tactile dot. Use the dot as a reference when operating the TV.

Button	Description
15 DVD/VCR Record Buttons	<ul style="list-style-type: none"> ● REC: Press to record. By pressing this button alone will start the recording. ▄▄ REC PAUSE: Press to pause the recording. ■ REC STOP: Press to stop the recording.
16 TOP MENU	Press to display the disc menu from your connected DVD player.
17 MENU	Press to display the menu of your connected DVD player.
18 POWER SAVING	Press to cycle through Standard and Reduced to benefit the power consumption. For additional benefits see page 71.
19 POWER	Press to turn on/off the external equipment selected from the FUNCTION button 3 .
20 TV POWER	Press to turn on/off the TV.
21 MTS/SAP	Press repeatedly to cycle through the Multi-channel TV Sound (MTS) options: Stereo , Auto SAP (Second Audio Program), and Mono . The MTS setting can be also accessed in the Audio menu. For more details, see “Selecting Audio Options” on page 60.
22 FREEZE	Press to freeze the current picture. Press again to restore the picture. For details, see “Using the FREEZE Button” on page 51.
23 SUR/TV/SAT	<p>SUR: Press SUR (Surround Sound) repeatedly to step through the available audio effect models: TruSurround XT, Simulated, Off.</p> <p>TV/SAT: While in SAT/CABLE FUNCTION, press to switch between the satellite receiver and antenna.</p>
24 WIDE	Press repeatedly to step through the Wide Screen Mode setting: Wide Zoom , Normal , Full and Zoom . The Wide Screen Mode setting can be also accessed in the Screen menu. For details, see “Using the WIDE Button” on page 50.
25 DISPLAY	Press once to display channel number, label, current time and other information. Press again to turn Display off. See page 73 for details on setting the time.
26 	Press  to move the on-screen cursor. To select an item, press  .
27 TOOLS	To be used only with your connected external equipment that supports this TOOLS function. (This button does not operate for the TV.)
28 WEGA GATE	<p>Press to access the following through the WEGA GATE menu:</p> <ul style="list-style-type: none"> Watch TV (see pages 54 and 55) Select channels from the Favorite Channels you stored (see page 54) View signals from external equipment such as DVD, VCR and others (see page 55). Adjust or customize TV settings (see Using the Settings on page 56 through 74).
29 CH +/-	Press to scan through channels. To scan quickly through channels, press and hold down either CH button.
30 F1	Press to select the function of connected components. For details, see “Using Other Equipment with Your Remote Control” on page 46.
31 F2	Press to select the function of connected components. For details, see “Using Other Equipment with Your Remote Control” on page 46.

Programming the Remote Control

The remote control is preset to operate Sony brand video equipment.

Sony Equipment	Programmable Code Number
DVR	772
DVD/VCR	601 (Sony Dream System)
SAT/Cable	801 (Sony Satellite Receiver)

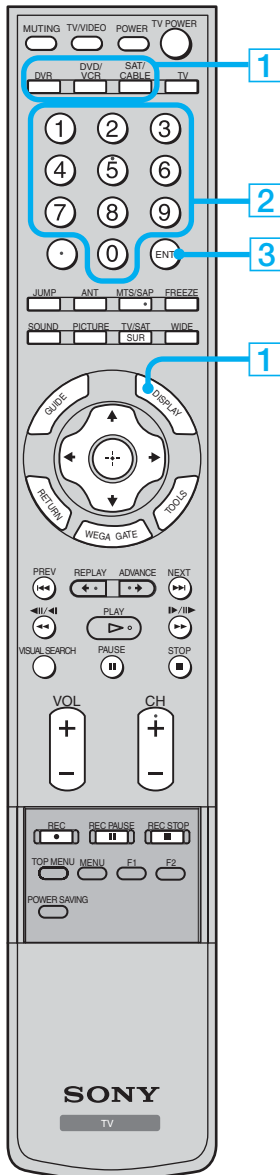



Follow the steps below to program your TV's remote control to operate the other video equipment.

Find the three-digit code for your equipment from the "Manufacturer's Codes" listed on page 45. If more than one code number is listed, try entering from the code listed first.

- 1** Press and hold the **DVR**, **DVD/VCR** or **SAT/CABLE** **FUNCTION** button you want to program on the remote control and press the **ENT** button simultaneously. The selected **FUNCTION** button (DVR, DVD/VCR or SAT/CABLE) will flash.
- 2** Enter the three-digit manufacturer's code number using the **0** – **9** buttons while the button is lit. If code is not entered within 10 seconds, you must perform the step 1 again.
- 3** Press **ENT** button.
When programmed correctly, the selected **FUNCTION** button will flash twice, and when not, it flashes five times.

To check if the code works

Aim your TV's remote control at the equipment, and press the green **POWER** button. If the equipment turns on and off, the programming is completed. If not, try the next code listed.

-  If no code is input within the above specified time, or an invalid or incorrect code number is input, the remote control automatically goes back to the previous setting.
-  In some cases, you may not be able to program your remote control to operate other equipment. In such cases, use the equipment's own remote control.
-  Removing the batteries or using dead batteries may cause the programmed codes to be lost and revert back to the factory setting. Reprogramming the codes may be necessary.

Manufacturer's Codes

DVD Players

Manufacturer	Code
Sony	751
General Electric	755
Hitachi	758
JVC	756
Magnvox	757
Mitsubishi	761
Panasonic	753
Philips	757
Pioneer	752, 778
RCA/PROSCAN	755
Samsung	758
Toshiba	754
Zenith	760

DVD Changers

Manufacturer	Code
Sony	765
Panasonic	766

DVD/VCR Combo Units

Manufacturer	Code
Sony	767
Broksonic	776
JVC	775
Panasonic	777
Samsung	774
Toshiba	773
Zenith	768

HDD/DVD Combo Units

Manufacturer	Code
Sony	772, 770, 771

5.1ch DVD AV System

Manufacturer	Code
Sony (DAV)	601, 602, 603, 604

AV Receivers

Manufacturer	Code
Sony	764

VCRs

Manufacturer	Code
Sony	301, 302, 303
Admiral (M. Ward)	327
Aiwa*	338, 344
Audio Dynamic	314, 337
Broksonic	319, 317

Manufacturer	Code
Canon	309, 308
Citizen	332
Craig	302, 332
Curtis Mathes	304, 338, 309
Daewoo	341, 312, 309
DBX	314, 336, 337
Dimensia	304
Emerson	319, 320, 316, 317, 318, 341
Fisher	330, 335
Funai	338
General Electric	329, 304, 309
Go Video	322, 339, 340
Goldstar	332
Hitachi	306, 304, 305, 338
Instant Replay	309, 308
JC Penney	309, 305, 304, 330, 314, 336, 337
JVC	314, 336, 337, 345, 346, 347
Kenwood	314, 336, 332, 337
LG	332
LXI (SEARS)	332, 305, 330, 335, 338
Magnavox	308, 309, 310
Marantz	314, 336, 337
Marta	332
Memorex	309, 335
Minolta	305, 304
Mitsubishi/MGA	323, 324, 325, 326
Multitech	325, 338, 321
NEC	314, 336, 337
Olympic	309, 308
Optimus	327
Orion	317
Panasonic	308, 309, 306, 307
Pentax	305, 304
Philco	308, 309
Philips	308, 309, 310
Pioneer	308
Quasar	308, 309, 306
RCA/PROSCAN	304, 305, 308, 309, 311, 312, 313, 310, 329
Realistic	309, 330, 328, 335, 324, 338
Sansui	314
Samsung	322, 313, 321
Sanyo	330, 335

Manufacturer	Code
Scott	312, 313, 321, 335, 323, 324, 325, 326
Sharp	327, 328
Signature 2000 (M. Ward)	338, 327
SV2000	338
Sylvania	308, 309, 338, 310
Symphonic	338
Tashiro	332
Tatung	314, 336, 337
Teac	314, 336, 338, 337
Technics	309, 308
Toshiba	312, 311
Wards	327, 328, 335, 331, 332
Yamaha	314, 330, 336, 337
Zenith	331

Cable Boxes

Manufacturer	Code
Sony	230
Hamlin/Regal	222, 223, 224, 225, 226
Jerrold/ General Inst./	201, 202, 203, 204, 205, 206,
Motorola	207, 208, 218, 222
Oak	227, 228, 229
Panasonic	219, 220, 221
Pioneer	211, 214, 215
Scientific Atlanta	209, 210, 211
Tocom	216, 217
Zenith	212, 213

Satellite Receivers

Manufacturer	Code
Sony	801
Dish Network	810
Echostar	810
General Electric	802
Hitachi	805
Hughes	804
Mitsubishi	809
Panasonic	803
Philips	811
RCA/PROSCAN	802, 808
Toshiba	806, 807
Samsung	812

* If an Aiwa VCR does not work even though you enter the code for Aiwa, enter the code for Sony instead.

Using Other Equipment with Your Remote Control

To operate other connected equipment with your TV, first turn to page 44 and program the necessary code. For operating video equipment, press **TV/VIDEO** repeatedly until you see the video input on the screen for your connected equipment. Remote control operation tips are provided below.

Operating a Cable Box

To Do This ...	Press
Activate the remote control to operate the cable box	SAT/CABLE (FUNCTION)
Turn on/off	POWER

Operating a Satellite Receiver

To Do This ...	Press
Activate the remote control to operate the satellite receiver	SAT/CABLE (FUNCTION)
Turn on/off	POWER
Select a channel	0-9, ENT
Change channels	CH +/-
Back to previous channel	JUMP

Operating a VCR

To Do This ...	Press
Activate the remote control to operate the VCR	DVD/VCR (FUNCTION)
Turn on/off	POWER
Change channels	CH +/-
Record	●
Play	▷
Stop	■

Operating a DVD Player or DVD Changer

To Do This ...	Press
Activate the remote control to operate the DVD	DVD/VCR (FUNCTION)
Turn on/off	POWER
If you have a DVD changer, to skip disk	F1
Play	▷
Stop	■
Pause	(press again to resume normal playback)

To Do This ...	Press
Select a channel	0-9, ENT
Change channels	CH +/-
Back to previous channel	JUMP

To Do This ...	Press
Display channel number	DISPLAY
Display SAT Guide	GUIDE
Display SAT Menu	MENU
Move highlight (cursor)	↑ ↓ ← →
Select item	⊕

To Do This ...	Press
Fast forward	▶▶
Rewind the tape	◀◀
Pause	(press again to resume normal playback)
Search the picture forward or backward	▶▶ or ◀◀ during playback (release to resume normal playback)

To Do This ...	Press
Step through different tracks of the disc	▶▶ to fast forward or ◀◀ to fast reverse
Step through different chapters of the disc	▶▶ to step forward or ◀◀ to step backward
Select a track directly	0-9, ENT
Display the disc menu	MENU
Display the Top menu	TOP MENU
Operate the DVD menu	↑ ↓ ← →, ⊕

Operating a 5.1ch DVD AV System (Sony DAV)

To Do This ...	Press
Activate the remote control to operate the DVD	DVD/VCR (FUNCTION)
Turn on/off	POWER
Select other equipment connected to the DAV	F1
Skip a disc	F2
Display the Top menu	TOP MENU
Display the disc menu	MENU

Operating a DVD/VCR Combo Unit

To Do This ...	Press
Activate the remote control to operate the DVD/VCR	DVD/VCR (FUNCTION)
Turn on/off	POWER
If you have a DVD/VCR combo component,	
Select the DVD	F1
Select the VCR	F2
Display the Top menu	TOP MENU
Display the disc menu	MENU
Play	▷
Stop	■

Operating an AV Receiver

To Do This ...	Press
Activate the remote control to operate the AV Receiver	DVD/VCR (FUNCTION)
Turn on/off	POWER
Change the volume	VOL +/-, MUTING
Select other equipment connected to the AV Receiver	F1

To Do This ...	Press
Play	▷
Stop	■
Pause	⏸
Search the picture forward or backward	▶▶ or ◀◀ during playback
Move highlight (cursor)	↑ ↓ ← →
Select item	⊕
Master Volume	VOL+/-, MUTING

To Do This ...	Press
Pause	⏸
Search the picture forward or backward	▶▶ or ◀◀ during playback
Replay	◀ •
Advance	• ▶
Move highlight (cursor) and select (DVD)	↑ ↓ ← → ⊕
Record (VCR)	●
Change channels (VCR)	CH +/- or 0-9, ENT (using tuner)
Adjust tracking (VCR)	CH +/- (during tape playback)

Special Buttons on the Remote Control

This TV comes with convenient features that can be accessed directly by pressing their buttons on your remote control.

Using the **GUIDE** Button

This TV is equipped to show program information if it is available from the station. The Program Guide lets you review program information, and select both analog and digital channels.

To display the Program Guide:

- 1 Tune your TV to a channel by using the **0-9**, **⊙**, and **ENT** buttons.
- 2 Press **GUIDE** on the TV's remote control. The Program Guide will appear with the currently selected program showing in the background.

Channel number, call letters, etc.

Program title and description, program duration, time remaining, rating information, closed-caption availability, etc.

Selectable channel list.

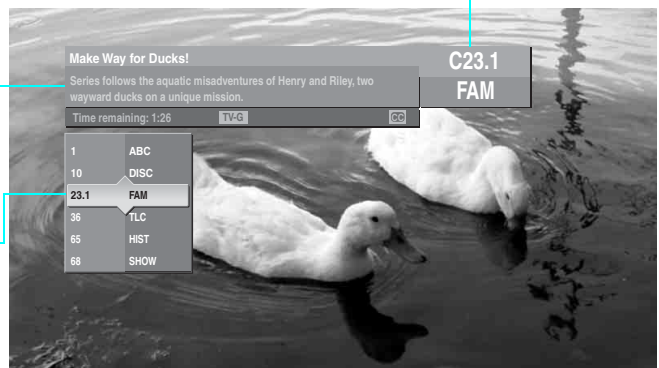

 Program information in the guide is provided by the broadcasters. As a result, it may sometimes include only the channel number, without a program title or description.

Using the Program Guide

The Program Guide allows you to select the channels from a drop down list. The Guide also provides information about the current program being shown on each channel.

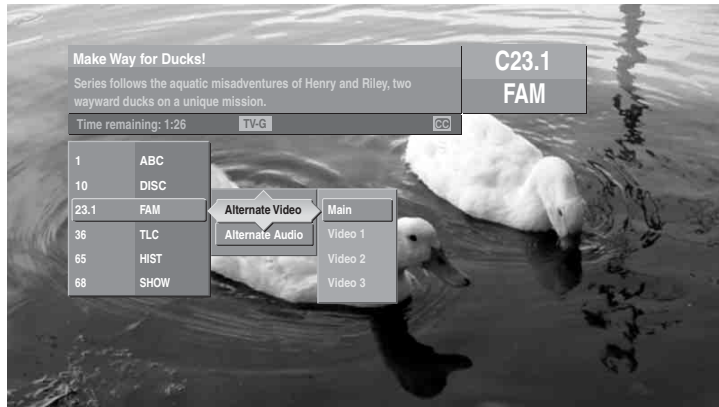

 Subchannels are additional channels of programming broadcast simultaneously. For example, channel 4 might include three subchannels (4.1, 4.2, 4.3) that are showing programs at the same time.

Using the Program Options Menu

The Program Options menu allows you to customize the program settings on the currently tuned channel.

<i>Option</i>	<i>Description</i>
Alternate Video (When available)	Each program has a main video stream (the video that you see when the channel is first tuned), and may have alternate video streams. This option allows you to switch among these alternate video streams.
Alternate Audio (When available)	Each program has a main audio stream (the audio you hear when the channel is first tuned). This option allows you to switch among these alternate audio streams (e.g., for different languages).

Using the WIDE Button

Wide screen mode lets you watch 4:3 normal broadcasts in several wide screen modes (16:9 aspect ratio).

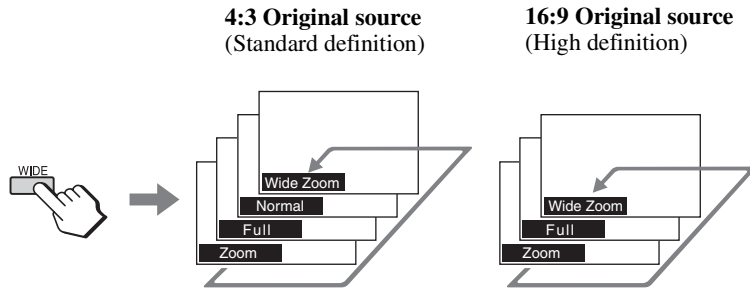

 When the TV receives a 720p or 1080i signal that is in 4:3 aspect ratio picture with a black bar at each side, Full returns the picture to its original size.

 When the TV receives a 720p or 1080i signal, Normal cannot be selected.

 You can also access the **Wide Mode** settings from the Screen menu. For details, see page 62.

Changing the wide screen mode

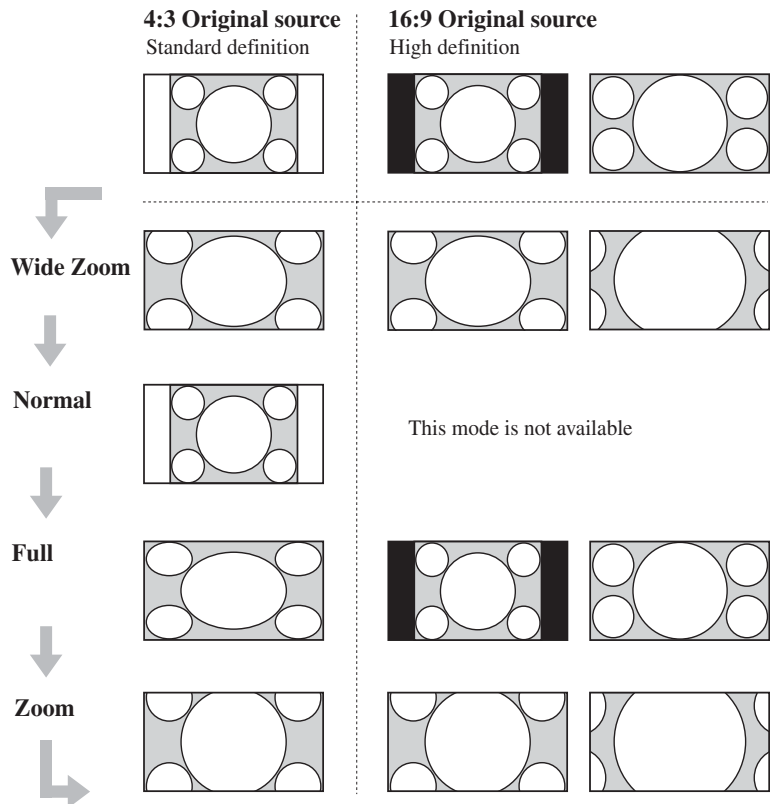

Using the FREEZE Button

The **FREEZE** button allows you to temporarily capture a program's picture. You can use this feature to write down information such as phone numbers, recipes, etc.

To Freeze

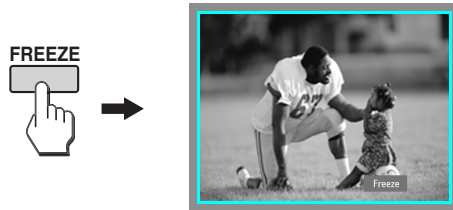

To cancel **FREEZE** for normal viewing, press **FREEZE** again.

Using the JUMP Button

The **JUMP** button allows you to jump back and forth between the current channel and the last channel that was selected.

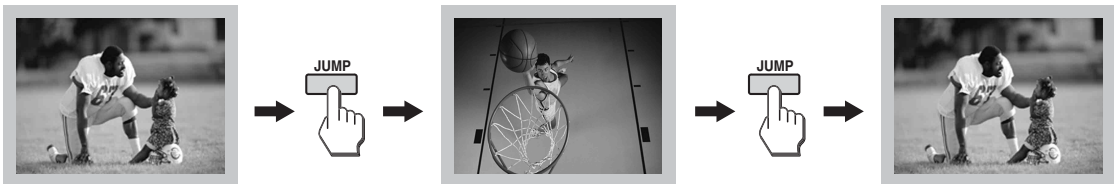

Introducing WEGA GATE

Overview of WEGA GATE



A push of a button on your remote control provides a whole new experience of TV viewing. It enables you to perform a variety of tasks intuitively with a control panel on the screen rather than using complicated remote control button presses.

When you press the  button, you can select from basic TV function: watching TV, selecting from Favorite Channels, viewing external equipment signals or adjusting or adjusting TV settings.

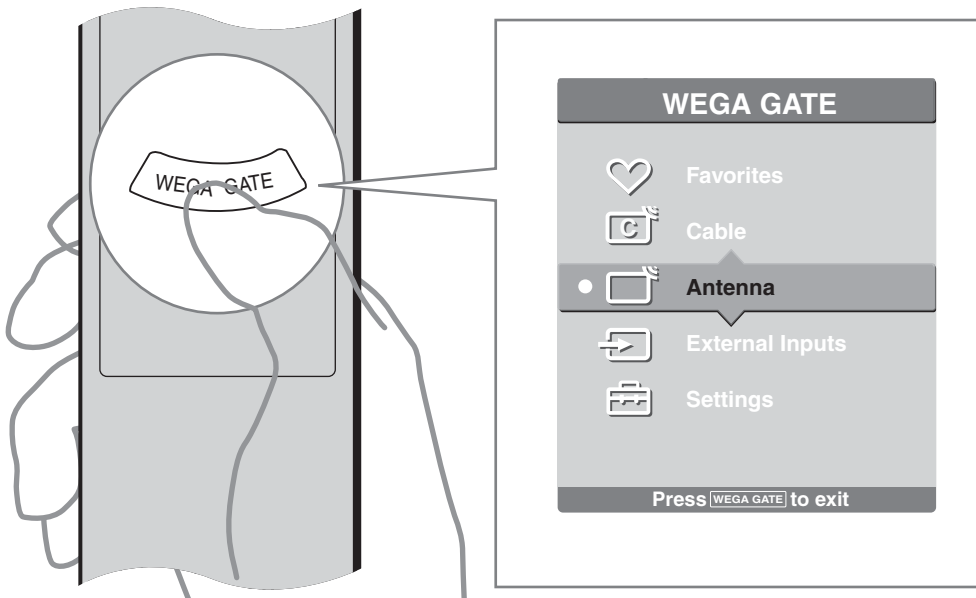



- 1 Press  on the remote.



WEGA GATE control panel appears.

- 2 Press  to highlight the item.
- 3 Press  to select.
- 4 Press  to exit.

The WEGA GATE screen gives you access to the following items:

<i>Icon</i>	<i>Description</i>
 Favorites	The Favorites feature lets you select programs from a list of up to 16 favorite channels that you specify. For details, see page 54.
 Cable	The Cable feature takes you to the most recently viewed channel on the cable input. When tuned to the channel, the Program Banner and Channel number will be displayed.
 Antenna	The Antenna feature takes you to the most recently viewed channel on the antenna input. When tuned to the channel, the Program Banner and Channel number will be displayed.
 External Inputs	The External Inputs feature lets you select equipment that is connected to your TV, such as a DVD player. You can assign a label to the equipment. For details, see page 55.
 Settings	The Settings feature lets you adjust the Video, Audio, Screen, Channel, Parental Control, Setup and Applications menus. For details, see page 55.

Using Favorites in WEGA GATE

The Favorites feature lets you select programs from a list of up to 16 favorite channels that you specify. You can create a list using the **Add to Favorites** option.

- 1 Select **Favorites** from the WEGA GATE control panel and press **(+)**.
The Favorite Channels list appears. Make your selection.

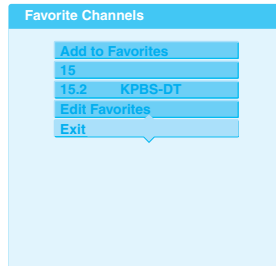

- 2 Press **↑/↓** to highlight the desired channel and press **(+)**.
 - To add the current channel to the list of Favorite Channels, highlight **Add to Favorites** and press **(+)**.
 - When the Favorite Channel list is full, select **Edit Favorites** to remove a channel from the list or go to the **Channel** settings and select **Favorites Channels** then edit the channel.

Using Cable in WEGA GATE

The Cable feature takes you to the most recently viewed channel on the cable input. When tuned to the channel, the Program Banner and Channel number will be displayed.

Select **Cable** from the WEGA GATE control panel and press **(+)**.

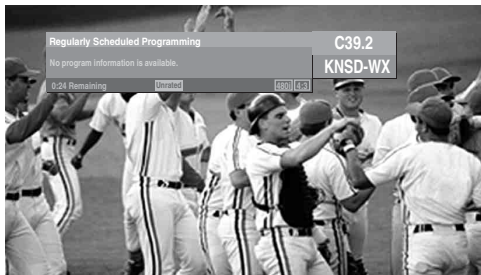

Using Antenna in WEGA GATE

The Antenna feature takes you to the most recently viewed channel on the antenna input. When tuned to the channel, the Program Banner and Channel number will be displayed.



Select Antenna from the WEGA GATE control panel and press .



 If you have not completed the initial channel setup (see page 64) both Cable and Antenna will tune to the lowest channel number. To run Auto Program see page 64.

Using External Inputs in WEGA GATE

The External Inputs feature lets you view from a selected external input connected to your TV. You can assign a label or skip over unused inputs by selecting Edit Video Labels. Input label assignment can also be done by going to Setup settings and select Label Video Inputs (see page 70).

- 1 Select External Inputs from the WEGA GATE control panel and press .
The External Inputs list appears. Make your selection.
- 2 Press  to highlight the desired external input and press .

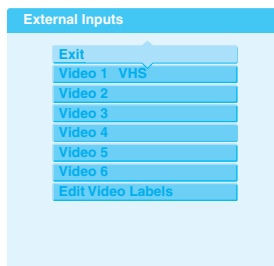



Using Settings in WEGA GATE

The Settings feature lets you enter to the menu screen where most of advanced settings and adjustments are performed (see page 56).

Using the Settings

Overview

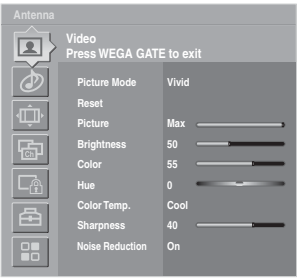
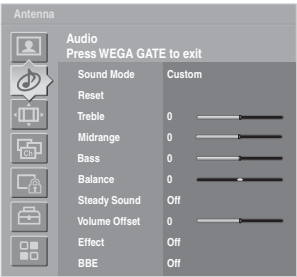
The Settings gives you access to the following features:
(Depending on the signal tuned, you may see a different Setting options on your screen. Settings displayed here are with the 720p signal.)

Settings	Allows you to set/change	
Video 	Picture Mode (page 58) Reset (page 58) Picture (page 58) Brightness (page 58) Color (page 58) Hue (page 58) Color Temp. (page 58) Sharpness (page 58) Noise Reduction (page 59)	DRC Mode (page 59) DRC Palette (page 59) Advanced Video (page 59)
Audio 	Sound Mode (page 60) Reset (page 60) Treble (page 60) Midrange (page 60) Bass (page 60) Balance (page 60) Steady Sound (page 60) Volume Offset (page 60) Effect (page 60)	BBE (page 61) MTS (page 61) Speaker (page 61) Audio Out (page 61) A/V Sync (page 61)
Screen 	Wide Mode (page 62) Game Picture (page 62) 4:3 Default (page 63) Display Area (page 63) Vertical Center (page 63) Vertical Size (page 63)	

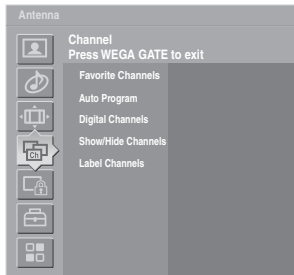
Settings*Allows you to set/change***Channel**

Favorite Channels (page 64)
 Auto Program (page 64)
 Digital Channels (page 64)
 Show/Hide Channels (page 64)
 Label Channels (page 65)

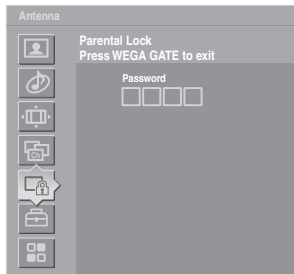
Parental Lock

Parental Lock (page 66)
 Change Password (page 67)
 Select Country (page 67)

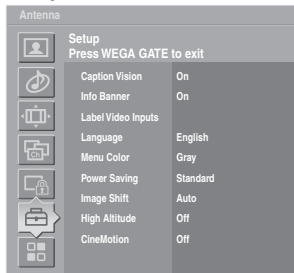
Setup

Caption Vision (page 70)
 Info Banner (page 70)
 Label Video Inputs (page 70)
 Language (page 71)
 Menu Color (page 71)
 Power Saving (page 71)
 Image Shift (page 71)
 High Altitude (page 71)
 CineMotion (page 71)

Applications

Clock/Timers (page 73)
 Diagnostics (page 74)
 CableCARD (page 74)

Accessing the Video Settings

1. Press **WEGA GATE**.....



2. Select **Settings**.....



3. Highlight.....



4. Press to select.....

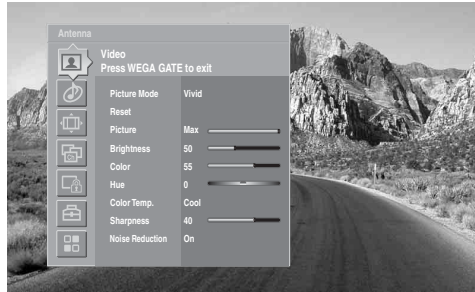

To highlight an option and to change settings, press **↑ ↓ ← →**.

Press **+** to confirm the selection.



To exit the Video, press **WEGA GATE**.

Selecting Video Options

To quickly and easily change from one **Picture Mode** to another, use **PICTURE** on the remote control.

The Video settings include the following options:

Option	Description
Picture Mode <i>Customized picture viewing</i>	Vivid Select for enhanced picture contrast and sharpness.
	Standard Select for standard picture settings. Recommended for home entertainment.
	Custom Select to display a picture with minimum enhancements.
<p> You can alter the Video settings (Picture, Brightness, Color, etc.) for each Picture Mode and each video input.</p> <p> You may set up a Picture Mode (Vivid, Standard, Custom) independently for each Video input (Video 1-Video 6, including the Antenna input). Your Picture Mode settings are automatically saved after each selection. This allows you to customize the Picture Mode setting for each type of signal source.</p>	
Reset	Select OK to reset all settings and adjustments to the default setting for each Picture Mode (Vivid, Standard, Custom) (except for the options grayed out).
Picture	Adjust to increase picture contrast and deepen the color or decrease picture contrast and soften the color.
Brightness	Adjust to brighten or darken the picture.
Color	Adjust to increase or decrease color intensity.
Hue	Adjust to increase or decrease the green tones.
Color Temp. <i>White intensity adjustment</i>	Choose from three color temperatures:
	Cool Select to give the white colors a blue tint.
	Neutral Select to give the white colors a neutral tint.
	Warm When selected Custom in Picture Mode , select to give the white colors a red tint.

Option	Description
Sharpness	Adjust to sharpen or soften the picture.
Noise Reduction	<p>On Select to reduce the noise level of signal from connected equipment and from the VHF/UHF jack.</p> <p>Off Select to turn off Noise Reduction.</p>
DRC Mode	<p>High Density Creates a high-resolution picture with 4 x density, for high quality sources (i.e., DVD player, satellite receiver).</p> <p>Progressive Recommended for moving pictures.</p> <p> DRC Mode is not available when using the Freeze feature; also not available when watching 480p, 720p or 1080i sources.</p>
DRC Palette	<p>Custom Allows you to customize the level of detail (Reality) and smoothness (Clarity) for up to three input sources. For example, you can create one Custom setting to optimize your cable input's picture, and create another to optimize your DVD player's picture. You can switch among the three Custom settings.</p> <p>1 Press the arrow buttons to highlight Custom then press (+). The DRC palette appears.</p> <div data-bbox="759 808 1008 1012" data-label="Image"> </div> <p>2 Press the arrow buttons to adjust the position of the marker (●). As you move the ● higher along the Reality axis, the picture becomes more detailed. As you move the ● to the right along the Clarity axis, the picture becomes smoother.</p> <p>3 To save the setting, press (+).</p> <p> DRC Palette is not available when using the Freeze feature; also not available when watching 480p, 720p or 1080i sources.</p>
Advanced Video Available in "Custom Picture Mode"	<p>Program Select Program to choose among the options: Gamma (High/Medium/Low/Off), Clear White (On/Off), Color Corrector (High/Low/Off).</p> <p>Select Black Corrector to enhance the black colors to give the picture strong contrast (High/Medium) or lesser contrast (Low/Off).</p>



Accessing the Audio Settings

1. Press **WEGA GATE**.....



2. Select **Settings**.....



3. Highlight.....



4. Press to select.....

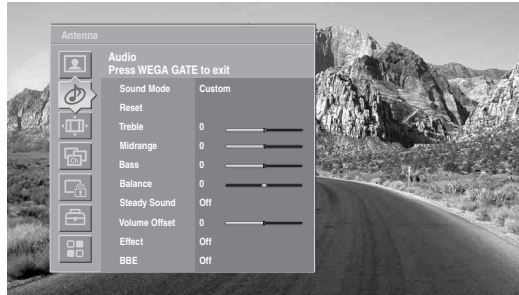

To highlight an option and to change settings, press **↑ ↓ ← →**.

Press **+** to confirm the selection.

To exit the Audio, press **WEGA GATE**.

Selecting Audio Options



The Audio settings include the following options:

Option	Description
Sound Mode	Dynamic Select to enhance treble and bass.
	Standard Suitable for spoken dialogue.
	Custom Flat setting.
Reset	Select OK to reset all settings and adjustments to the default setting for each Sound Mode (Dynamic, Standard, Custom) (except for the options grayed out).
Treble	Adjust to increase or decrease higher-pitched sounds.
Midrange	Adjust to increase or decrease the sounds between the Treble and Bass.
Bass	Adjust to increase or decrease lower-pitched sounds.
Balance	Adjust to emphasize left or right speaker balance.
Steady Sound	On Select to stabilize the volume across all programs and commercials.
	Off Select to turn off Steady Sound .
Volume Offset	Adjust to increase or decrease the sound level of the current input (TV or video input) relative to other inputs.
Effect	TruSurround XT Select for surround sound (for stereo programs only).
	Simulated Adds a surround-like effect to mono programs.
	Off Normal stereo or mono reception.



TruSurround XT

attempts to create the same surround effect produced by a multichannel system using the left and right speakers.

Option	Description	
BBE	On	Select to give sound more impact by compensating for phase effects in speakers.
	Off	Select for normal stereo or mono reception.
MTS <i>Enjoy stereo, bilingual and mono programs</i>	Stereo	Select for stereo reception when viewing a program broadcast in stereo.
	Auto SAP	Select to automatically switch to second audio programs when a signal is received. (If no SAP signal is present, the TV remains in Stereo mode.)
	Mono	Select for mono reception. (Use to reduce noise during weak stereo broadcasts.)
	 MTS is available only for analog programs.	
Speaker	On	Select to turn on the TV speakers.
	Off	Select to turn off the TV speakers and listen to the TV's sound only through your external audio system speakers.
	 The MUTING button on your remote control becomes nonfunctional when the Speaker is set to Off.	
Audio Out <i>Easy control of volume adjustments</i>	This option can be set only when the Speaker option is set to Off .	
	Variable	The TV's speakers are turned off, but the audio output from your audio system can still be controlled by the TV's remote control.
	Fixed	The TV's speakers are turned off and the audio output of the TV is fixed. Use your audio receiver's volume control to adjust the volume (and other settings) through your audio system.
A/V Sync	Off/1/2/3	Use this option to make adjustments to audio and video synchronization when you have external equipment connected to DIGITAL AUDIO (OPTICAL)OUT of the TV. Select Off (factory default setting) to make no adjustments. Select 1, 2 or 3 to adjust so that the video and audio from your connected external equipment are synchronized.

Accessing the Screen Settings

1. Press **WEGA GATE**..... 
2. Select **Settings**..... 
3. Highlight..... 
4. Press to select..... 





To highlight an option and to change settings, press **↑ ↓ ← →**.
 Press **+** to confirm the selection.
 To exit the Screen, press **WEGA GATE**.

Selecting Screen Options

 **Wide Mode** is unavailable while in Freeze (page 51).

The Screen settings include the following options:

Option	Description
Wide Mode <i>Select a screen mode to use for 4:3 sources.</i>	Wide Zoom Select to enlarge the 4:3 picture, to fill the 16:9 screen, keeping the original image as much as possible.
Normal	Select to return the 4:3 picture to its original size and aspect ratio.
 Normal is not available when watching 720p or 1080i sources.	
Full	Select to enlarge the 4:3 picture horizontally only, to fill the wide screen.
Zoom	Select to proportionally enlarge 1080i and 720p sources. For 480p and 480i sources, Zoom will vertically stretch the image to fill the screen.

 To change from one **Wide Mode** setting to another, use **WIDE** button on the remote control (see page 50).





Game Picture Allows you to move the position of the picture left and right in the window. (This feature also allows you to adjust the picture from any connected equipment.) Select while watching the picture to be adjusted. The TV stores the position in memory for each input. Press **←** or **→** and press **+** to choose a correction between +5 and -5.

 Not available in **Full** and **Normal** mode when sources are in 720p or 1080i.

 If **4:3 Default** is set to anything but **Off**, the **Wide Mode** setting changes only for the current channel. When you change channels (or inputs), **Wide Mode** is automatically replaced with the **4:3 Default** setting. To retain the current **Wide Mode** setting as channels and inputs are changed, set **4:3 Default** to **Off**.

Option	Description
4:3 Default	Wide Zoom Select to enlarge the 4:3 picture, to fill the 16:9 screen, keeping the original image as much as possible.
<i>Select the default screen mode to use for 4:3 sources.</i>	Normal Select to return the 4:3 picture to normal mode.
	Full Select to enlarge the 4:3 picture horizontally only, to fill the wide screen.
	Zoom Select to enlarge the 4:3 picture horizontally and vertically to an equal aspect ratio that fills the wide screen.
	Off Select to continue using the current screen mode setting when the channel or input is changed.
Display Area	Select Normal to return to the default Display Area. Select -1 or -2 to keep the edge of the picture out of screen.
Vertical Center	Adjust Allows you to move the position of the picture up and down in the window. (Available only in Wide Zoom and Zoom modes.) Press ▲ or ▼ and press ⊕ to choose a correction between +5 and -5.
Vertical Size	Adjust Allows you to adjust the vertical size of the picture. (Available only in Wide Zoom and Zoom modes.) Press ▲ or ▼ and press ⊕ to choose a correction between +5 and -5.

Accessing the Channel Settings

1. Press **WEGA GATE**..... 
2. Select **Settings**..... 
3. Highlight..... 
4. Press to select..... 



To highlight an option and to change settings, press **▲ ▼ ◀ ▶**.

Press **+** to confirm the selection.

To exit the Channel, press **WEGA GATE**.

Selecting Channel Options

The Channel settings include the following options:

Option	Description
Favorite Channels	Lets you set up a list of your favorite channels. For details, see “Using Favorites in WEGA GATE” on page 54.
Digital Channels Add	Select to add digital channels.
Auto Program	Automatically sets up the channel list on the TV for all receivable channels for the current input (VHF/UHF or CABLE). Select to start the Auto Program.
	 Auto Program may take up to 20 to 50 minutes to complete. A progress bar will display the approximate progress of the Auto Program and Digital Channels/ Add sequences.
Show/Hide Channels	Allows you to show or hide channels that appear in the Program Guide (page 48) and when you use the CH+/- buttons to channel surf. Channels that are set to Hidden do not appear in the Program Guide or when you use the CH+/- buttons. <ol style="list-style-type: none"> 1 Press ▲ or ▼ to highlight the channel that you want to show or hide. To move between the Major and Digital subchannel lists, press ◀ or ▶. 2 To change a channel’s setting to Shown or Hidden, press +. 3 To show or hide more channels, repeat steps 1 and 2.

 Channels that you set to Hidden can only be accessed with the **0-9** buttons.

<i>Option</i>	<i>Description</i>
✎	If you select to hide or show a major digital channel, all the sub-channels are automatically hidden or shown. To show or hide an individual sub-channel within a digital channel, you must individually select that sub-channel to show or hide.
✎	If you hide all sub-channels of a major digital channel, that digital channel is automatically set to Hidden.

Label Channels Allows you to assign labels (such as station call letters) to channel numbers.

- 1 Press **▲** or **▼** to scroll through the channel numbers. Then press **+** to select the channel number that you want to assign a label.
- 2 Press **▲** or **▼** to scroll through the label characters (A-Z, 0-9, etc.). Then press **+** to select the highlighted character. Repeat to add characters to the label.
- 3 Press **◀** to return to the Channel menu, or press **WEGA GATE** to exit the menus.



Accessing the Parental Lock Settings

1. Press **WEGA GATE**.....



2. Select **Settings**.....



3. Highlight.....



4. Press to select.....



To highlight an option and to change settings, press **↑ ↓ ← →**.

Press **+** to confirm the selection.

To exit the Parental Lock, press **WEGA GATE**.





You need your password for any future access into the Parental Lock menu. If you lose your password, see “Lost password” on page 83.

Selecting Parental Lock Options

The Parental Lock settings include the following options:

Option	Description
Parental Lock <i>Turn ratings on/off and select a rating system</i>	Off Turn Parental Lock off. No programs are blocked from viewing.
	Child Maximum ratings permitted are: US: TV-Y, TV-G, G Canada: C, G, TV-Y
	Youth Maximum ratings permitted are: US: TV-PG, PG Canada: C8+, PG, 8 ans+, TV-PG
	Y. Adult Maximum ratings permitted are: US: TV-14, PG-13 Canada: 14+, 13 ans+, TV-14
	Custom Select to set ratings manually. US: See page 68 for details. Canada: See page 69 for details.

 If you are not familiar with the Parental Guideline rating system, you should select **Child**, **Youth**, or **Y.Adult** to help simplify the rating selection. To set more restrictive ratings, select **Custom**.

 For descriptions of **Child**, **Youth**, and **Y.Adult** ratings, see page 66.

Option	Description
Change Password	Select to change your password.
Select Country	U.S.A. Select to use U.S.A. ratings (see page 68).
	Canada Select to use Canadian ratings (see page 69).

To deactivate the parental control feature

- Set **Parental Lock** to **OFF** when in the Parent menu.

To change the password

- 1** In the Parent menu, use the arrow buttons to highlight **Change Password**, and press **+** to select it.
- 2** Enter a new four-digit password using the **0-9** buttons.
- 3** Confirm the new password by entering it again.
- 4** Press **WEGA GATE** to exit the menu screen.

Viewing Blocked Programs

You can view a blocked program by entering the password.

- 1** Press **ENT** when tuned to a blocked program.
- 2** Enter your password using the **0-9** buttons.
Parental Lock will be canceled temporarily until you turn your TV off.

Selecting Custom Rating Options

 To ensure maximum blocking capability, the age-based ratings should be blocked.

 If you select **Block**, be aware that the following programs may be blocked: news, sports, weather, emergency broadcasts, political programs, public service announcements, and religious programs.

US custom rating options

If you selected U.S.A. as the country of residence on page 67, the Custom Rating menu includes the following options. (If you selected Canada, see page 69.)

Option	Description
Movie Rating	G All children and general audiences.
	PG Parental guidance suggested.
	PG-13 Parental guidance for children under 13.
	R Restricted viewing, parental guidance is suggested for children under 17.
	NC-17 and X No one 17 and under.
TV Rating <i>Block programs by their rating, content or both</i>	Age-Based Options
	TV-Y All children.
	TV-Y7 Directed to children age 7 and older.
	TV-G General audience.
	TV-PG Parental guidance suggested.
	TV-14 Parents strongly cautioned.
	TV-MA Mature audience only.
	Content-Based Options
	FV Fantasy violence.
	D Suggestive dialog.
	L Strong language.
	S Sexual situations.
	V Violence.
Unrated <i>Block programs or movies that are broadcast without a rating</i>	Allow Allows programs and movies that are broadcast without a rating.
	Block Blocks all programs and movies that are broadcast without a rating.

 The content ratings will increase depending on the level of the age-based rating. For example, a program with a **TV-PG V** (Violence) rating may contain moderate violence, while a **TV-14 V** (Violence) rating may contain more intense violence.

Canadian custom rating options

If you selected Canada as the country of residence on page 67, the Custom Rating menu includes the following options. (If you selected U.S.A., see page 68.)

<i>Option</i>	<i>Description</i>
English Rating	C All children.
	C8+ Children 8 years and older.
	G General programming.
	PG Parental guidance.
	14+ Viewers 14 and older.
	18+ Adult programming.
French Rating	G General programming.
	8 ans+ Not recommended for ages under 8.
	13 ans+ Not recommended for ages under 13.
	16 ans+ Not recommended for ages under 16.
	18 ans+ Programming restricted to adults.
U.S.A. Rating	See “ TV Rating ” on page 68 for details.



Accessing the Setup Settings

1. Press **WEGA GATE**.....



2. Select **Settings**.....



3. Highlight.....



4. Press to select.....

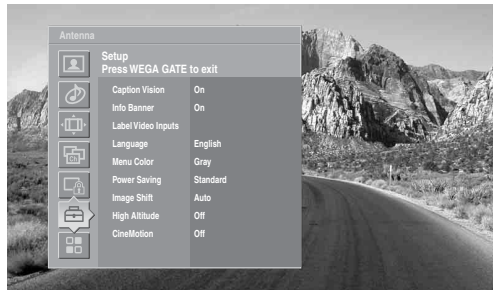

To highlight an option and to change settings, press **▲ ▼ ◀ ▶**.



Press **+** to confirm the selection.

To exit the Setup, press **WEGA GATE**.

Selecting Setup Options

The Setup settings include the following options:

Option	Description
Caption Vision	Allows you to select from four closed caption modes (for programs that are broadcast with closed captioning). On Caption Vision is turned on. Off Caption Vision is turned off.
Program	Allows you to set basic and advanced Caption Vision options. See “Programming Caption Vision” on page 72.
Info Banner	Set to On or Off . Select On to display the program name, time remaining and other information (if the broadcaster offers this service). Also displays when the channel is changed or the DISPLAY button is pressed.
Label Video Inputs	Allows you to label the audio/video equipment you have connected to the TV so you can identify them when using TV/VIDEO . When in this menu: 1 Press ▲ or ▼ to highlight an input to label, then press + to select it. 2 Use the arrow buttons to scroll through the labels. 3 Press + to select the equipment you connected to each of the input jacks on the back of your TV. Select Skip if you do not have any equipment connected to a particular input.

Option	Description
Video 1-6	VHS, DVD, Receiver, Satellite, Cable Box, 8mm, DTV, Game, LD, Beta, HD, DVR, Camcorder, Skip ✍ If you select Skip, your TV skips the selected connection when you press TV/VIDEO.
Language	Select to display all on-screen menus in your language of choice: English, Español, Français.
Menu Color	Enables you to select a specific color for the on-screen menus.
Power Saving	<p>Standard Select to view picture without the benefit of Power Saving.</p> <p>Reduced Select to view picture with reduced power consumption. The picture becomes darker, but also enhances the black level.</p>
Image Shift	<p>Corrects the image on your TV.</p> <p>Before adjusting</p>  <p>After adjusting</p>  <p>Auto (Factory setting) Automatically corrects double images.</p> <p>Level 1-4 Select a level from 1-4 to align the images and improve the picture.</p>
High Altitude	Select On to use the TV at an altitude of 5,000 feet (1,500 m) or higher. Select Off to use the TV at normal altitude.
CineMotion	Select On to optimize the screen display automatically detecting film content and applying a reverse 3-2 pulldown process. Moving picture will appear clearer and more natural looking. Select Off will disabling the detection.

(Continued)

Programming Caption Vision

If you selected the **Program** option under **Caption Vision** (see page 70), you can change the following settings:

Option	Description
Basic	Allows you to select basic analog (EIA-608) closed caption options.
CC1, CC2, CC3, CC4	Displays a printed version of the dialog or sound effects of a program. (Should be set to CC1 for most programs.)
Text1, Text2, Text3, Text4	Displays network/station information presented using either half or the whole screen (if available).
Advanced	Allows you to select advanced digital (EIA-708) closed caption options. Select from the available options.
Digital CC	Allows you to set digital closed captioning to Basic (digital EIA-608) or Advanced (digital EIA-708).
Advanced Settings	Allows you to make additional settings for digital (EIA-708) closed caption options.
As Broadcast	
Small Text	
Large Text	
Custom...	Allows you to customize the following settings:
Character Size	Small, Standard, Large
Character Style	Style 1-7
Character Color	Color 1-8
Character Opacity	Solid, Translucent
Edge Color	Color 1-8
Edge Type	None, Raised, Depressed, Outline, Left shadow, Right shadow
Background Color	Color 1-8
Background Opacity	Solid, Translucent
Window Color	None, Color 1-8
Window Opacity	Solid, Translucent



Accessing the Applications Settings

1. Press **WEGA GATE**.....



2. Select **Settings**.....



3. Highlight.....



4. Press to select.....



To highlight an option and to change settings, press **▲ ▼ ◀ ▶**.

Press **+** to confirm the selection.

To exit the Applications, press **WEGA GATE**.

Selecting Applications Options

The Applications settings include the following options:

Option	Description
Clock/Timers	Select to set the clock and to program your TV to turn on and off at two scheduled viewing times.
Sleep	Allows you to select the amount of time (Off , 15 minutes , 30 minutes , 45 minutes , 60 minutes or 90 minutes) that you want the TV to remain on before shutting off automatically.
Timer 1 Timer 2	You can use the Timers to program the TV to turn on and off and tune to a specific channel at two scheduled viewing times.
Timer 1 and Timer 2 cannot be set until you set the Current Time .	
1	Press ▲ or ▼ to highlight Timer 1 or Timer 2 . To set the timer, press ▶ .
To go directly to programming Timer 1 or 2 , press + instead of pressing ▶ .	

(Continued)

Option	Description
	<p>2 Press ▲ or ▼ to highlight one of the following options, then press ⊕.</p> <p>Program Select to set the Timer by day, time, duration, and channel.</p> <p>Off Select to turn off the Timer. (Your previous settings are saved.)</p>
	<p>3 If you selected Program in step 2, press ▲ and ▼ to set the day(s), hour, minute, duration, and channel number. Press ⊕ or press ➔ to confirm each setting and move to the next setting. Press ◀ to go back to the previous setting.</p>
	<p>4 Press WEGA GATE to exit the menu screen. An LED on the front panel will light, indicating the Timer has been set.</p>
	<p>Current Time You can set the current time.</p>
	<p>1 Press ⊕ to select Current Time.</p>
	<p>2 Press ▲ and ▼ to set the current time (day, hour, minute, and AM/PM). Press ⊕ (or press ➔) to confirm each setting and move to the next setting. Press ◀ to go back the previous setting.</p>
	<p>3 Press WEGA GATE to exit the menu screen.</p>
<p>Diagnostics</p>	<p>Display diagnostics information about the TV. This can be useful in providing information to an authorized technician or repair person.</p>
<p>CableCARD</p>	<p>This list of selectable CableCARD options will vary, depending on your cable service provider.</p>

Other Information

Overview

This chapter includes the following topics:

<i>Topic</i>	<i>Page</i>
Contacting Sony	75
Replacing the Lamp	76
Troubleshooting	80
Specifications	84
Optional Accessories	85
Index	87

Contacting Sony

If, after reading these operating instructions, you have additional questions related to the use of your Sony television, please call our Customer Information Services Center.

For US residents: 1-800-222-SONY (7669)

or visit: <http://www.sonystyle.com/tv/>

For Canadian residents: 1-877-899-SONY (7669)

or visit: <http://www.sonystyle.ca/tv/>

Before calling Sony customer support, please write down the model and serial numbers of your TV. You'll find this information on the front cover of this manual.

Replacing the Lamp

The projection lamp, which illuminates the picture, has a **limited life**.

If the screen becomes dark, the color looks unusual, or the LAMP indicator on the front of the TV flashes, it is time to replace the lamp with a new one (not supplied).

 **WARNING**

Electric appliances can cause fire or high temperature, resulting in injury or death. Be sure to follow the instructions below.

- ❑ Use a Sony XL-2200 replacement lamp (not supplied) for replacement. Use of any other lamp may damage the TV.
- ❑ Do not remove the lamp for any purpose other than replacement. Doing so may cause injury or fire.
- ❑ Do not put flammable materials and metal objects inside the lamp receptacle of the TV after removing the lamp. Doing so may cause fire or electrical shock. Do not touch the lamp receptacle once the lamp has been removed.
- ❑ When the lamp eventually burns out, you may hear a noticeable pop sound. This is normal and it is inherent to this type of lamp.
- ❑ In rare instances, the bulb may pop inside the lamp unit, but the lamp unit is designed to contain all of broken glass pieces inside the lamp unit.
- ❑ The lamps contain mercury, for proper disposal of the used lamps follow and observe the local ordinances. See page 79.

How to Replace the Lamp

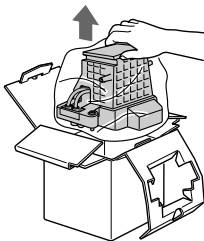

- 1** Turn off the power on the main unit. Wait several minutes, then unplug the power cord.
(The cooling fan will continue to operate for about two minutes after turning the power off.)
- 2** Wait at least 30 minutes after unplugging the power cord to allow the lamp to cool down before replacing it. To avoid being burned, do not touch the lamp receptacle once the lamp has been removed.
- 3** Take the new lamp out of the box.
Do not touch the glass portion of the new lamp.

 Do not shake the lamp. Vibration can damage the lamp or shorten its life.

 Avoid touching the front glass of a new lamp or the glass of the lamp receptacle. This may reduce picture quality or lamp life.

- 4** Loosen the screws on the rear side panel.

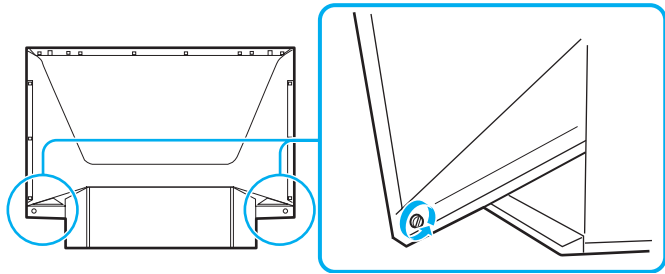

- 5** Remove the front panel.

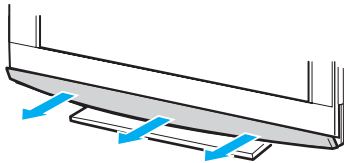

- 6** Pull out the lamp.

Loosen the right screw on the cover with a coin or similar object.

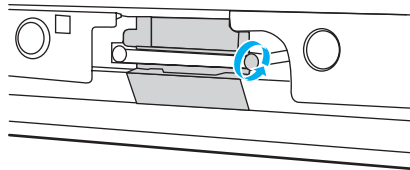

Remove the screw from the lamp cover. Pull down the cover toward you.

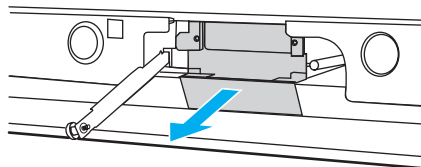

Unscrew the lamp and pull out the lamp horizontally.

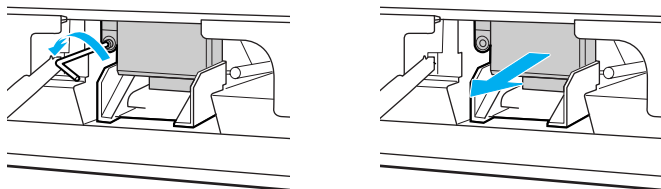

(Continued)

- ⚠ The lamp is very hot immediately after use. Never touch the glass portion of the lamp or the surrounding parts.
- ⚠ After it has cooled, place the used lamp into the empty box of the replacement lamp. Never put the used lamp into a plastic bag.

7 Place the new lamp into its place, then tighten the screw. Mount the new lamp securely. Failure to mount correctly may cause a fire or the screen to go dark.

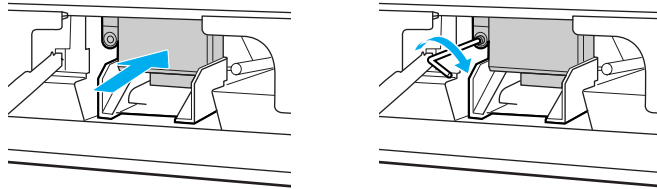

Push the cover back on. Make sure that the hole on the cover aligns with the hole on the unit. Reattach the lamp cover by tightening the screw.

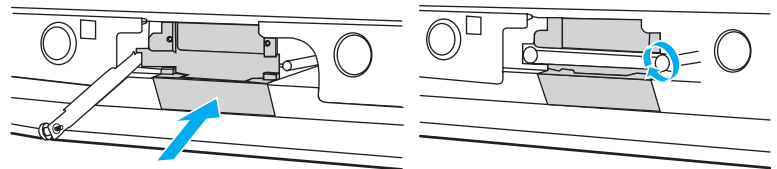

- ⚠ If the lamp cover screw is inserted incorrectly, the lamp may not operate properly. In such a case, remove the screw, insert it correctly and then tighten the screw completely (see “Indicators” on page 11).
- ⚠ If the lamp cover is not reattached securely, the self-diagnostic function may be triggered and the POWER indicator flashes three times (see page 11).

8 Reattach the front panel securely.

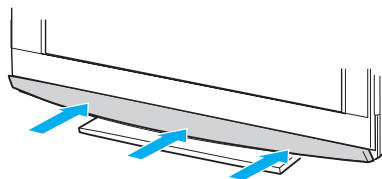

- 9 Tightly screw the side panel in its place.

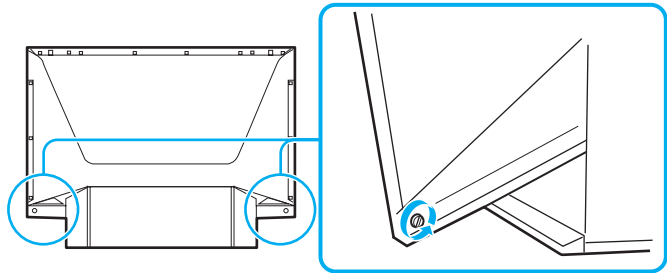

- ✎ Consult your Sony dealer for a Sony XL-2200 replacement lamp.
- ✎ Take great care when replacing the lamp or plugging in/unplugging the connecting cords. Rough handling may cause the TV to fall, damaging the TV, the TV stand and/or the floor.

The used lamp

For customers in the United States:

This product contains mercury. Disposal of this product may be regulated if sold in the United States. For disposal or recycling information, please contact your local authorities or the Electronics Industries Alliance (<http://www.eiae.org>).

- ❑ Do not leave the used lamp near flammable materials or within the reach of children.
- ❑ Do not pour water onto the used lamp or put any object inside the lamp. Doing so may cause the lamp to burst.

**For replacement lamp information visit:
U.S. residents: <http://www.sonystyle.com/tv/>
Canadian residents: <http://www.sonystyle.ca/tv/>**

Troubleshooting

Remote Control

<i>Problem</i>	<i>Possible Remedies</i>
Remote control does not operate	<ul style="list-style-type: none">❑ The batteries could be weak. Replace the batteries.❑ Check the orientation of the batteries.❑ Press TV (FUNCTION) once, and the TV indicator lights up. You may have inadvertently pressed SAT/CABLE (FUNCTION), which changes the remote control to SAT or CABLE mode.❑ Make sure this unit's power cord is connected securely to the wall outlet.❑ Locate the unit at least 3-4 feet away from fluorescent lights.
Cannot change channels with the remote control	<ul style="list-style-type: none">❑ If you are using the TV to change channels, first press TV (FUNCTION) once, and the TV indicator lights up.❑ If you are using another device to change channels, be sure you have not inadvertently switched your TV from the channel 3 or 4 setting.❑ If you are using another device to change channels, be sure to press FUNCTION for that device. For example, if you are using your cable box to change channels, be sure to press SAT/CABLE (FUNCTION) once, and the SAT/CABLE indicator lights up.
Remote control does not operate non-Sony video equipment	<ul style="list-style-type: none">❑ If you replaced the batteries to the remote recently, the code numbers for the video equipment may need to be reset.❑ There may be more than one code for the equipment that you are attempting to operate.❑ There is a possibility that some non-Sony equipment cannot be operated by your Sony TV remote. You may need to use the equipment's original remote control.

CableCARD Device

<i>Problem</i>	<i>Possible Remedies</i>
Problems using CableCARD device or CableCARD services	<ul style="list-style-type: none">❑ Check that the CableCARD device is inserted properly (see pages 25-26).❑ The CableCARD device must be activated by your local cable TV provider before you can receive digital cable TV services. See the activation instructions on pages 25-26.❑ Check the Diagnostics and CableCARD menu options (see page 74). (This can be useful in providing information to an authorized technician or repair person.)❑ Contact your cable TV provider.

Video

Problem	Possible Remedies
No picture (screen not lit), no sound	<ul style="list-style-type: none"> ❑ If your TV does not turn on, and a red light keeps flashing, your TV may need service. Call your local Sony Service Center. ❑ Make sure the power cord is plugged in. ❑ Press POWER on the front of the TV. ❑ Press TV/VIDEO to cycle through the connected video sources. ❑ Try another channel; it could be station trouble.
Dark, poor or no picture (screen lit), good sound	<ul style="list-style-type: none"> ❑ Adjust the Picture option in the Video menu (see page 58). ❑ Adjust the Brightness option in the Video menu (see page 58). ❑ Check the antenna/cable connections.
No color/dark picture/color is not correct	<ul style="list-style-type: none"> ❑ Adjust the Color option in the Video menu (see page 58).
Only snow and noise appear on the screen	<ul style="list-style-type: none"> ❑ Check the antenna/cable connections. ❑ Try another channel; it could be station trouble. ❑ Press ANT to change the input mode (see page 42).
Dotted lines or stripes	<ul style="list-style-type: none"> ❑ Adjust the antenna. ❑ Move the TV away from noise sources such as cars, neon signs, or hair-dryers.
Double images	<ul style="list-style-type: none"> ❑ Using a highly directional outdoor antenna or a cable may solve the problem. ❑ Set the Image Shift to an appropriate value. The default setting is Auto. If doubled images appear with Auto, select the best value from 1 to 4 (see page 71).
“Black box” on screen	<ul style="list-style-type: none"> ❑ You have selected a text option in the Setup menu and no text is available. (See page 70 to reset Setup selections.) To turn off this feature, set the Caption Vision option to Off. If you were trying to select closed captioning, select CC1 instead of Text 1-4.
Black bands appear at the top and bottom of the screen	<ul style="list-style-type: none"> ❑ Some wide-screen programs are filmed in aspect ratios that are greater than 16:9 (this is especially common with theatrical releases). Your TV will show these programs with black bands at the top and bottom of the screen. For more details, check the documentation that came with your DVD (or contact your program provider).
Certain programs on DVD or other digital sources display a loss of detail, especially during fast-motion or dark scenes	<ul style="list-style-type: none"> ❑ The compression used by certain digital broadcasts and DVDs may cause your TV’s screen to display less detail than usual, or cause artifacts (small blocks or dots, pixelations) to appear on your screen. This is due to your TV’s large screen and ability to show very fine detail, and is normal for certain digitally recorded programs. Adjust the reality/clarity in the DRC Palette menu (see page 59) to optimize the picture while viewing these sources.

Audio

Problem	Possible Remedies
Good picture, no sound	<ul style="list-style-type: none">❑ Press MUTING so that Muting disappears from the screen (see page 42).❑ Make sure the Speaker option is set to On in the Audio menu (see page 61).❑ Make sure the MTS option is set to Stereo or Mono (see page 61).
Audio noise	<ul style="list-style-type: none">❑ Communication problems may occur if infrared communication equipment (e.g., infrared cordless headphones) is used near the TV. Please use headphones other than infrared cordless headphones. Also, if you use infrared communication equipment other than infrared cordless headphones, move the infrared transceiver away from the TV until the noise is eliminated, or move the transmitter and receiver of the infrared communication equipment closer together.
Cannot gain enough volume when using a cable box	<ul style="list-style-type: none">❑ Increase the volume of the cable box using the cable box's remote control. Then press FUNCTION once, and the TV indicator lights up and adjust the TV's volume.
Sound seems weak or insufficient	<ul style="list-style-type: none">❑ The TV's audio might be set to Auto SAP or Mono, when it might be better set to Stereo. In the Audio menu (see page 61), set the MTS setting to Stereo. If already set to Stereo, switch to Mono (which may reduce background noise during weak stereo broadcasts).
Cannot raise the volume on external speakers	<ul style="list-style-type: none">❑ If the Speaker option is set to Off and the Audio Out option is set to Fixed (in order to output the sound to your audio system) use your audio receiver to adjust the sound (see page 61). Or, to use the TV remote control, set the Audio Out option to Variable.❑ To turn on the TV speakers, set the Speaker option to On (see page 61).

Channels

Problem	Possible Remedies
Cannot receive upper channels (UHF) when using an antenna	<ul style="list-style-type: none">❑ Press ANT to select the VHF/UHF input (see page 42).❑ Use Auto Program in the Channel menu to add receivable channels that are not presently in the TV's memory (see page 64).
Cannot receive any channels when using cable TV	<ul style="list-style-type: none">❑ Use Auto Program in the Channel menu to add receivable channels that are not presently in the TV's memory (see page 64).❑ Press ANT to select the CABLE input (see page 42).
Cannot receive or select channels	<ul style="list-style-type: none">❑ Use Auto Program in the Channel menu to add receivable TV channels that are not presently in TV memory (see page 64).
Some digital cable channels are not being displayed	<ul style="list-style-type: none">❑ Certain cable companies have limitations on the broadcast of digital cable channels. Check with your cable company for more information.❑ The digital cable channel may be set to Hidden in the Channel settings menu (see page 64).

General

Problem	Possible Remedies
How to restore the TV to factory settings	<ul style="list-style-type: none"> Turn on the TV. While holding down the ▲ button on the remote control, press the POWER button on the TV. (The TV will turn itself off, then back on again.) Release ▲ button. WARNING: The Factory Reset will clear all of your customized settings including Parental Lock setting.
How to restore Video settings to factory settings	<ul style="list-style-type: none"> Select RESET menu option while in the Video menu (see page 58).
How to restore Audio settings to factory settings	<ul style="list-style-type: none"> Press RESET menu option while in the Audio menu (see page 60).
Cannot cycle through the other video equipment connected to the TV	<ul style="list-style-type: none"> Be sure the Label Video Inputs option is not set to Skip (see page 70).
Cannot operate Menu	<ul style="list-style-type: none"> If a menu option appears in gray, this indicates that the menu option is not available.
Lost password	<ul style="list-style-type: none"> In the password screen (see page 66), enter the following master password: 4357. The master password clears your previous password; it cannot be used to temporarily unblock channels.
TIMER is set	<ul style="list-style-type: none"> The LED will remain lit even when the TV is turned off. To rest the timer or cancel the timer, see page 73. If the LED (red) blinks continuously, this may indicate the TV needs service.
Digital cable box does not work	<ul style="list-style-type: none"> If you are connecting a VCR and digital cable box using a splitter, as described on page 34, you must use a special bi-directional splitter that is designed to work with your digital cable box. Contact your cable provider for details.
Cannot record digital channels to VCR	<ul style="list-style-type: none"> Only analog channels can be recorded to your VCR.
The replacement lamp does not light up	<ul style="list-style-type: none"> The screw of the lamp cover may be slanted. Take out the screw, insert it straight into the screw hole, and then tighten it completely (see page 76 for both KDF-E55A20 and KDF-E60A20).
TV cabinet creaks	<ul style="list-style-type: none"> When the TV is in use, there is a natural rise in temperature, causing the cabinet to expand or contract and may be accompanied by a slight creaking noise. This is not a malfunction.

Specifications

Projection System	3 LCD Panels, 1 lens projection system	
LCD Panel	0.87 inch TFT LCD panel Approx. 3.28 million dots (1,042,168 pixels)	
Projection Lens	High Performance, large diameter hybrid lens F2.4	
Antenna	75 ohm external terminal for VHF/UHF	
Lamp	132W, XL-2200	
Television System	NTSC	American TV Standard
	ATSC (8VSB terrestrial)	ATSC compliant 8VSB
	QAM on cable	ANSI/SCTE 07 2000
Visible Screen Size (Picture measured diagonally)	KDF-E55A20:	55 inches
	KDF-E60A20:	60 inches
Channel Coverage	Terrestrial (analog)	2-69
	Cable TV (analog)	1-125
	Terrestrial (digital)	2-69
	Cable TV (digital)	1-135
Power Requirements	120V, 60 Hz	
Number of Inputs/Outputs		
HDMI IN	Video	1080i, 720p, 480p, 480i
	Audio	Two channel linear PCM 32, 44.1 and 48 kHz, 16, 20 and 24 bit
Video (IN)	3 total (1 on front panel)	1 Vp-p, 75 ohms unbalanced, sync negative
S Video (IN)	3 total (1 on front panel)	Y: 1 Vp-p, 75 ohms unbalanced, sync negative
		C: 0.286 Vp-p (Burst signal), 75 ohms
Audio (IN)	6 total (1 on front panel)	500 mVrms (100% modulation)
		Impedance: 47 kilohms
Component Video Input	2 (YPbPr)	Y: 1.0 Vp-p, 75 ohms unbalanced, sync negative
		Pb: 0.7 Vp-p, 75 ohms
		Pr: 0.7 Vp-p, 75 ohms
AUDIO (VAR/FIX) OUT	1	500 mVrms at the maximum volume setting (Variable)
		500 mVrms (Fixed)
		Impedance (output): 2 kilohms
 AUDIO OUT jacks are operable only when the TV's Speaker is set to Off.		
RF Inputs	2	
Digital Audio Optical Output (PCM/Dolby Digital)	1	Optical Rectangular (1)
CableCARD Slot	PCMCIA Type I/II	
Speaker Output	12 W (L), 12 W (R)	

Power Consumption	
In Use	265 W
In Standby	Less than 15 W
Dimensions (W × H × D)	
	KDF-E55A20: (57 ³ / ₈ × 37 ¹ / ₄ × 19 ³ / ₈ inches) (1,456 × 943 × 491 mm)
	KDF-E60A20: (62 × 39 ⁵ / ₈ × 20 ¹ / ₂ inches) (1,574 × 1,005 × 518 mm)
Mass	
	KDF-E55A20: 92.5 lb (42 kg)
	KDF-E60A20: 101.5 lb (46.1 kg)
Supplied Accessories	
Remote Control	RM-YD002
AA (R6) Batteries	2 supplied for remote control

Design and specifications are subject to change without notice.

Non-metric weights and measures are approximate.

Optional Accessories

- HDMI cable
- Component video cable
- S VIDEO cable
- A/V cable
- Audio cable
- Optical cable
- TV Stand: SU-GW12
- Lamp: XL-2200

Index

Numerics

0-9 buttons **42**

A

Adding channels to the channel list **64**

Adjusting audio, Steady Sound **60**

Advanced Video **59**

Alternate Audio **49**

Alternate Video **49**

ANT button **42**

Applications Menu **73**

Audio Menu **60**

Audio receiver, connecting **39**

Audio setting **56**

B

Balance, adjusting **60**

Bass, adjusting **60**

Batteries, inserting in remote **41**

Bilingual audio **61**

Brightness, adjusting **58**

C

Cable

with VCR, connecting **32**

Cable box

connecting with VCR **33**

cable box

using with remote control **46**

CableCARD™ Device **25**

Camcorder, connecting **38**

Caption Vision **70**

Channel Menu **64**

Channel setting **57**

Channel Show Hide **64**

Channels

Auto Program **64**

creating labels **65**

setting up **30**

Clock/Timers **73**

closed caption modes **70**

Color temperature, adjusting **58**

Color, adjusting **58**

Connecting

Audio receiver **39**

Cable box **33**

Camcorder or PlayStation **38**

DVD player **36**

VCR **32–35**

D

Digital subchannels **49**

DISPLAY button **42**

Display unit

controls **14**

Display, turning off **42**

DVD 5.1Channel using with

remote control **47**

DVD player

using with remote control **46**

with A/V connectors,

connecting **37**

with component video
connectors,

connecting **36**

E

ENT button **42**

F

Favorite Channel

setting up **64**

Features **8**

FREEZE button **43, 51**

FUNCTION button **42**

G

Game Picture **62**

GUIDE button **42, 48**

Guide menu **49**

H

Hue, adjusting **58**

I

Inputs, labeling **70**

Installation of the projection TV
19–39

J

JUMP button **42, 51**

L

Label

Channels **30, 65**

video inputs **70**

Lamp, replacing **76–79**

M

MENU button **43**

Menus

Parent **66**

Screen **62**

Setup **70**

Mode

Custom **58**

Standard **58**

Vivid **58**

MTS/SAP **43, 61**

MUTING button **42**

N

Noise Reduction **59**

P

Parental control, described **9**

Parental Lock Settings **66**

Password, changing **67**

PICTURE button **42**

Picture contrast, adjusting **58**

POWER LED indicator **14**

problems, troubleshooting **80–83**

Program Guide **48**

Program Options menu **49**

R

Ratings

setting **68**

viewing blocked programs **67**

(Continued)

Rear panel controls and connections **16**
Remote control
 inserting batteries **41**
 programming **44–45**
Removing channels from the channel list **64**

S

Satellite Receiver **23**
satellite receiver, using with remote control **46**
Screen Menu **62**
Screen setting **56**
setting up channels **30**
Settings
 Application **57**
 Audio **56**
 Channel **57**
 Parental Lock **57**
 Screen **56**
 Setup **57**
 Video **56**
Setup menu **70**
Setup setting **57**
Sharpness, adjusting **58**
Specifications **84–85**
Steady Sound
 adjusting **60**
Surround sound **60, 61**

T

Timer
 set current **74**
TIMER indicator **11, 14**
Timer setting **73**
Treble, adjusting **60, 62**
troubleshooting **80–83**
TV FUNCTION button **42**
TV POWER button **43**
TV/VIDEO button **43**

V

VCR
 using with remote control **46**
 with cable box, connecting **33**
 with cable, connecting **32**
Video inputs, labeling **70**
Video Modes, selecting **58**

Video setting **56**
VOL +/- button **42**

W

WEGA GATE **43, 52–55**
WIDE button **43, 50**



<http://www.sony.net/>

Printed in U.S.A.
