

SONY[®]

4-097-520-11 (1)

GRAND WEGA



**LCD Projection TV
HD-Monitor
Operating Instructions**

**KDF-60XBR950
KDF-70XBR950**

XBR

DRC-MFV1
Digital Reality Creation

MEMORY STICK™

WARNING

To prevent fire or shock hazard, do not expose the LCD Projection TV to rain or moisture.

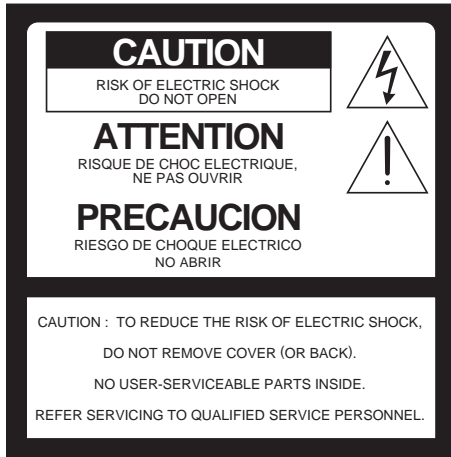

This symbol is intended to alert the user to the presence of uninsulated “dangerous voltage” within the product’s enclosure that may be of sufficient magnitude to constitute a risk of electric shock to persons.



This symbol is intended to alert the user to the presence of important operating and maintenance (servicing) instructions in the literature accompanying the appliance.

CAUTION

To prevent electric shock, do not use this polarized AC plug with an extension cord, receptacle or other outlet unless the blades can be fully inserted to prevent blade exposure.

Note on Caption Vision

This television receiver provides display of television closed captioning in accordance with §15.119 of the FCC rules.

Owner’s Record

The model and serial numbers are located at the rear of the LCD Projection TV, below the Sony logo, on the sticker, and also on the TV box (white label). Record these numbers in the spaces provided below. Refer to them whenever you call upon your Sony dealer regarding this product.

Model No. _____

Serial No. _____

Note to CATV system installer

This reminder is provided to call the CATV system installer’s attention to Article 820-40 of the NEC that provides guidelines for proper grounding and, in particular, specifies that the cable ground shall be connected to the grounding system of the building, as close to the point of cable entry as practical.

Use of this television receiver for other than private viewing of programs broadcast on UHF, VHF, transmitted by cable companies or satellite for the use of the general public may require authorization from the broadcaster/cable company and/or program owner.

NOTIFICATION

This equipment has been tested and found to comply with the limits for a Class B digital device pursuant to Part 15 of the FCC Rules. These limits are designed to provide reasonable protection against harmful interference in a residential installation. This equipment generates, uses, and can radiate radio frequency energy and, if not installed and used in accordance with the instructions, may cause harmful interference with radio communications. However, there is no guarantee that interference will not occur in a particular installation. If this equipment does cause harmful interference to radio or television reception, which can be determined by turning the equipment off and on, the user is encouraged to try to correct the interference by one or more of the following measures:

- Reorient or relocate the receiving antennas.
- Increase the separation between the equipment and receiver.
- Connect the equipment into an outlet on a circuit different from that to which the receiver is connected.
- Consult the dealer or an experienced radio/TV technician for help.

You are cautioned that any changes or modifications not expressly approved in this manual could void your warranty and your authority to operate this equipment.

This document is for the remote control RM-Y914.
MODEL: KDF-60XBR950, KDF-70XBR950
Please keep this notice with the instruction manual.

Safety

- ❑ Operate the LCD Projection TV only on 120 V AC.
 - ❑ The plug is designed, for safety purposes, to fit into the wall outlet only one way. If you are unable to insert the plug fully into the outlet, contact your dealer.
 - ❑ If any liquid or solid object should fall inside the cabinet, unplug the LCD Projection TV immediately and have it checked by qualified service personnel before operating it further.
 - ❑ If you will not be using the LCD Projection TV for several days, disconnect the power by pulling the plug itself. Never pull on the cord.
- For details concerning safety precautions, see “Important Safeguards” on page 4.

Installing

- ❑ To prevent internal heat buildup, do not block the ventilation openings.
- ❑ Do not install the LCD Projection TV in a hot or humid place, or in a place subject to excessive dust or mechanical vibration.
- ❑ Avoid operating the LCD Projection TV at temperature below 41°F (5°C).
- ❑ If the LCD Projection TV is transported directly from a cold to a warm location, or if the room temperature changes suddenly, the picture may be blurred or show poor color. In this case, please wait a few hours to let the moisture evaporate before turning on the LCD Projection TV.
- ❑ To obtain the best picture, do not expose the screen to direct illumination or direct sunlight. It is recommended to use spot lighting directed down from the ceiling or to cover the windows that face the screen with opaque drapery. It is desirable to install the LCD Projection TV in a room where the floor and walls are not of a reflective material.

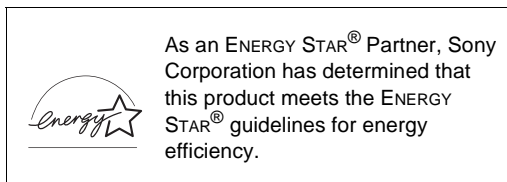

ENERGY STAR® is a U.S. registered mark.

TruSurround, SRS and the (●)® symbol are trademarks of SRS Labs, Inc.

TruSurround technology is incorporated under license from SRS Labs, Inc.

BBE and BBE Symbol are trademarks of BBE Sound, Inc. and are licensed by BBE Sound, Inc. under U.S. Patent No. 4,638,258 and 4,482,866.

“Dolby”, “Pro Logic”, and the double-D symbol are trademarks of Dolby Laboratories.

ATTENTION

Pour prévenir les chocs électriques, ne pas utiliser cette fiche polarisée avec un prolongateur, une prise de courant ou une autre sortie de courant, sauf si les lames peuvent être insérées à fond sans en laisser aucune partie à découvert.

Important Safety Instructions

- 1) Read these instructions.
- 2) Keep these instructions.
- 3) Heed all warnings.
- 4) Follow all instructions.
- 5) Do not use this apparatus near water.
- 6) Clean only with dry cloth.
- 7) Do not block any ventilation openings. Install in accordance with the manufacturer's instructions.
- 8) Do not install near any heat sources such as radiators, heat registers, stoves, or other apparatus (including amplifiers) that produce heat.
- 9) Do not defeat the safety purpose of the polarized or grounding-type plug. A polarized plug has two blades with one wider than the other. A grounding type plug has two blades and a third grounding prong. The wide blade or the third prong are provided for your safety. If the provided plug does not fit into your outlet, consult an electrician for replacement of the obsolete outlet.
- 10) Protect the power cord from being walked on or pinched particularly at plugs, convenience receptacles, and the point where they exit from the apparatus.
- 11) Only use attachments/accessories specified by the manufacturer.
- 12) Use only with the cart, stand, tripod, bracket, or table specified by the manufacturer, or sold with the apparatus. When a cart is used, use caution when moving the cart/apparatus combination to avoid injury from tip-over. 
- 13) Unplug this apparatus during lightning storms or when unused for long periods of time.
- 14) Refer all servicing to qualified service personnel. Servicing is required when the apparatus has been damaged in any way, such as power-supply cord or plug is damaged, liquid has been spilled or objects have fallen into the apparatus, the apparatus has been exposed to rain or moisture, does not operate normally, or has been dropped.
- 15) Apparatus shall not be exposed to dripping or splashing and no objects filled with liquids, such as vases, shall be placed on the apparatus.

Important Safeguards

For your protection, please read these instructions completely, and keep this manual for future reference.

Carefully observe and comply with all warnings, cautions and instructions placed on the set or described in the operating instructions or service manual.

WARNING

To guard against injury, the following basic safety precautions should be observed in the installation, use and servicing of the set.

Use

Power Sources

This set should be operated only from the type of power source indicated on the serial/model plate. If you are not sure of the type of electrical power supplied to your home, consult your dealer or local power company. For those sets designed to operate from battery power, refer to the operating instructions. 

Grounding or Polarization

This set is equipped with a polarized AC power cord plug (a plug having one blade wider than the other), or with a three-wire grounding type plug (a plug having a third pin for grounding). Follow the instructions below:

For the set with a polarized AC power cord plug

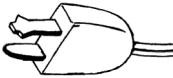
This plug will fit into the power outlet only one way. This is a safety feature. If you are unable to insert the plug fully into the outlet, try reversing the plug. If the plug still fails to fit, contact your electrician to have a suitable outlet installed. Do not defeat the safety purpose of the polarized plug by forcing it in. 

Alternate Warning for the set with a three-wire grounding type AC plug

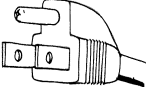
This plug will only fit into a grounding-type power outlet. This is a safety feature. If you are unable to insert the plug into the outlet, contact your electrician to have a suitable outlet installed. Do not defeat the safety purpose of the grounding plug. 

Overloading

Do not overload wall outlets, extension cords or convenience receptacles beyond their capacity, since this can result in fire or electric shock.

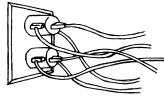

Always turn the set off when it is not being used. When the set is left unattended and unused for long periods of time, unplug it from the wall outlet as a precaution against the possibility of an internal malfunction that could create a fire hazard.



If a snapping or popping sound from a TV set is continuous or frequent while the TV is operating, unplug the TV and consult your dealer or service technician. It is normal for some TV sets to make occasional snapping or popping sounds, particularly when being turned on or off.

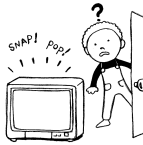

Object and Liquid Entry

Never push objects of any kind into the set through the cabinet slots as they may touch dangerous voltage points or short out parts that could result in a fire or electric shock. Never spill liquid of any kind on the set.



Attachments

Do not use attachments not recommended by the manufacturer, as they may cause hazards.

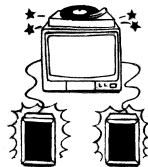

Cleaning

Clean the cabinet of the LCD Projection TV with a dry soft cloth. To remove dust from the screen, wipe it gently with a soft cloth. Stubborn stains may be removed with a cloth slightly dampened with solution of mild soap and warm water. Never use strong solvents such as thinner or benzine for cleaning.



If the picture becomes dark after using the LCD Projection TV for a long period of time, it may be necessary to clean the inside of the LCD Projection TV. Consult qualified service personnel.

On contamination on the screen surface

The screen surface has a special coating to reduce a picture displayed by reflecting. If you clean the screen surface in the wrong way, the screen may be damaged. To clean the screen, do as follows:

- ❑ Clean the screen with a soft cloth, such as the supplied cleaning cloth or a glass cleaning cloth.
- ❑ To remove hard contamination, use the supplied cleaning cloth or a glass cleaning cloth moistened with a solution of mild detergent and water.
- ❑ Do not use any type of abrasive pad, alkaline cleaner, acid cleaner, scouring powder, chemical cloth, or solvent such as alcohol, benzene or thinner, as these may scratch the screen's coating.

Installation

Water and Moisture

Do not use power-line operated sets near water — for example, near a bathtub, washbowl, kitchen sink, or laundry tub, in a wet basement, or near a swimming pool, etc.



Accessories

Do not place the set on an unstable cart, stand, table or shelf. The set may fall, causing serious injury to a child or an adult and serious damage to the set. Use only a cart or stand recommended by the manufacturer for the specific model of LCD Projection TV. An appliance and cart combination should be moved with care. Quick stops, excessive force, and uneven surfaces may cause the appliance and cart combination to overturn.



Ventilation

The slots and openings in the cabinet and in the back or bottom are provided for necessary ventilation. To ensure reliable operation of the set, and to protect it from overheating, these slots and openings must never be blocked or covered.

- ❑ Never cover the slots and openings with a cloth or other materials.



- ❑ Never block the slots and openings by placing the set on a bed, sofa, rug or other similar surface.



- ❑ Never place the set in a confined space, such as a bookcase or built-in cabinet, unless proper ventilation is provided.



- ❑ Do not place the set near or over a radiator or heat register, or where it is exposed to direct sunlight.



Power-Cord Protection

Do not allow anything to rest on or roll over the power cord, and do not place the set where the power cord is subject to wear or abuse.



Antennas

Outdoor Antenna Grounding

If an outdoor antenna is installed, follow the precautions below. An outdoor antenna system should not be located in the vicinity of overhead power lines or other electric light or power circuits, or where it can come in contact with such power lines or circuits.

WHEN INSTALLING AN OUTDOOR ANTENNA SYSTEM, EXTREME CARE SHOULD BE TAKEN TO KEEP FROM CONTACTING SUCH POWER LINES OR CIRCUITS AS CONTACT WITH THEM IS ALMOST INVARIABLY FATAL.

Be sure the antenna system is grounded so as to provide some protection against voltage surges and built-up static charges.

Section 810 of the National Electrical Code (NEC) in USA and Section 54 of the Canadian Electrical Code in Canada provides information with respect to proper grounding of the mast and supporting structure, grounding of the lead-in wire to an antenna discharge unit, size of grounding conductors, location of antenna discharge unit, connection to grounding electrodes, and requirements for the grounding electrode.

Antenna Grounding According to the NEC

Refer to section 54-300 of Canadian Electrical Code for Antenna Grounding.

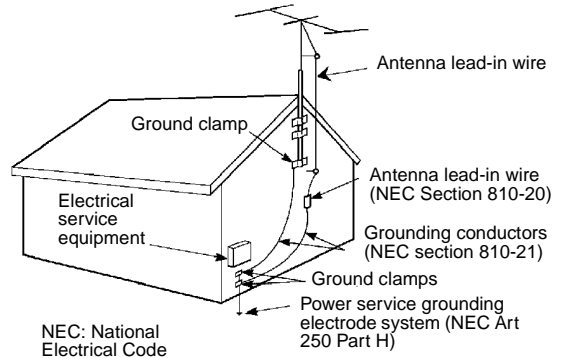





Lightning

For added protection for this television receiver during a lightning storm, or when it is left unattended and unused for long periods of time, unplug it from the wall outlet and disconnect the antenna. This will prevent damage to the receiver due to lightning and power-line surges.

Service

Damage Requiring Service

Unplug the set from the wall outlet and refer servicing to qualified service personnel under the following conditions:

- ❑ When the power cord or plug is damaged or frayed. 
- ❑ If liquid has been spilled into the set. 
- ❑ If the set has been exposed to rain or water. 
- ❑ If the set has been subject to excessive shock by being dropped, or the cabinet has been damaged. 
- ❑ If the set does not operate normally when following the operating instructions. Adjust only those controls that are specified in the operating instructions. Improper adjustment of other controls may result in damage and will often require extensive work by a qualified technician to restore the set to normal operation. 
- ❑ When the set exhibits a distinct change in performance, it indicates a need for service.

Servicing

Do not attempt to service the set by yourself since opening the cabinet may expose you to dangerous voltage or other hazards. Refer all servicing to qualified service personnel.



Replacement Parts

When replacement parts are required, be sure the service technician certifies in writing that he has used replacement parts specified by the manufacturer that have the same characteristics as the original parts.

Unauthorized substitutions may result in fire, electric shock or other hazards.

Safety Check

Upon completion of any service or repairs to the set, ask the service technician to perform routine safety checks (as specified by the manufacturer) to determine that the set is in safe operating condition, and to so certify. When the set reaches the end of its useful life, improper disposal could result in a picture tube implosion. Ask a qualified service technician to dispose of the set.



For Safety

Be careful when moving the LCD Projection TV

When you place the LCD Projection TV in position, be careful not to drop it on your foot or fingers.

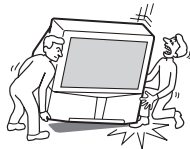

Watch your footing while installing the LCD Projection TV.

Carry the LCD Projection TV in the specified manner

If you carry the LCD Projection TV in a manner other than the specified manner and without the specified number of persons, it may drop and a serious injury may be caused. Be sure to follow the instructions mentioned below.

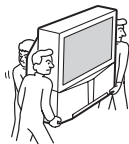

- ❑ Carry the LCD Projection TV with the specified number of persons (see page 18).
- ❑ Do not carry the LCD Projection TV holding the speaker grill.
- ❑ Hold the LCD Projection TV tightly when carrying it.

About the LCD Projection TV

Although the LCD projection TV is made with high-precision technology, black dots may appear or bright points of light (red, blue, or green) may appear constantly on the LCD screen. This is a structural property of the LCD panel and is not a malfunction.

Installation

- ❑ If direct sunlight or other strong illumination shines on the screen, part of the screen may appear white due to reflections from behind the screen. This is a structural property of the LCD Projection TV. Do not expose the screen to direct illumination or direct sunlight.
- ❑ The picture quality may be affected by your viewing position. If you sit too close to the TV, you may suffer from eye fatigue. For the best picture quality, install your LCD projection TV according to the operating instructions. Sit at least 2.2 m (approx. 7 ft.) for KDF-60XBR950 or 2.6 m (approx. 8 ft.) for KDF-70XBR950 away from your LCD projection TV, and within 60° of the vertical viewing area, and 130° of the horizontal viewing area.
- ❑ When installing your LCD Projection TV against a wall, keep it at least 10 cm (4 inches) from the wall.
- ❑ Avoid installing the LCD projection TV near a heater, etc.

Projection lamp

- ❑ Your LCD projection TV uses a projection lamp as its light source. When the projection lamp wears out after using the LCD projection TV for a long period of time, the screen image becomes dark, or no image will appear on the display. If the lamp replacement indicator of the front panel blinks in red, replace the lamp with a new one (not supplied). In some cases, the bulb bursts inside the lamp unit noisily, but the lamp unit is securely designed so that the pieces of broken glass remain inside the lamp unit. (See “Replacing the Lamp” on page 13.)

Cooling fan

- ❑ This LCD projection TV uses a cooling fan to prevent the internal temperature from heating up. You might hear the noise from the cooling fan, depending on the place you install the LCD projection TV.

Contents

Introducing the Sony LCD Projection TV

Presenting the Sony LCD Projection TV	9
Using This Manual.....	10
Enjoying Your LCD Projection TV	11
Replacing the Lamp	13

Installing and Connecting the LCD Projection TV

Contents	17
Inserting Batteries into the Remote Control	17
Carrying Your LCD Projection TV	18
To Prevent the LCD Projection TV from Falling Down.....	19
When Installing Your LCD Projection TV Against a Wall	19
Recommended Viewing Area.....	20
LCD Projection TV Controls and Connectors	21
Basic Connections: Connecting a Cable or Antenna.....	25
Connecting a VCR and Cable.....	32
Connecting a VCR and Cable Box	33
Connecting Two VCRs for Tape Editing	35
Connecting a Satellite Receiver.....	36
Connecting a Satellite Receiver with a VCR.....	37
Connecting an Audio Receiver.....	39
Connecting a DVD Player with Component Video Connectors	40
Connecting a DVD Player with A/V Connectors ..	41
Connecting a Camcorder	42
Connecting a Device with an Optical IN Connector.....	43
Using the CONTROL S Feature.....	44
Setting Up the LCD Projection TV Automatically.....	45

Using the Features

Using the Remote Control	46
Programming the Remote Control.....	48
Using Other Equipment with Your LCD Projection TV Remote Control	50
Watching the TV	52
Using Favorite Channels.....	54

Using Twin View™.....	55
Using the Freeze Function.....	58
Using Wide Screen Mode.....	59

Using the Digital Program Guide

Displaying the Digital Program Guide	60
--	----

Using the Memory Stick Viewer

About Memory Stick	64
Inserting and Removing a Memory Stick.....	66
Using the Memory Stick Index.....	69
Viewing Photos.....	71
Playing Movies	74
Memory Stick Index Menu Bar Options	76
Notes on Using Memory Stick Media	78

Using i.LINK

About i.LINK.....	80
Selecting an i.LINK Device.....	83
Using the i.LINK Control Panel	84
i.LINK Setup.....	86

Using the Menus

Overview.....	87
Using the Video Menu.....	88
Using the Audio Menu.....	92
Using the Screen Menu.....	94
Using the Channel Menu	96
Using the Parent Menu	98
Using the Setup Menu	102

Other Information

Overview.....	106
Glossary	107
Contacting Sony.....	108
Troubleshooting.....	108
Flashing Indicators on the Front of the Monitor..	114
Specifications.....	115

Introducing the Sony LCD Projection TV

Presenting the Sony LCD Projection TV

Thank you for purchasing the Sony LCD Projection TV.
This manual is for models KDF-60XBR950 and KDF-70XBR950.

Features

Some of the features that you will enjoy with your new LCD projection TV include:

- ❑ **Integrated HDTV:** You can watch digital television programs and enjoy the improved audio/video quality offered by these programs.
- ❑ **DRC[®] (Digital Reality Creation) Multifunction V1:** Unlike conventional line doublers, the DRC feature converts frames reproduced every 1/60th of a second in real time, minimizing the blur or ghost of the motion images (for 480i signals only).
- ❑ **CineMotion[™]:** Using the reverse 3-2 pull down technology, the CineMotion feature allows you to obtain a smooth picture movement when playing back movies or other video sources on film.
- ❑ **Twin View[™]:** Using Multi-Image Driver (MID-X), Twin View allows you to watch two programs side by side with the ability to zoom in on one picture and listen to the program in the selected window. You can watch pictures from two different sources (1080i, 720p, 480p or 480i) simultaneously.
- ❑ **Memory Stick[®] Viewer:** Allows you to view on your LCD Projection TV screen digital photos (JPEG) and movies (MPEG1) that are stored on Memory Stick media.
- ❑ **Parental Control:** V-Chip technology allows parents to block unsuitable programming for younger viewers.
- ❑ **Digital Visual Interface (DVI-HDTV):** Can accommodate a copy-protected digital connection (HDCP^{*}) to other devices (such as digital set-top boxes) that have compatible interfaces. The DVI-HDTV input terminal is compliant with the EIA-861 standard and is not intended for use with personal computers.

* High-bandwidth Digital Content Protection

(Continued)

- ❑ **i.LINK:** Provides a secure digital interface to other digital home entertainment devices. i.LINK allows for the secure transfer of copyright-protected high-definition content between these devices and your LCD projection TV. The i.LINK is not compatible with personal computers.
- ❑ **Component Video Inputs:** Offers the best video quality for DVD (480p, 480i) and Digital Set-top box (1080i, 720p, 480p, 480i) connections.
- ❑ **S-VIDEO Inputs:** Provides a high-quality image for connected equipment.
- ❑ **Favorite Channel Preview:** Preview up to sixteen favorite channels without leaving the current channel.
- ❑ **Wide Screen Mode:** Allows you to watch 4:3 normal broadcasts in wide screen mode (16:9 aspect ratio).
- ❑ **Auto Wide:** Allows you to select the wide screen mode automatically.

Using This Manual

We recommend that you carefully review the contents of the following three sections in the order shown to ensure that you fully understand the operation of your new LCD projection TV.

- 1 **Installing and Connecting the LCD Projection TV**
This section guides you through your initial setup. It shows you how to install your LCD projection TV, to connect your new components and to connect the antenna and cable.
- 2 **Using the Features**
This section shows you how to begin using your new LCD projection TV. It also shows you how to use your remote control functions.
- 3 **Using the menus**
This section teaches you how to access on-screen menus and adjust your LCD projection TV settings.

Instructions in this manual are written for the remote control. Similar controls are also found on the LCD projection TV console.

Enjoying Your LCD Projection TV

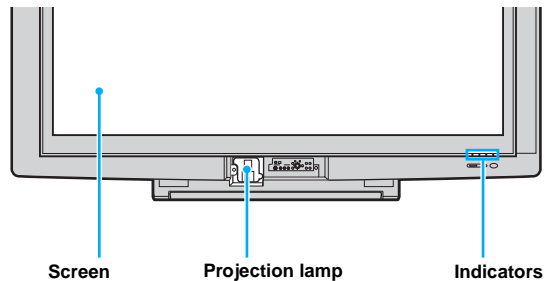

Indicators

The indicators show the current status of your LCD projection TV.

Screen

To minimize screen reflection, its surface has a special coating. Read the instructions “Use of the Cleaning Cloth” on page 12 carefully before cleaning.

Inappropriate cleaning methods could damage the finishing.

Projection lamp

Your LCD projection TV uses a projection lamp as its light source. Note the following:

- ❑ After turning on your LCD projection TV, it may take a while before the picture appears (1 minute or less).
 - ❑ When the projection lamp wears out, the screen image becomes dark. Replace the lamp with a new Sony XL-2100U replacement lamp (not supplied).
- 🔧 Be sure to attach the lamp cover securely; otherwise, your LCD projection TV will not turn on. For details on lamp replacement, see “Replacing the Lamp” on page 13.
 - 🔧 The light emitted from the lamp is quite bright when your LCD projection TV is in use. To avoid eye discomfort or injury, do not look into the housing when the power is on.

Notes on the LCD Projection TV

To enjoy clear pictures

- ❑ Be sure not to allow sunlight or light from a lamp to shine directly onto the screen.
- ❑ The screen surface is easily scratched. Do not rub, touch, or tap it with a sharp or abrasive object (see “Use of the Cleaning Cloth” below).

On moisture condensation

- ❑ If your LCD projection TV is transported directly from a cold to a warm location, is placed in a humid room, or if the room temperature changes suddenly, the picture may be blurred or show poor color. This is because moisture has condensed on the lenses inside. If this happens, leave the power on and let the moisture evaporate before using your LCD projection TV.

When the LCD projection TV will not be used for a long period of time

- ❑ Turn off the main power on the front of your LCD projection TV before going to sleep or going out. Disconnect the AC plug if idle for more than 7 days.

When turning off the power

- ❑ Be sure to turn off the power switch on the main unit or on the remote control. After turning off the power, the fan will continue to blow for about two minutes. Be sure to wait for several minutes after turning the power off when unplugging from the outlet or switching the breaker off.

When carrying the LCD Projection TV

- ❑ Before carrying, unplug the power cord and disconnect all cables. Do not carry the LCD projection TV by placing hands under the front screen.

Use of the Cleaning Cloth

To remove dust from the front of the screen, wipe with the supplied Cleaning Cloth.

- 🧽 Do not use any type of abrasive pad, alkaline cleaner, scouring powder, window cleaners or solvent such as alcohol or benzene. Otherwise, this type of contact may result in a damaged screen.
- 🧽 To clean the screen, please use the supplied Cleaning Cloth lightly moistened with water diluted mild detergent solution. Do not apply heavy press when cleaning.
- 🧽 The supplied Cleaning Cloth is washable with warm water and a mild detergent solution, and can be used repeatedly.

Replacing the Lamp

The projection lamp has a limited life which illuminates the picture.

If the screen becomes dark, the color looks unusual, or the LAMP indicator on the front of the LCD projection TV flashes, it is time to replace the lamp with a new one (not supplied).



WARNING

Electric appliances can cause fire or high temperature, resulting in injury or death. Be sure to follow the instructions below.

- ❑ Use a Sony XL-2100U replacement lamp (not supplied) for replacement. Failure to do so may damage the LCD projection TV.
- ❑ Do not remove the lamp for any purpose other than replacement. Failure to do so may cause fire or a skin burn.
- ❑ Before replacing the lamp, turn the power off on the main unit, then several minutes later, unplug the power cord. (The cooling fan will continue to blow for about two minutes after turning the power off.)
- ❑ Before replacing the lamp, let it cool down completely, as the surface of the lamp remains extremely hot for at least 30 minutes after the power has been turned off.
- ❑ Do not leave the removed lamp near flammable materials or within the reach of children.
- ❑ Do not pour water onto the removed lamp, or put any object inside the lamp. Doing so may cause the lamp to burst.
- ❑ Do not put flammable materials and metal objects inside the lamp receptacle of the LCD projection TV after removing the lamp. Doing so may cause fire or electrical shock. Also, be sure not to touch the receptacle, because it may cause a skin burn.
- ❑ Mount the new lamp securely, otherwise the screen may become dark, or it may cause a fire.
- ❑ Do not touch the glass with your fingers on the new lamp.

The used lamp

Used lamp contains Mercury, Dispose According to Local, State or Federal Laws.



Do not touch the front glass of a new lamp or the glass of the lamp receptacle. This may reduce picture quality or lamp life.

(Continued)

- 1 Turn off the power switch on the LCD projection TV and after several minutes, unplug the power cord.
(The cooling fan will continue to blow for about two minutes after turning the power off.)

 Do not touch the front glass of a new lamp or the glass of the lamp receptacle. This may reduce picture quality or lamp life.

- 2 Unplug the power cord after turning off the main power. Wait at least 30 minutes to allow the lamp to cool down before replacing it.
Take the new lamp out of the box.
- 3 Remove the control panel cover.

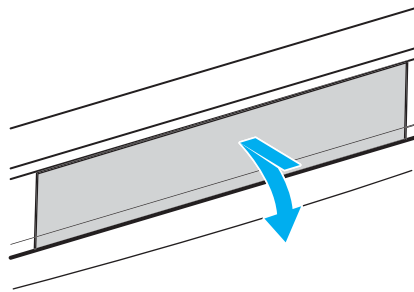

Push and release the center in the upper of the control panel cover to open it.

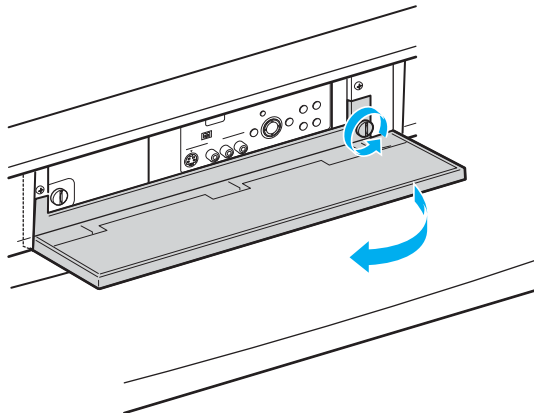

Loosen the screw in the right underneath with a coin or similar object and remove the control panel cover.

- 4 Loosen the screw with a coin or similar object to remove the lamp cover.

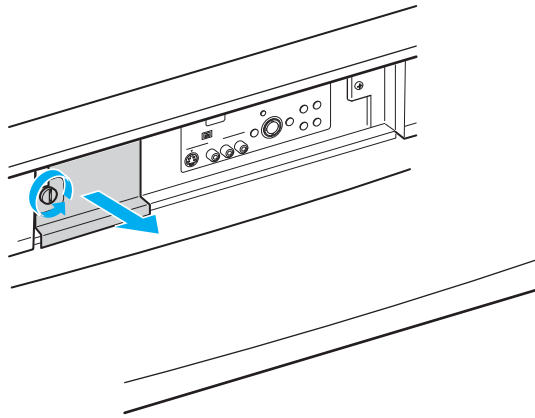

- 5 Loosen the two screws that secure the lamp, then pull out the lamp. The lamp is very hot immediately after use. Never touch the front glass of the lamp or the surrounding parts.

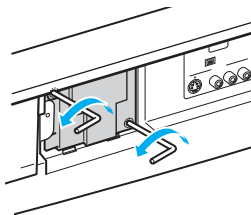

Loosen the two screws as shown in the illustration using the hex key supplied with the lamp.

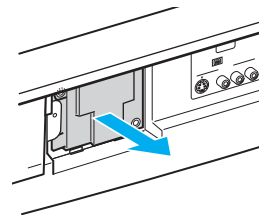

Hold the handle and pull straight out.

 After it has cooled, place the removed lamp into the empty box of the replacement lamp. Never put the removed lamp into a plastic bag.

- 6 Mount the new lamp. Be sure to attach the new lamp securely.

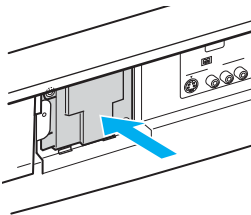

Mount the new lamp securely into the lamp receptacle.

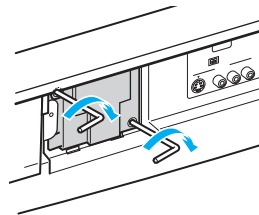

Tighten the two screws securely as shown in the illustration using the hex key supplied with the lamp.

(Continued)

- 7 Mount the lamp cover and tighten the screw.
Make sure that the lamp cover is mounted securely, otherwise the power will not turn on.

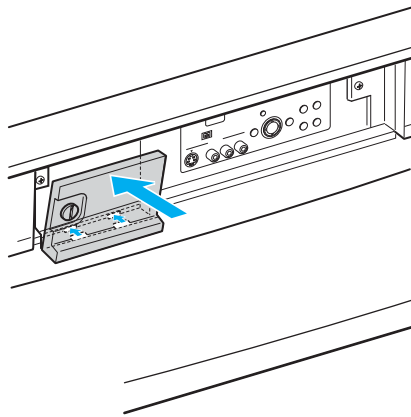

Match the projections of the underneath of the lamp cover with the holes of the unit, and replace the lamp cover as it was.

 If the lamp cover is not mounted securely, the self-diagnostic function works and the POWER/STANDBY indicator flashes for three times.

- 8 Mount the front panel in the order of ① to ③, as shown in the illustration.

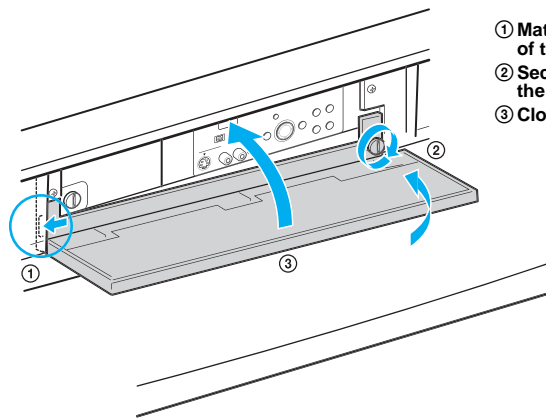

- ① Match the projection of the left side.
- ② Secure the screw of the right side.
- ③ Close the front panel.

 Consult your Sony dealer for a Sony XL-2100U replacement lamp.

 Take great care when replacing the lamp or plugging in/unplugging the connecting cords. If you handle them roughly, the LCD projection TV may fall or be moved, and the TV stand or floor surfaces may be scratched.

Installing and Connecting the LCD Projection TV

Contents

The box contains your new LCD projection TV, a remote control and two AA (R6) batteries. No peripheral cables are included. If you intend to add additional equipment to your LCD projection TV, please check the hookup instructions for your desired setup before you begin. You may need to purchase cables and/or splitters to complete the hookup properly.

Inserting Batteries into the Remote Control

Insert two size AA (R6) batteries (supplied) by matching the + and – on the batteries to the diagram inside the battery compartment.

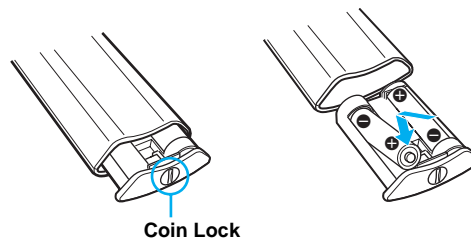

- ✎ Remove the batteries to avoid damage from possible battery leakage whenever you anticipate that the remote control will not be used for an extended period.
- ✎ Handle the remote control with care. Avoid dropping it, getting it wet, or placing it in direct sunlight, near a heater, or where the humidity is high.
- ✎ Your remote control can be programmed to operate most video equipment. (See “Programming the Remote Control” on page 48.)

Carrying Your LCD Projection TV

Carrying the LCD projection TV requires at least four people. Do not grasp the pedestal or the front panel of the LCD projection TV, otherwise these parts might break off.

When moving the LCD projection TV, support the screen bottom with one hand while grasping the top part with the other hand, as shown in the illustration below.

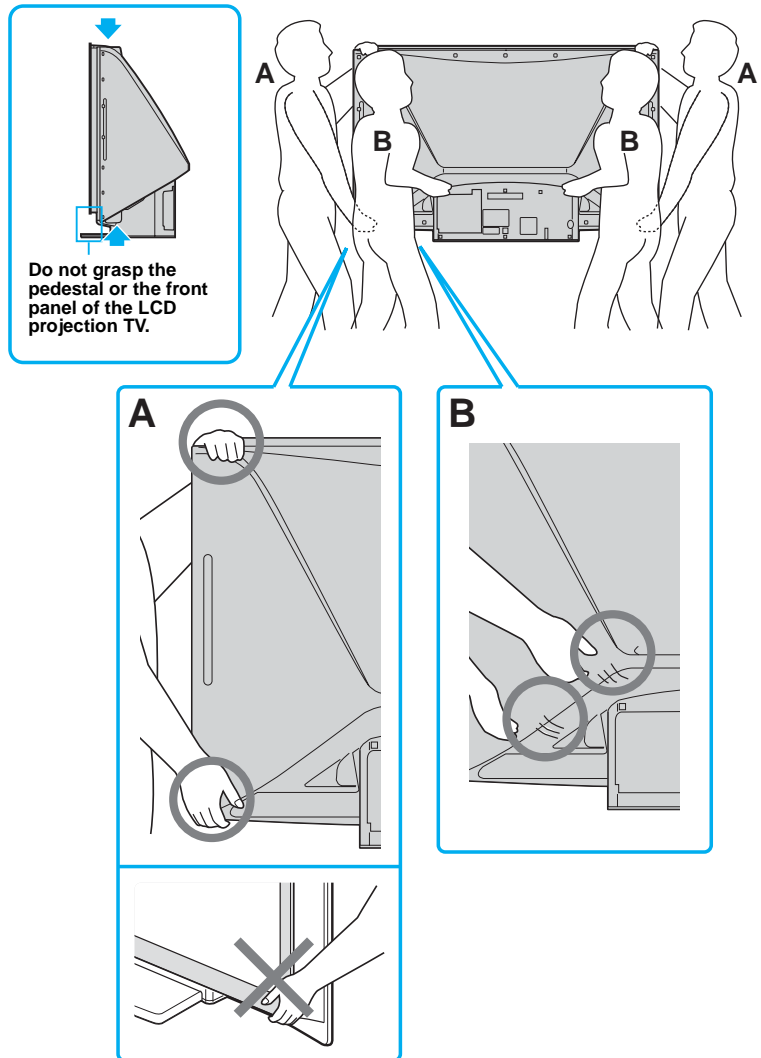

To Prevent the LCD Projection TV from Falling Down

Pay special attention to children around the LCD projection TV. If children should climb onto or push the LCD projection TV or its stand SU-GW3 (not supplied), it may fall down.

When Installing Your LCD Projection TV Against a Wall

Keep your LCD projection TV at least 10 cm (4 inches) from the wall.

Recommended Viewing Area

The picture quality may be affected by your viewing position.

For the best picture quality, install your LCD projection TV within the areas shown below.

Sit at least 2.2 m (approx. 7 ft.) for KDF-60XBR950 or 2.6 m (approx. 8 ft.) for KDF-70XBR950 away from your LCD projection TV, and within 60° of the vertical viewing area, and 130° of the horizontal viewing area.

Horizontal Viewing Area

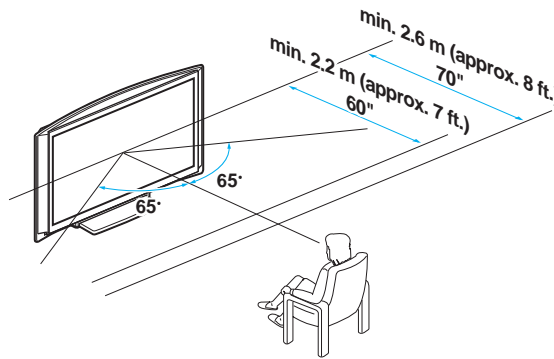

Vertical Viewing Area

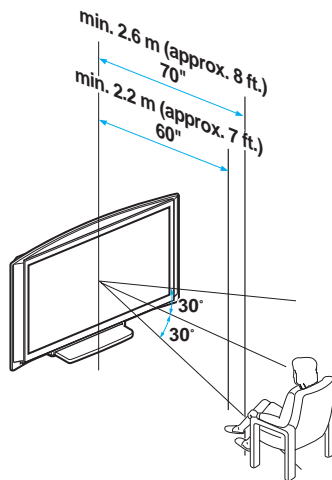

LCD Projection TV Controls and Connectors

Front Panel Menu Controls

The front panel menu controls allow access to the on-screen menus without using the remote control. Pressing **MENU** brings up the on-screen menus. The arrow buttons move the on-screen cursor in the menus and by pressing the **↔** button selects the menu item.

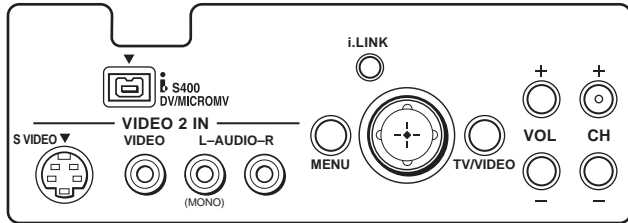

How to open and close the front panel

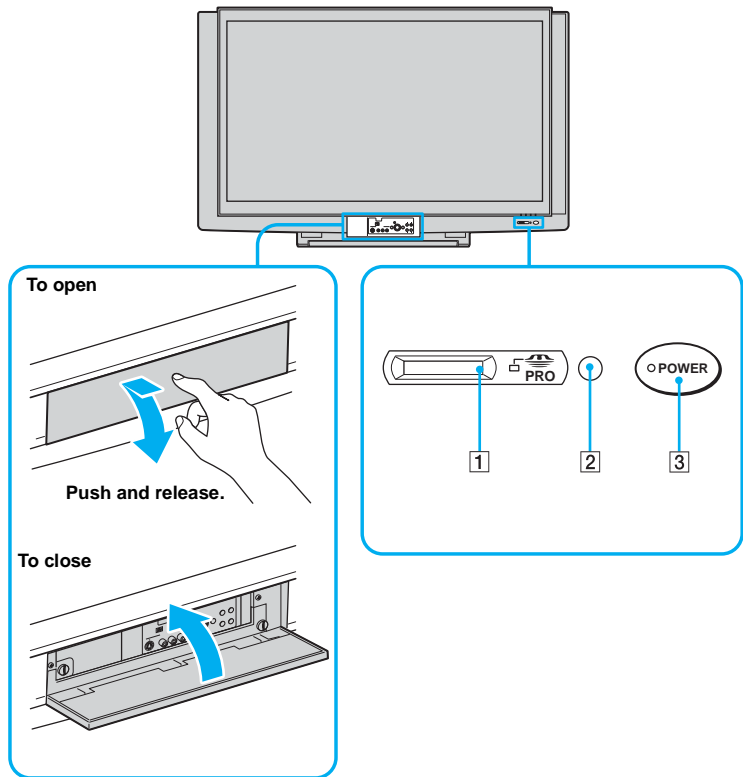

(Continued)

Item	Description
1	Memory Stick slot Memory Stick insertion slot. For details, see “Inserting and Removing a Memory Stick” on page 66.
2	Memory Stick indicator When lit, indicates that the Memory Stick is being read. (Do not remove the Memory Stick when the indicator is lit.)
3	POWER Press to turn on and off the LCD projection TV.

LCD Projection TV Rear and Front Panel Connectors

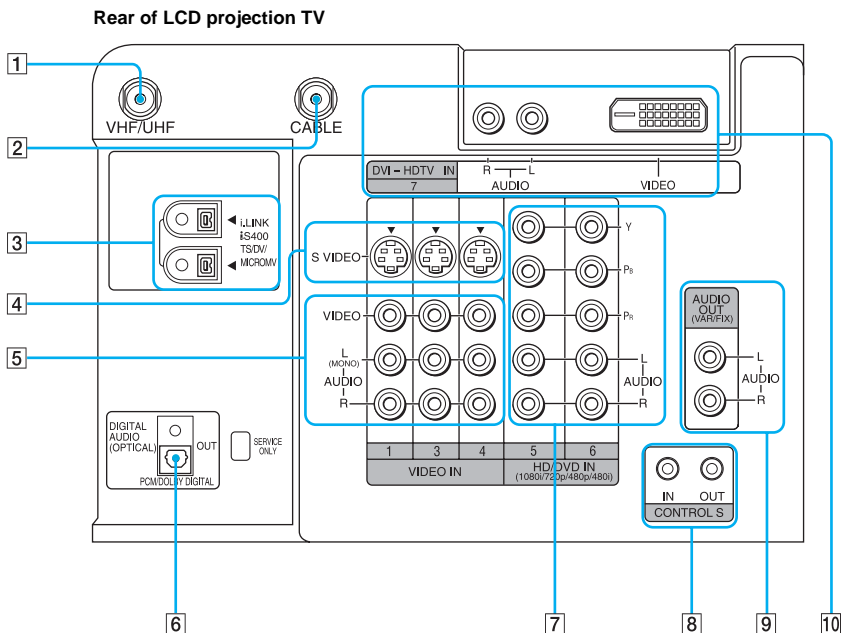

Front Panel of LCD projection TV

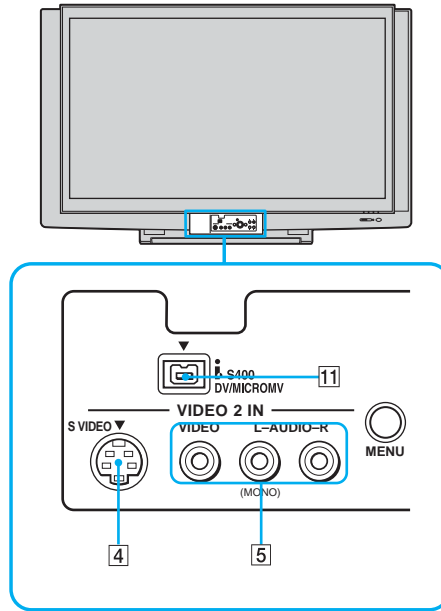

Front panel connectors are in the control panel cover. To open and close the cover, refer to page 21.

Connection	Description
1 VHF/UHF	Connects to your VHF/UHF antenna or cable box output jack.
2 CABLE	Connects to your cable signal. This CABLE input jack, in conjunction with the VHF/UHF input jack, lets you set up your LCD projection TV to switch between scrambled channels (coming through a cable box) and unscrambled cable channels. For details, see page 28.
3 i.LINK	Connects to i.LINK-compatible devices. These terminals are not intended for connection with personal computers.
4 S VIDEO (Front and rear)	Connects to the S VIDEO OUT jack of your VCR or other S VIDEO-equipped video component. Provides better picture quality than the VHF/UHF jacks or the Video IN jack.
5 VIDEO/ (L/R) AUDIO (Front and rear)	Connects to the audio and video OUT jacks on your VCR or other video component. A fourth video input (VIDEO 2) is located on the front panel of the LCD projection TV.

(Continued)

Connection	Description
6 DIGITAL AUDIO (OPTICAL) OUT (PCM/DOLBY* DIGITAL)	Connects to the optical audio input of a digital audio component that is PCM/Dolby digital compatible.
7 HD/DVD IN (1080i/720p/480p/480i)	Connects to your DVD player's or Digital Set-top box's component video (Y, PB, PR) and audio (L/R) jacks.
8 CONTROL S IN/OUT	<p>To control other Sony equipment with the LCD projection TV's remote control, connect the CONTROL S IN jack of the equipment to the CONTROL S OUT jack on the LCD projection TV with the CONTROL S cable.</p> <p>To control the LCD projection TV with a remote control for another Sony product, connect the CONTROL S OUT jack of the equipment to the CONTROL S IN jack on the LCD projection TV with the CONTROL S cable.</p>
9 AUDIO OUT (VAR/FIX) L/R	Connects to the left and right audio inputs of your audio or video component.
10 DVI-HDTV VIDEO AUDIO L/R (VIDEO 7 IN)	Can accommodate a copy-protected digital connection (HDCP**) to other devices (such as digital set-top boxes) that have compatible interfaces. The DVI-HDTV input terminal is compliant with the EIA-861 standard and is not intended for use with personal computers. See the instruction manual that came with your equipment for details about connecting and using it with the LCD projection TV.
11 i.LINK	Connects to the i.LINK jack on your i.LINK-compatible portable device. Provides a secure digital connection between your LCD projection TV and your i.LINK-compatible portable device.

* “Dolby”, “Pro Logic”, and the double-D symbol are trademarks of Dolby Laboratories.

** High-bandwidth Digital Content Protection

Basic Connections: Connecting a Cable or Antenna

The way in which you will connect your LCD projection TV varies, depending on how your home receives a signal (cable, cable box, antenna) and whether or not you plan to connect a VCR.

<i>If You Are Connecting</i>	<i>See Page</i>
<i>Cable or Antenna Only</i>	26
<input type="checkbox"/> No cable box or VCR	
<i>Cable Box and Cable Only</i>	28
<input type="checkbox"/> Cable box unscrambles only some channels (usually premium channels)	
<input type="checkbox"/> No VCR	
<i>Cable Box Only</i>	30
<input type="checkbox"/> Cable box unscrambles all channels	
<input type="checkbox"/> No VCR	

If you are connecting a VCR

- See the connections described on pages 32 and 33.

Cable or Antenna Only

For best results, use one of the following connections if you are connecting a cable or an antenna and you:

- ❑ Do not need a cable box to unscramble channels. (If you have a cable box, see pages 28 to 30.)
- ❑ Do not intend to connect a VCR. (If you have a VCR, see pages 32 and 33.)

The connection you choose depends on the cable type you have in your home, as described below.

75-ohm coaxial cable (usually found in newer homes)

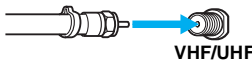
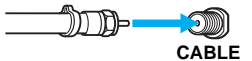
Cable Type	Connect As Shown
VHF Only or combined VHF/UHF	 <p>75-ohm coaxial cable</p> <p>Rear of LCD projection TV VHF/UHF</p>
Cable	 <p>75-ohm coaxial cable</p> <p>Rear of LCD projection TV CABLE</p>

300-ohm twin lead cable (usually found in older homes)

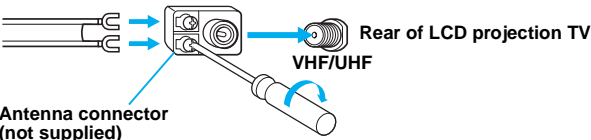
Cable Type	Connect As Shown
VHF Only or UHF Only or combined VHF/UHF	 <p>300-ohm twin lead cable</p> <p>Rear of LCD projection TV VHF/UHF</p> <p>Antenna connector (not supplied)</p>

75-ohm coaxial and 300-ohm twin lead cable (found in some homes)

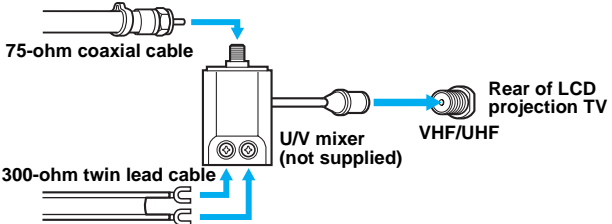
Cable Type	Connect As Shown
VHF and UHF	 <p>75-ohm coaxial cable</p> <p>300-ohm twin lead cable</p> <p>U/V mixer (not supplied)</p> <p>Rear of LCD projection TV VHF/UHF</p>

Notes on Using This Connection

To Do This ...	Do This ...
Switch the TV's input between the cable and antenna	Press ANT to switch back and forth between the TV's VHF/UHF and CABLE inputs.

- ✎ It is highly recommended to connect the antenna using a 75-ohm coaxial cable to get optimum picture quality. A 300-ohm twin lead cable can be easily affected by radio noise and the like, resulting in signal deterioration. If you use a 300-ohm twin lead cable, keep it away as far as possible from the LCD projection TV.
- ✎ Do not use an indoor antenna because it is especially susceptible to radio noise.

Cable Box and Cable Only

For best results, use this connection if:

- ❑ Your cable company scrambles some channels, such as premium channels (which requires you to use a cable box), but does not scramble all channels.
- ❑ You do not have a VCR. (If you have a VCR, see pages 32 and 33.)

With this connection you can:

- ❑ Use the LCD projection TV remote control to change channels coming through the cable box to the LCD projection TV’s VHF/UHF input jack. (You must first program the remote control for your specific cable box; see “Programming the Remote Control” on page 48.)
- ❑ Use the LCD projection TV remote control to change channels coming directly into the LCD projection TV’s CABLE input. (The LCD projection TV’s tuner provides a better signal than the cable box.)

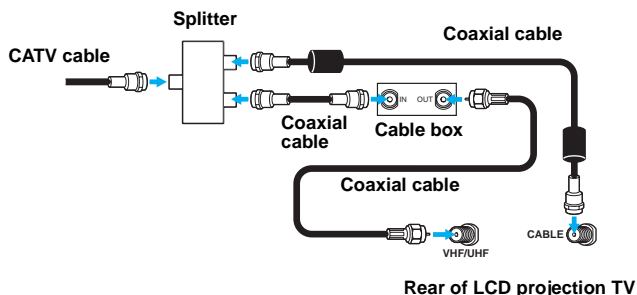

About Using This Connection with Dual Picture (Twin View, etc.) Features

With this connection, you can use all the dual picture features for unscrambled channels coming directly into the LCD projection TV’s CABLE input jack.

Notes on Using This Connection

To Do This ...	Do This ...
Use the cable box	Tune the LCD projection TV to the channel the cable box is set to (usually channel 3 or 4) and then use the cable box to switch channels.
Set up the LCD projection TV remote control to operate the cable box	Program the remote control. See “Programming the Remote Control” on page 48.
Activate the remote control to operate the cable box	Press FUNCTION repeatedly until the SAT/CABLE indicator lights up.

Prevent the accidental switching of TV channels	When using the cable box, you need the LCD projection TV to stay on the channel the cable box is set to (usually channel 3 or 4). You can use the LCD projection TV's Channel Fix feature to lock in a specific channel. For details, see "Using the Channel Menu" on page 96.
Switch the LCD projection TV's input between the cable box and cable	Press ANT to switch back and forth between the LCD projection TV's VHF/UHF (scrambled channels) and CABLE (unscrambled) inputs.

Cable Box Only

For best results, use this connection if:

- ❑ Your cable company scrambles all channels, which requires you to use a cable box.
- ❑ You do not have a VCR. (If you have a VCR, see pages 32 and 33.)

With this connection you can:

- ❑ Use the LCD projection TV remote control to change channels coming through the cable box to the LCD projection TV's VHF/UHF jack. (You must first program the remote control for your specific cable box.)

About Using This Connection with Dual Picture (Twin View, etc.) Features

With this connection, all channels come into the LCD projection TV through your cable box and only one unscrambled signal is sent to the LCD projection TV, so you cannot use the dual picture features. If some of your channels are scrambled, but others are not, consider using the "Cable Box and Cable Only" connection on page 28 instead.

To connect the cable box

- 1 Connect the CATV cable to the cable box's input jack.
- 2 Use a coaxial cable to connect the cable box's output jack to the LCD projection TV's VHF/UHF jack.
- 3 Run the Auto Setup program, as described in "Setting Up the LCD Projection TV Automatically" on page 45.

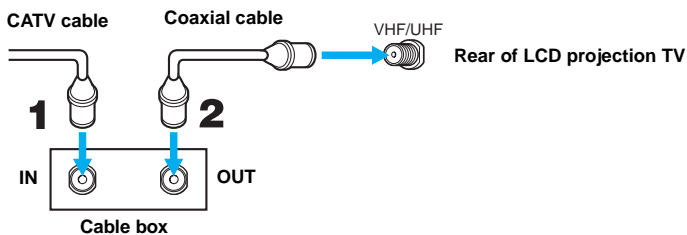

Notes on Using This Connection

To do this...	Do This ...
Use the cable box	Tune the LCD projection TV to the channel the cable box is set to (usually channel 3 or 4) and then use the cable box to switch channels.
Set up the LCD projection TV remote control to operate the cable box	Program the remote control. See "Programming the Remote Control" on pages 48.

Activate the remote control to operate the cable box	Press FUNCTION repeatedly until the SAT/CABLE indicator lights up.
Prevent the accidental switching of TV channels	When using the cable box, you need the LCD projection TV to stay on the channel the cable box is set to (usually channel 3 or 4). You can use the LCD projection TV's Channel Fix feature to lock in a specific channel. For details, see "Using the Channel Menu" on page 96.

Connecting a VCR and Cable

Use this hookup if:

- ❑ You have cable TV that does not require a cable box.

Disconnect all power sources before making any connections.

- 1 Connect the cable TV cable to the VCR's IN jack.
- 2 Using a coaxial cable, connect the VCR's OUT jack to the LCD projection TV's CABLE jack.
- 3 Using AUDIO and S VIDEO cables, connect the VCR's Audio and S Video OUT jacks to the LCD projection TV's AUDIO and S VIDEO IN jacks.

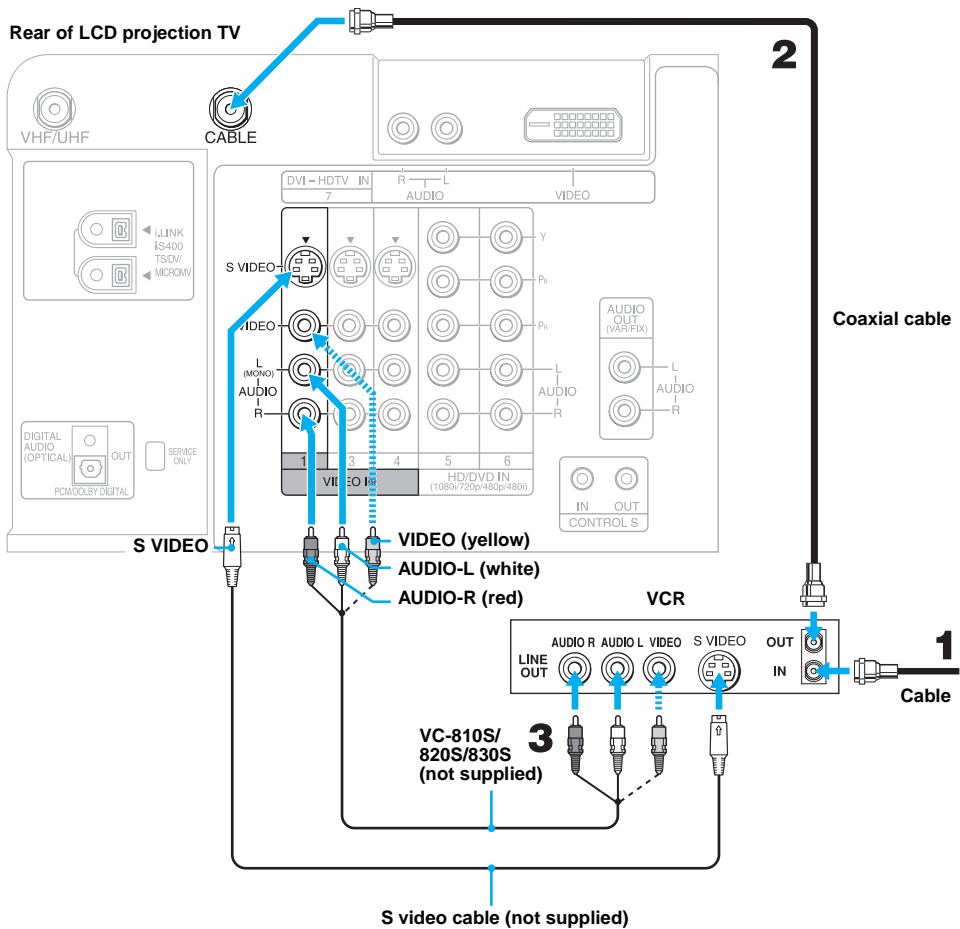

⚠ If your VCR is not equipped with S VIDEO, use a VIDEO cable (yellow) instead of the S VIDEO cable.

Connecting a VCR and Cable Box

Use this hookup if:

- ❑ Your cable TV company scrambles some channels, but not all of them (pay channels vs. regular cable channels) and you need to use a cable box, and
- ❑ You want to enjoy the Twin View feature.

With this setup you can:

- ❑ Use the LCD projection TV remote control to change channels on your cable box when the signal is scrambled. To program your Sony remote control to operate your cable box, see “Programming the Remote Control” on page 48.
- ❑ Use the LCD projection TV remote control to change channels using your LCD projection TV when the signal is not scrambled. Your LCD projection TV’s tuner provides a better signal than the cable box.
- ❑ Use the Twin View feature. (When all channels are routed through your cable box, only one signal is sent to the LCD projection TV, so you cannot use the Twin View feature.)

Disconnect all power sources before making any connections.

- 1 Connect the CATV cable to the single (input) jack of the splitter.
- 2 Use a coaxial cable to connect one of the splitter’s two output jacks to the TV’s CABLE jack.
- 3 Use a coaxial cable to connect the splitter’s other output jack to the cable box’s input jack.
- 4 Use a coaxial cable to connect the cable box’s output jack to the VCR’s RF input jack.
- 5 Use an A/V cable to connect the VCR’s A/V output jacks to the LCD projection TV’s A/V input jacks.
- 6 Use a coaxial cable to connect the VCR’s RF output jack to the LCD projection TV’s VHF/UHF jack.
- 7 Run the Auto Setup program, as described in “Setting Up the LCD Projection TV Automatically” on page 45.

 To view scrambled channels, set your LCD projection TV to channel 3 or 4 (depending on your cable box output). Change channels using your cable box.

(Continued)

If you are connecting a digital cable box, you will need a special bi-directional splitter designed to work with your cable box.

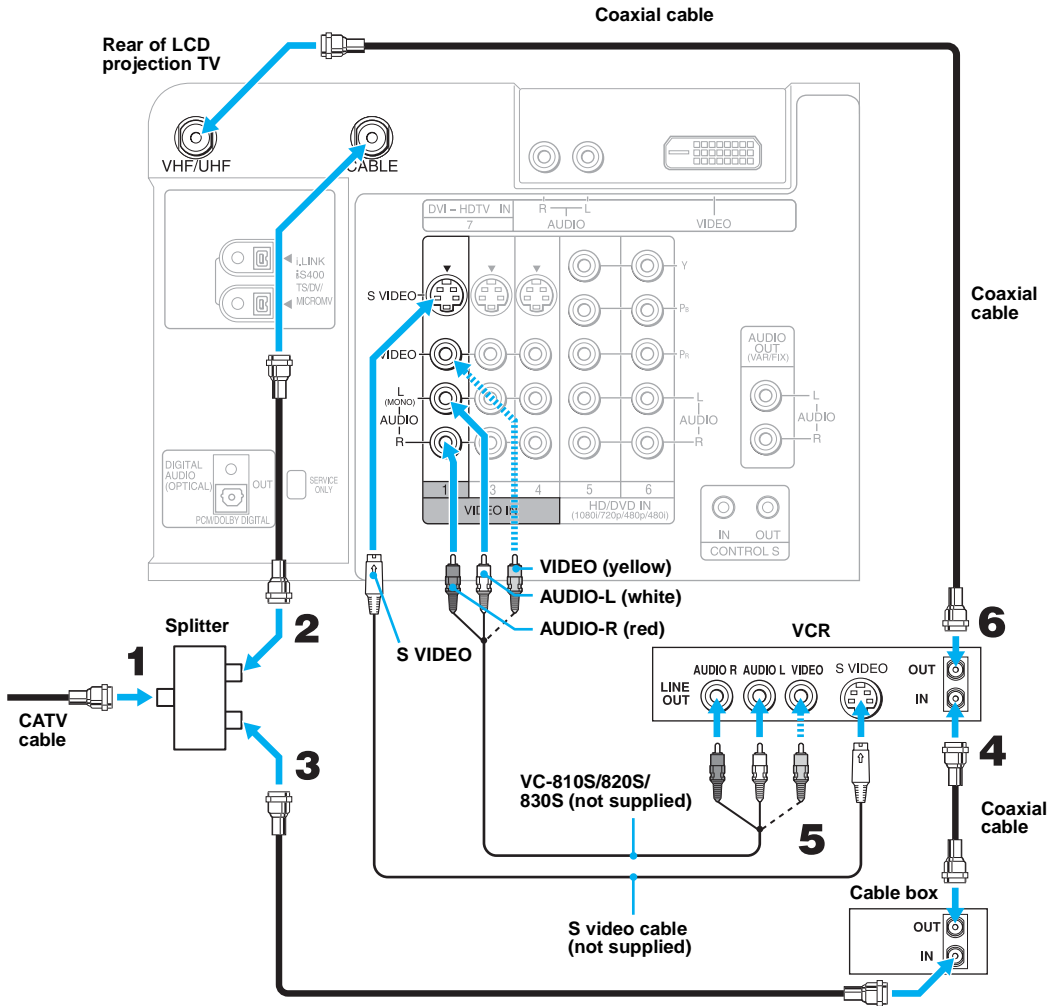

- ✎ If your VCR is not equipped with S VIDEO, use a VIDEO cable (yellow) instead of the S VIDEO cable.
- ✎ You will not be able to change channels on the VCR. Set your LCD projection TV and VCR to channel 3 or 4, depending on your cable box channel output.
- ✎ Pressing ANT on the remote control switches between the channels coming in through the cable box (scrambled) and those coming directly to the LCD projection TV (unscrambled).

Connecting Two VCRs for Tape Editing

If you connect two VCRs, you can record from one VCR to the other while using your LCD projection TV to monitor what is being recorded.

Disconnect all power sources before making any connections.

- 1 Using AUDIO and VIDEO cables, connect the playback VCR's Audio and Video OUT jacks to the recording VCR's Audio and Video IN jacks.
- 2 Using AUDIO and VIDEO cables, connect the recording VCR's Audio and Video OUT jacks to the LCD projection TV's AUDIO and VIDEO IN jacks.

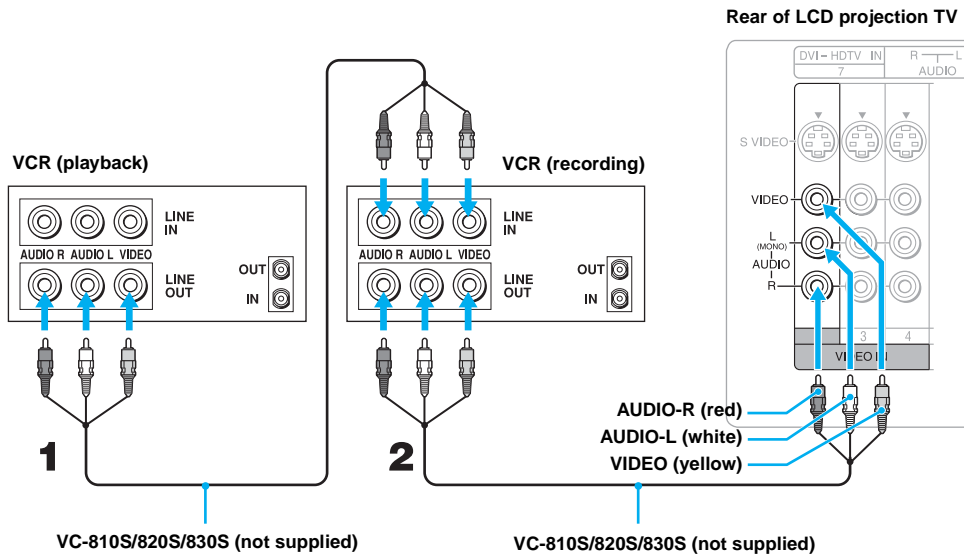

- To perform tape editing, set the LCD projection TV to the video input intended for playback by pressing TV/VIDEO on the remote control.
- You may need to change the video input on your VCR. Consult your VCR's operating manual for instructions.
- If your VCRs have an S VIDEO jack: For best picture quality, use an S VIDEO connection instead of the yellow video cable on your combined A/V cable. Using an S VIDEO cable, connect the playback VCR's S VIDEO OUT jack to the recording VCR's S VIDEO IN jack. S VIDEO does not provide audio, so audio cables must be connected to provide sound.
- You cannot record signals from equipment connected to the Y, P_B, P_R input.

Connecting a Satellite Receiver

Disconnect all power sources before making any connections.

- 1 Connect the satellite antenna cable to the satellite receiver's SATELLITE IN jack.
- 2 Using AUDIO and S VIDEO cables, connect the satellite receiver's AUDIO and S VIDEO OUT jacks to the LCD projection TV's AUDIO and S VIDEO IN jacks.
- 3 Connect a coaxial cable from your cable or antenna to the LCD projection TV's VHF/UHF or CABLE jack.

 If your satellite receiver is not equipped with S VIDEO, use a VIDEO cable (yellow) instead of the S VIDEO cable.

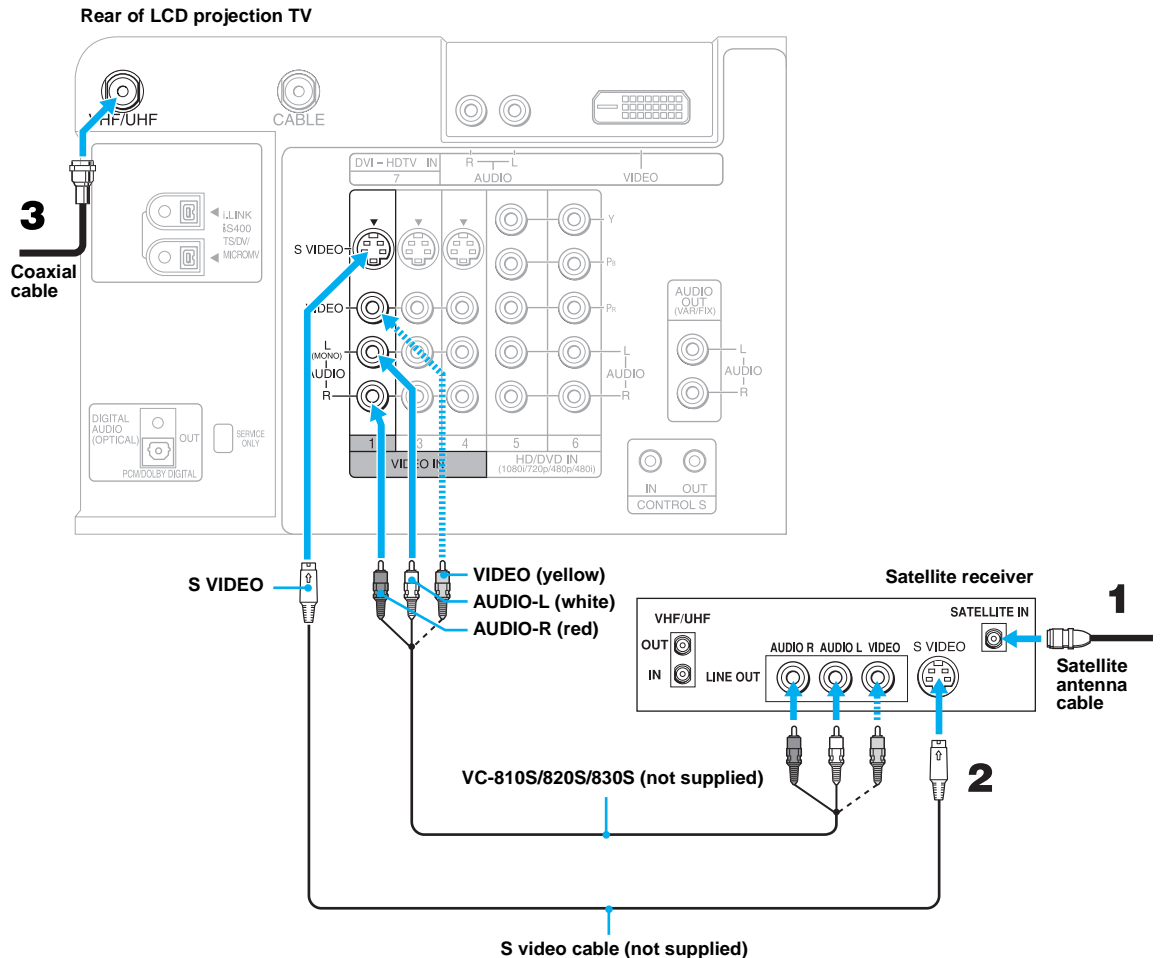

Connecting a Satellite Receiver with a VCR

Disconnect all power sources before making any connections.

- 1 Connect the satellite antenna cable to the satellite receiver's SATELLITE IN jack.
- 2 Connect the CATV cable to the VCR's VHF/UHF IN jack.
- 3 Using a coaxial cable, connect the VCR's VHF/UHF OUT jack to the LCD projection TV's CABLE jack.
- 4 Using AUDIO and S VIDEO cables, connect the satellite receiver's AUDIO and S VIDEO OUT jacks to the VCR's AUDIO and S VIDEO IN jacks.
- 5 Using AUDIO and S VIDEO cables, connect the VCR's AUDIO and S VIDEO OUT jacks to the LCD projection TV's AUDIO and S VIDEO IN jacks.

Rear of LCD projection TV

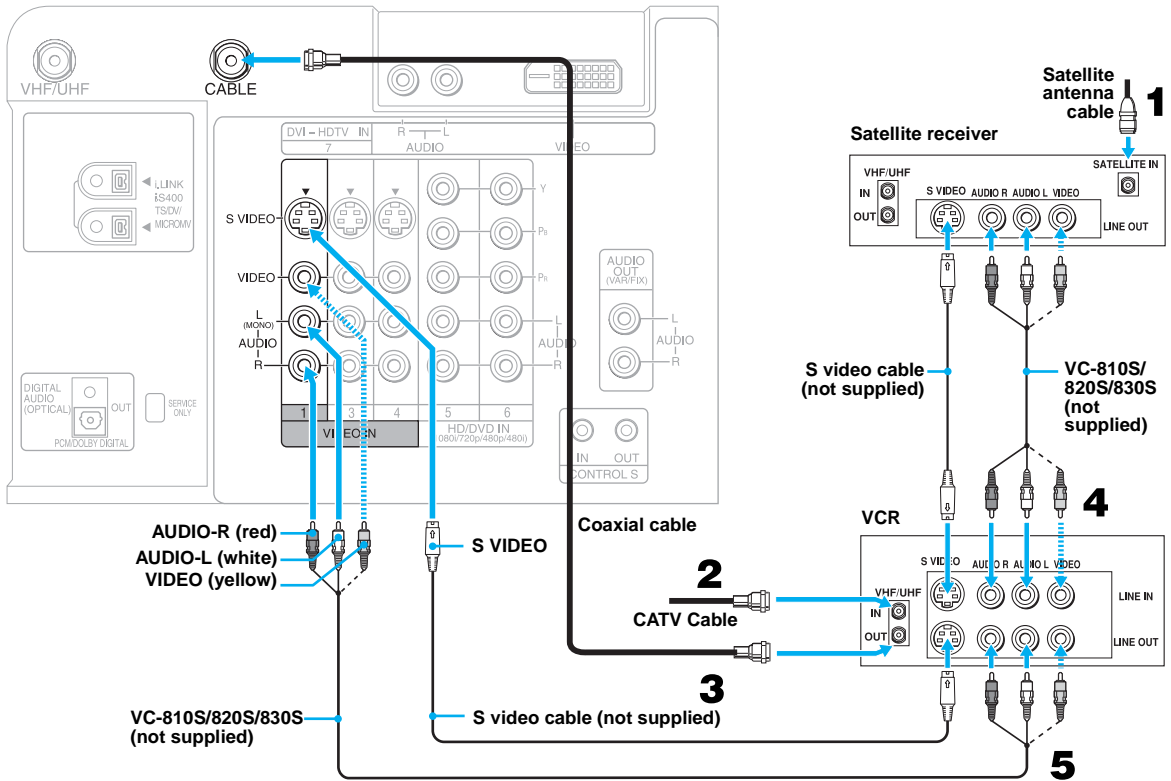

(Continued)

- ✎ Be sure your VCR's video input is set correctly. Consult your VCR's operating manual for instructions.
- ✎ Use TV/VIDEO to select
 - VIDEO 1 to watch satellite TV or the VCR (your VCR must be turned on).
 - VHF/UHF to watch cable TV.
- ✎ If your VCR or satellite receiver is not equipped with S VIDEO, use a VIDEO cable (yellow) instead of the S VIDEO cable.

Connecting an Audio Receiver

Disconnect all power sources before making any connections.

Using audio cables, connect the LCD projection TV's AUDIO OUT (VAR/FIX) jacks to the audio receiver's audio LINE IN jacks.

Rear of LCD projection TV

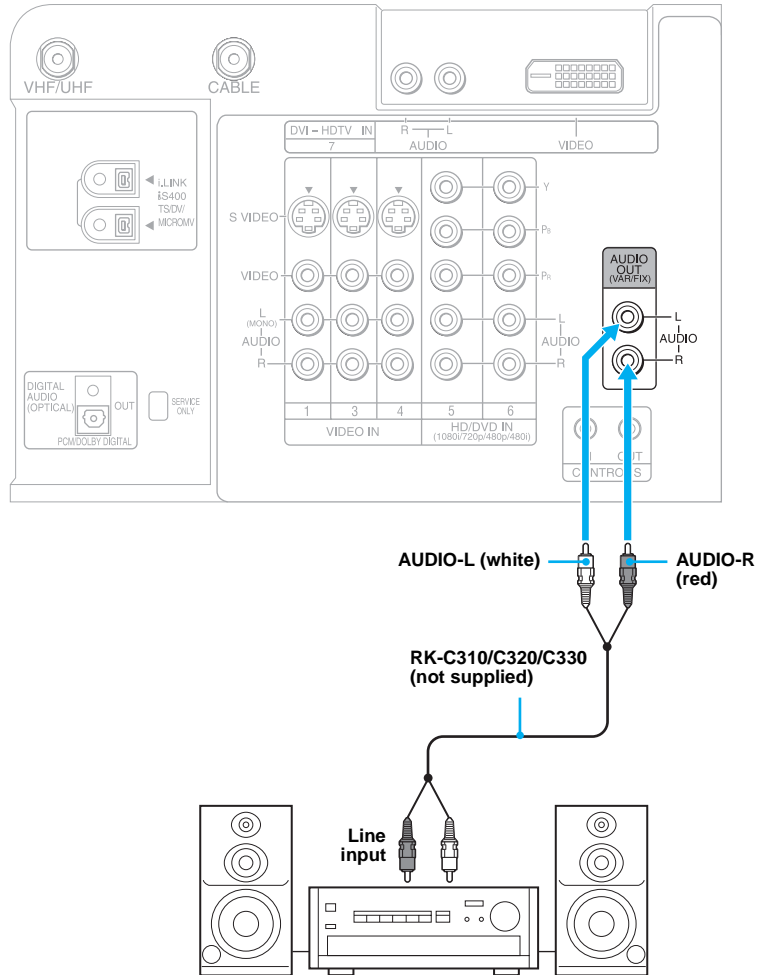

Connecting a DVD Player with Component Video Connectors

This is the preferred hookup to use if:

- ❑ Your DVD player has component (Y, B-Y, R-Y) jacks.

Disconnect all power sources before making any connections.

- 1 Using three separate component video cables, connect the DVD player's Y, B-Y and R-Y jacks to the Y, PB and PR jacks on the LCD projection TV. Use the HD/DVD IN 5 or 6 connections.

 The Y, B-Y and R-Y jacks on your DVD player are sometimes labeled Y, C_B and C_R, or Y, P_B and P_R. If so, connect the cables to like colors.

- 2 Using an audio cable, connect the DVD player's Audio OUT jacks to the LCD projection TV's AUDIO IN jacks. Be sure to use the same row of inputs that you used for the video connection (HD/DVD IN 5 or 6).

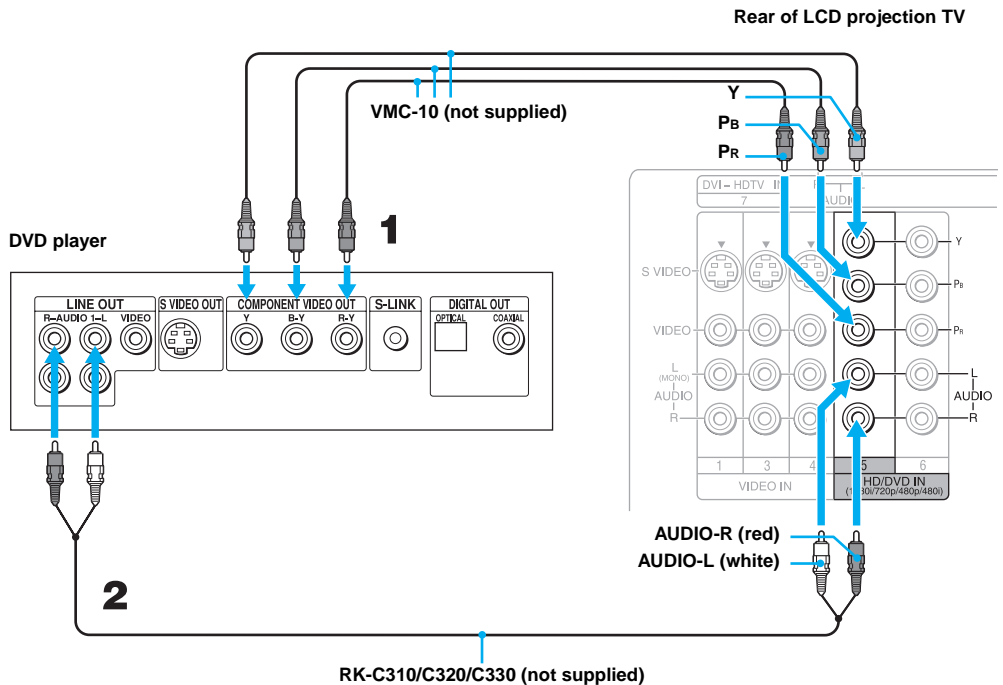

 To take advantage of the Wide Screen modes, set the TV's aspect ratio to 16:9 on your DVD player. For details, refer to the operating instructions supplied with your DVD player.

Connecting a DVD Player with A/V Connectors

Use this hookup if:

- Your DVD player does not have component (Y, PB, PR) jacks.

✎ If your DVD player has video component output connectors: for best picture quality use the connection described on page 40.

Disconnect all power sources before making any connections.

- 1 Using audio cables, connect the DVD player's Audio OUT jacks to the LCD projection TV's AUDIO IN jacks.
- 2 Using an S VIDEO cable, connect the DVD player's S VIDEO jack to the LCD projection TV's S VIDEO jack.

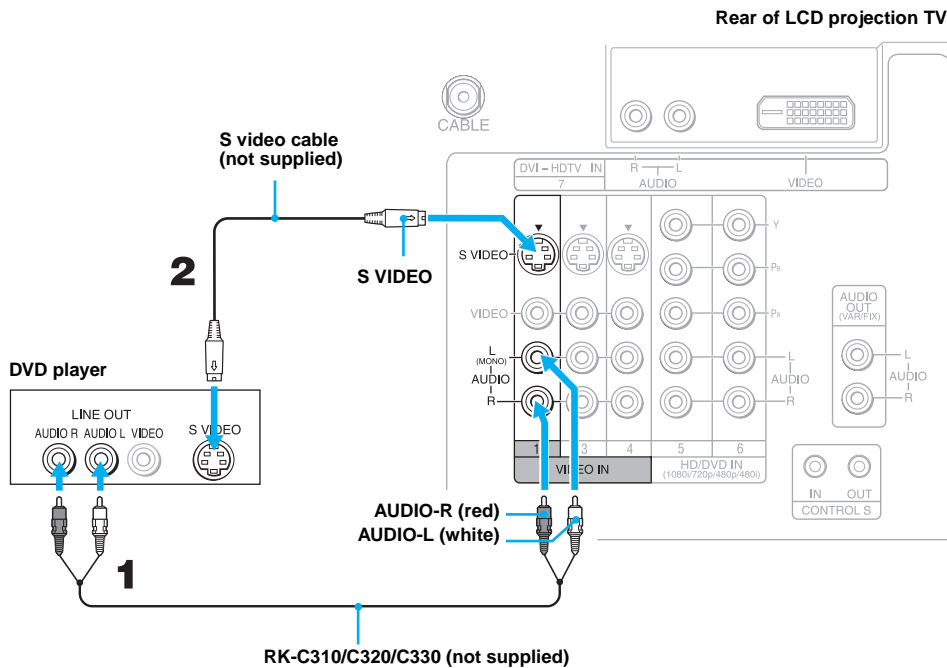

✎ To take advantage of the Wide Screen modes, set the TV's aspect ratio to 16:9 on your DVD player. For details, refer to the operating instructions supplied with your DVD player.

✎ Use TV/VIDEO on the remote control to switch between the VCR, DVD player and cable TV inputs.

✎ If your VCR is not equipped with S VIDEO, use a VIDEO cable (yellow) instead of the S VIDEO cable.

Connecting a Camcorder

For easy connection of the camcorder, the LCD projection TV has front Audio and Video inputs (shown below). However, if you prefer, you can also connect the camcorder to the LCD projection TV's rear AUDIO and VIDEO IN jacks.

Using AUDIO and S VIDEO cables, connect the camcorder's Audio and S VIDEO OUT jacks to the LCD projection TV's AUDIO and S VIDEO IN jacks.

- ✎ If you have a mono camcorder, connect its left audio output to the LCD projection TV's AUDIO L (MONO) jack.
- ✎ If your camcorder is not equipped with S VIDEO, use a VIDEO cable (yellow) instead of the S VIDEO cable.

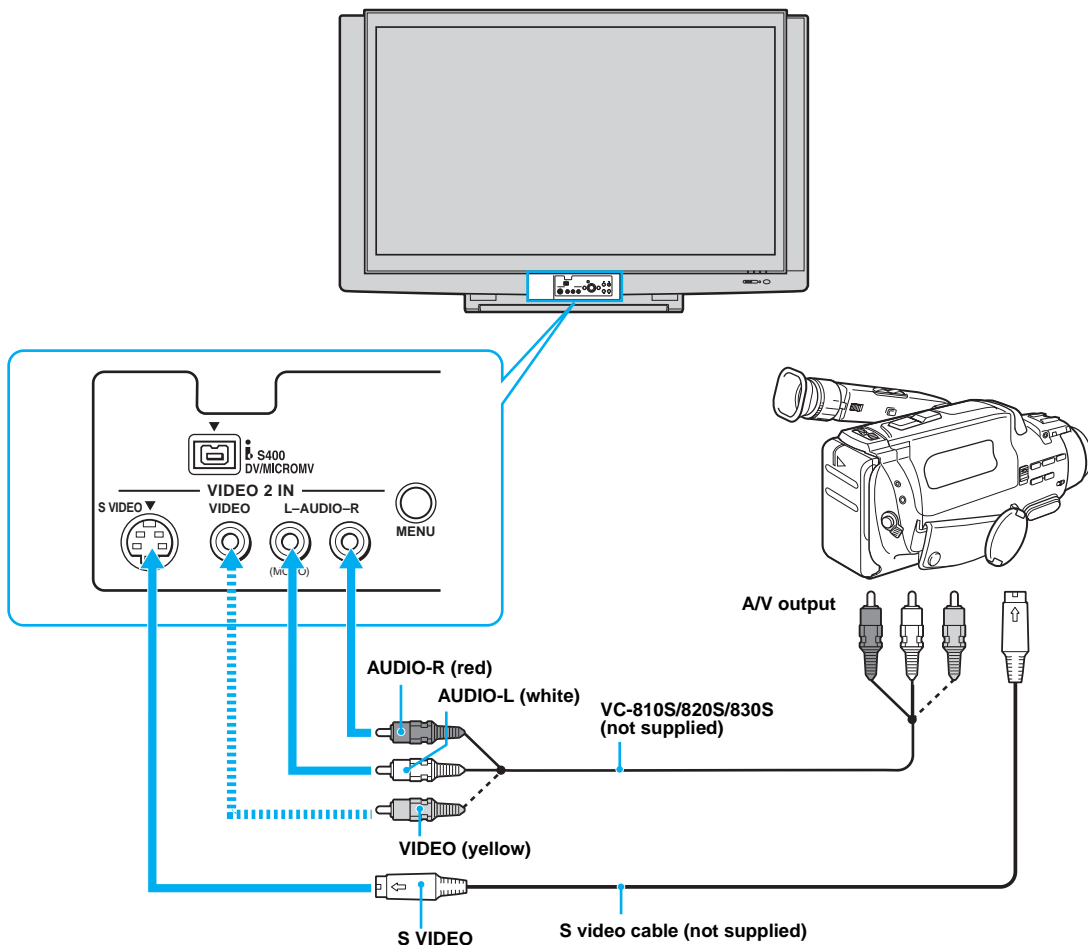

Connecting a Device with an Optical IN Connector

You can use the LCD Projection TV's DIGITAL AUDIO (OPTICAL) OUT jack to connect a digital audio device that is PCM/Dolby digital compatible, such as an audio amplifier.

Using an optical cable, connect the device's OPTICAL IN jack to the LCD Projection TV's DIGITAL AUDIO (OPTICAL) OUT jack.

Rear of LCD projection TV

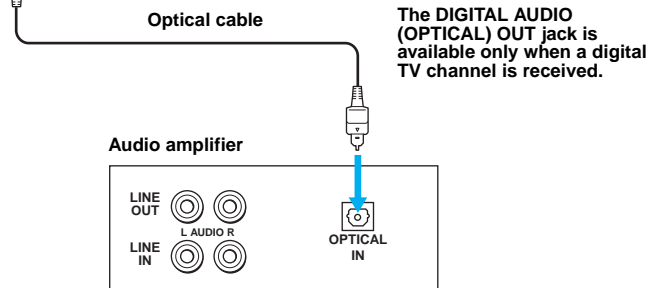
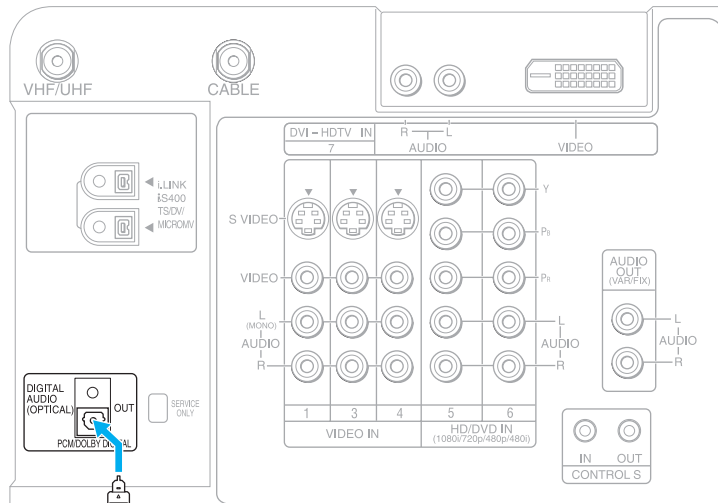

Using the CONTROL S Feature

CONTROL S allows you to control your LCD projection TV system and other Sony equipment with one remote control. In addition to allowing you to control multiple devices with one remote control, the CONTROL S feature allows you to always point your remote control at your LCD projection TV, instead of having to point it at the other equipment, which might be hidden or out of direct line of sight.

Rear of LCD projection TV

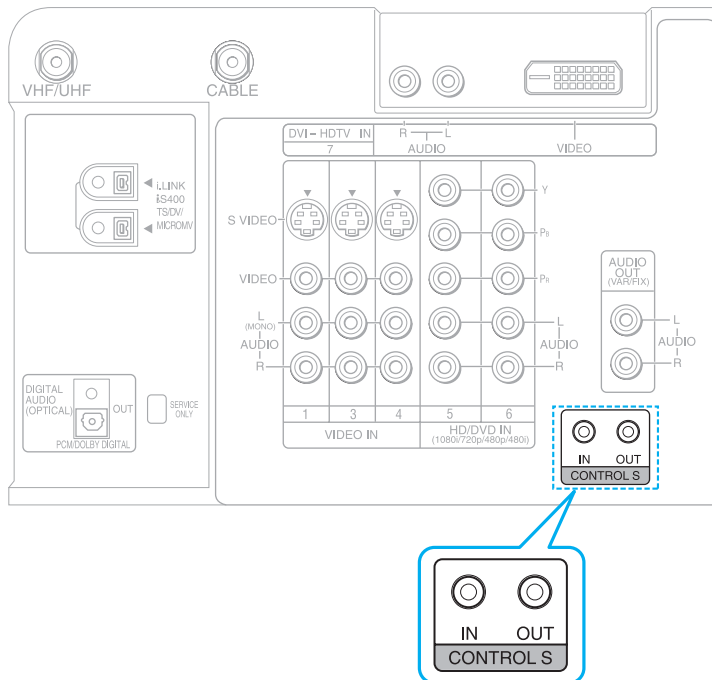



Setting Up the LCD Projection TV Automatically

After you finish connecting your LCD projection TV, you need to run Auto Setup to set up available analog and digital channels. The Auto Program screen appears when you turn your LCD projection TV on for the first time after installing it. If you do not want to set up the channels at this time, you can do it later by using the Auto Program feature in the Channel menu (see page 96).

 The Auto Setup feature does not apply for installations that use a cable box for all channel selection.

Using Auto Setup

- 1 Press **POWER** on the front panel of your LCD projection TV to turn on the LCD projection TV.
The Initial Setup screen appears.
- 2 Move the arrow button up or down to select the desired on-screen display language, and press the  button.
“Start auto program now?” appears.
- 3 Move the arrow button up or down to select “Yes,” and press the  button.
Auto Program automatically creates a list of receivable channels.

 Auto Program may take up to 30 minutes to complete. A progress bar is displayed while the channel list is being created.

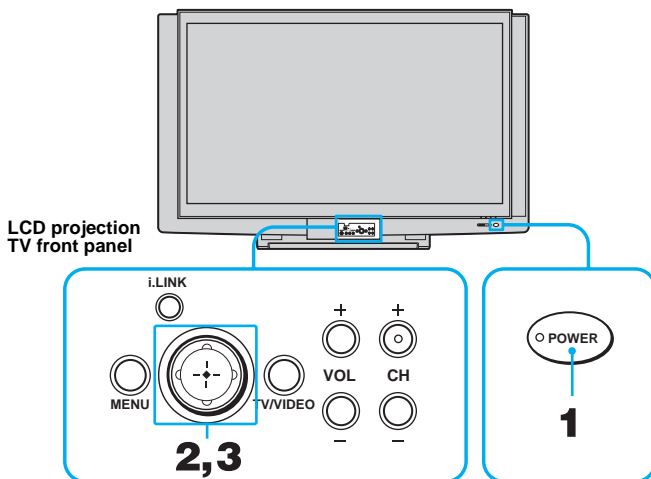

 You can run Auto Program by selecting it in the Channel menu, as described on page 96.









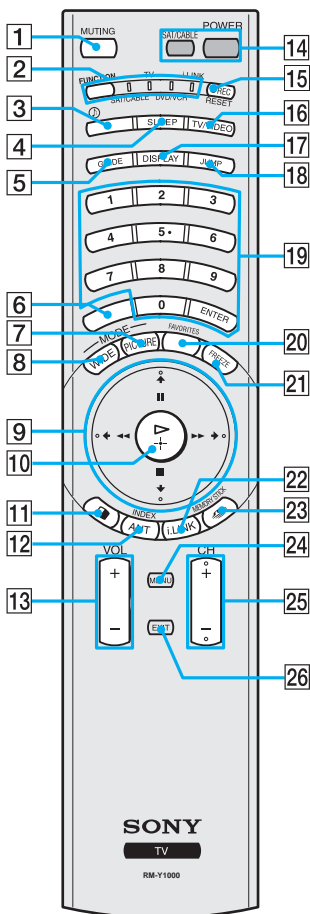

Using the Features



Using the Remote Control

The following table describes the buttons on the remote control that are for more advanced functions.

Button Descriptions



Button	Description
1 	MUTING Press to mute the sound. Press again or press VOL + to restore the sound.
2 	FUNCTION Press repeatedly until the indicator of the equipment (TV, SAT/CABLE, DVD/VCR, i.LINK) that you want to operate lights up.
3 	Press repeatedly to step through the available audio effect modes: Virtual Dolby, TruSurround, Simulated, Off. For details, see “Selecting Audio Options” on page 92.
4 	SLEEP Press repeatedly until the TV displays the time in minutes (15, 30, 45, 60 or 90) that you want the LCD projection TV to remain on before shutting off. To cancel Sleep Timer, press SLEEP repeatedly until SLEEP OFF appears.
5 	GUIDE Press to display the digital program guide. If FUNCTION is switched on SAT/CABLE Press to display the program guide of your satellite program provider.
6 	Use with 0-9 and ENTER buttons to select digital channels (for example, 2.1). For details on selecting digital channels, see page 60.
7 	PICTURE Press repeatedly to step through the available video picture modes: Vivid , Standard , Pro . Also available in the Video menu. For details, see “Selecting Video Options” on page 88.
8 	WIDE Press to step through the wide screen modes: Wide Zoom , Normal , Full and Zoom . For details, see “Using Wide Screen Mode” on page 59.
9 	When the menu is displayed, move the on-screen cursor. : Pause ■ : Stop ◀◀ : Rewind ▶▶ : Fast-Forward
10 	▷ : Playback -◁ : When the menu is displayed, select the item.
11 	Turns on/off Twin View. For details, see “Using Twin View™” on page 55.

Button	Description
12 ANT	Changes between the VHF/UHF input and the CABLE input. If FUNCTION is switched on SAT/CABLE
INDEX	Displays index of your satellite program provider.
13 VOL +/-	Adjusts the volume.
14 POWER buttons (Green)	Turn on and off the LCD projection TV and other audio/video equipment you have programmed into the remote control. For instructions, see “Programming the Remote Control” on page 48.
15 REC	Record
RESET	Press when in a menu to reset the settings to the factory defaults.
16 TV/VIDEO	Cycles through the video equipment connected to your LCD projection TV’s video inputs: TV , VIDEO 1 , VIDEO 2 , VIDEO 3 , VIDEO 4 , VIDEO 5 , VIDEO 6 and VIDEO 7 .
17 DISPLAY	Press once to display the current time and channel label (if set) and channel number. Press again to turn Display off. See page 104 for details on setting the time.
18 JUMP	Press to jump back and forth between two channels. The LCD projection TV alternates between the current channel and the last channel that was selected.
19 0 - 9 and ENTER	Press 0 - 9 to select a channel, the channel changes after 3 seconds. Press ENTER to select immediately.
20 FAVORITES	Displays the Favorite Channels list. For details, see “Using Favorite Channels” on page 54.
21 FREEZE	Freezes the window picture. Press again to restore the picture.
22 i.LINK	Press to display the i.LINK Control Panel. For information on using the i.LINK Control Panel, see page 83.
23  MEMORY STICK	Press to display the Memory Stick Menu. For details, see “Using the Memory Stick Viewer” on page 64.
24 MENU	Press to display the LCD projection TV on-screen menu. Press again to exit from the menu.
25 CH +/-	Scan through channels.  To scan rapidly through the channels, press and hold down CH+ or CH- .
26 EXIT	Press to exit the on-screen menu or display and return to normal viewing.

Programming the Remote Control

The remote control is preset to operate Sony brand video equipment.

Function	Equipment	Programmable Code Number
DVD/VCR	Sony DVD player	751
SAT/CABLE	Sony DSS tuner	801
i.LINK	Sony DVD player (i.LINK)	901

If you have video equipment other than Sony brand that you want to control with the LCD projection TV's remote control, use the following procedure to program the remote control.

 The equipment must have infrared (IR) remote capability in order to be used with the remote control.

- 1 Turn to the list of "Manufacturer's Codes" on page 49, and find the three-digit code number for the manufacturer of your equipment. (If more than one code number is listed, use the number listed first.)
- 2 Press **FUNCTION** repeatedly until the DVD/VCR, SAT/CABLE or i.LINK indicator lights up.
- 3 Press **SAT/CABLE** for five seconds until the indicator of the selected input flashes.
- 4 While the desired indicator is flashing, enter the three-digit manufacturer's code number.
- 5 Press **ENTER**.

 You must do step 5 within 10 seconds of step 4, or you must redo steps 4 through 5.

- 6 To check if the code number works, aim the LCD projection TV's remote control at the equipment and press **POWER** that corresponds with that equipment. If it responds, you are done. If not, try using another code listed for that manufacturer.

Notes

- If more than one code number is listed, try entering them one by one until you come to the correct code for your equipment.
- If you enter a new code number, the code number you previously entered at that setting is erased.
- In some cases, you may not be able to operate your equipment with the supplied remote control. In such cases, use the equipment's own remote control unit.
- Whenever you remove the batteries to replace them, the code numbers may revert to the factory setting and must be reset.

Manufacturer's Codes**VCRs**

Manufacturer	Code
Sony	301, 302, 303
Admiral (M. Ward)	327
Aiwa	338, 344
Audio Dynamic	314, 337
Broksonic	319, 317
Canon	309, 308
Citizen	332
Craig	302, 332
Criterion	315
Curtis Mathes	304, 338, 309
Daewoo	341, 312, 309
DBX	314, 336, 337
Dimensia	304
Emerson	319, 320, 316, 317, 318, 341
Fisher	330, 335
Funai	338
General Electric	329, 304, 309
Go Video	322, 339, 340
Goldstar	332
Hitachi	306, 304, 305, 338
Instant Replay	309, 308
JC Penney	309, 305, 304, 330, 314, 336, 337
JVC	314, 336, 337, 345, 346, 347
Kenwood	314, 336, 332, 337
LG	332
LXI (Sears)	332, 305, 330, 335, 338
Magnavox	308, 309, 310
Marantz	314, 336, 337
Marta	332
Memorex	309, 335
Minolta	305, 304
Mitsubishi/ MGA	323, 324, 325, 326
Multitech	325, 338, 321
NEC	314, 336, 337
Olympic	309, 308
Optimus	327
Orion	317

Manufacturer	Code
Panasonic	308, 309, 306, 307
Pentax	305, 304
Philco	308, 309
Philips	308, 309, 310
Pioneer	308
Quasar	308, 309, 306
RCA/ PROSCAN	304, 305, 308, 309, 311, 312, 313, 310, 329
Realistic	309, 330, 328, 335, 324, 338
Sansui	314
Samsung	322, 313, 321
Sanyo	330, 335
Scott	312, 313, 321, 335, 323, 324, 325, 326
Sharp	327, 328
Signature 2000 (M. Ward)	338, 327
SV2000	338
Sylvania	308, 309, 338, 310
Symphonic	338
Tashiro	332
Tatung	314, 336, 337
Teac	314, 336, 338, 337
Technics	309, 308
Toshiba	312, 311
Wards	327, 328, 335, 331, 332
Yamaha	314, 330, 336, 337
Zenith	331

Laserdisc Players

Manufacturer	Code
Sony	701
Panasonic	704, 710
Pioneer	702

DVD Players

Manufacturer	Code
Sony	751
Sony (i.LINK)	901
General Electric	755
Hitachi	758
JVC	756

Magnavox	757
Mitsubishi	761
Oritron	759
Panasonic	753
Philips	757
Pioneer	752
RCA/Proscan	755
Samsung	758
Toshiba	754
Zenith	760

Cable Boxes

Manufacturer	Code
Sony	230
Hamlin/Regal	222, 223, 224, 225, 226
Jerrold/G. I.	201, 202, 203, 204, 205, 206, 207, 208, 218
Oak	227, 228, 229
Panasonic	219, 220, 221
Pioneer	214, 215
Scientific Atlanta	209, 210, 211
Tocom	216, 217
Zenith	212, 213

Satellite Receivers







Manufacturer	Code
Sony	801
Dish Network	810
Echostar	810
General Electric	802
Hitachi	805
Hughes	804
Mitsubishi	809
Panasonic	803
RCA/ PROSCAN	802, 808
Toshiba	806, 807

Using Other Equipment with Your LCD Projection TV Remote Control





All Equipment

To Do This ...	Do This ...
Switch the LCD projection TV's input to the VCR, DVD player, or other connected equipment	Press TV/VIDEO repeatedly to cycle through the video equipment connected to the LCD projection TV's video inputs.
Set up the LCD projection TV remote control to operate non-Sony equipment	You must program the remote control the first time you use it. See "Programming the Remote Control" on page 48.

Operating a VCR

To Do This ...	Press
Activate the remote control to operate the VCR	FUNCTION repeatedly until the DVD/VCR indicator lights up.
Turn on/off	SAT/CABLE
Change channels	CH +/-
Record	● REC
Play	
Stop	
Fast forward	
Rewind the tape	
Pause	
Search the picture forward or backward	 or  during playback (release to resume normal playback)





Operating a Satellite Receiver

To Do This ...	Press
Activate the remote control to operate the satellite receiver	FUNCTION repeatedly until the SAT/CABLE indicator lights up.
Turn on/off	SAT/CABLE
Select a channel	0-9, ENTER
Change channels	CH +/-
Back to previous channel	JUMP
Display channel number	DISPLAY
Display SAT Index	INDEX
Display SAT Guide	GUIDE
Display SAT Menu	MENU
Move highlight (cursor)	   
Select item	





Operating a Cable Box

To Do This ...	Press
Activate the remote control to operate the cable box	FUNCTION repeatedly until the SAT/CABLE indicator lights up.
Turn on/off	SAT/CABLE
Select a channel	0-9, ENTER
Change channels	CH +/-
Back to previous channel	JUMP

Operating a DVD Player

To Do This ...	Press
Activate the remote control to operate the DVD	FUNCTION repeatedly until the DVD/VCR indicator lights up.
Turn on/off	SAT/CABLE
Play	
Stop	
Pause	
Step through different tracks of the disc	 to step forward or  to step backward
Step through different chapters of a video disc	CH+ to step forward or CH- to step backward

Operating an MDP (Laserdisc Player)

To Do This ...	Press
Activate the remote control to operate the MDP	FUNCTION repeatedly until the indicator of the position you programmed for the MDP player lights up.
Turn on/off	SAT/CABLE
Play	
Stop	
Pause	
Search the picture forward or backward	 or  during playback (release to resume normal playback)
Search a chapter forward or backward	CH +/-

Watching the TV

Many TV features can be accessed directly through the remote control. The following will explain the function of some of the buttons found on your remote control.

Buttons for LCD Projection TV Operations

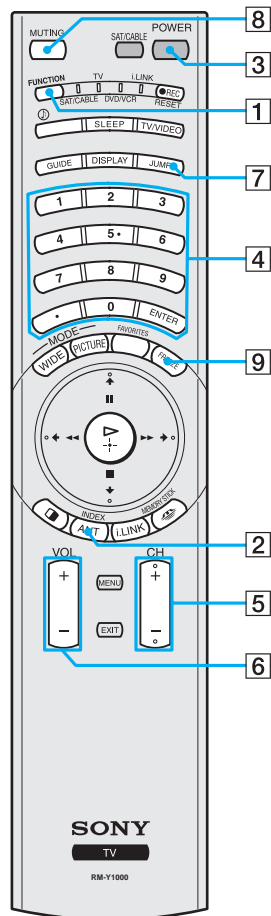

1 FUNCTION

Press until the TV indicator lights up. This activates the remote control for use with the LCD projection TV.

2 ANT

Press to change between the VHF/UHF input and the CABLE input.

3 POWER

Press to turn the LCD projection TV on and off. If a video input indication (e.g., VIDEO 1, VIDEO 2) appears on the screen, press **TV/VIDEO** or **CH +/-** until a channel number appears.

4 0-9, and ENTER

Use for direct channel selection. Press **0-9** to select an analog channel (for example, to select channel 10, press 1 and 0). The channel will change after 3 seconds, or you can press **ENTER** for immediate selection.

For digital subchannels, press **0-9**, , press **0-9** again, and then **ENTER**.

 You can also select digital channels using the digital program guide. See page 60 for details.

5 CH +/-

Press to scan through the channels (+ up or – down).

6 VOL +/-

Press to adjust the volume (+ up or – down).

7 JUMP

Press to jump back and forth between the current channel and the last channel selected.

8 MUTING

Press to mute the sound. “MUTING” will appear on the screen and will dim three seconds later. To restore the sound, press again or press **VOL +**.

9 FREEZE

This is useful when you need to copy down information that appears on the LCD projection TV’s screen (see “Using the Freeze Function” on page 58).

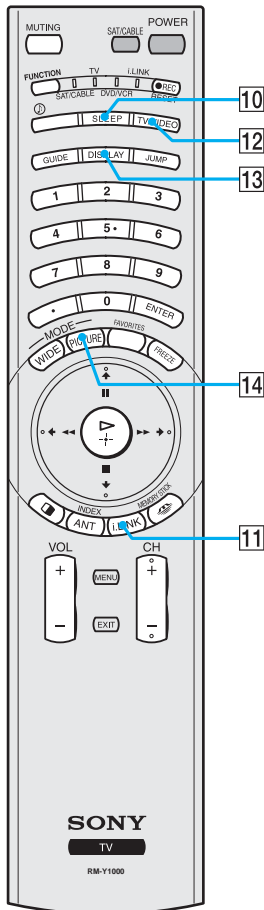

10 SLEEP

Press repeatedly to display the time in minutes (15, 30, 45, 60 or 90) that you want the LCD projection TV to remain on before shutting off.

To cancel Sleep Timer, press SLEEP repeatedly until SLEEP OFF appears.

11 i.LINK

Press to display a list of available i.LINK devices, and select the desired device from the list. See page 83 for details.

12 TV/VIDEO

Press repeatedly to scroll through available video inputs: TV, VIDEO 1, VIDEO 2, VIDEO 3, VIDEO 4, VIDEO 5, VIDEO 6 and VIDEO 7.

If you select **Skip** as a **Video Label** in the Setup menu, your LCD projection TV will skip the video input you selected (see “Video Label” on page 103).

13 DISPLAY

Press to display the channel number, current time and channel label (if set).

To turn the display off, press **DISPLAY** again.

14 PICTURE

Press **PICTURE** repeatedly to directly choose one of three different video modes that best suits the program you are watching.

Vivid: Select for enhanced picture contrast and sharpness.

Standard: Select to display a standard picture for home entertainment.

Pro: Select to display a picture with minimum enhancements.

When you select each mode, you can also adjust the picture quality (such as Picture, Brightness, Color, etc.) to suit your taste. For details, see “Mode” on page 88.

Using Favorite Channels

The Favorite Channel feature lets you select programs from a list of favorite channels that you preset.



Creating a List of Favorite Channels

- 1 Press **MENU** to display the Menu.
 - 2 Press **◀** or **▶** to highlight the Channel icon and press **⊙**.
 - 3 Press **⊙** to select Favorite Channels.
 - 4 Press **▲** or **▼** to highlight a Favorite Channel number (1-16) and press **⊙**.
 - 5 Press **▲** or **▼** to highlight a channel you want to assign to the Favorite Channel number. A preview of the highlighted channel appears in the upper right of the screen.
Press **⊙** to select that channel as a Favorite Channel.
 - 6 To add more channels to your favorites list, repeat steps 4-5.
To clear a Favorite Channel, press **▲** or **▼** to highlight the channel you want to clear. Press **⊙** and then press **RESET**.
 - 7 Press **MENU** to exit the Menu.
-  For details on using the Channel Menu, see page 96.

Displaying a List of Favorite Channels

- 1 Press **FAVORITES**.
The Favorite Channel options appear.



- 2 Press **▲** or **▼** to highlight the channel you want to watch. The program of that channel appears in the preview window. Press **⊙** to select.
-  When the remote control mode is set to other than TV function, you can display the Favorite Channels. However, you cannot select the channel by using **▲** or **▼**.
-  To assign Channel Labels (e.g., ABC, HBO, MTV, etc.) to channel numbers, as shown at right, use the Channel Label feature in the Channel Menu (see page 97).

Using Twin View™

Twin View enables you to watch two programs at the same time. You can also change the size of both the left and right pictures.



Activating Twin Pictures

To display twin pictures



- 1 Make sure your LCD projection TV is tuned to a working channel.
- 2 Press .



To cancel twin pictures

- Press  again (or press .

Activating the Picture

Although two pictures appear on the screen at the same time, only one picture is active. Change the picture size by using the  or  button. For an active picture, you can:

- Change channels.
- Adjust the volume.
- Switch the input sources from VHF/UHF to cable by pressing **ANT** or **TV/VIDEO** to switch the video input.

To activate the right picture

- Press .





To activate the left picture

- Press .

(Continued)

 Hookups that affect your ability to use Twin View:

- If you are viewing all channels through the cable box, the Twin View feature will not work. The cable box only unscrambles one signal at a time, so the right picture will be the same as the left picture.
- You can watch a scrambled cable channel and another video source. Be sure your DVD player, VCR or satellite receiver are connected to one of the VIDEO IN 1-7 and antenna inputs on the rear of the LCD projection TV. Digital TV pictures, and pictures from equipment connected to HD/DVD IN 5 and 6, and DVI-HDTV IN 7, will only appear in the left picture, not in the right.

 The active picture is indicated by the  icon.

Factors Affecting Twin View

- ❑ If you use a cable box to view all channels, the same channel appears in both windows because the cable box unscrambles only one channel at a time.
- ❑ If you use a cable box, you can view the cable box output in one window and view a different source (such as a VCR or DVD player) in the second window by using the **TV/VIDEO** button.
- ❑ Digital TV channels, as well as any sources connected to the VIDEO 5, VIDEO 6, and VIDEO 7 inputs display in the left window, but not the right.
- ❑ If you are viewing a 4:3 source and a 16:9 enhanced source (such as a DVD) side by side, the 4:3 source appears larger.
- ❑ Twin View does not display channels that are blocked by parental settings (see page 98).

Changing the Picture Size

The zoom feature lets you change the size of the left and right pictures.

To enlarge the left picture (reduce the right)

- 1 Press ◀ to activate the left picture (if not already activated).
- 2 Press ▲ to enlarge the picture and ▼ to reduce the picture.



To enlarge the right picture (reduce the left)

- 1 Press ▶ to activate the right picture (if not already activated).
- 2 Press ▲ to enlarge the picture and ▼ to reduce the picture.

🔍 When you adjust the twin screen sizes, the LCD projection TV memorizes the change. The next time you use the Twin View function, the memorized sizes appear.

Using the Freeze Function

The **FREEZE** button allows you to temporarily capture a program's picture. You can use this feature to write down information such as phone numbers, recipes, etc.

To use the Freeze function

- 1 When the program information you want to capture is displayed, press **FREEZE**.
- 2 The LCD projection TV switches to Twin View mode and displays the "frozen" picture on the right, while the current program continues on the left.

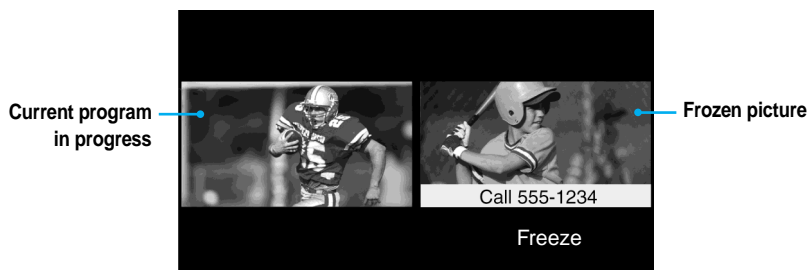

- 3 To cancel and return to normal viewing, press **FREEZE**.

 Freeze feature is not available if you are already in Favorite Channel (see page 54), or Twin View™ (see page 55) mode.

Using Wide Screen Mode

Wide Screen Mode lets you watch 4:3 normal broadcasts in several Wide Screen Modes (16:9 aspect ratio).

- Press **WIDE** repeatedly to toggle through the following Screen Mode settings.

 You can also access the Screen Mode settings in the Screen menu. For details, see page 94.



Wide Zoom



Normal



Full



Zoom

Wide Zoom enlarges the 4:3 picture to fill the 16:9 screen, keeping the original image as much as possible.

Normal returns the 4:3 picture to its original size.

Full Mode stretches the 4:3 picture horizontally only, to fill the 16:9 screen.

Zoom Mode enlarges the 4:3 picture horizontally and vertically to an equal aspect ratio that fills the 16:9 screen. Useful for watching Letterbox movies.

 When you change channels or inputs, the Screen Mode settings revert to Wide Zoom (or the 4:3 Default setting in the Screen menu). To retain the current Screen Mode setting as channels and inputs are changed, set 4:3 Default to Off. For details, see page 95.

Using the Digital Program Guide

Displaying the Digital Program Guide

This LCD projection TV is equipped to show digital programming, if a digital signal is present. The digital program guide and menus let you review program information, select digital channels and subchannels, set up your LCD projection TV's digital programming, and enable digital closed captioning.

 Analog channels are not available in this guide.

To display the digital program guide:

- 1 Tune your LCD projection TV to a digital channel by using the **0-9**, , and **ENTER** buttons.
- 2 Press **GUIDE** on the LCD projection TV's remote control. The digital program guide appears, with the currently selected program showing in the background.

 The digital program guide and menus are not available while using multipicture functions (Twin View, Freeze, i.LINK, Memory Stick, or Favorite Channels).

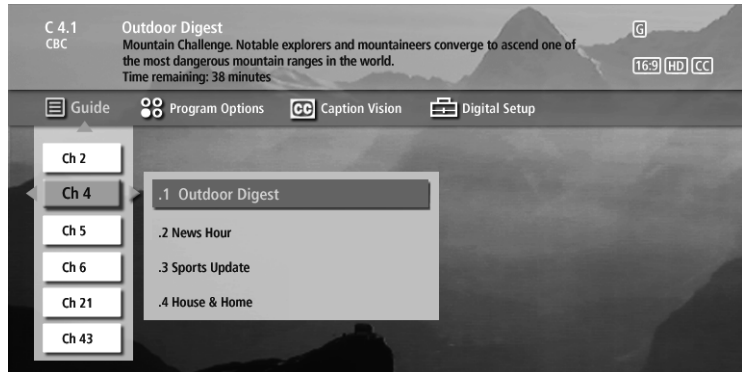

 Program information in the guide is provided by the broadcasters. As a result, it may sometimes include only the channel number, without a program title or description.

Navigating the Digital Program Menus

Four digital menus are available on the digital program guide.

Digital Program Menu	See Page
Using the Guide Menu	61
Using the Program Options Menu	61
Using the Caption Vision Menu	62
Using the Digital Setup Menu	62

To navigate to these menus and through the available options:

- 1 Press **▲ ▼ ◀ ▶** to navigate through the options.
- 2 Press **⊞** to select the desired option.

Using the Guide Menu

The Guide menu allows you to select digital channels and subchannels from a dropdown list. This list also provides information about the current program being shown on each digital channel.

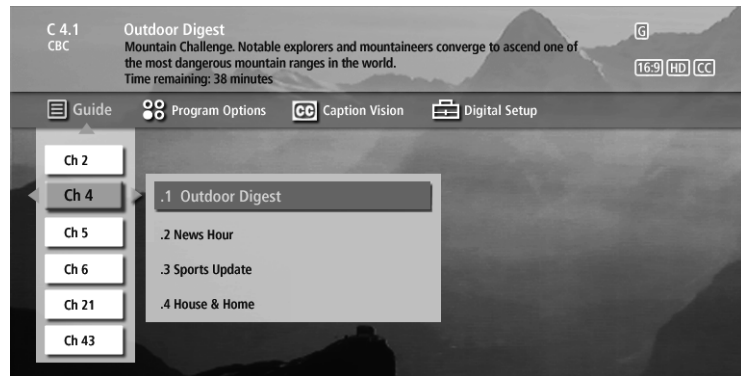

 Subchannels are additional channels of programming broadcast simultaneously. For example, channel 4 might include three subchannels (4.1, 4.2, 4.3) that are showing programs at the same time.

Using the Program Options Menu

The Program Options menu allows you to customize the settings of the program on the currently tuned channel.

Option	Description
Alternate Video	Each program has a main video stream, and may have alternate video streams. This option allows you to switch among these alternate video streams.
Alternate Audio	Each program has a main audio stream (the audio that you hear when the channel is first tuned). This option allows you to switch among these alternate audio streams (e.g., for different languages).

Using the Caption Vision Menu

The Caption Vision menu allows you to turn on/off digital closed captioning, and to modify how digital closed captioning is shown on your LCD projection TV. Depending on the program, digital closed captioning will be available in a number of different languages, aspect ratios, and reading levels.

- 1 Press **▲** or **▼** to select from the following six services. The service description, if available, applies to the currently tuned channel.

Option	Description
Off	Turns off closed captioning for digital programs
1 XXX YYY ZZZ	XXX = language (English, Spanish, French, etc.)
2 XXX YYY ZZZ	YYY = reader level (standard*, easy)
3 XXX YYY ZZZ	ZZZ = aspect ratio (4:3, 16:9)
4 XXX YYY ZZZ	* When set to this option, the option name is not shown
5 XXX YYY ZZZ	
6 XXX YYY ZZZ	

 The Caption Vision menu only affects digital channels. For closed captioning on analog channels, see “Using the Setup Menu” on page 102.

Using the Digital Setup Menu

 This option is the same as the “Digital Channels” option. See “Using the Channel Menu” on page 96.

The Digital Setup menu lets you change the way your digital channels are displayed.

The following digital setup functions are available:

Option	Description
Add Digital Channels	This option allows you to add new digital channels for the currently active antenna mode (Cable or VHF/UHF). This option is useful if the number of digital channels that your LCD projection TV is able to receive has recently been increased, but you do not want your LCD projection TV to perform a full Auto Setup.
Channel Show/Hide	This option allows you to remove (hide) digital channels from the Digital Program Guide’s list of channels and subchannels, as well as from channel surfing using CHANNEL +/- . Hidden channels can still be directly tuned using 0-9 and  .
Digital Signal Strength	Displays the current strength of the digital signal on VHF/UHF, to allow you to adjust your antenna for optimal reception. (Does not apply to digital cable channels.)
Digital Caption Setup	Allows you to customize digital closed captioning (see page 63 for details).

Customizing Caption Vision

You can use the Digital Caption Setup menu to customize your LCD projection TV's Caption Vision.

Select from the following options to change the visual characteristics of your LCD projection TV's digital closed captioning. A preview window displays a sample as you scroll through each option.

<i>Option</i>	<i>Description</i>
Character Size	Small, Standard*, Large
Character Style	Style 1-7 (Style 4*)
Character Color	None, Color 1-8 (White*)
Edge Type	None*, Raised, Depressed, Outline, Left Shadow, Right Shadow
Edge Color	Color 1-8 (Black*)
Background Color	None, Color 1-8 (Teal, Transparent*)
Window Color	None*, Color 1-8

* Indicates factory default setting

Using the Memory Stick Viewer

About Memory Stick



Memory Stick (sold separately) is a new, compact, portable, and versatile Integrated Circuit recording medium with a data capacity that exceeds that of a floppy disk. Memory Stick is specially designed for sharing digital data among Memory Stick compatible products such as digital cameras and digital video cameras. Because it is removable, Memory Stick can also be used for external data storage.

The Memory Stick Viewer on your LCD projection TV allows you to view files that are stored on Memory Stick media. You can view:

- ❑ Digital photos (JPEG files)
- ❑ Movies (MPEG1 files)

You can also play slide show background music using MP3 files stored on your Memory Stick.

For more information about handling Memory Stick media, see “Notes on Using Memory Stick Media” on page 78.

Features

With the Memory Stick Viewer, you can:

- ❑ View photo (JPEG) and movie (MPEG1) files in a thumbnail index or Slide Show
- ❑ Set customized Slide Show options, including transitions and background audio
- ❑ Pan, zoom, and rotate photos
- ❑ Lock (protect) or delete files on the Memory Stick

Memory Stick Compatibility

This television is compatible with the following Memory Stick media types:

- ❑ Memory Stick Media
- ❑ Memory Stick Duo Media
- ❑ Memory Stick Media with Memory Select Function
- ❑ Memory Stick PRO Media

About Memory Stick PRO Media

Memory Stick PRO media features vary by and are dependent upon the design of host hardware devices. Memory Stick Pro in this LCD projection TV has been tested to support up to 1 GB media capacity and does not support high-speed transfer, MagicGate copyright protection technology, or access control security features.

File Compatibility

The Memory Stick Viewer is compatible with JPEG images taken with Sony digital still cameras and MPEG1^{*} movies taken with Sony digital cameras and camcorders. In order to be viewable in the Memory Stick Viewer, the files must have the following file name extensions:

<i>File Type</i>	<i>Supported File Name Extensions</i>
JPEG	.jpg .jpeg
MPEG1	.mpg .mpeg

Trademark Information

Memory Stick, Memory Stick PRO, and MagicGate are trademarks of Sony Corporation.

* Some variations of MPEG1 movies may not play back correctly.

Inserting and Removing a Memory Stick

If you are using a Memory Stick Duo, see “Inserting the Memory Stick Duo” on page 67.

Inserting a Memory Stick

- 1 Locate the Memory Stick slot and insert the Memory Stick into the Memory Stick slot as illustrated below. When inserted properly, it should slide in with little resistance and click into place.

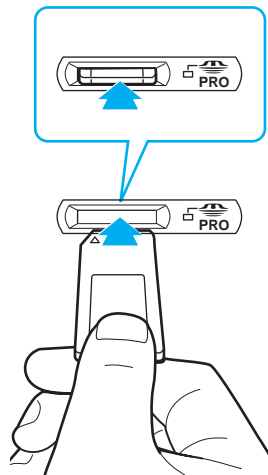

- ⚠ Be sure to insert the Memory Stick in the correct direction. If the Memory Stick is forced in the wrong way, it may become damaged.
- ⚠ Insert only Memory Stick media into the Memory Stick slot. Attempting to insert other objects into the slot may damage the LCD projection TV.

To remove the Memory Stick, see “Removing a Memory Stick” on page 68.

Inserting the Memory Stick Duo

Memory Stick Duo is a new, compact version of the standard-sized Memory Stick recording medium.

 **CAUTION:** Inserting the Memory Stick Duo incorrectly may result in permanent damage to the Memory Stick Duo and the LCD projection TV.

- 1 Before inserting a Memory Stick Duo into the LCD projection TV's Memory Stick slot, you must first insert the Memory Stick Duo into an adapter (sold separately).

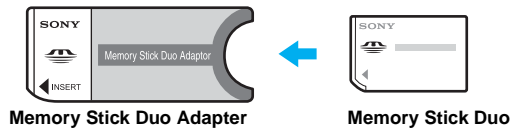

 **CAUTION:** Inserting the Memory Stick Duo into the Memory Stick slot without the adapter may result in permanent damage to the Memory Stick Duo and the LCD projection TV.

- 2 Insert the Memory Stick Duo and adapter as shown below.

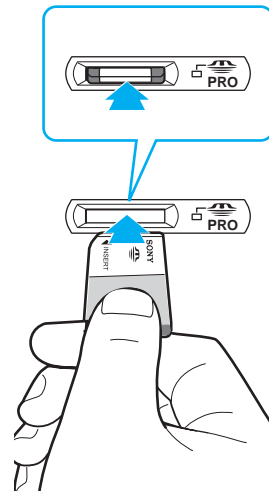

 **CAUTION:** Inserting the Memory Stick adapter backwards or upside down may result in permanent damage to the Memory Stick adapter and the LCD projection TV.

To remove the Memory Stick Duo, see “Removing a Memory Stick” on page 68.

Removing a Memory Stick

- 1 Check that the Memory Stick indicator is off. (When the light is on, this indicates that the LCD projection TV is reading data from the Memory Stick.)

 Removing the Memory Stick while a file is being accessed (when the Memory Stick indicator on the LCD projection TV's front panel is lit) may damage the Memory Stick or its contents.

- 2 Push the Memory Stick gently into the slot, and then release it. The Memory Stick media is ejected.

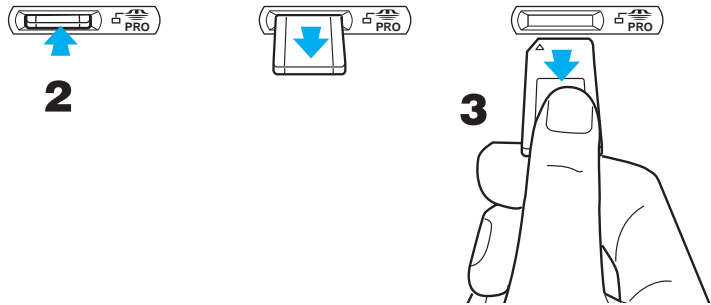



 When removing the Memory Stick, do not attempt to just pull it from its slot. Follow steps 1-3 (right).

- 3 Pull the Memory Stick completely out of the slot.

 To protect small children from injury from Memory Stick Media, remove all Memory Stick media from the LCD projection TV's Memory Stick slot and store it in a safe location when it is not in use.

Using the Memory Stick Index



Turn on the LCD projection TV and insert a Memory Stick that contains the photo or movie files you want to view. For how to insert a Memory Stick, see page 66.

 If the Memory Stick Index does not appear, press the MEMORY STICK  button on the remote control.

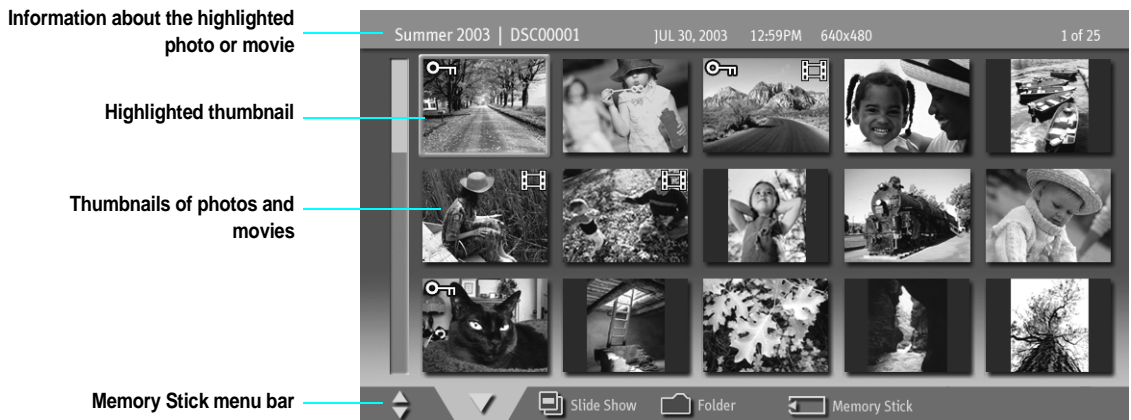
The Memory Stick Index appears, which displays thumbnail images of the files stored on the Memory Stick.



About the Lock and Movie Icons on the Thumbnail Images

-  Indicates the thumbnail is a movie (MPEG1) file instead of a photo (JPEG) file.
-  Indicates the thumbnail is locked. Locked files cannot be changed or deleted. For details, see “Protect” on page 77.

Using the Memory Stick Index

The following describes how to use the Memory Stick Index.

To Do This ...	Do This ...
Move the highlight to a photo or movie (🖼️) thumbnail	Press ↑ ↓ ← → .
Display the highlighted photo or movie file full screen	Press ⏏ . For details, see “Viewing Photos” on page 71 and “Playing Movies” on page 74.
Display the next page of thumbnails	<ol style="list-style-type: none">1 Press ↓ to select ▼.2 Press ↓ to display the next page of thumbnails.
Display the previous or next page of thumbnails	<ol style="list-style-type: none">1 Press ↓ to select ▼.2 Press ← to select ◀.3 To go to the previous page, press ↑. To go to the next page, press ↓.
Use the Memory Stick menu bar to access additional options	<ol style="list-style-type: none">1 Press ↓ to select ▼.2 Press ← or → to select Slide Show, Folder, or Memory Stick.3 Press ↑ or ↓ to select the option you want to change. <p>For details on these options, see “Memory Stick Index Menu Bar Options” on page 76.</p>
Move the highlight from the Memory Stick menu bar back to the thumbnails	<ol style="list-style-type: none">1 Press ← or → to select ▼.2 Press ↑ to return to the currently displayed thumbnails, or ↓ to display the next page of thumbnails.
Exit Memory Stick Viewer	Press MEMORY STICK  on the remote control.

Viewing Photos

When you select a photo from the Memory Stick Index (described on page 69), it displays as shown below, with the following controls.



JPEGs captured using a digital video camera may appear to display motion in full screen. This is a result of the way digital video cameras record still images, and is not a result of a malfunction with the LCD projection TV.

Using the Memory Stick Viewer

Photo Controls

When the menu is hidden, press ◀ or ▶ to go to the previous or next photo.

To Do This ...	Do This ...
Display the next or previous file on the Memory Stick	Press ▲ or ▼ to highlight the ◀ ▶ (Previous/Next) button. Then press ◀ to go to the previous file, or ▶ to go to the next file.
Hide the Photo menu bar, displaying only the photo	With the highlight in the Photo menu bar, press ▼.
Display the hidden Photo menu bar	Press ▲.
Display the Memory Stick Index again	Press ◀ or ▶ to highlight Index in the Photo menu bar and press ⏏. For details on the Memory Stick Index, see page 70.
Access additional options in the Photo menu bar	See “Photo Menu Bar Options” on page 72.
Exit Memory Stick Viewer	Press MEMORY STICK on the remote control.



Photo Menu Bar Options

The Photo menu bar lets you access additional photo viewing options.

To access the Photo menu bar

- 1 Press **←** or **→** to select **Slide Show**, **View**, or **File**.
- 2 Use **↑** **↓** **←** **→** to select the desired option.

Option	Description
Index	Displays the Memory Stick Index, with the highlight on the thumbnail of the currently displayed photo. For details, see “Using the Memory Stick Index” on page 69.
Slide Show	Displays the Slide Show menu. For details, see “Slide Show Menu Options” on page 76.
View	Zoom/Pan Allows you to magnify and pan across the photo. For details, see “Using Zoom and Pan” on page 73.
	Rotate Allows you to rotate the photo in 90 degree increments clockwise or counterclockwise. For details, see “Using Rotate” on page 73.
File	Information Allows you to turn on or off the display of file information. Select On or Off .
	Protect Allows you to protect the JPEG file from any changes. When a JPEG file is protected, it cannot be rotated or deleted. Select On or Off .
	Delete Deletes the JPEG file from the Memory Stick. You cannot delete a JPEG file that has been protected (or if the Memory Stick is locked).

 JPEG files that are protected are indicated by the Lock  icon.

Using Zoom and Pan

To Zoom and Pan a photo

- 1 In the Photo menu bar, press ◀ or ▶ to highlight **View**.
- 2 Press ▲ or ▼ to highlight **Zoom/Pan** and press (A+).
- 3 Specify the zoom center point by using ▲ ▼ ◀ ▶; then press (A+) to set the center.

The Zoom and Pan controls are displayed.

Indicates Zoom increment

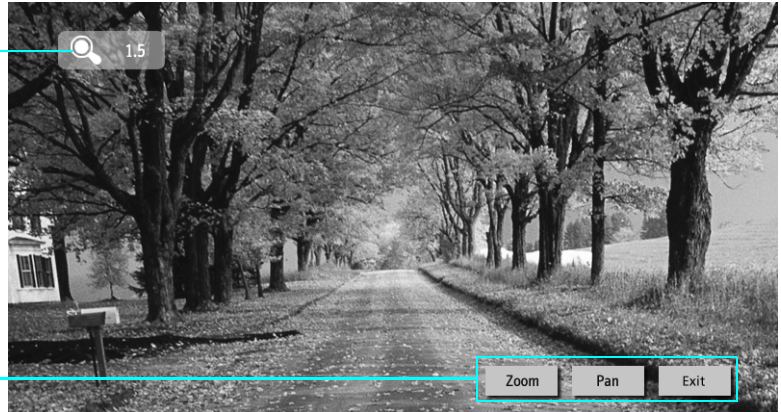

Zoom and Pan Controls

To Do This ...

Zoom in (increase magnification) or out (decrease magnification)

Pan (left, right, up, down)

Exit the Zoom/Pan controls

Exit Memory Stick Viewer

Do This ...

Press ◀ or ▶ to highlight **Zoom** and press (A+). Then press ▲ to zoom in or ▼ to zoom out.

To stop using Zoom, press (A+).

(You can use **Pan** only when the photo is magnified using **Zoom**.)

Press ◀ or ▶ to highlight **Pan** and press (A+). Then press ◀ ▶ ▲ ▼ to pan around the photo.

To stop using Pan, press (A+).

Press ◀ or ▶ to highlight **Exit** and press (A+).

Press **MEMORY STICK**  on the remote control.

Using Rotate

To Rotate a photo

- 1 In the Photo menu bar, press ◀ or ▶ to highlight **View**.
- 2 Press ▲ or ▼ to highlight **Rotate**.
- 3 To rotate clockwise, press ▲ or ▼ to highlight **Clockwise** and press (A+).
To rotate counterclockwise, press ▲ or ▼ to highlight **Counterclockwise** and press (A+).

The photo is rotated 90 degrees each time you press (A+).



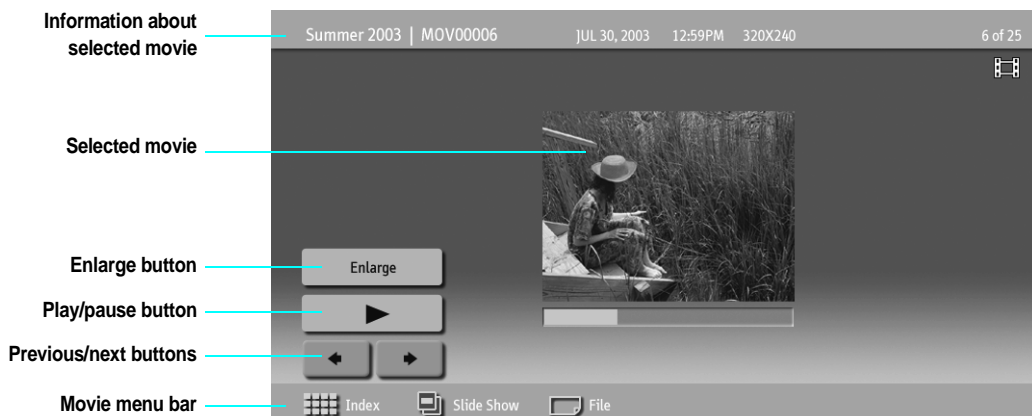

Playing Movies

When you select a movie from the Memory Stick Index (described on page 69), it displays as shown below, with the following controls.



Movie Controls

 The quality of the movie when enlarged depends on the resolution of the MPEG1 file. See your camera's instruction manual for details.



To Do This ...	Do This ...
Enlarge the movie window	Press ▲ or ▼ to highlight Enlarge , and then press  . To display the movie controls again, press  . When the movie playback ends, the movie controls are displayed again.
Play the movie with the movie controls displayed	Press ▲ or ▼ to highlight ▶ (Play) and then press  .
Pause the movie	While the movie is playing, the ▶ button changes ⏸ (pause) button. Press ▲ or ▼ to highlight ⏸ (Pause) and then press  .
Display the previous or next file on the Memory Stick	Press ▲ or ▼ to highlight the ◀ ▶ (Previous/Next) button. Then press ◀ to go to the previous file, or ▶ to go to the next file.
Hide the Movie menu bar, displaying only the movie	With the highlight in the Movie menu bar, press ▼ .
Display the hidden Movie menu bar	Press ▲ .
Access additional options in the Movie menu bar	See "Movie Menu Bar Options" on page 75.
Exit Memory Stick Viewer	Press MEMORY STICK  on the remote control.

Movie Menu Bar Options

To access the Movie menu bar

- 1 Use **↑** or **↓** to highlight **Index** in the Movie menu bar.
- 2 Press **←** or **→** to select **Index**, **Slide Show**, or **File**.
- 3 Press **↑** or **↓** to select the desired option.

Option	Description
Index	Displays the Memory Stick Index, with the highlight on the thumbnail of the currently displayed movie.
Slide Show	Displays the Slide Show menu. For details, see “Slide Show Menu Options” on page 76.
File	Information Determines whether file information is displayed. Select On or Off .
	Protect Allows you to protect the MPEG1 file from any changes. When an MPEG1 file is protected, it cannot be deleted. Select On or Off .
	Delete Deletes the MPEG1 file from the Memory Stick. You cannot delete an MPEG1 file that has been protected (or if the Memory Stick is locked).

 MPEG1 files that are protected are indicated by the Lock  icon.

Memory Stick Index Menu Bar Options

Slide Show Menu Options

 The Slide Show menu is the same whether you select it from the Memory Stick Index (page 69), Photo (page 71), or Movie (page 74) menus.

 When you select [Complete List](#), it may take a moment to display the list of all MP3 files.

 Some JPEG files may take longer to display than others, which may make it seem longer than the interval you selected for [Slide](#)



The Slide Show menu includes the following options:

Option	Description
Start	Starts the Slide Show.
Music	Allows you to select background audio to play during the Slide Show.
Off	No additional background audio is played during the Slide Show. Audio that is associated with the JPEG or MPEG1 files will play.
Play All	Plays all MP3 files on the Memory Stick. The Piano MP3 file is not played.
Piano	Plays the MP3 file stored in the LCD projection TV's internal memory. (This file is indicated by a different color than the MP3 files on the Memory Stick.)
(List of MP3 Files)	Displays a list of all MP3 files found at the top level (root) of the Memory Stick. To show additional MP3 files stored in other folders on the Memory Stick, select Complete List .
Complete List	Displays a list of all available MP3 files. The list is sorted in alphabetical order, grouped by folder.
Transition Effect	Allows you to select an effect to be used when advancing to the next file in the Slide Show.
Off	Uses a quick change, or cut.
Fade	Uses a cross fade.
Wipe →	Uses a linear sweep that moves across the screen, revealing the next image while covering the previous image.
Wipe ←	
Wipe ↑	
Wipe ↓	
Random	Randomly cycles through all Transition Effects.
Slide Duration	Allows you to specify a timed slide advance after a selected time interval. Select from 3 sec , 5 sec , 10 sec , 30 sec , 1 min , 5 min .
Repeat	On Slide Show continuously loops.
	Off Slide Show plays once through all files and ends.

Folder Menu Options

The Folder menu includes the following options:

Option	Description
Select Contents	Allows you to select different folders to view in the Memory Stick Viewer.
Digital Camera Folders	Selects all folders within the directories defined by the DCF rules used by Sony digital cameras (see page 78). JPEG and MPEG1 files in those directories are recognized even if they do not conform to the DCF file naming rules.
Select a Folder	Allows you to access individual folders on the Memory Stick.
Protect	Allows you to protect files from any changes. When a file is protected, it cannot be rotated or deleted. The Protect options affect files currently shown in the Memory Stick Index.
Protect All	Protects all files.
Protect None	Unprotects all files.
File Order	Allows you to change the order in which the Memory Stick files are displayed.
Date Order	Displays files in chronological order by modification date.
Date Order Reverse	Displays files in reverse chronological order by modification date.
Alphabetical	Displays files in alphabetical order by filename.
Filter	Allows you to selectively display specific file types within the selected folder.
Show All	Displays all readable files.
Show Photos Only	Displays only photo (JPEG) files.
Show Movies Only	Displays only movie (MPEG1) files.

 Files that are protected are indicated by the Lock  icon.

 The Rotate and Protect functions do not change the file's modification date.

Memory Stick Menu

The Memory Stick menu displays the current status of the Memory Stick, including total capacity, used capacity, and free capacity.

Notes on Using Memory Stick Media

About DCF File Names

Most Sony brand digital still and video cameras automatically record still photo and movie files using DCF compliant directory and file names.

If you selected the [Digital Camera Folders](#) option, as described on page 77, you might want to have your digital camera's instruction manual handy in order to check how files and directories are organized for your specific model of digital camera.

DCF stands for "Design Rules for Camera File Systems," which are specifications established by the Japan Electronics and Information Technology Industries Association (JEITA: former JEIDA).

Memory Stick Precautions

When using Memory Stick media, follow these precautions:

- ❑ To avoid permanent damage to still image data, do not turn off the LCD projection TV or remove Memory Stick media from the insertion slot while data is being read (as indicated by the Memory Stick indicator light being on).
- ❑ Avoid touching the terminal of Memory Stick media or bringing it into contact with a metal object.
- ❑ Do not drop, bend, or submit Memory Stick media to external shock.
- ❑ Do not disassemble or modify Memory Stick media.
- ❑ Avoid getting liquid on Memory Stick media.
- ❑ Apply labels only within the designated label area.

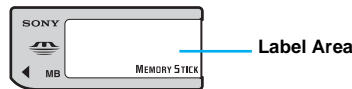

- ❑ To avoid permanent damage to still image data, do not use or store Memory Stick media in a location subject to:
 - ❑ High temperature (such as near a heater or inside a hot car)
 - ❑ High humidity
 - ❑ Direct sunlight
 - ❑ Corrosive substances
 - ❑ Magnetic fields
 - ❑ Excessive dust
 - ❑ Static electricity or electric noise
 - ❑ Electric surges
- ❑ Store and carry Memory Stick media in its original case to ensure protection of stored data.
- ❑ Save a backup of stored data.

Using i.LINK

About i.LINK

This LCD projection TV is equipped with i.LINK, which provides a secure digital interface to other digital home entertainment devices, such as digital VCRs, digital camcorders, set-top boxes, and other devices that also are equipped with i.LINK. i.LINK allows for the secure transfer of copyright-protected digital content between these devices and your digital television.

i.LINK is a trademark of Sony Corporation and used only to designate that a product contains an IEEE 1394 connector.

All products with an i.LINK connector may not communicate with each other.

Using i.LINK Cables

This LCD projection TV has three S400 i.LINK terminals (one in the front panel, and two in the back panel). You can use the following i.LINK cables with this LCD projection TV:

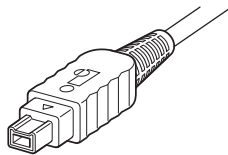

4-pin i.LINK cable

Sony Model	Length
VMC-IL4415	1.5 meters
VMC-IL4435	3.5 meters

 Do not use cables other than the ones listed above.

Connecting i.LINK Devices

 Before connecting this unit to i.LINK-compatible equipment, read the instruction manual of the i.LINK device to be connected.

To connect a digital i.LINK device (using only a digital signal)

- 1 Using an i.LINK cable (see page 80), connect the device's i.LINK jack to either of the LCD projection TV's i.LINK jacks.

To connect an i.LINK device that supports an EIA-775A connection

- 1 Using an i.LINK cable (see page 80), connect the device's i.LINK jack to either of the LCD projection TV's i.LINK jacks.
- 2 Using an A/V cable, connect the i.LINK device's A/V output jacks to the LCD projection TV's VIDEO 3 A/V input jacks.

 Only one i.LINK cable should connect the LCD projection TV and any given i.LINK device.

Rear of the LCD projection TV

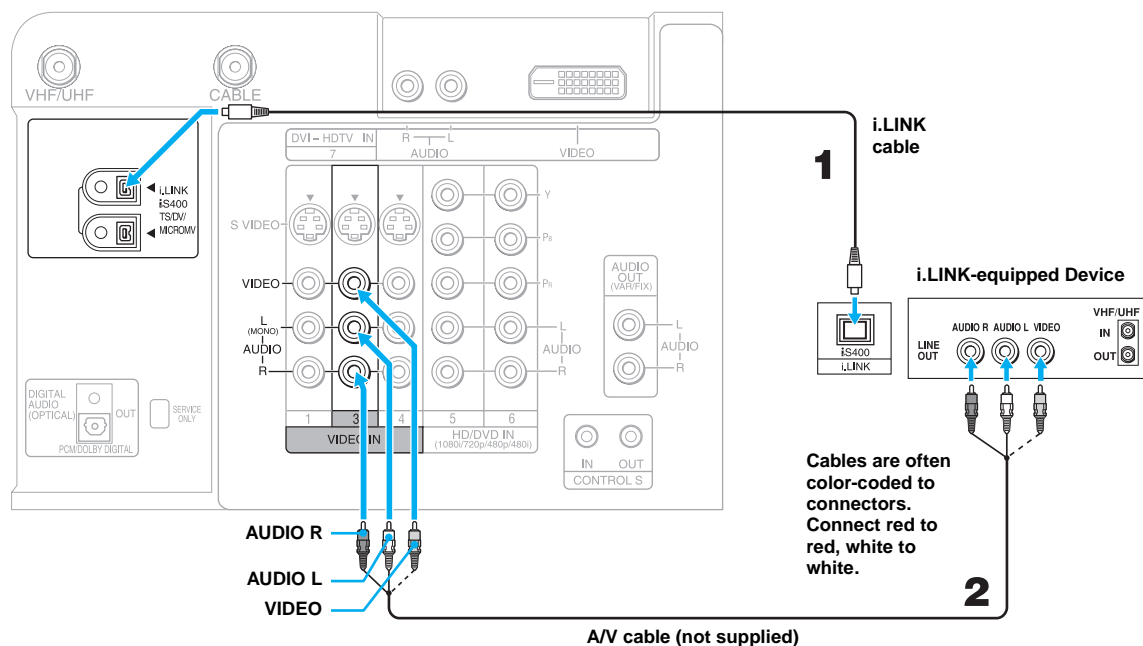

(Continued)

Notes on Using This Connection

To Do This ...	Do This ...
Set up a digital i.LINK device	For digital i.LINK devices (devices that require only the i.LINK connection), no setup is necessary. The LCD projection TV automatically recognizes the device as soon as the connection is made.
Set up an i.LINK device that supports an EIA-775A analog connection	<ul style="list-style-type: none"> ❑ Connect analog A/V cables to the VIDEO 3 input (see page 81). ❑ Use the i.LINK Control Panel to activate the analog connection to your i.LINK device (see page 86).

Notes on Connecting i.LINK Devices

To connect two or more i.LINK devices, use i.LINK cables to connect them as shown below.

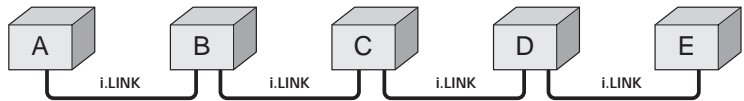

You can connect up to 63 i.LINK devices. However, the maximum number of cables in any serial route is 16.

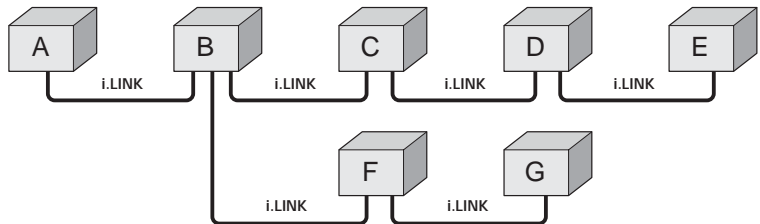

Do not connect i.LINK devices in a way that creates a loop.

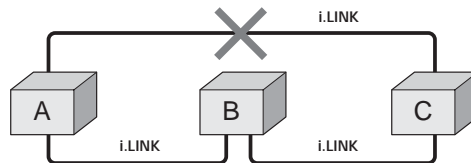

Connecting non-compatible devices, such as PCs or PC peripherals, may result in malfunctions.

Selecting an i.LINK Device

Before an i.LINK device can be viewed, it must first be selected via the i.LINK Device List.

- 1 Connect the i.LINK device that you wish to operate.

 For instructions on connecting i.LINK devices, see page 81.

- 2 Press **i.LINK** on the remote control.



 i.LINK functions are not available while using the following TV features: Twin View, Freeze, and Memory Stick.

The LCD projection TV (DTV), along with all devices connected by i.LINK to the LCD projection TV, appear on the i.LINK Device List.

Devices that are not supported by the LCD projection TV appear on the Device List as “Other Device,” but cannot be controlled using the LCD projection TV's remote control or on-screen i.LINK Control Panel. For these devices, use the remote control supplied with the device.

- 3 Press **▲** or **▼** to navigate among the i.LINK-connected devices.



 i.LINK devices can be connected to one another and to the LCD projection TV while the LCD projection TV is powered on. The Device List will automatically update to include the newly-connected device. See page 81 for more information on connecting i.LINK devices.

- 4 Press **[OK]** to select the desired device and display the device's i.LINK Control Panel. Use the i.LINK Control Panel to operate the selected device. For details, see page 84.

Using the i.LINK Control Panel

After you select an i.LINK device using the Device List, the LCD projection TV displays the i.LINK Control Panel, which allows you to use the LCD projection TV's remote to control the selected i.LINK device.

1 If the i.LINK Control Panel is not already displayed, press **i.LINK** on the remote control.

 If i.LINK is pressed while the LCD projection TV is displaying an analog or digital channel (not the i.LINK device), then the Device List will appear. Select the desired device from the list and press  to display the Control Panel.

2 Press **▲ ▼ ◀ ▶** on the remote control to navigate through the options available in the i.LINK Control Panel.

3 Press  to select a desired option.







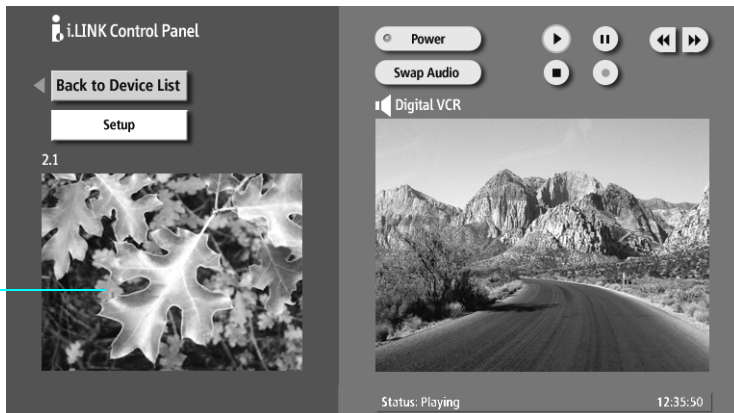







4 Press **EXIT** to exit the Control Panel and view the i.LINK device full-screen.

 To exit i.LINK mode, select DTV from the Device List or press **CH+/-**.

The DTV window appears only if the i.LINK menus were entered while watching a digital TV channel



The i.LINK Control Panel displays the signal from the LCD projection TV to the left (if available), and the signal from the currently selected device to the right.

To Do This ...	Do This ...
Go to the Device List	Press ↑ ↓ ← → to highlight Back to Device List and press  .
Change the audio being played from the LCD projection TV to the current selected device, and vice versa	Press ↑ ↓ ← → to highlight Swap Audio and press  . An icon appears next to the window that currently has sound.
Play a recording from the selected i.LINK camcorder or digital VCR	Press ↑ ↓ ← → to highlight  and press  .
Fast-forward or rewind a recording from the selected i.LINK camcorder or digital VCR	Press ↑ ↓ ← → to highlight  or  and press  .
Record from LCD projection TV to the selected i.LINK digital VCR	If the  (record) button is available, press ↑ ↓ ← → to highlight  and press  .
Stop a recording from the selected i.LINK digital VCR	Press ↑ ↓ ← → to highlight  and press  .
Turn the selected device power on and off	Press ↑ ↓ ← → to highlight Power and press  .
Setup the selected device	Press ↑ ↓ ← → to highlight Setup and press  . For more details on Setup, see page 86.

Notes About Controlling i.LINK Devices

- ❑ You can control the functions of the selected i.LINK device by using the equivalent buttons on the LCD projection TV's remote control. To program the remote control to operate i.LINK devices, see "Programming the Remote Control" on page 48.
- ❑ Some options on the i.LINK Control Panel may not be available, depending on the device being controlled.
- ❑ Only i.LINK-equipped digital camcorders and digital VCRs can be controlled directly through the i.LINK Control Panel.
- ❑ Not all functions are supported for all i.LINK devices.

i.LINK Setup

You can use the i.LINK Control Panel to access digital setup options, some of which are also available through the Digital Program Guide (described on page 62).

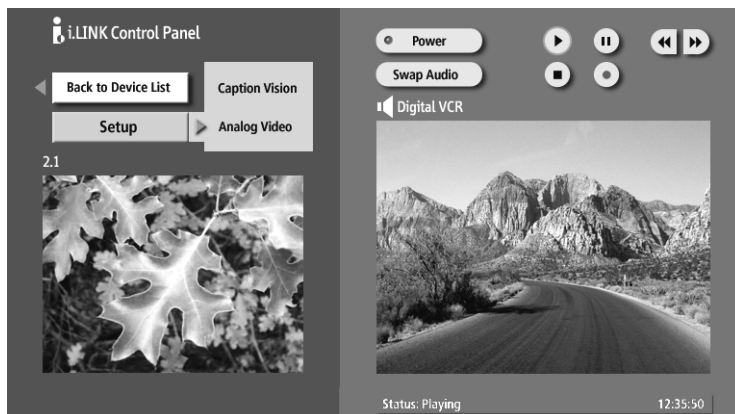

To Do This ...	Do This ...
Set up the selected device	Press ▲ ▼ ◀ ▶ to highlight Setup and press ⏺ .
Set up Caption Vision	Once i.LINK Setup has been selected, Press ▶ then ▲ or ▼ to Caption Vision , and press ⏺ . <div style="background-color: #e0f0ff; padding: 5px;">✍ For details about setting up Caption Vision , see "Customizing Caption Vision" on page 63.</div>
Set up i.LINK Analog Video (Set-Top Box)	The LCD projection TV is able to accept an analog signal from a selected set-top box. The set-top box must be EIA-775A compliant and must be connected to the LCD projection TV's VIDEO 3 input. To associate the device with the LCD projection TV's analog VIDEO 3 input, press ▲ or ▼ to select to Analog Video and press ⏺ . All EIA-775A-compliant devices will be shown in the list. Select the desired device from the list and press ⏺ .

Notes on i.LINK

- ❑ The LCD projection TV can act as an i.LINK repeater, so that i.LINK signals are be relayed to another device even when the LCD projection TV is powered off. To enable this feature, set the **i.LINK Standby** option to **On** using the Setup Menu as described on page 105.
- ❑ Parental Control settings apply to the signal from a selected device. For more details, see page 98.

Using the Menus

Overview

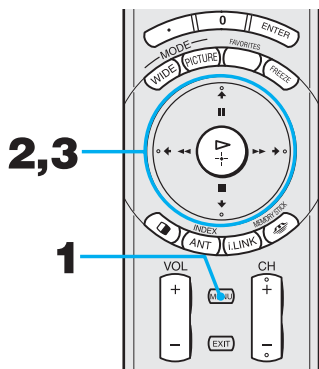

Opening and choosing a menu

- 1 Press **MENU** to display the menu screen.
- 2 Press **←** or **→** to highlight the desired menu icon and press **⏏** to select it.
- 3 Use the arrow button to scroll through the features.
- 4 See the specific menu page for instructions on moving through the menu.







To end a menu session

- ❑ Press **MENU** again.

To end one menu session and move to another

- ❑ Press **↑** to return to the menu icons.
Press **←** or **→** to choose the next menu icon and press **⏏** to select it.





The menu gives you access to the following features:

Menu Icon	Description	Page
	Allows you to make adjustments to your picture settings. It also allows you to customize the Picture Mode based on the type of program you are viewing.	88
	Offers enhanced audio options such as listening to second audio programming (SAP), or customizing the Effect of the sound on your LCD projection TV.	92
	Allows you to set the wide screen mode, adjust the vertical center and vertical size in wide mode, and set the 4:3 Default mode.	94
	Allows you to set up a Favorite Channel list, run the Auto Program function, and more.	96
	Lets you control the viewing of programs based on their ratings.	98
	Provides several options for setting up your channels, labeling your Video inputs, selecting the language of the on-screen menus and more.	102



Using the Video Menu

To select the Video Menu

- 1 Press **MENU**.
- 2 Press **←** or **→** to highlight the Video icon  and press .
- 3 Use the arrow button to scroll through the features.
- 4 Press  to select a feature. That feature's adjustment appears.
- 5 Use the arrow button to make the desired adjustments.
- 6 Press  to select/set.
- 7 Press **MENU** to exit the menu screen.





To restore the factory default settings for the Video settings:

- Press **RESET** on the remote control when in the Video menu.

Selecting Video Options

 To quickly and easily change from one Picture Mode to another, use **PICTURE** on the remote control.

The Video menu includes the following options.

Option	Description
Mode	Vivid Select for enhanced picture contrast and sharpness.
Customized picture viewing	Standard Select for standard picture settings. Recommended for home entertainment.
	Pro Select to display a picture with minimum enhancements.
<p> You can alter the Video menu settings (Picture, Brightness, Color, etc.) for each Mode.</p> <p> You may set up a "Picture Mode" (Vivid, Standard, Pro) independently for each Video input (Video 1-Video 7, including the Antenna input). Your "Picture Mode" settings will automatically be saved after each selection. This will enable you to customize the Picture Mode setting for each type of signal source. Typically, Vivid should be used for higher quality input signal sources, and Pro for lower quality signals.</p>	
Picture	Adjust to increase picture contrast and deepen the color or decrease picture contrast and soften the color.
Brightness	Adjust to brighten or darken the picture.
Color	Adjust to increase or decrease color intensity.
Hue	Adjust to increase or decrease the green tones.



Option	Description
Sharpness	Adjust to sharpen or soften the picture.
Color Temp.	Choose from three color temperatures:
<i>White intensity adjustment</i>	Cool Select to give the white colors a blue tint.
	Neutral Select to give the white colors a neutral tint.
	Warm Select to give the white colors a red tint.
NR Noise Reduction	Select to reduce the noise level of connected equipment. It is also effective on the signal from the VHF/UHF jack. Select from High, Medium, Low, Off .
Mild Mode	On Select for a natural, soft picture.
	Off Select to turn off Mild Mode .
Advanced Video	Select Program to choose among the options described below.
	DRC Mode Creates a high-resolution picture with 4 × density, for high quality sources (i.e., DVD player, satellite receiver).
	High Dens. Recommended for moving pictures.
	Progressive Recommended for still images and text.
	CineMotion Provides an optimized display by automatically detecting film content and applying a reverse 3-2 pulldown process. Moving pictures will appear clearer and more natural-looking.

 **DRC Mode** and **DRC Palette** are not available when watching 480p, 720p, and 1080i sources.

 **DRC Palette** is not available when **Mild Mode** is set to **On**.

 **BN Smoother** may not be effective according to the input equipment.

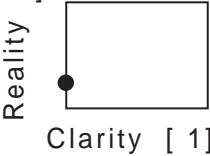
 **Clear White, Detail Enhancer, Color Corrector, Black Corrector, Gamma Balance** and **Cinema Black** options are available only when **Pro mode** is selected.





Option	Description
	<p>DRC Palette Allows you to customize the level of detail (Reality) and smoothness (Clarity) for up to three input sources. For example, you can create one Custom setting to optimize your cable input's picture, and create another to optimize your DVD player's picture. You can switch among the three Custom settings.</p> <ol style="list-style-type: none"> Press the arrow button to highlight Custom 1, Custom 2, or Custom 3 and then press . The DRC palette appears. <div data-bbox="744 465 1145 696" style="border: 1px solid black; padding: 5px; margin: 10px 0;"> <p>Custom 1 [25]</p>  <p>Reality</p> <p>Clarity [1]</p> </div> <ol style="list-style-type: none"> Press the arrow button to adjust the position of the marker (●). As you move the ● higher along the Reality axis, the picture becomes more detailed. As you move the ● to the right along the Clarity axis, the picture becomes smoother. To save the setting, press . <p>To return the Custom options to the default factory settings, press the RESET button.</p>
<p>BN Smoother</p>	<p>Select to reduce block noise caused by digital video encoding and decoding process. It is especially effective for watching a DVD or digital TV picture. Select from High, Medium, Low and Off.</p>
<p> An image may not be corrected due to the connected equipment.</p>	
<p>Clear White</p>	<p>Select to emphasize the white colors. Select On or Off.</p>
<p>Detail Enhancer</p>	<p>Select to sharpen picture definition. Select from High, Medium, Low and Off.</p>
<p>Color Corrector</p>	<p>Select to emphasize the red and blue colors. Select On or Off.</p>
<p>Black Corrector</p>	<p>Select to enhance the black colors to give the picture strong contrast. Select from High, Medium, Low and Off.</p>
<p>Gamma Corrector</p>	<p>Select to adjust the balance between bright and dark areas of the picture. Select from High, Medium, Low and Off.</p>

Option	Description
White Balance	Select to fine-adjust the white color intensity by changing the red, green and blue levels. You can adjust these levels by selecting R-Gain , G-Gain , B-Gain , R-Bias , G-Bias or B-Bias . To restore the factory default setting of White Balance , select Initial Set .
Cinema Black	Select to enhance the black level. Select On or Off .



Using the Audio Menu

To select the Audio Menu

- 1 Press **MENU**.
- 2 Press **←** or **→** to highlight the Audio icon  and press .
- 3 Use the arrow button to scroll through the options.
- 4 Press  to select an option. That option's settings appear.
- 5 Use the arrow button to scroll through the settings.
- 6 Press  to select the desired setting.
- 7 Press **MENU** to exit the menu screen.

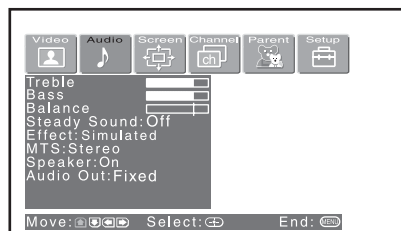

To restore the factory default settings for Treble, Bass and Balance

- Press **RESET** on the remote control when in the Audio menu.

Selecting Audio Options

 **Virtual Dolby** and **TruSurround** attempt to create the same surround effect produced by a multichannel system using the left and right speakers. **Virtual Dolby** is most effective for programs encoded in Dolby Surround.

The Audio menu includes the following options:





Option	Description
Treble	Adjust to increase or decrease higher-pitched sounds.
Bass	Adjust to increase or decrease lower-pitched sounds.
Balance	Adjust to emphasize left or right speaker balance.
Steady Sound	Auto Select to stabilize the volume. Off Select to turn off Steady Sound.
Effect	Virtual Dolby Select for Dolby Pro Logic surround sound (for stereo programs only). TruSurround Select for surround sound (for stereo programs only). Simulated Adds a surround-like effect to mono programs. Off Normal stereo or mono reception.

Option	Description	
MTS <i>Enjoy stereo, bilingual and mono programs</i>	Stereo	Select for stereo reception when viewing a program broadcast in stereo.
	Auto SAP	Select to automatically switch the LCD projection TV to second audio programs when a signal is received. (If no SAP signal is present, the LCD projection TV remains in Stereo mode.)
	Mono	Select for mono reception. (Use to reduce noise during weak stereo broadcasts.)
Speaker	On	Select to turn on the LCD projection TV speakers.
	Off	Select to turn off the LCD projection TV speakers and listen to the LCD projection TV's sound only through your external audio system speakers.
Audio Out <i>Easy control of volume adjustments</i>	Variable	This option can be set only when the Speaker option is set to Off . The LCD projection TV's speakers are turned off, but the audio output from your audio system can still be controlled by the LCD projection TV's remote control.
	Fixed	The LCD projection TV's speakers are turned off and the audio output of the LCD projection TV is fixed. Use your audio receiver's volume control to adjust the volume (and other setting) through your audio system.



Using the Screen Menu

To select the Screen menu

- 1 Press **MENU**.
- 2 Press **←** or **→** to highlight the Screen icon  and press .
- 3 Use the arrow button to scroll through the features.
- 4 Press  to select a feature. That feature's options appear.
- 5 Use the arrow button to scroll through the options.
- 6 Press  to select the desired option.
- 7 Press **MENU** to exit the menu screen.

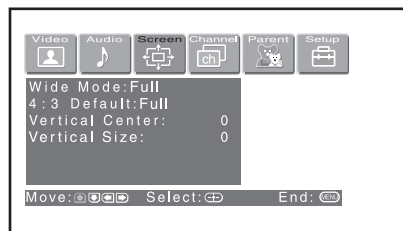

Selecting Screen Options

 **Wide Mode** is unavailable while in Twin View (page 55) or Freeze (page 58) mode.

 **Wide Mode** is unavailable when you are watching 720p and 1080i sources, and when viewing photos from your memory stick media.



The Screen menu includes the following options:

 To change from one **Wide Mode** to another, use **WIDE MODE** on the remote control.

Option	Description
Wide Mode <i>Select a Screen Mode to use for 4:3 sources.</i>	Wide Zoom Select to enlarge the 4:3 picture, to fill the 16:9 screen, keeping the original image as much as possible.
	Normal Select to return the 4:3 picture to normal mode.
	Full Select to enlarge the 4:3 picture horizontally only, to fill the wide screen.
	Zoom Select to enlarge the 4:3 picture horizontally and vertically to an equal aspect ratio that fills the wide screen.

 The **4:3 Default** functions only when the LCD projection TV receives 480i and 480p signals.





 If **4:3 Default** is set to anything but **Off**, the **Wide Mode** setting changes only for the current channel. When you change channels (or inputs), **Wide Mode** is automatically replaced with the **4:3 Default** setting. To retain the current Wide Mode setting as channels and inputs are changed, set **4:3 Default** to **Off**.

Option	Description	
4:3 Default	Wide Zoom	Select to enlarge the 4:3 picture, to fill the 16:9 screen, keeping the original image as much as possible.
<i>Select the default Screen Mode to use for 4:3 sources.</i>	Normal	Select to return the 4:3 picture to normal mode.
	Full	Select to enlarge the 4:3 picture horizontally only, to fill the wide screen.
	Zoom	Select to enlarge the 4:3 picture horizontally and vertically to an equal aspect ratio that fills the wide screen.
	Off	Select to continue using the current Screen Mode setting when the channel or input is changed.
Vertical Center	Adjust	Allows you to move the position of the picture up and down in the window. (Available only in Wide Zoom and Zoom modes.) Press ▲ or ▼ and press  to choose a position between +25 and -25 (ZOOM mode), and +10 and -10 (Wide Zoom mode).
Vertical Size	Adjust	Allows you to adjust the vertical size of the picture. (Available only in Wide Zoom and Zoom modes.) Press ▲ or ▼ and press  to choose a correction between +7 and -7.



Using the Channel Menu

To select the Channel Menu

- 1 Press **MENU**.
- 2 Press **←** or **→** to highlight the Channel icon  and press .
- 3 Use the arrow button to scroll through the features.
- 4 Press  to select a feature. That feature's options appear.
- 5 Use the arrow button to scroll through the options.
- 6 Press  to select the desired option.
- 7 Press **MENU** to exit the menu screen.

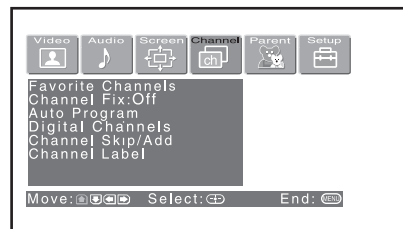







Selecting Channel Options

The Channel menu includes the following options:

Option	Description
Favorite Channels	Let you set up a list of your favorite channels. For details, see "Using Favorite Channels" on page 54.
Channel Fix	Off Turns off Channel Fix .
<i>Useful when you have a cable box or satellite receiver connected</i>	2-6 "Fix" your LCD projection TV's channel setting to 2-6 and use the cable box, VCR or satellite receiver to change channels. Select one of these settings if you have connected the device to the VHF/UHF jack.
	C 2-6 Same as 2-6, except you select one of these settings if you have connected the device to the CABLE jack (see page 23).
	Video 1 Use when connecting a cable box. TV output should be connected through the cable box.
Auto Program	Automatically programs the LCD projection TV for all receivable channels.
Digital Channels Add	Select to add digital channels.

 Channels that you set to be skipped can be accessed only with the 0-9 buttons.

Option	Description
Channel Skip/Add	<p>Allows you to customize the channel list that appears when you use the CH+/- buttons.</p> <ol style="list-style-type: none"> 1 Press ▲ or ▼ to scroll through the channels until you find the channel you want to skip or add. Then press  to select it. 2 Press ▲ or ▼ to toggle between Add or Skip. Then press  to select. 3 To add or skip more channels, repeat steps 1 and 2. 4 Press ◀ to return to the Channel Menu, or press MENU to exit the Menus.
Channel Label	<p>Allows you to assign labels (such as station call letters) to channel numbers. You can label up to 40 channels.</p> <ol style="list-style-type: none"> 1 Press ▲▼◀▶ to highlight Channel and press . 2 Press ▲ or ▼ to scroll through the channel numbers (1-125). Then press  to select the channel number that you want to assign a label. 3 Press ▲▼◀▶ to highlight Label and press . 4 Press ▲ or ▼ to scroll through the label characters (A-Z, 0-9, etc.). Then press  to select the highlighted character. 5 Repeat to add up to 5 characters to the label. 6 To assign labels to more channels, repeat steps 1-4. 7 Press ◀ to return to the Channel Menu, or press MENU to exit the Menus.





Using the Parent Menu

The Parent Menu allows you to set up the TV to block programs according to their content and rating levels.

To select the Parent Menu

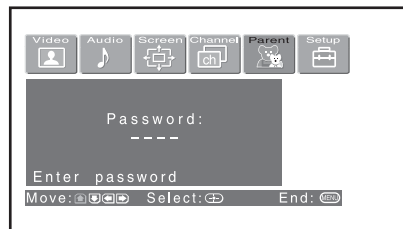
- 1 Press **MENU**.
- 2 Press **←** or **→** to highlight the Parent icon  and press **(A+)**.
- 3 Use the 0-9 buttons on the remote control to enter a four-digit password.
- 4 If this is the first time you are creating this password, confirm the password by entering it again. (The Parent Menu options appear.)
- 5 Press **↑** **↓** **←** **→** to change settings. Press **(F)** to select the changed setting.
- 6 Press **MENU** to exit the Menu.





 You need your password for any future access into the Parent Menu. If you lose your password, see “Lost password” on page 113.

Selecting Parent Options

The Parent Menu includes the following options:

Option	Description
Parental Lock <i>Turn ratings on/off and select a rating system</i>	<p>Off Parental lock is off. No programs are blocked from viewing.</p> <hr/> <p>Child Maximum ratings permitted are: US: TV-Y, TV-G, G Canada: C, G, TV-Y</p> <hr/> <p>Youth Maximum ratings permitted are: US: TV-PG, PG Canada: C8+, PG, 8 ans+, TV-PG</p> <hr/> <p>Y. Adult Maximum ratings permitted are: US: TV-14, PG-13 Canada: 14+, 13 ans+, TV-14</p> <hr/> <p>Custom Select to set ratings manually. US: See page 100 for details. Canada: See page 101 for details.</p>

 If you are not familiar with the Parental Guideline rating system, you should select **Child**, **Youth**, or **Y.Adult** to help simplify the rating selection. To set more restrictive ratings, select **Custom**.

 For descriptions of **Child**, **Youth**, and **Y.Adult** ratings, see page 98.

Option	Description
Change Password	For changing your password.
Select Country	U.S.A. Select to use USA ratings (see page 100). Canada Select to use Canadian ratings (see page 101).

To deactivate the Parental Control feature

- Set **Parental Lock** to **OFF** when in the Parent menu.

To change the password

- 1 Select **Change Password** option when in the Parent menu using the arrow button, and press .
- 2 Enter a new four-digit password using the **0-9** buttons.
- 3 Confirm the new password by entering it again.
- 4 Press **MENU** to exit the menu screen.

Viewing Blocked Programs

You can view a blocked program by entering the password.

- 1 Press **ENTER** when tuned to a blocked program.
- 2 Enter your password using the **0-9** buttons. Parental Control will be canceled temporarily until you turn your LCD projection TV off.

Selecting Custom Rating Options

 To ensure maximum blocking capability, the age-based ratings should be blocked.

 If you select **Block**, please be aware that the following programs may be blocked: emergency broadcasts, political programs, sports, news, public service announcements, religious programs and weather.

US custom rating options

If you selected U.S.A. as the country of residence on page 99, the Custom Rating Menu includes the following options. (If you selected Canada, see page 101.)

Option	Description
Movie Rating	G All children and General Audience.
	PG Parental Guidance suggested.
	PG-13 Parental Guidance for children under 13.
	R Restricted viewing, parental guidance is suggested for children under 17.
	NC-17 and X No one 17 and under allowed.
TV Rating <i>Block programs by their rating, content or both</i>	Age-Based Options
	TV-Y All children.
	TV-Y7 Directed to children age 7 and older.
	TV-G General Audience.
	TV-PG Parental Guidance suggested.
	TV-14 Parents Strongly cautioned.
	TV-MA Mature Audience only.
	Content-Based Options
	FV Fantasy Violence.
	D Suggestive Dialogue.
	L Strong Language.
	S Sexual situations.
	V Violence.
	Unrated <i>Block programs or movies that are broadcast without a rating</i>
Allow Allows programs and movies that are broadcast without a rating.	

 The content ratings will increase depending on the level of the age-based rating. For example, a program with a **TV-PG V** (Violence) rating may contain moderate violence, while a **TV-14 V** (Violence) rating may contain more intense violence.

Canadian custom rating options





If you selected Canada as the country of residence on page 99, the Custom Rating Menu includes the following options. (If you selected U.S.A., see page 100.)

<i>Option</i>	<i>Description</i>
English Rating	C All children.
	C8+ Children 8 years and older.
	G General programming.
	PG Parental Guidance.
	14+ Viewers 14 and older.
	18+ Adult programming.
French Rating	G General programming.
	8 ans+ Not recommended for young children.
	13 ans+ Not recommended for ages under 13.
	16 ans+ Not recommended for ages under 16.
	18 ans+ Programming restricted to adults.
U.S.A. Rating	See “TV Rating” on page 100 for details.



Using the Setup Menu

To select the Setup Menu

- 1 Press **MENU**.
- 2 Press **←** or **→** to highlight the Setup icon  and press .
- 3 Use the arrow button to scroll through the features.
- 4 Press  to select a feature. That feature's options appear.
- 5 Use the arrow button to scroll through the options.
- 6 Press  to select the desired option.
- 7 Press **MENU** to exit the menu screen.

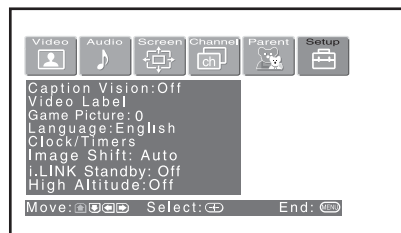

Selecting Setup Options

 Caption Vision options in the Setup menu apply only to analog programs. To set up closed captioning for digital programs, see “Using the Caption Vision Menu” on page 62.

The Setup menu includes the following options:

Option	Description
Caption Vision	Allows you to select from three closed caption modes (for programs that are broadcast with closed captioning).
Off	Turns off Caption Vision.
CC1, CC2, CC3, CC4	Displays a printed version of the dialog or sound effects of a program. (Should be set to CC1 for most programs.)
Text1, Text2, Text3, Text4	Displays network/station information presented using either half or the whole screen (if available). For closed captioning, set to CC1 .
Info	Displays the program name and the time remaining in the program (if the broadcaster offers this service). Displays when the channel is changed or the DISPLAY button is pressed.

Option	Description
Video Label	<p>Allows you to label the audio/video components you connected to the LCD projection TV so you can identify them when using TV/VIDEO. When in the Setup menu's Video Label feature, press ▲ or ▼ to highlight an input to label, then press ⏏ to select it. Use the arrow button to scroll through the labels. Press ⏏ to select the component you connected to each of the input jacks on the back of your LCD projection TV. Select Skip if you do not have a component connected to a particular set of input jacks.</p>
Video 1/2/3/4	VHS, DVD, Receiver, Satellite, Cable Box, 8mm, DTV, Game, LD, Web, Beta, Skip
Video 5/6/7	DVD, Satellite, Cable Box, DTV, HD, Game, Skip
	If you select Skip , your LCD projection TV skips this connection when you press TV/VIDEO .
Game Picture	<p>Adjust</p> <p>Allows you to move the position of the picture left and right in the window. (Available for the picture of connected equipment.) Select while watching the picture to be adjusted. The LCD projection TV stores the position in memory for each input.</p>
Language	Select to display all on-screen menus in your language of choice: English, Español, Français .

(Continued)

Option	Description
Clock/Timers	Select to set the clock and to program your LCD projection TV to turn on and off at two scheduled viewing times.
Sleep	Allows you to select the time in minutes (15, 30, 45, 60 or 90 min) at you want the TV to remain on before shutting off automatically.
Timer 1 Timer 2	You can use the Timers to program the TV to turn on and off and tune to a specific channel at two scheduled viewing times.
Timer 1 and Timer 2 are not available to be set until you set the Current Time .	
1	Press ▲ or ▼ to highlight Timer 1 or Timer 2 . To set the timer, press ▶ .
2	Press ▲ or ▼ to highlight one of the following options, then press ⊙ .
Program	Select to set the Timer by day, time, duration, and channel.
Off	Select to turn off the Timer. (Your previous settings are saved.)
3	If you selected Program in step 2, press ▲ and ▼ to set the day(s), hour, minute, duration, and channel number. Press ⊙ or press ▶ to confirm each setting and move to the next setting. Press ◀ to go back to the previous setting.
4	Press MENU to exit the Menu. An LED on the front panel will light, indicating the timer has been set.
 To go directly to programming Timer 1 or 2 , press ⊙ instead of pressing ▶ .	
Current Time	
1	Press ⊙ to select Current Time .
2	Press ▲ and ▼ to set the current time (day, hour, and minute). Press ⊙ (or press ▶) to confirm each setting and move to the next setting. Press ◀ to go back the previous setting.
3	Press MENU to exit the Menu.

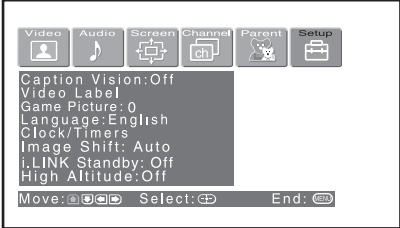
Option	Description
Image Shift	<p>Corrects the Image on your LCD projection TV.</p> <p>Before adjusting</p>  <p>After adjusting</p> 
Auto	(Factory setting) Automatically corrects double images.
Level 1-4	Select the value with which double images are improved.
i.LINK Standby	<p>On Allows the i.LINK signal to pass through to connected i.LINK devices even when the LCD projection TV is turned off. The front panel i.STANDBY (i.LINK standby) LED lights in red. The LCD projection TV uses more standby power than when this option is set to Off.</p> <p>Off Does not allow the i.LINK signal to pass through to connected i.LINK devices when the LCD projection TV is turned off. The front panel i.STANDBY (i.LINK Standby) LED turns off. The LCD projection TV uses less standby power than when this option is set to On.</p>
High Altitude	Off Select to use the LCD projection TV at normal altitude.
	On Select to use the LCD projection TV at an altitude of 1,500 m or higher.

Other Information

Overview

This chapter includes the following topics:

<i>Topic</i>	<i>Page</i>
Glossary	107
Contacting Sony	108
Troubleshooting	108
Flashing Indicators on the Front of the Monitor	114
Specifications	115
Optional Accessories	116
Index	117

Glossary

analog signal

A signaling method that uses continuous changes in the amplitude or frequency of an electronic transmission to convey information.

aspect ratio

Refers to the ratio between the width and height of the screen. This LCD projection TV has a 16:9 (widescreen) aspect ratio, as opposed to a 4:3 aspect ratio.

4:3 aspect ratio



16:9 aspect ratio



component video



Component video is sent through three cables: two color shade (chrominance) signals and one brightness (luminance) signal. Component video achieves greater color accuracy than composite video or S VIDEO by splitting chrominance into two separate portions.

composite video



Composite video is sent through a single cable. Composite video combines the color shade (chrominance) and brightness (luminance) information into one video signal.

digital television (DTV)

A new technology for transmitting and receiving broadcast television signals. DTV provides higher resolution and improved sound quality over analog television.

National Television System Committee (NTSC)

A unit of the Federal Communications Commission, Washington, DC, that establishes television standards in the United States, such as NTSC Color, the standard used in this LCD projection TV.

RF

Radio Frequency. That part of the frequency spectrum that is used to transmit TV and radio signals.

S VIDEO



S VIDEO requires a single cable, which carries the brightness (luminance) and color (chrominance) signals of the picture separately. S VIDEO provides better resolution than composite video, which carries the signals together.

VHF/UHF

VHF (Very High Frequency) is the part of the frequency spectrum from 30 to 300 megahertz. UHF (Ultra High Frequency) is the part of the frequency spectrum from 300 to 3,000 megahertz.

480i

Provides 480 lines of resolution. Displays images using interlaced scanning, which first transmits all the odd lines on the LCD projection TV screen and then the even lines.

480p

Provides 480 lines of resolution. Displays images using progressive scanning, which transmits each line from top to bottom.

720p

Provides 720 lines of resolution. Displays images using progressive scanning, which transmits each line from top to bottom.

1080i

Provides 1080 lines of resolution. Displays images using interlaced scanning, which first transmits all the odd lines on the LCD projection TV screen and then the even lines. 1080i is one of the formats used by HDTV (High Definition TV).

Contacting Sony

If, after reading these operating instructions, you have additional questions related to the use of your Sony television, please call our Customer Information Services Center at 1-800-222-SONY (7669) (US residents only) or (416) 499-SONY (7669) (Canadian residents only).

Troubleshooting

Twin View

Problem	Possible Remedies
I cannot get Twin View to work	<ul style="list-style-type: none">❑ If you are using a cable box to unscramble all channels (as shown on page 30), you cannot use the Twin View feature. This is because the cable box can unscramble only one channel at a time.❑ You can use Twin View to view a signal from a different source that is connected to the LCD projection TV's A/V jacks (such as a VCR or DVD player) in the second window by pressing TV/VIDEO while in Twin View.❑ Sources connected to the CABLE, VIDEO 5, VIDEO 6 and VIDEO 7 inputs, as well as digital source display in the left Twin View window, but not in the right.
There is no Twin View window, or it is just static	<ul style="list-style-type: none">❑ Be sure the Twin View window is set to a video input or channel that has a signal airing.❑ You might be tuned to a video input with nothing connected to it. Try cycling through the video inputs by pressing TV/VIDEO.
Twin View cannot display anything but TV channels	<ul style="list-style-type: none">❑ Try cycling through the video inputs by pressing TV/VIDEO. Check that the Video Label option is not set to Skip. (See the Setup Menu on page 102.)
Twin View displays the same program in both windows	<ul style="list-style-type: none">❑ Both Twin View windows might be set to the same channel. Try changing channels in either window.

Remote Control

Problem	Possible Remedies
Remote control does not operate	<ul style="list-style-type: none">❑ The batteries could be weak. Replace the batteries.❑ Check the orientation of the batteries.❑ Press FUNCTION repeatedly until the TV indicator lights up. You may have inadvertently pressed FUNCTION, which changes the remote control to SAT or CABLE mode.❑ Make sure this unit's power cord is connected securely to the wall outlet.❑ Locate the unit at least 3-4 feet away from fluorescent lights.





Problem	Possible Remedies
Cannot change channels with the remote control	<ul style="list-style-type: none"> ❑ If you are using the LCD projection TV to change channels, first press FUNCTION repeatedly until the TV indicator lights up. ❑ If you are using another device to change channels, be sure you have not inadvertently switched your LCD projection TV from the channel 3 or 4 setting. Use the Channel Fix option to “fix” the channel based on the hookup you used (see page 96). ❑ If you are using another device to change channels, be sure to press FUNCTION for that device. For example, if you are using your cable box to change channels, be sure to press FUNCTION repeatedly until the SAT/CABLE indicator lights up.
Remote control does not operate non-Sony video equipment	<ul style="list-style-type: none"> ❑ If you replaced the batteries to the remote recently, the code numbers for the video equipment may need to be reset. ❑ There may be more than one code for the equipment that you are attempting to operate. ❑ There is a possibility that some non-Sony equipment cannot be operated by your Sony LCD projection TV remote. You may need to use the equipment’s original remote control.

Memory Stick

Problem	Possible Remedies
Image does not display/Cannot see all files	<ul style="list-style-type: none"> ❑ Some variations of MPEG1 movies may not play back correctly. ❑ Make sure the image file is a JPEG (.jpg, .jpeg) file or an MPEG1 (.mpg, mpeg) file. ❑ Make sure the Memory Stick is inserted properly (see page 66). ❑ Check the Filter option setting (see page 77). ❑ Check the Select Contents setting (see page 77) and ensure that files are either in DCF directories if Digital Camera Folders is selected (see page 77), or in the currently selected folder if Select a Folder is selected (see page 77). ❑ The maximum number of files the Memory Stick Viewer can display is 1,024.
JPEG image displays undesirable motion or flicker in full screen	<ul style="list-style-type: none"> ❑ JPEGs captured using a digital video camera may appear to display motion in full screen. This is a result of the way digital video cameras record still images, and is not a result of a malfunction with the LCD projection TV.
Rotation not saved after Memory Stick is ejected or Memory Stick Viewer is closed	<ul style="list-style-type: none"> ❑ The Memory Stick might be locked. Unlock the Memory Stick and try rotating the image again. ❑ The file might not have information (EXIF data) that is usually generated when a digital camera records a photo. In this case, it is not possible to save the rotation. ❑ There might be insufficient space on the Memory Stick to save the rotated file. Try deleting one or more files and rotating the image again.
Cannot show (or hide) file information in full screen or Slide Show	<ul style="list-style-type: none"> ❑ Set the File/Information option to On or Off (see pages 72 and 75).
Cannot see menu	<ul style="list-style-type: none"> ❑ Press ▲ to display the menu again.
Cannot hear audio while using Memory Stick	<ul style="list-style-type: none"> ❑ Check the LCD projection TV’s volume or Speaker (page 93) settings. ❑ To hear JPEG voice memo, select the Digital Camera Folders option and set the Filter option to Show All. ❑ Check that the Music option is not set to Off (see page 76).

(Continued)

Other Information

Problem	Possible Remedies	
Not all MP3 files on Memory Stick are included when the Music/Complete List option is selected (page 76)	<ul style="list-style-type: none"> <input type="checkbox"/> The maximum number of MP3 files the Memory Stick Viewer can display is 128. <input type="checkbox"/> Make sure that the file is named with the file extension (.mp3). 	
MPEG1 movie does not play back correctly	<input type="checkbox"/>	Some variations of MPEG1 movies may not be compatible with the Memory Stick Viewer.
MPEG1 quality is poor when enlarged (page 74)	<input type="checkbox"/>	The quality of the movie when enlarged depends on the resolution of the MPEG1 file. See your camera's instruction manual for details.
MP3 files on the Memory Stick are not listed	<input type="checkbox"/>	Only MP3 files that are named with the file extension (.mp3) are displayed in the list.
Music files are playing in wrong order	<input type="checkbox"/>	MP3 files are played in alphabetical order, according to the folder in which they are stored. If you want to change the playlist order, rename your files alphabetically in the order in which you want them to play.
Cannot see MP3 list to play music	<input type="checkbox"/>	MP3 files on your Memory Stick only can be played as background music during a Slide Show (see page 76).
Error message is displayed	<input type="checkbox"/>	No Memory Stick There is no Memory Stick in the slot.
	<input type="checkbox"/>	Memory Stick is Locked The lock mechanism on the Memory Stick is engaged.
	<input type="checkbox"/>	Memory Stick Error The Memory Stick in the slot might be damaged; try a different Memory Stick.
	<input type="checkbox"/>	Format Error The Memory Stick may have been formatted using a PC or other device that is not compatible with cameras.
Error icon is displayed		The file is not a valid MPEG1 or JPEG format.
		The thumbnail is not DCF-compatible.
		The file is a JPEG or an MPEG1, but the thumbnail is unreadable.
		The file is unreadable.

Video

Problem	Possible Remedies
No picture (screen not lit), no sound	<ul style="list-style-type: none"> ❑ If your LCD projection TV does not turn on, and a red light keeps flashing, your LCD projection TV may need service. Call your local Sony Service Center. ❑ Make sure the power cord is plugged in. ❑ Press POWER on the front of the LCD projection TV. ❑ Press TV/VIDEO to cycle through the connected video sources. ❑ Try another channel; it could be station trouble.
Dark, poor or no picture (screen lit), good sound	<ul style="list-style-type: none"> ❑ Adjust the Picture option in the Video Menu (see page 88). ❑ Adjust the Brightness option in the Video Menu (see page 88). ❑ Check the antenna/cable connections.
No color	<ul style="list-style-type: none"> ❑ Adjust the Color option in the Video Menu (see page 88).
Only snow and noise appear on the screen	<ul style="list-style-type: none"> ❑ Check the antenna/cable connections. ❑ Try another channel; it could be station trouble. ❑ Press ANT to change the input mode (see page 47).
Dotted lines or stripes	<ul style="list-style-type: none"> ❑ Adjust the antenna. ❑ Move the LCD projection TV away from noise sources such as cars, neon signs, or hair-dryers.
Double images	<ul style="list-style-type: none"> ❑ Using a highly directional outdoor antenna or a cable may solve the problem. ❑ Set the Image Shift to an appropriate value. The default setting is Auto. If doubled images appear with Auto, select the best value from 1 to 4 (see page 105).
“Black box” on screen	<ul style="list-style-type: none"> ❑ You have selected a text option in the Setup Menu and no text is available. (See page 102 to reset Setup selections.) To turn off this feature, set the Caption Vision option to Off. If you were trying to select closed captioning, select CC1 instead of Text 1-4.
Black bands appear at the top and bottom of the screen	<ul style="list-style-type: none"> ❑ Some wide-screen programs are filmed in aspect ratios that are greater than 16:9 (this is especially common with theatrical releases). Your LCD projection TV will show these programs with black bands at the top and bottom of the screen. For more details, check the documentation that came with your DVD (or contact your program provider).
Certain programs on DVD or other digital sources display a loss of detail, especially during fast-motion or dark scenes	<ul style="list-style-type: none"> ❑ The compression used by certain digital broadcasts and DVDs may cause your LCD projection TV’s screen to display less detail than usual, or cause artifacts (small blocks or dots, pixelations) to appear on your screen. This is due to your LCD projection TV’s large screen and ability to show very fine detail, and is normal for certain digitally recorded programs. Adjust the reality/clarity in the DRC Palette menu (see page 90) to optimize the picture while viewing these sources.

Audio

Problem	Possible Remedies
Good picture, no sound	<ul style="list-style-type: none"> ❑ Press MUTING so that Muting disappears from the screen (see page 52). ❑ Make sure the Speaker option is set to On in the Audio Menu (see page 93).
Audio noise	<ul style="list-style-type: none"> ❑ Communication problems may occur if the infrared communication equipment (e.g., infrared cordless headphones) is used near the LCD projection TV. Please use headphones other than infrared cordless headphones. Also, if you use the infrared communication equipment other than infrared cordless headphones, move the infrared transceiver away from the LCD projection TV until the noise is eliminated, or move the transmitter and receiver of the infrared communication equipment closer together.
Cannot gain enough volume when using a cable box	<ul style="list-style-type: none"> ❑ Increase the volume of the cable box using the cable box's remote control. Then press FUNCTION repeatedly until the LCD projection TV indicator lights up and adjust the LCD projection TV's volume.
Sound seems weak or insufficient	<ul style="list-style-type: none"> ❑ The LCD projection TV's audio might be set to Auto SAP or Mono, when it might be better set to Stereo. In the Audio Menu (see page 93), set the MTS setting to Stereo. If already set to Stereo, switch to Mono (which may reduce background noise during weak stereo broadcasts).
Cannot raise the volume on external speakers	<ul style="list-style-type: none"> ❑ If the Speaker option is set to Off and the Audio Out option is set to Fixed (in order to output the sound to your audio system) use your audio receiver to adjust the sound (see page 93). Or, to use the LCD projection TV remote control, set the Audio Out option to Variable. ❑ To turn on the LCD projection TV speakers, set the Speaker option to On (see page 93).

Channels

Problem	Possible Remedies
Cannot receive upper channels (UHF) when using an antenna	<ul style="list-style-type: none"> ❑ Press ANT to select the VHF/UHF input (see page 47). ❑ Use Auto Program in the Channel Menu to add receivable channels that are not presently in the LCD projection TV's memory (see page 96).
TV is fixed to one channel	<ul style="list-style-type: none"> ❑ Use Auto Program in the Channel Menu to add receivable channels that are not presently in the LCD projection TV's memory (see page 96). ❑ Check your Channel Fix settings (see page 96).
Cannot receive any channels when using cable TV	<ul style="list-style-type: none"> ❑ Use Auto Program in the Channel Menu to add receivable channels that are not presently in the LCD projection TV's memory (see page 96). ❑ Press ANT to select the CABLE input (see page 47).
Cannot receive or select channels	<ul style="list-style-type: none"> ❑ Use Auto Program in the Channel Menu to add receivable TV channels that are not presently in LCD projection TV memory (see page 96).
Some digital cable channels are not being displayed	<ul style="list-style-type: none"> ❑ Certain cable companies have limitations on the broadcast of digital cable channels. Check with your cable company for more information. ❑ The digital cable channel may be set to Hide in the Digital Setup Menu (see page 62).

General

<i>Problem</i>	<i>Possible Remedies</i>
How to restore Video settings to factory settings	<ul style="list-style-type: none"> ❑ Press RESET on the remote control while in the Video Menu (see page 88).
How to restore Audio settings to factory settings	<ul style="list-style-type: none"> ❑ Press RESET on the remote control while in the Audio Menu (see page 92).
Cannot cycle through the other video equipment connected to the LCD projection TV	<ul style="list-style-type: none"> ❑ Be sure the Video Label option is not set to Skip (see page 103).
Cannot operate Menu	<ul style="list-style-type: none"> ❑ If a menu option appears in gray, this indicates that the menu option is not available.
Lost password	<ul style="list-style-type: none"> ❑ In the password screen (see page 98), enter the following master password: 4357. The master password clears your previous password; it cannot be used to temporarily unblock channels. ❑ The i.LINK STANDBY LED blinks when the signal from an i.LINK device is being shown.
The signal from a selected i.LINK device is not being displayed	<ul style="list-style-type: none"> ❑ If you have several i.LINK devices connected and operating at once, the LCD projection TV may not be able to display the signal from the selected device. Turn the other i.LINK devices off, and reselect the desired i.LINK device.

Flashing Indicators on the Front of the Monitor

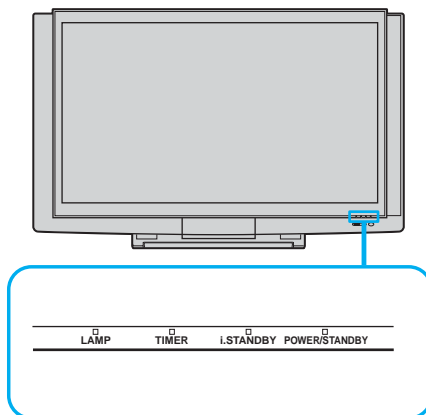

The POWER/STANDBY (green or red) and/or LAMP (red) indicators indicate the conditions of the LCD projection TV and warnings by lighting or flashing, as follows.

The POWER/STANDBY (green) indicator flashes.

- ❑ The lamp for the light source is ready to turn on.

The POWER/STANDBY (red) indicator flashes three times.

- ❑ The lamp cover is not attached securely. When you correct, the POWER/STANDBY indicator lights in red and the LCD projection TV enters the standby mode (see page 16).

The LAMP indicator flashes.

- ❑ The lamp for the light source burns out.
Replace it with new one (see page 13).

If the LCD projection TV is not recovered after correcting the problems, contact with qualified Sony personnel.

Specifications

Projection System	3 LCD Panels, 1 lens projection system	
LCD Panel	0.87 inch TFT LCD panel Approx. 3.28 million dots (1,042,168 pixels)	
Projection Lens	High Performance, large diameter hybrid lens F2.4	
Antenna	75 ohm external terminal for VHF/UHF	
Lamp	UHP lamp, 120W XL-2100U	
Television System	NTSC, American TV Standard	
Screen Size (measured diagonally)	KDF-60XBR950: 60 inches KDF-70XBR950: 70 inches	
Channel Coverage		
VHF	2-13	
UHF	14-69	
DTV	1-999	
CATV	1-125	
Power Requirements	120V, 60 Hz	
Number of Inputs/Outputs		
DVI-HDTV	1 terminal, 3.3 V T.M.D.S., 50 ohms The DVI-HDTV input terminal is compliant with the EIA-861 standard and is not intended for use with personal computers.	
Video (IN)	4	1 Vp-p, 75 ohms unbalanced, sync negative
S Video (IN)	4	Y: 1 Vp-p, 75 ohms unbalanced, sync negative C: 0.286 Vp-p (Burst signal), 75 ohms
Audio (IN)	6	500 mVrms (100% modulation) Impedance: 47 kilohms
AUDIO (VAR/FIX) OUT	1	500 mVrms at the maximum volume setting (Variable) 500 mVrms (Fixed) Impedance (output): 2 kilohms
CONTROL S (IN)	1	minijack
CONTROL S (OUT)	1	minijack
Component Video Input	2 (Y, Pb, Pr)	Y: 1.0 Vp-p, 75 ohms unbalanced, sync negative Pb: 0.7 Vp-p, 75 ohms Pr: 0.7 Vp-p, 75 ohms
RF Inputs	2	
Digital Audio Optical Output (PCM/Dolby Digital)	1	Optical Rectangular (1)
i.LINK	3 total (1 on front panel)	4-pin S400 i.LINK terminal
Speaker Output	5 W (L), 5 W (R), 20 W (Woofer)	
Dimensions (W × H × D)	KDF-60XBR950: 1,600 × 1,008 × 583 mm (63 × 39 ³ / ₄ × 23 inches) KDF-70XBR950: 1,821 × 1,143 × 647 mm (71 ³ / ₄ × 45 × 25 ¹ / ₂ inches)	

Other Information

Mass	KDF-60XBR950: 78.5 kg (173 lbs) KDF-70XBR950: 92.5 kg (204 lbs)
Power Consumption	
In Use	250 W
In Standby	Under 1 W
In i.LINK Standby	Under 20 W
Supplied Accessories	
Remote Control	RM-Y914
AA (R6) Batteries	2 supplied for remote control
Cleaning Cloth	1
Optional Accessories	
TV Stand	SU-GW3
Lamp	XL-2100U
AV Cable	VC-810S/820S/830S
Component Video Cable	VMC-10/30
i.LINK cables	VMC-IL4415 (4-pin to 4-pin, 1.5 meters); VMC-IL4435 (4-pin to 4-pin, 3.5 meters)

Design and specifications are subject to change without notice.

Index

- A**
 - Activating a Twin View screen **55**
 - Add Digital Channels **62**
 - Adding channels to the channel list **97**
 - Adjusting audio, Steady Sound **92**
 - Advanced Video **89**
 - Alternate Audio **61**
 - Alternate Video **61**
 - Antenna, connecting **25, 26**
 - Audio menu **87, 92**
 - Audio receiver, connecting **39**
 - Auto Program (channel setup) **45**
 - Auto Setup **45**
- B**
 - Balance, adjusting **92**
 - Bass, adjusting **92**
 - Batteries, inserting in remote **17**
 - Bilingual audio **93**
 - Black Corrector **90**
 - BN Smoother **90**
 - Brightness, adjusting **88**
- C**
 - Cable
 - connecting **26**
 - with VCR, connecting **32**
 - Cable box
 - connecting with VCR **33**
 - using with TV remote control **51**
 - Camcorder, connecting **42**
 - Caption Vision **102**
 - Caption Vision menu, for digital channels **62**
 - CATV. *See cable*
 - Channel menu **87, 96**
 - Channel Show/Hide **22**
 - Channel Skip/Add **97**
 - Channels
 - Auto Program **96**
 - creating labels **97**
 - setting up **45**
 - Cinema Black **91**
 - CineMotion **89**
 - Cleaning Cloth **12**
 - Clear White **90**
 - Clock/Timers **104**
 - Closed caption modes **102**
 - Color Corrector **90**
 - Color temperature, adjusting **89**
 - Color, adjusting **88**
 - Connecting
 - Audio receiver **39**
 - Cable box **32–34**
 - Cable or antenna **25**
 - Camcorder **42**
 - DVD player **40, 41**
 - Satellite receiver **36–38**
 - VCR **32–35, 37**
 - Contents of box **17**
 - CONTROL S **44**
- D**
 - Detail Enhancer **90**
 - Digital Caption Setup **62**
 - Digital Caption Setup menu **63**
 - Digital Setup menu **62**
 - Digital Signal Strength **62**
 - Digital subchannels **61**
 - DISPLAY button **47**
 - Display, turning off **47**
 - DRC (Digital Reality Creation) Mode, described **9**
 - DRC Mode **89**
 - DVD player
 - using with TV remote control **51**
 - with A/V connectors, connecting **41**
 - with component video connectors, connecting **40**
- E**
 - Enlarging pictures, in Twin View **57**
 - error messages, Memory Stick **110**
- F**
 - Favorite Channel
 - setting up **96**
 - using **54**
 - FAVORITES button **47**
 - Features **9**
 - FREEZE button **47**
 - Freeze, using **52, 58**

Front Panel Controls **21**

FUNCTION button **46**

G

Gamma Corrector **90**

GUIDE button **60**

Guide menu **61**

H

Hue, adjusting **88**

I

i.LINK **10, 80–86**

i.LINK Standby **105**

Image Shift **105**

Inputs, labeling **103**

Installation of the projection TV **25–44**

interlaced **107**

J

JUMP button **47**

Jump, using **52**

L

Label

Channels **97**

video inputs **103**

Lamp, replacing **13–16**

M

MDP, using with TV remote control **51**

Memory Stick

Duo **67**

features **64**

Index **69**

indicator (LED) **22**

inserting **66**

insertion slot **22**

panning photos **73**

photo options **72**

playing movies **74**

precautions **79**

removing **68**

rotating photos **73**

slide show options **76**

troubleshooting **109**

viewing photos **71**

zooming photos **73**

MEMORY STICK button **47**

MENU button **47**

118

Menus

Audio **87, 92**

Channel **87, 96**

Parent **87, 98**

Screen **87, 94**

Setup **87, 102**

Video **87, 88**

Mild Mode **89**

MODE

Pro **53, 88**

Standard **53, 88**

Vivid **53, 88**

MTS/SAP **93**

Muting, using **52**

N

NR **89**

P

Parental control, described **9**

Password, changing **99**

PICTURE button **46**

Picture contrast, adjusting **88**

Picture size, adjusting in Twin View **57**

POWER buttons (GREEN) **47**

POWER/STANDBY **114**

Presetting channels **45**

problems, troubleshooting **108–113**

Program Guide **60**

Program Options menu **61**

progressive **107**

R

Ratings

setting **99**

viewing blocked programs **99**

Rear panel controls and connections **23**

Remote control

Function of buttons **52**

inserting batteries **17**

programming **48**

Removing channels from the channel list **97**

RESET button **47**

Resetting

Audio options **92**

Video options **88**

S

SAT/CABLE function button **46**

SAT/CABLE power button **47**
Satellite receiver
 connecting **36**
 satellite receiver, using with TV remote control **50**
Screen menu **94**
Setting up channels **45**
Setup menu **87, 102**
Sharpness, adjusting **89**
Specifications **115–116**
Steady Sound
 adjusting **92**
Surround sound **92**

T

Timer
 set current **104**
Timer setting **104**
Treble, adjusting **92**
troubleshooting **108–113**
TV function button **46**
TV power button **47**
TV/VIDEO button **47**
Twin View™
 activating a picture **55**
 described **9**
 using **55**

V

VCR
 using with TV remote control **50**
 with cable box, connecting **33**
 with cable, connecting **32**
 with satellite receiver, connecting **37**
Video inputs, labeling **103**
Video menu **87, 88**
Video Modes, selecting **88**
Viewing area, recommended **20**
VOL +/- button **47**

W

WIDE button **46**

Z

Zoom feature, with Twin View **57**

<http://www.sony.net/>

Printed in U.S.A.