



# LCD Projection TV



Operating Instructions

**KDF-46E3000**  
**KDF-50E3000**

# BRAVIA



## Owner's Record

The model and serial numbers are provided under the Product Support in the TV menu or at the rear of the TV. Record these numbers in the spaces provided below. Refer to them whenever you call upon your Sony dealer regarding this TV.

Model Name

\_\_\_\_\_

Serial No.

\_\_\_\_\_

## WARNING

To reduce the risk of fire or electric shock, do not expose this TV to rain or moisture.



This symbol is intended to alert the user to the presence of uninsulated "dangerous voltage" within the TV's enclosure that may be of sufficient magnitude to constitute a risk of electric shock to persons.



This symbol is intended to alert the user to the presence of important operating and maintenance (servicing) instructions in the literature accompanying the TV.

The TV shall not be exposed to dripping or splashing and no objects filled with liquids, such as vases, shall be placed on the TV.

## CAUTION

To prevent electric shock, do not use this polarized AC plug with an extension cord, receptacle or other outlet unless the blades can be fully inserted to prevent blade exposure.

## Declaration of Conformity

Trade Name: SONY  
Model: KDF-46E3000/KDF-50E3000  
Responsible Party: Sony Electronics Inc.  
Address: 16530 Via Esprillo,  
San Diego, CA 92127 U.S.A.  
Telephone Number: 858-942-2230

This device complies with part 15 of the FCC rules. Operation is subject to the following two conditions: (1) This device may not cause harmful interference, and (2) this device must accept any interference received, including interference that may cause undesired operation.

## NOTIFICATION

This equipment has been tested and found to comply with the limits for a Class B digital device, pursuant to Part 15 of the FCC Rules. These limits are designed to provide reasonable protection against harmful interference in a residential installation. This equipment generates, uses and can radiate radio frequency energy and, if not installed and used in accordance with the instructions, may cause harmful interference to radio communications.

However, there is no guarantee that interference will not occur in a particular installation. If this equipment does cause harmful interference to radio or television reception, which can be determined by turning the equipment off and on, the user is encouraged to try to correct the interference by one or more of the following measures:

- Reorient or relocate the receiving antenna.
- Increase the separation between the equipment and receiver.
- Connect the equipment into an outlet on a circuit different from that to which the receiver is connected.
- Consult the dealer or an experienced radio/TV technician for help.

Pursuant to FCC regulations, you are cautioned that any changes or modifications not expressly approved in this manual could void your authority to operate this equipment.

## For Customers in Canada

This Class B digital apparatus complies with Canadian ICES-003.

## Safety

- Operate the TV only on 120 V AC.
- Use the AC power cord specified by Sony and suitable for the voltage where you use it.
- The plug is designed, for safety purposes, to fit into the wall outlet only one way. If you are unable to insert the plug fully into the outlet, contact your dealer.
- If any liquid or solid object should fall inside the cabinet, unplug the TV immediately and have it checked by qualified service personnel before operating it further.
- If you will not be using the TV for several days, disconnect the power by pulling the plug itself. Never pull on the cord.
- When disconnecting AC power cord, the power cord should be easily accessible for disconnection.
- For details concerning safety precautions, see "Important Safety Instructions" on page 4.

## Installing

- The TV should be installed near an easily accessible power outlet.
- To prevent internal heat buildup, do not block the ventilation openings.
- Do not install the TV in a hot or humid place, or in a place subject to excessive dust or mechanical vibration.
- Avoid operating the TV at temperatures below 41°F (5°C).
- If the TV is transported directly from a cold to a warm location, or if the room temperature changes suddenly, the picture may be blurred or show poor color due to moisture condensation. In this case, please wait a few hours to let the moisture evaporate before turning on the TV.
- To obtain the best picture, do not expose the screen to direct illumination or direct sunlight. It is recommended to use spot lighting directed down from the ceiling or to cover the windows that face the screen with opaque drapery. It is desirable to install the TV in a room where the floor and walls are not of a reflective material.

## To Customers

Sufficient expertise is required for installing the specified TV. Be sure to subcontract the installation to a Sony dealer or licensed contractor and pay adequate attention to safety during the installation.

## CAUTION

Use the following Sony appliance(s) only with the following TV STAND.

SONY TV STAND MODEL NO.	SONY APPLIANCE MODEL NO.	
	KDF-46E3000	KDF-50E3000
	SU-RG13M	

Use with other TV STAND may cause instability and possibly result in injury.

## Note

This television includes a QAM demodulator which should allow you to receive unscrambled digital cable television programming via subscription service to a cable service provider. Availability of digital cable television programming in your area depends on the type of programming and signal provided by your cable service provider.

## Trademark Information

Macintosh is a trademark of Apple Inc., registered in the U.S. and other countries.

HDMI, the HDMI logo and High-Definition Multimedia Interface are trademarks or registered trademarks of HDMI Licensing LLC.

Manufactured under license from Dolby Laboratories. "Dolby" and double-D symbol are trademarks of Dolby Laboratories.

Blu-ray Disc is a trademark.

"BRAVIA" and BRAVIA, BRAVIA ENGINE EX, "XMB" and "XrossMediaBar", S-Force, BRAVIA Theatre Sync, DME<sup>+</sup>, BRAVIA Internet Video Link Ready and "PS3" are trademarks or registered marks of Sony Corporation and/or Sony Computer Entertainment Inc.



# Contents

Important Safety Instructions .....	4
-------------------------------------	---

## Welcome to the World of BRAVIA™

The Four Steps to Full HD Experience: Set, Sound, Source, and Setup .....	6
Picture Quality and Aspect Ratio .....	6
TV Home Menu: XMB™ (XrossMediaBar) .....	7



## Getting Started















<b>1. Installing the TV</b> .....	<b>8</b>
Carrying Your TV .....	8
When Installing Your TV against a Wall .....	8
Securing Your TV .....	8
Recommended Viewing Area .....	9
Screen .....	9
Projection Lamp .....	9
<b>2. Locating Inputs and Outputs</b> .....	<b>10</b>
Rear .....	10
Left side .....	12
<b>3. Connecting the TV</b> .....	<b>13</b>
Cable System or VHF/UHF Antenna System .....	13
Cable System and VHF/UHF Antenna System .....	13
HD Cable Box/HD Satellite Box .....	13
PC .....	15
Other Equipment .....	16
Using HDMI Control for BRAVIA Theatre Sync™ .....	17
<b>4. Setting Up the Channel List</b> – Initial Setup .....	<b>18</b>
<b>TV Control and Indicators</b> .....	<b>19</b>
Side Panel and Indicators .....	19
<b>Remote Control</b> .....	<b>20</b>
Inserting Batteries into the Remote Control .....	20
Button Descriptions .....	20
<b>Programming the Remote Control</b> .....	<b>25</b>
Operating Sony Brand Video Equipment .....	25

Programming Non-Sony Video Equipment .....	25
---	----

<b>Using Other Equipment with Your Remote Control</b> .....	<b>27</b>
---	-----------

## Using TV Features

 <b>Adjust TV Settings</b> .....	<b>30</b>
 <b>Watching TV</b> .....	<b>30</b>
 <b>Access the equipment connected to your TV</b> .....	<b>30</b>
<b>Navigating through TV Home Menu on XMB™</b> .....	<b>31</b>

<b>TV Settings Descriptions</b> .....	<b>32</b>
 Product Support .....	32
 Clock/Timers Settings .....	32
 Picture Settings .....	32
 Sound Settings .....	34
 Screen Settings .....	35
 Video Options Settings .....	36
 Audio Options Settings .....	37
 Channel Settings .....	37
 Closed Captions (CC) Settings .....	38
 Parental Lock Settings .....	38
 External Inputs Settings .....	41
 HDMI Settings .....	41
 General Settings .....	42
 Initial Setup .....	42

## Other Information

<b>Replacing the Lamp</b> .....	<b>43</b>
How to Replace the Lamp .....	43
<b>Troubleshooting</b> .....	<b>46</b>
<b>Specifications</b> .....	<b>49</b>
<b>Index</b> .....	<b>50</b>



**Quick Setup Guide (separate volume)**  
Provides a variety of optional equipment  
connection diagrams.



**Customer Support**  
<http://www.sony.com/tvsupport>  
**On-line Registration**  
United States  
<http://productregistration.sony.com>  
Canada  
<http://www.SonyStyle.ca/registration>

# Important Safety Instructions

- 1) Read these instructions.
- 2) Keep these instructions.
- 3) Heed all warnings.
- 4) Follow all instructions.
- 5) Do not use this apparatus near water.



- 6) Clean only with dry cloth.



- 7) Do not block any ventilation openings. Install in accordance with the manufacturer's instructions.



- 8) Do not install near any heat sources such as radiators, heat registers, stoves, or other apparatus (including amplifiers) that produce heat.



- 9) Do not defeat the safety purpose of the polarized or grounding-type plug. A polarized plug has two blades with one wider than the other. A grounding type plug has two blades and a third grounding prong. The wide blade or the third prong are provided for your safety. If the provided plug does not fit into your outlet, consult an electrician for replacement of the obsolete outlet.



- 10) Protect the power cord from being walked on or pinched particularly at plugs, convenience receptacles, and the point where they exit from the apparatus.



- 11) Only use attachments/accessories specified by the manufacturer.



- 12) Use only with the cart, stand, tripod, bracket, or table specified by the manufacturer, or sold with the apparatus. When a cart is used, use caution when moving the cart/apparatus combination to avoid injury from tip-over.



- 13) Unplug this apparatus during lightning storms or when unused for long periods of time.



- 14) Refer all servicing to qualified service personnel. Servicing is required when the apparatus has been damaged in any way, such as power-supply cord or plug is damaged, liquid has been spilled or objects have fallen into the apparatus, the apparatus has been exposed to rain or moisture, does not operate normally, or has been dropped.



□ Be sure to observe the TV's "For Safety" section on page 5.

## Antennas

### Outdoor Antenna Grounding

If an outdoor antenna is installed, follow the precautions below. An outdoor antenna system should not be located in the vicinity of overhead power lines or other electric light or power circuits, or where it can come in contact with such power lines or circuits.

**WHEN INSTALLING AN OUTDOOR ANTENNA SYSTEM, EXTREME CARE SHOULD BE TAKEN TO KEEP FROM CONTACTING SUCH POWER LINES OR CIRCUITS AS CONTACT WITH THEM IS ALMOST INVARIABLY FATAL.**

Be sure the antenna system is grounded so as to provide some protection against voltage surges and built-up static charges.

Section 810 of the National Electrical Code (NEC) in USA and Section 54 of the Canadian Electrical Code in Canada provides information with respect to proper grounding of the mast and supporting structure, grounding of the lead-in wire to an antenna discharge unit, size of grounding conductors, location of antenna discharge unit, connection to grounding electrodes, and requirements for the grounding electrode.

### Antenna Grounding According to the NEC

Refer to section 54-300 of Canadian Electrical Code for Antenna Grounding.

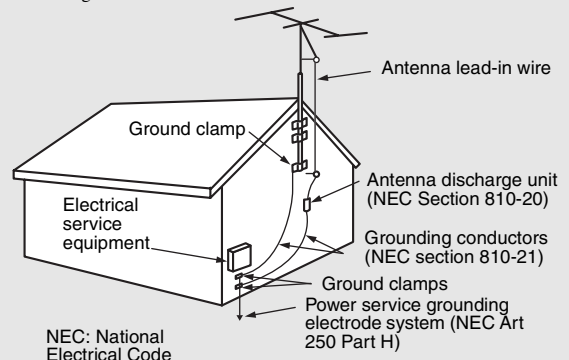

NEC: National Electrical Code

## Cleaning

- Clean the rear cover area of the TV regularly. Dust in the rear cover area may cause a problem with the cooling system of the TV set.
- Clean the cabinet of the TV with a dry soft cloth. To remove dust from the screen, wipe it gently with a soft cloth. Stubborn stains may be removed with a cloth slightly dampened with solution of mild soap and warm water. Never use strong solvents such as thinner or benzine for cleaning. If the picture becomes dark after using the TV for a long period of time, it may be necessary to clean the inside of the TV. Consult qualified service personnel.
- Unplug the AC power cord when cleaning this unit. Cleaning this unit with a plugged AC power cord may result in electric shock.



## On Contamination on the Screen Surface

The screen surface has a special coating to reduce reflections. To prevent screen damage, clean the screen as follows:

- Clean the screen with a soft cloth.
- To remove hard contamination, use a cloth moistened with a solution of mild detergent and water. Do not spray cleaning solution directly onto the TV. It should only be sprayed to moisten the cleaning cloth.
- Do not use any type of abrasive pad, alkaline cleaner, acid cleaner, scouring powder, chemical cloth, or solvent such as alcohol, benzene or thinner, as these may scratch the screen's coating.

## Service

### Damage Requiring Service

Do not attempt to service the set by yourself since opening the cabinet may expose you to dangerous voltage or other hazards.

Unplug the set from the wall outlet and refer servicing to qualified service personnel.



## Replacement Parts

When replacement parts are required, be sure the service technician certifies in writing that he has used replacement parts specified by the manufacturer that have the same characteristics as the original parts.

Unauthorized substitutions may result in fire, electric shock or other hazards.

See "Replacing the Lamp" on page 43.

## For Safety

### Be Careful When Moving the TV

When you place the TV in position, be careful not to drop it on your foot or fingers.

Watch your footing while installing the TV.

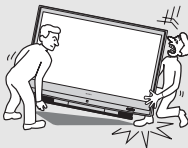

### Carry the TV in the Specified Manner

If you carry the TV in a manner other than the specified manner and without the specified number of persons, it may drop and a serious injury may be caused. Be sure to follow the instructions mentioned below.

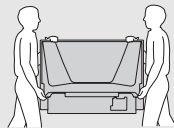

- Carry the TV with the specified number of persons (see page 8).
- Hold the TV tightly when carrying it.
- Before carrying the TV, disconnect any accessories or cables.

## About the TV

Although the TV is made with high-precision technology, black dots may appear or bright points of light (red, blue, or green) may appear constantly on the screen. This is a structural property of the panel and is not a defect.

## Installation

- If direct sunlight or other strong illumination shines on the screen, part of the screen may appear white due to reflections from behind the screen. This is a structural property of the TV. Do not expose the screen to direct illumination or direct sunlight.
- The picture quality may be affected by your viewing position. For the best picture quality, install your TV according to "Recommended Viewing Area" on page 9.
- When installing your TV against a wall, keep it at least 4 inches (10 cm) away from the wall.

## Projection Lamp

- Your TV uses a projection lamp as its light source. It is time to replace the lamp with a new one (not supplied) when:
  - the message, "Projection lamp is nearing end of life. Please replace the lamp." appeared on the screen,
  - the lamp replacement indicator on the front panel blinks in red,
  - screen images become dark,
  - no image appears on the display after prolonged use.
- In rare instances, the bulb may pop inside the lamp unit, but the lamp unit is designed to contain all of broken glass pieces inside the lamp unit. (See "Replacing the Lamp" on page 43.)
- When the lamp eventually burns out, you may hear a noticeable pop sound. This is normal and is inherent in this type of lamp.

## Cooling Fans

This TV uses cooling fans. You may hear the noise of fans running, depending on the placement of your TV. The noise may be more noticeable during the night or when the background noise level is low.

## Disposal of Used Batteries

To preserve our environment, dispose of used batteries according to your local laws or regulations.

## For Customers in the United States

Lamp in this product contains mercury. Disposal of these materials may be regulated due to environmental considerations. For disposal or recycling information, please contact your local authorities or the Electronic Industries Alliance ([www.eiae.org](http://www.eiae.org)).

# Welcome to the World of BRAVIA™

Thank you for purchasing this Sony BRAVIA™ high-definition television. The quality of the image you see on your BRAVIA TV is only as good as the quality of the signal it receives. To experience the stunning detail of your new BRAVIA TV, you need access to HD programming. Your BRAVIA TV can receive and display HD programming from:

- Over-the-air broadcasting via HD-quality antenna
- HD cable subscription
- HD satellite subscription
- Blu-ray Disc™ player or other external equipment

Contact your cable or satellite provider for information on upgrading to HD programming.

**To learn more about HDTV, visit: <http://www.sony.com/HDTV>**

## The Four Steps to Full HD Experience: Set, Sound, Source, and Setup

Along with your BRAVIA TV **set**, a complete HD system requires an HD **sound** system, a **source** of HD programming and proper **setup** connections. This manual explains basic setup connections (see page 13). The Quick Setup Guide, enclosed separately, illustrates how to connect other optional equipment.

## Picture Quality and Aspect Ratio

You can enjoy crisp, clear images, smooth movement and high-impact visuals from 1080 HD signals. When you compare a high-definition signal to a standard analog signal, you will notice a big difference. The 1080 HD signals provide more than twice the vertical resolution of the standard TV signal.

High-definition and standard-definition signals are transmitted with different aspect ratios (the width-to-height ratio of the image). HDTV uses a wider screen than conventional standard-definition TV.



### 16:9 (high-definition) source

Most HDTV signals use a widescreen aspect ratio of 16:9. 16:9 fills your BRAVIA screen, maintaining a crisp, clear, vivid picture.

### 4:3 (standard-definition) source

Most standard-definition signals use a boxy 4:3 aspect ratio. When a 4:3 image is displayed on an HDTV, you will see black bars on the sides. The picture quality may not be as sharp as with HD sources.



- You can use the **Wide Mode** function of the TV to adjust the 4:3 image to fit the entire screen (see pages 23, 35 and 36).

## TV Home Menu: XMB™ (XrossMediaBar)

The **XMB™** is a menu of BRAVIA features and input sources displayed on the TV screen. The **XMB™** is an easy way to select programming and adjust settings on your BRAVIA TV. Press the **HOME** button on your remote control to access the **XMB™**.

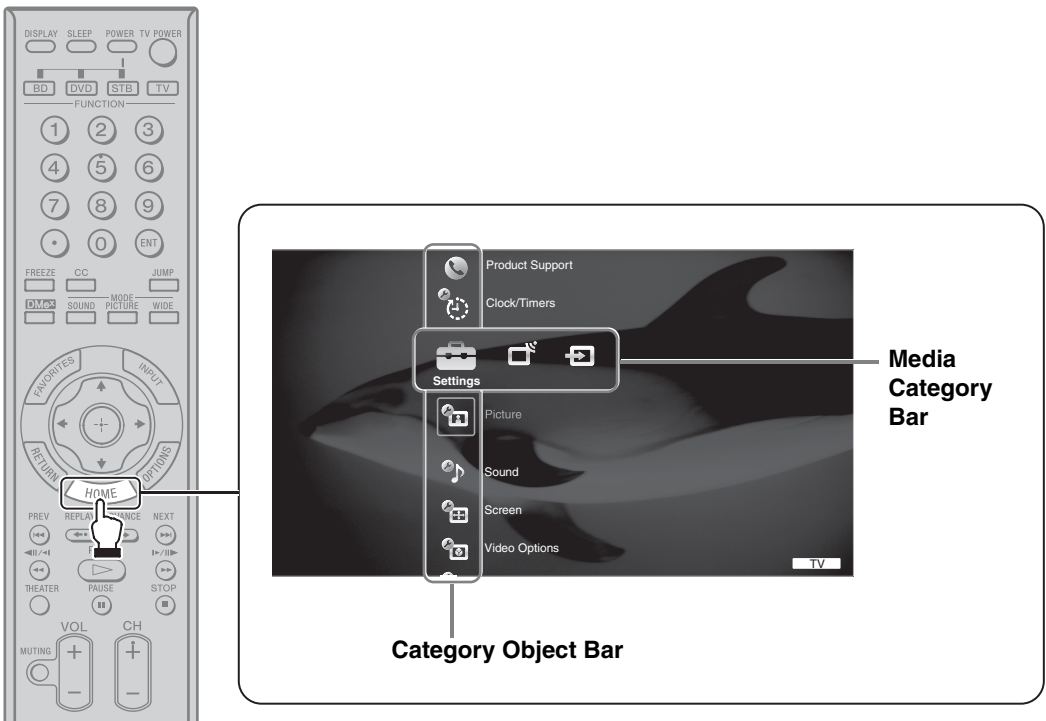

From the horizontal Media Category Bar you can control:

- **Settings:** timer, picture, sound, screen and other options (see page 32 for customization options).
- **TV Channels:** available channels are displayed on the vertical Category Object Bar.
- **External Inputs:** cable, satellite, VCR, DVD players or other inputs can also be selected from the Category Object Bar for the **External Inputs**.

# Getting Started

## 1. Installing the TV

### Carrying Your TV

Carrying the TV requires at least two people. Do not hold by the pedestal or the front panel of the TV. Doing so may cause these parts to break off.

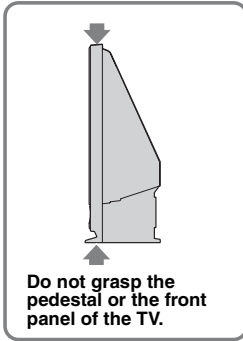

When moving the TV, place one hand in the hole on the lower portion of the TV while grasping the top with the other hand, as shown in the illustration below.

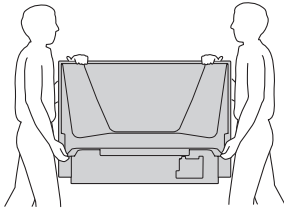

If you have connected cables and cords, be sure to unplug them before moving the TV.

To ensure the safety of children and the TV, keep children away from the TV during installation. Climbing on or pushing the TV or its stand may cause it to fall and may damage the TV.

### When Installing Your TV against a Wall

Keep your TV at least 4 inches (10 cm) away from the wall to provide proper ventilation. Blocking the ventilation opening of the cooling fan may damage the TV.

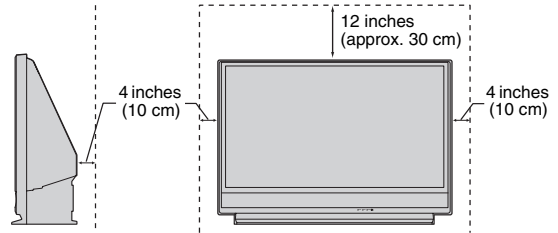

Never install the TV as follows:

Air blown into cooling fan. Air circulation is blocked.

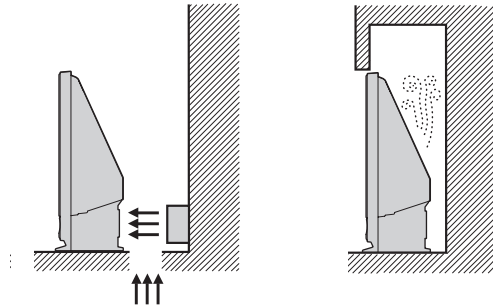

- Do not install the TV near any ventilation, as it may affect the normal TV operating temperature.

### Securing Your TV

As a protective measure, secure the TV as follows.

#### Using the TV stand with a support metal safety hook

Sony strongly recommends using the TV stand SU-RG13M with a support metal safety hook designed for your TV.

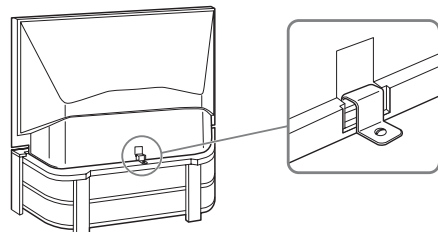

- When using the SU-RG13M stand for your TV, you must use the support metal safety hook.



## Recommended Viewing Area

Your viewing position may affect the picture quality.

For the best picture quality, install your TV within the areas shown below.

Model	Viewing distance
KDF-46E3000	min. 5.9 ft. (approx. 1.8 m)
KDF-50E3000	min. 6.6 ft. (approx. 2.0 m)

Horizontal Viewing Area

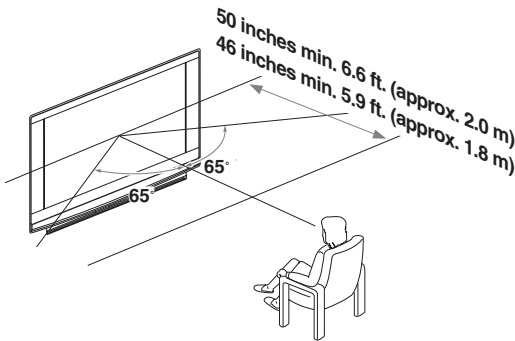

Vertical Viewing Area

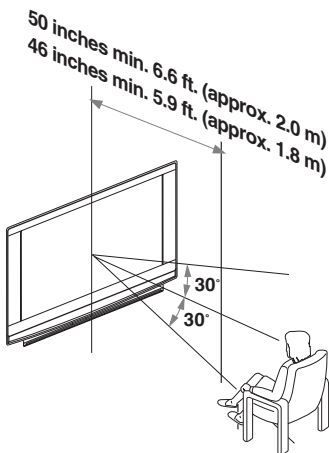

## Screen

To minimize reflection, the screen surface has a special coating.

Inappropriate cleaning methods could damage the screen surface. Special care is required.

### Cleaning the Screen Surface

Dust and dirt on the screen can affect the picture quality. To dust off the screen use a soft cloth. Be sure to follow the cleaning instruction on page 5 for stubborn stains and dirt.

### Temporary Image Retention

When high contrast non-moving images such as station logos and channel numbers are displayed for a long period of time, there may be some image retention on the screen. This is only a temporary condition. Turning off the power for a while or letting the TV run on another channel will eliminate the image retention.

## Projection Lamp

Your TV uses a projection lamp as its light source. As with any lamp, it has a lifespan and needs to be replaced when the Lamp Indicator flashes or the screen becomes darker. Your TV also has a function to display a message, "Projection lamp is nearing end of life. Please replace the lamp." to let you know that the lamp has reached its expected lifespan. Note the following:

- After turning on your TV, it may take a while (one minute or less) before the picture appears.
- When the projection lamp wears out, the screen goes dark. Replace the lamp with a new Sony XL-2500 replacement lamp (not supplied).
- After lamp is replaced, please set the **Lamp Replacement** option in the **General** settings (see page 42).

"How to Replace the Lamp", see page 43.



- The light emitted from the lamp is quite bright when your TV is in use. To avoid eye discomfort or injury, do not look into the light housing when the power is on.

## 2. Locating Inputs and Outputs

### Rear

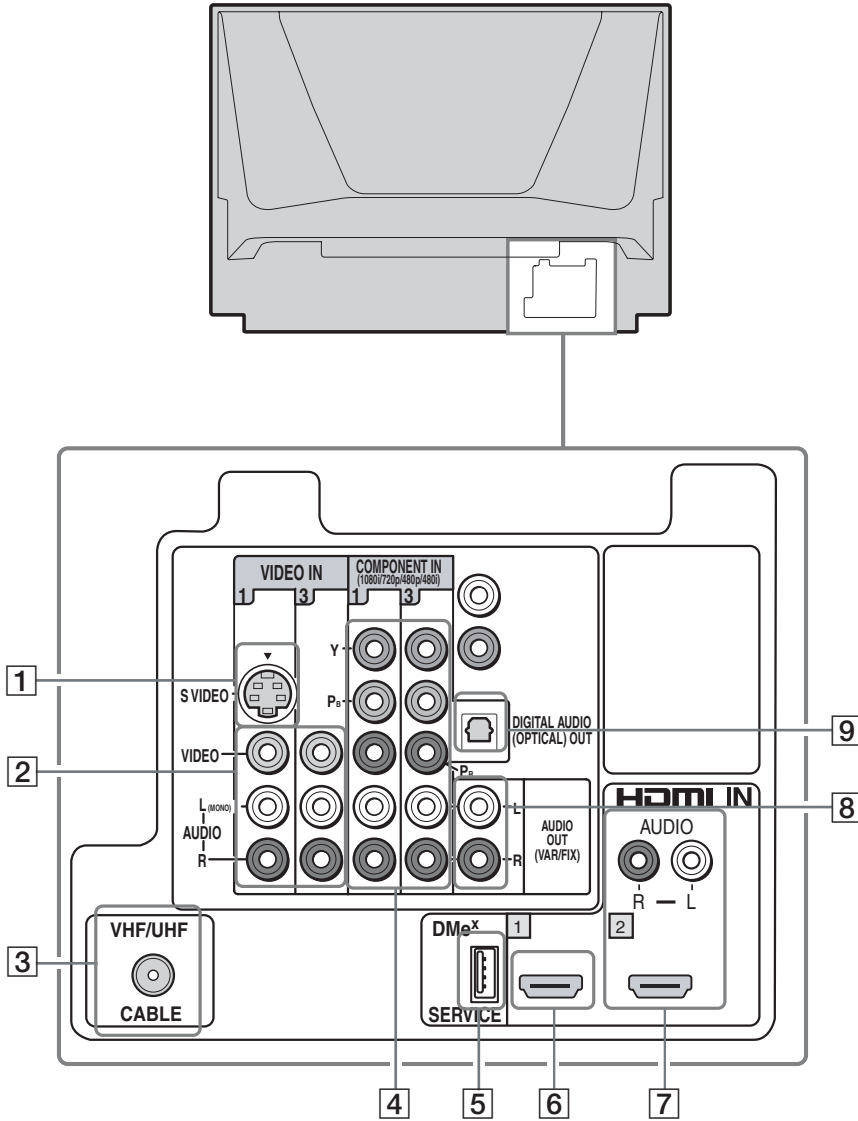

Item	Description
1 VIDEO IN 1 S VIDEO	Connects to the S VIDEO output jack of your VCR or other video equipment that has S VIDEO. The S VIDEO provides better picture quality than composite video.
2 VIDEO IN 1/3 VIDEO/ L(MONO)- AUDIO-R	Connects to the composite video and audio output jacks on your A/V equipment such as a VCR or other video equipment. A third composite video and audio (VIDEO IN 2) is located on the left side of the TV.
3 VHF/UHF/CABLE	RF input that connects to your Cable or VHF/UHF antenna.
4 COMPONENT IN 1/3 (1080i/720p/ 480p/480i)/ L(MONO)-AUDIO- R	Connects to your equipment's component video (Y/Pb/Pr) and audio (L/R) jacks. Component video provides better picture quality than the S VIDEO or the composite video connections.
5 DMe <sup>x</sup> /SERVICE	This USB port is for connecting to the optional BRAVIA external module (DMe <sup>x</sup> ) or used for service purpose only.
6 HDMI IN 1 HDMI	HDMI (High-Definition Multimedia Interface) provides an uncompressed, all-digital audio/video interface between this TV and any HDMI-equipped audio/video equipment, such as a set-top box, DVD player, Blu-ray Disc player, A/V receiver as well as PC. HDMI supports enhanced, or high-definition video, plus digital audio.
7 HDMI IN 2 HDMI/ AUDIO R-L	If the equipment has a DVI jack and not an HDMI jack, connect the DVI jack to the HDMI IN 2 (with DVI-to-HDMI cable or adapter) jack, and connect the audio jack to the AUDIO IN(L/R) jacks of HDMI IN 2.

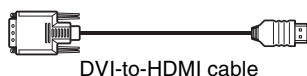

DVI-to-HDMI cable



DVI-to-HDMI adapter



Audio cable





- HDMI connection has capability for displaying 480i, 480p, 720p, 1080i, 1080p and some PC formats (see page 15).
- When using a DVI-to-HDMI cable, make sure to connect the DVI side first.
- Be sure to use only an HDMI cable that bears the HDMI logo.

8 AUDIO OUT (VAR/FIX)	Connects to the left and right audio input jacks of your analog audio equipment. You can use these outputs to listen to your TV's audio through your stereo system.
9 DIGITAL AUDIO (OPTICAL) OUT	Connects to the optical audio input of your digital audio equipment that is PCM/Dolby <sup>*</sup> digital compatible. If you have connected an audio system to the HDMI input, be sure to connect this output to your audio system to enjoy the sound from your audio system.

\* Manufactured under license from Dolby Laboratories. "Dolby" and the double-D symbol are trademarks of Dolby Laboratories.

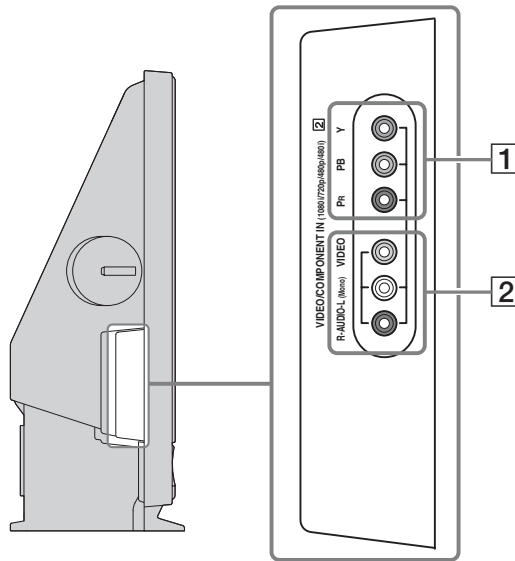
**Left side**



Item	Description
<p><b>1 COMPONENT IN 2 (1080i/720p/480p/480i)/YPbPr</b></p> <p></p> <ul style="list-style-type: none"> <li>When connecting to component video (YPbPr), be sure to make the additional connection for the audio signal. Audio cable can be connected to the R-AUDIO-L jack described below <b>2</b>.</li> </ul>	<p>Connects to your equipment's component video (YPbPr) and audio (L/R) jacks. Component video provides better picture quality than the composite video connections. (See <b>Video/Component 2 Priority</b> on page 41.)</p>
<p><b>2 VIDEO IN 2 VIDEO/ R-AUDIO-L (MONO)</b></p> <p></p> <ul style="list-style-type: none"> <li>If you have mono equipment, connect its audio output jack to the TV's L (MONO) audio input jack.</li> </ul>	<p>Connects to the composite video and audio output jacks on your camcorder or other video equipment such as a VCR or video game equipment. (See <b>Video/Component 2 Priority</b> on page 41.)</p>

### 3. Connecting the TV

#### Cable System or VHF/UHF Antenna System

You can enjoy high-definition and standard-definition digital programming (if available in your area) along with standard-definition analog programming.



- This TV is capable of receiving unscrambled digital programming for both cable (QAM and 8VSB) and external VHF/UHF antenna (ATSC).
- It is strongly recommended that you connect the antenna/cable input using the supplied 75-ohm coaxial cable to receive optimum picture quality. A 300-ohm twin lead cable can be easily affected by radio frequency interference, resulting in signal deterioration.

#### Cable or VHF/UHF (or VHF only)

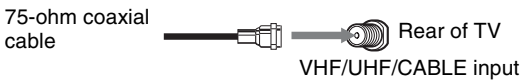

#### Cable System and VHF/UHF Antenna System

Use an optional A-B RF switch (not supplied) to switch between the cable and over-the-air antenna programming, as indicated below.

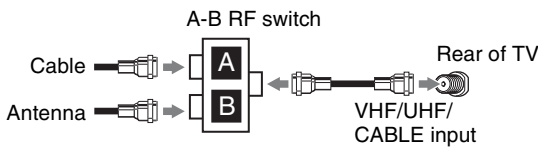

- Be sure to set the **Cable** setting to **On** or **Off** in the **Channel** settings for the type of input signal you choose (see page 37).

#### HD Cable Box/HD Satellite Box

You can also enjoy high-definition programming by subscribing to a high-definition cable service or a high-definition satellite service. For the best possible picture, make sure you connect this equipment to your TV via the HDMI or component video (with audio) input on the back of your TV.

#### Shown with HDMI Connection

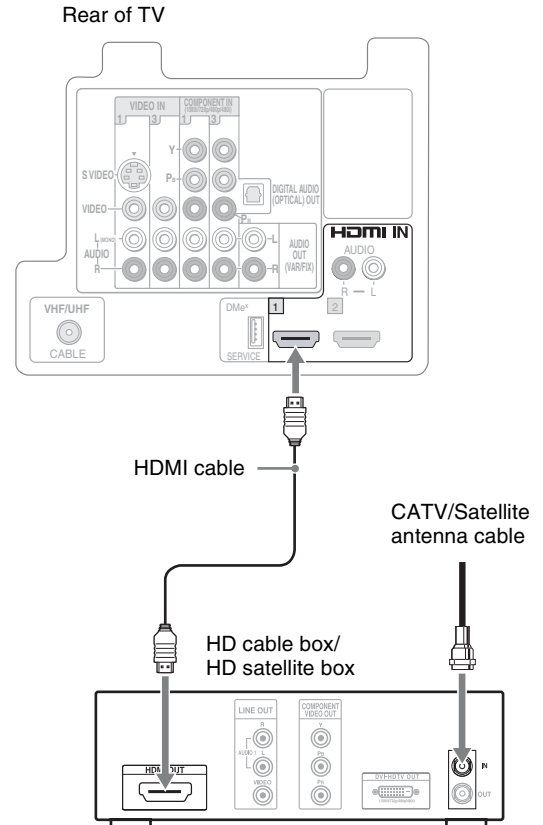

(Continued)

## Shown with DVI Connection

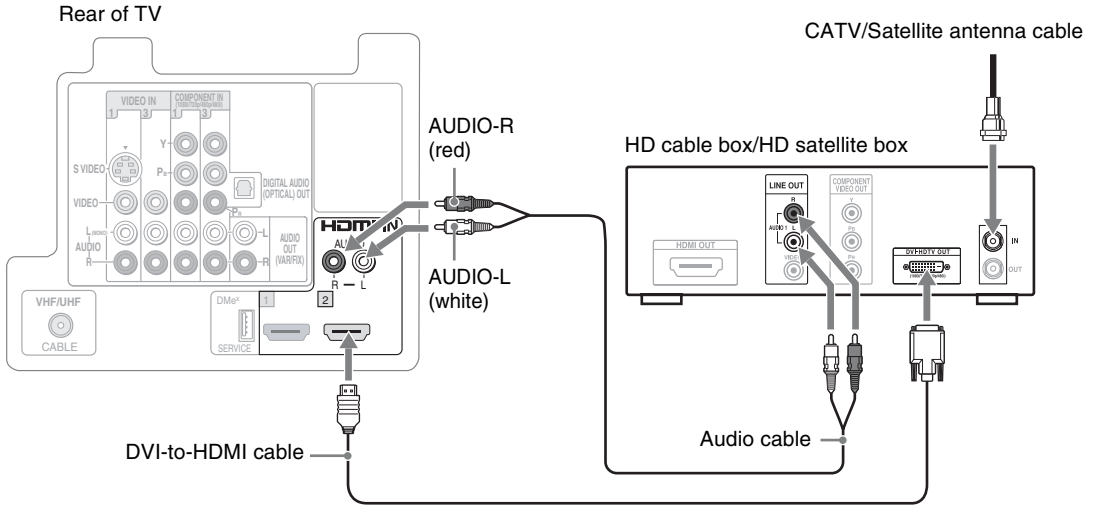

If the equipment has a DVI jack and not an HDMI jack, connect the DVI jack to the HDMI IN 2 (with DVI-to-HDMI cable or adapter) jack and connect the audio jack to the AUDIO IN(L/R) jacks of HDMI IN 2. For details, see page 11.

## Shown with Component Connection

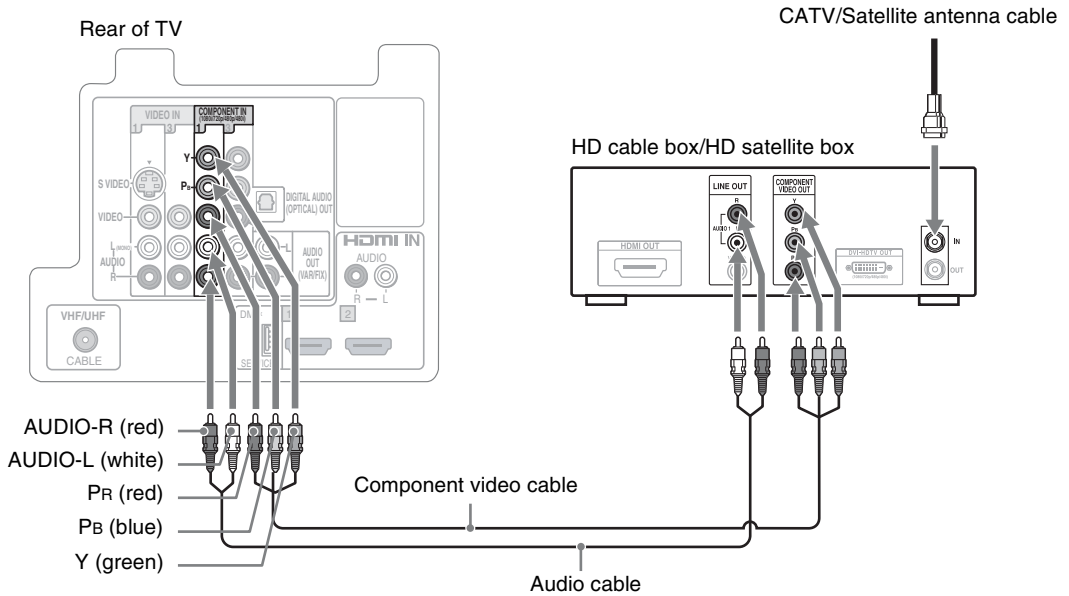

Use the TV as a monitor for your PC.

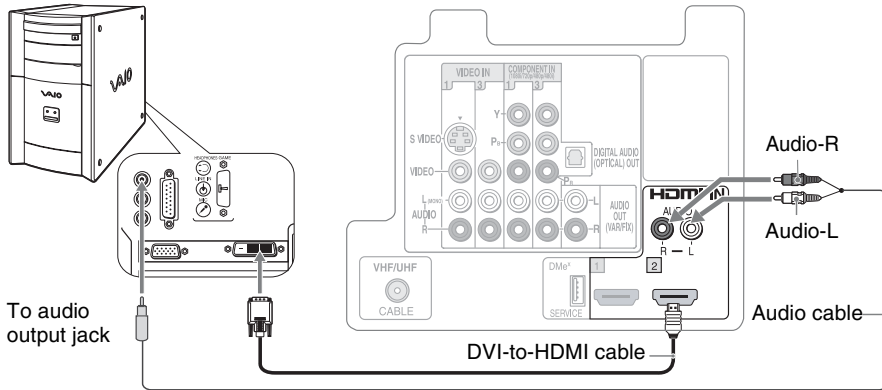

### PC Input Signal Reference Chart

After connecting the PC to the TV, set the output signal from the PC according to the chart below.

<i>Resolution Signals</i>	<i>Horizontal (Dot)</i>	<i>x</i>	<i>Vertical (Line)</i>	<i>Horizontal frequency (kHz)</i>	<i>Vertical frequency (Hz) (Refresh rate)</i>	<i>VESA standard</i>
VGA	<b>640</b>	<b>x</b>	<b>480</b>	<b>31.5</b>	<b>60</b>	—*
	640	x	480	37.5	75	✓
	640	x	480	43.3	85	✓
	720	x	400	31.5	70	—*
SVGA	800	x	600	35.2	56	✓
	<b>800</b>	<b>x</b>	<b>600</b>	<b>37.9</b>	<b>60</b>	✓
	800	x	600	46.9	75	✓
	800	x	600	48.1	72	✓
XGA	<b>1024</b>	<b>x</b>	<b>768</b>	<b>48.4</b>	<b>60</b>	✓
	1024	x	768	56.5	70	✓
	1024	x	768	60	75	✓
WXGA	<b>1280</b>	<b>x</b>	<b>768</b>	<b>47.4</b>	<b>60</b>	✓
	<b>1280</b>	<b>x</b>	<b>768</b>	<b>47.8</b>	<b>60</b>	✓
	<b>1152</b>	<b>x</b>	<b>648</b>	<b>40.3</b>	<b>60</b>	CVT**

\*: Corresponding to the VGA signal.

\*\* : Coordinated Video Timing.



- If a signal other than one from the above chart is input, it may not be displayed properly or may not be displayed as you set.
- For the best picture quality, it is recommended to use signals with a 60 Hz vertical frequency from a personal computer. In plug and play, signals with 60 Hz vertical frequency will be selected automatically.
- Noise may be detected under certain conditions. If unsupported signals are used, you will see the message, “Unsupported Signal”.

## Other Equipment

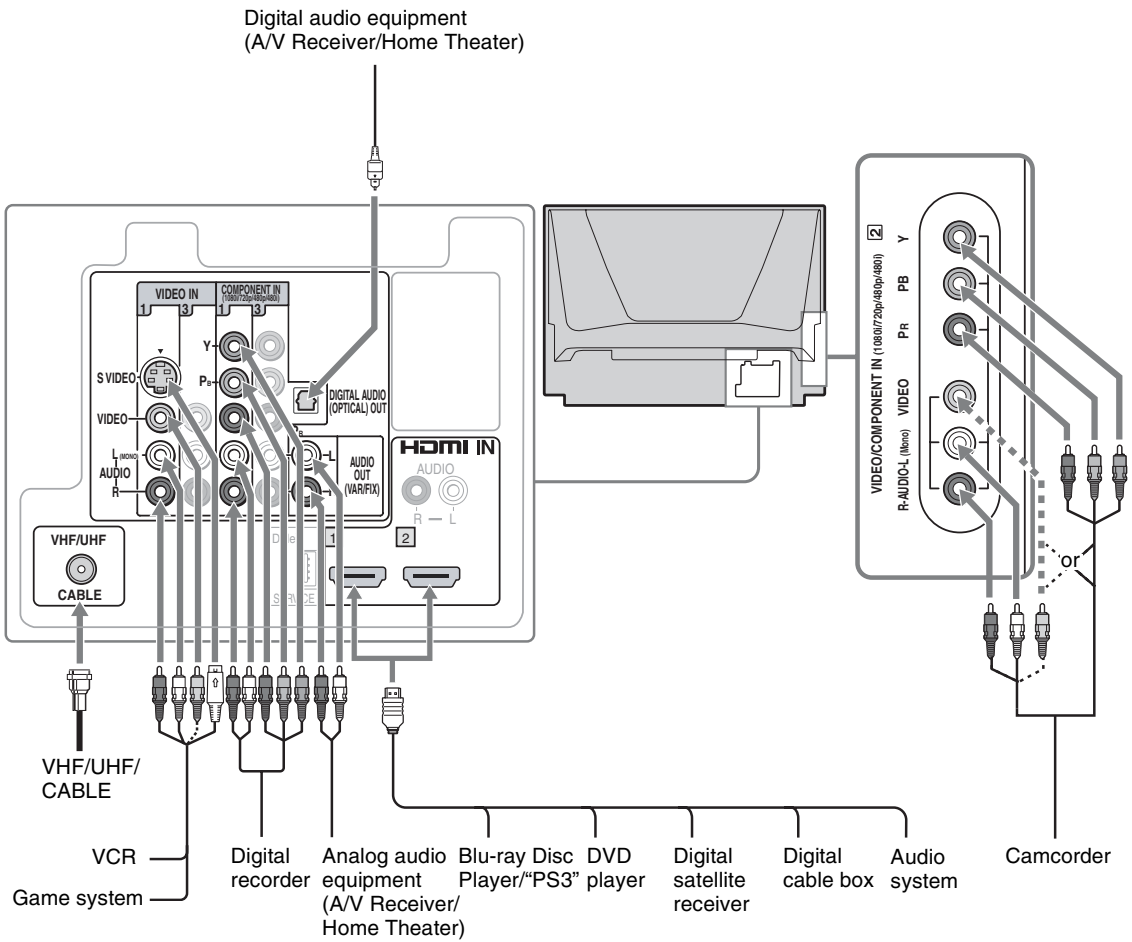

- Refer to the Quick Setup Guide (supplied) when connecting other equipment to your TV.



## Using HDMI Control for BRAVIA Theatre Sync™

This TV is equipped with BRAVIA Theatre Sync. The **HDMI Control** function enables BRAVIA Theatre Sync to allow communication between Sony TV's and Sony equipment. Only Sony equipment with **HDMI Control** capability is supported.

### To connect HDMI Control equipment

Use an HDMI cable that bears the HDMI logo for connection. See pages 13 to 16 or see the HDMI connection shown in the Quick Setup Guide provided with the TV documentation.

### Setting the HDMI Control

In order for the **HDMI Control** function to operate, the TV and other Sony **HDMI Control** equipment must be setup. See page 41 on how to turn the **HDMI Control On**. For other equipment, refer to the operating instructions for that equipment.

### HDMI Control available with your TV:

Once the supported equipment is connected, the following operations are available:

- Turn off the equipment automatically when you turn off the TV.
- When the connected equipment is turned on by One-Touch-Play, the TV will automatically turn on and select the respective HDMI input.
- Automatically turn on equipment listed under the **External Inputs** on the **XMB™** (XrossMediaBar) when selected, see pages 7 and 30.

When a Sony A/V receiver with BRAVIA Theatre Sync is connected, the following additional operations are possible:

- Turning on the A/V receiver when the TV is turned on.
- Automatically switching to the audio output of the A/V receiver's attached speakers.
- Adjusting the volume and muting of the A/V receiver with the TV's remote control.



- The A/V receiver cannot be selected from the **XMB™**.

## 4. Setting Up the Channel List – Initial Setup

The **Initial Setup** screen appears when you turn on the TV for the first time.

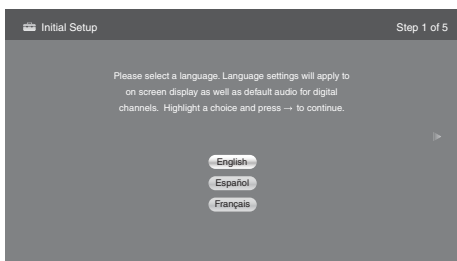

After you finish connecting the TV, you can run **Initial Setup** to create a list of available analog and digital channels if you have connected an antenna or cable directly to the TV's VHF/UHF/CABLE input.

You will be prompted to select the language of your choice to be used for all the on screen settings.

Use the remote control to navigate through the **Initial Setup**:

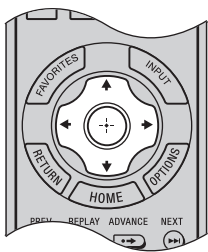

**↑/↓ button:**  
Allows you to highlight options where applicable.

**⊕ button:**  
Allows you to select the highlighted option and advance to the next screen.

**← button:**  
Allows you to move back to the previous screen.

**→ button:**  
Allows you to move to the next screen.

Follow the help text provided on the screen to run **Auto Program** with the connected signal source or select **Skip** to skip the **Auto Program** if you are receiving channels from a cable box or satellite receiver and the VHF/UHF/CABLE input is not connected. The **Auto Program** will scan for available channels. When the **Auto Program** is completed, the TV will display how many analog and digital channels are found.



- If you accidentally turn off the TV during the **Initial Setup** process, the **Initial Setup** will restart from the beginning when the TV is turned back on.
- The **Auto Program** may be canceled while the channels are being scanned. Press **RETURN** first, then press either **←/→** on the remote control, highlight “Yes” to cancel or “No” to resume the **Auto Program**.

### ☐ To Run Initial Setup Again or Auto Program Again at a Later Time

Select the **Initial Setup** feature from the **XMB™** (XrossMediaBar) or refer to the **Initial Setup** described on page 42. To run **Auto Program**, see page 37.

### ☐ To Add Digital Channels

Use the **Add Digital Channels** feature as described on page 38. (Useful for antenna installations.)

### ☐ To Display the Picture in Your Preferred Aspect Ratio

Select the proper **Wide Mode** as described on pages 23 and 35.



You may want to set up convenient features such as **Favorites** (see page 21), **Show/Hide Channels** (page 38), **Edit Channel Labels** (page 38) when **Auto Program** is completed.

# TV Control and Indicators

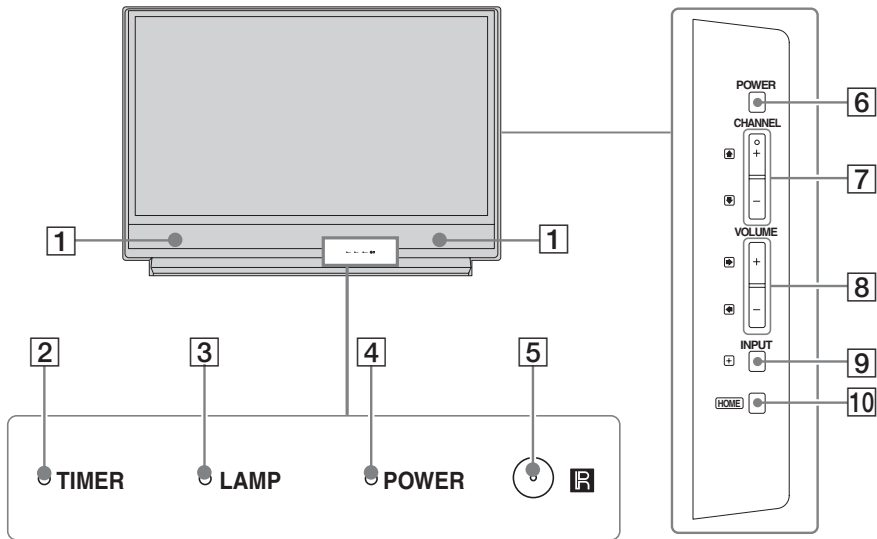
## Side Panel and Indicators



Buttons located at the right side of the TV will operate the same as these buttons on the remote control.

Item	Description
1 <b>Speaker</b>	Outputs the audio signal.
2 <b>TIMER LED</b>	Lights up in orange when the timer is set. When the timer is set, this LED will remain lit even if the TV is turned off. For details, see page 32.
3 <b>LAMP LED</b>	The projection lamp has burned out. Replace it with new one (see page 43).
4 <b>POWER LED</b>	Lights up in green when the TV is turned on. Also lights up in red during the diagnostics.
5 <b>(IR) Infrared Receiver</b>	Receives IR signals from the remote control. Do not put anything near the sensor, as its function may be affected.
6 <b>POWER</b>	Press to turn on and off the TV.
7 <b>CHANNEL +/-</b>	Press to scan through channels. To scan quickly through channels, press and hold down either +/-.
8 <b>VOLUME +/-</b>	Press to adjust the volume.
9 <b>INPUT</b>	Press to display the list of <b>External Inputs</b> and TV mode. Press repeatedly to toggle through the inputs. 
10 <b>HOME</b>	Press to display the <b>TV Home Menu/XMB™</b> (XrossMediaBar) to access the <b>TV Home Menu</b> items such as the TV <b>Settings</b> , TV channels and <b>External Inputs</b> list (see pages 7 and 30). 

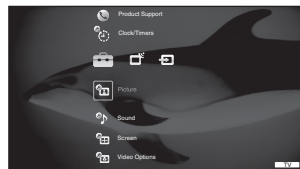

- While **XMB™** is displayed, the [7], [8] and [9] become navigational buttons. Use them to navigate on the **XMB™**. When **HOME** is pressed again, these buttons will activate the **CHANNEL +/-**, **VOLUME +/-** and **INPUT** operation.

# Remote Control

## Inserting Batteries into the Remote Control

Insert two size AA batteries (supplied) by matching  $\oplus$  and  $\ominus$  on the batteries to the diagram inside the battery compartment of the remote control.

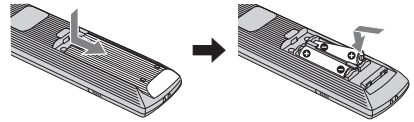

- To avoid possible damage from battery leakage, remove the batteries if you anticipate the remote control will not be used for an extended period.
- Handle the remote control with care. Avoid dropping it, getting it wet, or placing it in direct sunlight, near a heater, or in high humidity.

## Button Descriptions



Button	Description
<b>1 DISPLAY</b>	Press once to display the information pertaining to the channel and/or program when available. The OSD (On Screen Display) will time out in a few seconds or press again to immediately turn off the display. You can also set the display to show minimal information. See <b>Info Banner</b> on page 42.
<b>2 SLEEP</b>	Press repeatedly until the TV displays the time in minutes ( <b>Off</b> , <b>15min</b> , <b>30min</b> , <b>45min</b> , <b>60min</b> , <b>90min</b> or <b>120min</b> ) that you want the TV to remain on before shutting off. To cancel <b>Sleep Timer</b> , press <b>SLEEP</b> repeatedly until <b>Off</b> appears.
<b>3 FUNCTION Buttons</b>	The <b>FUNCTION</b> button indicator lights up momentarily when pressed to show which external equipment the remote control is operating. When the remote control is set to operate the external equipment, these buttons will operate the equipment you choose. You must first press one of these <b>FUNCTION</b> buttons to operate the corresponding equipment. See page 25 for "Programming the Remote Control".
<b>4 0-9 ENT</b>	Press <b>0-9</b> to select a channel; the channel changes after two seconds. Press <b>ENT</b> to change channels immediately.
<b>5</b> 	Use with <b>0-9</b> and <b>ENT</b> to select digital channels. For example, to enter 2.1, press <b>2</b> , <b>.</b> , <b>1</b> and <b>ENT</b> .



- The **5**, **PLAY** and **CH +** buttons have a tactile dot. Use them as a reference when operating the TV.

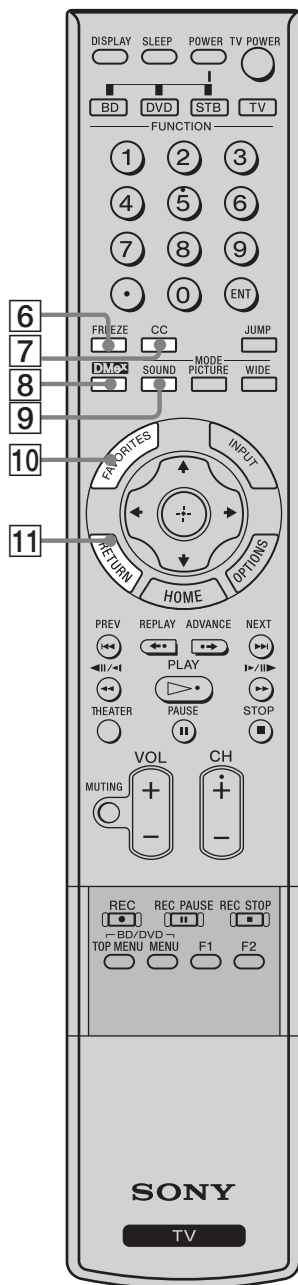

Button	Description
<b>6</b> FREEZE	Press once to display the frozen image of the current program in the left window. The window on the right will display the current program in progress. Press again to return to the program. <div data-bbox="661 281 1243 485" data-label="Image"> </div> <ul style="list-style-type: none"> <li>With the <b>Freeze</b> feature active, some features are unavailable.</li> <li>While the <b>Freeze</b> feature is active, pressing <b>HOME</b> will deactivate the <b>Freeze</b> and display the <b>XMB™</b>.</li> </ul>
<b>7</b> CC	Press to turn on and off the Closed Captions (CC). To change or customize the <b>CC Display</b> , see page 38.
<b>8</b> DMe <sup>x</sup>	Press to access features in the optional BRAVIA external module (e.g. DMX-NV1). See your dealer or <a href="http://www.sony.com/bravia">www.sony.com/bravia</a> for more information. The module may not be available in your region.
<b>9</b> SOUND	Press to cycle through different sound settings: <b>Dynamic</b> for enhanced treble and bass, <b>Standard</b> for spoken dialog and <b>Custom</b> for flat setting.
<b>10</b> FAVORITES	Press once to display the stored favorite channel list. You can store up to 30 channels in your <b>Favorites</b> list. <p><b>How to Add to Favorites</b></p> While tuned to the channel you want to add to the list, press <b>OPTIONS</b> and highlight “Add to Favorites”, then press (+). A confirmation message of “Channel added to Favorites” will appear for a few seconds. <p><b>How to Remove from Favorites</b></p> While tuned to a channel that exists in the <b>Favorites</b> list, press <b>OPTIONS</b> and highlight “Remove from Favorites”, then press (+). A confirmation message of “Channel removed from Favorites” will appear for a few seconds. <ul style="list-style-type: none"> <li>Your <b>Favorites</b> list will be cleared each time you run <b>Auto Program</b> (see pages 18 and 37 for <b>Auto Program</b>).</li> </ul>
<b>11</b> RETURN	Press to go back to the previous screen or exit from the screen when displaying menu items and settings.

(Continued)

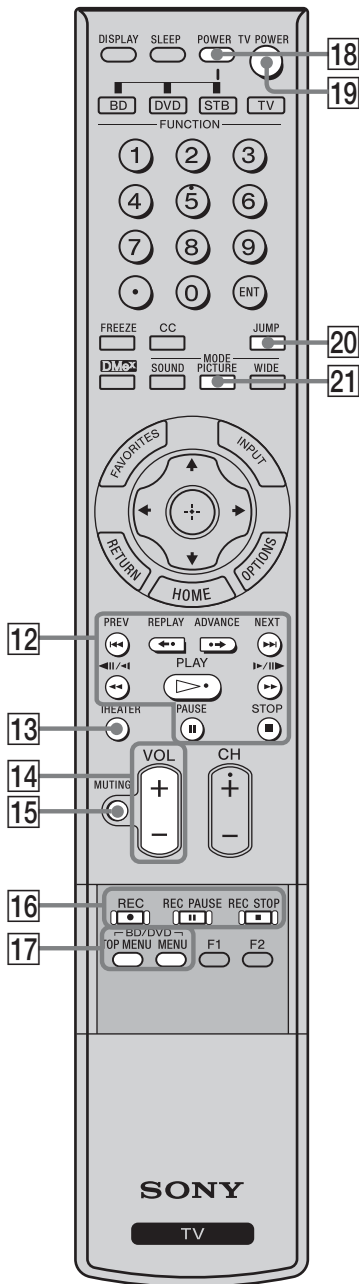

Button	Description
<b>12</b> <b>BD/DVD/STB Operating Buttons</b>	When <b>FUNCTION</b> is switched on BD (Blu-ray Disc), DVD or STB, these buttons operate the video equipment you have programmed into the remote control. For details, see “Using Other Equipment with Your Remote Control” on page 27.
<b>13</b> <b>THEATER</b>	Press to turn on and off the <b>Theater Mode</b> . The picture settings will be set for a cinema-like experience* and the audio will be switched to the audio output of the attached speakers of your BRAVIA Theatre Sync audio system. Your BRAVIA Theatre Sync audio system must be connected by an HDMI connection to your TV (see page 17 for details).
<b>14</b> <b>VOL +/-</b>	Press to adjust the volume.
<b>15</b> <b>MUTING</b>	Press to mute the sound. Press again or press <b>VOL +</b> to restore the sound.
<b>16</b> <b>DVD/VCR Record Buttons</b>	<ul style="list-style-type: none"> <li>● <b>REC</b>: Press to record. Pressing this button alone starts the recording process.</li> <li>⏸ <b>REC PAUSE</b>: Press to pause the recording.</li> <li>■ <b>REC STOP</b>: Press to stop the recording.</li> </ul>
<b>17</b> <b>BD/DVD TOP MENU/MENU</b>	Press to display the top menu or menu of the connected equipment. <ul style="list-style-type: none"> <li>✍ For more information, refer to the operating manual of the connected equipment.</li> </ul>
<b>18</b> <b>POWER</b>	Press to turn on/off the external equipment selected from the <b>FUNCTION</b> buttons <b>[3]</b> .
<b>19</b> <b>TV POWER</b>	Press to turn on and off the TV.
<b>20</b> <b>JUMP</b>	Press to jump back and forth between two channels. The TV alternates between the current channel and the last channel that was selected. <div style="text-align: center;"> </div>
<b>21</b> <b>PICTURE</b>	Press repeatedly to cycle through the available picture modes: <b>Vivid</b> , <b>Standard</b> , <b>Cinema</b> . The picture modes can also be accessed in the <b>Picture</b> settings. For details, see <b>Picture</b> settings on page 32.

\* Effectiveness will depend on the source.

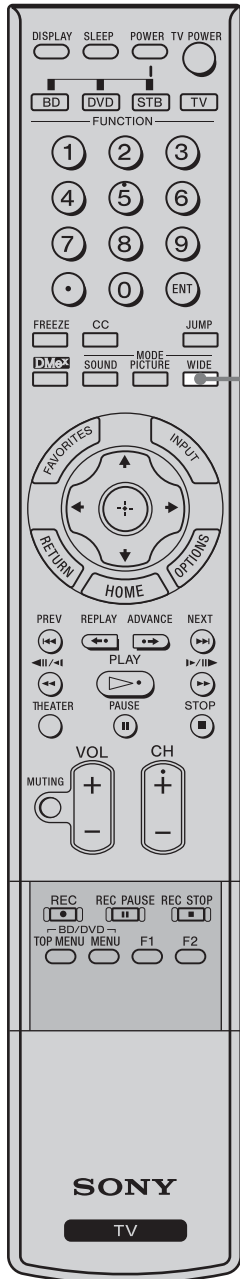

Button	Description
--------	-------------

**22 WIDE**

Press repeatedly to step through the **Wide Mode** settings: **Wide Zoom, Normal, Full, Zoom**. The **Wide Mode** settings can be also accessed in the **Screen** settings (see page 35). When selecting **Wide Mode** for images from external equipment, see page 35.

### Changing the Wide Screen Mode

(For PC signal, see below)

4:3 Original source Standard-definition source	16:9 Original source High-definition source
<b>Wide Zoom</b> 	<b>Wide Zoom</b> 
<b>Normal</b> 	<b>Normal</b> This mode is not available
<b>Full</b> 	<b>Full</b> 
<b>Zoom</b> 	<b>Zoom</b> 



- When the TV receives a 720p, 1080i or 1080p signal, **Normal** cannot be selected.

### Changing the Wide Screen Mode for PC Signal Format

Incoming PC signal Less than 16:9 PC format	Incoming PC signal 16:9 or more than 16:9 PC format
<b>Normal</b> (May not be available at some formats) 	<b>Normal</b> (May not be available at some formats) 
<b>Full 1</b> 	<b>Full 1</b> 
<b>Full 2</b> 	<b>Full 2</b> 
<b>Zoom</b> 	<b>Zoom</b> 

(Continued)

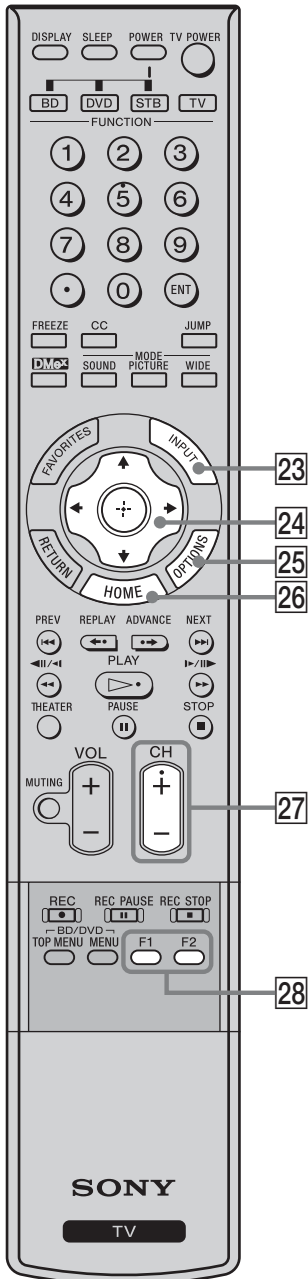

Button	Description
--------	-------------

**23 INPUT** Press to display the list of **External Inputs** and TV mode. Press repeatedly to toggle through the inputs.



- See page 41 on setting up the **External Inputs** labels, including the **Skip** feature.

**24**  $\oplus$  Press to move the on screen cursor. Press  $\oplus$  to select/confirm an item.

**25 OPTIONS** Press to display a list of convenient functions and menu shortcuts. The **OPTIONS** menu items vary based on input and content.

Menu Item	Reference Page
Picture	See page 32
Sound	See page 34
Speakers	See page 37
Add to Favorites/ Remove from Favorites	See page 21
MTS	See page 37
Alternate Audio	See page 37
Digital Rating	See page 39
Screen	See page 35

**26 HOME** Press to display the **TV Home Menu/XMB™** (XrossMediaBar) to access the **TV Home Menu** items such as the **TV Settings**, **TV channels** and **External Inputs** list (see pages 7 and 30).

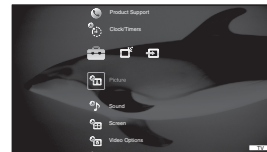

Press **HOME** again to exit the **XMB™**.

**27 CH +/-** Press to scan through channels. To scan quickly through channels, press and hold down either **+/-**.

**28 F1/F2** Press to select the function of connected components. For details, see “Using Other Equipment with Your Remote Control” on page 27.



## Programming the Remote Control

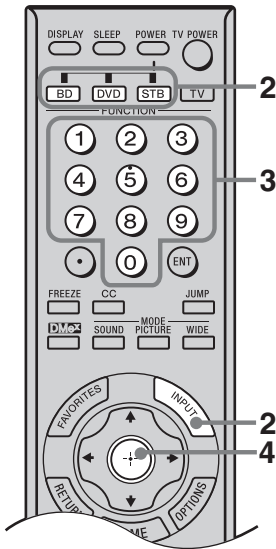

### Operating Sony Brand Video Equipment

The remote control is preset as below so that you may not need to program the remote control.

Sony Equipment	Programmable Code Number
BD	101 (Sony Blu-ray Disc Player)
DVD	751 (Sony DVD Player)
STB	801 (Sony Satellite Receiver)

### Programming Non-Sony Video Equipment

Follow the steps below to program your TV's remote control.

- In the space provided below, write down the three-digit code of your equipment found on the Manufacturer's Codes List on page 26.  
If more than one code is listed, try entering the code listed first.  
Code No. \_\_\_\_\_
- Press and hold **[BD]**, **[DVD]** or **[STB]** and **[INPUT]** simultaneously to light the **FUNCTION** button.
- Enter the three-digit code using **[0]**-**[9]** while the selected button is lit. If the code is not entered within 10 seconds, you must repeat step 2.

- Press **[+]** while the **FUNCTION** button is lit. If programmed correctly the selected **FUNCTION** button blinks twice. If not it blinks five times.

### To Confirm the Programming

If you can turn on and off the equipment by pressing the green **[POWER]** button, then the programming is complete. If not, try the next code listed.



- In some cases, you may not be able to program your remote control. If this is the case, use your equipment's own remote control.
- Any one of the **FUNCTION** buttons can be programmed to operate other equipment regardless of the labeling. For example, if programmed with the correct code, **[DVD]** can operate DVD/VCR combo equipment. This is useful if your equipment does not match the labeled buttons available. Make note of your equipment's programmed button.
- You may program one equipment per **FUNCTION** button.

## Manufacturer's Codes

### DVD Players

Manufacturer	Code
Sony	751, 763
General Electric/ RCA	755
Hitachi	758
JVC	756
Magnavox	757
Mitsubishi	761
Oritron	759
Panasonic	753
Philips	757
Pioneer	752, 778
RCA/PROSCAN	755
Samsung	758
Toshiba	754
Zenith	760, 762

### DVD/VCR Combo Units

Manufacturer	Code
Sony	767
Broksonic	776
JVC	775
Panasonic	777
Samsung	774
Toshiba	773
Zenith	768

### HDD/DVD Combo Units

Manufacturer	Code
Sony	770, 771, 772

### DVD Changers

Manufacturer	Code
Sony	765
Panasonic	766

### DVR

Manufacturer	Code
Sony	901
DirecTV	902, 903
Samsung	902, 903

### Blu-ray Disc Player (BD)

Manufacturer	Code
Sony	101, 102, 103

### 5.1ch DVD AV System

Manufacturer	Code
Sony (DAV)	601, 602, 603, 604

### AV Receivers

Manufacturer	Code
Sony	764

## VCRs

Manufacturer	Code
Sony	301, 302, 303 (VHS, 8mm, Beta)
Sony DV	348
Admiral (M. Ward)	327
Aiwa*	338, 344
Audio Dynamic	314, 337
Broksonic	317, 319
Canon	308, 309
Citizen	332
Craig	302, 332
Curtis Mathes	304, 309, 338
Daewoo	309, 312, 341
DBX	314, 336, 337
Dimensia	304
Emerson	316, 317, 318, 319, 320, 341
Fisher	330, 335
Funai	338
General Electric	304, 309, 329
Go Video	322, 339, 340
Goldstar	332
Hitachi	304, 305, 306, 338
Instant Replay	308, 309
JC Penney	304, 305, 309, 314, 330, 336, 337
JVC	314, 336, 337, 345, 346, 347
Kenwood	314, 332, 336, 337
LG	332
LXI (SEARS)	305, 330, 332, 335, 338
Magnavox	308, 309, 310
Marantz	314, 336, 337
Marta	332
Memorex	309, 335
Minolta	304, 305
Mitsubishi/MGA	323, 324, 325, 326
Multitech	321, 325, 338
NEC	314, 336, 337
Olympic	308, 309
Optimus	327
Orion	317
Panasonic	306, 307, 308, 309
Pentax	304, 305
Philco	308, 309
Philips	308, 309, 310
Pioneer	308
Quasar	306, 308, 309
RCA/PROSCAN	304, 305, 308, 309, 310, 311, 312, 313, 329
Realistic	309, 324, 328, 330, 335, 338
Sansui	314
Samsung	313, 321, 322
Sanyo	330, 335
Scott	312, 313, 321, 323, 324, 325, 326, 335
Sharp	327, 328

Manufacturer	Code
Signature 2000 (M. Ward)	327, 338
SV2000	338
Sylvania	308, 309, 310, 338
Symphonic	338
Tashiro	332
Tatung	314, 336, 337
Teac	314, 336, 337, 338
Technics	308, 309
Toshiba	311, 312
Wards	327, 328, 331, 332, 335
Yamaha	314, 330, 336, 337
Zenith	331

### Cable Boxes

Manufacturer	Code
Sony	230
Hamlin/Regal	222, 223, 224, 225, 226
Jerrold, General	201, 202, 203, 204, 205, 206, 207, 208,
Instrument or Motorola	218, 222
Oak	227, 228, 229
Panasonic	219, 220, 221
Pioneer	211, 214, 215
Scientific Atlanta	209, 210, 211
Tocom	216, 217
Zenith	212, 213

### Satellite Receivers

Manufacturer	Code
Sony	801
DirecTV	902, 903
Dish Network	810
EchoStar	810
General Electric	802
Hitachi	805
Hughes	804
Humax	902, 903
JVC	810
LG	902, 903
Mitsubishi	809
Panasonic	803
Philips	811, 902, 903
RCA/PROSCAN	802, 808, 902, 903
Toshiba	806, 807
Samsung	812, 902, 903

\* If an Aiwa VCR does not work even though you enter the code for Aiwa, enter the code for Sony instead.

## Using Other Equipment with Your Remote Control

Make sure that the equipment is programmed on the remote control (page 25).

Press **INPUT** repeatedly until you find your connected equipment. Remote control tips are provided below.





- Equipment marked with an (\*) below may not necessarily be activated by the suggested button if it has been programmed with another **FUNCTION** button.
- Use the remote control supplied with your connected equipment if a function cannot be operated.

### Cable Box

To Do This ...	Press ...
Activate the remote control to operate the cable box	<b>STB (FUNCTION)</b>
Turn on/off	<b>POWER</b>
Select a channel	<b>0-9, ENT</b>
Change channels	<b>CH +/-</b>
Back to previous channel	<b>JUMP</b>

### Satellite Receiver

To Do This ...	Press ...
Activate the remote control to operate the satellite receiver	<b>STB (FUNCTION)</b>
Turn on/off	<b>POWER</b>
Select a channel	<b>0-9, ENT, </b>
Change channels	<b>CH +/-</b>
Back to previous channel	<b>JUMP</b>
Display channel number	<b>DISPLAY</b>
Display SAT Guide	<b>OPTIONS</b>
Display SAT Menu	<b>HOME</b>
Move highlight (cursor)	<b>↑ ↓ ← →</b>
Select item	<b></b>

### VCR\*

To Do This ...	Press ...
Activate the remote control to operate the VCR	<b>STB (FUNCTION)</b>
Turn on/off	<b>POWER</b>
INPUT SELECT	<b>INPUT</b>
Select a channel	<b>0-9, ENT</b>
Change channels	<b>CH +/-</b>
Record	<b>●</b>
Play	<b>▷</b>
Stop	<b>■</b>
Fast forward	<b>▶▶</b>
Rewind the tape	<b>◀◀</b>
Pause	<b>  </b> (press again to resume normal playback)

### DVD Player or DVD Changer

To Do This ...	Press ...
Activate the remote control to operate the DVD	<b>DVD (FUNCTION)</b>
Turn on/off	<b>POWER</b>
If you have a DVD changer, to skip disc	<b>F1</b>
Play	<b>▷</b>
Stop	<b>■</b>
Pause	<b>  </b> (press again to resume normal playback)
Step through different tracks of the disc	<b>◀◀</b> to fast reverse or <b>▶▶</b> to fast forward the disc when pressed during playback
Step through different chapters of the disc	<b>▶▶ </b> to step forward or <b>◀◀ </b> to step backward
Select a track directly	<b>0-9, ENT</b>
Display the disc menu or top menu	<b>BD/DVD MENU</b> or <b>TOP MENU</b>
Operate the DVD menu	<b>↑ ↓ ← →, </b>
Display the system MENU	<b>HOME</b>
Return	<b>RETURN</b>

(Continued)

## Blu-ray Disc Player (BD)

To Do This ...	Press ...
Activate the remote control to operate the Blu-ray Disc Player	<b>BD (FUNCTION)</b>
Turn on/off	<b>POWER</b>
Play	
Stop	
Pause	<b>II</b> (press again to resume normal playback)
Step through different tracks of the disc	<b>◀◀</b> to fast reverse or <b>▶▶</b> to fast forward the disc when pressed during playback
Display the POP UP menu (BD)	<b>BD/DVD MENU</b>
Display the disc menu (DVD)	<b>BD/DVD MENU</b>
Display the top menu (BD)	<b>BD/DVD TOP MENU</b>
Display the top menu (DVD)	<b>BD/DVD TOP MENU</b>
Operate the menu	<b>↑ ↓ ← →</b> ,
MENU on/off	<b>HOME</b>
Specify the previous chapter/track	<b>◀◀</b>
Specify the next chapter/track	<b>▶▶</b>
Return to the previous display	<b>RETURN</b>

### 5.1ch DVD AV System (Sony DAV)

To Do This ...	Press ...
Activate the remote control to operate the DVD	<b>DVD (FUNCTION)</b>
Turn on/off	<b>POWER</b>
Select other equipment connected to the DAV	<b>F1</b>
Disk skip	<b>F2</b>
Display the disc menu or top menu	<b>BD/DVD MENU</b> or <b>TOP MENU</b>
Select a track directly	<b>0-9, ENT</b>
Play	
Stop	
Pause	<b>II</b>
Search the picture forward or backward	<b>▶▶</b> or <b>◀◀</b> during playback
Specify the previous chapter/track	<b>◀◀</b>
Specify the next chapter/track	<b>▶▶</b>
Move highlight (cursor)	<b>↑ ↓ ← →</b>
Select item	
Master volume	<b>VOL +/-, MUTING</b>

## DVD/VCR Combo Unit

To Do This ...	Press ...
Activate the remote control to operate the DVD/VCR	<b>DVD (FUNCTION)</b>
Turn on/off	<b>POWER</b>
Select the DVD	<b>F 1</b>
Select the VCR	<b>F 2</b>
Display the disc menu or top menu	<b>BD/DVD MENU</b> or <b>TOP MENU</b>
Play	
Stop	
Pause	<b>II</b>
Search the picture forward or backward	<b>▶▶</b> or <b>◀◀</b> during playback
Move highlight (cursor) and select (DVD)	<b>↑ ↓ ← →</b> ,
Record (VCR)	
Change channels (VCR)	<b>CH +/-</b> or <b>0-9, ENT</b> (using tuner)
Adjust tracking (VCR)	<b>CH +/-</b> (during tape playback)
Index search	<b>◀◀ ▶▶</b>
INPUT SELECT	<b>INPUT</b>
Menu on/off	<b>HOME</b>

## HDD/DVD Combo Unit

To Do This ...	Press ...
Activate the remote control to operate the DVD/HDD	<b>DVD (FUNCTION)</b>
Turn on/off	<b>POWER</b>
Select the HDD	<b>F 1</b>
Select the DVD	<b>F 2</b>
Play	
Stop	
Pause	<b>II</b>
Search the picture forward or backward	<b>▶▶</b> or <b>◀◀</b> during playback
Move highlight (cursor) and select	<b>↑ ↓ ← →</b> ,
Record	
Record stop	
Record pause	<b>II</b>
Specify the previous chapter/track	<b>◀◀</b>
Specify the next chapter/track	<b>▶▶</b>
Replay	<b>←•</b>
Advance	<b>•→</b>
Display the disc menu or top menu	<b>BD/DVD MENU</b> or <b>TOP MENU</b>
INPUT SELECT	<b>INPUT</b>
MENU on/off	<b>HOME</b>
Search DVD by title or chapter	<b>OPTIONS</b>
Return to the previous display	<b>RETURN</b>

**AV Receiver\***

To Do This ...	Press ...
Activate the remote control to operate the AV Receiver	<b>STB (FUNCTION)</b>
Turn on/off	<b>POWER</b>
Master volume	<b>VOL +/-, MUTING</b>
Select other input connected to AV receiver	<b>F1</b>

**DVR\***

To Do This ...	Press ...
Activate the remote control to operate the DVR	<b>DVD (FUNCTION)</b>
Turn on/off	<b>POWER</b>
Play	
Replay the current program for a set period of time	<b>◀• (REPLAY)</b>
Advance forward a set period of time when playing back a recorded program	<b>•➔ (ADVANCE)</b>
Specify the previous chapter mark	<b>◀◀ (PREV)</b>
Specify the next chapter mark	<b>▶▶ (NEXT)</b>
Stop	<b>■</b>
Pause	<b>  </b>
Record	<b>●</b>
Open the Favorites List	<b>FAVORITES</b>
Open the Guide	<b>OPTIONS</b>
Open Main Menu	<b>HOME</b>
Move highlight (cursor)	<b>↑ ↓ ← →</b>
Select item	<b>⊕</b>
Close on-screen display	<b>RETURN</b>
Page +/-	<b>CH +/-</b>
Open the RECORDINGS List	<b>TOP MENU</b>

# Using TV Features

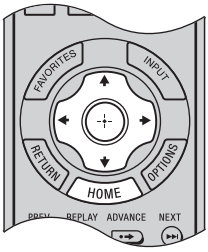

The **HOME** button allows you to access the **TV Home Menu** on the **XMB™** (XrossMediaBar) as well as a variety of TV features.

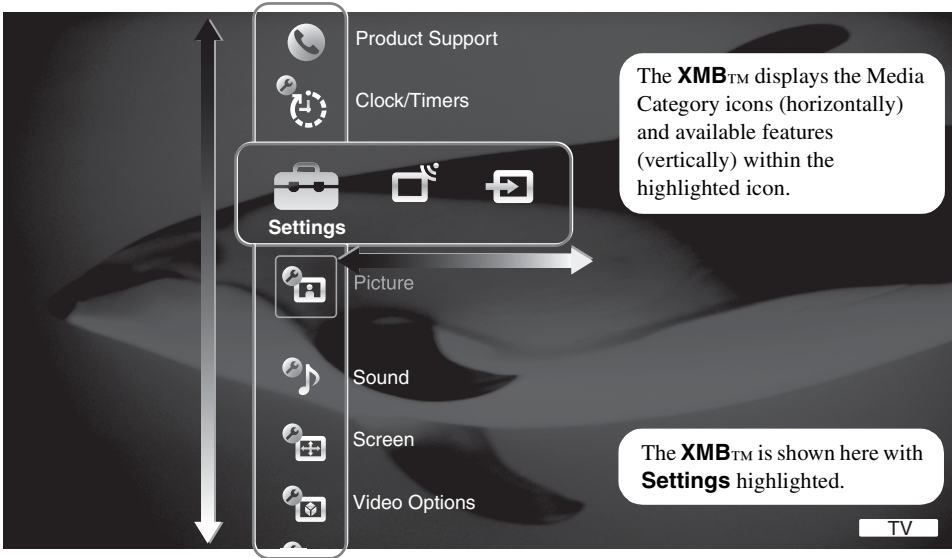

The **XMB™** displays the Media Category icons (horizontally) and available features (vertically) within the highlighted icon.

The **XMB™** is shown here with **Settings** highlighted.

## Media Category Icons



### Adjust TV Settings

Customize the TV settings with various options.

Explanations of different **Settings** start from page 32.

- The available options vary depending on the situations and conditions applied. Unavailable options are grayed out or not displayed.



### Watching TV

Select a channel.

- You can also select a TV channel using the number **0-9** or **CH+/-** buttons (see remote control section pages 20 and 24).



### Access the equipment connected to your TV

Watch a movie, play a game, record a program or work on your PC.

Assign a label using the **Label Inputs** feature for your convenience, see page 41.

# Navigating through TV Home Menu on XMB™

1  Press **HOME** to display the **XMB™**.

2  Press **←/→** to select a Media Category icon.





Available TV settings and features are listed under the **Settings** icon.

Available channels are listed under the **TV** icon.

Select inputs from **Video1**, **Video/Component 2**, **Video 3**, **Component 1, 3**, **HDMI 1, 2** under the **External Inputs** icon.

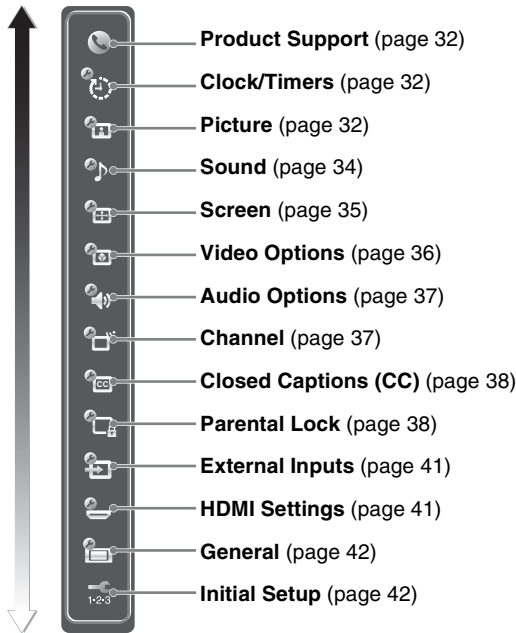
3  Press **↑/↓** to move within the Category Object Bar.  
(The Category Object Bar shown below is for the **Settings**.)



4  Press **⏏** when desired item is highlighted.

5  Press **⏏** or **↑/↓** to select the highlighted item.

6  Press **RETURN** or **HOME** to exit.



# TV Settings Descriptions



## Product Support

---

<b>Contact Sony</b>	Sony contact information is available from this screen for your convenience. Your TV's specific information such as Model Name, Serial Number, Software Version and downloadable ratings if available from the TV are displayed here.
<b>Signal Diagnostics</b>	Press  to display the diagnostics information for the current signal.

---



## Clock/Timers Settings

---

<b>Current Time</b>	<p>Sets the current time (day, hour, minutes, and AM/PM). The <b>Timer</b> feature will not be available until you set the <b>Current Time</b>.</p> <ol style="list-style-type: none"><li>1 Use the  button to highlight the <b>Clock/Timers</b> icon and press .</li><li>2 Use the  button to set the current time.</li><li>3 Press <b>RETURN</b> to display the confirmation screen.</li><li>4 Select <b>Yes</b> or <b>No</b> to save changes you made. Selecting <b>Yes</b> will save your settings and exit the <b>Current Time</b> setting screen.</li></ol>
<b>Timer</b>	<p>After the <b>Current Time</b> is set, you can set the <b>Timer</b> to automatically turn the TV on and off and tune to a specific channel at a scheduled time.</p> <ol style="list-style-type: none"><li>1 Use the  button to highlight the <b>Timer</b> icon and press .</li><li>2 Press  to select <b>On</b> to set the timer.</li><li>3 Use the  button to set the following: <b>Day of the Week</b>, <b>Time</b>, <b>Duration</b>, <b>Channel</b>, and <b>Volume</b>.</li><li>4 Press <b>RETURN</b> to display the confirmation screen.</li><li>5 Select <b>Yes</b> or <b>No</b> to save changes you made. Selecting <b>Yes</b> will save your settings and will light up the TIMER LED.</li><li>6 Exit the <b>Timer</b> setting screen.</li></ol>
<b>Sleep Timer</b>	Sets the time in minutes ( <b>Off</b> , <b>15min</b> , <b>30min</b> , <b>45min</b> , <b>60min</b> , <b>90min</b> , or <b>120min</b> ) that you want the TV to remain on before shutting off automatically. This can also be set using the <b>SLEEP</b> button on the remote control (see page 20).

---



## Picture Settings

---

<b>Picture Mode</b>	<b>Vivid</b>	For enhanced picture contrast and sharpness.
	<b>Standard</b>	For standard picture settings. Recommended for home entertainment.
	<b>Cinema</b>	For viewing film-based content. Most suitable for viewing in a theater-like environment.

---





• **Picture Mode** can also be accessed by pressing **PICTURE** on the remote control to directly toggle the modes.

---

<b>Reset</b>	Resets the current <b>Picture Mode</b> setting to the default values.
--------------	---

---



<b>Advanced Iris</b>	By selecting the iris option, you can obtain the best brightness and contrast suited for your TV viewing.																					
<b>Auto 1, 2</b>	Automatically detects the brightness of the screen. These options are best suited for programs such as movies that often change between bright scenes and low light setting scenes. <b>Auto 1:</b> Recommended option for viewing programs that have larger variation in brightness from scene to scene. <b>Auto 2:</b> Recommended option for viewing programs that have less variation in brightness from scene to scene.																					
<b>High</b>	With this option, the screen has maximum level of brightness. It is suitable for TV viewing in a brightly lit room.																					
<b>Medium</b>	With this option, the brightness is about the standard level.																					
<b>Low</b>	With this option, the screen is dimmed but contrast is at a maximum. It is suitable for TV viewing in a room with low lighting.																					
																						
	<ul style="list-style-type: none"> <li>When <b>Picture Mode</b> is set to <b>Vivid</b>, <b>Advanced Iris</b> option is automatically set to <b>Auto 1</b>.</li> </ul>																					
<b>Picture</b>	Increases or decreases picture contrast.																					
<b>Brightness</b>	Brightens or darkens the picture.																					
<b>Color</b>	Increases or decreases color intensity.																					
<b>Hue</b>	Increases or decreases the green tones.																					
<b>Color Temperature</b> <i>White adjustment</i>	<b>Cool</b>	Gives the white colors a bluish tint.																				
	<b>Neutral</b>	Gives the white colors a neutral tint.																				
	<b>Warm 1, 2</b>	Gives the white colors a reddish tint.																				
																						
	<ul style="list-style-type: none"> <li><b>Picture Mode</b> settings determine the available <b>Color Temperature</b> options:</li> </ul>																					
	<table border="1"> <thead> <tr> <th rowspan="2">Color Temperature options</th> <th colspan="3">Picture Mode for all modes</th> </tr> <tr> <th>Vivid</th> <th>Standard</th> <th>Cinema</th> </tr> </thead> <tbody> <tr> <td>Cool</td> <td>yes</td> <td>yes</td> <td>yes</td> </tr> <tr> <td>Neutral</td> <td>yes</td> <td>yes</td> <td>yes</td> </tr> <tr> <td>Warm1, 2</td> <td>n/a</td> <td>yes</td> <td>yes</td> </tr> </tbody> </table>			Color Temperature options	Picture Mode for all modes			Vivid	Standard	Cinema	Cool	yes	yes	yes	Neutral	yes	yes	yes	Warm1, 2	n/a	yes	yes
Color Temperature options	Picture Mode for all modes																					
	Vivid	Standard	Cinema																			
Cool	yes	yes	yes																			
Neutral	yes	yes	yes																			
Warm1, 2	n/a	yes	yes																			
<b>Sharpness</b>	Sharpens or softens the picture.																					
<b>Noise Reduction</b>	Reduces the noise level of connected equipment, and the VHF/UHF/CABLE input. Select from <b>Auto</b> (available only with VHF/UHF/Cable input), <b>High</b> , <b>Medium</b> , <b>Low</b> and <b>Off</b> .																					
<b>DRC Mode</b>	<b>High Density</b>	Creates a high-resolution picture with 4 × density, for high quality sources (i.e., DVD player, satellite receiver).																				
	<b>Progressive</b>	Recommended for still pictures.																				
																						
	<ul style="list-style-type: none"> <li><b>DRC Mode</b> is available only with 480i source. <b>DRC Mode</b> is not available when using the <b>Freeze</b> feature.</li> <li><b>DRC Mode</b> is not available when the <b>Game Mode</b> is set to <b>On</b>.</li> </ul>																					

(Continued)

## DRC Palette

Allows you to customize the level of detail (**Reality**) and smoothness (**Clarity**).

- 1 Press the arrow buttons to highlight **DRC Palette** then press  $\oplus$ .  
The **DRC Palette** appears.

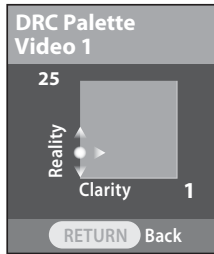

- 2 Press the arrow buttons to adjust the position of the marker (●). As you move the ● higher along the **Reality** axis, the picture becomes more detailed. As you move the ● to the right along the **Clarity** axis, the picture becomes smoother.
- 3 To save the setting, press  $\oplus$ .



- **DRC Palette** is available only with 480i source. **DRC Palette** is not available when using the **Freeze** feature.
- **DRC Palette** is not available when the **Game Mode** is set to **On**.

## Advanced Settings

**Advanced Settings** are available for the following conditions:

	Vivid	Standard	Cinema	PC signal
Advanced Settings	n/a	yes	yes	n/a

**Reset** Resets all the advanced settings to the default values.

**Black Corrector** Enhances black areas of the picture for stronger contrast.

**Gamma** Adjusts the balance between the light and dark areas of the picture.

**Clear White** Emphasizes white and light colors.

**Live Color** Makes colors more vivid and reproduces clear skin tones.



## Sound Settings

The following **Sound** settings options are available for the TV speakers. Make sure to have the **Speakers** option set to **TV Speakers** under **Audio Options** settings (see page 37).

<b>Sound Mode</b>	<b>Dynamic</b>	Enhances treble and bass.
	<b>Standard</b>	Suitable for spoken dialog.
	<b>Custom</b>	Customizes the sound settings including the <b>Sound Booster</b> setting.



- **Sound Mode** can also be accessed by pressing **OPTIONS** on the remote control.

**Reset** Resets the current **Sound Mode** setting to the default values.

**Treble** Increases or decreases higher-pitched sounds.

**Bass** Increases or decreases lower-pitched sounds.

**Balance** Emphasizes left or right speaker balance.



<b>Surround</b>	<b>S-FORCE Front Surround</b>	Provides a virtual surround sound experience made possible using just two front speakers.
	<b>Off</b>	Select for normal stereo or mono reception.
<b>Sound Booster</b>	The <b>Sound Booster</b> provides a fuller sound with a greater sense of depth and width, by emphasizing the High and Low frequency sounds. Select <b>High</b> or <b>Low</b> for the amount of boost you desire while in the <b>Custom Sound Mode</b> . Selecting <b>Off</b> will bypass the emphasis.	
	 <ul style="list-style-type: none"> <li>The <b>Sound Booster</b> is automatically in the <b>High</b> position for <b>Dynamic Sound Mode</b> and <b>Low</b> position for <b>Standard Sound Mode</b>.</li> </ul>	
<b>Steady Sound</b>	<b>On</b>	Stabilizes the volume across all programs and commercials.
	<b>Off</b>	Turns off <b>Steady Sound</b> .
<b>Volume Offset</b>	Adjusts the volume level of the current input (TV or video input) relative to other inputs.	



## Screen Settings



- This television's picture is slightly overscanned on the screen to prevent artifacts or lack of picture at screen edge caused by television signal or other video sources.

<b>Wide Mode</b>	<b>Wide Zoom</b>	Fills the screen with minimum distortion.
	<b>Normal</b>	Displays the 4:3 picture in its original size when the original source is 4:3.
	 <ul style="list-style-type: none"> <li><b>Normal</b> is not available when you are watching 720p, 1080i or 1080p sources.</li> </ul>	
	<b>Full</b>	Enlarges the picture horizontally to fill the screen when the original source is 4:3 (Standard-definition source). When the original source is 16:9 (High-definition source), select this mode to display the 16:9 picture in its original size.
	<b>Zoom</b>	Enlarges the original picture while maintaining the aspect ratio.
 <ul style="list-style-type: none"> <li><b>Wide Mode</b> can also be accessed by pressing the <b>WIDE</b> button.</li> </ul>		
<b>Auto Wide</b>	<b>On</b>	Automatically changes <b>Wide Mode</b> setting based upon content. If frequent screen changes are disturbing to you, select <b>Off</b> .
	<b>Off</b>	Turns off the <b>Auto Wide</b> option. Choose a <b>Wide Mode</b> from the <b>Wide Mode</b> option.
<b>4:3 Default</b> <i>Select the default screen mode to use for 4:3 sources</i>	<b>Wide Zoom</b>	Enlarges the 4:3 picture to fill the 16:9 screen, keeping the original image as much as possible.
	<b>Normal</b>	Displays the 4:3 picture in its original size.
	<b>Full</b>	Select to enlarge the 4:3 picture horizontally only, to fill the display area.
	<b>Zoom</b>	Select to enlarge the picture horizontally and vertically while maintaining the aspect ratio that fills the wide screen.
	<b>Off</b>	Select to continue using the current screen mode setting when the channel or input is changed.
 <ul style="list-style-type: none"> <li>This option is not available for HDMI PC input.</li> <li>This option is not available if <b>Auto Wide</b> is set to <b>Off</b>.</li> <li>If <b>4:3 Default</b> is set to anything but <b>Off</b>, the <b>Wide Mode</b> setting changes only for the current channel. When you change channels (or inputs), <b>Wide Mode</b> is automatically replaced with the <b>4:3 Default</b> setting for 4:3 sources. To retain the current <b>Wide Mode</b> setting as channels and inputs are changed, set <b>4:3 Default</b> to <b>Off</b>.</li> </ul>		

<b>Display Area</b>	<b>Normal</b>	Displays the picture in its original size.
	<b>-1/-2</b>	Enlarges the picture to hide the edge of the picture.
<b>Screen Position</b>	Adjust the <b>Vertical</b> positioning by pressing the <b>▲/▼</b> buttons. Press the <b>◀/▶</b> buttons to adjust the <b>Horizontal</b> positioning.	
	 <ul style="list-style-type: none"> <li>• <b>Vertical</b> adjustment is available only when <b>Wide Mode</b> is set to <b>Zoom</b> or <b>Wide Zoom</b>.</li> <li>• <b>Screen Position</b> feature is useful if the TV is connected to game equipment.</li> </ul>	
<b>Vertical Size</b>	Adjusts the vertical size of the picture. (Available only in <b>Wide Zoom</b> and <b>Zoom</b> .) Press <b>◀/▶</b> and press <b>⊕</b> to adjust.	

**Screen** settings for PC Input Modes differ from all other input modes and are shown below.

<b>H Center</b>	Allows you to move the position of the picture horizontally (left and right) while <b>PC Wide Mode</b> is set to <b>Zoom</b> . <b>To Adjust the H Center</b> Press <b>▲/▼</b> to highlight <b>H Center</b> and press <b>⊕</b> . Press <b>◀/▶</b> to correct the centering then press <b>⊕</b> .	
<b>V Center</b>	Allows you to move the position of the picture vertically (up and down) while <b>PC Wide Mode</b> is set to <b>Zoom</b> . <b>To Adjust the V Center</b> Press <b>▲/▼</b> to highlight <b>V Center</b> and press <b>⊕</b> . Press <b>◀/▶</b> to correct the centering then press <b>⊕</b> .	
<b>Wide Mode</b>	<b>Normal</b>	Select to display the picture in its original size of PC format resolution.
	<b>Full 1</b>	Select to enlarge the picture to increase (or expand) the display area, keeping its original aspect ratio.
	<b>Full 2</b>	Select to enlarge the picture to increase (or expand) the display area.   <ul style="list-style-type: none"> <li>• <b>PC Wide Mode</b> can also be accessed by pressing the <b>WIDE</b> button while in PC mode.</li> </ul>
	<b>Zoom</b>	Select to enlarge the picture horizontally and vertically to an equal aspect ratio that fills the wide screen.



## Video Options Settings

<b>CineMotion</b>	Select <b>Auto</b> to automatically detect film-based content and apply a reverse 3-2 pulldown process. Moving pictures will appear cleaner and more natural looking. The <b>CineMotion</b> feature can be set separately for each external input. Select <b>Off</b> to disable the detection.
<b>Game Mode</b>	Select <b>On</b> to optimize the enjoyment of fast paced video game capturing every movement. <b>Game Mode</b> can be set to each external input. Select <b>Off</b> to disable the mode.



## Audio Options Settings

<b>MTS</b> <i>Enjoy stereo, bilingual and mono programs</i>	<b>Stereo</b>	For stereo reception when viewing a TV program broadcast in stereo.
	<b>Auto SAP</b>	Automatically switches the TV to second studio programs when a SAP signal is received. If no SAP signal is present, the TV remains in <b>Stereo</b> mode.
	<b>Mono</b>	For mono reception. Use to reduce noise during weak stereo broadcasts.
		<ul style="list-style-type: none"> <li>• <b>MTS</b> is available only for analog programs.</li> </ul>
<b>Speakers</b>	<b>TV Speakers</b>	Select to use the TV speakers for audio.
	<b>Audio System</b>	Select this option if you wish to use an external audio system for the TV sound. By selecting this option you are disabling the TV speakers.
<b>Audio Out</b> <i>Easy control of volume adjustments</i>	<b>Fixed</b>	Select to fix the audio output and allow you to adjust the volume with your audio system's remote control. (The TV's remote control's <b>VOLUME</b> and <b>MUTING</b> buttons have no effect on the <b>Audio Out</b> .)
	<b>Variable</b>	Select to control the <b>Audio Out</b> 's volume and muting with your TV's remote control.
		<ul style="list-style-type: none"> <li>• <b>Alternate Audio</b> feature is available only for digital programs. If the program you are watching is also available in other languages from the audio tracks, and if that language is what you have selected in the <b>Language</b> setting, your TV will automatically switch to the matching language with the <b>Alternate Audio</b> feature. The <b>Alternate Audio</b> option may be accessed by pressing the <b>OPTIONS</b> button on the remote control when alternate audio stream is available from the broadcaster.</li> </ul>



## Channel Settings

<b>Cable</b>	<b>On</b>	For receiving cable channels via cable TV provider.
	<b>Off</b>	For using an antenna.
		<ul style="list-style-type: none"> <li>• You should run <b>Auto Program</b> after changing the <b>Cable</b> setting.</li> </ul>
<b>Auto Program</b>	Automatically sets up the channel list on the TV for all receivable channels. Channel scanning will be based on the <b>Cable On/Off</b> setting.	
	<b>1</b>	Select <b>Auto Program</b> .
	<b>2</b>	Select <b>OK</b> to start <b>Auto Program</b> . When <b>Auto Program</b> is completed, the screen will display the number of channels found.
	<b>3</b>	Press <b>RETURN</b> to exit the <b>Auto Program</b> .
		<ul style="list-style-type: none"> <li>• Running <b>Auto Program</b> will clear <b>Favorites</b> list.</li> <li>• If you run <b>Auto Program</b> again, previously scanned channels will be overwritten with the newly scanned channels.</li> </ul>

(Continued)

<b>Add Digital Channels</b>	Select to add digital channels. Be sure to have the <b>Cable</b> option selected appropriately for the signal source.
<b>Show/Hide Channels</b>	Allows you to show or hide channels when you surf with the <b>CH +/-</b> button or in the <b>TV</b> channel list on the <b>XMB™</b> . <ol style="list-style-type: none"> <li>1 Press <b>▲/▼</b> to scroll through the channels until you highlight channel to show or hide.</li> <li>2 Press <b>⊕</b> to select <b>Shown</b> or <b>Hidden</b>. To show or hide more channels, repeat steps 1-2.</li> </ol>  <ul style="list-style-type: none"> <li>• <b>Hidden</b> channels can be accessed by entering the channel number with <b>0-9</b> buttons on the remote control.</li> </ul>
<b>Edit Channel Labels</b>	Assigns labels (such as station call letters) to channel numbers. <ol style="list-style-type: none"> <li>1 Press <b>▲/▼</b> to scroll through the channel numbers. Then press <b>⊕</b> to select the channel number to assign a label.</li> <li>2 Press <b>▲/▼</b> to scroll through the label characters (A-Z, 0-9, etc.). Press <b>▶</b> to move to the next character. Repeat to add up to 7 characters to the label. Then press <b>⊕</b> to set it. To assign labels to more channels, repeat steps 1-2.</li> </ol>



## Closed Captions (CC) Settings

<b>CC Display</b>	This option allows you to turn <b>On</b> or <b>Off</b> the <b>Closed Captions (CC)</b> feature.				
<b>Analog CC</b>	Select this option for the basic analog (EIA-608) closed caption options. <table border="1" data-bbox="342 917 1221 1043"> <tr> <td><b>CC1, CC2, CC3, CC4</b></td> <td>Displays a printed version of the dialogue or sound effects of a program. (Should be set to <b>CC1</b> for most programs.)</td> </tr> <tr> <td><b>Text1, Text2, Text3, Text4</b></td> <td>Displays network/station information presented using either half or the whole screen (if available).</td> </tr> </table>	<b>CC1, CC2, CC3, CC4</b>	Displays a printed version of the dialogue or sound effects of a program. (Should be set to <b>CC1</b> for most programs.)	<b>Text1, Text2, Text3, Text4</b>	Displays network/station information presented using either half or the whole screen (if available).
<b>CC1, CC2, CC3, CC4</b>	Displays a printed version of the dialogue or sound effects of a program. (Should be set to <b>CC1</b> for most programs.)				
<b>Text1, Text2, Text3, Text4</b>	Displays network/station information presented using either half or the whole screen (if available).				
<b>Digital CC</b>	Select this option for both analog (EIA-608) and digital (EIA-708) closed caption options. Select from <b>CC1-4</b> and <b>Service 1-6</b> (advanced digital closed caption options).				
<b>Display Options</b>	Customize the <b>Closed Captions (CC) Text</b> display with: <b>Character Size, Character Style, Character Color, Character Opacity, Edge Type, Edge Color, Background Color</b> and <b>Background Opacity</b> .				



- **Closed Captions (CC)** can be turned on and off directly by pressing the **CC** button on the remote control.





## Parental Lock Settings

The **Parental Lock** feature allows you to block programs according to their content and rating levels and block channels (regardless of the programs). Password is necessary in setting up blocking.

### To View Blocked Programs

Press **ENT** when tuned to a blocked program, then enter the password. To reactivate the **Parental Lock** settings, turn off and on the TV.

<b>Password</b>	Use <b>0-9</b> button on the remote control to enter a four-digit password. The first time the password is created, you must re-enter it again to confirm the password. "Password Set" message will appear on the screen upon confirmation.	
	<b>Change Password:</b> You can change your password by entering the <b>Parental Lock</b> setting with the previously set password, highlight and select the <b>Change Password</b> then enter the new password.	
		
	<ul style="list-style-type: none"> <li>You need your password for any future access into the <b>Parental Lock</b> setting. If you lose your password, see "Lost password" on page 48.</li> </ul>	
<b>Country</b>	Select the country name of <b>U.S.A.</b> or <b>Canada</b> for the appropriate ratings. The rating system varies between these two countries. See Custom Rating System Chart on page 40.	
<b>Rating</b>	<b>Off</b>	Turns off <b>Parental Lock</b> . No programs are blocked from viewing based on their ratings.
	<b>Child</b>	Maximum ratings permitted are: U.S.: TV-Y, TV-G, G Canada: C, G, TV-Y
	<b>Youth</b>	Maximum ratings permitted are: U.S.: TV-PG, PG Canada: C8+, PG, 8 ans+, TV-PG
	<b>Young Adult</b>	Maximum ratings permitted are: U.S.: TV-14, PG-13 Canada: 14+, 13 ans+, TV-14
	<b>Custom</b>	Sets ratings manually. U.S.: See page 40 for details. Canada: See page 40 for details.
		
	<ul style="list-style-type: none"> <li>If you are not familiar with the parental guideline rating system, you should select <b>Child</b>, <b>Youth</b>, or <b>Young Adult</b> to help simplify the rating selection. To set more specific ratings, select <b>Custom</b>.</li> </ul>	
<b>Digital Rating</b> <i>(Available only in U.S.A where advanced ratings exist)</i>	<b>Off</b>	Turn <b>Digital Rating</b> off. No programs containing digital ratings are blocked from viewing.
	<b>Custom</b>	Select to customize the <b>Parental Lock</b> with downloadable digital ratings.
	<b>Clear All</b>	Select to clear the downloaded ratings.
<b>Unrated</b> <i>(Available only when Country is set to U.S.A.)</i> Block programs or movies that are broadcast without a rating	<b>Allow</b>	Allows programs and movies that are broadcast without a rating.
	<b>Block</b>	Blocks all programs and movies that are broadcast without a rating.
		
	<ul style="list-style-type: none"> <li>If you block unrated TV programs, be aware that the following types of programs may be blocked: programs broadcast from another country, emergency broadcasts, political programs, sports, news, public service announcements, religious programs and weather.</li> </ul>	
<b>Channel Block</b>	This option allows you to block channels regardless of program ratings. The password needs to be set up prior to blocking channels. The blocked channel can only be viewed by entering the correct password.	
	<b>To View a Blocked Channel</b>	
	Press <b>ENT</b> button when tuned to the blocked channel then enter the password.	

(Continued)

## Custom Rating System Chart

For **Country** selection of **U.S.A.**:

<b>Movie Rating</b>	<b>G</b>	All children and general audience	
	<b>PG</b>	Parental guidance suggested	
	<b>PG-13</b>	Parental guidance for children under 13	
	<b>R</b>	Restricted viewing, parental guidance is suggested for ages under 17	
	<b>NC-17 and X</b>	No one 17 and under allowed	
<b>TV Rating</b> <i>Block programs by their rating, content or both</i>	Age-Based Ratings		
	<b>TV-Y</b>	All children	
	<b>TV-Y7</b>	Directed to children age 7 and older	
	<b>TV-G</b>	General audience	
	<b>TV-PG</b>	Parental guidance suggested	
	<b>TV-14</b>	Parents strongly cautioned	
	<b>TV-MA</b>	Mature audience only	
	Content-Based Ratings		
	<b>FV</b>	Fantasy violence	
	<b>D</b>	Suggestive dialogue	
	<b>L</b>	Strong language	
	<b>S</b>	Sexual situations	
	<b>V</b>	Violence	
		• To ensure maximum blocking capability, set the Age-Based Ratings.	



For **Country** selection of **Canada**:

<b>English Rating</b>	<b>C</b>	All children
	<b>C8+</b>	Children 8 years and older
	<b>G</b>	General programming
	<b>PG</b>	Parental guidance
	<b>14+</b>	Viewers 14 and older
	<b>18+</b>	Adult programming
<b>French Rating</b>	<b>G</b>	General programming
	<b>8 ans+</b>	Not recommended for young children
	<b>13 ans+</b>	Not recommended for ages under 13
	<b>16 ans+</b>	Not recommended for ages under 16
	<b>18 ans+</b>	Programming restricted to adults
<b>U.S.A. Rating</b>	See <b>TV Rating</b> under <b>U.S.A.</b> for details.	





## External Inputs Settings

<b>Label Inputs</b>	<p>To assign your own label or <b>Skip</b>:</p> <ol style="list-style-type: none"> <li>1 Press <b>▲/▼</b> to highlight the video input (<b>Video 1, Video/Component 2, Video 3, Component 1, Component 3, HDMI 1, HDMI 2</b>), then press <b>⊕</b> to select the desired input.</li> <li>2 Press <b>▲/▼</b> to highlight the display label you want to assign, then press <b>⊕</b>.</li> </ol> <p></p> <ul style="list-style-type: none"> <li>• You can select from the following labels for each input: –, DVD, Cable Box, Satellite, BD, VCR, Receiver, DVR, Game, Camcorder, PC, Skip.</li> <li>• “–” indicates that no labels are assigned and displayed with the default labeling.</li> </ul>
<b>Video/Component 2 Priority</b>	<p>If both inputs are connected, then selecting <b>Video 2</b> selects the composite input, and <b>Component 2</b> selects the component input. If only one component or composite is connected, the TV will automatically select the connected input by default.</p> <p>To view signal from the equipment connected to the side terminal:</p> <ol style="list-style-type: none"> <li>1 Press <b>HOME</b> to display the <b>XMB™</b>.</li> <li>2 Press <b>▶</b> button to get to the <b>External Inputs</b>.</li> <li>3 Press <b>▲/▼</b> to highlight <b>Video/Component 2</b> (dual composite/component connection).</li> </ol> <p></p> <ul style="list-style-type: none"> <li>• You will need to connect the audio cable in addition to connecting the component cables.</li> </ul>



## HDMI Settings

HDMI inputs of this TV will recognize and communicate with other Sony equipment equipped with **HDMI Control**.

<b>HDMI Control</b>	<b>On/Off</b> feature allows your TV to communicate with other equipment that supports <b>HDMI Control</b> . You must select <b>On</b> to use the features listed below.
<b>Device Auto Power Off</b>	Select <b>On</b> to have your connected <b>HDMI Control</b> equipment to power off automatically when the TV is turned off. Select <b>Off</b> to disable this function.
<b>TV Auto Power On</b>	Select <b>On</b> to control your TV's power on from your connected <b>HDMI Control</b> equipment. Select <b>Off</b> to disable this function.
<b>Device List</b>	Displays a list of <b>HDMI Control</b> equipment connected to the TV.



## General Settings

<b>Language</b>	Select the language of your choice from <b>English</b> , <b>Español</b> and <b>Français</b> to be used for displaying all the on screen settings.
<b>Info Banner</b>	Displays the program name and the program information such as program title and program rating (if available from the broadcaster) when option is set to <b>On</b> . Select <b>Off</b> for minimal display information. Selecting <b>Off</b> will not completely disable the banner display. <b>Info Banner</b> also appears on the screen each time the channel is changed or <b>DISPLAY</b> button on the remote control is pressed.  <ul style="list-style-type: none"><li>• To see the rating information on the banner, <b>Info Banner</b> setting must be set to <b>On</b>.</li></ul>
<b>Display Position</b>	When selected, the guide markers for the TV <b>Display Position</b> will appear at four corners of the screen. Adjust <b>Vertical</b> position and/or <b>Horizontal</b> position by pressing <b>▲/▼/◀/▶</b> buttons to evenly position the markers.
<b>Cooling Mode</b>	Select <b>High</b> to use the TV at an altitude of 5,000 feet (1,500 m) or higher. Select <b>Normal</b> to use the TV at normal altitude.
<b>Lamp Replacement</b>	When the lamp nears the end of its life, a message will appear every time the TV is turned on. After the lamp is replaced, select this option then follow the steps on screen.



## Initial Setup

If you have missed the **Initial Setup** when you first connected the TV or if you want to scan all receivable channels, you can run the **Initial Setup**. Follow the instructions on the screen. Settings such as picture and sound adjustments will not be affected by this **Initial Setup**.



- **Favorites** list will be cleared each time you run the **Initial Setup**.

# Other Information

## Replacing the Lamp

The projection lamp, like all lamps, will eventually lose brightness and functionality, which affects the overall performance of your TV. How long the lamp maintains its brightness will vary depending upon your usage and environmental conditions. To maintain the quality of your viewing experience, Sony recommends that you replace the lamp (1) after approximately 8,000 hours of use; (2) when the screen becomes dark or the color looks unusual; (3) when the LAMP LED on the front of the TV blinks; or (4) when the lamp replacement message appears on the TV screen.



### WARNING

**Electric appliances can cause fire or high temperature, resulting in injury or death. Be sure to follow the instructions below.**

- Use a Sony XL-2500 replacement lamp (not supplied) for replacement. Use of any other lamp may damage the TV.
- Do not remove the lamp for any purpose other than replacement. Doing so may cause injury or fire.
- Do not put flammable materials and metal objects inside the lamp receptacle of the TV after removing the lamp. Doing so may cause fire or electrical shock. Do not touch the lamp receptacle once the lamp has been removed.
- When the lamp eventually burns out, you may hear a noticeable pop sound. This is normal and it is inherent to this type of lamp.
- In rare instances, the bulb may pop inside the lamp unit, but the lamp unit is designed to contain all of the broken glass pieces inside the lamp unit.
- This TV's lamp contains mercury and should be disposed of properly. Consult your local authorities regarding safe disposal. The material contained in this lamp is similar to those of a fluorescent lamp, so you should dispose of it in the same way.

## How to Replace the Lamp

- 1** Turn off the power on the main unit. Wait several minutes, then unplug the power cord. (The cooling fan will continue to operate for about two minutes after turning the power off.)
- 2** Wait at least 30 minutes after unplugging the power cord to allow the lamp to cool down before replacing it. To avoid being burned, do not touch the lamp receptacle once the lamp has been removed.
- 3** Take the new lamp out of the box. Do not touch the glass portion of the new lamp.

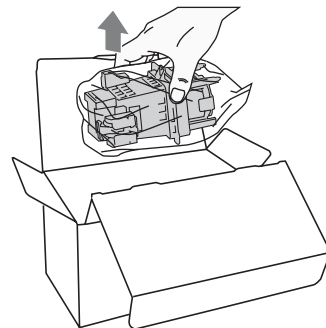

- Do not shake the lamp. Vibration can damage the lamp or shorten its life.
- Avoid touching the front glass of a new lamp or the glass of the lamp receptacle. This may reduce picture quality or lamp life.

- 4** Remove the outside lamp cover. Using equal force, press both hooks (marked by ①) towards the TV screen in the direction the arrows are pointing. While pressing the two hooks (marked by ①), push the center lever (marked by ②) towards the TV screen and pull the lamp cover towards you. The lamp cover should come off easily.

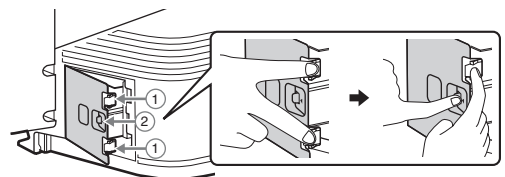

- 5** Remove the lamp door.  
Holding the door knob, press the door lever toward the door knob in the direction the arrow is pointing. Then, pull the lamp door out of the TV towards you.

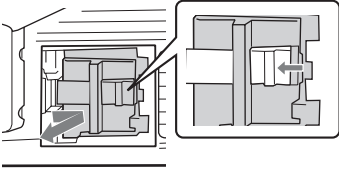

- 6** Pull the lamp out of the TV.  
Grip the lamp by the indented grooves as illustrated below.  
Pull the lamp straight out of the TV as illustrated below.

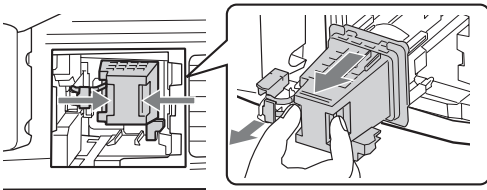

- The lamp is very hot immediately after use. Do not touch the inside of the lamp compartment, the glass portion of the lamp, or the surrounding parts.
- After the used lamp has cooled, place it into the empty box of the replacement lamp. Never put the used lamp into a plastic bag.

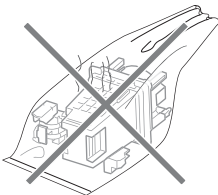

- 7** Slide the new lamp into its place.  
Insert the new lamp into place by holding the indented grooves firmly. Make sure the lamp is securely mounted into the compartment.  
Failure to do so may cause a fire or the screen to go dark.

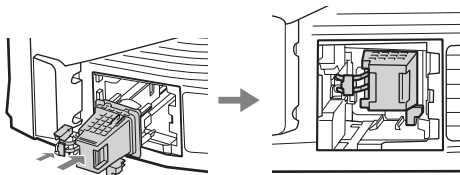

- If the lamp is not securely reattached, the self-diagnostic function may be triggered and the POWER LED blinks six times (see page 19).

- 8** Reattach the lamp door.  
Be sure that the word “TOP” imprinted on the lamp door is on top while placing the door lamp into the compartment.

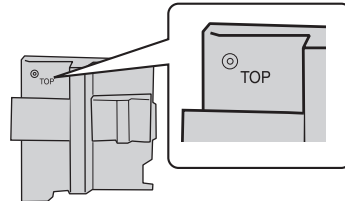

- Grip the door knob, but do not hold in the door lever when sliding the lamp door into the compartment.

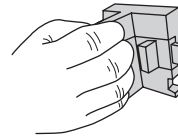

- While keeping the lamp door at a slant, slide the lamp door into the compartment by leading with the left side. Insert the two tabs into the slot and follow the guide rail. Once the left side can no longer be pushed in, press the lamp door lever toward the door knob.

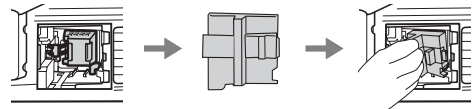

- Shut the lamp door by releasing the door lever.

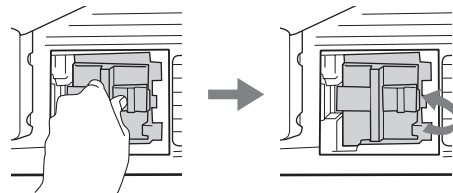

- The lamp door is securely closed when a clicking sound occurs. Make sure it is securely closed by tugging on the door knob.

- 9** Put the outside lamp cover back in its place. Insert the two small tabs from the left side of the outside lamp cover into the slots of the TV. Push in the two larger tabs of the outside lamp cover on the right side into the TV. The outside lamp cover is securely closed after two clicking sounds are made.

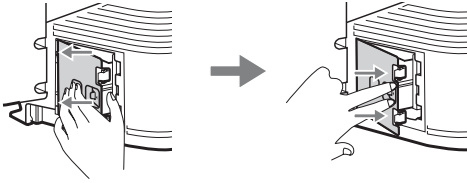

- 10** Plug in the power cord. Turn on the TV and set the **Lamp Replacement** option in the **General** settings (see page 42). This setting is necessary to inform you when the next lamp replacement is needed.



- Until you set the **Lamp Replacement** option, a message announcing that the lamp is at the end of its life will appear every time you turn on the TV.
- Consult your Sony dealer for a Sony XL-2500 replacement lamp.
- Take great care when replacing the lamp or plugging in/unplugging the connecting cords. Rough handling may cause the TV to fall, damaging the TV, the TV stand and the floor.

### The used lamp

#### For customers in the United States:

Lamp in this product contains mercury. Disposal of these materials may be regulated due to environmental considerations. For disposal or recycling information, please contact your local authorities or the Electronic Industries Alliance ([www.eiae.org](http://www.eiae.org)).

- Do not leave the used lamp near flammable materials or within the reach of children.
- Do not pour water onto the used lamp or put any object inside the lamp. Doing so may cause the lamp to burst.

#### For replacement lamp information visit:

U. S. residents:

<http://www.sonystyle.com/tv/>

Canadian residents:

<http://www.sonystyle.ca/tv/>

## Troubleshooting

If you have questions, service needs, or require technical assistance related to the use of your Sony TV, please visit our website or call one of the following numbers:

<http://www.sony.com/tvsupport>

1-800-222-SONY(7669) for US Support

1-877-899-SONY(7669) for Canadian Support

Condition	Explanation/Solution
<b>No picture</b>	
Cannot receive any channels	<ul style="list-style-type: none"> <li>• Make sure the power cord is connected securely.</li> <li>• Turn on the power of the TV.</li> <li>• Check antenna/cable connections.</li> <li>• Make sure the <b>Cable</b> setting is correct for your TV signal source.</li> </ul>
TV is locked to one channel	<ul style="list-style-type: none"> <li>• Perform <b>Auto Program</b> to add receivable channels that are not present in the TV's memory (see pages 18 and 37).</li> </ul>
Cannot receive or select channels	<ul style="list-style-type: none"> <li>• Perform <b>Auto Program</b> to add receivable channels that are not present in the TV's memory (see pages 18 and 37).</li> <li>• To receive or select cable channels, make sure that <b>Cable</b> in the <b>Channel</b> settings is set to <b>On</b> (see page 37). To receive or select UHF channels over an antenna, make sure <b>Cable</b> is set to <b>Off</b>.</li> </ul>
The TV turns off automatically	<ul style="list-style-type: none"> <li>• Check if <b>Sleep Timer</b> is activated, or confirm the <b>Duration</b> setting of <b>Timer</b> (see page 32).</li> </ul>
No picture from some video sources	<ul style="list-style-type: none"> <li>• Check the connection between the optional video equipment and the TV.</li> <li>• Press <b>INPUT</b> on the remote control (see page 24).</li> <li>• Press <b>HOME</b> on the remote control. Select your desired input from the <b>External Inputs</b> list.</li> </ul>
<b>Poor picture</b>	
The quality of the images is not as good as what I saw at the store	<ul style="list-style-type: none"> <li>• Picture quality depends on the signal content. See Quick Setup Guide (supplied) to display the best possible picture for that signal.</li> </ul>
Double images or ghosts	<ul style="list-style-type: none"> <li>• Check antenna/cable connections.</li> <li>• Check the antenna location and direction.</li> </ul>
Only snow and noise appear on the screen	<ul style="list-style-type: none"> <li>• Check if the antenna is broken or bent.</li> <li>• Check if the antenna has reached the end of its serviceable life. (3-5 years in normal use, 1-2 years at the seaside.)</li> </ul>
Dotted lines or stripes	<ul style="list-style-type: none"> <li>• Keep the TV away from noise sources such as cars, motorcycles, or hair-dryers.</li> <li>• If using 300 ohm twin lead, move the excess lead away from the TV or try using 75 ohm coaxial cable instead.</li> </ul>
No color/Dark picture/Color is not correct/The picture is too bright	<ul style="list-style-type: none"> <li>• Press <b>PICTURE</b> to select the desired <b>Picture Mode</b> (see page 22).</li> <li>• Adjust the <b>Picture Mode</b> options in the <b>Picture</b> settings (see page 32).</li> </ul>
Noisy picture	<ul style="list-style-type: none"> <li>• Make sure that the antenna is connected using the supplied 75-ohm coaxial cable.</li> <li>• Keep the antenna cable away from other connecting cords.</li> <li>• To avoid TV interference, make sure to use an undamaged antenna cable.</li> </ul>

Condition	Explanation/Solution
<b>No sound/Noisy sound</b>	
Good picture, no sound	<ul style="list-style-type: none"> <li>• Check the volume control.</li> <li>• Press <b>MUTING</b> or <b>VOL +</b> so that “Muting” disappears from the screen (see page 22).</li> <li>• Set <b>Speakers</b> to <b>TV Speakers</b> in the <b>Audio Options</b> settings (see page 37). If it is set to <b>Audio System</b>, sound is not output from the TV’s speakers regardless of the TV’s volume control.</li> <li>• Make sure that the audio is connected.</li> <li>• When using HDMI input with Super Audio CD or DVD-Audio, DIGITAL OUT (Optical) may not provide an audio signal.</li> <li>• For HDMI equipment, confirm that the audio output setting of the connected equipment is set to PCM. This TV’s HDMI inputs support PCM 32, 44.1 and 48 kHz, 16, 20 and 24bits.</li> </ul>
Audio noise	<ul style="list-style-type: none"> <li>• Make sure that the antenna is connected using the supplied 75-ohm coaxial cable.</li> <li>• Keep the antenna cable away from other connecting cords.</li> <li>• To avoid TV interference, make sure to use an undamaged antenna cable.</li> </ul>
No audio for HDMI	<ul style="list-style-type: none"> <li>• Confirm DVD player, set-top-box audio settings. Select 2 channel LPCM audio.</li> </ul>
<b>PC Input</b>	
No Picture / No Signal	<ul style="list-style-type: none"> <li>• Confirm the PC is connected to the TV with the HDMI IN.</li> <li>• Ensure the output signal from the PC is one of the formats listed on page 15.</li> <li>• Turn the PC off. Confirm the PC connection and restart the PC. Plug and play will auto-detect the TV and correctly set the correct resolution.</li> </ul>
Poor Picture	<ul style="list-style-type: none"> <li>• Adjust the resolution (see page 15).</li> </ul>
<b>General</b>	
<b>Wide Mode</b> changes automatically	<ul style="list-style-type: none"> <li>• The current <b>Wide Mode</b> setting is automatically replaced with the <b>4:3 Default</b> setting when you change the channel or video input, if <b>4:3 Default</b> in the <b>Screen</b> settings is set to other than <b>Off</b>. If you want to lock in <b>Wide Mode</b> selected with <b>WIDE</b> on the remote control, set <b>4:3 Default</b> to <b>Off</b> in the <b>Screen</b> settings (see page 35).</li> <li>• Check the <b>Auto Wide</b> option in the <b>Screen</b> settings (see page 35).</li> </ul>
“Black box” on screen	<ul style="list-style-type: none"> <li>• You have selected a text option and no text is available (see page 38). To turn off this feature, set the <b>CC Display</b> option to <b>Off</b>. If you were trying to select closed captioning, select <b>CC1</b> instead of <b>Text1-4</b>.</li> </ul>
Black bands appear at the edges of the screen	<ul style="list-style-type: none"> <li>• Some wide screen programs are filmed in aspect ratios that are greater than 16:9 (this is especially common with theatrical releases). Your TV will show these programs with black bands at the top and bottom of the screen. For more details, check the documentation that came with your DVD (or contact your program provider).</li> <li>• Programs in 4:3 aspect ratio will have bands on left and right sides of the screen.</li> </ul>
Certain programs on DVD or other digital sources display a loss of detail, especially during fast-motion or dark scenes	<ul style="list-style-type: none"> <li>• This is due to the digital compression of the source content used by certain digital broadcasts and DVDs which may cause your TV’s screen to display less detail than usual, or cause artifacts (small blocks or dots, pixelations) to appear on your screen. These signal compressions are more visible and are dependent on the clarity and resolution of the television.</li> </ul>
Remote control does not operate	<ul style="list-style-type: none"> <li>• Check the polarity of the batteries or replace the batteries.</li> <li>• Point the remote control at the remote control sensor located at the front of the TV.</li> <li>• Fluorescent lamps can interfere with your remote control operation; try turning off the fluorescent lamps.</li> <li>• Keep the remote control sensor area clear from obstacles.</li> </ul>
Some digital cable channels are not being displayed	<ul style="list-style-type: none"> <li>• Certain cable companies have limitations on the broadcast of digital cable channels. Check with your cable company for more information.</li> <li>• The digital cable channel may be set to <b>Hidden</b> in the <b>Show/Hide Channels</b> setting (see page 38).</li> </ul>

Condition	Explanation/Solution
Lost password	<ul style="list-style-type: none"> <li>• Select the <b>Password</b> settings on the <b>Parental Lock</b> settings, then enter the following master password: 4357. The master password clears your previous password and allows you to enter a new password (see page 39).</li> </ul>
How to reset the TV to factory settings	<ul style="list-style-type: none"> <li>• Turn on the TV. While holding down <b>▲</b> on the remote control, press <b>POWER</b> on the TV. (The TV will turn itself off, then back on again.) Release <b>▲</b>. WARNING: The Reset will clear all of your customized settings including the <b>Parental Lock</b> setting.</li> </ul>
LAMP LED blinks in red	<ul style="list-style-type: none"> <li>• Replace the lamp (see page 43).</li> </ul>
“Lamp Replacement message” appears	<ul style="list-style-type: none"> <li>• It is time for you to replace the projection lamp used in your TV.</li> <li>• Turn to page 43 on “How to Replace the Lamp” and follow the directions on replacing the lamp.</li> <li>• Use only the lamp designated for your TV model.</li> <li>• After the lamp is replaced, select the <b>Lamp Replacement</b> option in the <b>General</b> settings.</li> </ul>
The replacement lamp does not light up	<ul style="list-style-type: none"> <li>• The lamp door or lamp might not be securely attached. Repeat the steps on page 43 to ensure that they are both installed securely.</li> </ul>
The cooling fan is loud	<ul style="list-style-type: none"> <li>• If the TV is used at high altitudes and the <b>Cooling Mode</b> is set to <b>High</b>, the cooling fan runs faster and its sound becomes louder. If the TV is not used at high altitudes, set <b>Cooling Mode</b> to <b>Normal</b> (see page 42).</li> </ul>
“High Temperature Warning!” message appears	<ul style="list-style-type: none"> <li>• Make sure to remove dust from the ventilation slots on the rear and both sides of the TV. In addition, make sure that there are no obstacles in front of the ventilation slots. If the message still appears after the dust or obstacles are removed, the TV may need servicing. Call your local Sony Service Center.</li> </ul>
Image left on the screen (image retention)	<ul style="list-style-type: none"> <li>• Turn off the TV for a while or let the TV run on another channel. Unlike plasma TV and CRT TV, image retention on this TV is not permanent. It is only a temporary condition (see page 9).</li> </ul>
White spot on the screen when powered off	<ul style="list-style-type: none"> <li>• If screen is exposed to direct sunlight or strong ambient light, part of the screen may appear white even when TV is powered off. This is due to the strong light reflecting off the TV screen and reflections coming from behind the screen. This is a structural property of the projection TV and is not a defect.</li> <li>• Position your TV away from such light sources.</li> </ul>



# Specifications

Models	KDF-46E3000	KDF-50E3000
<b>System</b>		
LCD Panel	0.74 inch TFT LCD panel (1920 × 1080 pixels) All the video inputs are converted to fit this panel resolution.	
Projection system	3 LCD Panels, 1 lens projection system	
Projection Lens	High Performance, large diameter hybrid lens F2.4	
Lamp	100 W, XL-2500 Ultra High Pressure Lamp	
Television system	NTSC: American TV standard ATSC (8VSB terrestrial): ATSC compliant 8VSB QAM on cable: ANSI/SCTE 07 2000 (Does not include CableCARD functionality)	
Channel coverage	Analog terrestrial: 2-69 / Digital terrestrial: 2-69 Analog Cable: 1-125 / Digital Cable: 1-135	
Panel system	LCD (Liquid Crystal Display) Panel	
Speaker output	12 W + 12 W	
<b>Input/Output jacks</b>		
Antenna	75-ohm external terminal for VHF/UHF	
VIDEO IN 1/2/3	S VIDEO (4-pin mini DIN) (VIDEO 1 only): Y: 1.0 Vp-p, 75 ohms unbalanced, sync negative / C: 0.286 Vp-p (Burst signal), 75 ohms VIDEO: 1 Vp-p, 75 ohms unbalanced, sync negative AUDIO: 500 mVrms (100% modulation)/ Impedance: 47 kilohms	
COMPONENT IN 1/2/3	YPBPR (Component Video): Y: 1.0 Vp-p, 75 ohms unbalanced, sync negative / PB: 0.7 Vp-p, 75 ohms / PR: 0.7 Vp-p, 75 ohms / Signal format: 480i, 480p, 720p, 1080i AUDIO: 500 mVrms (typical)/ Impedance: 47 kilohms	
HDMI IN 1/2	HDMI: Video: 480i, 480p, 720p, 1080i, 1080p, PC timing / Audio: Two channel linear PCM 32, 44.1 and 48 kHz, 16, 20 and 24bits AUDIO (HDMI IN 2 only): 500 mVrms (100% modulation)/ Impedance: 47 kilohms	
AUDIO OUT	500 mVrms (100% modulation)/ Up to 2 Vrms at the maximum volume setting (varies with input level)	
DIGITAL AUDIO OPTICAL OUT	PCM/Dolby Digital optical signal	
<b>Power and others</b>		
Power requirement	120 V, 60 Hz	
Power consumption in use	200 W	
Power consumption in standby	Less than 0.8 W	
Screen size (inches measured diagonally)	46	50
Speaker/Full range (2)	65 × 130 mm (2 9/16 × 5 1/8 inches)	
Dimensions (W/H/D)	1099 × 795 × 301 mm (43 5/16 × 31 5/16 × 11 7/8 inches)	1187 × 847 × 320 mm (46 3/4 × 33 3/8 × 12 5/8 inches)
Mass	27 kg (59 lb. 9 oz.)	30 kg (66 lb. 3 oz.)
Supplied accessories	Remote control RM-YD016 (1) / Size AA batteries (2) / Operating Instructions (1) / Quick Setup Guide (1) / Warranty Card (1) / Online Registration Card (U.S.A. and Canada only) (1)	
Optional accessories	Connecting cables / Lamp: XL-2500 Ultra High Pressure Lamp / TV Stand: SU-RG13M for both models (KDF-46/50E3000)	



- Optional accessories availability depends on its stock.
- Design and specifications are subject to change without notice.

# Index

0-9 buttons 20  
4:3 Default 35

## A

Add Digital Channels 38  
Advanced Iris 33  
Advanced Settings 34  
Analog CC 38  
Audio Out 37  
AUDIO OUT jack, described 11  
Auto Program 18, 37  
Auto Wide 35

## B

Balance 34  
Bass 34  
BD/DVD TOP MENU/ MENU buttons 22  
BD/DVD/STB Operating buttons 22  
Brightness 33

## C

Cable 37  
CC button 21  
CC Display 38  
CH+/- button 24  
Channel Block 39  
CHANNEL+/- button 19  
CineMotion 36  
Color 33  
Color Temperature 33  
COMPONENT IN jack (1080i/720p/480p/480i), described 11, 12  
Contact Sony 32  
Cooling Mode 42  
Country 39  
Current Time 32

## D

Device Auto Power Off 41  
Device List 41  
DIGITAL AUDIO (OPTICAL) OUT, described 11  
Digital CC 38  
Digital Rating 39  
Display Area 36  
DISPLAY button 20  
Display Options 38  
Display Position 42  
DMe<sup>x</sup> button 21  
DMe<sup>x</sup>, described 11  
DRC Mode 33  
DRC Palette 34  
DVD/VCR Record buttons 22

## E

Edit Channel Labels 38  
English Rating 40  
ENT button 20

## F

F1/F2 buttons 24  
FAVORITES button 21  
FREEZE button 21  
French Rating 40  
FUNCTION buttons 20

## G

Game Mode 36

## H

H Center 36  
HDMI Control 41  
HDMI IN jack, described 11  
HOME button 19, 24  
Hue 33

## I

Info Banner 42  
Infrared Receiver (IR) 19  
INPUT button 19, 24

## J

JUMP button 22

## L

Label Inputs 41  
LAMP LED 19  
Lamp Replacement 42  
Lamp, replacing 43–45  
Language 42

## M

Movie Rating 40  
MTS 37  
MUTING button 22

## N

Noise Reduction 33

## O

OPTIONS button 24

## P

Password 39  
Picture 33  
PICTURE button 22  
Picture Mode 32  
POWER button 19, 22  
POWER LED 19

## R

Rating 39  
Remote control programming 25, 26  
Reset 32, 34, 48  
RETURN button 21

## S

S VIDEO jack, described 11  
Screen Position 36  
Setting up channels 18  
Settings  
    Audio Options 37  
    Channel 37

Clock/Timers 32  
Closed Captions (CC) 38  
External Inputs 41  
General 42  
HDMI Settings 41  
Initial Setup 42  
Parental Lock 38  
Picture 32  
Product Support 32  
Screen 35  
Sound 34  
Video Options 36

Sharpness 33  
Show/Hide Channels 38  
Signal Diagnostics 32  
SLEEP button 20  
Sleep Timer 32  
Sound Booster 35  
Sound button 21  
Sound Mode 34  
Speaker 19  
Speakers 37  
Steady Sound 35  
Surround 35

## T

THEATER button 22  
Timer 32  
TIMER LED 19  
Treble 34  
Troubleshooting 46–48  
TV Auto Power On 41  
TV POWER button 22  
TV Rating 40

## U

U.S.A. Rating 40  
Unrated 39  
Using with remote control  
    5.1ch DVD AV System 28  
    AV Receiver 29  
    Blu-ray Disc Player 28  
    Cable Box 27  
    DVD Player or DVD Changer 27  
    DVD/VCR Combo Unit 28  
    DVR 29  
    HDD/DVD Combo Unit 28  
    Satellite Receiver 27  
    VCR 27

## V

V Center 36  
Vertical Size 36  
VHF/UHF/CABLE input, described 11  
VIDEO/AUDIO (L/R) jacks, described 11, 12  
Video/Component 2 Priority 41  
VOL+/- button 22  
Volume Offset 35  
VOLUME+/- button 19

## W

WIDE button 23  
Wide Mode 35, 36



## For Your Convenience

### **Please contact Sony directly if you:**

- Have questions on the use of your television after reading your Operating Instruction manual and Quick Setup Guide
- Experience difficulty operating your television

### **Contact Sony Customer Support at:**

<http://www.sony.com/tvsupport>

**or to speak with a support representative:**

#### **United States**

1-800-222-SONY (7669)

#### **Canada**

1-877-899-SONY (7669)

Sony will work to resolve your questions more quickly than your retailer or place of purchase.

**Please Do Not Return the Product to the Store**

