

SONY®

4-208-637-11 (2)

Video Projector

<http://www.sony.net/>

Printed on recycled paper.

Sony Corporation Printed in Japan

Operating Instructions

VPL-HW20/HW20A

SXRD **HDMI**
Silicon X-tal Reflective Display

— © 2010 Sony Corporation



WARNING

To reduce the risk of fire or electric shock, do not expose this apparatus to rain or moisture.

To avoid electrical shock, do not open the cabinet. Refer servicing to qualified personnel only.

THIS APPARATUS MUST BE EARTHED.

AVERTISSEMENT

Afin de réduire les risques d'incendie ou d'électrocution, ne pas exposer cet appareil à la pluie ou à l'humidité.

Afin d'écarter tout risque d'électrocution, garder le coffret fermé. Ne confier l'entretien de l'appareil qu'à un personnel qualifié.

CET APPAREIL DOIT ÊTRE RELIÉ À LA TERRE.

WARNING

Um die Gefahr von Bränden oder elektrischen Schlägen zu verringern, darf dieses Gerät nicht Regen oder Feuchtigkeit ausgesetzt werden.

Um einen elektrischen Schlag zu vermeiden, darf das Gehäuse nicht geöffnet werden. Überlassen Sie

Wartungsarbeiten stets nur qualifiziertem Fachpersonal.

DIESES GERÄT MUSS GEERDET WERDEN.

For the customers in the U.S.A. and Canada

WARNING:

Using this unit at a voltage other than 120 V may require the use of a different line cord or attachment plug, or both. To reduce the risk of fire or electric shock, refer servicing to qualified service personnel.

For the customers in the U.S.A.

This equipment has been tested and found to comply with the limits for a Class B digital device, pursuant to Part 15 of the FCC Rules. These limits are designed to provide reasonable protection against harmful interference in a residential installation. This equipment generates, uses, and can radiate radio frequency energy and, if not installed and used in accordance with the instructions, may cause harmful interference to radio communications. However, there is no guarantee that interference will not occur in a particular installation. If this equipment does cause harmful interference to radio or television reception, which can be determined by turning the equipment off and on, the user is encouraged to try to correct the interference by one or more of the following measures:

- Reorient or relocate the receiving antenna.
- Increase the separation between the equipment and receiver.
- Connect the equipment into an outlet on a circuit different from that to which the receiver is connected.
- Consult the dealer or an experienced radio/TV technician for help.

You are cautioned that any changes or modifications not expressly approved in this manual could void your authority to operate this equipment.

All interface cables used to connect peripherals must be shielded in order to comply with the limits for a digital device pursuant to Subpart B of Part 15 of FCC Rules.

If you have any questions about this product, you may call;
Sony Customer Information Service Center
1-800-222-7669 or <http://www.sony.com/>

Declaration of Conformity

Trade Name: SONY
Model: VPL-HW20/HW20A
Responsible party: Sony Electronics Inc.
Address: 16530 Via Esprillo,
San Diego, CA 92127
U.S.A.
Telephone Number: 858-942-2230

This device complies with part 15 of the FCC Rules. Operation is subject to the following two conditions: (1) this device may not cause harmful interference, and (2) this device must accept any interference received, including interference that may cause undesired operation.

For the customers in Canada (for VPL-HW20)

This Class B digital apparatus complies with Canadian ICES-003.

Pour les clients au Canada (pour VPL-HW20)

Cet appareil numérique de la classe B est conforme à la norme NMB-003 du Canada.

For the customers in Europe

The manufacturer of this product is Sony Corporation, 1-7-1 Konan, Minato-ku, Tokyo, 108-0075 Japan.
The Authorized Representative for EMC and product safety is Sony Deutschland GmbH, Hedelfinger Strasse 61, 70327 Stuttgart, Germany. For any service or guarantee matters please refer to the addresses given in separate service or guarantee documents.

Pour les clients en Europe

Le fabricant de ce produit est Sony Corporation, 1-7-1 Konan, Minato-ku, Tokyo, 108-0075 Japon.

Le représentant autorisé pour EMC et la sécurité des produits est Sony Deutschland GmbH, Hedelfinger Strasse 61, 70327 Stuttgart, Allemagne. Pour toute question concernant le service ou la garantie, veuillez consulter les adresses indiquées dans les documents de service ou de garantie séparés.

Für Kunden in Europa

Der Hersteller dieses Produkts ist Sony Corporation, 1-7-1 Konan, Minato-ku, Tokyo, 108-0075 Japan.

Der autorisierte Repräsentant für EMV und Produktsicherheit ist Sony Deutschland GmbH, Hedelfinger Strasse 61, 70327 Stuttgart, Deutschland. Bei jeglichen Angelegenheiten in Bezug auf Kundendienst oder Garantie wenden Sie sich bitte an die in den separaten Kundendienst- oder Garantiedokumenten aufgeführten Anschriften.

For kundene i Norge

Dette utstyret kan kobles til et IT-strømfordelingssystem.

Für Kunden in Deutschland

Entsorgungshinweis: Bitte werfen Sie nur entladene Batterien in die Sammelboxen beim Handel oder den Kommunen. Entladen sind Batterien in der Regel dann, wenn das Gerät abschaltet und signalisiert „Batterie leer“ oder nach längerer Gebrauchsdauer der Batterien „nicht mehr einwandfrei funktioniert“. Um sicherzugehen, kleben Sie die Batteriepole z.B. mit einem Klebestreifen ab oder geben Sie die Batterien einzeln in einen Plastikbeutel.

For the customers in Taiwan only



廢電池請回收

Table of Contents

Precautions 6

Location of Controls

Front/Right Side 7
Rear/Bottom 8
Remote Control 9

Connections and Preparations

Unpacking 10
Step 1: Installing the Projector 11
 Before Setting Up the
 Projector 11
 Positioning the Projector and a
 screen 13
Step 2: Adjusting the Picture
Position 17
Step 3: Connecting the Projector 22
 Connecting to a VCR 22
 Connecting to a Computer 25
Step 4: Selecting the Menu
Language 26

Projecting

Projecting the Picture on the
Screen 28
 Turning Off the Power 29
Operating the BRAVIA Sync
Compatible Equipment with the
Remote Control of the Projector 30
Selecting the Wide Screen Mode 32
Selecting the Picture Viewing
Mode 34
Adjusting the Picture Quality 35
 Selecting to Directly Adjust the
 Desired Menu Item 35
 Selecting Desired Adjust Menu
 Items in the Order 36
Adjusting the Picture Using Real
Color Processing 37

Using the Menus

Operation through the Menus 39
Picture Menu 43
Advanced Picture Menu 47
Screen Menu 48
Setup Menu 50
Function Menu 52
Installation Menu 54
Information Menu 56
 About the Preset Memory No. 57

Others

About the Control for HDMI	58
About the x.v.Color	59
Troubleshooting	60
Warning Indicators	63
Message Lists	64
Replacing the Lamp and the Air Filter and Cleaning the Ventilation Holes (intake)	65
Cleaning the Air Filter	68
Fitting the Lens Cap	68
Cleaning and the Screen of the Projector	69
Specifications	70
Preset Signals	72
Input Signals and Adjustable/ Setting Items	75
Ceiling Installation	77
Index	81

Trademark Information

“PS3” is a registered trademark of Sony Computer Entertainment Inc.

HDMI, the HDMI logo and High-Definition Multimedia Interface are trademarks or registered trademarks of HDMI Licensing LLC.

“Blu-ray Disc” is a trademark.

.....
Control for HDMI is an HDMI standard mutual control function which uses the HDMI CEC (Consumer Electronics Control) specification. This projector supports DeepColor, x.v.Color, LipSync and computer input signal of HDMI standards. It also supports HDCP.

Precautions

On safety

- Check that the operating voltage of your unit is identical with the voltage of your local power supply.
- Should any liquid or solid object fall into the cabinet, unplug the unit and have it checked by qualified personnel before operating it further.
- Unplug the unit from the wall outlet if it is not to be used for several days.
- To disconnect the cord, pull it out by the plug. Never pull the cord itself.
- The wall outlet should be near the unit and easily accessible.
- The unit is not disconnected to the AC power source (mains) as long as it is connected to the wall outlet, even if the unit itself has been turned off.
- Do not look into the lens while the lamp is on.
- Do not place your hand or objects near the ventilation holes. The air coming out is hot.

On preventing internal heat build-up

After you turn off the power with the I/⏻ (ON/STANDBY) switch, do not disconnect the unit from the wall outlet while the cooling fan is still running.

Caution

The projector is equipped with ventilation holes (intake) and ventilation holes (exhaust). Do not block or place anything near these holes, or internal heat build-up may occur, causing picture degradation or damage to the projector.

On repacking

Save the original shipping carton and packing material; they will come in handy if you ever have to ship your unit. For maximum protection, repack your unit as it was originally packed at the factory.

Location of Controls

Front/Right Side

You can use the buttons on the control panel with the same names as those on the remote control to operate the projector.

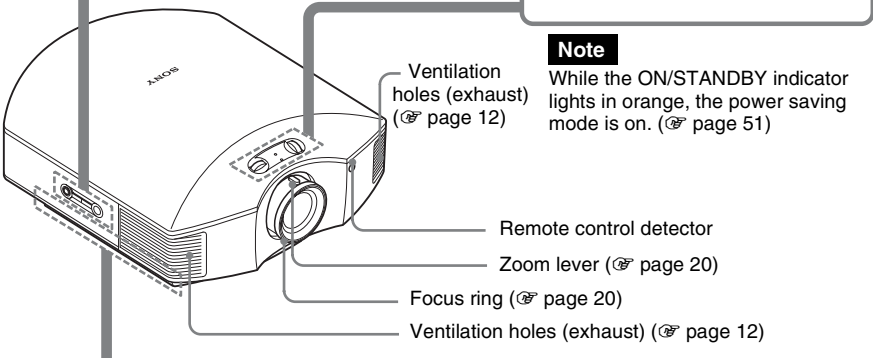
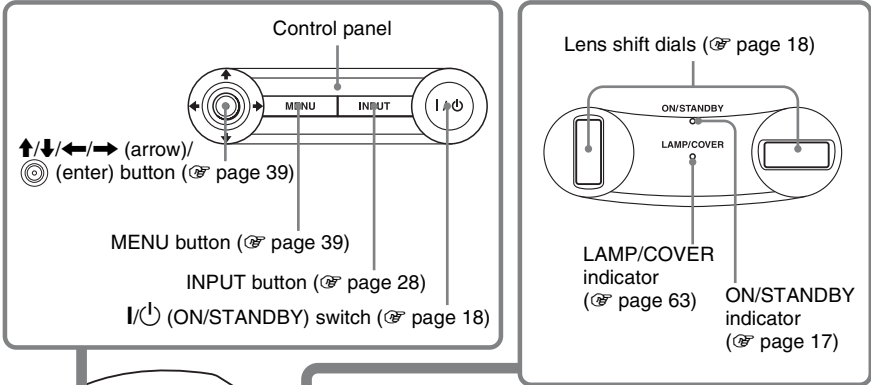

Note
While the ON/STANDBY indicator lights in orange, the power saving mode is on. (☞ page 51)

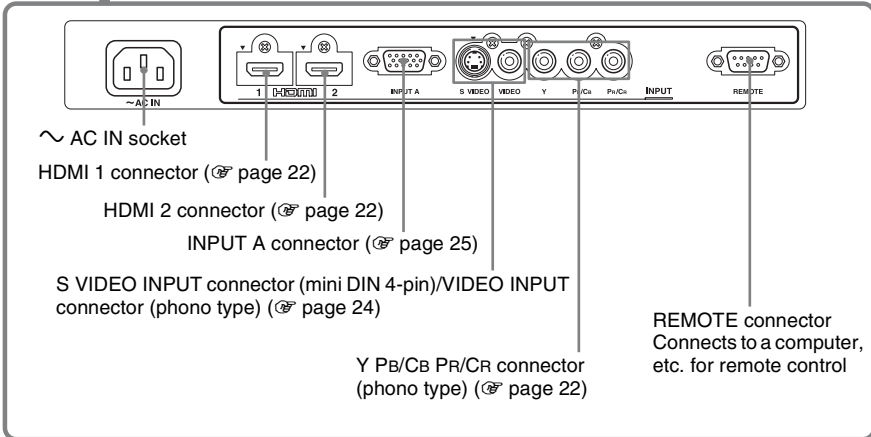

Rear/Bottom

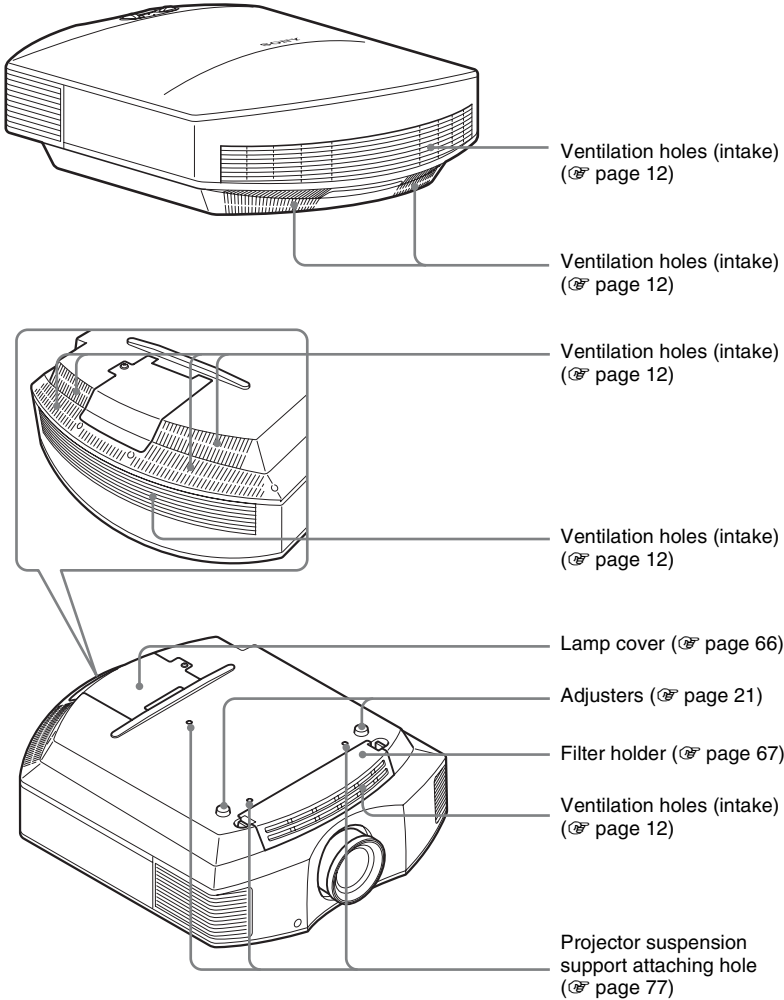

Remote Control

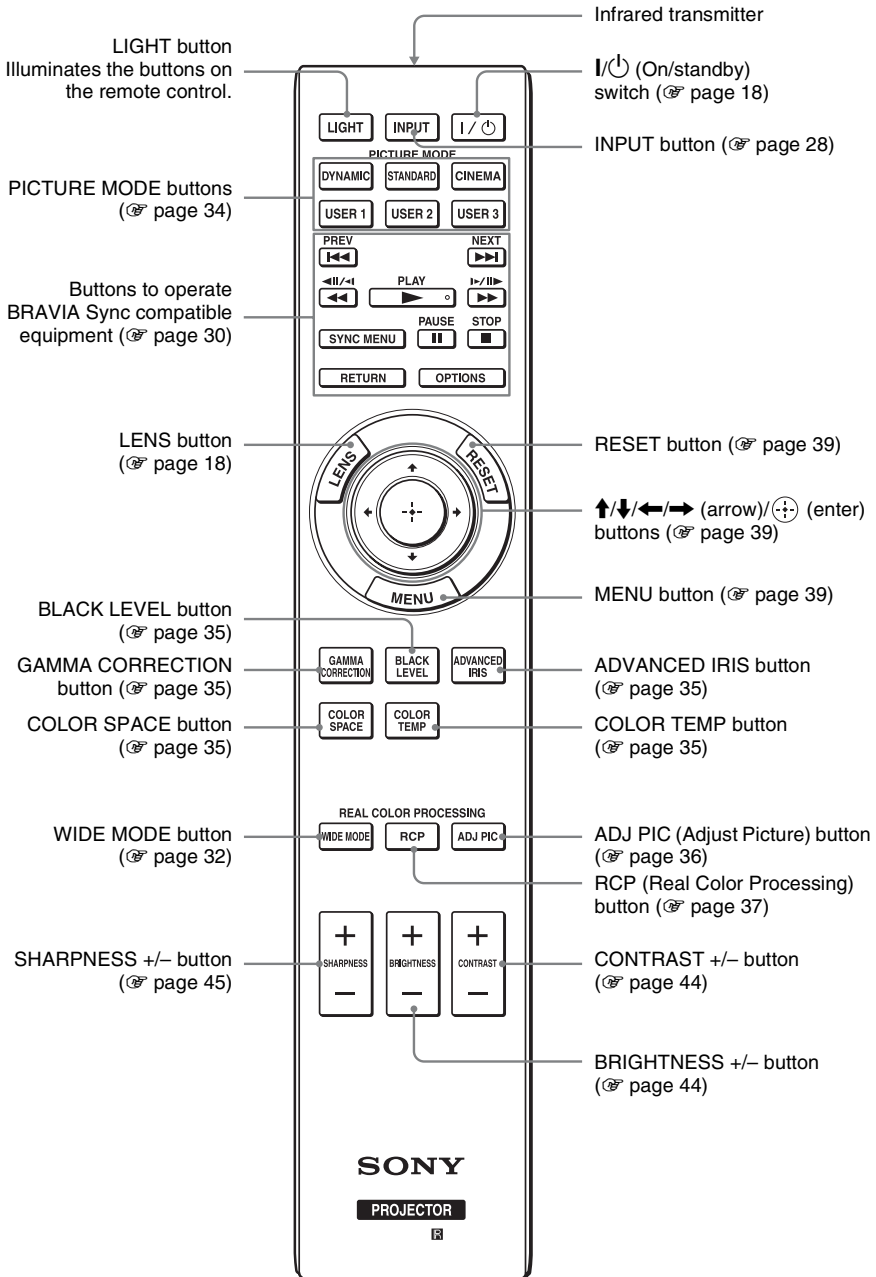

Connections and Preparations

This section describes how to install the projector and screen, how to connect the equipment from which you want to project the picture, etc.

Unpacking

Check the carton to make sure it contains the following items:

- Remote control (1) and Size AA (R6) manganese batteries (2)
- AC power cord (1)
- Lens cap (1)
When you have purchased the projector, the lens cap is put onto the lens. Remove this lens cap when you use the projector.
- Operating Instructions (this manual)

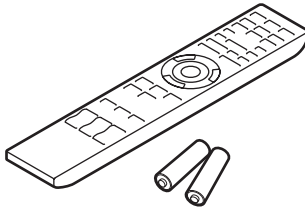

Inserting the batteries into the remote control

Insert the batteries  side first as shown in the illustration. Inserting them forcibly or with the polarities reversed may cause a short circuit and may generate heat.

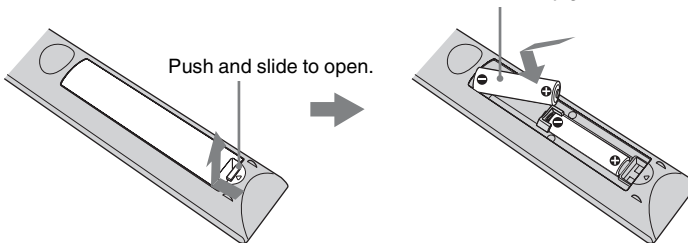

CAUTION

Danger of explosion if battery is incorrectly replaced.

Replace only with the same or equivalent type recommended by the manufacturer.

When you dispose of the battery, you must obey the law in the relative area or country.

Installing batteries

Two size AA (R6) batteries are supplied for Remote Control.

To avoid risk of explosion, use size AA (R6) manganese or alkaline batteries.

Caution about handling the remote control

- Handle the remote control with care. Do not drop or step on it, or spill liquid of any kind onto it.
- Do not place the remote in a location near a heat source, a place subject to direct sunlight, or a damp room.

Step 1: Installing the Projector

The projector displays pictures output from a VCR or other device.

The lens shift allows you to have broader options for placing the projector and viewing pictures easily.

Before Setting Up the Projector

Unsuitable installation

Do not place the projector in the following situations, which may cause malfunction or damage to the projector.

Poorly ventilated location

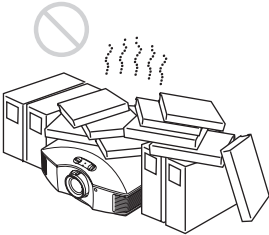

Leave space of more than 30 cm (11 ⁷/₈ inches) around the unit.

Hot and humid



Locations subject to direct cool or warm air from an air-conditioner

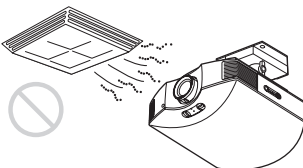

Installing the projector in such a location may cause a malfunction of the unit due to moisture condensation or rise in temperature.

Near a heat or smoke sensor

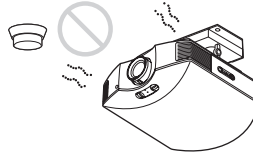

Malfunction of the sensor may occur.

Very dusty and extremely smoky locations



Install in a location away from walls

To maintain the performance and reliability of the projector, allow at least 30 cm (11 ⁷/₈ inches) between the projector and walls.

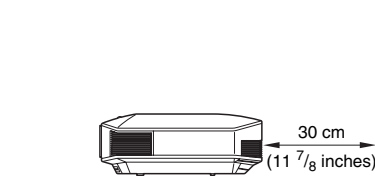
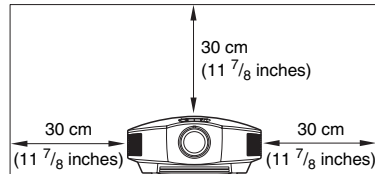

Improper use

Do not do any of the following while using the projector.

Blocking the ventilation holes (intake or exhaust)

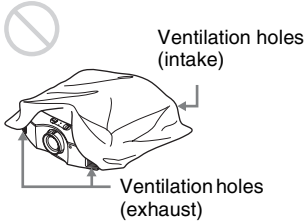

Tip

For details on the location of the ventilation holes (intake or exhaust), see “Location of Controls” (📖 page 7).

Tilting front/rear and left/right

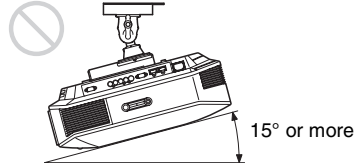
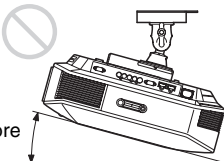
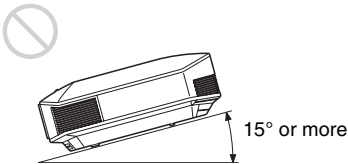
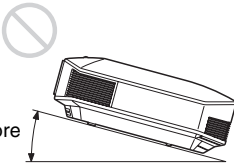
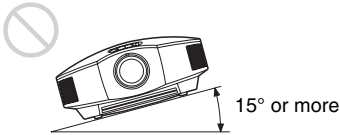

Avoid using the projector tilted at an angle of more than 15 degrees.

Do not install the projector anywhere other than on a level surface or on the ceiling. Installing the projector in such a location may result in uneven color uniformity or reduce the reliability of the effects of the lamp.

When installing the unit at altitudes

When using the projector at an altitude of 1,500 m or higher, set “Cooling Setting” in the Setup  menu to “High” (📖 page 50). Failing to set this mode when using the projector at high altitudes could have adverse effects, such as reducing the reliability of certain components.

WARNING

When installing the unit, incorporate a readily accessible disconnect device in the fixed wiring, or connect the power plug to an easily accessible socket-outlet near the unit. If a fault should occur during operation of the unit, operate the disconnect device to switch the power supply off, or disconnect the power plug.

Positioning the Projector and a screen

The installation distance between the projector and a screen varies depending on the size of the screen or whether or not you use the lens shift features.

1 Determine the installation position of the projector and screen.

You can obtain a good quality picture if you position the projector so that the center of the lens is within the area indicated in gray in the illustration.

Use the values L , x and y in the table on page 15 or 16 as a guide.

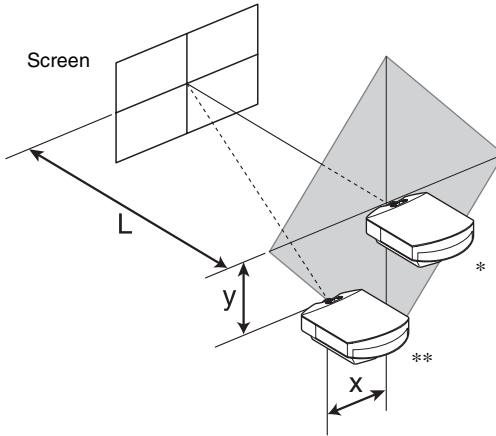

* Installation position not using lens shift ($x = 0$, $y = 0$)

** Example of installation position using lens shift (x , y)

L: Distance between the screen and the front end of the projector's lens.

x: Horizontal distance between the center of the screen and the center of the projector's lens.

y: Vertical distance between the center of the screen and the center of the projector's lens.

For installation of the projector on a ceiling, see "Ceiling Installation."
(☞ page 77)

For details on the lens shift feature, see "Step 2: Adjusting the Picture Position."
(☞ page 17)

When using the 16:9 aspect ratio screen size

Screen Size SS (inches)		40	60	80	100	120	150	200	250	300
(mm)		1016	1524	2032	2540	3048	3810	5080	6350	7620
L	minimum	1201 (47 ³ / ₈)	1825 (71 ⁷ / ₈)	2448 (96 ¹ / ₂)	3072 (121)	3695 (145 ¹ / ₂)	4631 (182 ³ / ₈)	6189 (243 ³ / ₄)	7748 (305 ¹ / ₈)	9307 (366 ¹ / ₂)
	maximum	1840 (72 ¹ / ₂)	2782 (109 ⁵ / ₈)	3723 (146 ⁵ / ₈)	4664 (183 ⁵ / ₈)	5605 (220 ³ / ₄)	7017 (276 ³ / ₈)	9371 (369)	11724 (461 ⁵ / ₈)	14077 (554 ¹ / ₄)
x		0 (0)	0 (0)	0 (0)	0 (0)	0 (0)	0 (0)	0 (0)	0 (0)	0 (0)
y		324 (12 ⁷ / ₈)	486 (19 ¹ / ₄)	648 (25 ⁵ / ₈)	809 (31 ⁷ / ₈)	971 (38 ¹ / ₄)	1214 (47 ⁷ / ₈)	1619 (63 ³ / ₄)	2024 (79 ³ / ₄)	2428 (95 ⁵ / ₈)
x		44 (1 ³ / ₄)	66 (2 ⁵ / ₈)	89 (3 ⁵ / ₈)	111 (4 ³ / ₈)	133 (5 ¹ / ₄)	166 (6 ⁵ / ₈)	221 (8 ³ / ₄)	277 (11)	332 (13 ¹ / ₈)
y		259 (10 ¹ / ₄)	389 (15 ³ / ₈)	518 (20 ¹ / ₂)	648 (25 ⁵ / ₈)	777 (30 ⁵ / ₈)	971 (38 ¹ / ₄)	1295 (51)	1619 (63 ³ / ₄)	1943 (76 ¹ / ₂)
x		89 (3 ⁵ / ₈)	133 (5 ¹ / ₄)	177 (7)	221 (8 ³ / ₄)	266 (10 ¹ / ₂)	332 (13 ¹ / ₈)	443 (17 ¹ / ₂)	553 (21 ⁷ / ₈)	664 (26 ¹ / ₄)
y		194 (7 ³ / ₄)	291 (11 ¹ / ₂)	389 (15 ³ / ₈)	486 (19 ¹ / ₄)	583 (23)	728 (28 ³ / ₄)	971 (38 ¹ / ₄)	1214 (47 ⁷ / ₈)	1457 (57 ³ / ₈)
x		133 (5 ¹ / ₄)	199 (7 ⁷ / ₈)	266 (10 ¹ / ₂)	332 (13 ¹ / ₈)	398 (15 ³ / ₄)	498 (19 ⁵ / ₈)	664 (26 ¹ / ₄)	830 (32 ³ / ₄)	996 (39 ¹ / ₄)
y		130 (5 ¹ / ₈)	194 (7 ³ / ₄)	259 (10 ¹ / ₄)	324 (12 ⁷ / ₈)	389 (15 ³ / ₈)	486 (19 ¹ / ₄)	648 (25 ⁵ / ₈)	809 (31 ⁷ / ₈)	971 (38 ¹ / ₄)
x		177 (7)	266 (10 ¹ / ₂)	354 (14)	443 (17 ¹ / ₂)	531 (21)	664 (26 ¹ / ₄)	886 (35)	1107 (43 ⁵ / ₈)	1328 (52 ³ / ₈)
y		65 (2 ⁵ / ₈)	97 (3 ⁷ / ₈)	130 (5 ¹ / ₈)	162 (6 ¹ / ₂)	194 (7 ³ / ₄)	243 (9 ⁵ / ₈)	324 (12 ⁷ / ₈)	405 (16)	486 (19 ¹ / ₄)
x		221 (8 ³ / ₄)	332 (13 ¹ / ₈)	443 (17 ¹ / ₂)	553 (21 ⁷ / ₈)	664 (26 ¹ / ₄)	830 (32 ³ / ₄)	1107 (43 ⁵ / ₈)	1384 (54 ¹ / ₂)	1660 (65 ³ / ₈)
y		0 (0)	0 (0)	0 (0)	0 (0)	0 (0)	0 (0)	0 (0)	0 (0)	0 (0)

Unit: mm (inches)

To calculate the installation positions

$$L (\text{minimum}) = 31.1781 (1 \frac{7}{32}) \times SS - 46.1543 (1 \frac{13}{16})$$

$$L (\text{maximum}) = 47.0644 (1 \frac{27}{32}) \times SS - 42.3308 (1 \frac{21}{32})$$

$$y = -1.463 \times x (\text{mm or inch}) + 8.0942 (5 \frac{5}{16}) \times SS$$

When using the 4:3 aspect ratio screen size

Screen Size SS (inches)		40	60	80	100	120	150	200	250	300
(mm)		1016	1524	2032	2540	3048	3810	5080	6350	7620
L	minimum	1480 (58 3/8)	2243 (88 3/8)	3006 (118 3/8)	3770 (148 1/2)	4533 (178 1/2)	5677 (223 5/8)	7585 (298 5/8)	9493 (373 3/4)	11401 (448 7/8)
	maximum	2262 (89 1/8)	3414 (134 1/2)	4566 (179 7/8)	5718 (225 1/8)	6870 (270 1/2)	8598 (338 5/8)	11478 (452)	14357 (565 1/4)	17237 (678 5/8)
x		0 (0)	0 (0)	0 (0)	0 (0)	0 (0)	0 (0)	0 (0)	0 (0)	0 (0)
y		396 (15 5/8)	594 (23 1/2)	792 (31 1/4)	991 (39 1/8)	1189 (46 7/8)	1486 (58 5/8)	1981 (78)	2477 (97 5/8)	2972 (117 1/8)
x		54 (2 1/4)	81 (3 1/4)	108 (4 3/8)	135 (5 3/8)	163 (6 1/2)	203 (8)	271 (10 3/4)	339 (13 3/8)	406 (16)
y		317 (12 1/2)	475 (18 3/4)	634 (25)	792 (31 1/4)	951 (37 1/2)	1189 (46 7/8)	1585 (62 1/2)	1981 (78)	2377 (93 5/8)
x		108 (4 3/8)	163 (6 1/2)	217 (8 5/8)	271 (10 3/4)	325 (12 7/8)	406 (16)	542 (21 3/8)	677 (26 3/4)	813 (32 1/8)
y		238 (9 3/8)	357 (14 1/8)	475 (18 3/4)	594 (23 1/2)	713 (28 1/8)	892 (35 1/8)	1189 (46 7/8)	1486 (58 5/8)	1783 (70 1/4)
x		163 (6 1/2)	244 (9 3/8)	325 (12 7/8)	406 (16)	488 (19 1/4)	610 (24 1/8)	813 (32 1/8)	1016 (40)	1219 (48)
y		158 (6 1/4)	238 (9 3/8)	317 (12 1/2)	396 (15 5/8)	475 (18 3/4)	594 (23 1/2)	792 (31 1/4)	991 (39 1/8)	1189 (46 7/8)
x		217 (8 5/8)	325 (12 7/8)	433 (17 1/8)	542 (21 3/8)	650 (25 5/8)	813 (32 1/8)	1084 (42 3/4)	1355 (53 3/8)	1626 (64 1/8)
y		79 (3 1/8)	119 (4 3/4)	158 (6 1/4)	198 (7 7/8)	238 (9 3/8)	297 (11 3/4)	396 (15 5/8)	495 (19 1/2)	594 (23 1/2)
x		271 (10 3/4)	406 (16)	542 (21 3/8)	677 (26 3/4)	813 (32 1/8)	1016 (40)	1355 (53 3/8)	1693 (66 3/4)	2032 (80)
y		0 (0)	0 (0)	0 (0)	0 (0)	0 (0)	0 (0)	0 (0)	0 (0)	0 (0)

Unit: mm (inches)

To calculate the installation positions

$$L \text{ (minimum)} = 38.1569 (1 \frac{1}{2}) \times SS - 46.1543 (1 \frac{13}{16})$$

$$L \text{ (maximum)} = 57.5992 (2 \frac{9}{32}) \times SS - 42.3308 (1 \frac{21}{32})$$

$$y = -1.463 \times x \text{ (mm or inch)} + 9.9060 (3 \frac{3}{8}) \times SS$$

2 Position the projector so that the lens is parallel to the screen.

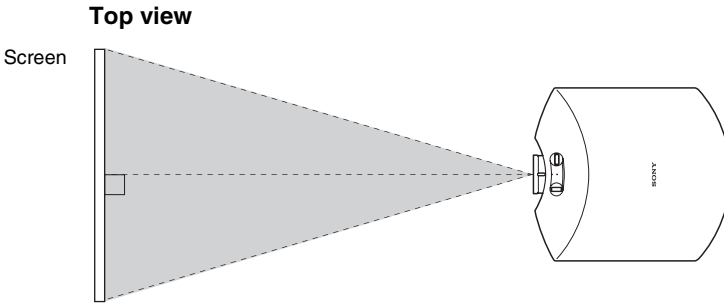

3 Project an image on the screen and adjust the picture so that it fits the screen. (☞ page 17)

Note

When using a screen with an uneven surface, stripes pattern may rarely appear on the screen depending on the distance between the screen and the projector or the zooming magnifications. This is not a malfunction of the projector.

Step 2: Adjusting the Picture Position

Project an image on the screen and then adjust the picture position.

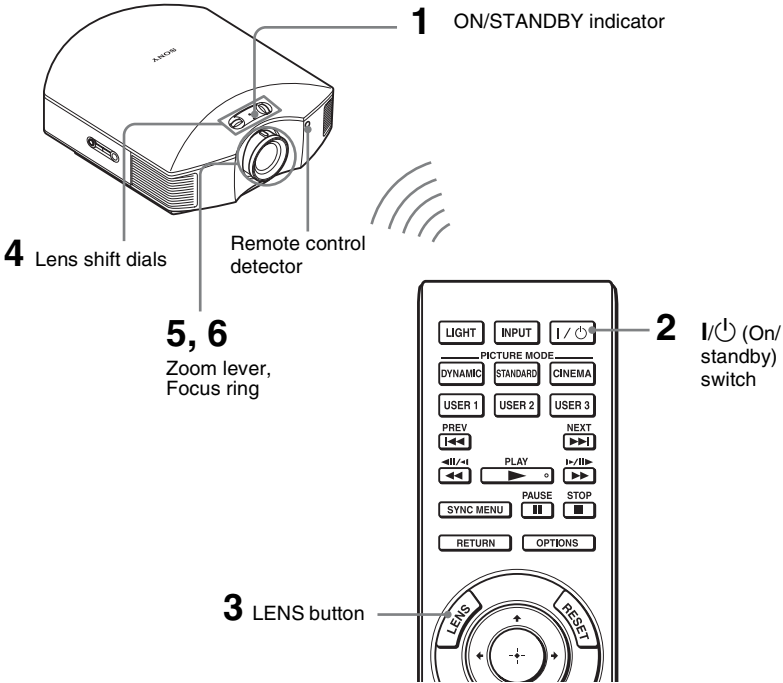

Tip

The I/⏻ (ON/STANDBY), INPUT, MENU, and ↑/↓/←/→/⊙ (joystick) buttons on the side panel of the projector function the same as those on the remote control.

Note

Depending on the installation location of the projector, you may not control it with the remote control. In this case, point the remote control to the screen instead of the projector.



- 1 After connecting the AC cord to the projector plug the AC cord into a wall outlet.**

The ON/STANDBY indicator lights in red and the projector goes into standby mode.

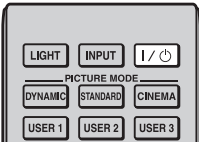

ON/STANDBY



Flashes in green for a while (tens of seconds) and then lights in green.

2 Press the I/⏻ (ON/STANDBY) switch to turn on the projector.

The ON/STANDBY indicator flashes in green, and then lights in green. When the ON/STANDBY indicator flashes, “Starting...” appears on the screen.

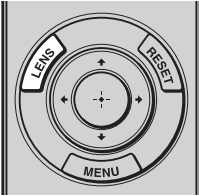

3 Display a test signal for performing adjustments.

Press the LENS button on the remote control to display the test signal.

Tip

The test signal is displayed for 1 minute. Press the  button to clear the test signal display before that.

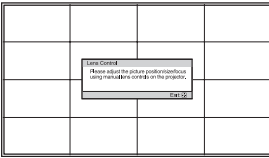

4 Move both lens shift dials to adjust the picture position.

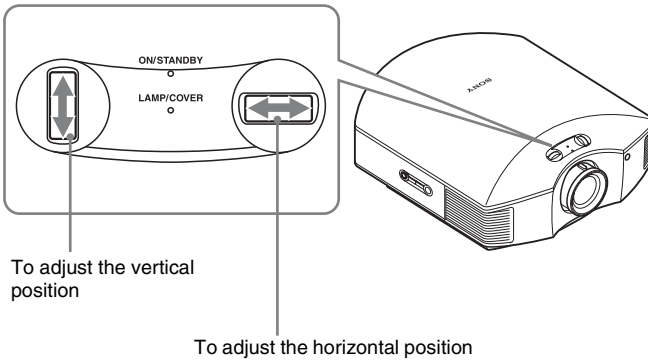

To adjust the horizontal position

Turn the lens shift dial right or left.

The picture projected on the screen moves right or left by a maximum of 25% of the screen width from the center of the lens.

25% 1 screen width 25%

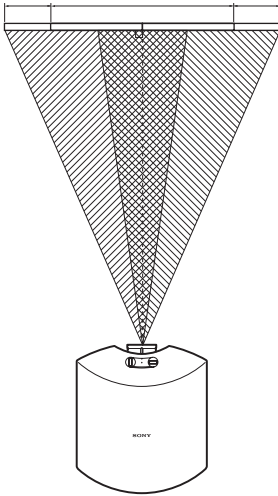

Top view

- : Picture position when moving the picture to the left at maximum
- : Picture position when moving the picture to the right at maximum

To adjust the vertical position

Turn the lens shift dial up or down.

The picture projected on the screen moves up or down by a maximum of 65% of the screen height from the center of the lens.

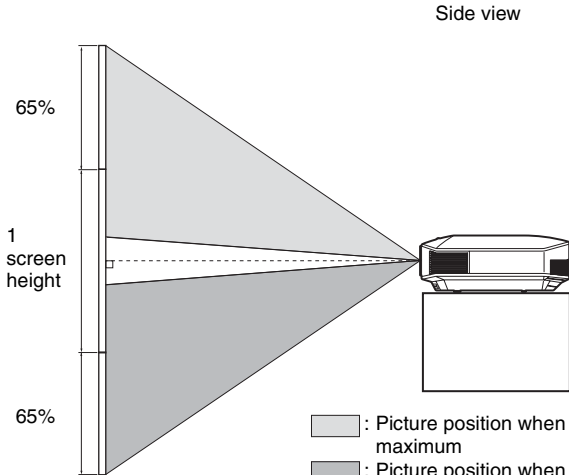

Side view

- : Picture position when moving the picture upward at maximum
- : Picture position when moving the picture downward at maximum

Notes

- The range to move the picture projected on the screen can be adjusted only within the octagon area illustrated below. In this connection, see “Positioning the Projector and a screen” (☞ page 13) as well.

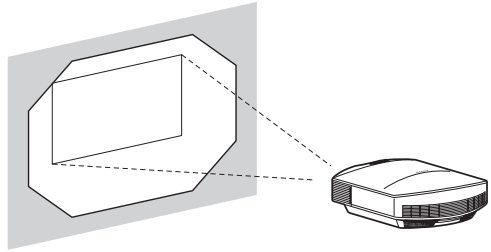
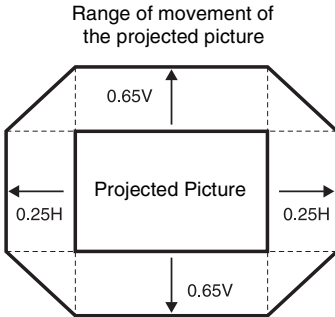

H: Width of the projected picture
V: Height of the projected picture

- When you use both the horizontal and vertical lens shift features at the same time, the distance the picture projected on the screen moves differ depending on how much the lens shift is adjusted. For details, see the table on page 14 or 15.

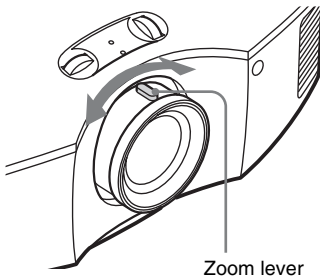

5 Adjust the picture size using the zoom lever.

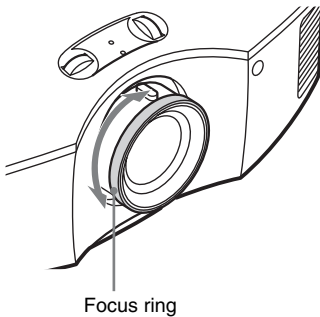

6 Adjust the focus using the focus ring.

To adjust the tilt of the installation surface

If the projector is installed on an uneven surface, use the adjusters to keep the projector level.

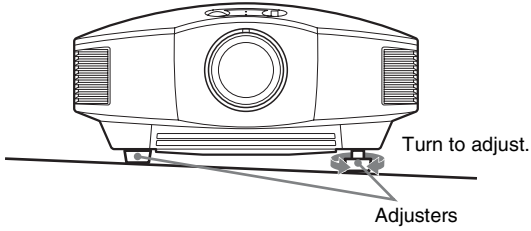

Notes

- Pointing the projector at too high or too low of a tilt will result in trapezoidal distortion in the projected image.
- Be careful not to catch your finger when turning the adjusters.



Step 3: Connecting the Projector

When making connections, be sure to do the following:

- Turn off all equipment before making any connections.
- Use the proper cables for each connection.
- Insert the cable plugs properly; poor connection at the plugs may cause a malfunction or poor picture quality. When pulling out a cable, be sure to pull it out from the plug, not the cable itself.
- Refer to the operating instructions of the connected equipment.

Connecting to a VCR

To connect to equipment with HDMI output connectors

You can enjoy better picture quality by connecting a DVD player/recorder, Blu-ray Disc player/recorder, or PS3[®] equipped with HDMI output to the HDMI input of the projector. Moreover, if you have a Control for HDMI compatible equipment, you can operate the projector synchronizing with the Control for HDMI compatible equipment. For details, see the Function  menu ( page 52) and “About the Control for HDMI” ( page 58).

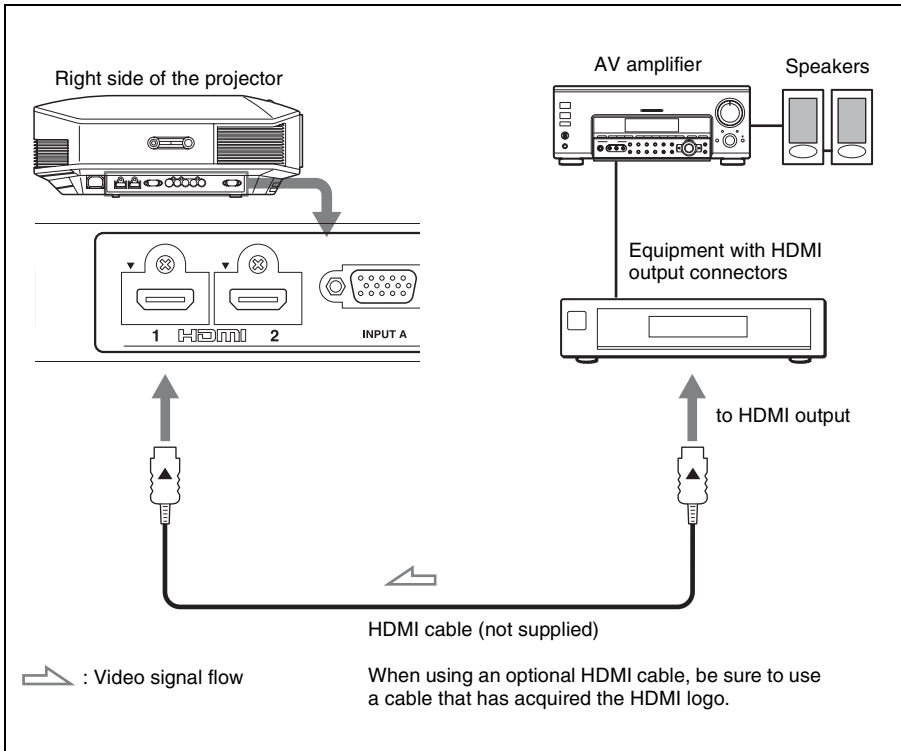

Notes

- When connecting an HDMI cable to the projector, make sure the ▼ mark on the upper part of the HDMI input of the projector and the ▲ mark on the connector of the cable is set at the same position.
- If the picture from equipment connected to the projector with an HDMI cable is not clear, check the settings of the connected equipment.

To connect to equipment with component video output connectors

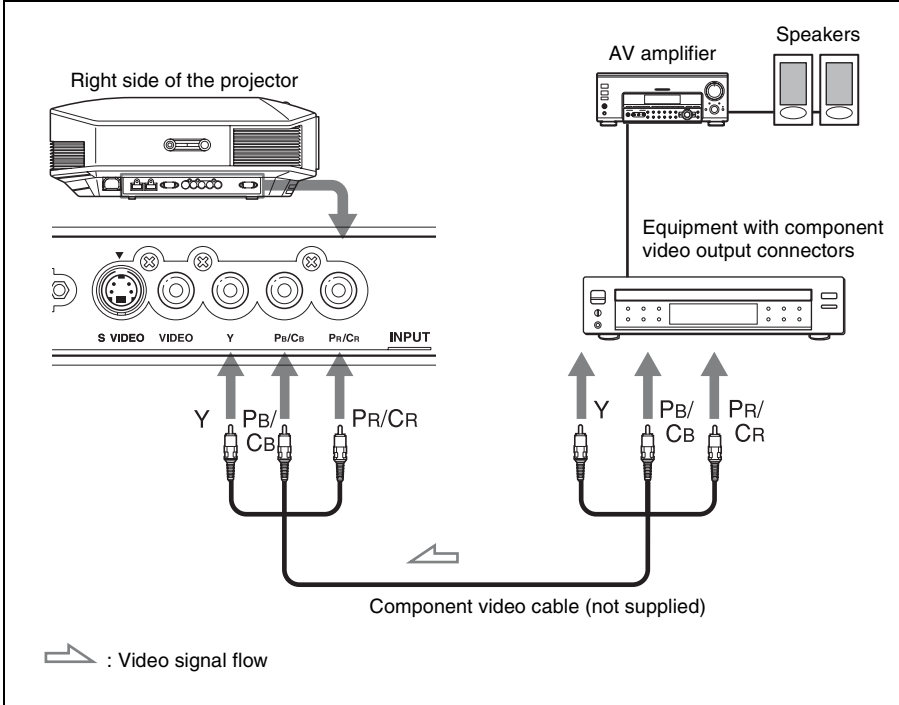

To connect to a VCR equipped with the S video connector or video connector

You can connect a DVD player/recorder, hard disk video recorder, VCR or laser disk player, which is not equipped with component video connectors.

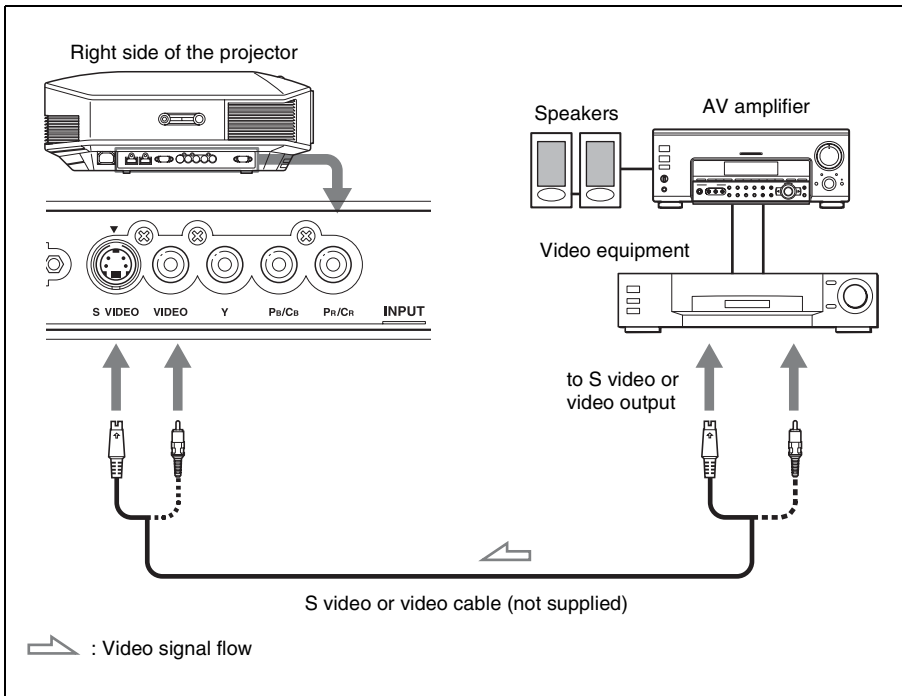

Tip



If you do not know to which connector you should connect the cable, S VIDEO INPUT (S video input connector) or VIDEO INPUT (video input connector), connect it to S VIDEO to enjoy better picture quality.

If the equipment to be connected has no S video connector, connect the cable to the video output.

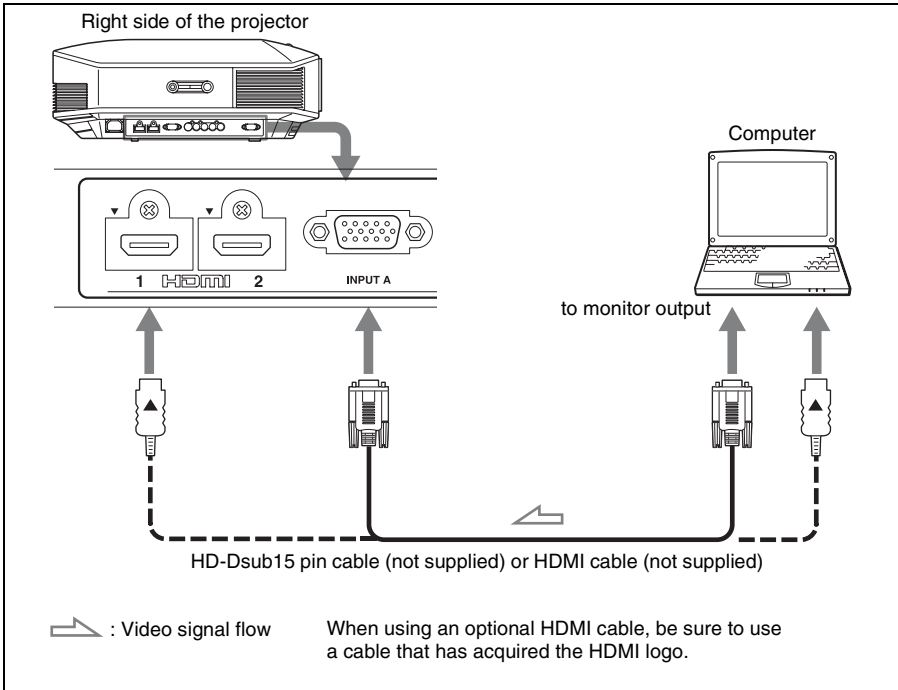
Connecting to a Computer



Tip

When connecting an HD-Dsub15 pin cable, set “Input-A Signal Sel.” in the Setup  menu to “Auto” or “Computer.” If the input signal does not appear properly, set it to “Computer.” ( pages 51, 64)

Notes

- When connecting an HDMI cable, make sure the ▼ mark on the upper part of the HDMI input of the projector and the ▲ mark on the connector of the cable is set at the same position.
- If you set your computer, such as a notebook type, to output the signal to both computer’s display and this equipment, the picture of the equipment may not appear properly. Set your computer to output the signal to only the external monitor.
For details, refer to the computer’s operating instructions supplied with your computer. For settings of the computer, consult with the manufacturer of the computer.
- If the picture from equipment connected to the projector with an HDMI cable is not clear, check the settings of the connected equipment.

Step 4: Selecting the Menu Language

You can select one of 16 languages for displaying the menu and other on-screen displays. The factory default setting is English. To change the current menu language, set the desired language with the menu screen.

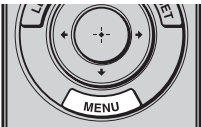
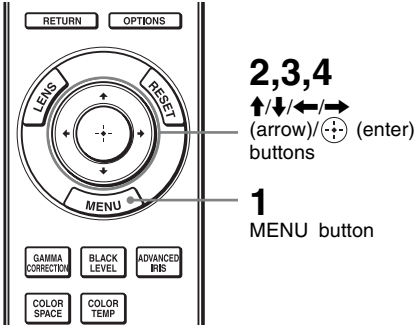

- 1 Press MENU.**
The menu appears.

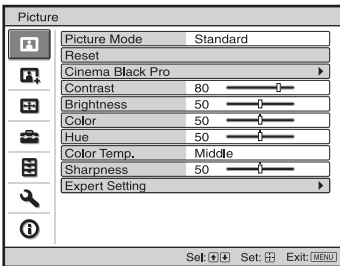

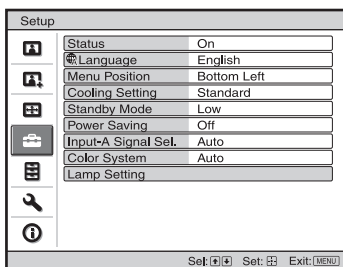
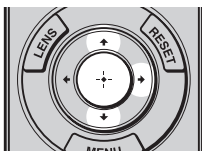

- 2** Press **↑/↓** to select the **Setup** menu, and press **→** or **⊕**.

The setting items of the selected menu appears.

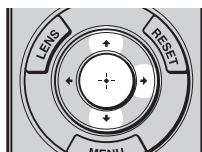

- 3** Press **↑/↓** to select “Language,” and press **→** or **⊕**.

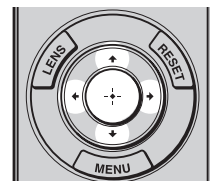

- 4** Press **↑/↓/←/→** to select a language, and press **⊕**.

The menu changes to the selected language.

To clear the menu

Press MENU.

Projecting

This section describes how to operate the projector to view the picture from the equipment connected to the projector. It also describes how to adjust the quality of the picture to suit your taste.

Projecting the Picture on the Screen

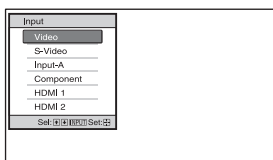
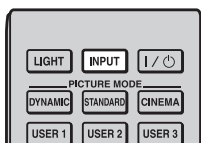



Example: To view the picture from the video equipment connected to the VIDEO INPUT connector.



- 1 Power on both the projector and the equipment connected to the projector.**
- 2 Press INPUT to display the input palette on the screen.**
- 3 Select the equipment from which you want to display images.**

Press INPUT repeatedly or press \uparrow/\downarrow (enter) to select the equipment from which to project.

To view the picture from	Press INPUT to display
Video equipment connected to the VIDEO INPUT connector	Video
Video equipment connected to the S VIDEO INPUT connector	S-Video
RGB/component equipment connected to the INPUT A connector	Input-A*
Component equipment connected to the Y Pb/Cb Pr/Cr connector	Component
Equipment connected to the HDMI 1 connector	HDMI 1
Equipment connected to the HDMI 2 connector	HDMI 2

* Set the “Input-A Signal Sel.” setting in the Setup  menu according to the signal input. When you set it to “Auto,” and cannot display the picture properly, select an appropriate signal according to the input signal. ( pages 51, 57)

Tips

- When “Auto Input Search” is set to “On” in the Function  menu, only input terminals with effective signals are displayed in the input palette.
- When “Status” is set to “Off” in the Setup  menu, the input palette does not appear. Press of the INPUT button to switch between input terminals in sequence.
- When the “Control for HDMI” is set to “On” in the Function  menu, the input terminal with effective signals is automatically displayed, synchronizing with the operation of the equipment connected to HDMI 1 or HDMI 2 input of the projector. (Only when the connected equipment supports Control for HDMI compatible.)



Notes on input of HDMI signal

The projector adjusts the RGB dynamic range of the equipment connected with HDMI cable to the following to suit the HDMI standard and display in best picture quality.

When video signal is input: Limited (16-235)

When computer signal is input: Full (0-255)

When a signal other than those of HDMI standard is input, the following symptoms may occur.

- When a video signal is input, the color gradation of the dark area or bright area may become unclear, or texts may become faded. In this case, switch the RGB dynamic range of the connected equipment to Limited (16-235). If this adjustment is unavailable, adjust “Brightness”, “Contrast”, or “Sharpness” in the Picture  menu of the projector. (☞ page 44)
- * When a computer signal is input, the texts may become faded. In this case, adjust the “Sharpness” in the Picture  menu. (☞ page 45) (* 1,920 × 1,080 or 1,280 × 720 signals)

Turning Off the Power

1 Press the I/⏻ (ON/STANDBY) switch.

A message “POWER OFF?” appears on the screen.

2 Press the I/⏻ (ON/STANDBY) switch again before the message disappears.

The ON/STANDBY indicator flashes in green and the fan continues to run to reduce the internal heat. First, the ON/STANDBY indicator flashes quickly, during which you will not be able to light up the ON/STANDBY indicator with the I/⏻ (ON/STANDBY) switch.

Note

Never disconnect the power cord while the indicator is flashing.

The fan stops and the ON/STANDBY indicator changes from flashing green to remaining red.

The power is turned off completely, and you can disconnect the power cord.

You can turn off the projector by holding the I/⏻ (ON/STANDBY) switch for about 1 second, instead of performing the above steps.

Operating the BRAVIA Sync Compatible Equipment with the Remote Control of the Projector

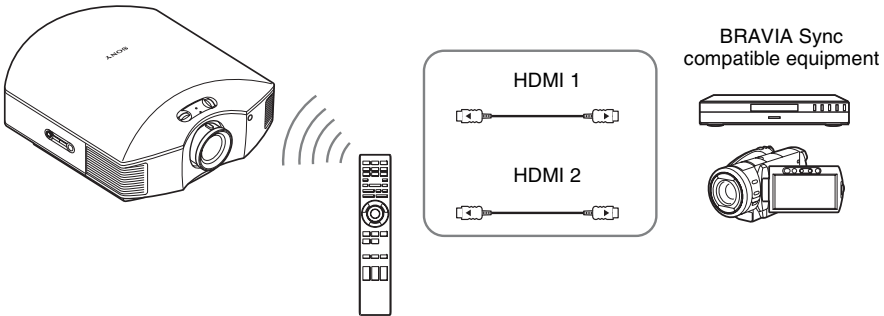

By using the remote control of the projector, you can directly operate the BRAVIA Sync compatible equipment connected to the HDMI 1 and HDMI 2 INPUT connectors of the projector. Only the connected equipment that is currently being viewed can be operated. To operate the BRAVIA Sync compatible equipment, the Control for HDMI setting of the projector and the connected equipment must both be set. (☞ page 52)

Making operations such as playback or stop

Press **◀◀**, **◀**, **▶**, **▶▶**, **▶▶▶**, **⏸**, **■** while viewing pictures.

You can make basic operations such as playback or stop for the connected equipment currently being viewed.

Displaying and operating the menu of the connected equipment currently being viewed

Press SYNC MENU while viewing pictures. Operating menu of the connected equipment currently being viewed is displayed. Select the menu item to operate with **↑/↓/←/→** or **⊕** or RETURN.

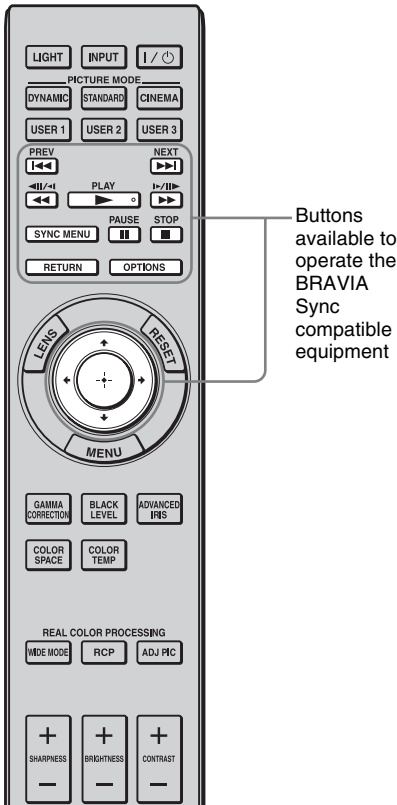

Note

You cannot operate the BRAVIA Sync compatible equipment with the remote control of the projector while the menu of the projector is being displayed.

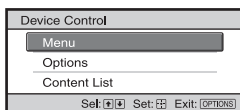

Using the OPTIONS button to operate

- 1 Press **OPTIONS** while viewing pictures from the connected BRAVIA Sync compatible equipment.

Device Control screen is displayed.

- 2 Select the desired menu item to operate with **↑/↓/⊕**.

The screen of the selected menu item is displayed.

Operate through the menu or select a menu item with **↑/↓/←/→/⊕**.

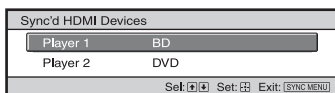

Switching the input setting to the BRAVIA Sync compatible equipment

- 1 Press **SYNC MENU** while viewing pictures from connected equipment that is not BRAVIA Sync compatible.

Sync'd HDMI Devices screen is displayed.*1

- 2 Select the name of the equipment to use with **↑/↓** and press **⊕**.

The power of the selected equipment will turn on, and the input setting of the projector will switch to the terminal of the selected equipment.*2

*1 Only the Control for HDMI compatible equipment connected to HDMI 1 and HDMI 2 INPUT connectors are displayed. Connected equipment will not be displayed when connected to component input connectors, etc. of the projector. Also, connected equipment will not be displayed if it is not compatible with HDMI Control. AV amplifier is also not displayed.

*2 Some equipment may take few minutes for the power to turn on.

Notes

- Only connected equipment compatible with BRAVIA Sync can be operated with the remote control of the projector.
- Functions available to operate differ depending on the equipment.
- For the functions available to operate, refer to the operating instruction of each equipment.

Selecting the Wide Screen Mode

You can enjoy various wide screen modes according to the video signal received.

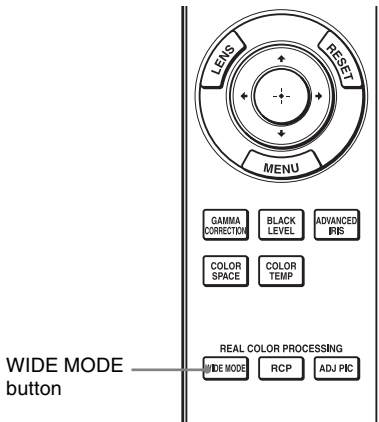

Press WIDE MODE.

Each time you press the button, you can select the “Wide Mode” setting.

You can also select it using the menu.
(☞ page 48)

Original image

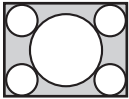

When the Wide Mode is operated

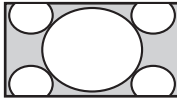

Wide Zoom (When a video signal is input)

A 4:3 aspect ratio picture is enlarged naturally to fill the screen. The upper and lower portions of the screen are slightly cut off.

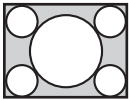

Normal (When a video signal is input)

A 4:3 aspect ratio picture is displayed in the center of the screen and enlarged to fill the screen vertically.

Squeezed

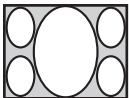

Full (When a video signal is input)

A picture squeezed to 4:3 aspect ratio is displayed in its original aspect ratio. When a 4:3 aspect ratio picture is displayed, the picture is enlarged horizontally to fill the 16:9 screen.

Tip

Squeezed: An original 16:9 aspect ratio picture is recorded horizontally compressed to a 4:3 picture.

Letterbox picture with side panels



Letterbox picture

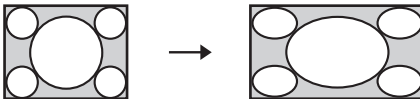
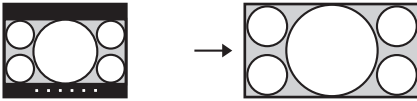

Zoom

A 16:9 aspect ratio picture is enlarged vertically and horizontally in the same ratio to fill the screen. Use this mode to view a letterbox picture or a letterbox picture with side panels.

If the subtitle of a movie, etc. is hidden and cannot be seen, adjust the screen with “Vertical Size” and “V Center” to display the subtitle. (☞ page 49)

Full 1 (When a computer signal is input)

Displays a picture on the whole of the screen without changing the aspect ratio of the original picture.

Full 2 (When a computer signal is input)

Displays a picture on the whole of the screen.

Notes

- You can adjust the vertical position of the picture with “V Center” and “Vertical Size” in the Screen  menu only when “Zoom” is selected. (☞ page 49)
- When the aspect ratio of the computer signal is 16:9 or wider, the “Wide Mode” setting is fixed at “Full 1.”

Notes on selecting the wide screen mode

The projector is featured with the WIDE MODE. When changing the settings of WIDE MODE, use caution as described below.

- Select the wide screen mode taking into account that changing the aspect ratio of the original picture will provide a different look from that of the original image.
- Note that if the projector is used for profit or for public viewing, modifying the original picture by switching to the wide mode may constitute an infringement of the rights of authors or producers, which are legally protected.

Selecting the Picture Viewing Mode

You can select the picture viewing mode that best suits the type of program or room conditions.

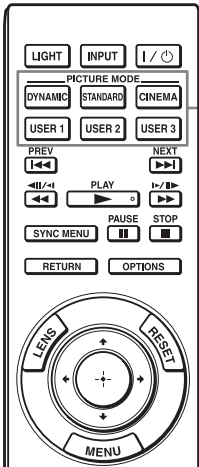

PICTURE MODE buttons

DYNAMIC
STANDARD
CINEMA
USER 1
USER 2
USER 3

Press one of the PICTURE MODE buttons (DYNAMIC, STANDARD, CINEMA, USER 1, USER 2 and USER 3).

DYNAMIC

Project bright images with sharp, vivid picture quality.

STANDARD

Ideal for projecting TV programs, concerts, and other video images.

CINEMA

Picture quality suited for watching movies.

USER 1, USER 2 and USER 3

You can adjust the quality of the picture to suit your taste and store the settings into the selected memory of the projector. Press one of the USER 1, USER 2 and USER 3 buttons, then adjust the picture by using the buttons on the remote control or the menus (pages 35, 43). The settings are stored, and you can view the picture with the adjusted picture quality by pressing the button.

Adjusting the Picture Quality

You can easily adjust the picture quality that suits your taste by selecting the adjustment items with the remote control. The adjusted data can be stored in each picture mode.

Selecting to Directly Adjust the Desired Menu Item

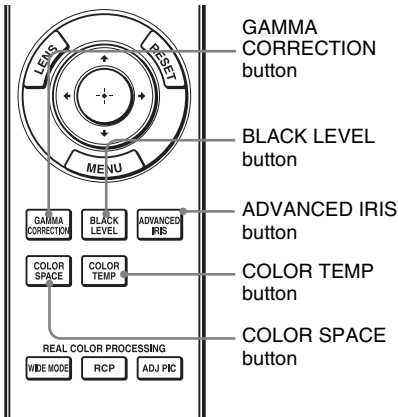

The following menu items can be adjusted by using the buttons on the remote control.

“Gamma Correction”

“Black Level Adj.”

“Advanced Iris”

“Color Temp.”

“Color Space”

Press the following buttons of the desired menu item repeatedly to adjust the picture quality to suit your taste. For details on each menu item, see the Picture  menu. (🔍 page 43)

Selecting Desired Adjust Menu Items in the Order

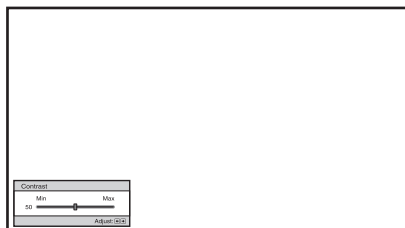
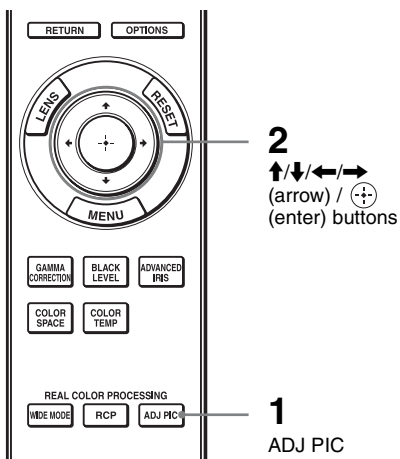



Example: To adjust the contrast

1 Press ADJ PIC.

Each time you press the button, the following adjustment windows are displayed in sequence.

“Advanced Iris”, “Lamp Control”, “Contrast”, “Brightness”, “Color”, “Hue”, “Color Temp.”, “Sharpness”, “NR”, “MPEG NR”, “Film Mode”, “Black Level Adj.”, “Gamma Correction”, “x.v.Color”, “Color Space”

For details on each adjustment, see the Picture  menu. ( page 43)

Note

Some adjustment windows cannot be displayed, depending on the type of input signal. For details, see “Input Signals and Adjustable/Setting Items” ( page 75).

2 Make the setting or adjustment on an item with $\uparrow/\downarrow/\leftarrow/\rightarrow$.

When changing the adjustment level

To increase the value, press \uparrow/\rightarrow .
To decrease the value, press \downarrow/\leftarrow .

When changing the setting

Press \uparrow/\downarrow to change the setting.

Adjusting the Picture Using Real Color Processing

The Real Color Processing (RCP) feature allows you to adjust the color and hue of each target of the projected picture you specify independently. You can thus obtain a picture more suitable to your taste.

Tip

Freeze the scene of the video source when you are adjusting the picture using Real Color Processing.

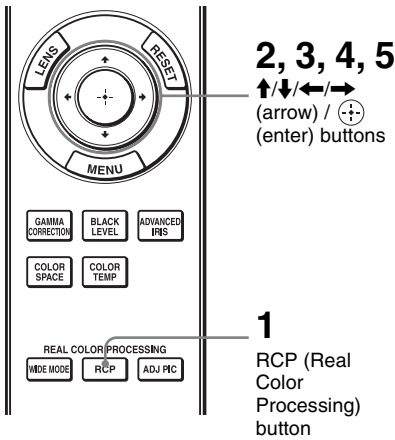

- 1** Press RCP on the remote control.
- 2** Press **↑/↓** to select “User 1,” “User 2” or “User 3,” then press **→**.
The RCP (Real Color Processing) window appears.
- 3** Select the target color you want to adjust.
Repeat steps **1** and **2** described below to specify the target color.

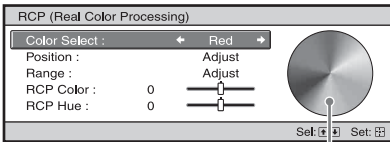

Reference palette

- 1** Press **↑/↓** to select “Color Select,” then press **←/→** to select the color you want to adjust among “Red,” “Yellow,” “Green,” “Cyan,” “Blue” and “Magenta.”

Only the portions that correspond to the specified color will be colored and the other portions will be displayed in black and white. The reference palette in the RCP window also shows the adjustable colors. Select the desired setting to adjust the color on the projected image using the reference palette as a guide.

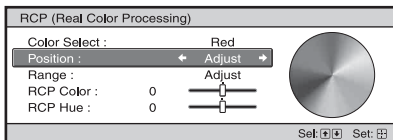

- 2 Press \uparrow/\downarrow to select “Position” or “Range,” and specify it more delicate color position and color range you want to adjust using \leftarrow/\rightarrow .

4 Adjust the color of the specified portions.

Press \uparrow/\downarrow to select “RCP Color” or “RCP Hue,” then adjust the color or hue of the portions selected in step 3 to suit your taste using \leftarrow/\rightarrow while watching the projected picture. The picture is returned to normal color during adjustment.

5 After the adjustment is complete, press \oplus .

The RCP window disappears and the picture of step 2 is appeared. Then after a few seconds, normal picture is restored.

Tip

There are some limitations on selection of position and range.

Using the Menus

This section describes how to make various adjustments and settings using the menus.

Note

The menu displays used for the explanation may be different from the actual menu display.

Operation through the Menus

The projector is equipped with an on-screen menu for making various adjustments and settings. Some of the adjustable/setting items are displayed in a pop-up menu, in a setting menu or adjustment menu with no main menu, or in the next menu window. If you select an item name followed by an arrow (▶), the next menu window with setting items appears. To change the on-screen menu language, see “Step 4: Selecting the Menu Language.” (☞ page 26)

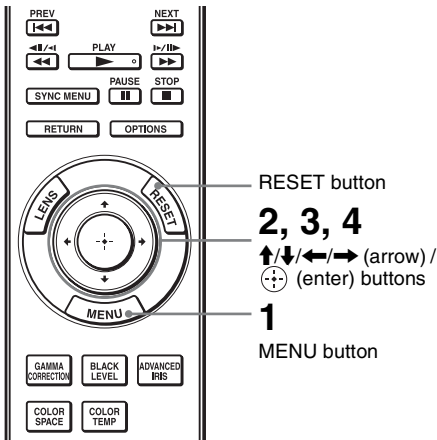

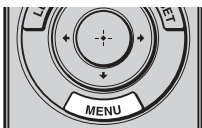

1 Press MENU.

The menu window appears.

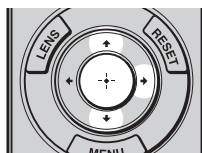
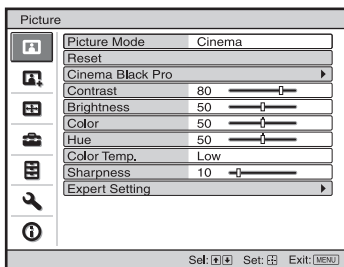

2 Press ↑/↓ to select a menu item, and press → or ↻.

The items that can be set or adjusted with the selected menu appear. The item presently selected is shown in white.

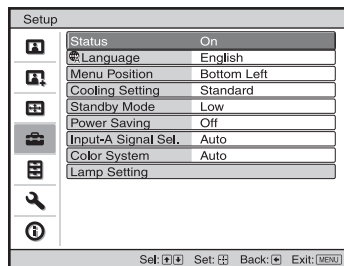

3 Press **↑/↓** to select an item you want to set or adjust and press **→** or **⊕**.

The setting items are displayed in a pop-up menu, in a setting menu, in an adjustment menu or in the next menu window.

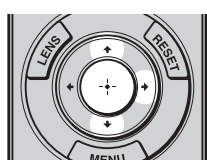

Pop-up menu

Setting items



Setting menu

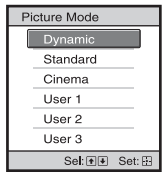

Adjustment menu

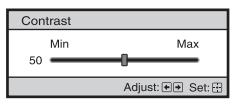

Next menu window

Setting items

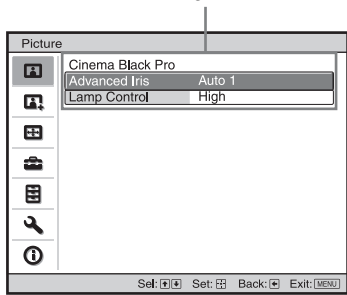

4 Make the setting or adjustment of an item.

When changing the adjustment level

To increase the value, press **↑/→**.

To decrease the value, press **↓/←**.

Press **⊕** to restore the original screen.

When changing the setting

Press **↑/↓** to change the setting.

Press **⊕** to restore the original screen.

You can restore the original menu screen using **←** depending on the selected item.

Items that cannot be adjusted

Adjustable items differ depending on the input signal. The items that cannot be adjusted or set do not appear in the menu.

( page 75)

To clear the menu

Press MENU.

To reset the picture that has been adjusted

Select “Reset” from Picture  menu.

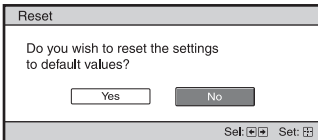

When the screen display appears, select “Yes” using **←** and press **⊕**.

All of the following settings are reset to its factory preset value.

The settings of “Cinema Black Pro”,

“Contrast”, “Brightness”, “Color”,

“Hue”, “Color Temp”, “Sharpness” and

“Expert Setting” on the Picture  menu

To reset the items that have been adjusted

Select an item in the Menu screen, and display the pop-up menu, the setting menu, and the adjustment menu.

Press the RESET on the remote control to reset only the selected settings to its factory preset value.

Note

RESET button on the remote control is available only when the adjustment menu or the setting menu is selected.

Picture Menu

The Picture menu is used for adjusting the picture.

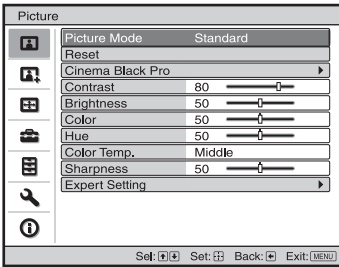

Note

These items may not be available, depending on the type of input signal. For details, see “Input Signals and Adjustable/Setting Items” (📖 page 75).

<p>Picture Mode</p>	<p>You can select the picture viewing mode that best suits the type of picture or the environment.</p> <p>Dynamic: Project bright images with sharp, vivid picture quality. Standard: Ideal for projecting TV programs, concerts, and other video images. Cinema: Picture quality suited for watching movies.</p> <p>User 1, User 2, User 3: You can adjust the quality of the picture to suit your taste and then store the settings. Once the settings are stored, you can view the picture with the adjusted picture quality by pressing the PICTURE MODE button on the remote control.</p> <p>To store the settings</p> <ol style="list-style-type: none"> 1 Select User 1, User 2, or User 3. 2 Adjust the items you want in the menus. <p>Tip</p> <p>You can also store the settings if the picture quality is adjusted in “Dynamic”, “Standard” or “Cinema”. To reset everything to the factory settings, select “Reset” from the menu. The factory default settings are as follows. User 1: Same as “Dynamic” setting. User 2: Same as “Standard” setting. User 3: Same as “Cinema” setting.</p>
<p>Reset</p>	<p>Resets all currently selected picture mode settings to their default values. (📖 page 42)</p>

Cinema Black Pro	<p>Advanced Iris Switches the iris function during projection. Auto 1: Automatically switches to an optimum iris according to a projected scene. The contrast of the scene is emphasized most. Auto 2: An optimum iris becomes smaller than when set to “Auto 1”. The contrast of the scene becomes reduced. Sensitivity: If “Auto 1” or “Auto 2” is selected, either “Recommend”, “Fast”, or “Slow” can be selected according to the desired response speed with Sensitivity Mode. Manual: Manually (fixed) adjusts the Iris.</p> <div data-bbox="555 357 777 448" style="text-align: center;"> <p>The image shows a graphical user interface for manual iris adjustment. It features a horizontal slider bar with 'Min' on the left and 'Max' on the right. A vertical marker is positioned at the 50% mark, with the number '50' displayed below it. Above the slider, the word 'Manual' is written. Below the slider, there are two buttons: 'Adjust' with a left and right arrow icon, and 'Set' with a square icon.</p> </div> <p>Off: Disables the iris (aperture) function.</p>
	<p>Lamp Control Switches the lamp wattage during projection. High: Increases the lamp brightness, and projects brighter images. Low: Decreases the lamp brightness, and enhances blacks by minimizing brightness.</p> <p>Tip When you switch from “Low” to “High”, the number of turns of the fan increases, and the fan noise becomes slightly louder. When you switch to “Low”, energy consumption is reduced, thereby increasing the lamp life.</p>
Contrast	<p>Adjusts the contrast. Higher values increase the sharpness in images, while lower values decrease the sharpness. You can make adjustments by pressing CONTRAST+/- on the remote control.</p>
Brightness	<p>Adjusts the brightness of the picture. The higher the setting, the brighter the picture. The lower the setting, the darker the picture. You can make adjustments by pressing BRIGHTNESS+/- on the remote control.</p>
Color	<p>Adjusts the color density. The higher the setting, the greater the intensity. The lower the setting, the lower the intensity.</p>
Hue	<p>Adjusts the color tone. The higher the setting, the more greenish the picture becomes. The lower the setting, the more reddish the picture becomes.</p>

Color Temp.	<p>Adjusts the color temperature. High: Equivalent to 11,000 K color temperature. Gives white colors a blue tint. Middle: Equivalent to 8,000 K color temperature. Gives a neutral tint between “High” and “Low”. Low: Equivalent to 6,500 K color temperature. Gives white colors a red tint. Custom 1, Custom 2, Custom 3, Custom 4: Enables you to adjust, set, and store your favorite color temperature. The factory default settings are as follows. Custom 1: Same as “High” color temperature setting. Custom 2: Same as “Middle” color temperature setting. Custom 3: Same as “Low” color temperature setting. Custom 4: Setting that prioritizes brightness.</p>
Sharpness	<p>Sharpens the outline of the picture, or reduces the noise. The higher the setting, the sharper the picture. The lower the setting, the softer the picture, thus reducing the noise. You can make adjustments by pressing SHARPNESS+/- on the remote control.</p>
Expert Setting	<p>NR (Noise Reduction) Reduces the roughness or noise of the picture. Usually, select “Off”. If the picture is rough or noisy, select a setting from among “Low”, “Middle” or “High” according to the input signal source.</p> <p>MPEG NR (MPEG Noise Reduction) Reduces block noise and mosquito noise, in particular in digital signals. Block NR: Reduces digital noise that appears in mosaic-like pattern. Mosquito NR: Reduces digital noise that appears near the outline of the picture.</p> <p>Film Mode According to the film source you have selected, make a setting for playback. Auto: Reproduces a 2-3 or 2-2 Pull-Down format video signal, such as film sources, in a smooth picture movement. When a video signal other than 2-3 or 2-2 Pull-Down format is input, the picture is played back in progressive format. Off: Plays back the picture in progressive format without detecting video signals automatically.</p> <p>Black Level Adj. (Adjust) Produces a bolder, dynamic picture with subdued blacks. Set according to the input signal source. High: Gives higher emphasis to the black color. Low: Gives lower emphasis to the black color. Off: Cancels this feature.</p>

<p>Expert Setting</p>	<p>Gamma Correction Adjusts the response characteristics of the tone of the picture. Select a favorite tone from 6 options. Gamma 1: Bright Produces a brighter picture overall. Gamma 2 ↑ Off ↓ Gamma 3: Dark Produces a darker picture overall. Gamma 4: Produces a picture with contrast emphasized slightly. This option is ideal for the Cinema picture mode. Gamma 5: Produces a picture with contrast emphasized more than with Gamma 4. This option is ideal for the Dynamic picture mode. Gamma 6: Brightens dark areas in the picture, and expands gradation expression.</p>
	<p>x.v.Color Set this item when playing back an x.v.Color video signal. Set this item to “On” when connecting the projector with equipment that supports x.v.Color and playing back an x.v.Color video signal. For details on x.v.Color, see “About the x.v.Color” (ⓘ page 59).</p>
	<p>Color Space You can convert the range of color reproduction. Normal: Color range conforming to sRGB standards. Wide: Reproduces more natural color tones in a wider range of color reproduction, compared to “Normal”.</p>

Advanced Picture Menu

The Advanced Picture is used for adjusting the picture more.



RCP (Real Color Processing)

You can adjust the color and hue of each selected portion of the picture independently.

User 1, User 2, User 3: You can adjust the picture using Real Color Processing and store the settings. Once the settings are stored, you can view the picture with the adjusted picture quality.

Off: Cancels this feature.

For details, see “Adjusting the Picture Using Real Color Processing”.

(🔍 page 37)

Screen Menu



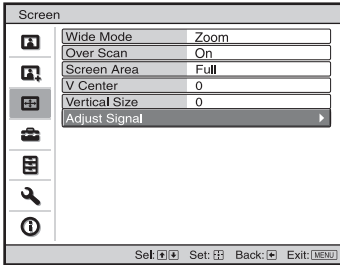

The Screen menu is used to adjust the input signal. You can adjust the size of the picture, and select wide screen mode, etc.



Note

These items may not be available, depending on the type of input signal. For details, see “Input Signals and Adjustable/Setting Items” (page 75).

<p>Wide Mode (Video signal)</p>	<p>You can set the aspect ratio of the picture to be displayed for the current input signal. (page 32) This item is enabled only when a video signal (preset memory numbers 1 to 14) is input.</p> <p>Wide Zoom: A 4:3 aspect ratio picture is enlarged naturally to fill the screen. The upper and lower portions of the screen are slightly cut off.</p> <p>Normal: A 4:3 aspect ratio picture is displayed in the center of the screen and enlarged to fill the screen vertically.</p> <p>Full: A picture squeezed to 4:3 aspect ratio is displayed in its original aspect ratio. When a 4:3 aspect ratio picture is displayed, the picture is enlarged horizontally to fill the 16:9 screen.</p> <p>Zoom: A 16:9 aspect ratio picture is enlarged vertically and horizontally in the same ratio to fill the screen. The upper and lower portions are cropped.</p> <p>You can switch settings by pressing WIDE MODE on the remote control.</p>
<p>Wide Mode (Computer signal)</p>	<p>You can set the aspect ratio of the picture to be displayed for the current input signal. (page 33) This item is enabled only when a computer signal is input.</p> <p>Full 1: Displays a picture on the whole of the screen without changing the aspect ratio of the original picture.</p> <p>Full 2: Displays a picture on the whole of the screen.</p> <p>Zoom: A picture is enlarged vertically and horizontally in the same ratio to fill the screen. The upper and lower portions are cropped.</p> <p>You can switch settings by pressing WIDE MODE on the remote control.</p> <p>Note</p> <p>When the aspect ratio of the input signal is 16:9 or wider, this setting is fixed at “Full 1”.</p>

Over Scan	<p>Hides the outline of the picture.</p> <p>On: Hides the outline of the input picture. Select this setting when noise appears along the edge of the picture.</p> <p>Off: Projects the whole of the input picture.</p> <p>Tip To display the displayable region within the four directions of the screen, refer to “Blanking” on the Installation  menu (Ⓞ page 54).</p>
Screen Area	<p>Selects the size of the picture when a Hi-Vision picture is overscanned.</p> <p>Full: Expands the picture on the whole of the screen.</p> <p>Through: Does not expand the picture on the whole of the screen.</p>
V Center	<p>Adjust the whole picture by moving up and down on the screen.</p> <p>As the selected number increases, the screen moves up, and as the selected number decreases, the screen moves down.</p>
Vertical Size	<p>Reduces or enlarges the picture vertically.</p> <p>The screen is enlarged as the setting increases and reduced as the setting decreases. If the subtitle of a movie, etc. cannot be seen, use this together with “V Center”.</p>
Adjust Signal	<p>You can adjust the input signal.</p> <p>APA: Adjusts “Phase”, “Pitch”, and “Shift” automatically to a position that suits the image signal for pictures from a computer.</p> <p>Phase: Adjusts the dot phase and the phase of computer signal of pictures from a computer. Adjusts the picture to the point where it looks clearest.</p> <p>Pitch: Adjusts the horizontal size of the picture from a computer. As the number increases, the picture becomes wider, and as the number decreases, the picture becomes narrower. Adjust the setting to match the number of dots of the input signal.</p> <p>Shift: Adjusts the position of the picture.</p> <p>H: As the setting for H (horizontal) increases, the picture moves to the right, and as the setting decreases, the picture moves to the left. Use  /  to adjust the horizontal position.</p> <p>V: As the setting for V (vertical) increases, the picture moves up, and as the setting decreases, the picture moves down. Use  /  to adjust the vertical position.</p>

Setup Menu

The Setup menu is used to change the factory preset settings, etc.

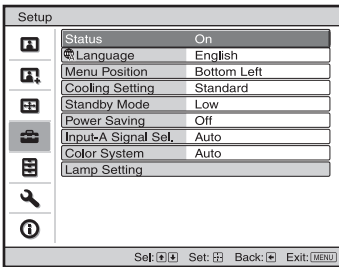

Status	<p>Sets whether or not the on-screen display is displayed. Set to “Off” to turn off the on-screen displays except for certain menus, message when turning off the power, and warning messages.</p>
Language	<p>Selects the language used in the menu and on-screen displays. Available languages are: English, Dutch, French, Italian, German, Spanish, Portuguese, Russian, Swedish, Norwegian, Japanese, Chinese (Simplified Chinese), Chinese (Traditional Chinese), Korean, Thai and Arabic.</p>
Menu Position	<p>You can change the position to display the menu on the upper screen. Bottom Left: Displays the menu on the bottom left area of the screen. Center: Displays the menu on the center of the screen.</p>
Cooling Setting	<p>Use this item when using the projector at high altitudes. High: Use this setting when using the projector at an altitude of 1,500 m or higher. Standard: Use this setting when using the projector at normal altitudes.</p> <p>Notes</p> <ul style="list-style-type: none"> • When this item is set to “High”, the fan noise becomes slightly louder since the number of fan rotations increase. • Do not use the projector at an altitude of 2,700 m or higher.
Standby Mode	<p>Lowers the power consumption in standby. When set to “Standard”, the power consumption in standby becomes normal. When set to “Low”, the power consumption in standby is lowered.</p> <p>Notes</p> <ul style="list-style-type: none"> • The factory default setting is “Low”. • When this item is set to “Low”, the “PJ Auto Power On” function is disabled (The function is set to “Off” and does not appear in the menu.). (page 52)

Power Saving	<p>Sets the power saving mode. When set to “On”, the projector goes into power saving mode if no signal is input for 10 minutes. At that time, the ON/STANDBY indicator lights in orange, then the screen becomes dark. In power saving mode, the power saving mode is cancelled if a signal is input or any button on the projector or the remote control is pressed. If you do not want to set the projector to power saving mode, select “Off”.</p>
Input-A Signal Sel.	<p>Selects the type of signal input from the equipment connected to the INPUT A connector. Selects the type of signal input from the equipment by selecting “Input-A” with the INPUT button. Auto: Selects the input signal type automatically. Computer: Inputs the signal from a computer. Video GBR: Inputs the signal from a TV game or HDTV broadcast. Component: Inputs the component signal from a DVD player/recorder, Blu-ray Disc player/recorder, digital tuner, etc.</p> <p>Note When the input signal is not displayed correctly with this item set to “Auto,” select the item according to the input signal.</p>
Color System	<p>Selects the color system of the input signal. Auto: Selects the color system of the input signal automatically from among NTSC3.58, PAL, SECAM, NTSC4.43, PAL-M, PAL-N, or PAL60. “NTSC3.58”–“PAL-N”: Allows you to set the color system to the selected system manually.</p> <p>Note Normally, set this to “Auto.” If the picture is distorted or colorless, select the color system appropriate for the input signal.</p>
Lamp Setting	<p>When replacing the lamps, set the desired lamp setting. (☞ page 67)</p>

Function Menu

The Function menu is used for changing the settings of the various functions of the projector.

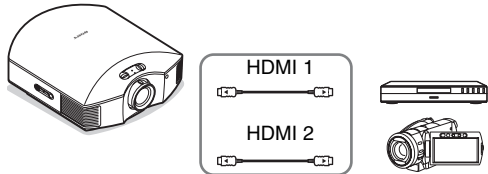
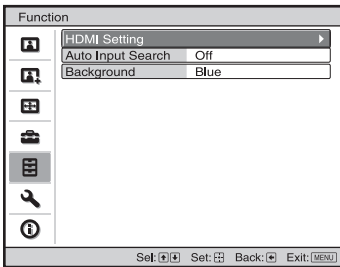

HDMI Setting

You can change the settings of the Control for HDMI function.

Control for HDMI: Selects the function whether to turn the Control for HDMI function effective when the HDMI 1 and HDMI 2 connectors are connected to a Control for HDMI compatible equipment.

When set to “On”, the following are available.

- The operation of the projector and the connected Control for HDMI compatible equipment will synchronize with each other.
- The Control for HDMI setting of Sony equipment (AV amplifier, video, etc.), which is compatible with “Control for HDMI - Easy Setting”*, will also be effective.

The factory default setting is “On”.

Device Auto Power Off: Sets whether to also turn the power of the connected Control for HDMI compatible equipment off when you turn the power of the projector off.

When set to “On”, the equipment will synchronize and turn off when the power of the projector turns off.

The factory default setting is “On”.

PJ Auto Power On: Select whether to link the power of the projector to the Control for HDMI compatible equipment.

When set to “On”, the power of the projector will automatically turn on when the power of the connected equipment is turned on or when making operations such as playback.

Note

To enable this function, set “Standby Mode” (Ⓞ page 50) in the Setup  menu to “Standard”, and then set “PJ Auto Power On” to “On”. For details, see “About the Control for HDMI” (Ⓞ page 58).

Device List: Lists all the Control for HDMI compatible equipment connected to the projector.

All equipment listed (except AV amplifier) can be selected with SYNC MENU of the remote control of the projector. When “Enable” is selected, the Control for HDMI setting of Sony equipment (AV amplifier, video, etc.), which is compatible with “Control for HDMI - Easy Setting”, will also be effective.

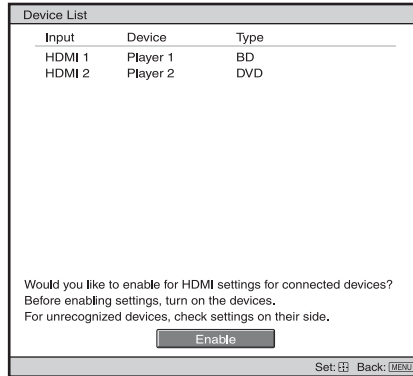

* “Control for HDMI - Easy Setting” is a function that makes the Control for HDMI setting of equipment connected to HDMI input of the projector effective as well when the Control for HDMI setting of the projector is effective. This function is only available between compatible Sony equipment, and some equipment may not be compatible.

Although some non-Sony equipment may be compatible, operation is not guaranteed for such equipment.

Auto Input Search

Hides input terminals that do not have signal input.

When set to “On”, terminals without input signals do not appear on the input palette that appears when you press INPUT. To display all input terminals, set this to “Off”. (Ⓢ page 28)

Background





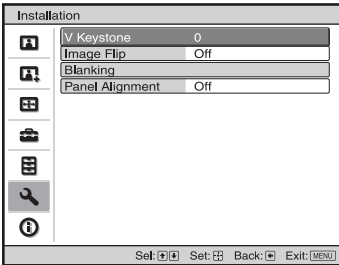

Selects the background color of the screen when no signal is input.

You can select “Black” or “Blue”.

Installation Menu

The Installation menu is used for changing the installation settings.



<p>V Keystone</p>	<p>Corrects the vertical trapezoidal distortion of the picture. When the bottom of the trapezoid is longer than the top (): Sets a lower value (– direction) When the top of the trapezoid is longer than the bottom (): Sets a higher value (+ direction).</p> <p>Note</p> <p>Depending on the picture position adjusted with the lens shift feature, the aspect ratio of the picture may change from the original or picture distortion may occur with V Keystone adjustment.</p>
<p>Image Flip</p>	<p>Flips the picture on the screen horizontally and/or vertically. Off: The picture does not flip. HV: Flips the picture horizontally and vertically. H: Flips the picture horizontally. V: Flips the picture vertically. Use this item for installation for the backside projection or ceiling installation.</p>
<p>Blanking</p>	<p>This feature allows you to adjust the displayable region within the four directions of the screen. Select the edge to adjust by highlighting Left, Right, Top, or Bottom using the  /  buttons. Adjust the amount of blanking using the  /  buttons.</p> <div data-bbox="557 1193 829 1353" data-label="Image"> <p>The screenshot shows a menu titled "Blanking" with four input fields:</p> <ul style="list-style-type: none"> Left: 2 Right: 3 Top: 2 Bottom: 3 <p>At the bottom, there are navigation buttons: Set (F4), Adjust (F5), and Set (F6).</p> </div> <p>Note</p> <p>When both the “Blanking” and the “V Keystone” are adjusted at the same time, the “Blanking” cannot be adjusted correctly. When using the “Blanking”, make sure that you set the “V Keystone” to “0”.</p>

Panel Alignment

This feature allows you to adjust the gaps in the color of characters or the picture.

When set to “On”, the “Adjust Color” and the “Pattern Color” can be assigned and adjusted.

Adjust Color: Assigns the desired color to adjust the gaps in color. Select “R” (Red) or “B” (Blue) to make adjustments based on “G” (Green).

Pattern Color: Select “R/G” (Red and Green) or “R/G/B” (White, all colors) when the “Adjust Color” is “R” (Red). Select “B/G” (Blue and Green) or “R/G/B” (White, all colors) only when the “Adjust Color” is “B” (Blue).

Adjust: Assign the settings of the horizontal direction (H) with ← / → buttons and the vertical direction (V) with ↑ / ↓ buttons on the Shift Adjust screen. The colors selected in the “Adjust Color” can be adjusted with the ← / →, ↑ / ↓ buttons in each direction.

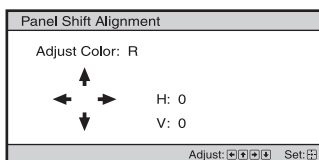

Reset: Returns to the factory settings.

Note

Depending on the adjustments made above, the number of display pixel may decrease. Also, colors may become uneven or the resolution may change.

Tip

If colors appear on the edge of the screen after making the adjustments above, adjust the region of the picture to display with “Blanking” in the Installation  menu. (🔧 page 54)

Information Menu

The Information menu displays the model name, serial number, the horizontal and vertical frequencies of the input signal and the cumulated hours of usage of the lamp.

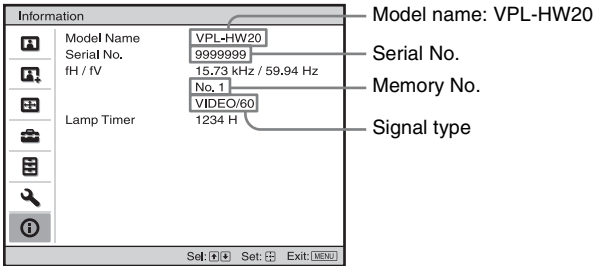



Model name	Displays the model name (VPL-HW20).
Serial No.	Displays the serial number.
fH (horizontal frequency)	Displays the horizontal frequency of the input signal.
fV (vertical frequency)	Displays the vertical frequency of the input signal.
Memory No.	Displays the preset memory number of the input signal.
Signal type	Displays the type of the input signal.
Lamp Timer	Indicates how long the lamp has been turned on (total usage).

Notes

- fH (horizontal frequency) and fV (vertical frequency) may not be displayed depending on the input signal used on the projector.
- You cannot change the displays listed above.

About the Preset Memory No.

This projector has 38 types of preset data for input signals (the preset memory). When the preset signal is input, the projector automatically detects the signal type and recalls the data for the signal from the preset memory to adjust it to an optimum picture. The memory number and signal type of that signal are displayed in the Information  menu.

You can also adjust the preset data through the Screen  menu.

This projector also contains 20 different user memories beside the preset memories used for inputting analog computer signals. You can save input signals that have not been preset on these user memories.

When an unpreset signal is input for the first time, a memory number is displayed as 0.

When you adjust the data of the signal in the Screen  menu, it will be registered to the projector. If more than 20 user memories are registered, the newest memory always overwrites the oldest one.

See the chart on page 72 to find if the signal is registered to the preset memory.

Note

When the aspect ratio of input signal does not match the screen size, a part of the screen is displayed in black.

Others

This section describes about the other functions, how to solve the problems, how to replace the lamp and air filter, etc.

About the Control for HDMI

What is the Control for HDMI?

Control for HDMI is an HDMI standard mutual control function which uses the HDMI CEC (Consumer Electronics Control) specification. By connecting a variety of Control for HDMI compatible equipment such as a hard disk Blu-ray Disc player, a DVD player/recorder, an AV amplifier, etc. to a Control for HDMI compatible TV or a projector with an HDMI cable, the equipment connected will synchronize with the TV or the projector when either is operated.

Using the Control for HDMI function

- Connect and assign the settings of each equipment appropriately.
- Do not turn off the main power of the equipment.
- Set the input setting of the projector to the HDMI input which the equipment is connected.
- Check if the picture from the equipment appears appropriately on the projector.

Connecting a Control for HDMI compatible equipment

Use an HDMI cable to connect the projector and the Control for HDMI compatible equipment. Use a cable that has acquired the HDMI logo.

Setting the Control for HDMI

Be sure to assign the appropriate connections for both the projector and the Control for HDMI compatible equipment

connected to the projector. For settings of the projector, see page 52. For settings of the Control for HDMI compatible equipment connected to the projector, refer to its operational instructions. When a equipment that is compatible with the “Control for HDMI - Easy Setting” is connected to the HDMI input of the projector, if you turn the Control for HDMI function setting of the projector on, the Control for HDMI function setting of the connected equipment will also turn on.

What you can do with the Control for HDMI

- Basic operations (playback, stop, menu operations, etc.) of the connected equipment is available by using the remote control of the projector.
- By turning on or playing back the connected equipment, the projector will turn on and the input setting will switch to the terminal of the connected equipment automatically.
- By turning the power of the projector off, the power of the connected equipment will also turn off automatically.
- By selecting equipment connected to the projector desired to operate with SYNC MENU button on the remote control of the projector, the power of the selected equipment will turn on and the input will switch to the terminal of the connected equipment automatically.
- By changing the language setting of the projector, the language setting of the connected equipment will also change to the same language automatically.

Notes

- The available functions of the Control for HDMI differ depending on each equipment. Refer to the operating instruction of each equipment.

- Some synchronization may be available with equipment of other brands with similar functions, but it is not guaranteed.

About the x.v.Color

- “x.v.Color” is a promotion name given to the products that have the capability to realize a wide color space based on the xvYCC specifications and is a trademark of Sony Corporation.
- xvYCC is an international standard of the technical specifications of the extended-gamut color space for video signals. The color gamut of xvYCC is wider than the one of sRGB that is used with the current television system.







Troubleshooting



If the projector appears to be operating erratically, try to diagnose and correct the problem using the following instructions. If the problem persists, consult with qualified Sony personnel.

Power



Symptom	Cause and Remedy
The power is not turned on.	<ul style="list-style-type: none"> → The power may not turn on if you turn the power off with I/O (ON/STANDBY) switch and turn it on again in a short time. After about 1 minute, turn the power on. → Close the lamp cover securely, then tighten the screws securely. (☞ page 66) → Close the filter holder securely. (☞ page 67) → Check warning indicators. (☞ page 63)

Picture

Symptom	Cause and Remedy
No picture.	<ul style="list-style-type: none"> → Check that the proper connections have been made. (☞ page 22) → Select the input source correctly using the INPUT button. (☞ page 28) → Set the computer signal to output from an external monitor. → Set the computer signal to output only to an external monitor. → Select “Computer,” “Component” or “Video GBR” for “Input-A Signal Sel.” on the Setup  menu according to the input signal. (☞ page 51)
The picture from the INPUT A connector is colored strange.	<ul style="list-style-type: none"> → Select “Computer,” “Component” or “Video GBR” for “Input-A Signal Sel.” on the Setup  menu according to the input signal. (☞ page 51)
The picture from the VIDEO INPUT or S VIDEO INPUT connector is colored strange.	<ul style="list-style-type: none"> → Adjust the picture of the Picture  menu. (☞ page 43) → Set “Color System” in the Setup  menu to match the color system being input. (☞ page 51)
The bright area of the picture may become unclear or texts may become faded. (When HDMI video signal is input)	<ul style="list-style-type: none"> → This symptom may occur when a signal other than those of HDMI standard is input. (☞ page 29) Switch the RGB dynamic range of the connected equipment to Limited (16-235). If this adjustment is unavailable, adjust “Brightness”, “Contrast”, or “Sharpness” in the Picture  menu of the projector. (☞ page 44)
The texts may become faded when connected with a computer. (When computer signal is input)	<ul style="list-style-type: none"> → This symptom may occur when a signal other than those of HDMI standard is input. (☞ page 29) Adjust “Sharpness” in the Picture  menu. (☞ page 44)

Symptom	Cause and Remedy
The picture is too dark.	→ Adjust the “Contrast” or “Brightness” of the Picture  menu properly. (☞ page 44)
The picture is not clear.	→ Adjust the focus. (☞ page 20) → Condensation has accumulated on the lens. Leave the projector for about 2 hours with the power on.
The picture flickers.	→ For pictures from a computer, activate “APA” and adjust the current input signal. → Adjust “Phase” for “Adjust Signal” in the Screen  menu properly. (☞ page 49)
The color of characters or the picture is not appropriate.	→ Select the desired color registration in “Panel Alignment” of Installation  menu (☞ page 55).

On-screen display

Symptom	Cause and Remedy
On-screen display does not appear.	→ Set “Status” in the Setup  menu to “On.” (☞ page 50) → Check if the ON/STANDBY indicator should light in green.
The model name does not disappear from the screen.	→ The display mode of the projector may be set at the time of purchase. Consult with your local dealer or qualified Sony personnel.
Input terminals do not appear.	→ Set “Auto Input Search” in the Function  menu to “Off”. (☞ page 53)

Remote control

Symptom	Cause and Remedy
The remote control does not work.	→ Batteries could be weak. Replace them with new batteries. (☞ page 10) → Insert the batteries with the correct polarities. (☞ page 10) → If there is a fluorescent lamp near the remote control detector, the projector may work improperly or inadvertently. → Confirm the position of the remote control detector on the projector. (☞ page 7)

Others

Symptom	Cause and Remedy
The fan is noisy.	<ul style="list-style-type: none"> → Check the setting of “Cooling Setting” in the Setup  menu. (☞ page 50) → Make sure that the room temperature is not too high. → Check the installation conditions. (☞ page 11) The number of fan rotation increases to maintain the product reliability of the projector’s components in a room, where the temperature is higher than normal. The fan noise becomes slightly louder. The approximate normal temperature is 25°C.
Image is left on the screen. (image retention)	<ul style="list-style-type: none"> → When High contrast non-moving images are displayed for a long period of time, there may be some image retention on the screen. This is only a temporary condition. Turning off the power for a while will eliminate the retained image.
The projector and connected equipment turn On/Off, play back, and operate at the same time.	<ul style="list-style-type: none"> → “Control for HDMI”, “Device Auto Power Off”, and “PJ Auto Power ON” are set to “On”. Set them to “Off”. For details, see “HDMI Setting” (☞ page 52).

Warning Indicators

The ON/STANDBY or LAMP/COVER indicator lights up or flashes if there is any trouble with your projector.

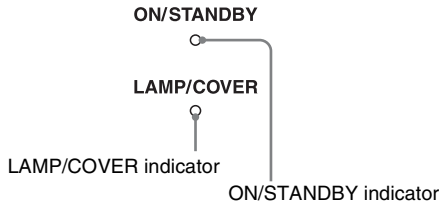

Symptom	Cause and Remedy
LAMP/COVER flashes in red. (A repetition rate of 2 flashes)	<ul style="list-style-type: none"> → Close the lamp cover securely, then tighten the screws securely. (☞ page 66) → Close the filter holder securely. (☞ page 67)
LAMP/COVER flashes in red. (A repetition rate of 3 flashes)	<ul style="list-style-type: none"> → The lamp has reached the end of its useful lifespan. Replace the lamp. (☞ page 65) → The lamp has reached a high temperature. Wait until the lamp cools, and then turn on the power again.
ON/STANDBY flashes in red. (A repetition rate of 4 flashes)	<ul style="list-style-type: none"> → The fan is broken. Consult with qualified Sony personnel.
ON/STANDBY flashes in red. (A repetition rate of 2 flashes)	<ul style="list-style-type: none"> → The internal temperature is unusually high. Check to ensure that if nothing is blocking the ventilation holes or whether or not the projector is being used at high altitudes.
ON/STANDBY flashes in red. (A repetition rate of 6 flashes)	<ul style="list-style-type: none"> → Press the I/⏻ (ON/STANDBY) switch to turn on the projector. If the power is not turned on, disconnect the AC power cord, then confirm the ON/STANDBY lamp is turned off. After about 10 seconds, reconnect the AC power cord and turn on the power again. If the indicators still light up, the electrical system has a problem. Consult with qualified Sony personnel.

Note

When a warning indicator other than the above starts flashing, and the symptom persists even after carrying out the above methods, consult with qualified Sony personnel.

Message Lists

Warning messages

Message	Cause and Remedy
High temp.! Lamp off in 1 min.	<ul style="list-style-type: none"> → Turn off the power. → Check to ensure that nothing is blocking the ventilation holes. (☞ page 12)
Frequency is out of range!	<ul style="list-style-type: none"> → Frequency is out of range. Input a signal that is within the acceptable frequency range of the projector. (☞ page 72)
Please check Input-A Signal Sel.	<ul style="list-style-type: none"> → Set “Input-A Signal Sel.” in the Setup  menu to “Computer” when an RGB signal is input from a computer. (☞ page 51)
Please replace the Lamp/Filter.	<ul style="list-style-type: none"> → It is time to replace the lamp. Replace the lamp. (☞ page 65) → Also, replace the air filter too. Restart cleaning the ventilation holes (intake). (☞ page 65) <p>If this message appears again after you replace the lamp and filter, the lamp replacement process is not complete. Check the lamp replacement process. (☞ page 65)</p> <p>Note</p> <p>To clear this message, press any button either on the remote control or the control panel of the projector once.</p>
Please clean the filter.	<ul style="list-style-type: none"> → It is time to clean the air filter. Clean the air filter. (☞ page 68) <p>Note</p> <p>To clear this message, press any button either on the remote control or the control panel of the projector once.</p>
Please clean the filter. Have you finished? Yes No	<ul style="list-style-type: none"> → It is time to clean the air filter. Clean the air filter. (☞ page 68) → If you cleaned the air filter, select “Yes.” If you did not clean the air filter, select “No.”
Projector temperature is high. Cooling Setting should be “High” if projector is being used at high altitude.	<ul style="list-style-type: none"> → Check to ensure that the ventilation holes on the unit are not covered. (☞ page 12) → When using the projector at high altitude, set the Cooling Setting to “High”. (☞ page 50) <p>Note</p> <p>When temperature inside the projector remains high, the Cooling Setting is switched to “High” in 1 minute, then the fan speed increases.</p>

Caution messages

Message	Cause and Remedy
x→	<ul style="list-style-type: none"> → No signal is input in the selected input. Check connections. (☞ page 22)
Not applicable!	<ul style="list-style-type: none"> → Press the appropriate button. → The operation to be activated by the button is currently prohibited.

Replacing the Lamp and the Air Filter and Cleaning the Ventilation Holes (intake)

Tools you need to get started:

- Projector Lamp LMP-H201 (optional)
- Standard Phillips screwdriver
- Cloth (for scratch protection)

The lamp used for the light source has a certain lifespan. When the lamp dims, the color balance of the picture becomes strange, or “Please replace the Lamp/Filter.” appears on the screen, the lamp may be exhausted. Replace the lamp with a new one (not supplied) without delay.

Use an LMP-H201 Projector Lamp as the replacement lamp.

The air filter is supplied with the LMP-H201 Projector Lamp. When you replace the lamp, it is also time to replace the air filter.

Whenever you replace the lamp, be sure to replace the air filter with a new one. Also clean the ventilation holes (intake).

Caution

- The lamp remains hot after the projector is turned off with the I/⏻ (ON/STANDBY) switch. If you touch the lamp, you may burn your fingers. When you replace the lamp, wait for at least 1 hour for the lamp to cool.
- Do not touch the surface of the lens. If you touch it, wipe off the fingerprints with a soft cloth.
- Pay special attention to replacing the lamp when the projector is installed on the ceiling.
- When removing the lamp unit, make sure it remains horizontal, then pull straight up. Do not tilt the lamp unit. If you pull out the lamp unit while tilted and if the lamp breaks, the pieces may scatter, causing injury.
- When you remove the air filter, be careful not to let any dust fall into the projector.
- Replacing the air filter is crucial to maintain the good performance of the projector or to prevent malfunction to it. When a warning

message for replacing the air filter appears, replace the air filter immediately.

- 1 Turn off the projector and unplug the AC power cord.
- 2 When setting the projector on a flat surface such as a desk etc., put a cloth to prevent the surface from being scratched. Reverse the projector as illustrated, then place it on the cloth.

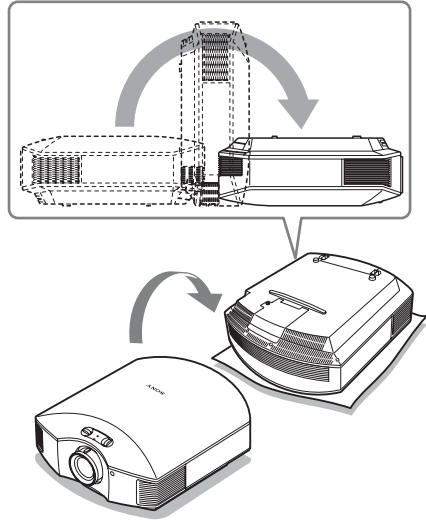

Notes

- When the lamp is damaged the broken pieces of the lamp may become scattered, if you do not reverse the projector. This may cause injury.
- Be sure that the projector is placed on a stable surface.

- 3** Loosen the screw on the lamp cover with a Phillips screwdriver, and then open the lamp cover.

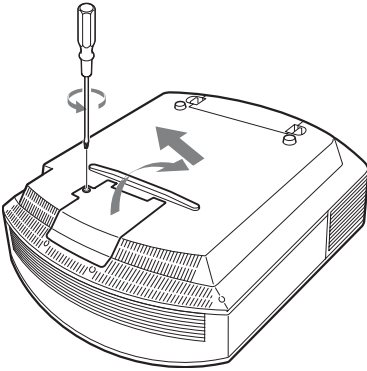

- 5** Hold the handle of the new lamp and push it in securely until it reaches the end, and then tighten the 3 screws.

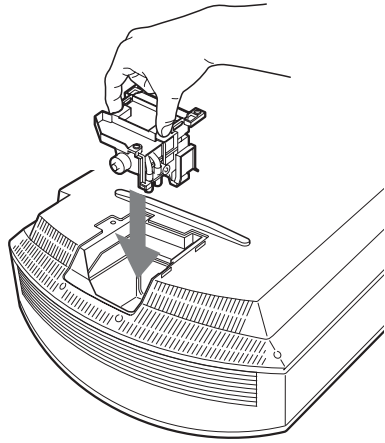

- 4** Loosen the 3 screws on the lamp with the Phillips screwdriver. Hold up the handle, then pull the lamp straight out.

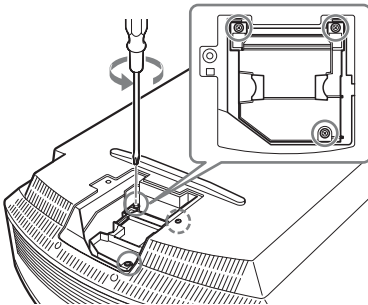

Note

Be careful not to touch the optical block inside the unit.

- 6** Close the lamp cover, then tighten the screws.

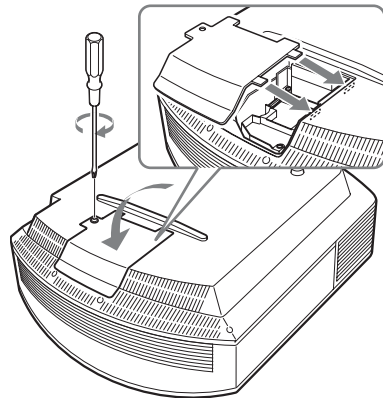

7 Remove the filter holder.

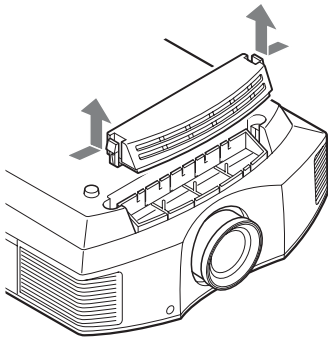

8 Remove the air filter.

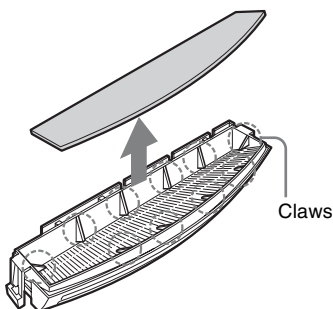

9 Attach the new air filter so that it fits into the each claws (10 positions) on the filter holder.

Note

Attach the air filter aligning it with the shape of the filter holder.
Also, do not touch the fan after removing the air filter that is set deep inside the projector.

10 Attach the filter holder.

Note

The projector will not turn on unless the filter holder is securely closed.

11 Wipe dust off the ventilation holes (intake) with a soft cloth.

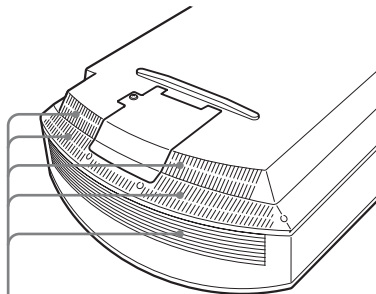

Ventilation holes (intake)

12 Place the project back on its original position.

13 Turn on the projector, then select the desired setting item on the Setup menu. The menu screen below will be appeared.

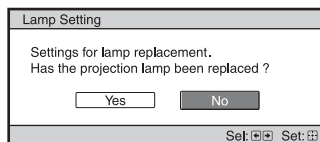

14 Select "Yes".

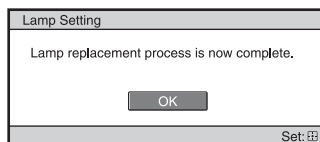

Caution

Do not put your hands into the lamp replacement slot, and do not allow any liquid or other objects into the slot to avoid electrical shock or fire.

Notes

- Be sure to use an LMP-H201 Projector Lamp for replacement. If you use lamps other than the LMP-H201, the projector may malfunction.
- Be sure to turn off the projector and unplug the power cord before replacing the lamp, then check the ON/STANDBY lamp has already been turned off.
- The projector will not turn on unless the lamp is securely installed in place.
- The projector will not turn on unless the lamp cover are securely closed.
- To cancel a message displayed on the screen, press either the button on the remote control or the one on the control panel on the projector.

Note

The lamp contains mercury. The disposal rules for used fluorescent tubes depend on where you live. Follow the waste disposal policy in your area.

Disposal of the used lamp

For the customers in the USA

Lamp in this product contains mercury. Disposal of these materials may be regulated due to environmental considerations. For disposal or recycling information, please contact your local authorities or the Telecommunications Industry Association (www.eiae.org).

Cleaning the Air Filter

When “Please clean the filter.” appears on the screen, you should clean the air filter. The air filter should be cleaned every 1,500 hours. This value varies depending on the environment or how the projector is used. 1,500 hours are approximate. After washing the air filter with a mild detergent solution, dry it in a shaded place.

Notes

- When you clean the air filter, make sure you do not damage it. For details on how to attach and remove the air filter, see “Replacing the Lamp and the Air Filter and Cleaning the Ventilation Holes (intake)” Steps 7 to 10. (☞ page 67)
- When you remove the air filter, be careful not to let any dust fall into the projector.
- Cleaning the air filter is crucial to maintain the good performance of the projector or to prevent malfunction to it. When a warning message for cleaning the air filter appears, clean the air filter immediately.

Fitting the Lens Cap

When fitting the lens cap onto the lens, position the lens cap so that the concave on the side of the lens cap will fit the zoom lever, as shown in the illustration.

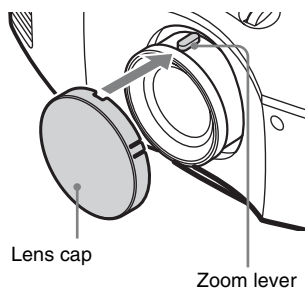

Cleaning and the Screen of the Projector

Cleaning the lens

The lens surface is especially treated to reduce reflection of light.

As incorrect maintenance may impair the performance of the projector, take care with respect to the following:

- Wipe the lens gently with a soft cloth such as a cleaning cloth or glass cleaning cloth.
- Stubborn stains may be removed with a soft cloth such as a cleaning cloth or glass cleaning cloth lightly dampened with water.
- Never use solvent such as alcohol, benzene or thinner, or acid, alkaline or abrasive detergent, or chemical cleaning cloth, as they will damage the lens surface.

Cleaning the cabinet

- To remove dust from the cabinet, wipe gently with a soft cloth. If dust is persistent, wipe with a soft cloth slightly moistened with a diluted mild detergent solution.
- Never use any type of abrasive pad, alkaline/acid cleaner, scouring powder, or volatile solvent, such as alcohol, benzene, thinner or insecticide.
- Using such materials or maintaining prolonged contact with rubber or vinyl materials may result in damage to the screen surface and cabinet material.

Black points and bright points (red, blue, or green) on the screen

The projector is manufactured using high-precision technology.

You may, however, see tiny black points and/or bright points (red, blue, or green) that continuously appear on the projector.

This is a normal result of the manufacturing process and does not indicate a malfunction.

Specifications

System

Projection system
SXRD panel, 1 lens, projection system

LCD panel
0.61-inch (15.4 mm)
SXRD panel 6,220,800 pixels
(2,073,600 pixels × 3)

Lens
1.6 times zoom lens (manual)
f=18.5 mm to 29.6 mm
F2.50 to F3.40

Lamp
200 W Ultra High Pressure Lamp

Projection picture size
40 inches to 300 inches (1,016 mm to
7,620 mm) (measured diagonally)

Color system
NTSC_{3.58}/PAL/SECAM/
NTSC_{4.43}/PAL-M/PAL-N/PAL60
system, switched automatically/
manually (PAL60 system not
switched manually)

Acceptable video signals
15 kHz RGB/component 50/60 Hz,
Progressive component 50/60 Hz,
480/60i, 576/50i, 480/60p, 576/50p,
720/60p, 720/50p, 1080/60i, 1080/50i,
1080/24PsF (48i), 1080/60p (HDMI
input only), 1080/50p (HDMI input
only), 1080/24p (HDMI input only),
Composite video, Y/C video

Acceptable computer signals
fH: 19 kHz to 72 kHz
fV: 48 Hz to 92 Hz
Maximum resolution 1,920 × 1,080
(HDMI input only)
For details, see "Preset Signals". (Ⓒ
page 72)

Input

Video input

VIDEO: phono type
Composite video: 1 V_p-p±2 dB
sync negative (75 ohms
terminated)
S VIDEO: Y/C mini DIN 4-pin type
Y (luminance): 1 V_p-p±2 dB sync
negative (75 ohms terminated)
C (chrominance): burst 0.286 V_p-p ±2
dB (NTSC)
(75 ohms terminated), or
burst 0.3 V_p-p±2 dB (PAL)
(75 ohms terminated)

Y PB/CB PR/CR

Component: phono type
Y with Sync: 1 V_p-p±2dB sync
negative (75 ohms terminated)
PB/CB: 0.7 V_p-p±2dB (75 ohms
terminated)
PR/CR: 0.7 V_p-p±2 dB (75 ohms
terminated)

HDMI

Digital RGB/Y C_B (P_B) C_R (P_R)

INPUT A

HD D-sub 15-pins
Analog RGB/component:
R/CR (P_R): 0.7 V_p-p±2 dB
(75 ohms terminated)
G: 0.7 V_p-p±2 dB
(75 ohms terminated)
G with sync/Y: 1 V_p-p±2 dB sync
negative (75 ohms terminated)
B/C_B (P_B): 0.7 V_p-p±2 dB
(75 ohms terminated)
SYNC/HD: Composite sync input:
TTL level, positive/ negative
Horizontal sync input: TTL level,
positive/negative
VD: Vertical sync input: TTL
level, positive/negative

REMOTE

RS-232C: D-sub 9-pins (female)

General

Dimensions

407.4 mm × 179.2 mm ×
463.9 mm (16 ¹/₈ × 7 ¹/₈ × 18 ³/₈
inches) (w/h/d)

Mass Approx. 10 kg (22 lb 1 oz)

Power requirements

AC 100 V to 240 V, 3.0 A to 1.3 A,
50/60 Hz

Power consumption

Max. 300 W
Standby mode: 8 W
Standby mode (low): 0.5 W

Operating temperature

5 °C to 35 °C (41 °F to 95 °F)

Operating humidity

35% to 85% (no condensation)

Storage temperature

-20 °C to +60 °C (-4 °F to +140 °F)

Storage humidity

10% to 90%

Supplied accessories

- Remote control RM-PJVW70 (1)
- Size AA (R6) manganese batteries (2)
- AC power cord (1)
- Lens cap (1)
- Operating Instructions (1)

Design and specifications are subject to change without notice.

Optional accessories

- Projector Lamp LMP-H201 (for replacement)
- Projector Suspension Support PSS-H10

Warning on power connection

Use a proper power cord for your local power supply.

	The United States, Canada	Continental Europe	UK, Ireland, Australia, New Zealand	Japan	China
Plug type	YP-3	YP-12A	*	YP-359	VM0722
Female end	YC-13	YC-13D	VM0303B	YC-13	VM0724
Cord type	SVT	H05VV-F	CEE (13) 53 rd (OC)	VCTF	227 IEC 53(RVV)
Rated Voltage & Current	10A/125V	10A/250V	10A/250V	12A/125V	10A/250V
Safety approval	UL/CSA	VDE	VDE	DENANHO	CCC

* Use a rated plug that complies with the regulation of each country/region and the specifications.

Preset Signals

The following table shows the signals and video formats which you can project using this unit.

When a signal other than the preset signal shown below is input, the picture may not be displayed properly.

Memory No.	Preset signal (resolution)		fH (kHz)	fV (Hz)	Sync	H Size
1	VIDEO/60	60 Hz	15.734	59.940	–	–
2	VIDEO/50	50 Hz	15.625	50.000	–	–
3	480/60i	480/60i (720 × 480i)	15.734	59.940	SonG/Y or composite sync	–
4	576/50i	576/50i (720 × 576i)	15.625	50.000	SonG/Y or composite sync /composite video	–
5	480/60p	480/60p (Progressive NTSC) (720 × 480p)	31.470	60.000	SonG/Y	–
6	576/50p	576/50p (Progressive PAL) (720 × 576p)	31.250	50.000	SonG/Y	–
7	1080/60i	1035/60i (1920 × 1035i) 1080/60i (1920 × 1080i)	33.750	60.000	SonG/Y	–
8	1080/50i	1080/50i (1920 × 1080i)	28.130	50.000	SonG/Y	–
9	1080/24PsF (48i)	1080/24PsF (48i) (1920 × 1080i)	27.000	48.000	SonG/Y	–
10	720/60p	720/60p (1280 × 720p)	45.000	60.000	SonG/Y	–
11	720/50p	720/50p (1280 × 720p)	37.500	50.000	SonG/Y	–
12	1080/60p	1080/60p (1920 × 1080p)	67.500	60.000	–	–
13	1080/50p	1080/50p (1920 × 1080p)	56.260	50.000	–	–
14	1080/24p	1080/24p (1920 × 1080p)	26.973	23.976	–	–
21	640 × 350	VGA-1 (VGA350)	31.469	70.086	H-pos, V-neg	800
22		VESA 85 (VGA350)	37.861	85.080	H-pos, V-neg	832

Memory No.	Preset signal (resolution)		fH (kHz)	fV (Hz)	Sync	H Size
23	640 × 400	NEC PC98	24.823	56.416	H-neg V-neg	848
24		VGA-2 (TEXT) /VESA70	31.469	70.086	H-neg V-pos	800
25		VESA 85 (VGA400)	37.861	85.080	H-neg, V-pos	832
26	640 × 480	VESA 60	31.469	59.940	H-neg, V-neg	800
27		Mac 13	35.000	66.667	H-neg, V-neg	864
28		VESA 72	37.861	72.809	H-neg, V-neg	832
29		VESA 75 (IBM M3)	37.500	75.000	H-neg, V-neg	840
30		VESA 85 (IBM M4)	43.269	85.008	H-neg, V-neg	832
31	800 × 600	VESA 56	35.156	56.250	H-pos, V-pos	1024
32		VESA 60	37.879	60.317	H-pos, V-pos	1056
33		VESA 72	48.077	72.188	H-pos, V-pos	1040
34		VESA 75 (IBM M5)	46.875	75.000	H-pos, V-pos	1056
35		VESA 85	53.674	85.061	H-pos, V-pos	1048
36	832 × 624	Mac 16	49.724	74.550	H-neg, V-neg	1152
37	1024 × 768	VESA 60	48.363	60.004	H-neg, V-neg	1344
38		VESA 70	56.476	70.069	H-neg, V-neg	1328
39		VESA 75	60.023	75.029	H-pos, V-pos	1312
45	1280 × 960	VESA 60	60.000	60.000	H-pos, V-pos	1800
47	1280 × 1024	VESA 60	63.974	60.013	H-pos, V-pos	1696
50	1400 × 1050	SXGA +	65.317	59.978	H-neg, V-pos	1864
55	1280 × 768	1280 × 768/60	47.776	59.870	H-neg, V-pos	1664
56	1280 × 720	1280 × 720/60	44.772	59.855	H-neg, V-pos	1664

Preset memory numbers for each input signal

Analog signal

Signal	Preset memory number
Video signal (VIDEO INPUT and S VIDEO INPUT connectors)	1, 2
Component signal (INPUT A and Y Pb/Cb Pr/Cr connectors)	3 to 11
Video GBR signal (INPUT A connector)	3 to 11
Computer signal (INPUT A connector)	21 to 39, 55 to 56

Digital signal

Signal	Preset memory number
Component signal (HDMI 1, 2 connectors)	3 to 8, 10 to 14
Video GBR signal (HDMI 1, 2 connectors)	3 to 8, 10 to 14
Computer signal (HDMI 1, 2 connectors)	10 to 13*, 26, 32, 36, 37, 45, 47, 50, 55

* Some digital signals input from computers may be displayed as preset memory number of Component or Video GBR signal.

Input Signals and Adjustable/Setting Items

The items in the menus available to adjust differ depending on the input signal. The following tables indicate them.

The items that cannot be adjusted are not displayed in the menu.

Picture Menu

Item	Input signal			
	Video signal	Component signal	Video GBR signal	Computer signal
Advanced Iris	●	●	●	●
Lamp Control	●	●	●	●
Contrast	●	●	●	●
Brightness	●	●	●	●
Color	● (except for B & W)	●	●	—
Hue	● (NTSC _{3.58} / NTSC _{4.43} only, except for B & W)	●	●	—
Color Temp.	●	●	●	●
Sharpness	●	●	●	—
NR	●	● (preset memory numbers 3, 4, 7, 8, 9 only)	● (preset memory numbers 3, 4, 7, 8, 9 only)	—
MPEG NR	●	●	●	●
Film Mode	●	● (preset memory numbers 3, 4, 7, 8, 9 only)	● (preset memory numbers 3, 4, 7, 8, 9 only)	—
Black Level Adj.* ¹	●	●	●	—
Gamma Correction * ¹	●	●	●	●
x.v.Color	●	●	—	—
Color Space	●	●	●	●
RCP	●	●	●	●

● : Adjustable/can be set

— : Not adjustable/cannot be set

Screen menu

Item	Input signal			
	Video signal	Component signal	Video GBR signal	Computer signal
Wide Mode	●	●	●	● * ³
Over Scan	–	●	●	–
Screen Area * ²	–	● (preset memory numbers 7, 8, 9, 12, 13, 14 only)	● (preset memory numbers 7, 8, 9, 12, 13, 14 only)	–
V Center * ⁴	●	●	●	●
Vertical Size * ⁴	●	●	●	–
APA	–	–	–	● * ⁵
Phase	–	–	–	● * ⁵
Pitch	–	–	–	● * ⁵
Shift	–	● * ⁵	● * ⁵	●

● : Adjustable/can be set

– : Not adjustable/cannot be set

*¹: The setting can be made only when “x.v.Color” is set to “Off”.



*²: The setting can be made only when “Over Scan” is set to “On” and “Wide Mode” is set to “Full” in the Screen  menu.

*³: If the input signal is from a computer, the setting cannot be made when the aspect ratio is 16:9 or wider (fixed at “Full 1”).

*⁴: The setting can be made only when “Zoom” is selected in “Wide Mode”.

*⁵: The setting can be made only for analog signal.

Note

When connecting a cable such as an HDMI cable, etc., check the type of the signal in the Information  menu ( page 56) and Digital signal ( page 74), and check items that are adjustable/can be set.

Ceiling Installation

Use the PSS-H10 Projector Suspension Support when you install the projector on a ceiling. The projection distances for ceiling installation are shown below.

- L': Distance between the screen and the installation hole at the ceiling side of the ceiling mount unit (front side)
- y': Distance between the ceiling and the center of the screen such that the picture will not be truncated or blocked

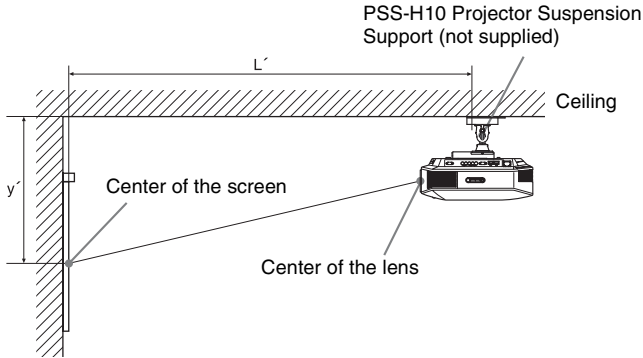

When using the 16:9 aspect ratio screen size

Screen Size SS (inches)		40	60	80	100	120	150	200	250	300
(mm)		1016	1524	2032	2540	3048	3810	5080	6350	7620
L'	(minimum)	1385 (54 ¹⁷ / ₃₂)	2008 (79 ¹ / ₁₆)	2632 (103 ⁵ / ₈)	3256 (128 ⁵ / ₃₂)	3879 (152 ²³ / ₃₂)	4814 (189 ¹⁷ / ₃₂)	6373 (250 ²⁹ / ₃₂)	7932 (312 ⁹ / ₃₂)	9491 (373 ²¹ / ₃₂)
	(maximum)	2013 (79 ⁹ / ₃₂)	2955 (116 ⁵ / ₁₆)	3896 (153 ³ / ₈)	4837 (190 ⁷ / ₁₆)	5779 (227 ¹ / ₂)	7190 (283 ³ / ₃₂)	9544 (375 ³ / ₄)	11897 (468 ³ / ₈)	14250 (561 ¹ / ₃₂)
y'	(minimum)	249 (9 ⁷ / ₈)	374 (14 ³ / ₄)	498 (19 ⁵ / ₈)	623 (24 ⁵ / ₈)	747 (29 ¹ / ₂)	934 (36 ⁷ / ₈)	1245 (49 ¹ / ₈)	1557 (61 ³ / ₈)	1868 (73 ⁵ / ₈)
	(maximum)	592 (23 ³ / ₈)	754 (29 ³ / ₄)	916 (36 ¹ / ₈)	1078 (42 ¹ / ₂)	1240 (48 ⁷ / ₈)	1483 (58 ¹ / ₂)	1887 (74 ³ / ₈)	2292 (90 ¹ / ₄)	2697 (106 ¹ / ₄)

Unit: mm (inches)

To calculate the installation positions

$$L' \text{ (minimum)} = 31.1781 (1 \frac{7}{32}) \times SS + 137.7 (5 \frac{13}{32})$$

$$L' \text{ (maximum)} = 47.0644 (1 \frac{27}{32}) \times SS + 130.8 (5 \frac{5}{32})$$

$$y' \text{ (minimum)} = 6.2263 (1 \frac{1}{4}) \times SS$$

$$y' \text{ (maximum)} = 8.0942 (5 \frac{1}{16}) \times SS + 268.5 (10 \frac{9}{16})$$

When using the 4:3 aspect ratio screen size

Screen Size SS (inches)		40	60	80	100	120	150	200	250	300
(mm)		1016	1524	2032	2540	3048	3810	5080	6350	7620
L'	(minimum)	1664 (65 ¹ / ₂)	2427 (95 ⁹ / ₁₆)	3190 (125 ¹⁹ / ₃₂)	3953 (155 ²¹ / ₃₂)	4717 (185 ¹¹ / ₁₆)	5861 (230 ³ / ₄)	7769 (305 ⁷ / ₈)	9677 (380 ³¹ / ₃₂)	11585 (456 ³ / ₃₂)
	(maximum)	2435 (95 ²⁷ / ₃₂)	3587 (141 ⁷ / ₃₂)	4739 (186 ⁹ / ₁₆)	5891 (231 ²⁹ / ₃₂)	7043 (277 ⁹ / ₃₂)	8771 (345 ⁵ / ₁₆)	11651 (458 ¹¹ / ₁₆)	14531 (572 ¹ / ₁₆)	17411 (685 ¹⁵ / ₃₂)
y'	(minimum)	305 (12 ¹ / ₈)	457 (18)	610 (24 ¹ / ₈)	762 (30)	914 (36)	1143 (45)	1524 (60)	1905 (75)	2286 (90)
	(maximum)	665 (26 ¹ / ₄)	863 (34)	1061 (41 ⁷ / ₈)	1259 (49 ⁵ / ₈)	1457 (57 ³ / ₈)	1754 (69 ¹ / ₈)	2250 (88 ⁵ / ₈)	2745 (108 ¹ / ₈)	3240 (127 ⁵ / ₈)

Unit: mm (inches)

To calculate the installation positions

$$L' \text{ (minimum)} = 38.1569 (1 \frac{1}{2}) \times SS + 137.7 (5 \frac{13}{32})$$

$$L' \text{ (maximum)} = 57.5992 (2 \frac{9}{32}) \times SS + 130.8 (5 \frac{5}{32})$$

$$y' \text{ (minimum)} = 7.62 (5 \frac{1}{16}) \times SS$$

$$y' \text{ (maximum)} = 9.906 (3 \frac{3}{8}) \times SS + 268.5 (10 \frac{9}{16})$$

Attaching the PSS-H10 projector suspension support

For details on installation on a ceiling, refer to the Installation manual for Dealers of the PSS-H10. Make sure to consult with a qualified Sony personnel for installation.

The installation measurements are shown below when installing the projector on a ceiling using the PSS-H10.

Top view

Install the projector so that the center of the lens is parallel to the center of the screen.

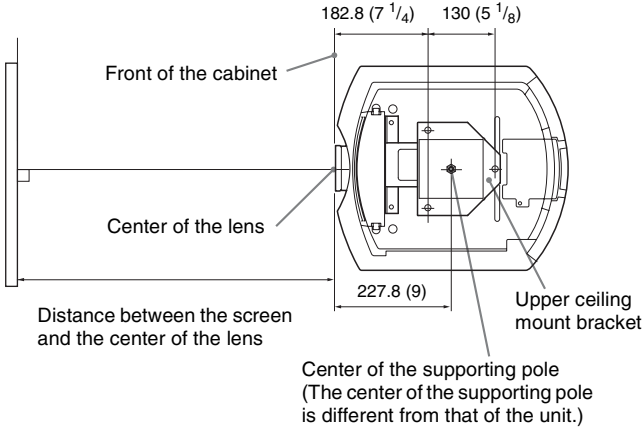

Front view

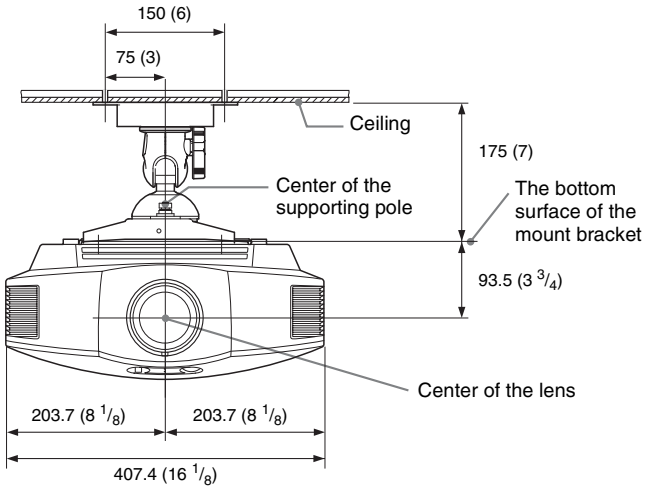

Side view

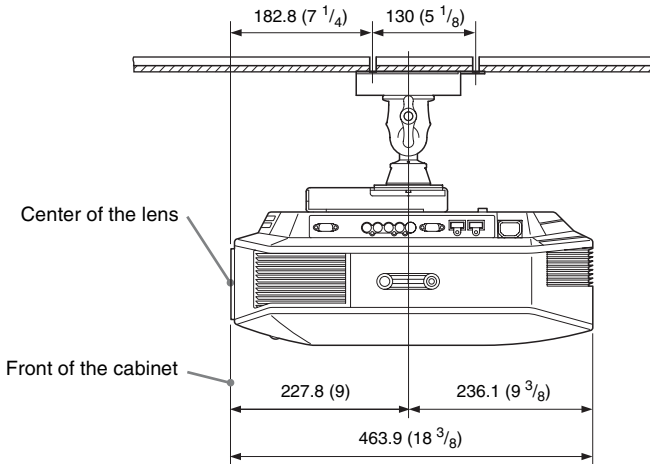

Index

A

Adjust Signal	
APA	49
Phase	49
Pitch	49
Shift	49
Adjuster	21
Adjusting	
picture position	17
picture quality	35
Advanced Iris	44
APA	49
Auto Input Search	53

B

Background	53
Black Level Adj.	45
Blanking	54
Brightness	44

C

Ceiling Installation	77
Cinema Black Pro	44
Color Space	46
Color System	51
Color Temp.	45
Connecting	
Computer	25
Video equipment	22
Contrast	44
Control for HDMI	52
Cooling Setting	50

E

Expert Setting	45, 46
----------------------	--------

F

fH	56
fV	56

G

Gamma Correction	46
------------------------	----

H

HDMI	22
------------	----

Hue	44
-----------	----

I

Image Flip	54
Input-A Signal Sel.	51

L

Lamp Control	44
Lamp Timer	56
Language	50
Location of Controls	
Front/Right side	7
Rear/Bottom	8

M

Menu	
Advanced Picture	47
Function	52
Information	56
Installation	54
Picture	43
Screen	48
Setup	50
Messages	
Caution	64
Warning	64
MPEG NR	45

N

NR	45
----------	----

O

Over Scan	49
-----------------	----

P

Panel Alignment	55
Picture Mode	
CINEMA	34
Cinema	43
DYNAMIC	34
Dynamic	43
STANDARD	34
Standard	43
USER	34
User	43
Precautions	6
Preset Memory	57
Preset Signals	72

R

RCP	47
Remote control	
inserting the batteries	10
location of controls	9
Reset	
resettable items	42
resetting the items	42

S

Screen Area	49
Selecting the menu language	26
Sharpness	45
Specifications	70
Standby Mode	50
Status	50
Supplied accessories	10

T

Troubleshooting	60
-----------------------	----

V

V Keystone	54
------------------	----

W

WIDE MODE	32
Wide Mode	
Full	48
Full 1	48
Full 2	48
Normal	48
Wide Zoom	48
Zoom	48

X

x.v.Color	46, 59
-----------------	--------

