

UF55/UF55w Projector User's Guide

Part of the SMART Board™ 600i3
Interactive Whiteboard System

Registration Benefits

If you register your SMART product, we'll notify you of new features and software upgrades.

Register online at www.smarttech.com/registration.

Keep the following information available, in case you need to contact Technical Support:

Serial Number _____

Date of Purchase _____

FCC Warning

This equipment has been tested and found to comply with the limits for a Class A digital device, pursuant to Part 15 of the FCC Rules. These limits are designed to provide reasonable protection against harmful interference when the equipment is operated in a commercial environment. This equipment generates, uses and can radiate radio frequency energy and, if not installed and used in accordance with the manufacturer's instructions, may cause harmful interference to radio communications. Operation of this equipment in a residential area is likely to cause harmful interference in which case the user will be required to correct the interference at his own expense.

Trademark Notice

SMART Board, smarttech and the SMART logo are trademarks or registered trademarks of SMART Technologies ULC in the U.S. and/or other countries. All other third-party product and company names may be the trademarks of their respective owners. Windows is either a registered trademark or a trademark of Microsoft Corporation in the U.S. and/or other countries. Apple, Macintosh, and iMac are trademarks of Apple Computer, Inc., registered in the U.S. and other countries.

Copyright Notice

© 2008 SMART Technologies ULC. All rights reserved. No part of this publication may be reproduced, transmitted, transcribed, stored in a retrieval system or translated into any language in any form by any means without the prior written consent of SMART Technologies ULC. Information in this manual is subject to change without notice and does not represent a commitment on the part of SMART.









Patent No. US5448263; US6141000; US6326954; US6337681; US6540366; US6741267; US6747636; US7151533; US7289113; US7283126; and CA2058219. Other patents pending.

Table of Contents

Table of Contents	1
Usage Notice.....	2
Precautions.....	2
Introduction.....	4
Product Features	4
Projector Package Overview	5
Product Overview	6
Main Unit.....	6
Connection Ports	7
Remote Control.....	8
Installation	10
Connecting the Projector	10
Opening and Closing the Input and Output Cover	10
Turning On the Projector and Putting It into Idle Mode	11
Turning On the Projector.....	11
Putting the Projector into Idle Mode.....	11
Adjusting the Projected Image.....	12
Adjusting the Projector's Focus	12
User Controls	13
On-Screen Display Menus.....	13
Using the OSD Menus	13
Image Adjustment	14
Audio Control	18
Default Settings.....	19
Network Settings	24
Multi Languages.....	25
Projector Information.....	26
Web Management.....	27
Appendices.....	42
Troubleshooting.....	42
Image Problems	42
Other Problems	44
Projector Status Indication	45
Compatibility Modes	47
RS-232 Connector Pin Assignments	49
Lens cleaning instruction.....	50
Replacing the lamp.....	51
Regulatory Compliance	53
Customer Support	54

Precautions

Follow all warnings, precautions and maintenance as recommended in this user's guide.

-  Warning: Don't look into the projector's lens when the lamp is on. The bright light may damage your eyes.
-  Warning: To reduce the risk of fire or electric shock, don't expose this projector to rain or moisture.
-  Warning: Don't open or disassemble the projector as this may cause electric shock.
-  Warning: Take the projector down off the Boom before replacing the lamp.
-  Warning: Before replacing the lamp, allow the projector to cool down and then turn it off. Disconnect the projector from the power outlet, and follow all the lamp replacement instructions.
-  Warning: This projector detects its own remaining lamp life. Replace the lamp when lamp life warning messages appear.
-  Warning: When you switch the projector off, ensure that the cooling cycle is complete before disconnecting the power. Allow 90 seconds for the projector to cool down.
-  Warning: Cooling of the lamp during the ignition phase should be avoided, because this could lead to ignition failures. After a successful starting attempt keep the lamp burning for at least 15 minutes to keep lamp life.
-  Warning: When the lamp is approaching to the end of its life, the message "Lamp is approaching the end of its useful life in full power operation" appears on the screen. Contact your local reseller or service center to change the lamp as soon as possible.

Usage Notice

Do

- Turn off the product before cleaning it.
- Use a soft cloth moistened with a mild detergent to clean the display housing.
- Disconnect the power plug from the AC outlet if the product isn't being used for a long period of time.
- Allow 15 minutes before restarting the lamp. This will prolong lamp life.

Don't

- Block the ventilation slots and openings on the unit.
- Use abrasive cleaners, waxes or solvents to clean the unit.
- Use under the following conditions:
 - In extremely hot, cold or humid environments.
 - ▶ Sea level to 6000 feet
 - Extremely hot: > 35°C
 - Extremely cold: < 5°C
 - ▶ 6000 feet above
 - Extremely hot: > 30°C
 - Extremely cold: < 5°C
 - ▶ Extremely humid: > 70% R.H. (Relative Humidity)
 - In areas susceptible to excessive dust and dirt.
 - Near any appliance that generates a strong magnetic field.
 - In direct sunlight.

Product Features

*This product is a single chip DLP® projector.
Outstanding features include:*

- ◆ DLP Technology
- ◆ UF55:
 - True XGA 0.55" 1024 × 768 resolution
 - Aspect ratio: 4:3
 - Short throw ratio: 0.6
- UF55w:
 - True WXGA 0.65" 1280 × 800 resolution
 - Aspect ratio: 16:10
 - Short throw ratio: 0.51
- ◆ 2000 ANSI Lumens (typical)
- ◆ Computer compatibility:
Apple® Macintosh®, iMac®, and VESA® Standards:
UXGA, SXGA+, SXGA, WXGA, XGA, SVGA, VGA
- ◆ Video compatibility:
 - NTSC, NTSC4.43
 - PAL/PAL-M/PAL-N/SECAM
 - SDTV compatible (480i/p, 576i/p)
 - HDTV compatible (720p, 1080i)
- ◆ Remote manager via network
- ◆ Remote manager via RS-232

Introduction

Projector Package Overview

This projector comes with all the items shown below. Check to make sure your package is complete. Contact your dealer immediately if anything is missing.

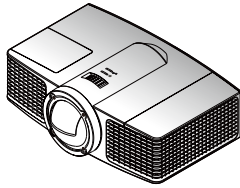

Projector



Remote Control

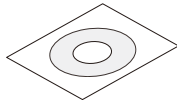

User's Guide

Introduction

Product Overview

Main Unit

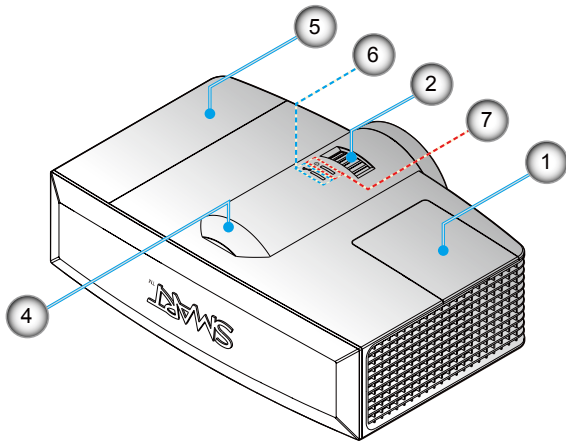
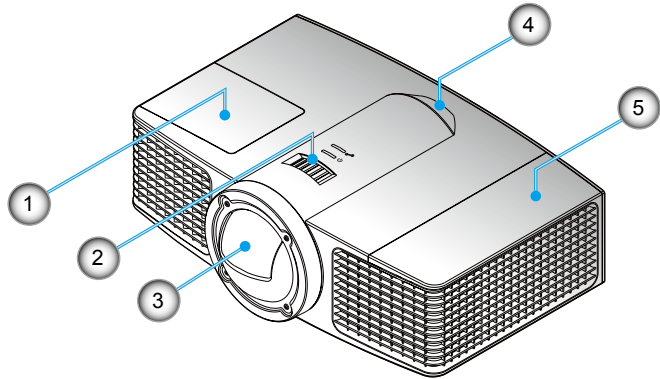

- | | |
|--------------------|-----------------------------|
| 1. Lamp cover | 5. Input/Output (IO) cover |
| 2. Focus | 6. Diagnostic Indicator LED |
| 3. Projection Lens | 7. Power Indicator LED |
| 4. IR Receiver | |

Introduction

Connection Ports

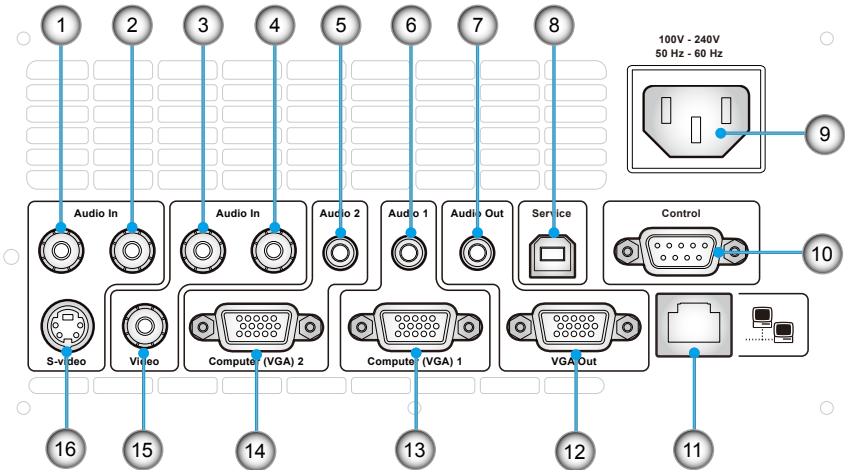



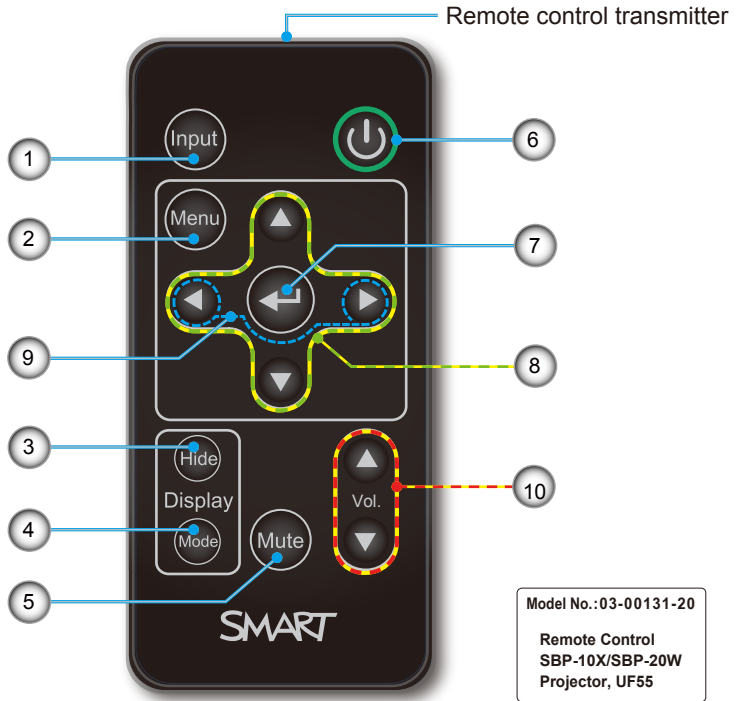

1. Audio-L Connector (for S-Video Connector)
2. Audio-R Connector (for S-Video Connector)
3. Audio-L Connector (for Composite Video Connector)
4. Audio-R Connector (for Composite Video Connector)
5. Audio-2 Input Connector (for VGA2-In Connector)
6. Audio-1 Input Connector (for VGA1-In Connector)
7. Audio-Out Connector
8. USB Connector (for service)
9. Power Socket
10. RS-232 Connector
11. Networking Connector RJ45
12. VGA-Out Connector (Monitor Loop-Through Output)
13. VGA1-In Connector
(PC Analog Signal/Component Video Input)
14. VGA2-In Connector
(PC Analog Signal/Component Video Input)
15. Video Input Connector
16. S-Video Input Connector

Introduction

Remote Control



Use the remote control to control these functions:

1.	Input	Select input source.
2.	Menu	Display menus.
3.	Hide	Press to hide or display the image.
4.	Mode	Select a display mode: Bright Classroom, Dark Classroom, sRGB or User.
5.	Mute	Turn off the sound temporarily.
6.	Power 	Turn on the power or enter Idle Mode.
7.	Enter 	Accept the selected mode.
8.		Menu selections and adjustments.
9.		Set the projector ID number.
10.	VOL.	Adjust the volume.

Introduction

To change the remote control's battery



When you use the remote control for the first time, there is a plastic sheet between the battery and its contact. Remove the sheet before use.

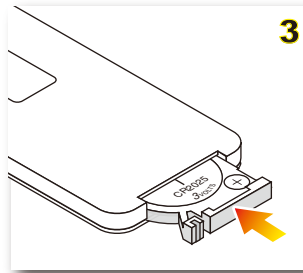
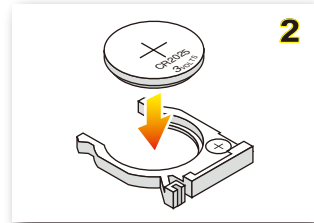
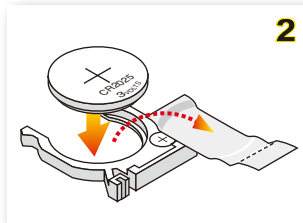
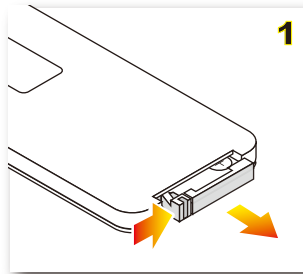

Procedure

1. Remove the battery holder by holding down the side release firmly and pulling out the battery holder. ❶
2. Insert a CR2025 coin cell battery. ❷
Be sure to align the plus and minus ends of the battery properly.
3. Replace the battery holder. ❸

Installation

Connecting the Projector

Opening and Closing the Input and Output Cover

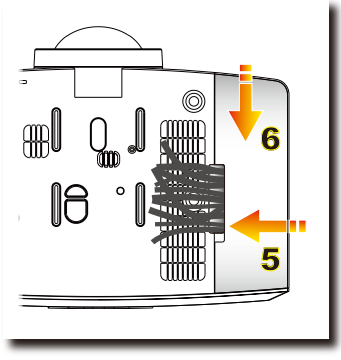
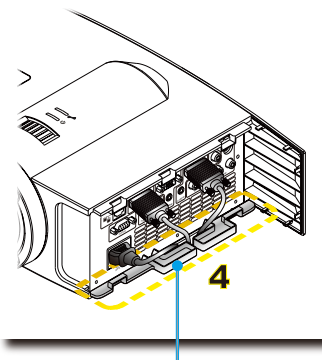
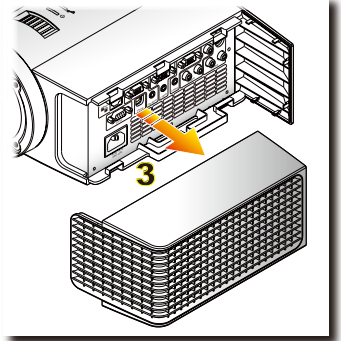
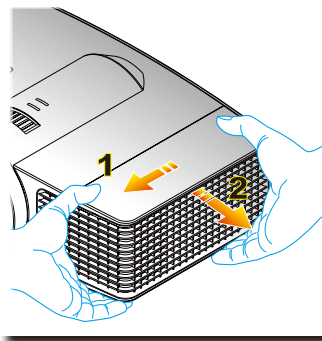

Cable management slot

○ Procedure ○

1. Pull the cable cover forward ❶ and leftward ❷ to remove the cable cover from the slot. ❸
2. Connect the power cord and the cable that you want to connect to the projector.
3. Collect all cables in the cable management slot. ❹
4. Clip the Input / Output IO cover rightward to the projector. ❺
5. Fit the Input / Output IO cover with the rear cover backward tightly ❻

Turning On the Projector and Putting It into Idle Mode



The first time you use the projector, you can select your preferred language from the main menu after the startup screen displays.



Turning On the Projector

1. Ensure that the power cord and video signal cable are securely connected. The Power LED is solid Amber.
 2. Turn on the lamp by pressing “” on the remote control. The Power LED turns green.
The startup screen displays in approximately 10 seconds.
 3. Turn on your source. Select **Input** on the remote control to select an input source (VGA-1, VGA-2, Composite or S-Video).
The projector detects the source you select and displays the image.
- If you connect multiple sources at the same time, press **Input** on the remote control to switch between inputs.

Putting the Projector into Idle Mode

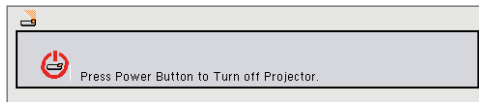
1. Press “” on the remote control to turn off the projector lamp. A message appears on the interactive whiteboard.



2. Press “” again to confirm your selection. If you don't press “” again, the message disappears after 10 seconds.

 **Caution!** Don't turn on the projector immediately after entering Idle Mode.

Adjusting the Projected Image

Adjusting the Projector's Focus

To focus the image, rotate the Focus Ring until the image is clear.

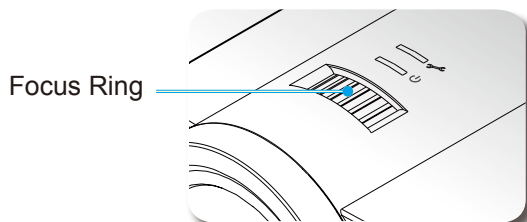

On-Screen Display Menu

The projector has multilingual On-Screen Display (OSD) menus that allow you to make image adjustments and change a variety of settings.

Using the OSD Menu

1. To open the OSD menu, press **Menu** on the remote control.
2. When the OSD displays, use the ◀▶ buttons to select an item in the main menu. Select an item and press the ▼ button to enter a submenu.
3. Use the ▲▼ buttons to select the desired item in the submenu and adjust the settings using the ◀▶ button.
4. Select the next item that you want to adjust in the submenu and adjust it as described above.

When each item is adjusted, the projector saves the new setting.

5. Press the ▲ in the first item of each submenu to return to the main menu.
6. To exit the OSD menu, press **Menu** again. The OSD menu closes.

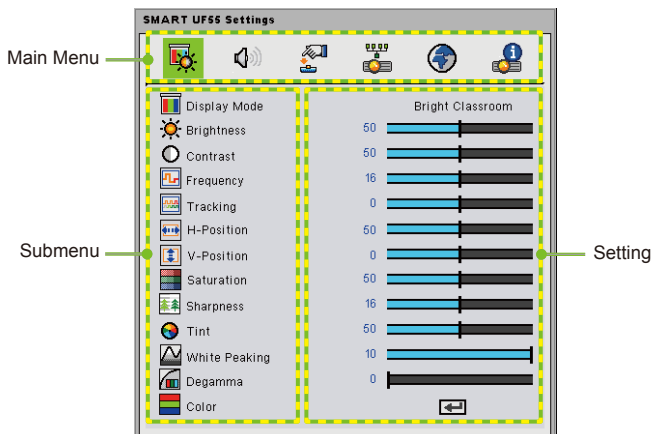
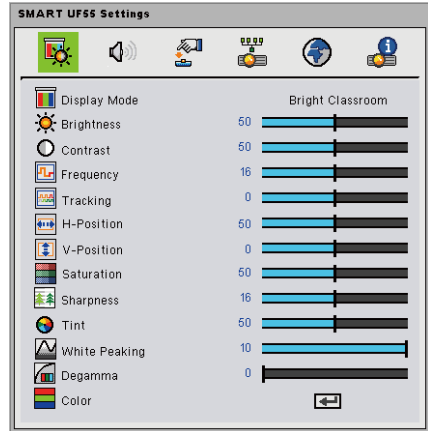

Image Adjustment



Display Mode

There are four factory presets optimized for various types of images:

- ▶ Bright Classroom: This mode is recommended for projecting in a bright classroom.
- ▶ Dark Classroom: This mode is recommended for projecting in a dark classroom.
- ▶ sRGB: This mode provides standardized accurate color.
- ▶ User: This mode allows you to apply your own settings.

Brightness

To adjust the brightness of the image:

- ▶ Press ◀ on the remote control to darken image.
- ▶ Press ▶ on the remote control to lighten the image.

Contrast

The contrast controls the degree of difference between the lightest and darkest parts of the picture. Adjusting the contrast changes the amount of black and white in the image.

- ▶ Press ◀ on the remote control to decrease the contrast.
- ▶ Press ▶ on the remote control to increase the contrast.

Image Adjustment



Frequency, Tracking, H-Position and V-Position functions are only supported under Analog VGA (RGB) signal.

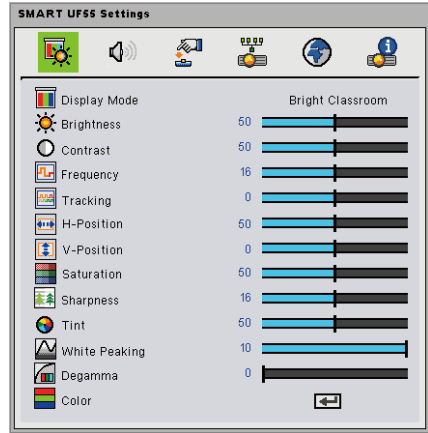

Frequency

Change the display data frequency to match the frequency of your computer's graphic card. If a flickering vertical bar appears on your screen, use this function to make an adjustment.

Tracking

Synchronize the signal timing of the display with your computer's graphics card. If the image appears to be unstable or flickers, use this function to correct it.

H-Position

- ▶ Press ◀ on the remote control to move the image left.
- ▶ Press ▶ on the remote control to move the image right.

V-Position

- ▶ Press ◀ on the remote control to move the image down.
- ▶ Press ▶ on the remote control to move the image up.

Image Adjustment

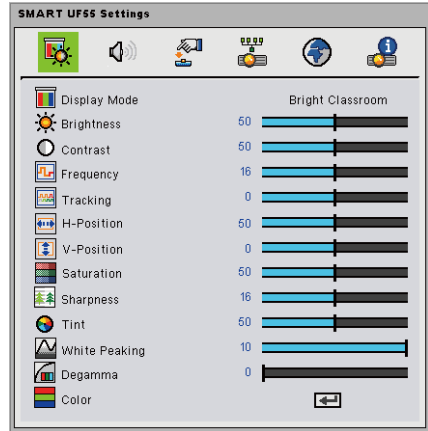

Saturation

To adjust a video image from black and white to fully saturated color:

- ▶ Press ◀ on the remote control to decrease the amount of saturation in the image.
- ▶ Press ▶ on the remote control to increase the amount of saturation in the image.



Saturation, Sharpness and Tint functions are available only when the video source is connected.

Sharpness

To adjust the sharpness of the image:

- ▶ Press ◀ on the remote control to decrease the sharpness.
- ▶ Press ▶ on the remote control to increase the sharpness.

Tint

To adjust the color balance of red and green:

- ▶ Press ◀ on the remote control to increase the amount of green in the image.
- ▶ Press ▶ on the remote control to increase the amount of red in the image.

Image Adjustment

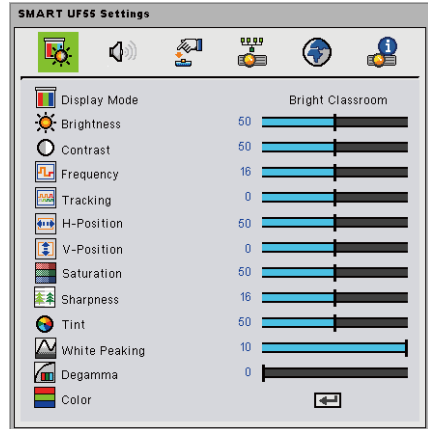

White Peaking

This adjustable item utilizes a new color-processing algorithm and system level enhancements to enable higher brightness while providing true, more vibrant colors in picture. The range is from “0” to “10”. If you prefer a more enhanced brightness, select a higher setting. For a smoother, more natural image, adjust toward the lower setting.

Degamma

Allows you to adjust the color performance of the display.

Color

Adjust the Red, Green, Blue, Cyan, Magenta and Yellow colors from the factory default settings for advanced adjustment of the individual colors.

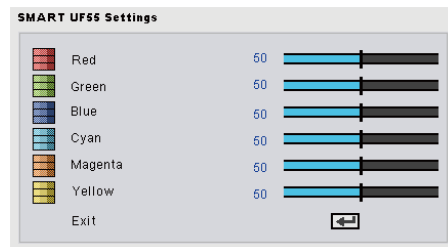

Audio Control

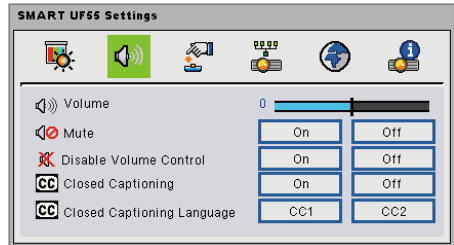

Volume

- ▶ Press ◀ on the remote control to decrease the volume.
- ▶ Press ▶ on the remote control to increase the volume.

Mute

- ▶ Select **On** to mute the sound.
- ▶ Select **Off** to turn off mute.

Disable Volume Control

- ▶ Select **On** to disable the volume adjustment.
- ▶ Select **Off** to enable the volume adjustment.

Closed Captioning

- ▶ Select **On** to turn on closed captions.
- ▶ Select **Off** to turn off the captioning feature.

Closed Captioning Language

Choose the closed captioning language. This feature is only supported in CC1 or CC2 mode.

CC1 language: American English.

CC2 language (depending on the TV channel of the user):
Spanish, French, Portuguese, German, Danish.

Default Settings

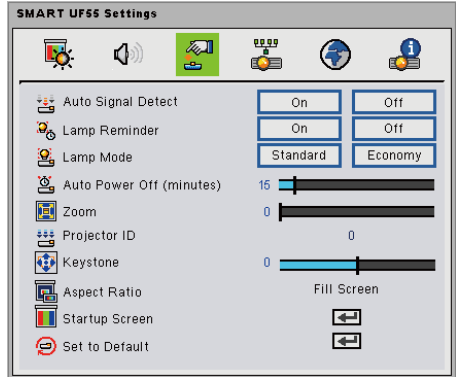

Auto Signal Detect

Auto Signal Detect enables the sequential searching of input connectors for a signal.

- ▶ **On** scans the inputs sequentially until the first input signal is found.
- ▶ **Off** keeps the signal detection in one input connector.

Lamp Reminder

Select this option to show or to hide the warning message when the “change lamp” message displays. The message appears 100 hours before the recommended lamp replacement.

Lamp Mode

To adjust the brightness of the image:

- ▶ Select **Standard** to brighten the image.
- ▶ Select **Economy** to darken the image.

Auto Power Off (minutes)

Set the countdown timer interval. The countdown timer starts when there is no signal being sent to the projector. The projector enters Idle Mode when the countdown finishes.

If user wishes to re-start the projector, please power on the projector again.

Default Settings

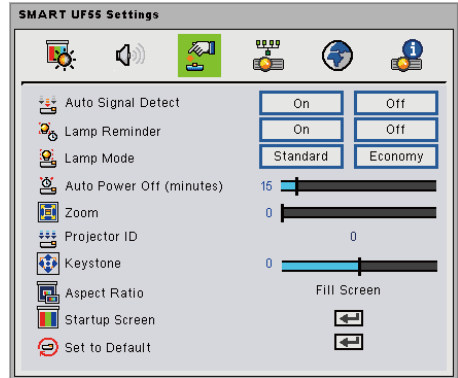

Zoom

- ▶ Press **▶** on the remote control to digitally magnify a default area of image in the center of the screen.
- ▶ Press **◀** on the remote control to zoom out of the image.

Projector ID

Press **◀** or **▶** on the remote control to set the projector ID number. The range of numbers is from 01 to 99.

Keystone

Press **◀** or **▶** on the remote control to adjust image distortion vertically and make a squarer image.

Aspect Ratio

Select one of the following aspect ratios to define how the image appears:

- ▶ **Fill Screen:** The input source scales to fit the full size of projection area.
- ▶ **Match Input:** The original input source's aspect ratio is used.
- ▶ **16:9:** Use this format for 16:9 input sources, such as HDTV and DVDs enhanced for widescreen TV.

Default Settings Startup Screen



Startup Screen

Use this function to select your desired startup screen. If you change this setting, when you exit the OSD menu, the new setting takes effect the next time you open the OSD open.

- ▶ SMART: The default startup screen.
- ▶ User: Uses the saved picture from the “Capture User Startup Screen” function.

Capture User Startup Screen

Press  on the remote control to capture a picture of the display screen.

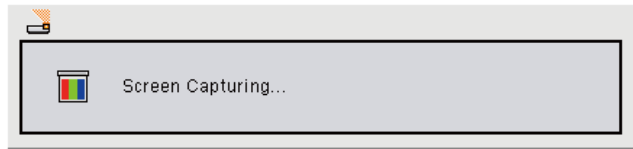

Preview Startup Screen

Press  on the remote control to preview the user startup screen on the display screen.

User Controls

Default Settings

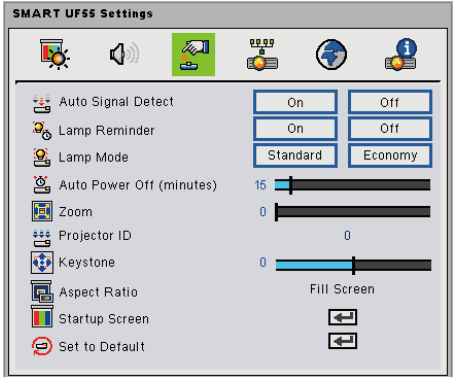

Set to Default

Select "Yes" to return the display parameters on all menus to the factory default settings.

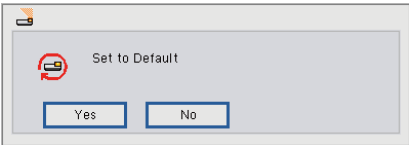

Default Settings



For configuring the network setting, please refer to **Web Management** on page 27

Status

Display the network connection status.

DHCP

Turn the network DHCP on or off.

- ▶ **On** assigns an IP address to the projector from the DHCP server automatically.
- ▶ **Off** allows you to assign an IP address manually.

Password Reminder

Press ← on the remote control to e-mail the yourself password you set through Web Management.

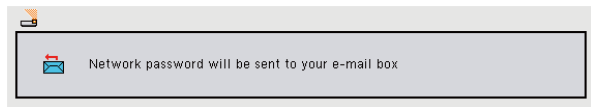

IP Address

Display the IP address.

Subnet Mask

Display the subnet mask number.

Network Settings

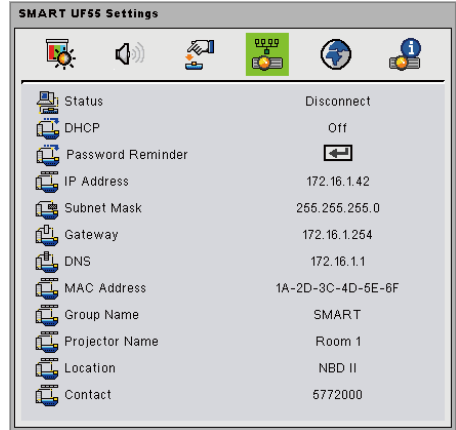

For configuring the network setting, please refer to **Web Management** on page 27.

Gateway

Display the default gateway of the network connected to the projector.

DNS

Display the DNS number.

MAC Address

Display the physical address.

Group Name

Display the group name.

Projector Name

Display the projector name.

Location

Display the location information.

Contact

Display the contact information.

Multi Languages



Language

This setting lets you choose the language of the OSD. Press ▼ to enter the submenu, and then press ▲ or ▼ or ◀ or ▶ on the remote control to select your preferred language. Press ◀ on the remote control to apply your selection.

Projector Information

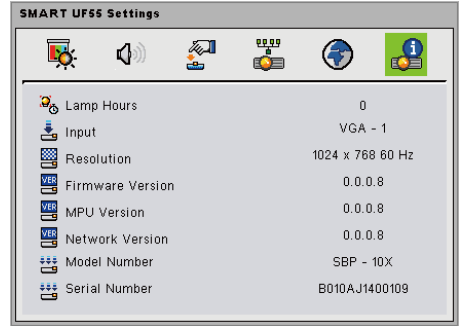

The image shows a screenshot of the SMART UF55 Settings window. The window title is "SMART UF55 Settings". It contains a table of projector information with the following data:

Setting	Value
Lamp Hours	0
Input	VGA - 1
Resolution	1024 x 768 60 Hz
Firmware Version	0.0.0.8
MPU Version	0.0.0.8
Network Version	0.0.0.8
Model Number	SBP - 10X
Serial Number	B010AJ1400109



All functions in **Projector Information** display the status of the projector only.

Lamp Hours

Display the operating hours since the last lamp timer reset.

Input

Display the input connector type.

Resolution

Display the current display resolution.

Firmware Version

Display the projector firmware version.

MPU Version

Display the projector MPU version.

Network Version

Display the projector Network version.

Model Number

Display the model number.

Serial Number

Display the Serial number.

User Controls

Web Management

This menu allows you to access Web Management and manage the projector from a remote location.

Accessing Web Management

- ▶ If the projector is connected to a network, the IP address appears on the OSD screen.

Example



Be sure to use JavaScript supportive browser.

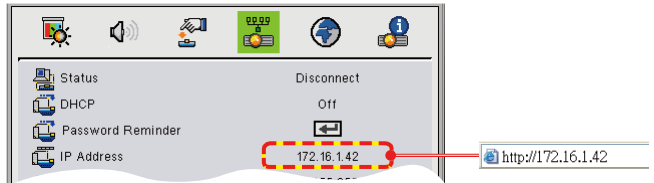

- ▶ Start the Internet Explorer® or Netscape Navigator™ Internet browser and enter the IP Address into the address field. The Web page displays as below.

SMART UF55 Projector Settings

Main Menu

- ▶ Home
- ▶ Control Panel
- ▶ **Network Settings**
- ▶ E-mail Alert
- ▶ Password Settings

Setting

Home

Projector Information

Group Name:	
Projector Name:	
Location:	
Contact:	
Status:	Idle
Lamp Hours:	0 Hours
Firmware Version:	0.0.5.5
Input:	None
Resolution (RGB):	None
IP Address:	192.168.5.140
MAC Address:	00-50-41-70-02-EC
Admin Password:	Disable
Display Hours:	0 Hours
Failure Log:	Normal
High Speed Fan:	Normal
Projector Mode:	Ceiling
Serial Number:	000000000000

Language

- English
- Español
- Français
- Português (Brazil)
- 日本語
- 简体中文
- 繁體中文
- 한국어
- Deutsch
- Italiano
- Nederlands
- Dansk
- Suomi
- Ελληνικά
- Norsk
- Polski
- Čeština
- Svenska
- Português (Portugal)
- Русский

Press **Submit** to apply your selection.

User Controls

Home Page

The **Home Page** displays basic information about the projector and allows you to set the OSD language.

SMART UF55 Projector Settings

▶ [Home](#)

▶ [Control Panel](#)

▶ [Network Settings](#)

▶ [E-mail Alert](#)

▶ [Password Settings](#)

Home

Projector Information

Group Name:

Projector Name:

Location:

Contact:

Status: Idle

Lamp Hours: 0 Hours

Firmware Version: 0.0.5.5

Input: None

Resolution (RGB): None

IP Address: 192.168.5.140

MAC Address: 00-50-41-70-02-EC

Admin Password: Disable

Display Hours: 0 Hours

Failure Log: Normal

High Speed Fan: Normal

Projector Mode: Ceiling

Serial Number: 000000000000

Language

English

Español

Français

Português (Brazil)

日本語

简体中文

繁體中文

한국어

Deutsch

Italiano

Nederlands

Dansk

Suomi

Ελληνικά

Norsk

Polska

Čeština

Svenska

Português (Portugal)

Русский

Language

Choose the language for the Web Management interface. Press **Submit** to apply your selection.

Projector Information

Display the projector information.

User Controls

Control Panel

The **Control Panel** allows you to manage the projector status using a Web browser.

SMART UF55 Projector Settings

▶ [Home](#)

▶ [Control Panel](#)

▶ [Network Settings](#)

▶ [E-mail Alert](#)

▶ [Password Settings](#)

Control Panel

Power

Power:

Restore All Projector Defaults:

Audio

Volume:(0) (-20 ~ 20)

Mute: On Off

Volume Control: On Off

Closed Captioning

Closed Captioning: On Off

Language: CC1 CC2

Power

- ▶ Select **Power ON** to turn on the projector.
- ▶ Select **Power OFF** to put the projector into Idle Mode.

Restore All Projector Defaults

- ▶ Select **Submit** to return the factory default settings.
- ▶ Select **Refresh** to refresh the current settings.

Volume

Adjust volume of the projector.

Mute

- ▶ Select **On** to mute the sound.
- ▶ Select **Off** to turn off mute.

Volume Control

- ▶ Select **On** to allow volume adjustment.
- ▶ Select **Off** to disable the volume adjustment.

User Controls

Control Panel

SMART UF55 Projector Settings

- ▶ [Home](#)
- ▶ [Control Panel](#)
- ▶ [Network Settings](#)
- ▶ [E-mail Alert](#)
- ▶ [Password Settings](#)

Control Panel

Power

Power:

Restore All Projector Defaults:

Audio

Volume:(0) (-20 ~ 20)

Mute: On Off

Volume Control: On Off

Closed Captioning

Closed Captioning: On Off

Language: CC1 CC2

Closed Captioning

- ▶ Select **On** to turn on closed captions.
- ▶ Select **Off** to turn off closed captions.

Language

Choose the closed captioning language. This feature is only supported in CC1 or CC2 mode.

CC1 language: American English.

CC2 language (depending on the TV channel of the user): Spanish, French, Portuguese, German, Danish.

Control Panel

SMART UF55 Projector Settings

▶ Home

▶ **Control Panel**

▶ Network Settings

▶ E-mail Alert

▶ Password Settings

Control Panel

Image adjustment- RGB (RGB input)

Display Mode:	<input type="text" value="----Select----"/>	<input type="button" value="Submit"/>
Brightness:(50)	<input type="text" value="0"/> (0 ~ 100)	<input type="button" value="Submit"/>
Contrast :(50)	<input type="text" value="0"/> (0 ~ 100)	<input type="button" value="Submit"/>
Frequency:(0)	<input type="text" value="0"/> (-5 ~ 5)	<input type="button" value="Submit"/>
Tracking:(0)	<input type="text" value="0"/> (0 ~ 31)	<input type="button" value="Submit"/>
Sharpness:(16)	<input type="text" value="0"/> (0 ~ 31)	<input type="button" value="Submit"/>
White Peaking:(10)	<input type="text" value="0"/> (0 ~ 10)	<input type="button" value="Submit"/>
Degamma:(0)	<input type="text" value="0"/> (0 ~ 9)	<input type="button" value="Submit"/>
Color (Red):(50)	<input type="text" value="0"/> (0 ~ 100)	<input type="button" value="Submit"/>
Color (Green):(50)	<input type="text" value="0"/> (0 ~ 100)	<input type="button" value="Submit"/>
Color (Blue):(50)	<input type="text" value="0"/> (0 ~ 100)	<input type="button" value="Submit"/>
Color (Cyan):(50)	<input type="text" value="0"/> (0 ~ 100)	<input type="button" value="Submit"/>
Color (Magenta):(50)	<input type="text" value="0"/> (0 ~ 100)	<input type="button" value="Submit"/>
Color (Yellow):(50)	<input type="text" value="0"/> (0 ~ 100)	<input type="button" value="Submit"/>

Display Mode

Select a display mode: Bright Classroom, Dark Classroom, sRGB or User.

Brightness

Adjust the brightness of the image.

Contrast

The contrast controls the degree of difference between the lightest and darkest parts of the picture. Adjusting the contrast changes the amount of black and white in the image.

Frequency

Change the display data frequency to match the frequency of your computer's graphic card. If a flickering vertical bar appears on your screen, use this function to make an adjustment.

Tracking

Synchronize the signal timing of the display with your computer's graphics card. If the image appears to be unstable or flickers, use this function to correct it.

Control Panel

SMART UF55 Projector Settings

[▶ Home](#)
[▶ Control Panel](#)
[▶ Network Settings](#)
[▶ E-mail Alert](#)
[▶ Password Settings](#)

Control Panel

Image adjustment- RGB (RGB input)

Display Mode:	<input type="text" value="----Select----"/>	<input type="button" value="Submit"/>
Brightness:(50)	<input type="text" value="0"/> (0 ~ 100)	<input type="button" value="Submit"/>
Contrast:(50)	<input type="text" value="0"/> (0 ~ 100)	<input type="button" value="Submit"/>
Frequency:(0)	<input type="text" value="0"/> (-5 ~ 5)	<input type="button" value="Submit"/>
Tracking:(0)	<input type="text" value="0"/> (0 ~ 31)	<input type="button" value="Submit"/>
Sharpness:(16)	<input type="text" value="0"/> (0 ~ 31)	<input type="button" value="Submit"/>
White Peaking:(10)	<input type="text" value="0"/> (0 ~ 10)	<input type="button" value="Submit"/>
Degamma:(0)	<input type="text" value="0"/> (0 ~ 9)	<input type="button" value="Submit"/>
Color (Red):(50)	<input type="text" value="0"/> (0 ~ 100)	<input type="button" value="Submit"/>
Color (Green):(50)	<input type="text" value="0"/> (0 ~ 100)	<input type="button" value="Submit"/>
Color (Blue):(50)	<input type="text" value="0"/> (0 ~ 100)	<input type="button" value="Submit"/>
Color (Cyan):(50)	<input type="text" value="0"/> (0 ~ 100)	<input type="button" value="Submit"/>
Color (Magenta):(50)	<input type="text" value="0"/> (0 ~ 100)	<input type="button" value="Submit"/>
Color (Yellow):(50)	<input type="text" value="0"/> (0 ~ 100)	<input type="button" value="Submit"/>

Sharpness

Adjust the sharpness of the image.

White Peaking

This adjustable item utilizes a new color-processing algorithm and system level enhancements to enable higher brightness while providing true, more vibrant colors in picture. The range is from “0” to “10”. If you prefer a more enhanced brightness, select a higher setting. For a smoother, more natural image, adjust toward the lower setting.

Degamma

Allows you to adjust the color performance of the display.

Color

Adjust the Red, Green, Blue, Cyan, Magenta and Yellow colors from the factory default settings for advanced adjustment of the individual colors.

Control Panel

SMART UF55 Projector Settings

- ▶ Home
- ▶ **Control Panel**
- ▶ Network Settings
- ▶ E-mail Alert
- ▶ Password Settings

Control Panel

Default Settings

Auto Signal Detect:	<input type="radio"/> On <input type="radio"/> Off	<input type="button" value="Submit"/>
Lamp Reminder:	<input type="radio"/> On <input type="radio"/> Off	<input type="button" value="Submit"/>
Lamp Mode:	<input type="radio"/> Standard <input type="radio"/> Economy	<input type="button" value="Submit"/>
Auto Power Off: (15)	<input type="text" value="0"/> (0 ~ 180)	<input type="button" value="Submit"/>
Zoom:(0)	<input type="text" value="0"/> (0 ~ 20)	<input type="button" value="Submit"/>
Keystone:(0)	<input type="text" value="0"/> (-40 ~ 40)	<input type="button" value="Submit"/>
H-Position (RGB input): (50)	<input type="text" value="0"/> (0 ~ 100)	<input type="button" value="Submit"/>
V-Position (RGB Input): (0)	<input type="text" value="0"/> (-5 ~ 5)	<input type="button" value="Submit"/>
Aspect Ratio:	<input type="button" value="---Select---"/>	<input type="button" value="Submit"/>
Startup Screen:	<input type="button" value="---Select---"/>	<input type="button" value="Submit"/>

Auto Signal Detect

Auto Signal Detect enables the sequential searching of input connectors for an signal.

- ▶ **On** scans the inputs sequentially until the first input signal is found.
- ▶ **Off** keeps the signal detection in one input connector.

Lamp Reminder

Select this option to show or to hide the warning message when the “change lamp” message displays. The message appears 100 hours before the recommended lamp replacement.

Lamp Mode

To adjust the brightness of the image:

- ▶ Select **Standard** to lighten the image.
- ▶ Select **Economy** to darken the image.

Auto Power Off

Set the countdown timer interval. The countdown timer starts when there is no signal being sent to the projector. The projector enters Idle Mode when the countdown finishes.

If user wishes to re-start the projector, please power on the projector again.

Zoom

Adjust the image on the projection screen.

Control Panel

SMART UF55 Projector Settings

▶ **Home**

▶ **Control Panel**

▶ **Network Settings**

▶ **E-mail Alert**

▶ **Password Settings**

Control Panel

Default Settings

Auto Signal Detect: On Off

Lamp Reminder: On Off

Lamp Mode: Standard Economy

Auto Power Off: (15) (0 ~ 180)

Zoom:(0) (0 ~ 20)

Keystone:(0) (-40 ~ 40)

H-Position (RGB input): (50) (0 ~ 100)

V-Position (RGB Input): (0) (-5 ~ 5)

Aspect Ratio:

Startup Screen:

Keystone

Adjust the image distortion vertically and make a squarer image.

H-Position (RGB input)

Adjust the image to move left or right.

V-Position (RGB input)

Adjust the image to move up or down.

Aspect Ratio

Select one of the following aspect ratios to define how the image appears:

- ▶ **Fill Screen:** The input source scales to fit the full size of projection area.
- ▶ **Match Input:** The original input source's aspect ratio is used.
- ▶ **16:9:** Use this format for 16:9 input sources, such as HDTV and DVDs enhanced for widescreen TV.

Startup Screen

Use this function to select your desired startup screen. If you change this setting, when you exit the OSD menu, the new setting takes effect the next time you open the OSD open.

- ▶ **SMART:** The default startup screen.
- ▶ **User:** Uses the saved picture from the "Capture User Startup Screen" function.

User Controls

Control Panel

SMART UF55 Projector Settings

▶ [Home](#)

▶ [Control Panel](#)

▶ [Network Settings](#)

▶ [E-mail Alert](#)

▶ [Password Settings](#)

Control Panel

Service

High Speed Fan: High Normal

Projector Mode:

Source Select

Source:

High Speed Fan

Adjust the rotational speed of the projector's fan.

- ▶ Select **HIGH** to rotate the projector's fan at high speed if the projector's temperature is high or if the location is above 6000 ft. altitude.
- ▶ Select **NORMAL** to use the normal rotational speed.

Projection Mode

Select the projection mode (Front, Ceiling, Rear or Rear Ceiling).

Source

Select the input source (VGA-1, VGA-2, Composite or S-Video).

User Controls

Network Settings

The **Network Settings** allow you to enable or disable DHCP and set network related addresses and names.

SMART UF55 Projector Settings

- ▶ [Home](#)
- ▶ [Control Panel](#)
- ▶ [Network Settings](#)
- ▶ [E-mail Alert](#)
- ▶ [Password Settings](#)

Network Settings

DHCP: On Off

IP Address:

Subnet Mask:

Gateway:

DNS:

Group Name:

Projector Name:

Location:

Contact:

DHCP

- ▶ **On** assigns an IP address to the projector from the DHCP server automatically.
- ▶ **Off** allows you to assign an IP address manually.

IP Address

Set an IP address.

Subnet Mask

Set the subnet mask number.

Gateway

Set the gateway number.

DNS

Set the DNS number.

User Controls

Network Settings

SMART UF55 Projector Settings

[▶ Home](#)

[▶ Control Panel](#)

[▶ **Network Settings**](#)

[▶ E-mail Alert](#)

[▶ Password Settings](#)

Network Settings

DHCP: On Off

IP Address:

Subnet Mask:

Gateway:

DNS:

Group Name:

Projector Name:

Location:

Contact:

Group Name

Allows you to define the group name of the projector.
(Maximum characters: 12)

Projector Name

Allows you to define the projector name.
(Maximum characters: 12)

Location

Allows you to define the location of the projector.
(Maximum characters: 16)

Contact

Allows you to define the contact name of the projector.
(Maximum characters: 16)

Network Settings

The screenshot shows the 'SMART UF55 Projector Settings' interface. On the left is a navigation menu with five items: 'Home', 'Control Panel', 'Network Settings' (which is highlighted with a red arrow and a dotted underline), 'E-mail Alert', and 'Password Settings'. The main content area is titled 'Network Settings' in blue. Underneath, there is a section for 'SNMP Settings'. It includes a radio button for 'SNMP' which is currently set to 'On'. Below this are three input fields: 'Read Only Community' with a masked password of six dots, 'Read-Write Community' also with a masked password of six dots, and 'Trap Destination Address' with the value '192.168.0.218'. A 'Submit' button is located at the bottom right of the form.

SNMP Enable

- ▶ Select **On** to enable SNMP MIB function.
- ▶ Select **Off** to disable SNMP MIB function.

Read Only Community

The **Read Only Community** string is like a password. It is sent along with each SNMP Get-Request and allows access to device. The default **Read Only Community** string is “public”.

Read-Write Community

The **Read-Write Community** string is like a password. It is sent along with each SNMP Set-Request and allows access to device. The default **Read-Write Community** string is “public”.

Trap Destination Address

Allows you to define the **Trap Destination Address** of the projector.

User Controls

E-mail Alert

The **E-mail Alert** allows you to enter your e-mail alert address and adjust related settings.

The screenshot shows the 'SMART UF55 Projector Settings' interface. On the left is a navigation menu with options: Home, Control Panel, Network Settings, E-mail Alert (highlighted), and Password Settings. The main content area is titled 'E-mail Alert' and contains the following settings:

- E-mail Alert:** Radio buttons for 'Enable' and 'Disable'.
- To:** Text input field with an '@' symbol.
- Cc:** Text input field with an '@' symbol.
- From:** Text input field with an '@' symbol.
- Subject:** Text input field.
- SMTP Settings:**
 - Outgoing SMTP Server:** Text input field.
 - Username:** Text input field.
 - Password:** Text input field.

E-mail Alert

- ▶ Select **Enable** to turn on the E-mail Alert function.
- ▶ Select **Disable** to turn off the E-mail Alert function.

To

Define the e-mail address of the E-mail Alert recipient.

Cc

Define the e-mail address of the E-mail Alert “copy to” recipient.

From

Define the e-mail address of the user who sends the E-mail Alert.

Outgoing SMTP server

Define the outgoing SMTP server.

Username

Define the SMTP server user name.

Password

Define the SMTP server password.

E-mail Alert

The screenshot shows the 'SMART UF55 Projector Settings' interface. On the left is a navigation menu with five items: 'Home', 'Control Panel', 'Network Settings', 'E-mail Alert' (which is highlighted with a dashed border), and 'Password Settings'. The main content area is titled 'E-mail Alert' and contains the following elements:

- Alert Condition**
- Lamp Warning
- Low Lamp Life
- Temperature Warning
- An 'E-mail Alert Test' button (light green)
- A 'Submit' button (blue)

Alert Condition

The projector provides three alert conditions (Lamp warning, Low lamp life and Temperature warning).

- ▶ Select the conditions you want to apply, and then press **Submit** to apply the selection. The projector sends an alert e-mail (SMART Alert) to your e-mail address.
- ▶ Press the **E-mail Alert Test** to confirm your e-mail address. The projector sends a test e-mail (SMART Alert- Test Mail) to your e-mail address.

User Controls

Password Settings

This projector provides a security function that allows the administrator to manage usage for the projector.

The **Password Settings** allow you to enable the Administrator Password function.

The screenshot shows the 'SMART UF55 Projector Settings' interface. On the left is a navigation menu with links for Home, Control Panel, Network Settings, E-mail Alert, and Password Settings (which is highlighted). The main content area is titled 'Password Settings' and contains the following text: 'To enable password function during first-time user, set the password before you enable it. When the password function is enabled, you have to enter an Administrator Password when you connect to SMART UF55 Projector Web Management.' Below this text, there is a section for 'Administrator' settings. It includes a 'Password:' label with two radio buttons: 'Enable' (unselected) and 'Disable' (selected), followed by a 'Submit' button. Below that are two input fields for 'New Password:' and 'Confirm Password:', both containing four dots to represent masked characters, and a 'Submit' button.



Password

First Time:
The Password is 4
digits, default value
is "1234".

- ▶ Select **Enable** to enter a password for access to Web Management.

When the password function is enabled, the administrator password will be required to access Web Management.

The screenshot shows the 'SMART UF55 Projector Settings' interface with the title 'Welcome to Web Management'. It features a 'Username:' label with a dropdown menu showing 'Administrator' and a 'Password:' label with an empty input field and a 'Logon' button.



If you can't
remember your
password, please
refer to **Password
Reminder** on page
23.

Projector Information

Name:
IP Address: 192.168.5.140

- ▶ Select **Disable** to be able to turn on the projector without a password.

Troubleshooting

If you experience a problem with your projector, please refer to the following information. If a problem persists, please contact your local reseller or service center.

Image Problems

? No image appears on-screen

- ▶ Ensure that all the cables and power connections are correctly and securely connected as described in the “Installation” section on page 10.
- ▶ Ensure that all of the pins on the connectors are not bent or broken.
- ▶ Make sure if the projection lamp has been securely installed.
- ▶ Make sure the projector is turned on.
- ▶ Ensure that the **Hide Display** feature on the remote is disabled.

? Partial, scrolling or incorrectly displayed image

- ▶ If you are using a desktop computer:

For computers running the Windows® 95, Windows® 98, Windows® 2000, or Windows® XP operating system:

1. Click **My Computer** → **Control Panel**, and then double-click **Display**.
2. Select the **Settings** tab.
3. Verify that your display resolution setting is lower than or equal to UXGA (1600 × 1200).

If the projector is still not projecting the whole image, you will also need to change the monitor display you are using. Refer to the following steps.

4. Click **Advanced Properties**.

5. Click **Change** on the Monitor tab.
 6. Click **Show all devices**, and then select **Standard monitor types** from the SP drop-down list. Select the resolution mode you need from the **Models** drop-down list.
 7. Verify that the resolution setting of the monitor display is lower than or equal to UXGA (1600 × 1200).
- ▶ If you are using a laptop computer:
1. Follow the steps above to adjust the resolution of the computer.
 2. Press the appropriate buttons listed below for your laptop manufacturer to send signals from laptop to the projector.
Example: [Fn]+[F4]

Acer® ⇒	[Fn]+[F5]	IBM®/Lenovo® ⇒	[Fn]+[F7]
Asus® ⇒	[Fn]+[F8]	HP®/Compaq® ⇒	[Fn]+[F4]
Dell® ⇒	[Fn]+[F8]	NEC® ⇒	[Fn]+[F3]
Gateway® ⇒	[Fn]+[F4]	Toshiba® ⇒	[Fn]+[F5]

Mac Apple®:

System Preference ⇒ Display ⇒ Arrangement ⇒ Mirror display

- ▶ If you experience difficulty changing resolutions or your monitor freezes, restart all equipment including the projector.

[?] The screen of the laptop or PowerBook® computer isn't displaying your presentation

- ▶ If you are using a laptop

Some laptop PCs may deactivate their own screens when a second display device is in use. Each has a different way to be reactivated. Refer to your computer's manual for detailed information.

[?] Image is unstable or flickering

- ▶ Adjust the **Tracking** setting in the OSD to correct this issue. See page 15 for more information.
- ▶ Change the tracking setting on your computer.

[?] Image has vertical flickering bar

- ▶ Adjust **Frequency** setting in the OSD to correct this issue. See page 15 for more information.
- ▶ Check and reconfigure the display mode of your graphic card to make it compatible with the projector.

[?] Image is out of focus

- ▶ Adjust the Focus Ring on the projector lens.

[?] The image is stretched when displaying 16:9 DVD title

When you play an anamorphic DVD or a 16:9 DVD, the projector displays the image in 16:9 format.

If you play a 4:3 format DVD title, change the **Aspect Ratio** to **Fill Screen** in the projector OSD.

If the image is still stretched, adjust the aspect ratio type.

[?] Image is too small or too large

- ▶ Press **Menu** on the remote control, select **Aspect Ratio**, and then try the different settings.

Other Problems

[?] The projector freezes when you enter any control

- ▶ If possible, turn off the projector, then unplug the power cord and wait at least 60 seconds before reconnecting power.

Appendices

Projector Status Indication

Status	Power LED	Diagnostic LED
	(Green/Amber)	(Red)
Idle Mode	Solid Amber	Off
Powering	Flashing Green	Off
On (Lamp On)	Green	Off
Cooling	Flashing Amber	Off
Error (Temperature Exceeded)	Off	Flashing Red
Error (Fan Failure)*	Off	Solid Red
Error (Color Wheel Failure)*	Off	Solid Red
Error (Lamp Failure)	Solid Amber	Flashing Red



* Contact your authorized SMART Reseller to solve the problem.

Message Reminders



* Contact your authorized SMART Reseller to solve the problem.

▶ Fan failure

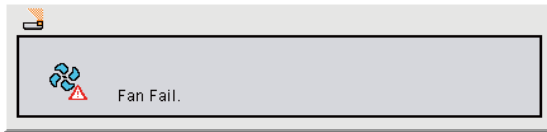

Fan breakdown: One of the fans has failed. The projector will automatically shut down.*

▶ Temperature warning

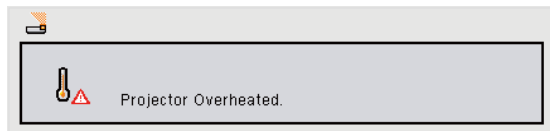

Projector overheated: Air vents might be blocked or the ambient temperature might be over 55°C. The projector will automatically shut down.

▶ Lamp warning

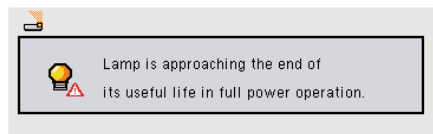

▶ Power message

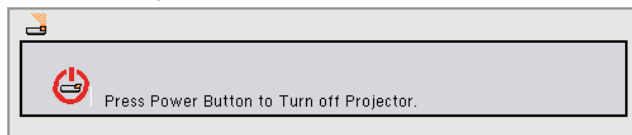

▶ Video mute message



Compatibility Modes

▶ VGA Analog

Resolution	Mode	Refresh Rate (Hz)	H-Frequency (kHz)	Pixel Clock (MHz)
720 × 400	720 × 400_85	85.039	37.927	35.5
640 × 480	VGA_60	59.94	31.469	25.175
640 × 480	VGA_72	72.809	37.861	31.5
640 × 480	VGA_75	75	37.5	31.5
640 × 480	VGA_85	85.008	43.269	36
800 × 600	SVGA_56	56.25	35.156	36
800 × 600	SVGA_60	60.317	37.879	40
800 × 600	SVGA_72	72.188	48.077	50
800 × 600	SVGA_75	75	46.875	49.5
800 × 600	SVGA_85	85.061	53.674	56.25
832 × 624	MAC16"	74.55	49.725	57.283
1024 × 768	XGA_60	60.004	48.363	65
1024 × 768	XGA_70	70.069	56.476	75
1024 × 768	XGA_75	75.029	60.023	78.75
1024 × 768	XGA_85	84.997	68.667	94.5
1024 × 768	MAC19"	74.7	60.134	79.857
1152 × 864	SXGA1_75	75	67.54	108
1280 × 768	WXGA	59.87	47.776	79.5
1280 × 800	16 × 10	59.81	49.702	83.5
1280 × 960	QuadVGA_60	60	60	108
1280 × 960	QuadVGA_85	85.002	85.938	148.5
1280 × 1024	SXGA3_60	60.02	63.981	108
1280 × 1024	SXGA3_75	75.025	79.976	135
1280 × 1024	SXGA3_85	85.024	91.146	157.5
1400 × 1050	SXGA+	59.978	65.317	121.75
1600 × 1200	UXGA_60	60	75	162
1600 × 1200	UXGA_65	65	81.25	175.5
1600 × 1200	UXGA_70	70	87.5	189
1600 × 1200	UXGA_75	75	93.75	202.5
1600 × 1200	UXGA_85	85	106.25	229.5

▶ Y/Pb/Pr signals

Signal format	fh (kHz)	fv (Hz)
480i (525i) @ 60 Hz	15.73	59.94
480p (525p) @ 60 Hz	31.47	59.94
576i (625i) @ 50 Hz	15.63	50
576p (625p) @ 50 Hz	31.25	50
720p (750p) @ 60 Hz	45	60
720p (750p) @ 50 Hz	37.5	50
1080i (1125i) @ 60 Hz	33.75	60
1080i (1125i) @ 50 Hz	28.13	50
1080p (1125p) @ 60 Hz	67.5	60
1080p (1125p) @ 50 Hz	56.25	50

▶ S-Video and Composite Video signals

Video mode	fh (kHz)	fv (Hz)	fsc (MHz)
NTSC	15.73	60	3.58
PAL	15.63	50	4.43
SECAM	15.63	50	4.25 or 4.41
PAL-M	15.73	60	3.58
PAL-N	15.63	50	3.58
PAL-60	15.73	60	4.43
NTSC4.43	15.73	60	4.43

RS-232 Connector Pin Assignments

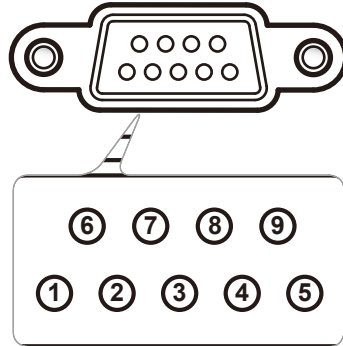

Pin no.	Spec.
1	N/A
2	TXD
3	RXD
4	N/A
5	GND
6	N/A
7	N/A
8	N/A
9	+9VDC

Lens cleaning instruction

1. Avoid touching or scratching the lens.
2. Do not use organic solvents, such as alcohol or ether, to clean the lens.
3. Use clean compressed air to remove dust and debris from the lens.
4. If wiping the lens becomes unavoidable, use protective gloves to dip a soft woven cloth in anti-static solvent and gently wipe from the center to the outer part.
Use an anti-static solvent such as Hyperclean® EE-6310 and a cloth such as Purestat® PW2004 or similar.

Replacing the lamp

When the lamp life is nearing the end of use, you will receive a warning message.

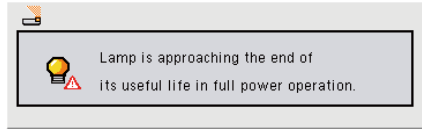



When you see this message, please contact your local reseller or service center to change the lamp as soon as possible. Make sure the projector has been cooled down for at least 30 minutes before changing the lamp.

 **Caution: Hot!** Let unit cool for 30 minutes before removing lamp module cover. Do not obstruct lens. High pressure lamp may shatter if improperly handled. Disconnect power before changing lamp. Replace only with SMART Technologies approved lamp module.

 Lamps contain mercury and must be recycled or disposed of according to local, state or federal laws.





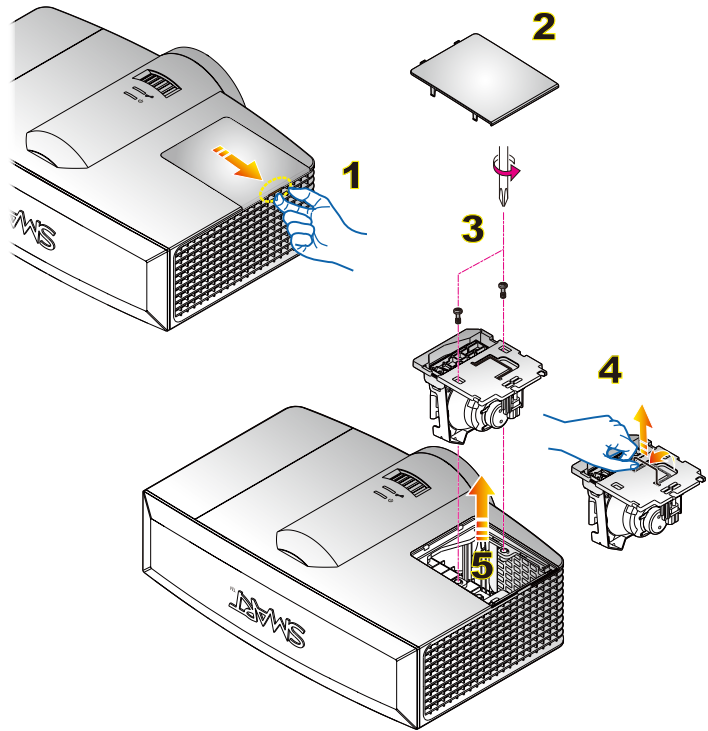

 **Warning:** Be careful of broken glass when replacing the lamp. Wear eye protection and gloves when replacing lamp.

 **Warning:** Lamp compartment may be hot! Allow it to cool down before changing the lamp.

 **Warning:** To reduce the risk of personal injury, don't drop the lamp module or touch the lamp bulb. The bulb may shatter and cause injury if it is dropped.



Lamp Replacement Procedure

1. Switch off the power to the projector by pressing “” on the remote control.
 2. Allow the projector to cool down for at least 30 minutes.
 3. Disconnect the power cord.
 4. Pull the lamp cover carefully. 
 5. Remove the lamp cover. 
 6. Use a screwdriver to unscrew the 2 screws from the lamp module. 
 7. Pull up the lamp handle carefully. 
 8. Remove the lamp module. 
- To replace the lamp module, follow previous steps in reverse order.

Regulatory Compliance

Waste Electrical and Electronic Equipment Regulations

Waste Electrical and Electronic Equipment regulations apply to all electrical and electronic equipment sold within the European Union.

When you dispose of any electrical or electronic equipment, including SMART products, we strongly encourage you to contact your local WEEE recycling agency for recycling and disposal advice.

Your SMART product required the extraction and use of natural resources for its production. It may contain hazardous substances. By disposing of electrical and electronic equipment appropriately, you lower the impact of these substances upon health and the environment and reduce the pressure on natural resources. Recycling agencies can reuse or recycle most of the materials from your product.

Please think about how you intend to dispose of any product that has a WEEE symbol or accompanying WEEE guidelines.

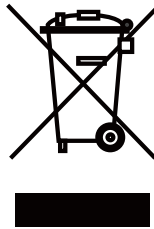

If you need more information on the collection, reuse and recycling of electrical and electronic equipment, please contact your local WEEE recycling agency.

Alternatively, contact your local reseller or SMART Technologies for information on the environmental performance of our products.

Restriction of Certain Hazardous Substances (RoHS) Directives

SMART Technologies supports global efforts to ensure that electronic equipment is manufactured, sold and disposed of in a safe and environmentally friendly manner.

This product meets the requirements of the European Union's Restriction of Certain Hazardous Substances (RoHS) Directive 2002/95/EC, as well as the People's Republic of China's Control of Pollution Caused by Electronic Information Products (China RoHS).

Subsequently, this product also complies with other, less stringent directives that have arisen in various geographical areas, and that incorporate the European Union's RoHS directive as a basis.

For more information, refer to your local regulations or visit www.smarttech.com.

Customer Support

Online Support

Visit www.smarttech.com/support to view and download user's guides, "how-to" and troubleshooting articles, software and more.

Training

Visit www.smarttech.com/trainingcenter for training materials and information about our training services.

Contacting SMART Technical Support

SMART Technical Support welcomes your call. However, if you experience difficulty with your SMART product, you may want to contact your [authorized SMART reseller](#) first. Your SMART reseller may be able to resolve the issue without delay.

All SMART products include online, telephone, fax and e-mail support:

Online: www.smarttech.com/contactsupport

Telephone: +1.403.228.5940 or

Toll Free 1.866.518.6791 (U.S./Canada)

(Monday to Friday, 5 a.m. – 6 p.m. Mountain Time)

Fax: +1.403.806.1256

E-mail: support@smarttech.com

General Inquiries

Address: SMART Technologies

1207 – 11 Ave SW, Suite 300

Calgary, AB T3C 0M5

CANADA

Switchboard: +1.403.245.0333 or

Toll Free 1.888.42.SMART (U.S./Canada)

Fax: +1.403.228.2500

E-mail: info@smarttech.com

Warranty

Product warranty is governed by the terms and conditions of SMART's "Limited Equipment Warranty" that shipped with the SMART product at the time of purchase.

Registration

To help us serve you, register online at www.smarttech.com/registration.



SMART Technologies

1207 – 11 Avenue SW, Suite 300

Calgary, AB T3C 0M5

CANADA

www.smarttech.com/support

www.smarttech.com/contactsupport

Support +1.403.228.5940

Toll Free 1.866.518.6791 (U.S./Canada)