

SHARP®

DATA PROJECTOR

MODEL

XG-PH80W-N

XG-PH80X-N

OPERATION MANUAL

Conference Series

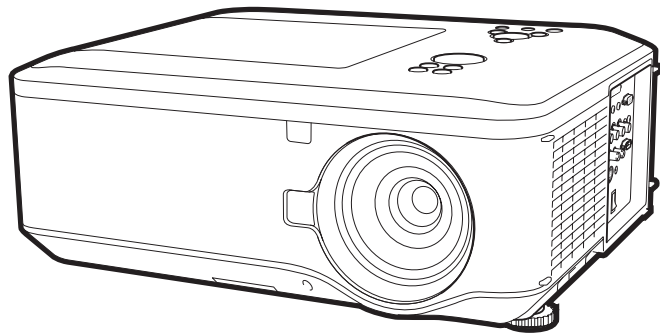

Introduction

Easy Start

Setup

Connections

Basic
Operation

Useful
Features

Appendix



IMPORTANT

- For your assistance in reporting the loss or theft of your Projector, please record the Model and Serial Number located on the bottom of the projector and retain this information.
- Before recycling the packaging, please ensure that you have checked the contents of the carton thoroughly against the list of “Supplied accessories” on page **11**.

Model No.:

Serial No.:

SPECIAL NOTE FOR USERS IN THE U.K.

The mains lead of this product is fitted with a non-rewireable (moulded) plug incorporating a 10A fuse. Should the fuse need to be replaced, a BSI or ASTA approved BS 1362 fuse marked  or  and of the same rating as above, which is also indicated on the pin face of the plug, must be used.

Always refit the fuse cover after replacing the fuse. Never use the plug without the fuse cover fitted.

In the unlikely event of the socket outlet in your home not being compatible with the plug supplied, cut off the mains plug and fit an appropriate type.

DANGER:

The fuse from the cut-off plug should be removed and the cut-off plug destroyed immediately and disposed of in a safe manner.

Under no circumstances should the cut-off plug be inserted elsewhere into a 13A socket outlet, as a serious electric shock may occur.

To fit an appropriate plug to the mains lead, follow the instructions below:

WARNING:

THIS APPARATUS MUST BE EARTHED.

IMPORTANT:

The wires in this mains lead are coloured in accordance with the following code:

Green-and-yellow	: Earth
Blue	: Neutral
Brown	: Live

As the colours of the wires in the mains lead of this apparatus may not correspond with the coloured markings identifying the terminals in your plug proceed as follows:

- The wire which is coloured green-and-yellow must be connected to the terminal in the plug which is marked by the letter E or by the safety earth symbol  or coloured green or green-and-yellow.
- The wire which is coloured blue must be connected to the terminal which is marked with the letter N or coloured black.
- The wire which is coloured brown must be connected to the terminal which is marked with the letter L or coloured red.

IF YOU HAVE ANY DOUBT, CONSULT A QUALIFIED ELECTRICIAN.

Authorized representative responsible for the European Union Community Market

SHARP ELECTRONICS (Europe) GmbH
SonninstraÙe 3, D-20097 Hamburg

E.U. ONLY

The supplied CD-ROM contains operation instructions in English, German, French, Spanish, Italian, Dutch, Swedish, Portuguese, Chinese, Korean and Arabic. Carefully read through the operation instructions before operating the projector.

Die mitgelieferte CD-ROM enthält Bedienungsanleitungen in Englisch, Deutsch, Französisch, Spanisch, Italienisch, Niederländisch, Schwedisch, Portugiesisch, Chinesisch, Koreanisch und Arabisch. Bitte lesen Sie die Bedienungsanleitung vor der Verwendung des Projektors sorgfältig durch.

Le CD-ROM fourni contient les instructions de fonctionnement en anglais, allemand, français, espagnol, italien, néerlandais, suédois, portugais, chinois, coréen et arabe. Veuillez lire attentivement ces instructions avant de faire fonctionner le projecteur.

El CD-ROM suministrado contiene instrucciones de operación en inglés, alemán, francés, español, italiano, holandés, sueco, portugués, chino, coreano y árabe. Lea cuidadosamente las instrucciones de operación antes de utilizar el proyector.

Il CD-ROM in dotazione contiene istruzioni per l'uso in inglese, tedesco, francese, spagnolo, italiano, olandese, svedese, portoghese, cinese, coreano e arabo. Leggere attentamente le istruzioni per l'uso prima di usare il proiettore.

De meegeleverde CD-ROM bevat handleidingen in het Engels, Duits, Frans, Spaans, Italiaans, Nederlands, Zweeds, Portugees, Chinees, Koreaans en Arabisch. Lees de handleiding zorgvuldig door voor u de projector in gebruik neemt.

Den medföljande CD-ROM-skivan innehåller bruksanvisningar på engelska, tyska, franska, spanska, italienska, holländska, svenska, portugisiska, kinesiska, koreanska och arabiska. Läs noga igenom bruksanvisningen innan projektorn tas i bruk.

O CD-ROM fornecido contém instruções de operação em Inglês, Alemão, Francês, Espanhol, Italiano, Holandês, Sueco, Português, Chinês, Coreano e Árabe. Leia cuidadosamente todas as instruções de operação antes de operar o projetor.

附送之CD-ROM光碟中，有用英文、德文、法文、西班牙文、意大利文、荷蘭文、瑞典文、葡萄牙文、中文、韓國文和阿拉伯文所寫的使用說明書。在操作本投影機之前，請務必仔細閱讀整本使用說明書。

제공된 CD-ROM에는 영어, 독일어, 프랑스어, 스페인어, 이탈리아어, 네덜란드어, 스웨덴어, 포르투갈어, 중국어, 한국어, 아라비아어로 작성된 조작 설명서가 수록되어 있습니다. 프로젝터를 조작하기 전에 조작 지침을 상세하게 숙지하십시오.

يحتوي القرص المضغوط المرفق مع المنتج على تعليمات التشغيل باللغة الإنجليزية، الألمانية، الفرنسية، الإسبانية، الإيطالية، الهولندية، السويدية، البرتغالية، الصينية، الكورية والعربية. برجاء قراءة تعليمات التشغيل بعناية قبل الشروع في تشغيل جهاز الإسقاط.

Before using the projector, please read this operation manual carefully.

Introduction

ENGLISH

There are two important reasons for prompt warranty registration of your new SHARP Projector, using the REGISTRATION CARD packed with the projector.

1. WARRANTY

This is to assure that you immediately receive the full benefit of the parts, service and labor warranty applicable to your purchase.

2. CONSUMER PRODUCT SAFETY ACT

To ensure that you will promptly receive any safety notification of inspection, modification, or recall that SHARP may be required to give under the 1972 Consumer Product Safety Act, PLEASE READ CAREFULLY THE IMPORTANT "LIMITED WARRANTY" CLAUSE.



U.S.A. ONLY

WARNING: High brightness light source. Do not stare into the beam of light, or view directly. Be especially careful that children do not stare directly into the beam of light.



WARNING: To reduce the risk of fire or electric shock, do not expose this product to rain or moisture.

See bottom of projector.

	CAUTION RISK OF ELECTRIC SHOCK. DO NOT REMOVE SCREWS EXCEPT SPECIFIED USER SERVICE SCREW.	
CAUTION: TO REDUCE THE RISK OF ELECTRIC SHOCK, DO NOT REMOVE COVER. NO USER-SERVICEABLE PARTS EXCEPT LAMP UNIT. REFER SERVICING TO QUALIFIED SERVICE PERSONNEL.		



The lightning flash with arrowhead symbol, within an equilateral triangle, is intended to alert the user to the presence of uninsulated "dangerous voltage" within the product's enclosure that may be of sufficient magnitude to constitute a risk or electric shock to persons.



The exclamation point within a triangle is intended to alert the user to the presence of important operating and maintenance (servicing) instructions in the literature accompanying the product.

WARNING:

This is a Class A product. In a domestic environment this product may cause radio interference in which case the user may be required to take adequate measures.

WARNING: FCC Regulations state that any unauthorized changes or modifications to this equipment not expressly approved by the manufacturer could void the user's authority to operate this equipment.

U.S.A. ONLY

The enclosed computer cable must be used with the device. The cable is provided to ensure that the device complies with FCC Class A verification.

U.S.A. ONLY

INFORMATION

This equipment has been tested and found to comply with the limits for a Class A digital device, pursuant to Part 15 of the FCC Rules. These limits are designed to provide reasonable protection against harmful interference when the equipment is operated in a commercial environment. This equipment generates, uses, and can radiate radio frequency energy and, if not installed and used in accordance with the operation manual, may cause harmful interference to radio communications. Operation of this equipment in a residential area is likely to cause harmful interference, in which case the user will be required to correct the interference at his own expense.

U.S.A. ONLY

PRODUCT DISPOSAL

This product utilizes lamp containing a small amount of mercury. Disposal of these materials may be regulated due to environmental considerations. For disposal or recycling information, please contact your local authorities, the Electronics Industries Alliance: www.eiae.org, the lamp recycling organization www.lamprecycle.org, or Sharp at 1-800-BE-SHARP.

U.S.A. ONLY

Caution Concerning Lamp Replacement

- This projector utilizes a pressurized mercury lamp. A loud sound may indicate lamp failure. Lamp failure can be attributed to numerous sources such as: excessive shock, improper cooling, surface scratches or deterioration of the lamp due to a lapse of usage time.
The period of time up to failure largely varies depending on the individual lamp and/or the condition and the frequency of use. It is important to note that failure can often result in the bulb cracking.
- When the lamp replacement indicator and on-screen display icon are illuminated, it is recommended that the lamp be replaced with a new one immediately, even if the lamp appears to be operating normally.
- Should the lamp break, there is also a possibility that glass particles may spread inside of the projector. In such a case, it is recommended you contact your nearest Sharp Authorized Projector Dealer or Service Center to assure safe operation.
- Should the lamp break, the glass particles may spread inside the lamp cage or gas contained in the lamp may be vented into the room from the exhaust vent. Because the gas in this lamp includes mercury, ventilate the room well if the lamp breaks and avoid all exposure to the released gas. In case of exposure to the gas, consult a doctor as soon as possible.

Caution

- Do not remove the lamp unit from the projector right after use. The lamp will be very hot and may cause burns or injury.
- Wait at least one hour after the power cord is disconnected to allow the surface of the lamp unit to fully cool before removing the lamp unit.
- Do not touch the glass surface of the lamp unit or the inside of the projector.
- Do not loosen other screws except for the lamp unit cover and lamp unit.
- Make sure to reset the lamp timer only when replacing the lamp. If you reset the lamp timer and continue to use the same lamp, this may cause the lamp to become damaged or explode.

■ Carefully change the lamp by following the instructions described on pages 66 to 68.

* If you wish, you may have the lamp replaced at your nearest Sharp Authorized Projector Dealer or Service Center.

* If the new lamp does not light after replacement, take your projector to the nearest Sharp Authorized Projector Dealer or Service Center for repair.



How to Read this Operation Manual

- The specifications are slightly different, depending on the model. However, you can connect and operate all models in the same manner.
- In this operation manual, the illustration and the screen display are simplified for explanation, and may differ slightly from the actual display.

Using the Menu Screen

Adjustment buttons (▲/▼/◀/▶)

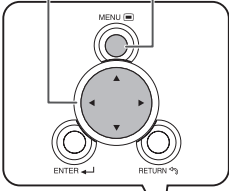
MENU button

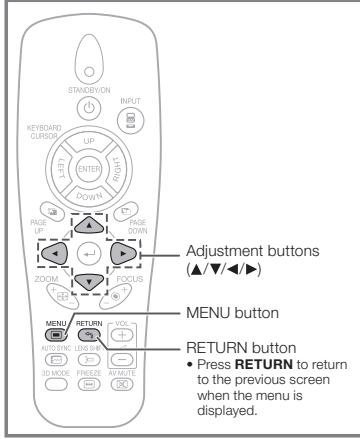

Adjustment buttons (▲/▼/◀/▶)

MENU button

RETURN button

- Press RETURN to return to the previous screen when the menu is displayed.

Menu Selections (Adjustments)

Example: Adjusting "Bright".

- This operation can also be performed by using the buttons on the projector.

- 1** Press **MENU**.
 - The menu screen is displayed.
- 2** Press **▶** or **◀** and select "Picture" to adjust.

Example: "Picture" screen menu for COMPUTER (RGB) input

Menu item		
Picture	SIG-ADJ	Video SCR-ADJ PRJ-ADJ
Picture Mode		Presentation
Bright Boost		2
Bright		0
Contrast		0
Color		0
Tint		0
Sharp		0
Ex. Setting		◀▶
Reset		◀▶
MENU = END		SEL/ADJ. ◀▶ SEL. ▲▼

Buttons used in this operation

Button used in this step

On-screen display

Useful Features

41

InfoIndicates safeguards for using the projector.

NoteIndicates additional information for setting up and operating the projector.

For Future Reference

Maintenance
➔ **P. 61**

Troubleshooting
➔ **PP. 73 to 75**

Index
➔ **P. 79**



Contents

Preparing

Introduction

How to Read this Operation Manual	3
Contents	4
IMPORTANT SAFEGUARDS	6
How to Access the PDF Operation Manuals.....	10
Accessories	11
Part Names and Functions.....	13
Top View	13
Front View	13
Side View (Terminals)	14
Inserting the Batteries.....	16
Usable Range.....	16

Easy Start

Easy Start	17
Setup and Projection	17

Setup

Setting Up the Projector.....	19
Video Setup.....	19
Setting Up the Projector	19
Standard Setup (Front Projection)	19
Projection (PRJ) Mode.....	20
Ceiling-Mount Setup.....	20

Connections

Connecting the Projector to Other Equipment.....	21
Controlling the Projector by a Computer	24
Attaching the Optional Lens.....	26
Connecting the Power Cord.....	27

Using

Basic Operation

Turning the Projector On/Off	28
Turning the Projector On.....	28
Turning the Power Off (Putting the Projector into Standby Mode)	28
Image Projection	29
Shifting the Lens.....	29
Using the Adjustment Feet.....	30
Adjusting the Focus.....	31
Adjusting the Projected Image Size.....	31
Correcting Trapezoidal Distortion	32

Switching the Input Mode.....	33
Adjusting the Volume	33
Displaying the Black Screen and Turning Off the Sound Temporarily	33
Resize Mode	34

Useful Features

Operating with the Remote Control.....	36
Auto Sync (Auto Sync Adjustment)	36
Freezing a Moving Image.....	36
Using the Remote Control to Operate the Computer	37
Menu Items.....	38
Using the Menu Screen	41
Menu Selections (Adjustments)	41
Picture Adjustment (“Picture” Menu)	43
Selecting the Picture Mode.....	43
Adjusting the Image.....	44
Using the Ex. Setting	44
Signal Type Setting	44
Adjusting the Color Temperature.....	44
Adjusting the Red/Blue	44
Adjusting the Colors	45
Selecting the Film Mode	45
Reducing Image Noise (DNR)	45
Setting the Dynamic Black.....	45
Signal Adjustment (“SIG-ADJ” Menu) ..	46
Adjusting the Computer Image	46
Setting the Resolution	46
Auto Sync (Auto Sync Adjustment)	46
Video Adjustment (“Video” Menu)	47
Setting the Overscan	47
Setting the Video System	47
Setting the Video Setup.....	48
Closed Caption	48
Adjusting the Projected Image (“SCR - ADJ” Menu).....	49
Selecting the On-screen Display Language ...	49
Selecting the Background Image	49
Reversing/Inverting Projected Images	49
Setting the Resize Mode.....	49
Keystone Correction.....	50
Image Resizing	50
Selecting the Wall Color.....	50
Using the Ex. Setting	50
Security Lock Function	51
Keypad Lock Function.....	51
Image Capture.....	51

Adjusting the Projector Function (“PRJ - ADJ” Menu)	52
Detecting the Input Signals Automatically ..	52
Auto Power Off Function	52
Auto Restart Function.....	52
Eco+Quiet	52
Setting the Lamp Mode.....	53
Setting the Audio.....	53
Using the Ex. Setting	53
Fan Mode Setting	53
STANDBY Mode.....	53
STANDBY Audio Out.....	53
Filter Message	54
3D MODE.....	54
Setting the LAN/RS232C.....	54
Setting the Network.....	54
Returning to the Default Settings	55
Information	55
Viewing Stereoscopic 3D Images.....	56
Precautions on Viewing Stereoscopic	
3D Images.....	56
Information on the 3D Projection Function ..	58
Using 3D Viewing Mode	59
Appendix.....	60

Reference

Appendix

Maintenance.....	61
Cleaning and Replacing the	
Dust Filters	62
Cleaning the Dust Filters	62
Replacing the Dust Filters	62
Maintenance Indicators	64
Regarding the Lamp.....	66
Lamp.....	66
Caution Concerning the Lamp.....	66
Replacing the Lamp	66
Removing and Installing the	
Lamp Unit.....	67
Resetting the Lamp Timer	68
Replacing the Color Wheel.....	69
Compatibility Chart	71
Troubleshooting.....	73
For SHARP Assistance.....	76
Specifications	77
Dimensions.....	78
Index.....	79

IMPORTANT SAFEGUARDS

CAUTION: Please read all of these instructions before you operate this product and save these instructions for later use.

Electrical energy can perform many useful functions. This product has been engineered and manufactured to assure your personal safety. BUT IMPROPER USE CAN RESULT IN POTENTIAL ELECTRICAL SHOCK OR FIRE HAZARDS. In order not to defeat the safeguards incorporated in this product, observe the following basic rules for its installation, use and servicing.

1. Read Instructions

All the safety and operating instructions should be read before the product is operated.

2. Retain Instructions

The safety and operating instructions should be retained for future reference.

3. Heed Warnings

All warnings on the product and in the operating instructions should be adhered to.

4. Follow Instructions

All operating and use instructions should be followed.

5. Cleaning

Unplug this product from the wall outlet before cleaning. Do not use liquid cleaners or aerosol cleaners. Use a damp cloth for cleaning.

6. Attachments

Do not use attachments not recommended by the product manufacturer as they may cause hazards.

7. Water and Moisture

Do not use this product near water—for example, near a bath tub, wash bowl, kitchen sink, or laundry tub; in a wet basement; or near a swimming pool; and the like.

8. Accessories

Do not place this product on an unstable cart, stand, tripod, bracket, or table. The product may fall, causing serious injury to a child or adult, and serious damage to the product. Use only with a cart, stand, tripod, bracket, or table recommended by the manufacturer, or sold with the product. Any mounting of the product should follow the manufacturer's instructions, and should use a mounting accessory recommended by the manufacturer.

9. Transportation

A product and cart combination should be moved with care. Quick stops, excessive force, and uneven surfaces may cause the product and cart combination to overturn.



10. Ventilation

Slots and openings in the cabinet are provided for ventilation to ensure reliable operation of the product and to protect it from overheating, and these openings must not be blocked or covered. The openings should never be blocked by placing the product on a bed, sofa, rug, or other similar surface. This product should not be placed in a built-in installation such as a bookcase or rack unless proper ventilation is provided or the manufacturer's instructions have been adhered to.

11. Power Sources

This product should be operated only from the type of power source indicated on the marking label. If you are not sure of the type of power supply to your home, consult your product dealer or local power company. For products intended to operate from battery power, or other sources, refer to the operating instructions.

12. Grounding or Polarization

This product is provided with one of the following types of plugs. If the plug should fail to fit into the power outlet, please contact your electrician.

Do not defeat the safety purpose of the plug.

- Two-wire type (mains) plug.
- Three-wire grounding type (mains) plug with a grounding terminal.

This plug will only fit into a grounding type power outlet.

13. Power-Cord Protection

Power-supply cords should be routed so that they are not likely to be walked on or pinched by items placed upon or against them, paying particular attention to cords at plugs, convenience receptacles, and the point where they exit from the product.

14. Lightning

For added protection for this product during a lightning storm, or when it is left unattended and unused for long periods of time, unplug it from the wall outlet and disconnect the cable system. This will prevent damage to the product due to lightning and power-line surges.

15. Overloading

Do not overload wall outlets, extension cords, or integral convenience receptacles as this can result in a risk of fire or electric shock.

16. Object and Liquid Entry

Never push objects of any kind into this product through openings as they may touch dangerous voltage points or short-out parts that could result in a fire or electric shock. Never spill liquid of any kind on the product.

17. Servicing

Do not attempt to service this product yourself as opening or removing covers may expose you to dangerous voltage or other hazards. Refer all servicing to qualified service personnel.

18. Damage Requiring Service

Unplug this product from the wall outlet and refer servicing to qualified service personnel under the following conditions:

- When the power-supply cord or plug is damaged.
- If liquid has been spilled, or objects have fallen into the product.
- If the product has been exposed to rain or water.
- If the product does not operate normally by following the operating instructions. Adjust only those controls that are covered by the operating instructions, as an improper adjustment of other controls may result in damage and will often require extensive work by a qualified technician to restore the product to normal operation.
- If the product has been dropped or damaged in any way.
- When the product exhibits a distinct change in performance, this indicates a need for service.

19. Replacement Parts

When replacement parts are required, be sure the service technician has used replacement parts specified by the manufacturer or have the same characteristics as the original part. Unauthorized substitutions may result in fire, electric shock, or other hazards.

20. Safety Check

Upon completion of any service or repairs to this product, ask the service technician to perform safety checks to determine that the product is in proper operating condition.

21. Wall or Ceiling Mounting

This product should be mounted to a wall or ceiling only as recommended by the manufacturer.

22. Heat

This product should be situated away from heat sources such as radiators, heat registers, stoves, or other products (including amplifiers) that produce heat.

- DLP® and the DLP logo are registered trademarks of Texas Instruments and DLP® Link™ is a trademark of Texas Instruments.
- Microsoft® and Windows® are registered trademarks of Microsoft Corporation in the United States and/or other countries.
- PC/AT is a registered trademark of International Business Machines Corporation in the United States.
- Adobe® Reader® is a trademark of Adobe Systems Incorporated.
- Macintosh® is a registered trademark of Apple Computer, Inc. in the United States and/or other countries.
- PJLink is a registered trademark or an application trademark in Japan, the United States, Canada, E.U., China and/or other countries/regions.
- All other company or product names are trademarks or registered trademarks of their respective companies.
- Some IC chips in this product include confidential and/or trade secret property belonging to Texas Instruments. Therefore you may not copy, modify, adapt, translate, distribute, reverse engineer, reverse assemble or discompile the contents thereof.

Observe the following safeguards when setting up your projector.

Caution concerning the lamp unit

- Potential hazard of glass particles if lamp ruptures. In case of lamp rupture, contact your nearest Sharp Authorized Projector Dealer or Service Center for replacement. See “Regarding the Lamp” on page 66.



Caution concerning the setup of the projector

- For minimal servicing and to maintain high image quality, SHARP recommends that this projector be installed in an area free from humidity, dust and cigarette smoke. When the projector is subjected to these environments, the vents and lens must be cleaned more often. As long as the projector is regularly cleaned, use in these environments will not reduce the overall operation life of the unit. Internal cleaning should only be performed by a Sharp Authorized Projector Dealer or Service Center.

Rest your eyes occasionally.

- Continuously watching the screen for long hours will cause eye strain. Take regular breaks to rest your eyes.

Do not set up the projector in places exposed to direct sunlight or bright light.

- Position the screen so that it is not in direct sunlight or room light. Light falling directly on the screen washes out the colors, making viewing difficult. Close the curtains and dim the lights when setting up the screen in a sunny or bright room.

Caution regarding placing of the projector

- Place the projector on a level site within the adjustment range (10 degrees) of the adjustment foot.

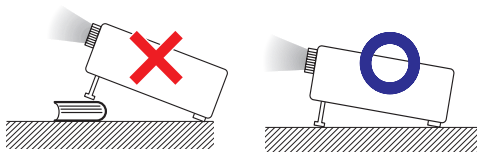

- After the projector is purchased, a faint smell from the vent may appear when the power is first turned on. This is normal and is not a malfunction. It will disappear after the projector is used for a while.

When using the projector in high-altitude areas such as mountains (at altitudes of approximately 1,200 meters (4,000 feet) or more)

- When you use the projector in high-altitude areas with thin air, set “Fan Mode” to “High”. Neglecting this can affect the longevity of the optical system.
- Use the projector at altitudes of 3,000 meters (10,000 feet) or less.

Warning about placing the projector in a high position

- When placing the projector in a high position, make certain it is carefully secure to avoid personal injury caused by the projector falling down.

Do not subject the projector to hard impact and/or vibration.

- Protect the lens so as not to hit or damage the surface of the lens.

Avoid locations with extremes of temperature.

- The operating temperature of the projector is from 41°F to 104°F (+5°C to +40°C).
- The storage temperature of the projector is from 14°F to 140°F (-10°C to +60°C).

Do not block the exhaust and intake vents.

- Allow at least 11 ¹³/₁₆ inches (30 cm) of space between the exhaust vent and the nearest wall or obstruction.
- Ensure that the intake vent and the exhaust vent are not obstructed.
- If the cooling fan becomes obstructed, a protection circuit will automatically put the projector into Standby mode to prevent overheat damage. This does not indicate a malfunction. (See pages 64 and 65.) Remove the projector power cord from the wall outlet and wait at least 10 minutes. Place the projector where the intake and exhaust vents are not blocked, plug the power cord back in and turn on the projector. This will return the projector to the normal operating condition.

Caution regarding usage of the projector

- If you are not to use the projector for a long time or before moving the projector, make certain you unplug the power cord from the wall outlet, and disconnect any other cables connected to it.
- Do not carry the projector by holding the lens.
- When storing the projector, ensure you attach the lens cap or dustproof cap to the projector.
- Do not expose the projector to direct sunlight or place next to heat sources. Doing so may affect the cabinet color or cause deformation of the plastic cover.

Other connected equipment

- When connecting a computer or other audio-visual equipment to the projector, make the connections AFTER unplugging the power cord of the projector from the AC outlet and turning off the equipment to be connected.
- Please read the operation manuals of the projector and the equipment to be connected for instructions on how to make the connections.

Using the projector in other countries

- The power supply voltage and the shape of the plug may vary depending on the region or country you are using the projector in. When using the projector overseas, make sure you use an appropriate power cord for the country you are in.

Temperature monitor function

- If the temperature inside the projector increases, due to blockage of the air vents, or the setting location, the lamp will turn off, the cooling fan will run and then the projector will enter Standby mode, and then the TEMP. (temperature warning)/STATUS indicator will blink. Refer to “Maintenance Indicators” on pages 64 and 65 for details.

Info

- The cooling fan regulates the internal temperature, and its performance is automatically controlled. The sound of the fan may change during projector operation due to changes in the fan speed. This does not indicate malfunction.

Optional lens installation

- For installing an optional lens, refer to “Attaching the Optional Lens” on page 26 or the lens installation manual (supplied with the optional lens).
- Remove the optional lens when carrying the projector. Carrying the projector with an optional lens attached can cause the projector to be damaged by vibration or other factors.
- When carrying the projector with no lens attached, attach the dustproof cap to the projector.

Closed Caption uses Bitstream Vera fonts

Copyright (c) 2003 by Bitstream, Inc. All Rights Reserved. Bitstream Vera is a trademark of Bitstream, Inc. Permission is hereby granted, free of charge, to any person obtaining a copy of the fonts accompanying this license (“Fonts”) and associated documentation files (the “Font Software”), to reproduce and distribute the Font Software, including without limitation the rights to use, copy, merge, publish, distribute, and/or sell copies of the Font Software, and to permit persons to whom the Font Software is furnished to do so, subject to the following conditions:

The above copyright and trademark notices and this permission notice shall be included in all copies of one or more of the Font Software typefaces.

The Font Software may be modified, altered, or added to, and in particular the designs of glyphs or characters in the Fonts may be modified and additional glyphs or characters may be added to the Fonts, only if the fonts are renamed to names not containing either the words “Bitstream” or the word “Vera”.

This License becomes null and void to the extent applicable to Fonts or Font Software that has been modified and is distributed under the “Bitstream Vera” names.

The Font Software may be sold as part of a larger software package but no copy of one or more of the Font Software typefaces may be sold by itself.

THE FONT SOFTWARE IS PROVIDED “AS IS”, WITHOUT WARRANTY OF ANY KIND, EXPRESS OR IMPLIED, INCLUDING BUT NOT LIMITED TO ANY WARRANTIES OF MERCHANTABILITY, FITNESS FOR A PARTICULAR PURPOSE AND NONINFRINGEMENT OF COPYRIGHT, PATENT, TRADEMARK, OR OTHER RIGHT. IN NO EVENT SHALL BITSTREAM OR THE GNOME FOUNDATION BE LIABLE FOR ANY CLAIM, DAMAGES OR OTHER LIABILITY, INCLUDING ANY GENERAL, SPECIAL, INDIRECT, INCIDENTAL, OR CONSEQUENTIAL DAMAGES, WHETHER IN AN ACTION OF CONTRACT, TORT OR OTHERWISE, ARISING FROM, OUT OF THE USE OR INABILITY TO USE THE FONT SOFTWARE OR FROM OTHER DEALINGS IN THE FONT SOFTWARE.

Except as contained in this notice, the names of Gnome, the Gnome Foundation, and Bitstream Inc., shall not be used in advertising or otherwise to promote the sale, use or other dealings in this Font Software without prior written authorization from the Gnome Foundation or Bitstream Inc., respectively. For further information, contact: fonts at gnome dot org.



How to Access the PDF Operation Manuals

PDF operation manuals in several languages are included in the CD-ROM. To utilize these manuals, you need to install Adobe® Reader® on your computer (Windows® or Macintosh®).

Please download Adobe® Reader® from the Internet (<http://www.adobe.com>).

Accessing the PDF Manuals

For Windows®:

- ① Insert the CD-ROM in the CD-ROM drive.
- ② Double click the “My Computer” icon.
- ③ Double click the “CD-ROM” drive.
- ④ **When you want to view the operation manual**
 - 1) Double click the “MANUALS” folder.
 - 2) Double click the language (name of the folder) that you want to view.
 - 3) Double click the pdf file to access the projector manuals.

When you want to view the SETUP MANUAL

- 1) Double click the “SETUP” folder.
- 2) Double click the language (name of the folder) that you want to view.
- 3) Double click the pdf file to access the SETUP MANUAL.

For Macintosh®:

- ① Insert the CD-ROM in the CD-ROM drive.
- ② Double click the “CD-ROM” icon.
- ③ **When you want to view the operation manual**
 - 1) Double click the “MANUALS” folder.
 - 2) Double click the language (name of the folder) that you want to view.
 - 3) Double click the pdf file to access the projector manuals.

When you want to view the SETUP MANUAL

- 1) Double click the “SETUP” folder.
- 2) Double click the language (name of the folder) that you want to view.
- 3) Double click the pdf file to access the SETUP MANUAL.



Note

- If the desired pdf file cannot be opened by double clicking the mouse, start Adobe® Reader® first, then specify the desired file using the “File”, “Open” menu.

SETUP MANUAL

Refer to the “SETUP MANUAL” contained on the supplied CD-ROM for details.

Setting up the Screen.....	2
Screen Size and Projection Distance	3
Connecting Pin Assignments	14
RS-232C Specifications and Commands.....	16
Setting up the Projector Network Environment	18
Controlling the Projector via LAN	24
Operating the Projector Using the PJLink™ Protocol.....	27
Troubleshooting.....	28
Dimensions	31

Accessories

Supplied accessories

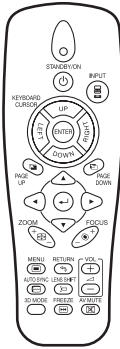

Remote control
<9NK5041821400>



Two R-6 batteries
("AAA" size, UM/SUM-4,
HP-7 or similar)

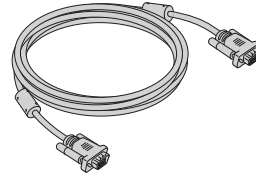

RGB cable
(6' (1.8 m))
<9NK3081405002>

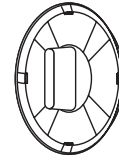

Dustproof cap
<9NK3392038200>



Anti-theft screw
<9NK3100132500>

Power cord*

(1)

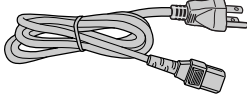

For U.S., Canada, etc.
(6' (1.8 m))
<9NK3090204900>

(2)

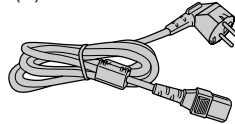

For Europe, except U.K.
(6' (1.8 m))
<9NK3090152701>

(3)

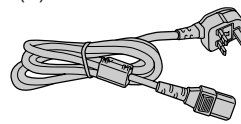

For U.K., Hong Kong
and Singapore
(6' (1.8 m))
<9NK3090152901>

(4)

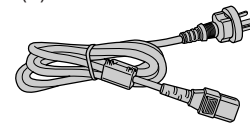

For Australia, New
Zealand and Oceania
(6' (1.8 m))
<9NK3090152601>

* Which power cords are supplied along with your projector depends on the region. Use the power cord that corresponds to the wall outlet in your country.

- Operation manuals (manual pack (including this manual and CD-ROM))
For U.S., Canada and Taiwan: <9NK3534150200>
For Europe, Asia, Australia and New Zealand: <9NK3534160900>
For Korea: <9NK3534161000>



Note

- Codes in "< >" are Replacement parts codes.
- When the lens is attached, use the lens cap supplied with the lens.
- You can attach the dustproof cap to the projector only when no lens is attached. (Do not attach the dustproof cap when the lens is attached.)

Optional accessories

- | | |
|--|----------------------------|
| ■ Lamp unit | AN-PH80LP |
| ■ Ceiling-mount unit | AN-XGCM80 (for U.S.A only) |
| ■ 3 RCA to mini D-sub 15 pin cable (10' (3.0 m)) | AN-C3CP2 |
| ■ Six-segment color wheel | AN-PH80CW |



Note

- Some of the optional accessories may not be available depending on the region. Please check with your nearest Sharp Authorized Projector Dealer or Service Center.

Accessories (Continued)

Optional accessories

Lens Type		Projection Distance for 100" Screen Size	
		XG-PH80W-N	XG-PH80X-N
Fixed wide lens (× 0.8)	AN-PH808EX	5'6" (1.7 m)	5'2" (1.6 m)
Wide-zoom lens (× 1.3 – 1.8)	AN-PH814EZ	9'5" (2.9 m) – 12'8" (3.9 m)	8'10" (2.7 m) – 11'11" (3.6 m)
Standard zoom lens (× 1.8 – 2.4)	AN-PH818EZ	12'7" (3.8 m) – 16'7" (5.1 m)	11'10" (3.6 m) – 15'8" (4.8 m)
Tele-zoom lens (× 2.2 – 4.4)	AN-PH823EZ	15'8" (4.8 m) – 31'4" (9.5 m)	14'10" (4.5 m) – 29'6" (9.0 m)
Tele-zoom lens (× 4.4 – 8.3)	AN-PH845EZ	31'4" (9.5 m) – 58'8" (17.9 m)	29'6" (9.0 m) – 55'4" (16.9 m)

No lens is attached to XG-PH80W-N/XG-PH80X-N. The optional lenses from Sharp are also available for specialized application. Please see your nearest Sharp Authorized Projector Dealer for details on all the lenses. (Refer to the lens operation manual when using a lens.)

Throw Distance

XG-PH80W-N

The graph below is for 100-inch (254 cm) screen with 16:10 normal mode.

Screen

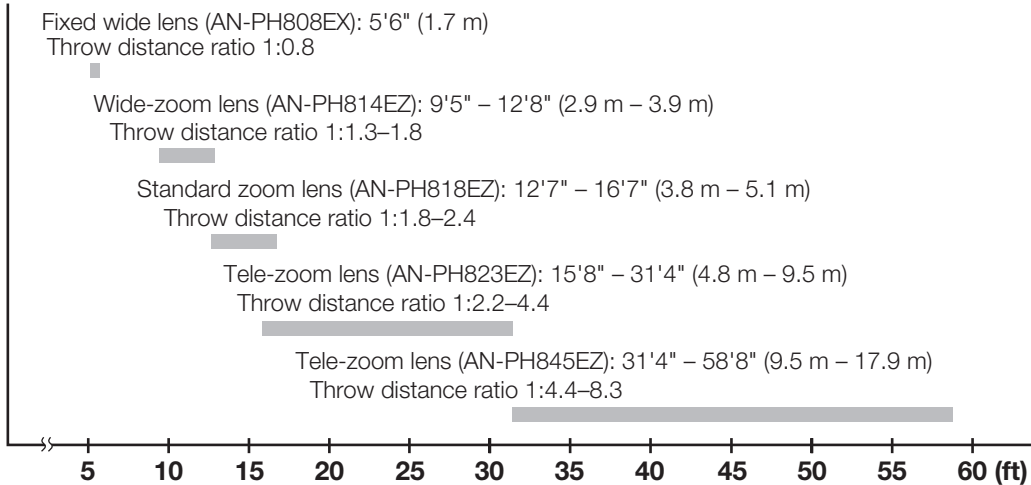

XG-PH80X-N

The graph below is for 100-inch (254 cm) screen with 4:3 normal mode.

Screen

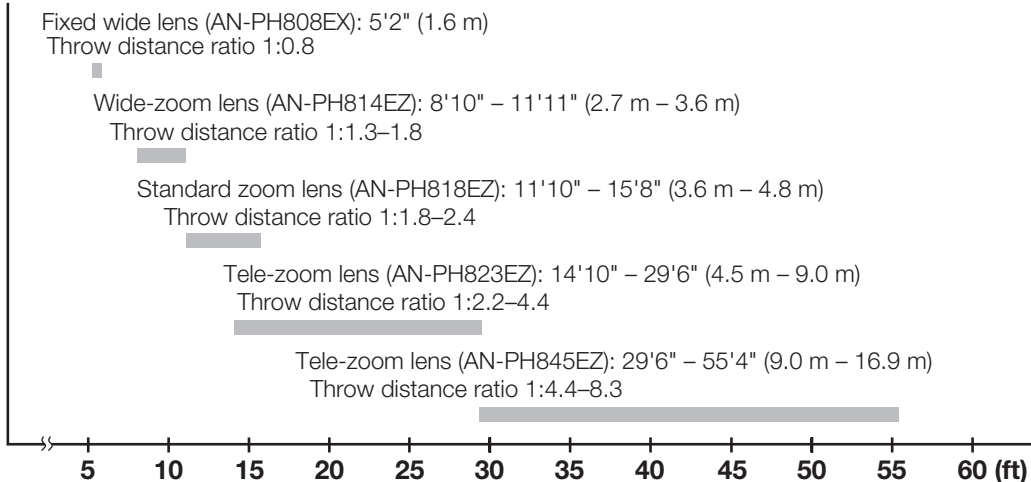

Part Names and Functions

Numbers in refer to the main pages in this operation manual where the topic is explained.

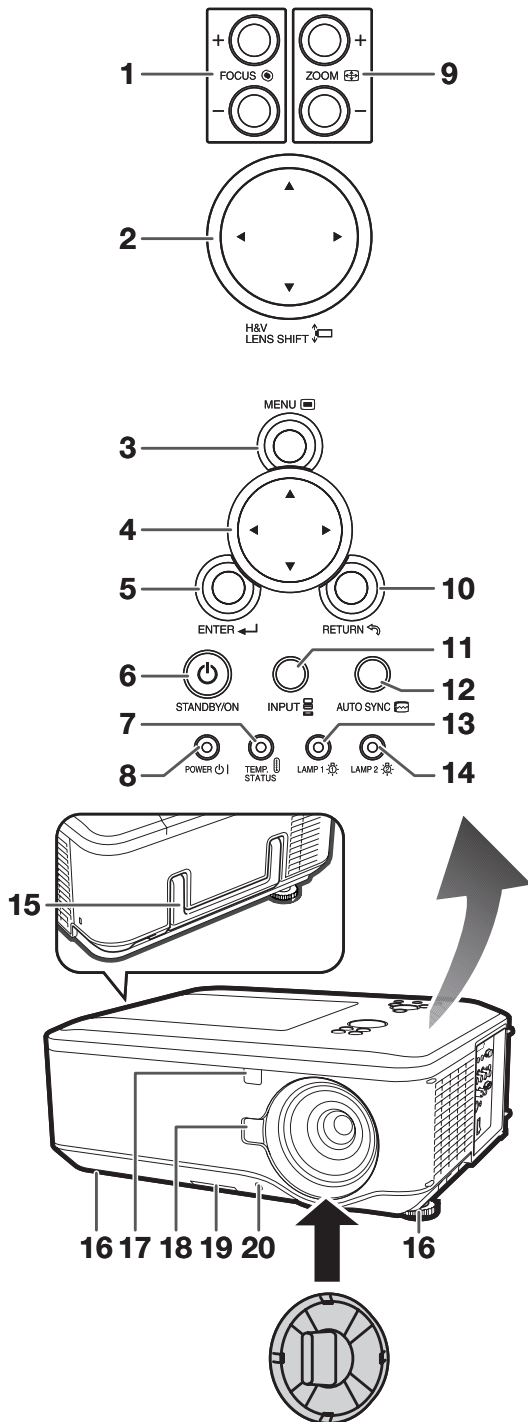

Attaching the lens cap/dustproof cap
Snap on the lens cap/dustproof cap straight.

Removing the lens cap/dustproof cap
Pull the lens cap/dustproof cap directly outward.

Top View

- 1** FOCUS buttons 31
For adjusting the focus.
- 2** H&V LENS SHIFT (▲/▼/◀/▶) buttons 30
For shifting the lens horizontally and vertically.
- 3** MENU button 41
For displaying adjustment and setting screens.
- 4** Adjustment buttons (▲/▼/◀/▶) 41
For selecting menu items.
- 5** ENTER button 33
For setting items selected or adjusted on the menu.
- 6** STANDBY/ON button 28
For turning the power on and putting the projector into Standby mode.
- 7** TEMP. (temperature warning)/STATUS indicator 64
- 8** POWER indicator 64
- 9** ZOOM buttons 31
For adjusting the projected image size.
- 10** RETURN button 41
For returning to the previous menu screen during menu operations.
- 11** INPUT button 33
For switching Input mode.
- 12** AUTO SYNC button 36
For automatically adjusting images when connected to a computer.
- 13** LAMP 1 indicator 64
- 14** LAMP 2 indicator 64

Front View

- 15** Carrying handle
For carrying the projector.
- 16** Adjustment foot 30
- 17** Remote control sensor 16
- 18** LENS RELEASE button 26
- 19** Dust filter 62
- 20** Anti-theft screw 27

Part Names and Functions (Continued)

Numbers in refer to the main pages in this operation manual where the topic is explained.

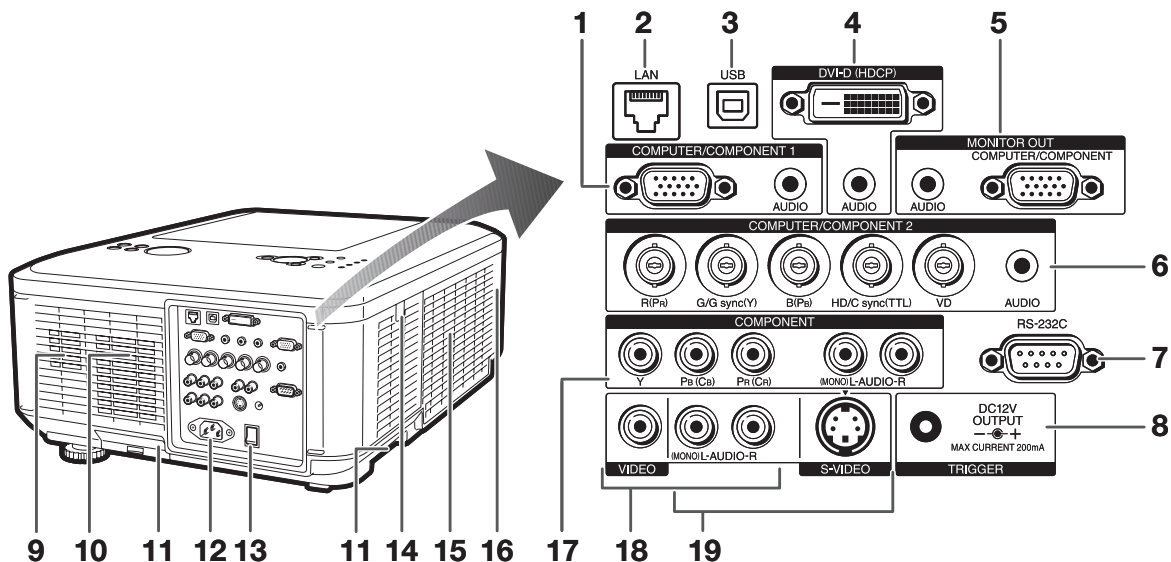

Side View (Terminals)

- | | |
|--|---|
| <p>1 COMPUTER/COMPONENT1 input terminals 21, 23
Terminal for computer RGB and component signals and audio input terminal.</p> <p>2 LAN terminal 25
Terminal for controlling the projector using a computer via network.</p> <p>3 USB terminal 37
Terminal connecting with the USB terminal on the computer for using the supplied remote control as the computer key board.</p> <p>4 DVI-D input terminals 21, 22
Terminals for DVI digital RGB and digital component signals and audio input terminal.</p> <p>5 MONITOR OUT terminals 23
 <ul style="list-style-type: none"> • COMPUTER/COMPONENT output terminal for computer RGB and component signals. (Shared for COMPUTER/COMPONENT1 and 2, COMPONENT input) • AUDIO output terminal. (Shared for all inputs) </p> <p>6 COMPUTER/COMPONENT2 input terminals 21, 22
BNC terminals for computer RGB and component signals and audio input terminal.</p> <p>7 RS-232C terminal 24
Terminal for controlling the projector using a computer.</p> <p>8 TRIGGER terminal
When the projector is turned on, a control signal (DC 12V) outputs from this terminal. If an electric screen or other compatible device is connected, it can be turned on when the projector is turned on.</p> | <p>9 Speaker 53</p> <p>10 Intake vent 62</p> <p>11 Dust filter 62</p> <p>12 AC socket 27
Connect the supplied power cord.</p> <p>13 MAIN POWER switch 26
Turn the projector On or Off.</p> <p>14 Remote control sensor 16</p> <p>15 Exhaust vent 62</p> <p>16 Kensington Security Standard connector</p> <p>17 COMPONENT input terminals 22
Terminals for component signals and audio input terminal.</p> <p>18 VIDEO input terminals 23
Terminal for connecting video equipment and audio input terminal.</p> <p>19 S-VIDEO input terminals 23
Terminal for connecting video equipment with an S-video terminal and audio input terminal.</p> |
|--|---|

Using the Kensington Lock

- This projector has a Kensington Security Standard connector for use with a Kensington MicroSaver Security System. Refer to the information that came with the system for instructions on how to use it to secure the projector.

Numbers in refer to the main pages in this operation manual where the topic is explained.

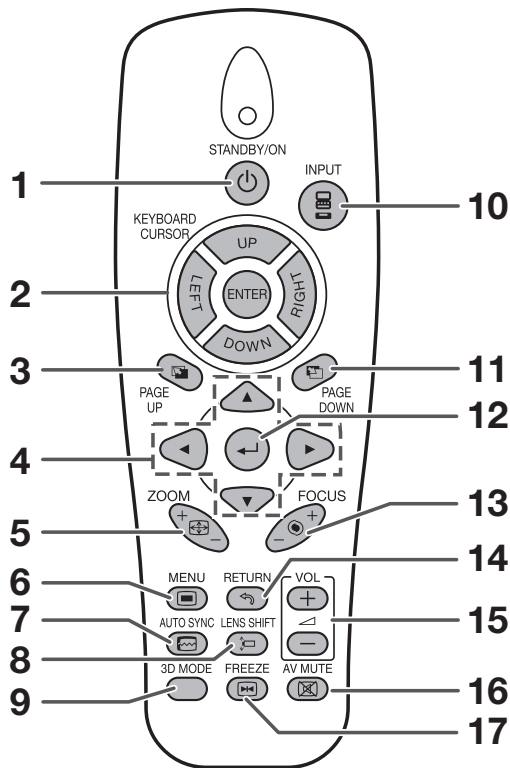

- 1 STANDBY/ON button 28**
For turning the power on and putting the projector into Standby mode.
- 2 KEYBOARD CURSOR (UP/DOWN/LEFT/RIGHT/ENTER) buttons 37**
 - For moving the computer cursor when with the USB connection (using a USB cable).
 - Same as the [Enter] key on a computer keyboard, when with the USB connection (using a USB cable).
- 3 PAGE UP button 37**
Same as the [Page Up] key on a computer keyboard, when with the USB connection (using a USB cable).
- 4 Adjustment buttons (▲/▼/◀/▶) 30, 41**
For selecting and adjusting menu items.
- 5 ZOOM buttons 31**
For adjusting the projected image size.
- 6 MENU button 41**
For displaying adjustment and setting screens.
- 7 AUTO SYNC button 36**
For automatically adjusting images when connected to a computer.
- 8 LENS SHIFT button 30**
For displaying the lens shift adjustment screen.
- 9 3D MODE button 59**
For displaying the 3D MODE menu screen.
- 10 INPUT button 33**
For switching Input mode.
- 11 PAGE DOWN button 37**
Same as the [Page Down] key on a computer keyboard, when with the USB connection (using a USB cable).
- 12 ← (ENTER) button 33**
For setting items selected or adjusted on the menu.
- 13 FOCUS buttons 31**
For adjusting the focus.
- 14 RETURN button 41**
For returning to the previous menu screen during menu operations.
- 15 VOL +/- (Volume) buttons 33**
For adjusting the speaker sound level.
- 16 AV MUTE button 33**
For temporarily displaying a black screen and turning off the sound.
- 17 FREEZE button 36**
For freezing images.

Part Names and Functions (Continued)

Inserting the Batteries

1 Remove the cover by sliding towards the direction of the arrow.

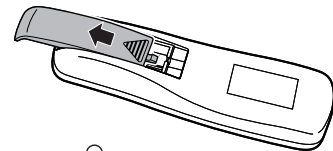

2 Insert the batteries.

- Insert the batteries making sure the polarities correctly match the ⊕ and ⊖ marks inside the battery compartment.

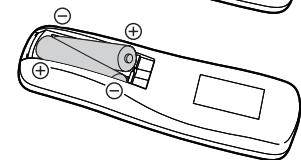

3 Replace the cover.

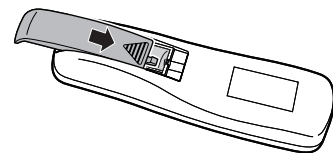

Incorrect use of the batteries may cause them to leak or explode. Please follow the precautions below



Caution

- Danger of explosion if battery is incorrectly replaced. Replace only with alkaline or manganese batteries.
- Insert the batteries making sure the polarities correctly match the ⊕ and ⊖ marks inside the battery compartment.
- Batteries of different types have different properties, therefore do not mix batteries of different types.
- Do not mix new and old batteries.
This may shorten the life of new batteries or may cause old batteries to leak.
- Remove the batteries from the remote control once they have run out, as leaving them in can cause them to leak. Battery fluid from leaked batteries is harmful to skin, therefore ensure you wipe them first and then remove them using a cloth.
- The batteries included with this projector may run down in a short period, depending on how they are kept. Be sure to replace them as soon as possible with new batteries.
- Remove the batteries from the remote control if you will not be using the remote control for a long time.
- Comply with the rules (ordinance) of each local government when disposing of worn-out batteries.

Usable Range

The remote control can be used to control the projector within the ranges shown in the illustration.



Note

- **Another remote control sensor is located on the rear of the projector. (See page 14.)**
- The signal from the remote control can be reflected off a screen for easy operation. However, the effective distance of the signal may differ depending on the screen material.

When using the remote control

- Ensure that you do not drop it or expose it to moisture or high temperature.
- The remote control may malfunction under a fluorescent lamp. In this case, move the projector away from the fluorescent lamp.

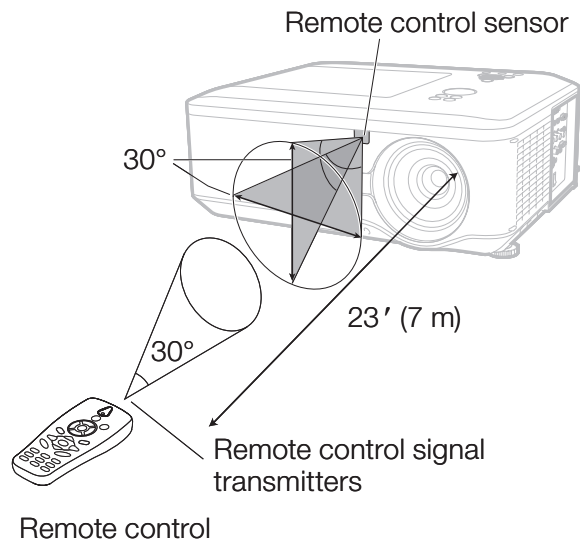

Easy Start

This section shows the basic operation (projector connecting with the computer). For details, see the page described below for each step.

Setup and Projection

In this section, connection of the projector and the computer is explained using one example.

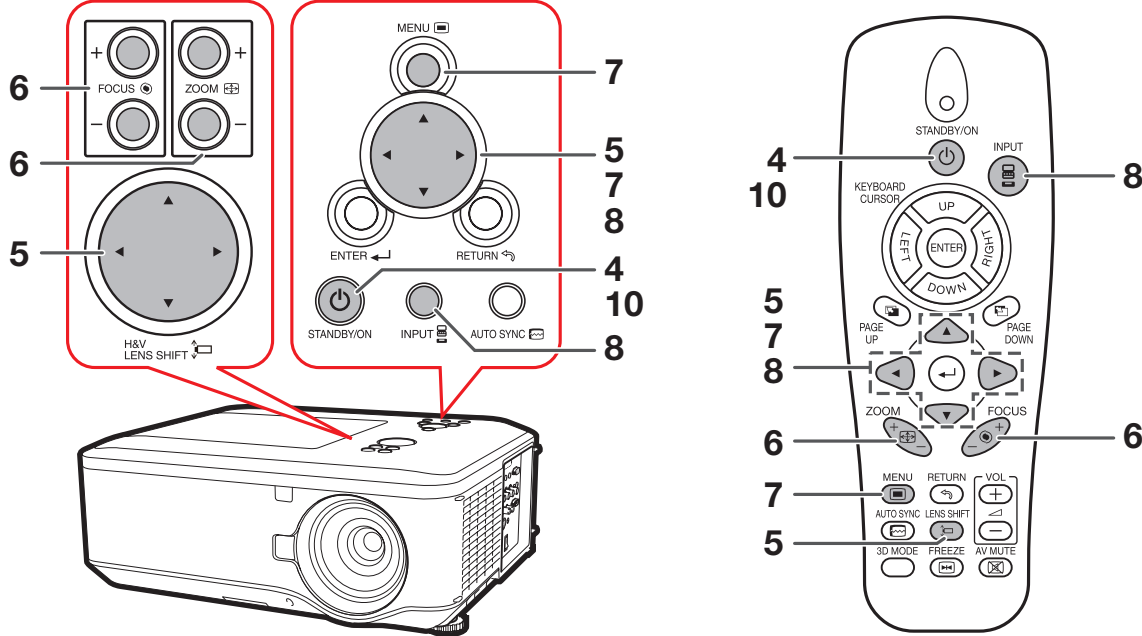

1. Remove the dustproof cap and then attach the optional lens → P. 26

2. Place the projector facing a wall or a screen → P. 19

3. Connect the projector to the computer and plug the power cord into the AC socket of the projector

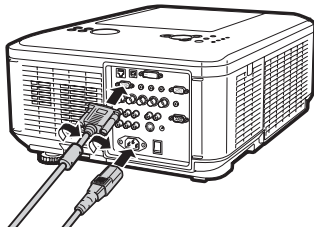

When connecting equipment other than a computer, see pages **22** and **23**.

→ PP. 21, 25

4. Turn the projector on

Switch the MAIN POWER switch on the projector to "ON" and, after the POWER indicator has turned red, press **STANDBY/ON** on the projector or on the remote control.

On the projector



STANDBY/ON

On the remote control



STANDBY/ON

→ P. 28

Easy Start (Continued)

5. Adjust the angle

Adjust the projector angle:

- Shift the lens horizontally and vertically.
 - Press **H&V LENS SHIFT** (▲/▼/◀/▶) on the projector.
 - Press **LENS SHIFT** and then press ▲, ▼, ◀ or ▶ on the remote control.
- Adjust the projector angle by rotating the adjustment feet.

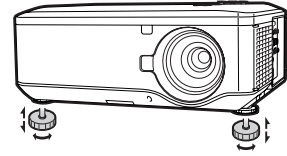

➔ P. 30

6. Adjust the focus and the zoom

- 1 Press **FOCUS +/-** on the projector or on the remote control to adjust the focus.
- 2 Press **ZOOM +/-** on the projector or on the remote control to adjust the zoom.

➔ P. 31

7. Correcting the image distortion due to the projection angle

- 1 Press **MENU** to display the menu screen.
- 2 Press ◀ or ▶ to select “SCR-ADJ”.
- 3 Press ▲ or ▼ to select “Keystone”.
- 4 Press ◀ or ▶ to adjust the Keystone Correction.

➔ P. 32

8. Select the Input mode

Press **INPUT** to display the INPUT list. Use ▲/▼ to select the Input mode.

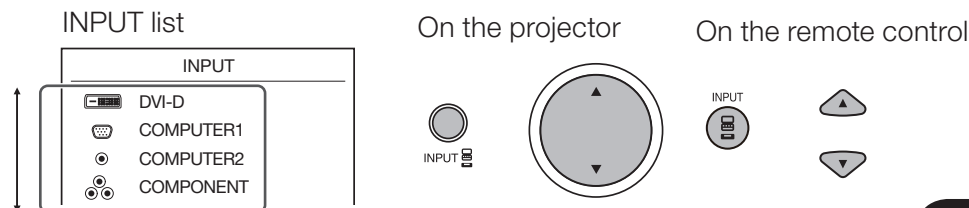

➔ P. 33

9. Turn the computer on

10. Turn the power off

Press **STANDBY/ON** on the projector or on the remote control, and then press the button again while the confirmation message is displayed to put the projector into Standby mode.

On the projector



On the remote control



On-screen display

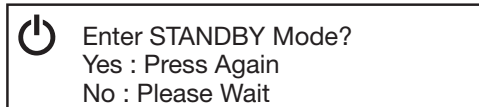

- You can unplug the power cord or switch the MAIN POWER switch to “OFF” even if the projector is operating.
- Even if you unplug the power cord or switch the MAIN POWER switch to “OFF”, the cooling fan continues to run for a while.

➔ P. 28

Setting Up the Projector

Video Setup

If using this projector outside the U.S.A., please change setting to "0 IRE" in Video Setup. (See page 48.)

Setting Up the Projector

For optimal image quality, position the projector perpendicular to the screen with the projector's feet flat and level. Doing so will eliminate the need for Keystone correction and provide the best image quality. (See page 32.)

Standard Setup (Front Projection)

- Place the projector at the required distance from the screen according to the desired picture size. (For details, refer to "SETUP MANUAL" contained on the supplied CD-ROM.)

Indication of the Projection Image Size and Projection Distance

XG-PH80W-N

(Example: 16:10 Signal Input (Normal Mode) for the standard zoom lens (AN-PH818EZ))

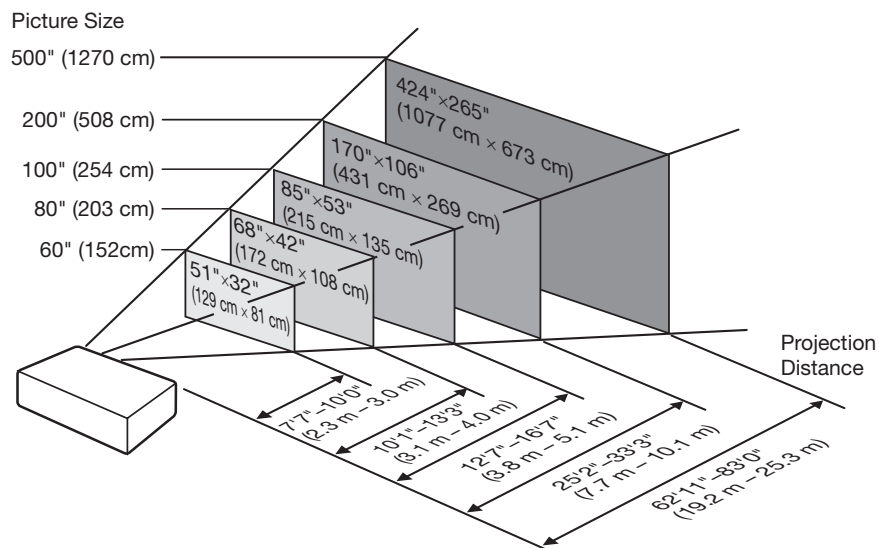

XG-PH80X-N

(Example: 4:3 Signal Input (Normal Mode) for the standard zoom lens (AN-PH818EZ))

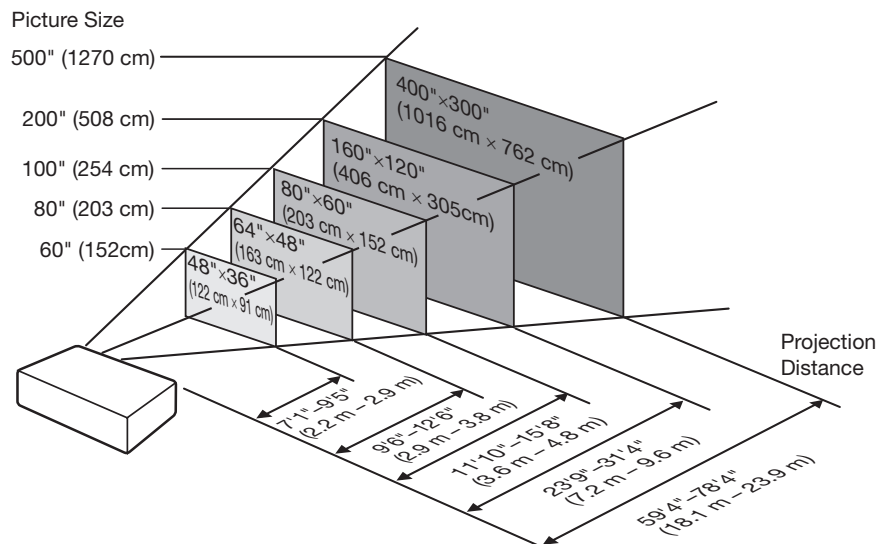

Setting Up the Projector (Continued)

Projection (PRJ) Mode

The projector can use any of the 4 projection modes shown in the diagram below. Select the mode most appropriate for the projection setting in use. (You can set the PRJ mode in “SCR-ADJ” menu. See page 49.)

- Table mounted, front projection
[Menu item → “Front”]

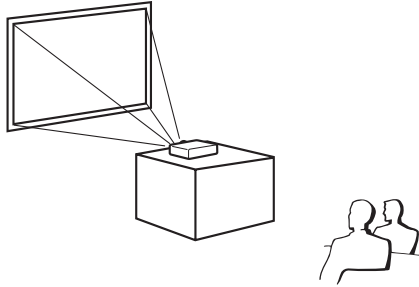

- Ceiling mounted, front projection
[Menu item → “Ceiling + Front”]

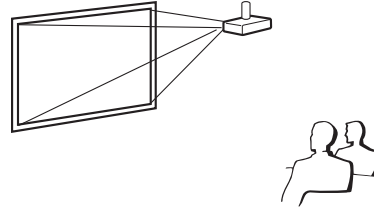

- Table mounted, rear projection
(with a translucent screen)
[Menu item → “Rear”]

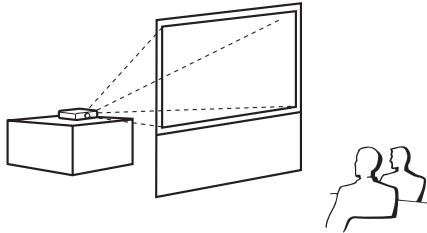

- Ceiling mounted, rear projection
(with a translucent screen)
[Menu item → “Ceiling + Rear”]

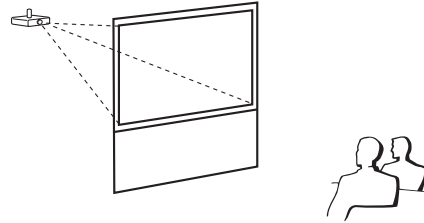

■ Ceiling-Mount Setup

Before mounting the projector, contact your nearest Sharp Authorized Projector Dealer or Service Center to obtain the recommended ceiling-mount adaptor and unit (sold separately).

Connecting the Projector to Other Equipment

Before connecting, ensure that the power cord of the projector is unplugged from the AC outlet and turn off the equipment to be connected. After making all connections, turn on the projector and then the other pieces of equipment. When connecting a computer, ensure that it is the last equipment to be turned on after all the connections are made.

IMPORTANT: Ensure that the appropriate input mode has been selected on the projector before you turn on the connected equipment.

- For more details of connection and cables, refer to the operation manual of the connected equipment.
- You may need other cables or connectors not listed below.

Terminals on the Projector

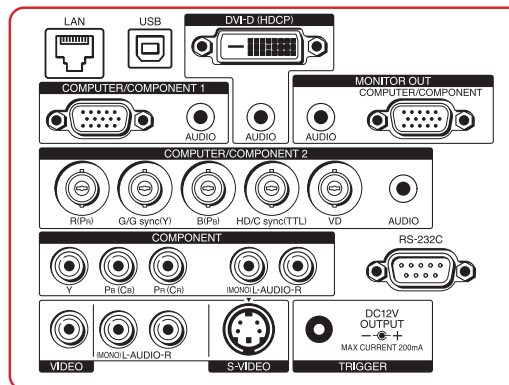









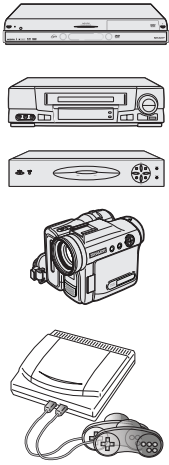

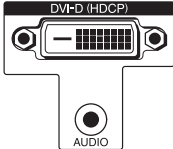

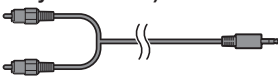

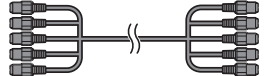

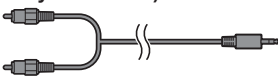
Equipment	Terminal on connected equipment	Cable	Terminal on the projector
	RGB output terminal 	RGB cable (supplied) 	COMPUTER/COMPONENT1
	Computer audio output terminal 	Computer audio cable (ø3.5 mm stereo minijack, commercially available) 	
	RGB output terminal 	Mini D-sub 15 pin/5 BNC cable (commercially available) 	COMPUTER/COMPONENT2
	Computer audio output terminal 	Computer audio cable (ø3.5 mm stereo minijack, commercially available) 	
	DVI digital output terminal 	DVI Digital cable (commercially available) 	DVI-D
	Computer audio output terminal 	Computer audio cable (ø3.5 mm stereo minijack, commercially available) 	

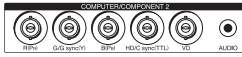
Note

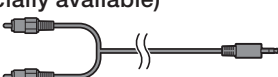

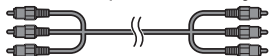

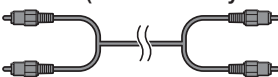





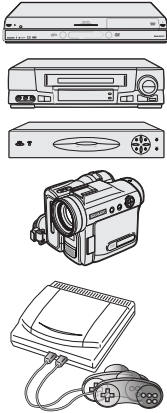

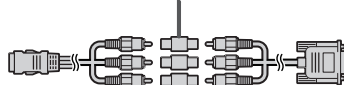

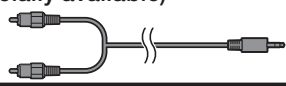

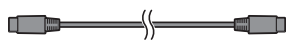

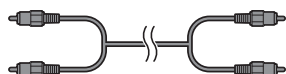

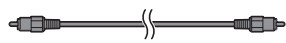
- When using the ø3.5 mm mono audio cable, the volume level will be half of when using the ø3.5 mm stereo audio cable.
- When connecting the projector to a compatible computer other than a PC (VGA/SVGA/XGA/SXGA/UXGA) or Macintosh (i.e. Workstation), a separate cable may be needed. Please contact your dealer for more information.
- See page 71 “Compatibility Chart” for a list of computer signals compatible with the projector. Use with computer signals other than those listed may cause some of the functions to not work.
- A Macintosh adaptor may be required for use with some Macintosh computers. Contact your nearest Macintosh Dealer.
- **Depending on the computer you are using, an image may not be projected unless the computer’s external output port is switched on (e.g. Press “Fn” and “F5” keys simultaneously when using a SHARP notebook computer).** Refer to the specific instructions in your computer’s operation manual to enable your computer’s external output port.

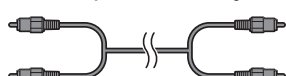
Connecting the Projector to Other Equipment (Continued)

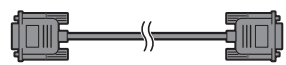
Equipment	Terminal on connected equipment	Cable	Terminal on the projector
Video equipment, Camera, Video game 	DVI digital output terminal 	DVI Digital cable (commercially available) 	DVI-D 
	Audio output terminal 	ø3.5 mm stereo minijack to RCA audio cable (commercially available) 	
	RGB video output terminal 	5 BNC cable (commercially available) 	COMPUTER/ COMPONENT2 
	Audio output terminal 	ø3.5 mm stereo minijack to RCA audio cable (commercially available) 	
	Component video output terminal 	Component cable (commercially available) + BNC-RCA adaptor plug (commercially available) 	COMPUTER/ COMPONENT2 
	Audio output terminal 	ø3.5 mm stereo minijack to RCA audio cable (commercially available) 	
Component video output terminal 	Component cable (commercially available) 	COMPONENT 	
Audio output terminal 	RCA audio cable (commercially available) 		

Note

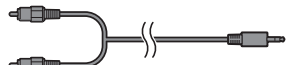
- When using the ø3.5 mm mono audio cable, the volume level will be half of when using the ø3.5 mm stereo audio cable.
- Select the input signal type of the video equipment when connecting to the COMPUTER/ COMPONENT1, 2 or DVI-D terminal. See page 44.
- The HD/C sync and VD terminals may be used depending on the specifications of the DTV decoder connected to this projector. Please refer to the operation manual of the DTV decoder for details.
- The HD/C sync terminal of the 5 BNC terminal is only for TTL signal.
- Depending on specifications of video equipment or the DVI⇔HDMI digital cable, the signal transmission may not work properly. (The HDMI specification does not support all connections to video equipment that has HDMI digital output terminal using a DVI⇔HDMI digital cable.)
- For details on compatibility for connection, see support information on DVI connection provided by the video equipment manufacturer.
- When you connect video equipment with a 21-pin RGB output (Euro-scart) to the projector, use a commercially available cable that fits in the projector terminal you want to connect.
- The projector does not support RGBC signals via the Euro-scart.

Equipment	Terminal on connected equipment	Cable	Terminal on the projector
Video equipment, Camera, Video game 	D-video output terminal 	Cables for a camera or a video game/3 RCA to mini D-sub 15 pin cable (optional, AN-C3CP2) RCA adaptor plug (commercially available) 	COMPUTER/ COMPONENT1 
	Audio output terminal 	ø3.5 mm stereo minijack to RCA audio cable (commercially available) 	S-VIDEO 
	S-video output terminal 	S-video cable (commercially available) 	
	Audio output terminal 	RCA audio cable (commercially available) 	VIDEO 
	Video output terminal 	Video cable (commercially available) 	
Audio output terminal 	RCA audio cable (commercially available) 		
Monitor 	RGB input terminal 	RGB cable (supplied or commercially available) 	MONITOR OUT 
Amplifier 	Audio input terminal 	ø3.5 mm stereo minijack to RCA audio cable (commercially available) 	MONITOR OUT 

 **Note**

- When using the ø3.5 mm mono audio cable, the volume level will be half of when using the ø3.5 mm stereo audio cable.
- The audio signal is not output from the speaker of the projector when the audio cable is connected to the audio output terminal.
- Video signal for monitor output is analog RGB signal as well as component signal (COMPUTER/COMPONENT1, 2). DVI input video signals would not be output.

Controlling the Projector by a Computer

When the RS-232C terminal on the projector is connected to the RS-232C serial terminal on the computer, or when the LAN terminal on the projector is connected to the LAN terminal on the computer, the computer can be used to control the projector. Refer to the “SETUP MANUAL” contained on the supplied CD-ROM for details.

When connecting to a computer using an RS-232C serial control cable

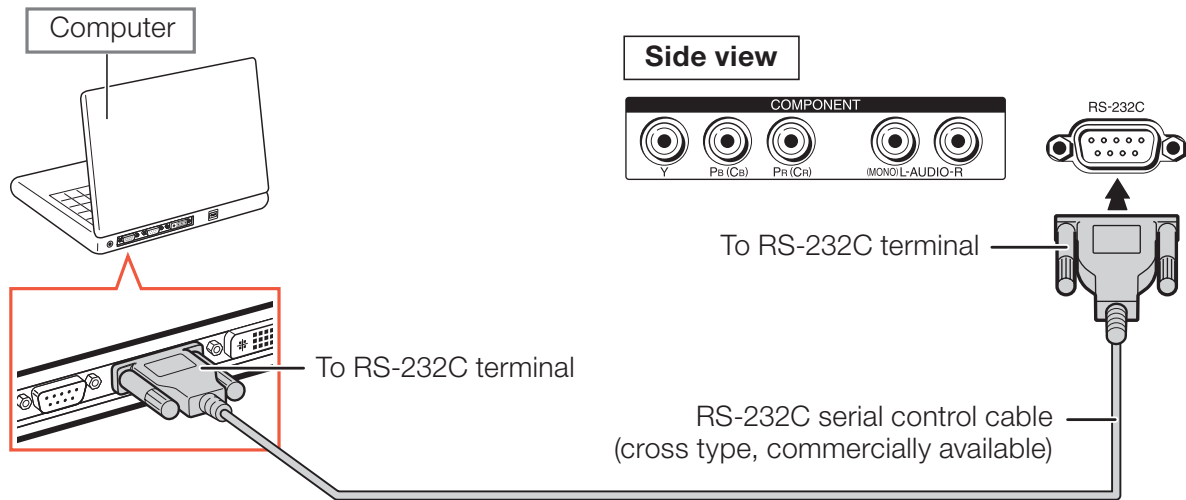

Note

- When you establish the connection shown above, set “LAN/RS232C” in “Ex. Setting” of the “PRJ-ADJ” menu to “RS232C”.
- The RS-232C function may not operate if your computer terminal is not correctly set up. Refer to the operation manual of the computer for details.
- **Refer to “SETUP MANUAL” contained on the supplied CD-ROM for the RS-232C specifications and commands.**

Info

- Do not connect the RS-232C cable to a terminal other than the RS-232C terminal on the computer. This may damage your computer or projector.
- Do not connect or disconnect an RS-232C serial control cable to or from the computer while it is on. This may damage your computer.

When connecting to the LAN terminal using a LAN cable

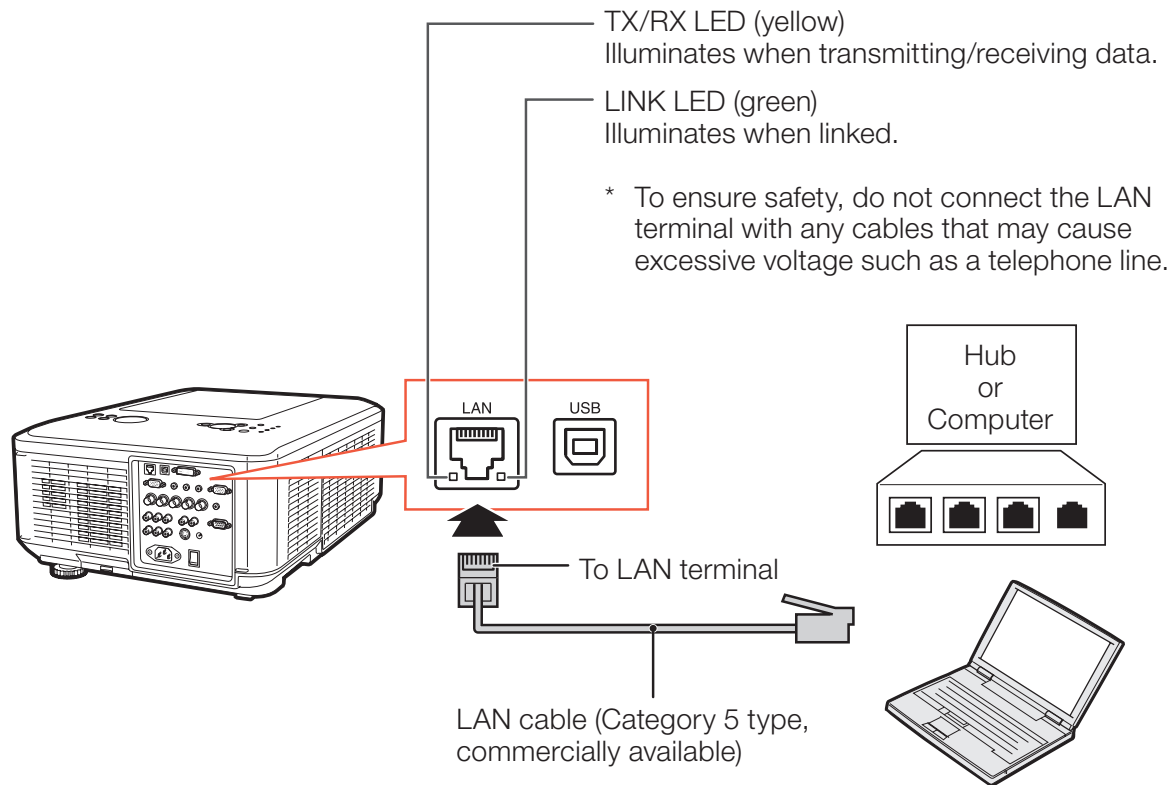

Note

- When you establish the connection shown above, set “LAN/RS232C” in “Ex. Setting” of the “PRJ-ADJ” menu to “LAN”.
- When connecting to a hub, use a straight-through Category 5 (CAT.5) type cable (commercially available).
- When connecting to a computer, use a cross-over Category 5 (CAT.5) type cable (commercially available).

Attaching the Optional Lens

When you attach a lens for the first time, skip steps 1 to 3. (When you replace the lens, start from step 1.)

Do not attempt to exchange the lens when the projector is installed hanging from the ceiling. Injury may occur if the lens falls.

1 Press **STANDBY/ON** on the projector or on the remote control to put the projector into standby mode.

- Switch the MAIN POWER switch on the projector to "OFF".
- Disconnect the power cord and unplug the power cord from the AC socket after the cooling fan stops.

2 Push the **LENS RELEASE** button all the way in and turn the lens anti-clockwise.

- The lens will be disengaged.

Note

- If the anti-theft screw is used to secure the lens, the lens cannot be removed when the **LENS RELEASE** button is pressed. In this case, remove the anti-theft screw first.

3 Pull the lens out slowly.

4 Remove the lens cap from a replacement lens.

- Start with this step when you set a lens for the first time.

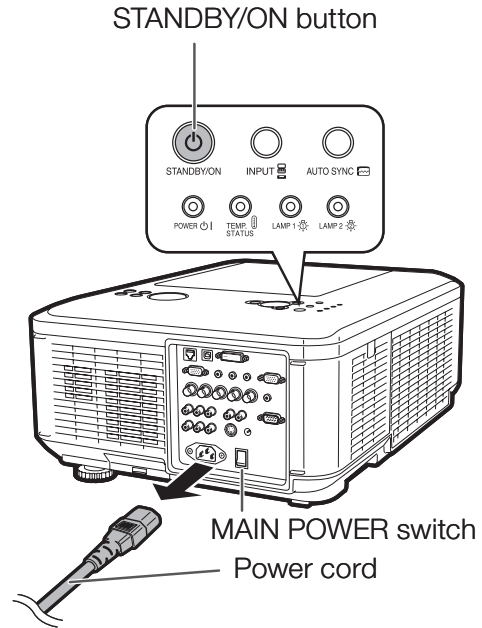

LENS RELEASE button

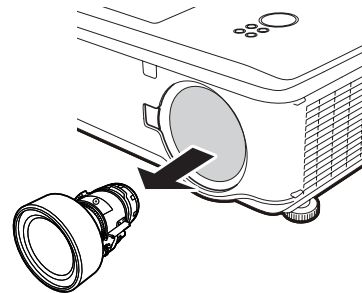
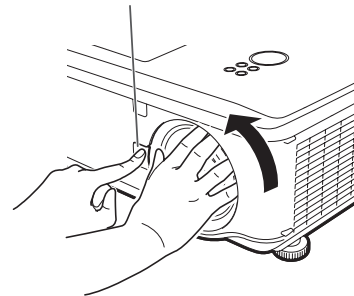

Info

- If you try to attach the lens to the projector without removing this cap, the optional lens attachment part can be damaged.

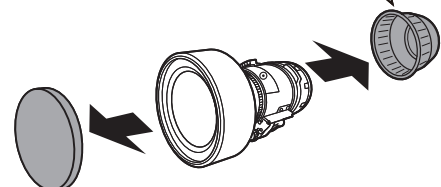

5 Insert the replacement lens with the top position mark on it facing up, and then turn the lens clockwise until you hear a click sound.

- Make sure that the lens cannot be released even when you try to turn the lens anti-clockwise and pull it out.

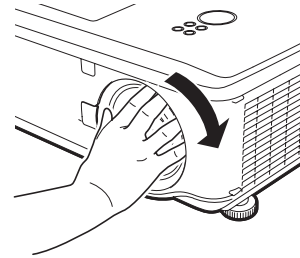
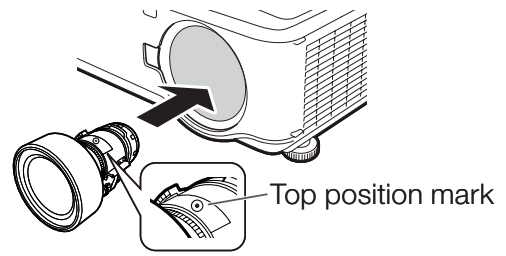

Using the Anti-Theft Screw

- The lens is secured by the above method, but for added security, an anti-theft screw is supplied to secure the lens more tightly.
- The screw is designed to be rather long, and to secure the screw, give it about 40-50 turns.

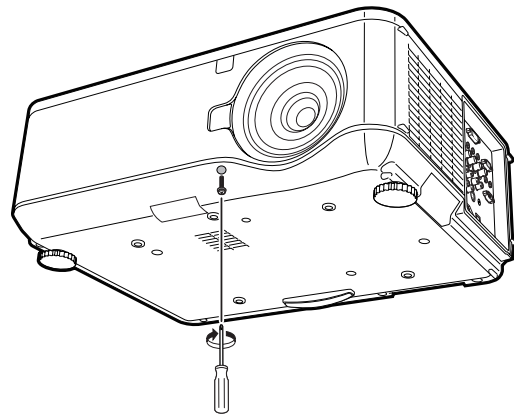

Connecting the Power Cord

Plug the supplied power cord into the AC socket on the side of the projector. Then plug into AC outlet.

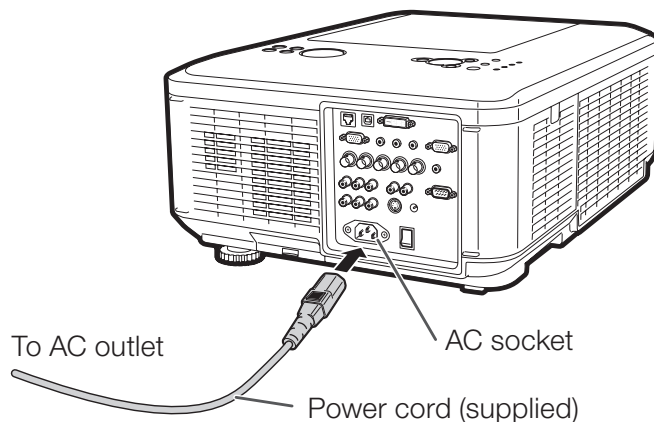

Turning the Projector On/Off

Turning the Projector On

Note that the connections to external equipment and power outlet should be done before performing the operations written below. (See pages 21 to 25.)

Remove the lens cap. Then switch the MAIN POWER switch on the projector to “ON” and, after the POWER indicator has turned red, press STANDBY/ON on the projector or on the remote control.

- The POWER indicator illuminates green.
- After the LAMP indicator illuminates, the projector is ready to start operation.

Note

• About the LAMP Indicator

The LAMP indicator illuminates to indicate the status of the lamp. (See page 64 for details.)

Green or orange: The lamp is on.

Blinking in green or orange: The lamp is warming up.

Red: The lamp is shut down abnormally or the lamp should be replaced.

- When you switch on the projector, a slight flickering of the image may be experienced within the first minute after the lamp has been illuminated. This is normal operation as the lamp's control circuitry is stabilizing the lamp output characteristics. It should not be regarded as faulty operation.
- If the projector is put into Standby mode and immediately turned on again, the lamp may take some time to start projection.
- When Security Lock is set, the password input box appears. To cancel the password setting, input the password that you have already set. See page 51 for details.

Turning the Power Off (Putting the Projector into Standby Mode)

Press STANDBY/ON on the projector or on the remote control, then press that button again while the confirmation message is displayed, to put the projector into Standby mode.

- The projector cannot be turned on while cooling.

Info

- **When “Auto Restart” is set to “On”:**
If the power cord is unplugged from the outlet or the breaker switch is turned off when the projector is on, then the projector automatically turns on when the power cord is plugged into the AC outlet or the breaker switch is turned on. (See page 52.)
- English is the factory default language. If you want to change the on-screen display to another language, change the language according to the procedure on page 49.

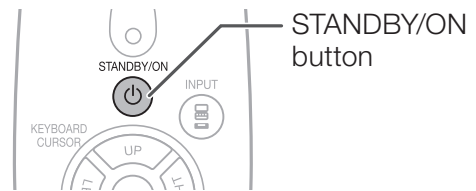
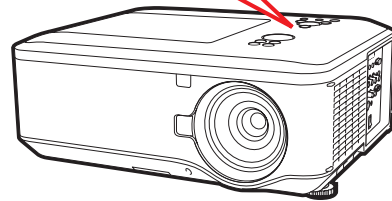
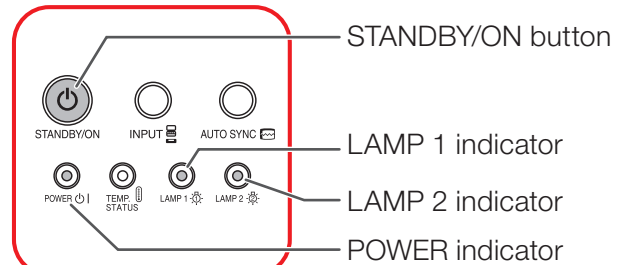

On-screen display (confirmation message)

 Enter STANDBY Mode?
Yes : Press Again
No : Please Wait

Info

Direct Power Off function:

- You can unplug the power cord or switch the MAIN POWER switch to “OFF” even if the cooling fan is still running.
- If you turn the power back on in the cases shown below, the lamp will take a longer time to light up than usual:
 - When the power cord is unplugged during operation
 - When the MAIN POWER switch is turned “OFF” during operation

Image Projection

Shifting the Lens

In addition to the zoom function and adjustment of projection angle using the adjustment feet, you can adjust the position of the projection using the lens shift function. This is a useful function in cases such as when the screen cannot be moved.

When moving upward or downward

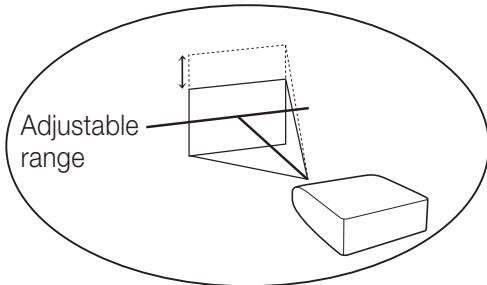

When moving in the left and right direction

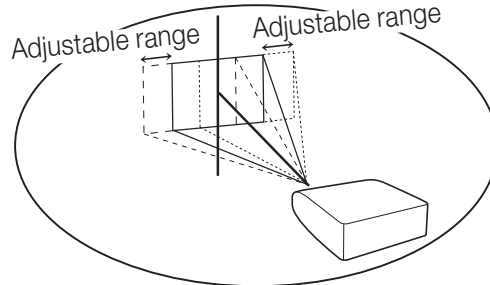

Adjustable range

- The adjustable range is shown below.
Horizontal range: $\pm 10\%$
Vertical range: $+50\%$ (AN-PH814EZ, AN-PH818EZ, AN-PH823EZ, AN-PH845EZ)/ 0% (AN-PH808EX)
The adjustable range has limitations even within the range shown above.
- The image can be adjusted as shown on the diagram.

AN-PH814EZ, AN-PH818EZ, AN-PH823EZ, AN-PH845EZ

Position of the image when the image is centered, both vertically and horizontally, in lens shift

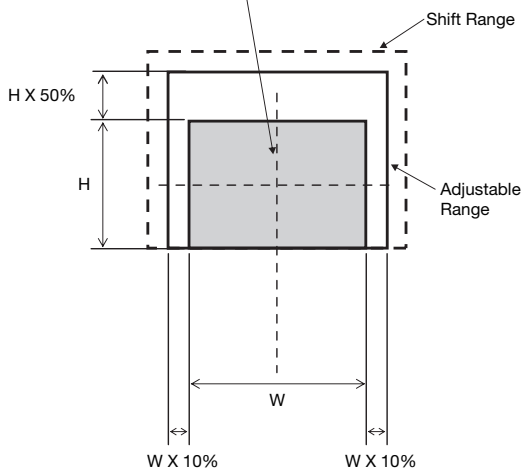

H : Height of the image
W : Width of the image

AN-PH808EX

Position of the image when the image is placed at the bottom vertically and is centered horizontally in lens shift

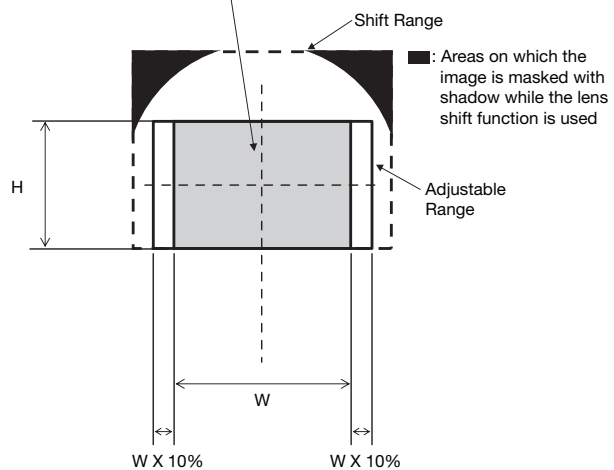

H : Height of the image
W : Width of the image

Image Projection (Continued)

1 Press **H&V LENS SHIFT** (▲/▼/◀/▶) on the projector, or press **LENS SHIFT** and ▲/▼/◀/▶ on the remote control, to adjust the image position.

▼On-screen display

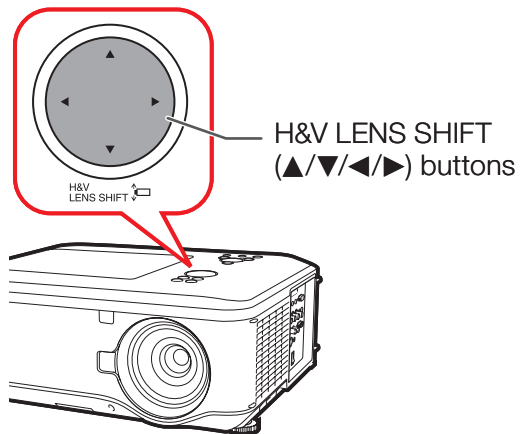
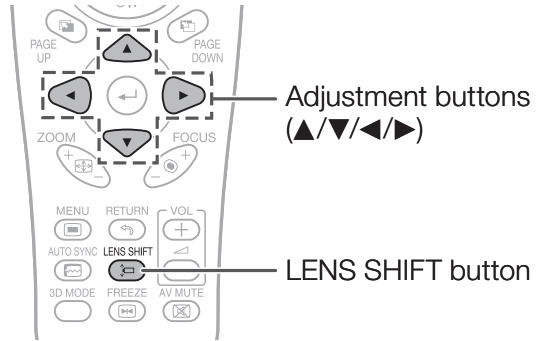
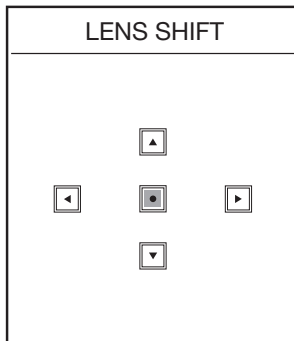

Using the Adjustment Feet

- When the position of the projected image cannot be adjusted with the lens shift function, use the adjustment feet to adjust the projected angle.
- The height of the projector can be adjusted using the adjustment feet when the screen is located higher than the projector, the screen is inclined or when the installation site is slightly inclined.
- Install the projector so that it is as perpendicular to the screen as possible.

1 Rotate the adjustment feet to adjust the projected angle.

- The projector is adjustable up to approximately 10 degrees.

⚠ Warning!

- Do not hold the lens when projector angle is adjusted.
- Use caution not to pinch your finger in the space between the adjustment foot and the projector when the projector angle is lowered.

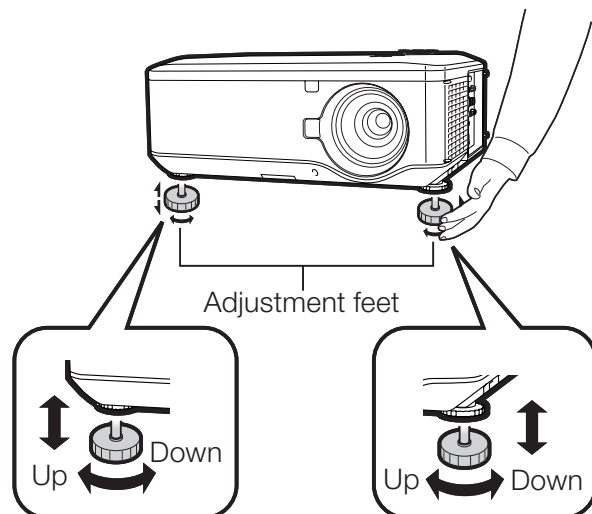

Adjusting the Focus

Press **FOCUS +/-** on the projector or on the remote control to adjust the focus.

Info

- It is recommended that the focus be adjusted after the projector has warmed up for at least 30 minutes.

Adjusting the Projected Image Size

Press **ZOOM +/-** on the projector or on the remote control to adjust the projected image size.

Note

- For fine adjustments, when **H&V LENS SHIFT**, **FOCUS** or **ZOOM** is pressed, the projected image moves a small amount in the desired direction for approximately one second. Hold down the buttons to move the projected image quickly.

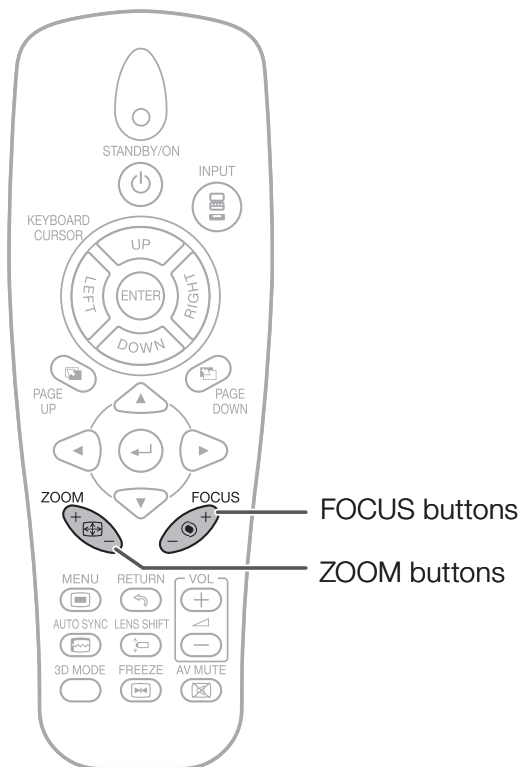
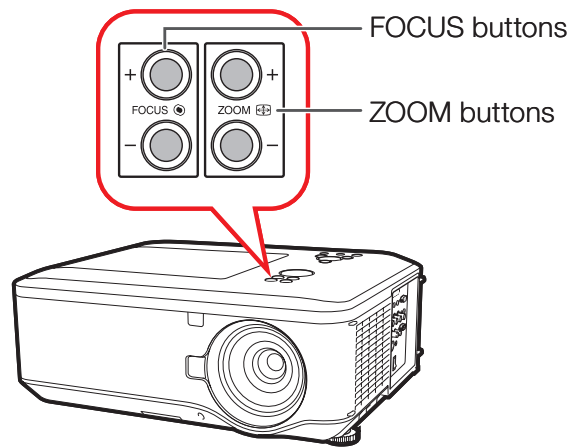
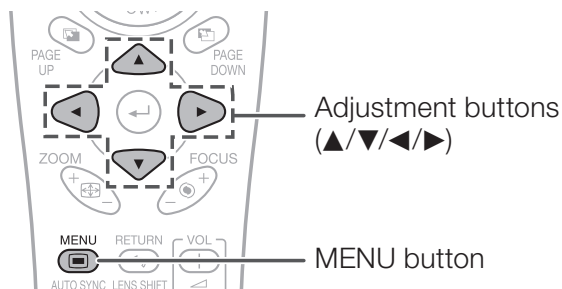

Image Projection (Continued)

Correcting Trapezoidal Distortion

When the image is projected either from the top or from the bottom towards the screen at an angle, the image becomes distorted trapezoidally. The function for correcting trapezoidal distortion is called Keystone Correction.



Note

- The Keystone Correction can be adjusted up to an angle of approximately ± 30 degrees and the screen can also be set up to an angle of approximately ± 30 degrees.

1 Press **MENU** to display the menu screen, and then press **◀** or **▶** to select “SCR-ADJ”.

2 Press **▲** or **▼** to select “Keystone”.

3 Press **◀** or **▶** to adjust the Keystone Correction.

4 Press **▼** to select “Image Resizing”.

- Only when “Keystone” is set to the values other than “0”, “Image Resizing” works.

5 Press **◀** or **▶** to correct the image distortion.

6 Press **MENU**.

- The menu screen will disappear.

Info

- While adjusting the image using Keystone Correction, straight lines and the edges of the image may appear jagged.

On-screen display
(Keystone Correction mode)

Keystone 0

Shrinks upper side.
(Move the slide bar in the + direction.)

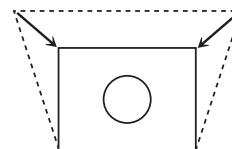

Shrinks lower side.
(Move the slide bar in the - direction.)

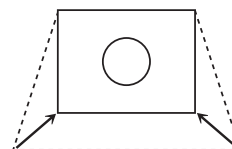

On-screen display
(Image Resizing mode)

Image Resizing 0

Shrinks the image vertically.
(Move the slide bar in the + direction.)

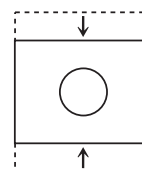

Enlarges the image vertically.
(Move the slide bar in the - direction.)

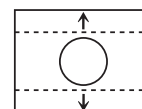

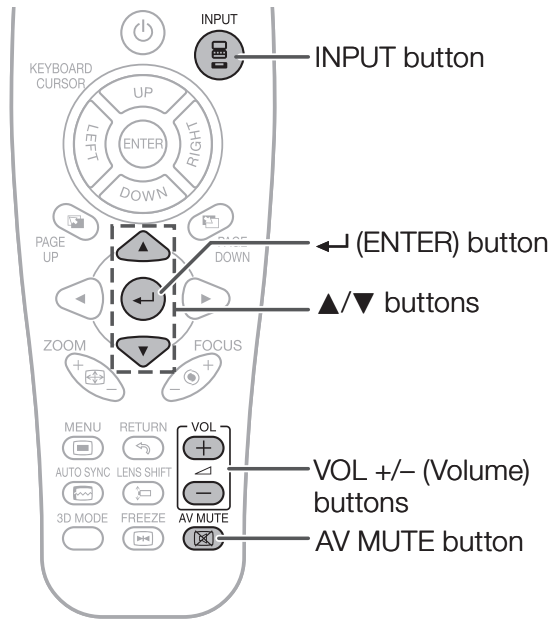

Adjusting the Volume

Press **VOL +/-** on the remote control to adjust the volume.

On-screen display

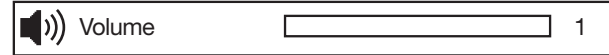

Note

- Pressing **VOL-** will lower the volume.
- Pressing **VOL+** will raise the volume.
- When the projector is connected to external equipment, the volume level of the external equipment changes in accordance with the volume level of the projector. Set the projector's volume to the lowest level when turning the projector on/off or when changing the input signal.
- When you do not want to output the sound from the projector's speaker while the projector is connected to external equipment, set "Speaker" in "Audio" of the "PRJ-ADJ" menu to "Off". (See page 53.)
- The audio signal is not output from the internal speaker when connecting the audio cable to the MONITOR OUT (AUDIO) terminal.

Switching the Input Mode

Select the appropriate Input mode for the connected equipment.

Press **INPUT** on the projector or on the remote control to display the **INPUT** list.

INPUT list

INPUT	
	DVI-D
	COMPUTER1
	COMPUTER2
	COMPONENT
	S-VIDEO
	VIDEO

- While the INPUT list is displayed, follow the procedure below to switch the input mode.
 - Press **▲/▼** to select the desired input mode and then press **↵ (ENTER)**.
 - If **↵ (ENTER)** is not pressed, the projector switches to the selected input mode in a few seconds.

Note

- When no signal or non-supported signal is received, "NO SIGNAL" will be displayed.

Displaying the Black Screen and Turning Off the Sound Temporarily

Press **AV MUTE** on the remote control to temporarily display a black screen and turn off the sound.

On-screen display



Note

- Pressing **AV MUTE** again will turn the projected image back on.

Image Projection (Continued)

Resize Mode

This function allows you to modify or customize the Resize mode to enhance the input image. You can set the Resize mode in “SCR-ADJ” menu. See page 49.

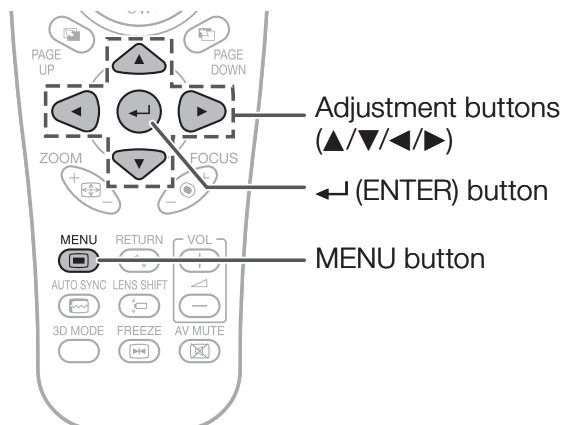

1 Press **MENU** to display the menu screen, and then press ◀ or ▶ to select “SCR-ADJ”.

2 Press ▲ or ▼ to select “Resize”.



3 Press ◀ or ▶ to adjust the desired Resize mode and then press ◀ (**ENTER**).

Note

- The RESIZE function that can be selected varies depending on the input signal (resolution and vertical frequency).

Resize Mode

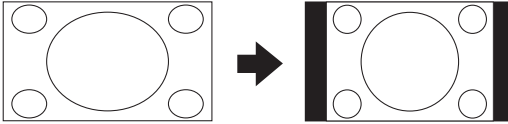
RESIZE	Output screen image
Normal	<p>The image is displayed with the original aspect ratio.</p>
Full	<p>The image is displayed at full-screen.</p>
16:9	<p>An image compressed from a 16:9 aspect ratio to a 4:3 aspect ratio is restored to a 16:9 aspect ratio and displayed at full-screen.</p>

RESIZE	Output screen image
4:3	<p data-bbox="509 268 1252 323">An image stretched from a 4:3 aspect ratio to a 16:9 aspect ratio is restored to a 4:3 aspect ratio.</p> 
Native	<p data-bbox="509 491 1195 575">The image is displayed according to the original input signal. "Native" cannot be selected when the input mode is VIDEO or S-VIDEO.</p> 

About Copyrights

- When using the Resize function to select an image size with a different aspect ratio to a TV program or video image, the image will look different from its original appearance. Keep this in mind while choosing an image size.
- The use of the Resize or Keystone Correction function to compress or stretch the image for commercial purposes/public displays in a café, hotel, etc. may be an infringement of copyright protected by law for copyright holders. Please use caution.

Operating with the Remote Control

Auto Sync (Auto Sync Adjustment)

Auto Sync function works when detecting input signal after the projector turns on.

Press **AUTO SYNC** to manually adjust with Auto Sync function.

Note

- When the optimum image cannot be achieved with Auto Sync adjustment, use manual adjustments. (See page 46.)

Freezing a Moving Image

- 1 Press FREEZE.**
 - The projected image is frozen.
- 2 Press FREEZE again to return to the moving image from the currently connected device.**

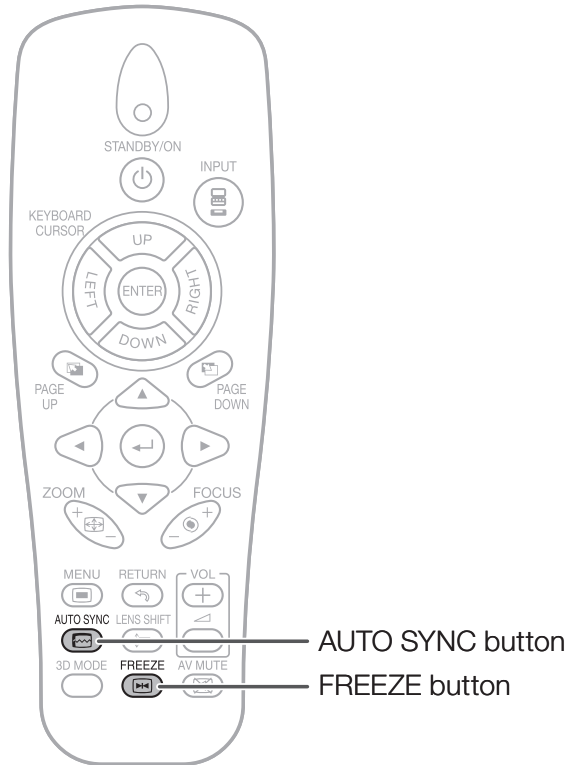

Using the Remote Control to Operate the Computer

When connecting the projector and the computer with a USB cable, you can use the remote control to operate the computer.

Connecting with a USB cable

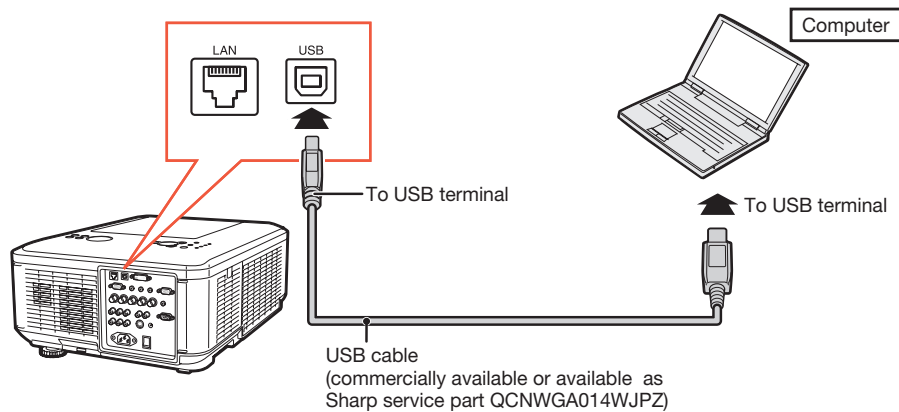

The computer can be operated in the following way after it is connected.

- **When moving the cursor**
Same as the [↑/↓/←/→] keys on a computer keyboard.
Press **KEYBOARD CURSOR (UP/DOWN/LEFT/RIGHT)**.
- **When using [Enter]**
Same as the [Enter] key on a computer keyboard.
Press **KEYBOARD CURSOR (ENTER)**.
- **When using [Page Up] or [Page Down]**
Same as the [Page Up] and [Page Down] keys on a computer keyboard.
Press **PAGE UP** or **PAGE DOWN**.

Note

- This function only works with the Microsoft® Windows® OS and Mac OS® that support USB.
- Confirm that the computer recognizes the USB connection.

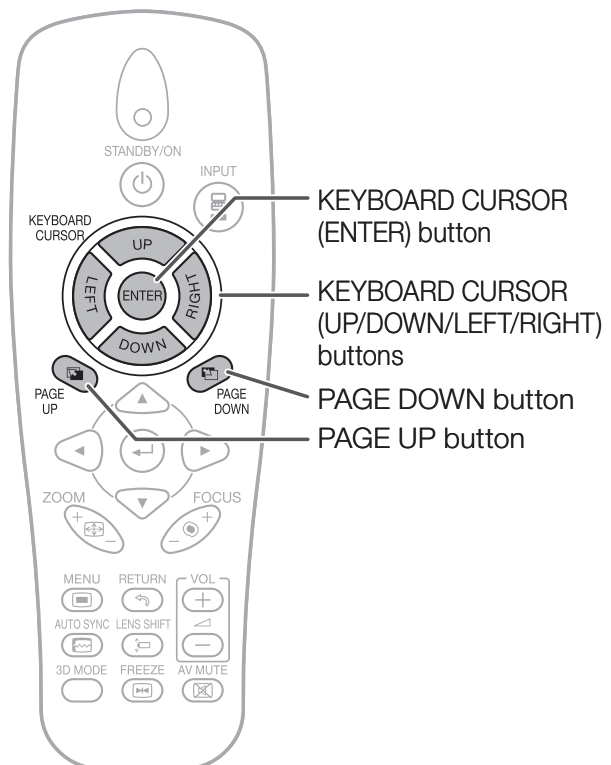

Menu Items

The following shows the items that can be set in the projector.

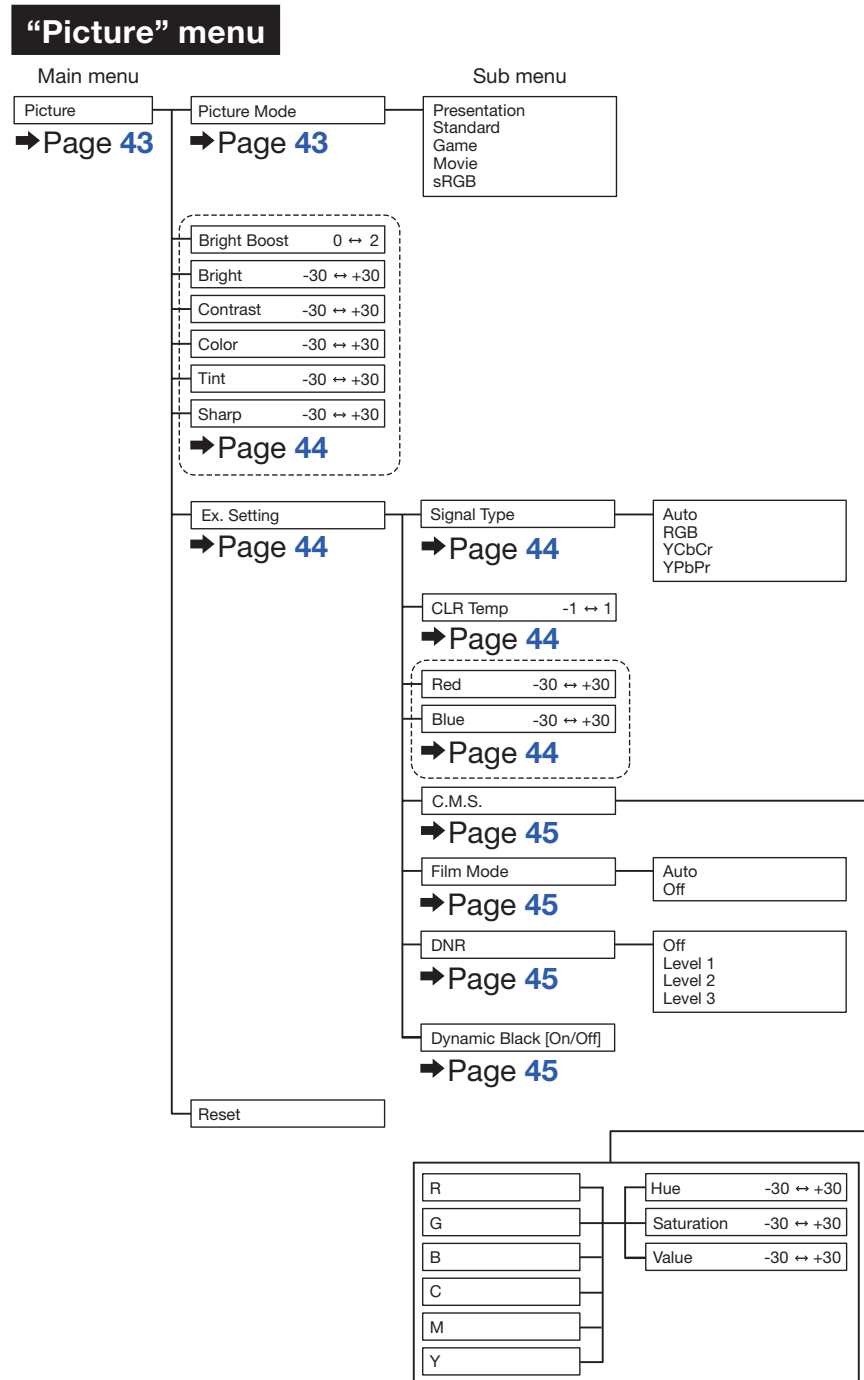

“Signal adjustment (SIG-ADJ)” menu

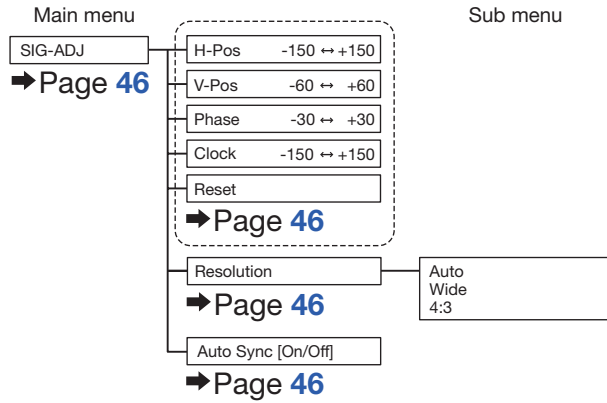

“Video” menu

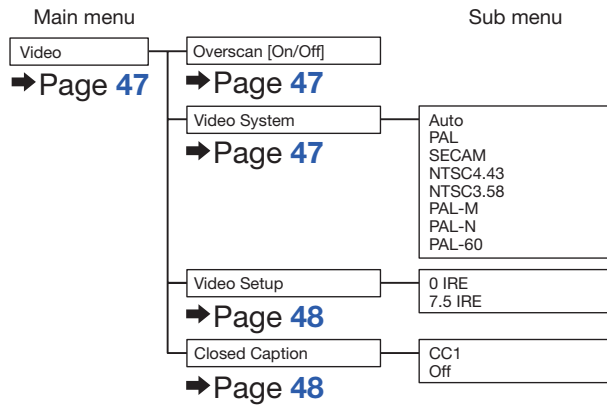

“Screen adjustment (SCR-ADJ)” menu

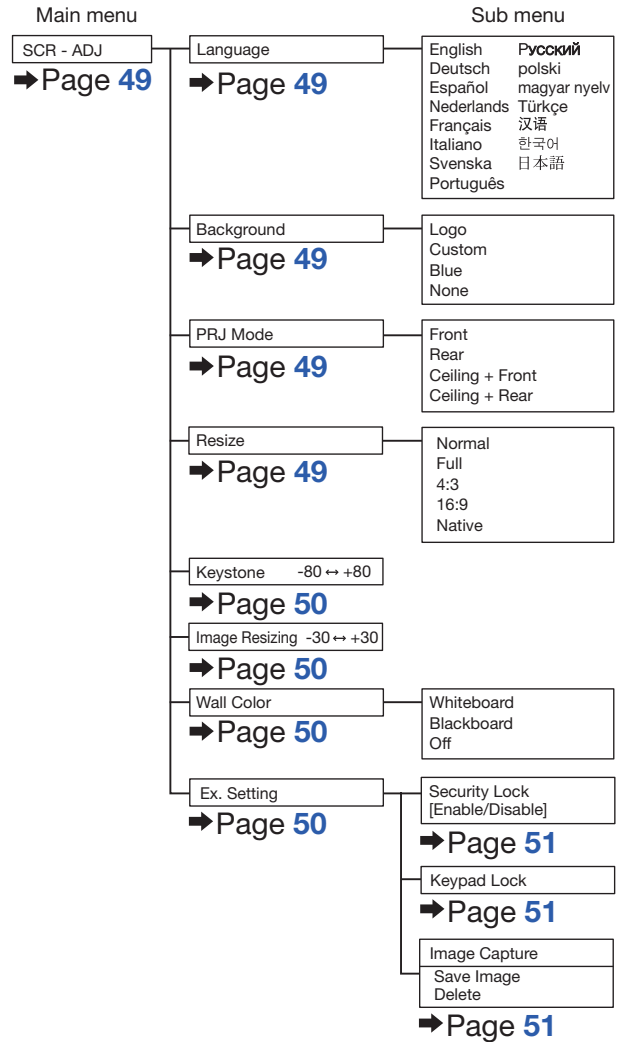

Menu Items (Continued)

“Projector adjustment (PRJ-ADJ)” menu

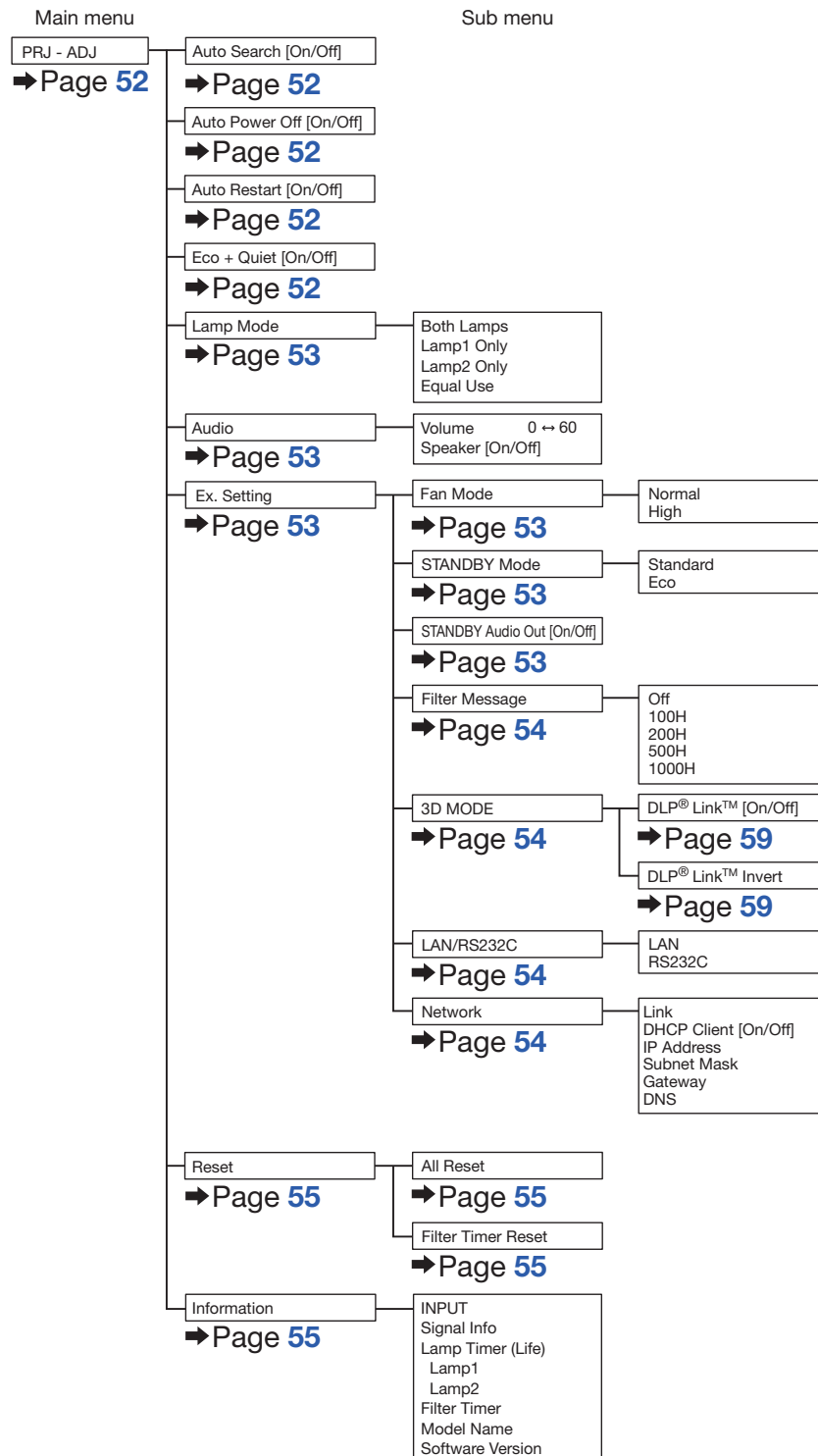

Using the Menu Screen

Adjustment buttons (▲/▼/◀/▶)

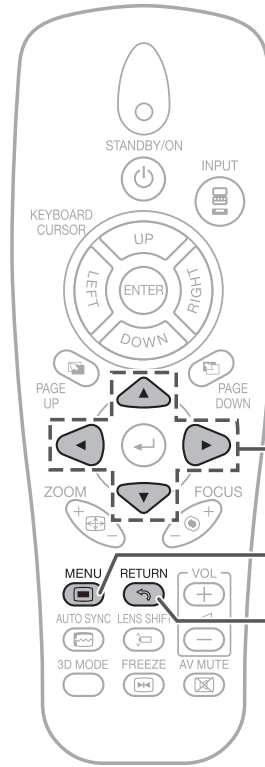
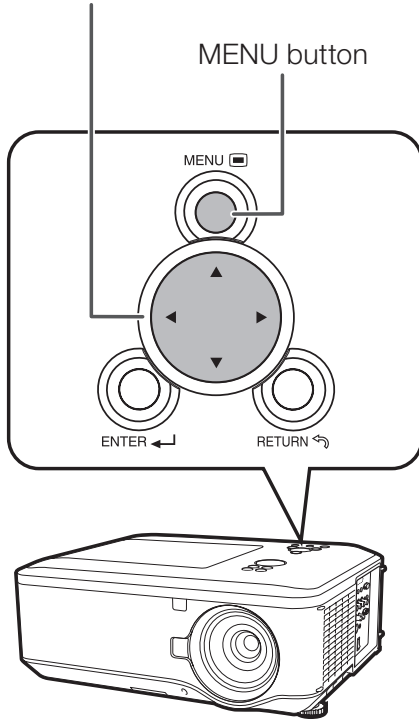

Adjustment buttons (▲/▼/◀/▶)

MENU button

RETURN button

- Press **RETURN** to return to the previous screen when the menu is displayed.

Menu Selections (Adjustments)

Example: Adjusting “Bright”.

- This operation can also be performed by using the buttons on the projector.

1 Press MENU.

- The menu screen is displayed.

2 Press ▶ or ◀ and select “Picture” to adjust.

Example: “Picture” screen menu for COMPUTER (RGB) input

Menu item

Picture	SIG-ADJ	Video	SCR-ADJ	PRJ-ADJ
Picture Mode				Presentation
Bright Boost				2
Bright				0
Contrast				0
Color				0
Tint				0
Sharp				0
Ex. Setting				↔
Reset				↔
MENU = END		SEL./ADJ. ◀▶	SEL. ▲▼	

Using the Menu Screen (Continued)

3 Press ▲ or ▼ and select “Bright” to adjust.

- The selected item is highlighted.

Picture	SIG-ADJ	Video	SCR-ADJ	PRJ-ADJ
Picture Mode		Presentation		
Bright Boost				2
Bright				0
Contrast				0
Color				0
Tint				0
Sharp				0
Ex. Setting				↔
Reset				↔
MENU = END		SEL./ADJ. ◀▶	SEL. ▲▼	

Items to be adjusted

Picture	SIG-ADJ	Video	SCR-ADJ	PRJ-ADJ
H-Pos				0
V-Pos				0

4 Press ◀ or ▶ to adjust the item selected.

- The adjustment is stored.

Picture	SIG-ADJ	Video	SCR-ADJ	PRJ-ADJ
Picture Mode		Presentation		
Bright Boost				2
Bright				15
Contrast				0
Color				0
Tint				0
Sharp				0
Ex. Setting				↔
Reset				↔
MENU = END		SEL./ADJ. ◀▶	SEL. ▲▼	

5 Press MENU.

- The menu screen will disappear.

Picture Adjustment (“Picture” Menu)

Menu operation → Page 41

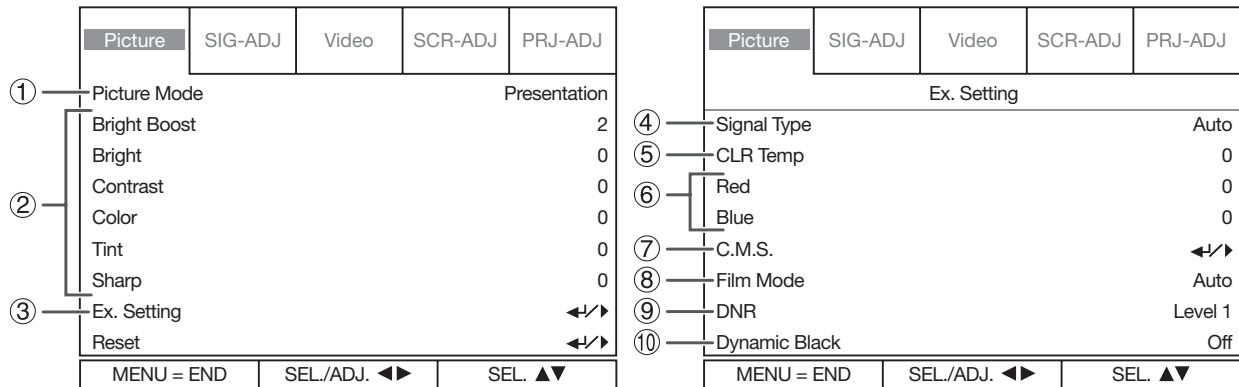

① Selecting the Picture Mode

Selectable items	Description	The default settings of each item when selecting Picture Mode	
		CLR Temp	Bright Boost
Presentation	Brightens portions of image for more enhanced presentations.	0	2
Standard	For standard image	0	1
Game	Gives sharpness to the projected image.	0	1
Movie	Gives natural tint to the projected image.	-1	0
sRGB*	For high fidelity reproduction of images from a computer.	-	-

- “sRGB” is displayed only when RGB signal is input.
- You can set or adjust each item in the “Picture” menu to your preference. Any changes you make are retained in memory.

Note

- *sRGB is an international standard of color reproduction regulated by the IEC (International Electrotechnical Commission). As the fixed color area has been decided by the IEC, the images are displayed in a natural tint based on an original image, when “sRGB” is selected. You cannot set the items, “Red”, “Blue”, “CLR Temp”, “Bright Boost”, “C.M.S.”, when “sRGB” is selected.

Info

- When “sRGB” is selected, the projected image may become dark, but this does not indicate a malfunction.

Picture Adjustment (“Picture” Menu) (Continued)

Menu operation → Page 41

② Adjusting the Image

Adjustment items	◀ button	▶ button
Bright Boost	To improve color reproduction, lower bright boost setting.	To increase brightness, increase bright boost setting.
Bright	For less brightness.	For more brightness.
Contrast	For less contrast.	For more contrast.
Color* ¹	For less color intensity.	For more color intensity.
Tint* ¹	For making skin tones purplish.	For making skin tones greenish.
Sharp* ¹	For less sharpness.	For more sharpness.

*1 Not selected in the RGB input mode.

Note

- “Bright Boost” cannot be set when “sRGB” is selected.
- To reset all adjustment items, select “Reset” and press **←** (ENTER).

③ Using the Ex. Setting

Select “Ex. Setting” and then press **←** (ENTER) to set “Signal Type”, “CLR Temp”, “Red”, “Blue”, “C.M.S.”, “Film Mode”, “DNR” or “Dynamic Black”.

④ Signal Type Setting

This function allows you to select the input signal for COMPUTER/COMPONENT1, 2 or COMPONENT.

Selectable items	Description
Auto	Input signals are automatically recognized as RGB or component.
RGB	Set when RGB signals are received.
YCbCr	Set when Component signals (480I/480P/576I/576P) are received.
YPbPr	Set when Component signals (720P/1080I/1080P) are received.

⑤ Adjusting the Color Temperature

Selectable items	Description
-1	For lower color temperature for warmer, reddish incandescent-like images.  For higher color temperature for cooler, bluish, fluorescent-like images.
0	
1	

Note

- “CLR Temp” cannot be set when “sRGB” is selected.
- Values on “CLR Temp” are only for general standard purposes.

⑥ Adjusting the Red/Blue

Adjustment items	◀ button	▶ button
Red	For weaker red.	For stronger red.
Blue	For weaker blue.	For stronger blue.

Note

- “Red” and “Blue” are not adjustable/selectable when selecting “sRGB”.

⑦ Adjusting the Colors

This function adjusts each of the six main colors that comprise the color wheel, altering their “Hue”, “Saturation”, or “Value”.

Selectable items	Description
Hue	Sets the hue of the main colors.
Saturation	Sets the saturation of the main colors.
Value	Sets the brightness of the main colors.

Adjusting “Hue”, “Saturation”, or “Value”.

- 1 Select “C.M.S.” in “Ex. Setting” of the “Picture” menu and then press **↵** (ENTER).
- 2 Select “R”, “G”, “B”, “C”, “M” or “Y” and then press **↵** (ENTER).
- 3 Press **▲** or **▼** to select either “Hue”, “Saturation”, or “Value”.
- 4 Select the color to be adjusted with **◀** or **▶**.

Example of adjusting the “Hue”

Main colors	◀ button	▶ button
R (Red)	Closer to magenta	Closer to yellow
G (Green)	Closer to yellow	Closer to cyan
B (Blue)	Closer to cyan	Closer to magenta
C (Cyan)	Closer to green	Closer to blue
M (Magenta)	Closer to blue	Closer to red
Y (Yellow)	Closer to red	Closer to green

- When “Saturation” is selected, the selected color becomes
◀: lighter. ▶: thicker.
- When “Value” is selected, the selected color becomes
◀: darker. ▶: brighter.

Note

- “C.M.S.” is not selectable when “sRGB” is selected.

⑧ Selecting the Film Mode

This function provides high-quality playback of images originally projected at 24 fps, such as movies on DVDs.

Selectable items	Description
Auto	Films are detected automatically.
Off	Films are not detected.

Note

- This function is available for the following signals.
With COMPUTER/COMPONENT1, 2 or COMPONENT input:
- 480I
- 576I
- 1080I
With S-VIDEO or VIDEO input:
- All signals

⑨ Reducing Image Noise (DNR)

Video digital noise reduction (DNR) provides high quality images with minimal dot crawl and cross color noise.

Selectable items	Description
Off	DNR does not function.
Level 1	Sets the DNR level for viewing a clearer picture.
Level 2	
Level 3	

Note

- This function is not available for some signals.

⑩ Setting the Dynamic Black

Use this function to improve the black level of the projector.

Selectable items	Description
On	The black level of the projector will be improved.
Off	Dynamic Black does not function.

Signal Adjustment (“SIG-ADJ” Menu)

Menu operation → Page 41

	Picture	SIG-ADJ	Video	SCR-ADJ	PRJ-ADJ
①	H-Pos				0
	V-Pos				0
	Phase				0
	Clock				0
	Reset				←/→
②	Resolution				Auto
③	Auto Sync				Off
MENU = END		SEL./ADJ. ◀▶		SEL. ▲▼	

① Adjusting the Computer Image

If the optimum image cannot be obtained with Auto Sync adjustment, use the SIG-ADJ function.

Selectable items	Description
H-Pos	Centers the on-screen image by moving it to the left or right.
V-Pos	Centers the on-screen image by moving it up or down.
Phase	Adjusts horizontal noise (similar to tracking on your VCR).
Clock	Adjusts vertical noise.

Note

- To reset all adjustment items, select “Reset” and press **← (ENTER)**.
- The adjustable range of “H-Pos” (H-Position) and “V-Pos” (V-Position) may vary depending on the screen resolution of the computer.

③ Auto Sync (Auto Sync Adjustment)

Selectable items	Description
On	Auto Sync adjustment will occur when the projector is turned on or when the input signals are switched, when connected to a computer.
Off	Auto Sync adjustment is not automatically performed.

Note

- Auto Sync adjustment is also performed by pressing **AUTO SYNC**.
- The Auto Sync adjustment may take some time to complete, depending on the image of the computer connected to the projector.
- When the optimum image cannot be achieved with Auto Sync adjustment, use manual adjustments.

② Setting the Resolution

Selectable items	Description
Auto	Input signal resolution is automatically recognized.
Wide	Set when the Wide signal is received.
4:3	Set when the 4:3 signal is received.

Video Adjustment (“Video” Menu)

Menu operation → Page 41

Picture	SIG-ADJ	Video	SCR-ADJ	PRJ-ADJ
①	Overscan			On
②	Video System			Auto
③	Video Setup			7.5 IRE
④	Closed Caption			Off
MENU = END SEL./ADJ. ◀▶ SEL. ▲▼				

① Setting the Overscan

This function allows you to set the overscan area (display area).

Selectable items	Description
On	The input area is displayed without the screen edges.
Off	The whole input area is displayed.

Note

- This function is available for the following signals.
With COMPUTER/COMPONENT1, 2, COMPONENT or DVI-D input:
 - 480P
 - 576P
 - 720P
 - 1080I/1080P
- If noise appears at the screen edges when “Off” is selected, set the function to “On”.
- Also see “About Copyrights” on page 35.

② Setting the Video System

The video input system mode is factory preset to “Auto”; however, a clear picture from the connected audio-visual equipment may not be received, depending on the Video signal difference.

In that case, switch the Video signal.

Selectable items
Auto
PAL
SECAM
NTSC4.43*
NTSC3.58
PAL-M
PAL-N
PAL-60

* When reproducing NTSC signals in PAL video equipment.

Note

- The Video signal can only be set in S-VIDEO or VIDEO mode.
- When “Video System” is set to “Auto”, you may not receive a clear picture due to signal differences. Should this occur, switch to the video system of the source signal.

Video Adjustment (“Video” Menu) (Continued)

Menu operation → Page 41

③ Setting the Video Setup

Selectable items	Description
0 IRE	Sets the black level to 0 IRE.
7.5 IRE	Sets the black level to 7.5 IRE.

Note

- This function is available for the following signals.
With COMPUTER/COMPONENT1, 2 or COMPONENT input:
 - 480I
 With S-VIDEO or VIDEO input:
 - NTSC3.58

Note

- Closed Caption may malfunction (white blocks, strange characters, etc.) if signal conditions are poor or if there are problems at the broadcast source. This does not necessarily indicate a problem with the projector.
- If any button is pressed to call up the on-screen display while viewing a Closed Caption broadcast, the closed captions will disappear.

④ Closed Caption

<For Americas only>

Info

- This function is available for NTSC3.58 signal.
- This function is available in the following cases only:

Resize mode	Keystone Correction
Normal Full 4:3	-40 – +40
16:9	-12 – +12

- “Closed Caption” is a system which allows conversations, narration, and sound effects in TV programs (Limited regions) and home videos to be viewed as captions on the screen.
- Not all programs and videos will offer closed captioning. Please look for the  symbol to ensure that captions will be shown.

Selectable items	Description
CC1	Closed Caption mode for CH1 data
Off	—

Adjusting the Projected Image (“SCR-ADJ” Menu)

Menu operation → Page 41

	Picture	SIG-ADJ	Video	SCR-ADJ	PRJ-ADJ
①	Language				English
②	Background				Logo
③	PRJ Mode				Front
④	Resize				Normal
⑤	Keystone				0
⑥	Image Resizing				0
⑦	Wall Color				Off
⑧	Ex. Setting				↔/↕
MENU = END SEL./ADJ. ◀▶ SEL. ▲▼					

	Picture	SIG-ADJ	Video	SCR-ADJ	PRJ-ADJ
	Ex. Setting				
⑨	Security Lock				Disable
⑩	Keypad Lock				↔/↕
⑪	Image Capture				↔/↕
MENU = END SEL./ADJ. ◀▶ SEL. ▲▼					

① Selecting the On-screen Display Language

The projector can switch the on-screen display language among 15 languages.

English	Русский
Deutsch	polski
Español	magyar nyelv
Nederlands	Türkçe
Français	汉语
Italiano	한국어
Svenska	日本語
Português	

② Selecting the Background Image

Selectable items	Description
Logo	Sharp logo screen
Custom	User customized image (e.g. company logo)
Blue	Blue screen
None	Black screen

Note

- When “Custom” is selected, an image saved using “Image Capture” can be displayed as a background image.

③ Reversing/Inverting Projected Images

Selectable items	Description
Front	Normal image (Projected from the front of the screen)
Rear	Reversed image (Projected from the rear of the screen or with a mirror)
Ceiling + Front	Inverted image (Projected from the front of the screen with an inverted projector)
Ceiling + Rear	Reversed and inverted image (Projected with a mirror)

See page 20 for details of Projection (PRJ) Mode.

④ Setting the Resize Mode

Use this function to stretch the image vertically or horizontally or when the edges of the image cannot be seen.

Note

- For details of the Resize mode, see pages 34 and 35.

Adjusting the Projected Image (“SCR-ADJ” Menu) (Continued)

Menu operation → Page 41

⑤ Keystone Correction

When the image is projected either from the top or from the bottom towards the screen at an angle, the image becomes distorted trapezoidally. The function for correcting trapezoidal distortion is called Keystone Correction.

Select “Keystone” on the “SCR-ADJ” menu and adjust with the slide bar.

See page 32 for details of “Correcting Trapezoidal Distortion”.

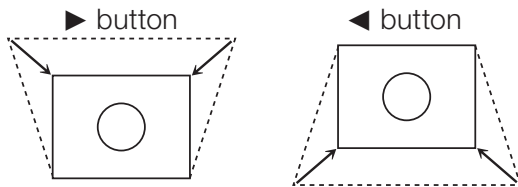

Note

- The Keystone Correction can be adjusted up to an angle of approximately ± 30 degrees.

⑥ Image Resizing

For correcting the image distortion which cannot be corrected with “Keystone”. Only when “Keystone” is set to the values other than “0”, “Image Resizing” can be adjusted.

Select “Image Resizing” on the “SCR-ADJ” menu and adjust with the slide bar.

See page 32 for details of “Correcting Trapezoidal Distortion”.

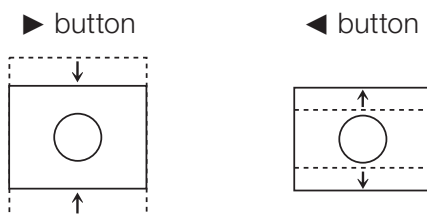

⑦ Selecting the Wall Color

This function allows you to project the image to a colored (white or dark green) surface or wall without using a screen.

Selectable items	Description
Whiteboard	Projects images onto a whiteboard.
Blackboard	Projects images onto a blackboard (dark green).
Off	The Wall Color function is not activated.

⑧ Using the Ex. Setting

Select “Ex. Setting” and then press \leftarrow (ENTER) to set “Security Lock”, “Keypad Lock” or “Image Capture”.

⑨ Security Lock Function

This function prevents unauthorized use of the projector. Once this function is activated, users must enter the correct password each time the projector is turned on. **We suggest you record the password in a safe place where only authorized users have access.**

Info

- If you lose or forget your password, contact your nearest Sharp Authorized Projector Dealer or Service Center (see page 76). Even if the product warranty is valid, the password reset will incur a charge.

■ Setting a Password

1 Select “Security Lock”, then press ► when “Disable” is displayed.

- The screen for entering the password appears.

2 Press ▲/▼/◀/▶ (Adjustment buttons) on the remote control or on the projector to enter the password in “Setting the Password”.

Password	
Setting the Password	■ ■ ■ ■ ■
Confirm Password	■ ■ ■ ■ ■

3 Enter the same password in “Confirm Password”.

4 Press RETURN to exit.

Note

When the Security Lock is set

- When Security Lock is set, the password input screen appears after the power is turned on. When it appears, enter the right password to start projection.

Input screen for password

Password	
	■ ■ ■ ■ ■

■ Canceling a Password

Select “Security Lock”, then press ► when “Enable” is displayed.

⑩ Keypad Lock Function

Use this function to lock the operation buttons on the projector.

Selectable items	Description
No	Turns off the Keypad Lock function.
Yes	All buttons on the projector, except STANDBY/ON , are locked.

■ Taking the Keypad Lock Off

Hold down ▼ (Adjustment button) on the projector for about 5 seconds.

Info

- Keypad Lock cannot be released while the projector is: displaying the “Menu” screens, in Standby mode, warming up, changing input signals or operating the Auto Sync function, in Freeze mode or on the “Security Lock” screen during warming up.

⑪ Image Capture

This projector allows you to capture projected images (RGB signals) and set them as a startup image, or background image when no signals are being received.

Note

- Images can be captured only when they are from WXGA (1280 × 800) (XG-PH80W-N), XGA (1024 × 768) (XG-PH80X-N) non-interlace signals in COMPUTER/COMPONENT1, 2 or DVI-D mode with “Resize” set to “Normal”.
- Images from equipment connected to VIDEO or S-VIDEO terminal cannot be captured.
- To delete the captured image, select “Yes” in “Delete”, and then press ← (ENTER). (See OSD tree image on page 39.)
- An image can be saved for either of the four-segment color wheel or the six-segment one, separately. Each color wheel can save one image.
 - When the four-segment color wheel is used, only the image saved for the four-segment color wheel is available.
 - When the six-segment color wheel is used, only the image saved for the six-segment color wheel is available.
- Depending on the image type, it may take the projector some 2 minutes to complete the capture.
- Switching input signals during performing Image Capture may result in the failure of the performance of the capture.

Adjusting the Projector Function (“PRJ-ADJ” Menu)

Menu operation → Page 41

	Picture	SIG-ADJ	Video	SCR-ADJ	PRJ-ADJ
①	Auto Search				Off
②	Auto Power Off				Off
③	Auto Restart				Off
④	ECO + Quiet				Off
⑤	Lamp Mode				Both Lamps
⑥	Audio				↔
⑦	Ex. Setting				↔
⑮	Reset				↔
⑯	Information				↔
MENU = END SEL./ADJ. ◀▶ SEL. ▲▼					

	Picture	SIG-ADJ	Video	SCR-ADJ	PRJ-ADJ
Ex. Setting					
⑧	Fan Mode				Normal
⑨	STANDBY Mode				Standard
⑩	Standby Audio Out				On
⑪	Filter Message				500H
⑫	3D MODE				↔
⑬	LAN/RS232C				LAN
⑭	Network				↔
MENU = END SEL./ADJ. ◀▶ SEL. ▲▼					

① Detecting the Input Signals Automatically

This function enables the projector to detect the received signal and to switch the Input mode automatically when the power is turned on.

Selectable items	Description
On	Automatically searches for and switches to the input mode in which signals are being received.
Off	Auto Search does not function.

Note

- While the “Auto Search” function is detecting the input signal, pressing a button on the projector or the remote control stops the “Auto Search” function. After the “Auto Search” function finishes completely, press the desired button.

② Auto Power Off Function

Selectable items	Description
On	When no input signal is detected for more than 15 minutes, the projector will automatically enter Standby mode.
Off	The Auto Power Off function will be disabled.

③ Auto Restart Function

Selectable items	Description
On	If the power cord is unplugged from the outlet or the breaker switch is turned off when the projector is on, then the projector automatically turns on when the power cord is plugged into the AC outlet or the breaker switch is turned on.
Off	The projector does not turn on automatically when the power cord is plugged into the AC outlet or the breaker switch is turned on.

To activate the Auto Restart function, you need to switch the MAIN POWER switch on the projector to “ON”.

④ Eco+Quiet

Selectable items	Brightness and Power consumption
On	Approx. 83%
Off	100%

Note

- When “Eco+Quiet” is set to “On”, the fan sound and power consumption are lower than they are when “Off” is selected. (Projection brightness decreases as shown in the chart.)

⑤ Setting the Lamp Mode

This function allows you to select the usage of the two lamps installed in the projector.

Selectable items	Description
Both Lamps	Both lamps are used for greater brightness.
Lamp 1 Only	The lamp 1 is used. When the lamp 1 burns out, the lamp 2 automatically switches in use.
Lamp 2 Only	The lamp 2 is used. When the lamp 2 burns out, the lamp 1 automatically switches in use.
Equal Use	The lamp whose remaining life time is the longer is used.



Note

- For lamp protection, this function is not available for several minutes when changing the lamp mode.

⑥ Setting the Audio

You can set the following Audio items.

Selectable items	Description	
Volume	You can change the volume level. The adjustable range is 0 to 60.	
Speaker	On	The audio signal is output from the internal speaker.
	Off	The audio signal is not output from the internal speaker.



Note

- The audio signal is not output from the speaker of the projector when the audio cable is connected to the audio output terminal and you cannot change the setting.

⑦ Using the Ex. Setting

Select “Ex. Setting” and then press **↵ (ENTER)** to set “Fan Mode”, “STANDBY Mode”, “STANDBY Audio Out”, “Filter Message”, “3D MODE”, “LAN/RS232C” or “Network”.

⑧ Fan Mode Setting

This function changes the fan rotation speed.

Selectable items	Description
Normal	Suitable for normal environments.
High	Set when using the projector at altitudes of approximately 1,200 meters (4,000 feet) or more.

When “Fan Mode” is set to “High”, the fan rotation speeds up, and the fan noise becomes louder.

⑨ STANDBY Mode

When set to “Eco”, power consumption is reduced in Standby mode.

Selectable items	Description
Standard	The monitor output, LAN/RS232C and Network functions are activated even if the projector is in Standby mode.
Eco	The monitor output, LAN/RS232C and Network functions are switched off in Standby mode.

⑩ STANDBY Audio Out

You can set audio output from the AUDIO OUTPUT terminal of the projector that is in Standby mode.

Selectable items	Description
On	The audio signal is output from the AUDIO OUTPUT terminal in Standby mode.
Off	The audio signal is not output from the AUDIO OUTPUT terminal in Standby mode.



Note

- When “Eco” is selected for “STANDBY Mode”, “STANDBY Audio Out” is set to “Off” automatically and you cannot change the setting.

Adjusting the Projector Function (“PRJ-ADJ” Menu) (Continued)

Menu operation → Page 41

11 Filter Message

You can select the interval time to display a message for cleaning the filter.

Clean The Filter.

Selectable items	Description
Off	Not displaying the message.
100H/200H/ 500H/1000H	Select the interval time to display a message.

12 3D MODE

You can set “DLP® Link™” and “DLP® Link™ Invert”. See “Using 3D Viewing Mode” on page 59 for details.

13 Setting the LAN/RS232C

You can select “LAN” or “RS232C” and selected terminal is only used.

Selectable items	Description
LAN	The LAN function is activated.
RS232C	The RS-232C function is activated.

14 Setting the Network

■ Link

Selectable items	Description
Connected	Connected to the network.
Disconnected	Disconnected from the network.

■ DHCP Client

Connect the LAN cable before turning the projector on. If not, the DHCP Client function does not work. If the DHCP server is not available, set the IP Address, Subnet Mask, Gateway and DNS manually.

Selectable items	Description
On	Obtains configuration parameters for IP Address, Subnet Mask, Gateway, and DNS automatically.
Off	Set the IP Address, Subnet Mask, Gateway, and DNS manually.

■ IP Address/Subnet Mask/Gateway/DNS/Apply

Selectable items	Description
IP Address	Factory default setting: 192.168.150.002 Enter an IP address appropriate for the network.
Subnet Mask	Factory default setting: 255.255.255.000 Set the subnet mask to the same as that of the computer and equipment on the network.
Gateway	Factory default setting: 000.000.000.000 * When not in use, set to “000.000.000.000”.
DNS	Factory default setting: 000.000.000.000 * When not in use, set to “000.000.000.000”.
Apply	Apply and save the new settings.

Note

- Confirm the existing network's segment (IP address group) to avoid setting an IP address that duplicates the IP addresses of other network equipment or computers. If “192.168.150.002” is not used in a network with an IP address of “192.168.150.XXX”, you don't have to change the projector IP address.
- For details about each setting, consult your network administrator.

15 Returning to the Default Settings

■ All Reset

This function allows you to initialize the settings you have made in the projector.

Note

- The following items or menu cannot be initialized.
 - Lamp Timer (Life)
 - Filter Timer
 - Image stored using “Image Capture”

■ Filter Timer Reset

This function allows you to reset the filter timer.

Note

- Make sure to reset the filter timer after cleaning or changing the dust filter. (See page 62.)

16 Information

You can confirm the following items.

Displayed items	Description
INPUT	Used input terminal is displayed.
Signal Info	Current input signal information is displayed.
Lamp Timer (Life)	Lamp usage time and the remaining lamp life (%) are displayed (Both Lamp1 and Lamp2). See “Lamp Life” below.
Filter Timer	Filter usage time is displayed.
Model Name	Model Name is displayed.
Software Version	Current software version is displayed.

Lamp Life

Lamp usage condition	Remaining lamp life	
	“Life”	
	100%	5%
Operated exclusively with “Eco+Quiet” set to “On”	Approx. 3,000 hours	Approx. 150 hours
Operated exclusively with “Eco+Quiet” set to “Off”	Approx. 2,000 hours	Approx. 100 hours

Note

- It is recommended that the lamp be changed when the remaining lamp life becomes 5%.
- The lamp life may vary depending on the usage condition.



Viewing Stereoscopic 3D Images

Precautions on Viewing Stereoscopic 3D Images

Before viewing stereoscopic 3D images, please read this section carefully.

WARNING

- Under normal conditions, viewing stereoscopic 3D images is safe for any duration that you would normally view your screen. However, some people may experience discomfort. The following precautions are recommended to minimize the potential for experiencing visual problems or any adverse symptoms.
- Take regular breaks, at least 5 to 15 minutes after every 30 to 60 minutes of stereoscopic 3D viewing.
 - * Based on the guidelines issued by the 3D Consortium revised December 10, 2008.
- Maintain an appropriate distance from the screen. Viewing from too close a distance can strain your eyes. If you experience eye strain, immediately discontinue viewing.

If you experience any of the following symptoms during viewing:

- nausea
- queasiness/dizziness
- headache
- blurry vision or double vision that lasts longer than few seconds

Do not engage in any potentially hazardous activity (for example, driving a vehicle) until your symptoms have completely gone away. If symptoms persist, discontinue use and do not resume stereoscopic 3D viewing without discussing your symptoms with a physician.

- As you get more comfortable viewing stereoscopic 3D:
 - Adjust the parallax on the 3D-video playback equipment. (You may not be able to adjust the parallax on some models of equipment.)
 - Adjust the projected image to the most comfortable viewing size by zooming. (Projecting images on the smallest or largest screen size possible may eliminate the stereoscopic effect and strain your eyes.)
 - Use the DLP® Link™ Invert function to properly set the video for your left and right eyes. (For details on using “DLP® Link™ Invert”, see the section on its operation in this operation manual.)

WARNING

- The following people should limit stereoscopic 3D viewing:
 - Children under 6 years of age (to protect the eye growth process)
 - People with a history of photosensitivity
 - People with heart disease
 - People in poor health
 - People who are sleep deprived
 - People who are physically tired
 - People under the influence of drugs or alcohol

■ **Epilepsy**

A small percentage of the population may experience epileptic seizures when viewing certain types of images that contain flashing patterns of light.

IF YOU OR ANY MEMBER OF YOUR FAMILY HAS A HISTORY OF EPILEPSY

The following people should consult a physician before viewing stereoscopic 3D images.

- Anyone with a history of epilepsy, or who has a family member with a history of epilepsy
- Children under 6 years of age
- Anyone who has ever experienced epileptic seizures or sensory disturbances triggered by flashing light effects

SOME LIGHT PATTERNS MAY INDUCE SEIZURES IN PERSONS WITH NO PRIOR HISTORY OF EPILEPSY

Discontinue use if you experience any of the following symptoms while viewing stereoscopic 3D images.

- Involuntary movements, eye or muscle twitching
- Muscle cramps
- Nausea, dizziness, or queasiness
- Convulsions
- Disorientation, confusion, or loss of awareness of your surroundings



Viewing Stereoscopic 3D Images (Continued)

Information on the 3D Projection Function

- To display 3D images, this projector requires:
WHAT YOU WILL NEED
 - 1) Source devices that support the field sequential format
 - For details on the supported signals, see the Compatibility Chart in this operation manual.
 - 2) 3D LCD shutter glasses that support the DLP® Link™* system
 - Contact your nearest Sharp Authorized Projector Dealer for purchasing details.
 - * DLP® Link™ is a trademark of Texas Instruments.
- The projected image may become dark when using the 3D projection function (with “DLP® Link™ ” set to “On”).
- When “DLP® Link™” is set to “On”, the following functions may not work fully or may not be available at all.
 - Keystone
 - Resize
 - Image Resizing
- 3D formats except for the field sequential method, such as ones used for Blu-ray 3D or DVD prepackaged media, are not compatible with this projector. (As of February 2011)
- If the power of your left and right eyes greatly differs and you primarily use one eye for viewing the images, the images will not appear in 3D.
In addition, images may be difficult to view in 3D or images may not be able to be viewed in 3D depending on the individual or the content being displayed.
The stereoscopic effect varies with the individual.
- 3D viewing is possible within the range that the 3D LCD shutter glasses are able to receive light signals reflected by the screen. However, most 3D images are manufactured to be viewed from directly in front of the screen, so 3D viewing is recommended directly in front of the screen as much as possible.
 - The range for receiving signals varies depending on the 3D LCD shutter glasses. For details, see the operation manual of your 3D LCD shutter glasses.
- 3D images may not be able to be played back correctly on your computer.

Using 3D Viewing Mode

Use the following procedure to project 3D images.

For operation of the 3D LCD shutter glasses and the 3D-video playback equipment, see the corresponding operation manual.

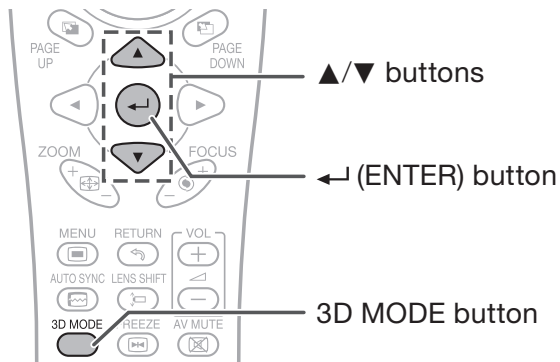

Projecting 3D images

- 1 Turn the projector on.**
- 2 Turn the 3D-video playback equipment on.**
 - Set the 3D-video playback equipment so that it outputs one of the signals listed in the Compatibility Chart in this operation manual.
- 3 Switch the Input mode of the projector to enable input of 3D video signals.**
- 4 Operate the 3D-video playback equipment and play back the 3D content.**
- 5 Turn the 3D LCD shutter glasses on and place them over your eyes.**
- 6 Press 3D MODE on the remote control to display the 3D MODE menu.**

- 7 Press ▲ or ▼ to select “DLP® Link™”, and then select “On”.**

- 8 Select “DLP® Link™ Invert”, and then press ← (ENTER) to switch the mode and enable more natural 3D image viewing.**

Warning!

- If the projector, 3D-video playback equipment, and 3D LCD shutter glasses are not properly set, you may experience eye strain in addition to not being able to view the images in 3D.

- 9 Press 3D MODE.**
 - The 3D MODE menu will disappear.

Note

- If the images are not displayed in 3D, repeat steps 6 to 8.
- You can also use “DLP® Link™” and “DLP® Link™ Invert” on the menu screen to change the 3D setting.

Ending 3D projection

- 1 Press 3D MODE on the remote control to display the 3D MODE menu.**
- 2 Press ▲ or ▼ to select “DLP® Link™”, and then select “Off”.**
- 3 Press 3D MODE.**
 - The 3D MODE menu will disappear.

Note

- You may not be able to enjoy the full 3D effects depending on the installation or usage environment of the projector.
- When you use the 3D projection function, it is recommended that “Lamp Mode” be set to “Both Lamps” and “Eco + Quiet” be switched to “Off”.

Viewing Stereoscopic 3D Images (Continued)

Appendix

■ How the 3D Projection Function (DLP Link™) Works

The 3D projection function of this projector is compatible with the DLP® Link™ system. To watch 3D images, you use a pair of 3D LCD shutter glasses that alternately display the projected images for the left and right eyes and are synchronized with a control (light) signal.

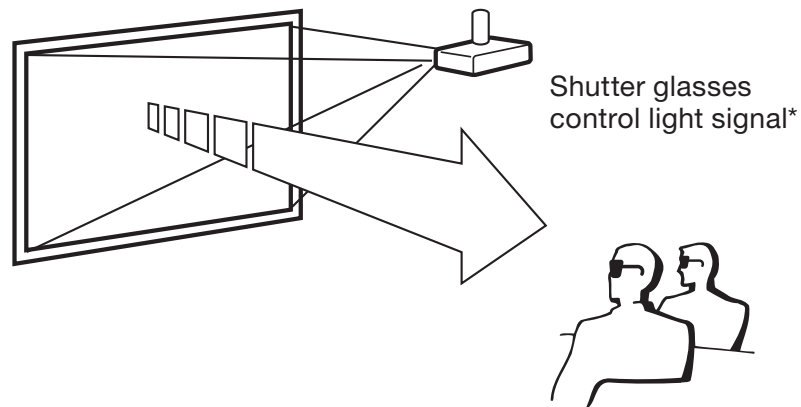

* The control light signal is transmitted from the lens of the projector, reflected by the screen, and received by the light reception sensor on the 3D LCD shutter glasses. Therefore, the range of 3D viewing varies depending on the specifications of the 3D LCD shutter glasses (light signal receiving sensitivity).

For details, see the operation manual of your 3D LCD shutter glasses.

■ For more information on the 3D projection function

Future information on the 3D projection function will be posted on the following web site.
<http://www.sharp-world.com/projector/>

Maintenance

Cleaning the projector

- Ensure that you have unplugged the power cord before cleaning the projector.
- The cabinet as well as the operation panel is made of plastic. Avoid using benzene or thinner, as these can damage the finish on the cabinet.
- Do not use volatile agents such as insecticides on the projector. Do not attach rubber or plastic items to the projector for long periods. The effects of some of the agents in the plastic may cause damage to the quality or finish of the projector.
- Wipe off dirt gently with a soft flannel cloth. Using a chemical cloth (wet/dry sheet type cloth, etc.) may deform the components of the cabinet or cause cracking.
- Wiping with a hard cloth or using strong force may scratch the cabinet surface.
- When the dirt is hard to remove, soak a cloth in a mild detergent diluted with water, wring the cloth well and then wipe the projector. Strong cleaning detergents may discolor, warp or damage the coating on the projector. Make sure to test on a small, inconspicuous area on the projector before use.

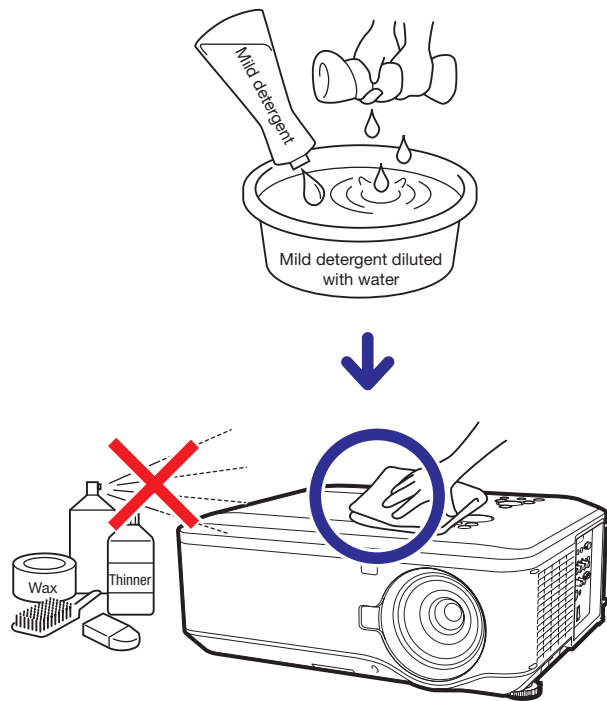

Cleaning the lens

- Use a commercially available blower or lens cleaning paper (for glasses and camera lenses) for cleaning the lens. Do not use any liquid type cleaning agents, as they may wear off the coating film on the surface of the lens.
- As the surface of the lens can easily get damaged, be careful not to scrape or hit the lens.

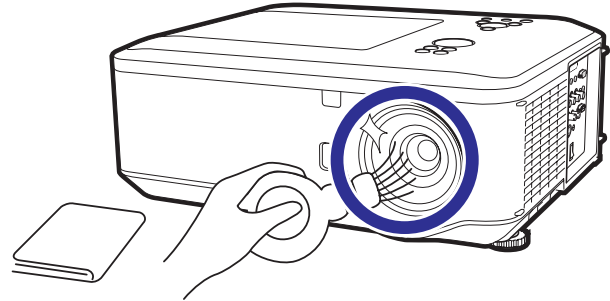

Cleaning and Replacing the Dust Filters

When the message shown below is displayed, clean or replace the three dust filters and then reset the filter timer (see page 55). You must clean or replace all three dust filters at the same time to synchronize the filter timer.

Clean The Filter.

Cleaning the Dust Filters

Use a vacuum cleaner to clean dust from the exhaust vent and the intake vent (bottom, side and rear).

Info

- The dust filters should be cleaned every 100 hours of use. Clean the filters more often when the projector is used in a dusty or smoky location.
- If you want to clean the air vents during projector operation, ensure you press **STANDBY/ON** on the projector or on the remote control and put the projector into Standby mode. After the cooling fan has stopped, clean the vents.

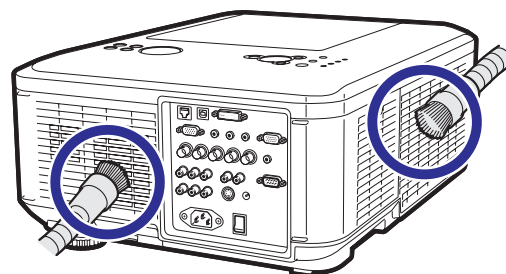
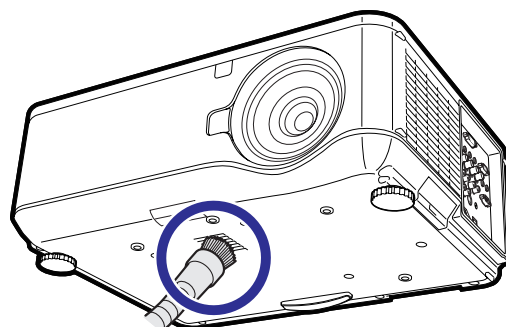

Replacing the Dust Filters

Info

- If the filters become too dirty to clean effectively, purchase new ones (Front: 9NK3243073701, Side: 9NK3243073801, Rear: 9NK3243073601) from your nearest Sharp Authorized Projector Dealer or Service Center.

1 Press **STANDBY/ON** on the projector or on the remote control to put the projector into standby mode.

- Switch the MAIN POWER switch on the projector to "OFF" after the cooling fan stops, and then disconnect the power cord and unplug the power cord from the AC socket.

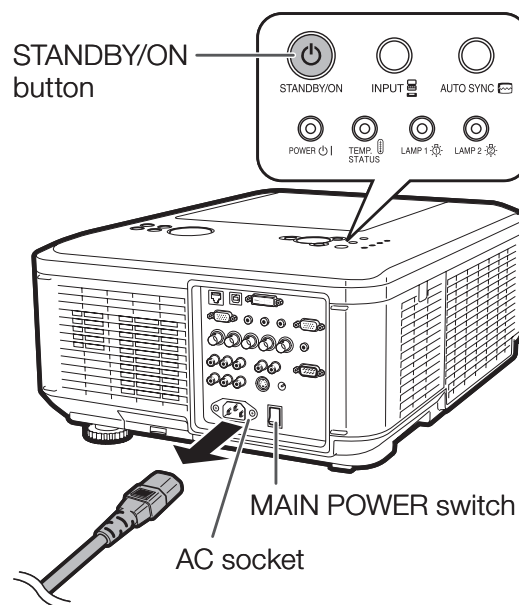

2 Remove the filter covers.

- Remove the filter covers towards the direction of the arrow.

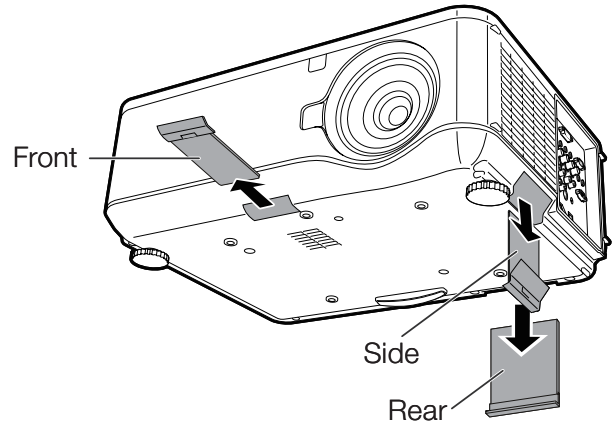

3 Pick the dust filters up and lift them out of all the three filter covers as shown in the figures.

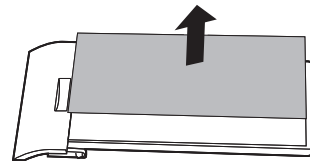

4 Place replacement dust filters and press them down firmly.

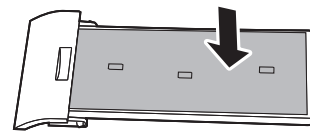

5 Replace the filter covers.

- Insert the filter covers and push them gently as shown in the figure.

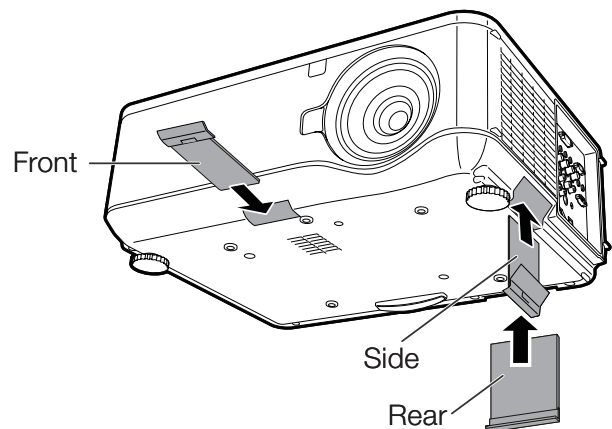

Maintenance Indicators

- The warning lights (POWER indicator, TEMP. (temperature warning)/STATUS indicator and LAMP indicator) on the projector indicate problems inside the projector.
- If a problem occurs, either the TEMP. (temperature warning)/STATUS indicator or the LAMP indicator will illuminate red, and the projector will enter Standby mode. After the projector has entered Standby mode, follow the procedures given below.

Top View

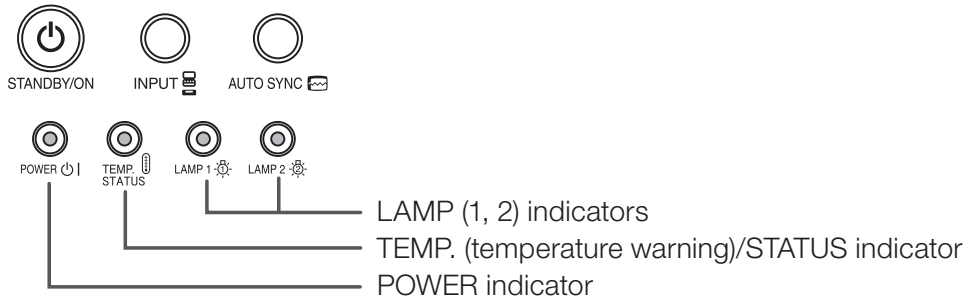



About the TEMP. (temperature warning)/STATUS indicator

If the temperature inside the projector increases, due to blockage of the air vents, or the setting location, the lamp will turn off, the cooling fan will run and then the projector will enter Standby mode, and then the TEMP. (temperature warning)/STATUS indicator will blink. When you find the TEMP. (temperature warning)/STATUS indicator blinking, be sure to perform the measures described on page 65.

About the LAMP indicator

Change The Lamp. (LAMP 1)

- When the remaining lamp life becomes 5% or less,  (yellow) and “Change The Lamp.(LAMP1/2)” will be displayed on the screen. When the percentage becomes 0%, it will change to  (red), the lamp will automatically turn off and then the projector will automatically enter Standby mode. At this time, the lamp indicator will illuminate in red.
- **If you try to turn on the projector a fourth time without replacing the lamp, the projector will not turn on.**

Indicators on the Projector

POWER indicator	Red on	Normal (Standby)
	Green on	Normal (Power on)
	Orange blinks	Normal (Cooling)
	Green blinks	Normal (Warming up)
LAMP indicator	Green on	Normal (“Eco + Quiet” is “Off”.)
	Orange on	Normal (“Eco + Quiet” is “On”.)
	Green blinks	The lamp is warming up. (“Eco + Quiet” is “Off”.)
	Orange blinks	The lamp is warming up. (“Eco + Quiet” is “On”.)
	Red on/Red blinks	The lamp is shut down abnormally or requires to be changed. (See page 65.)
TEMP. (temperature warning)/STATUS indicator	Off	Normal
	Red/Orange blinks	Abnormal. (See page 65.)

	Maintenance indicator		Problem	Cause	Possible Solution
	Normal	Abnormal			
TEMP. (temperature warning)/ STATUS indicator	Off	Red blinks	The TEMP. (temperature warning)/STATUS indicator blinks in red when the projector is on.	<ul style="list-style-type: none"> The lamp unit cover is open. 	<ul style="list-style-type: none"> If the TEMP. (temperature warning)/STATUS indicator blinks in red even when the lamp unit cover are securely installed, contact your nearest Sharp Authorized Projector Dealer or Service Center (see page 76) for advice.
		Red blinks 2 times (Repeatedly)	The internal temperature is abnormally high.	<ul style="list-style-type: none"> Temperatures around the projector are high. Blocked air intake Internal circuit failure. 	<ul style="list-style-type: none"> Use the projector in an area with a temperature of lower than 104°F (+40°C). Relocate the projector to an area with proper ventilation. (See page 8.)
		Orange blinks		<ul style="list-style-type: none"> Cooling fan breakdown Internal circuit failure Clogged air intake 	<ul style="list-style-type: none"> Take the projector to your nearest Sharp Authorized Projector Dealer or Service Center (see page 76) for repair.
LAMP indicator	Green on (Green blinks when the lamp is warming up.)/ Orange on (Eco)	Red blinks	The lamp does not illuminate.	<ul style="list-style-type: none"> No lamp 	<ul style="list-style-type: none"> Install the lamp unit.
			Time to change the lamp.	<ul style="list-style-type: none"> Remaining lamp life becomes 5% or less. 	<ul style="list-style-type: none"> Disconnect the power cord from the AC outlet, and then connect it again. Carefully replace the lamp. (See page 66.) Take the projector to your nearest Sharp Authorized Projector Dealer or Service Center (see page 76) for repair. Please exercise care when replacing the lamp. Securely install the cover.
		Red blinks 2 times (Repeatedly)	The lamp does not illuminate.	<ul style="list-style-type: none"> The lamp is shut down abnormally. Burnt-out lamp Lamp circuit failure 	
	Orange blinks (When the lamp is cooling.)	Red on	Time to change the lamp.	<ul style="list-style-type: none"> The lamp life is over. 	

* For information about other types of blinking, contact your nearest Sharp Authorized Projector Dealer or Service Center (see page 76).

Info

- If the TEMP. (temperature warning)/STATUS indicator illuminates, and the projector enters Standby mode, follow the possible solutions above and then wait until the projector has cooled down completely before plugging in the power cord and turning the projector back on. (At least 10 minutes.)
- If the power is turned off for a brief moment due to power outage or some other cause while using the projector, and the power supply recovers immediately after that, the LAMP indicator will illuminate in red and the lamp may not be lit. In this case, unplug the power cord from the AC outlet, replace the power cord in the AC outlet and then turn the power on again.
- The cooling fan keeps the internal temperature of the projector constant and this function is controlled automatically. The sound of the cooling fan may change during operation because the fan speed may change and this is not a malfunction.

Regarding the Lamp

Lamp

- It is recommended that the lamp (sold separately) be replaced when the remaining lamp life becomes 5% or less, or when you notice a significant deterioration in the picture and color quality. The lamp life (percentage) can be checked with the on-screen display. (See page 55.)
- Purchase a replacement lamp of type AN-PH80LP from your place of purchase, nearest Sharp Authorized Projector Dealer or Service Center.

IMPORTANT NOTE TO U.S. CUSTOMERS:

The lamp included with this projector is backed by a 90-day parts and labor limited warranty. All service of this projector under warranty, including lamp replacement, must be obtained through a Sharp Authorized Projector Dealer or Service Center. For the name of the nearest Sharp Authorized Projector Dealer or Service Center, please call toll-free: 1-888-GO-SHARP (1-888-467-4277).

Hg LAMP CONTAINS MERCURY For State Lamp Disposal Information

www.lamprecycle.org or 1-800-BE-SHARP

U.S.A ONLY

Caution Concerning the Lamp

- This projector utilizes a pressurized mercury lamp. A loud sound may indicate lamp failure. Lamp failure can be attributed to numerous sources such as: excessive shock, improper cooling, surface scratches or deterioration of the lamp due to a lapse of usage time.
The period of time up to failure largely varies depending on the individual lamp and/or the condition and the frequency of use. It is important to note that failure can often result in the bulb cracking.
- When the lamp replacement indicator and on-screen display icon are illuminated, it is recommended that the lamp be replaced with a new one immediately, even if the lamp appears to be operating normally.
- Should the lamp break, there is also a possibility that glass particles may spread inside of the projector. In such a case, it is recommended you contact your nearest Sharp Authorized Projector Dealer or Service Center to assure safe operation.
- Should the lamp break, the glass particles may spread inside the lamp cage or gas contained in the lamp may be vented into the room from the exhaust vent. Because the gas in this lamp includes mercury, ventilate the room well if the lamp breaks and avoid all exposure to the released gas. In case of exposure to the gas, consult a doctor as soon as possible.

Replacing the Lamp



Caution

- Do not remove the lamp unit from the projector right after use. The lamp will be very hot and may cause burns or injury.
 - Wait at least one hour after the power cord is disconnected to allow the surface of the lamp unit to fully cool before removing the lamp unit.
 - **Carefully change the lamp by following the instructions described in this section.**
 - * **If you wish, you may have the lamp replaced at your nearest Sharp Authorized Projector Dealer or Service Center.**
- * If the new lamp does not light after replacement, take your projector to the nearest Sharp Authorized Projector Dealer or Service Center for repair.

Removing and Installing the Lamp Unit

Info

- Do not touch the glass surface of the lamp unit or the inside of the projector.
- To avoid injury to yourself and damage to the lamp, make sure you carefully follow the steps below.
- Do not loosen other screws except for the lamp unit cover and lamp unit.

Warning!

- Do not remove the lamp unit from the projector right after use. The lamp and parts around the lamp will be very hot and may cause burns or injury.

Optional accessory

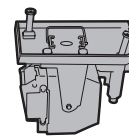

Lamp unit
AN-PH80LP

- 1 Press **STANDBY/ON** on the projector or on the remote control to put the projector into Standby mode.**

- 2 Switch the **MAIN POWER** switch on the projector to “OFF” and then disconnect the power cord.**

- Unplug the power cord from the AC socket.
- Leave the lamp until it has fully cooled down (about 1 hour).

- 3 Remove the lamp unit cover.**

- Loosen the user service screw (1) that secures the lamp unit cover. Remove the lamp unit cover (2).

- 4 Remove the lamp unit.**

- Loosen the securing screws (two for each lamp) from the lamp unit. Hold the lamp unit by the handle and pull it in the direction of the arrow. At this time, keep the lamp unit horizontal and do not tilt it.

STANDBY/ON button

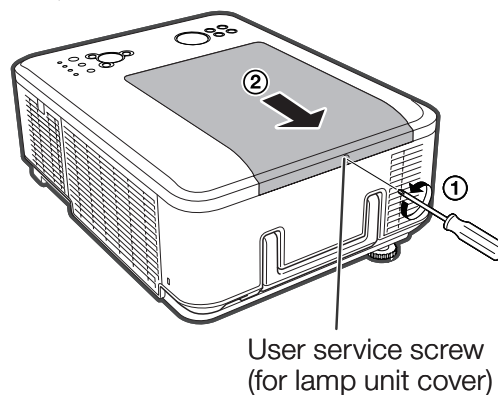
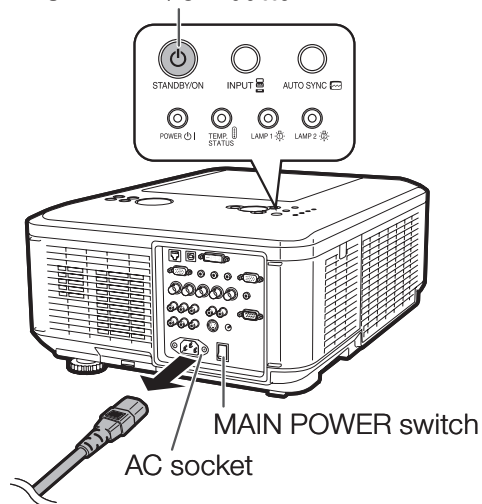

User service screw
(for lamp unit cover)

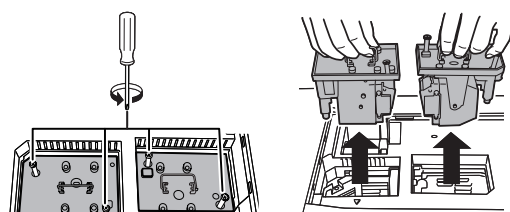

Regarding the Lamp (Continued)

5 Insert the new lamp unit.

- Press the lamp unit firmly into the lamp unit compartment. Fasten the securing screw.

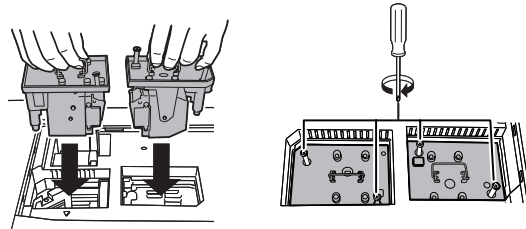

6 Replace the lamp unit cover.

- Align the lamp unit cover and slide it to close (①). Then tighten the user service screw (②) to secure the lamp unit cover.

Info

- If the lamp unit and lamp unit cover are not correctly installed, the power will not turn on, even if the power cord is connected to the projector.

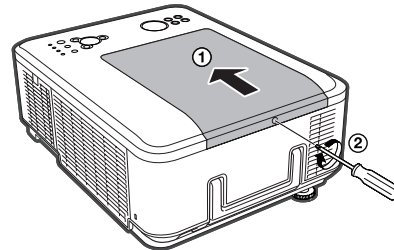

Resetting the Lamp Timer

Reset the lamp timer after replacing the lamp.

Info

- Make sure to reset the lamp timer only when replacing the lamp. If you reset the lamp timer and continue to use the same lamp, this may cause the lamp to become damaged or explode.
- You can reset the lamp timer only when “STANDBY mode” is set to “Standard”.

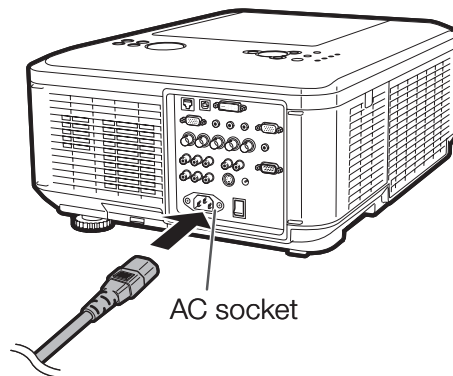

1 Connect the power cord and switch the MAIN POWER switch on the projector to “ON”.

- Plug the power cord into the AC socket of the projector.

2 Reset the lamp timer.

- The projector enters Standby mode when you reset the lamp timer.

For Lamp 1

- When you reset the timer, press **MENU** → **ENTER** → **ENTER** → **MENU** → **←** → **STANDBY/ON** on the projector.
- “LAMP1 0000H” is displayed, indicating that the lamp timer is reset.

For Lamp 2

- When you reset the timer, press **MENU** → **ENTER** → **ENTER** → **MENU** → **▶** → **STANDBY/ON** on the projector.
- “LAMP2 0000H” is displayed, indicating that the lamp timer is reset.

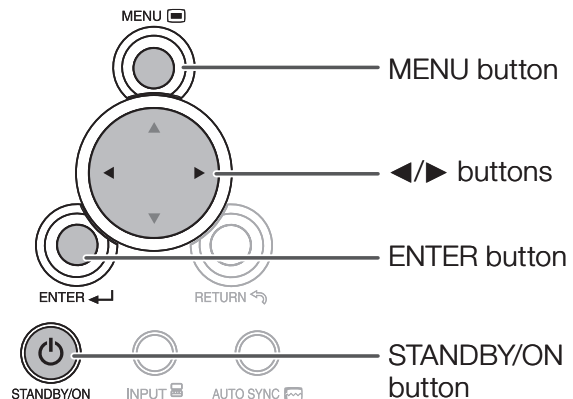

Replacing the Color Wheel

The projector is equipped with a four-segment color wheel. You can replace it with a six-segment color wheel (sold separately). The replacement procedure described below also applies when you put the four-segment color wheel back in the place of the six-segment one.

Warning!

- Do not remove the color wheel from the projector right after use. The lamp and parts around the lamp will be very hot and may cause burns or injury.

1 Press **STANDBY/ON** on the projector or on the remote control to put the projector into Standby mode.

2 Switch the **MAIN POWER** switch on the projector to “OFF” and then disconnect the power cord.

- Unplug the power cord from the AC socket.
- Leave the lamp until it has fully cooled down (about 1 hour).

3 Remove the lamp unit cover.

- Loosen the user service screw (①) that secures the lamp unit cover. Remove the lamp unit cover (②).

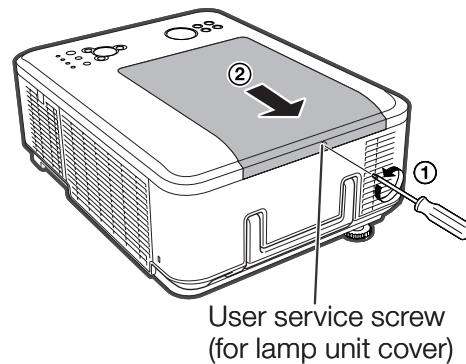
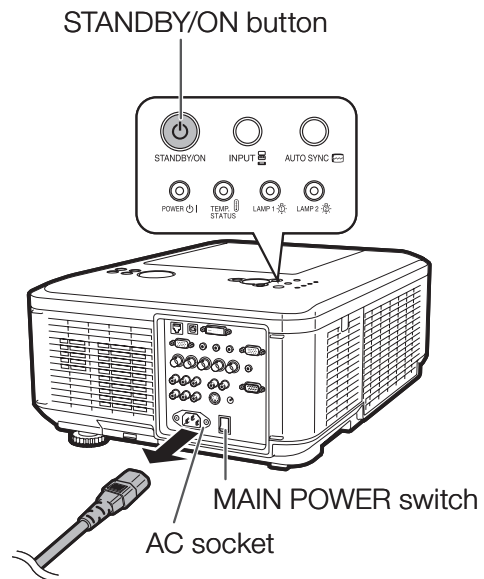

Replacing the Color Wheel (Continued)

4 Loosen the 4 retaining screws from the four-segment color wheel.

5 Hold the color wheel and pull it in the direction of the arrow.

! Caution

The module contains components that can be damaged or destroyed by electrostatic discharge. Please pick the module with the handle.

6 Insert the six-segment color wheel, and tighten the 4 retaining screws.

7 Replace the lamp unit cover.

- Align the lamp unit cover and slide it to close (①). Then tighten the user service screw (②) to secure the lamp unit cover.

Info

Storing the Unused Color Wheel:

Use the zipper bag in which the six-segment color wheel was packaged to store the unused color wheel. This bag prevents dust and dirt from collecting on the color wheel.

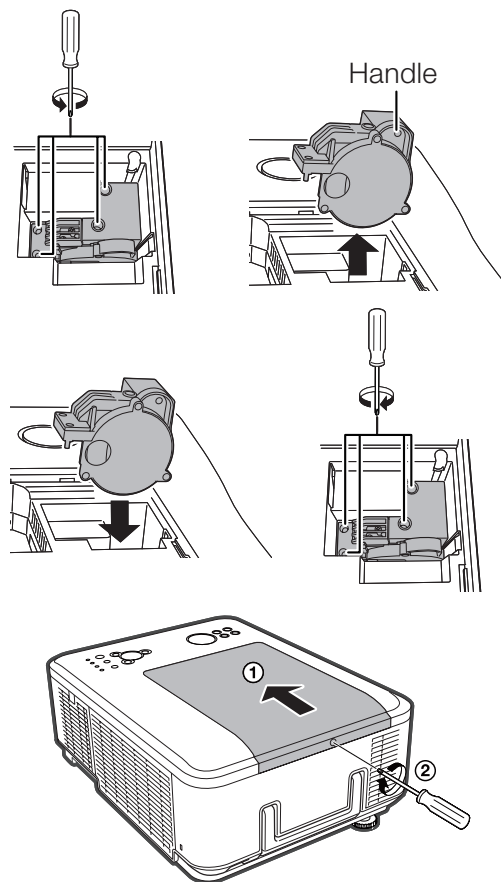

Compatibility Chart

Computer

- Multiple signal support
Horizontal Frequency: 15, 31-90 kHz,
Vertical Frequency: 50-85 Hz,

- Pixel Clock: 12-165 MHz
Sync signal: Compatible with TTL level
- Compatible with sync on green signal

PC/MAC	Mode	Resolution	Horizontal Frequency (kHz)	Vertical Frequency (Hz)	Analog Support	Digital Support	Display		
							XG-PH80W-N	XG-PH80X-N	
PC	VGA	640 × 480	31.5	60	✓	✓	Upscale	Upscale	
			37.9	72	✓	✓			
			37.5	75	✓	✓			
			43.3	85	✓	✓			
	SVGA	800 × 600	35.2	56	✓	✓			
			37.9	60	✓	✓			
			48.1	72	✓	✓			
			46.9	75	✓	✓			
			53.7	85	✓	✓			
	XGA	1024 × 768	48.4	60	✓	✓			TRUE
			56.5	70	✓	✓			
			60.0	75	✓	✓			
			68.7	85	✓	✓			
	WXGA	1280 × 720	45.0	60	✓	✓	TRUE		
			47.8	60	✓	✓			
			49.7	60	✓	✓			
			62.8	75	✓	✓			
			1360 × 768	47.7	60	✓		✓	
	WXGA+	1280 × 800	1366 × 768	47.7	60	✓	Intelligent Compression		
			1440 × 900	55.9	60	✓			
SXGA	1152 × 864	1152 × 864	67.5	75	✓				
		1280 × 960	60.0	60	✓				
		1280 × 1024	64.0	60	✓				
		80.0	75	✓					
SXGA+	1400 × 1050	65.3	60	✓	✓				
WSXGA+	1680 × 1050	65.3	60	✓	✓				
UXGA	1600 × 1200	75.0	60	✓	✓				
MAC 13"	VGA	640 × 480	34.9	67	✓	Upscale		Upscale	
MAC 16"	SVGA	832 × 624	49.7	75	✓		TRUE		
MAC 19"	XGA	1024 × 768	60.2	75	✓		Intelligent Compression		
MAC 21"	SXGA	1152 × 870	68.7	75	✓	Intelligent Compression	Intelligent Compression		

Note

- Optimum image quality will be achieved by matching your computer's output resolution to the resolution that corresponds to "TRUE" in the "Display" column shown above.
- When "Screen resolution" of the computer is different from the resolution displayed on the projected image, follow the procedures shown below.
 - Make the appropriate adjustments for "Resolution" in "SIG-ADJ".
 - Depending on the computer you are using, the output signal may not be faithful to the "Screen resolution" adjustment. Check the settings of the computer's signal output. If the settings cannot be changed, it is recommended that the resolution be set to the one that corresponds to "TRUE" in the "Display" column.

Compatibility Chart (Continued)

3D Supported Signals

Signal		Horizontal Frequency (kHz)	Vertical Frequency (Hz)	Analog Support	Digital Support
SVGA	800 × 600	37.9	60	✓	✓
		77.1	120	✓	✓
XGA	1024 × 768	48.4	60	✓	✓
		98.6	120	✓	✓
WXGA	1280 × 800	49.7	60	✓	✓
		101.6	120 *1	✓	✓
	1280 × 720	45.0	60	✓	✓
		92.6	120	✓	✓

*1 Reduced Blanking







Note

- Your computer graphics card must be able to display 3D stereoscopic signals. Please check with your computer/graphic card specifications or call your computer manufacturer to ensure this capability.

DTV

Signal	Horizontal Frequency (kHz)	Vertical Frequency (Hz)	Analog Support	Digital Support	Signal	Horizontal Frequency (kHz)	Vertical Frequency (Hz)	Analog Support	Digital Support
480I	15.7	60	✓		1080I	28.1	50	✓	✓
480P	31.5	60	✓	✓	1080I	33.8	60	✓	✓
576I	15.6	50	✓		1080P	56.3	50	✓	✓
576P	31.3	50	✓	✓	1080P	67.5	60	✓	✓
720P	37.5	50	✓	✓					
720P	45.0	60	✓	✓					

Troubleshooting

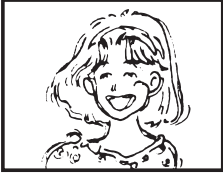
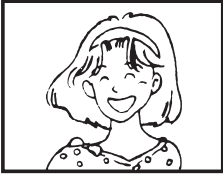
Problem	Check	Page
 No picture and no sound or projector does not start.	<ul style="list-style-type: none"> Projector power cord is not plugged into the wall outlet. 	27
	<ul style="list-style-type: none"> Power to the external connected devices is off. 	–
	<ul style="list-style-type: none"> The selected Input mode is wrong. 	33
	<ul style="list-style-type: none"> The AV Mute function is working. 	33
	<ul style="list-style-type: none"> Cables are incorrectly connected to the projector. 	21–25
	<ul style="list-style-type: none"> Remote control battery has run out. 	16
 Sound is heard but no picture appears (or picture is dark).	<ul style="list-style-type: none"> External output has not been set when connecting notebook computer. When the connected DVI digital equipment is turned on before the “DVI-D” input mode is selected on the projector, the image may not be projected properly or may not be displayed at all. Ensure that the appropriate input mode has been selected and set the input signal type on the projector before you turn on the connected equipment. 	21
	<ul style="list-style-type: none"> The lamp unit cover is not installed correctly. 	67, 68
	<ul style="list-style-type: none"> Cables are incorrectly connected to the projector. “Bright” is set to minimum position. 	21–25 44
 Dark or bluish image	<ul style="list-style-type: none"> Depending on the computer you are using, an image may not be projected unless the signal output setting of the computer is switched to the external output. Refer to the computer's operation manual for how to switch its signal output settings. Is “On” selected in “DLP® Link™”? 	– 58
	<ul style="list-style-type: none"> Check that “Wall Color” is configured correctly. 	50
 Color is faded or poor.	<ul style="list-style-type: none"> Image adjustments are incorrectly set. 	44
	(S-VIDEO, VIDEO Input only) <ul style="list-style-type: none"> Video input system is incorrectly set. 	47
	(COMPUTER/COMPONENT1, 2, COMPONENT, DVI Input only) <ul style="list-style-type: none"> Input signal type (RGB/Component) is incorrectly set. 	44
 Picture is blurred; noise appears.	<ul style="list-style-type: none"> Adjust the focus. 	31
	<ul style="list-style-type: none"> The projection distance exceeds the focus range. When an optional lens is attached, refer to the operation manual of the lens. 	–
	<ul style="list-style-type: none"> There is fog on the lens. If the projector is carried from a cold room into a warm room, or if it is suddenly heated, condensation may form on the surface of the lens and the image will become blurred. Set up the projector at least one hour before it is to be used. If condensation should form, remove the power cord from the wall outlet and wait for it to clear. 	–
	(Computer Input only) <ul style="list-style-type: none"> Perform “SIG-ADJ” Adjustments (“Clock” and “Phase” Adjustment) Turn off the LCD display of the notebook computer. Noise may appear depending on the computer. 	46 –
 Picture appears but no sound is heard.	<ul style="list-style-type: none"> Cables are incorrectly connected to the projector. 	21–25
	<ul style="list-style-type: none"> Volume is set to minimum. When the projector is connected to an external device and the volume is set to minimum, the sound is not output even if you turn up the volume of the external device. 	33
	<ul style="list-style-type: none"> “Speaker” is set to “Off”. The AV Mute function is working. 	53 33

Troubleshooting (Continued)

Problem	Check	Page
Data image is not centered.	<ul style="list-style-type: none"> • Make the necessary adjustments of each item in the "SIG-ADJ" menu. 	46
	<ul style="list-style-type: none"> • Depending on the computer you are using, the output resolution signal may be different from the one you have set. For details, refer to the operation manual of the computer. 	–
An unusual sound is occasionally heard from the cabinet.	<ul style="list-style-type: none"> • If the picture is normal, the sound is due to cabinet shrinkage caused by room temperature changes. This will not affect operation or performance. 	–
Maintenance indicator on the projector illuminates or blinks in red.	<ul style="list-style-type: none"> • See "Maintenance Indicators". 	64
Picture is green on COMPUTER/ COMPONENT1, 2 (Component).	<ul style="list-style-type: none"> • Change the input signal type setting. 	44
Picture is pink (no green) on COMPUTER/ COMPONENT1, 2 or DVI (RGB).		
Picture is too bright and whitish.	<ul style="list-style-type: none"> • Image adjustments are incorrectly set. 	44
The cooling fan becomes noisy.	<ul style="list-style-type: none"> • When temperature inside the projector increases, the cooling fan runs faster. 	8, 9, 64, 65
The lamp does not light up even after the projector turns on.	<ul style="list-style-type: none"> • The LAMP indicator is illuminating in red. Replace the lamp. 	64, 67, 68
The lamp suddenly turns off during projection.		
The image sometimes flickers.	<ul style="list-style-type: none"> • Cables are incorrectly connected to the projector or the connected equipment works improperly. • If this happens frequently, replace the lamp. 	21–25 67
The lamp needs much time to turn on.	<ul style="list-style-type: none"> • The lamp will eventually need to be changed. While the remaining lamp life draws to a close, replace the lamp. 	67
Picture is dark.		
The remote control cannot be used.	<ul style="list-style-type: none"> • Operate the remote control while pointing it at the projector's remote control sensor. • The remote control may be too far away from the projector. • If direct sunlight or a strong fluorescent lamp is shining on the projector's remote control sensor, place the projector where it will not be affected by strong light. 	16
		<ul style="list-style-type: none"> • The batteries may be depleted or inserted incorrectly. Make sure the batteries are inserted correctly or insert new ones.

Problem	Check	Page
3D images flicker when watching in a room.	<ul style="list-style-type: none"> • Images may appear to flicker when fluorescent light or ambient light enters your vision. <ul style="list-style-type: none"> – Turn off the lights. – Block any ambient light. 	–
Ghosting (a double image) occurs without the image appearing in 3D.	<ul style="list-style-type: none"> • Check that you are using 3D LCD shutter glasses that support the DLP® Link™ system. <ul style="list-style-type: none"> – Be sure to use 3D LCD shutter glasses that support the DLP® Link™ system. 	–
	<ul style="list-style-type: none"> • Check that the shutters on the 3D LCD shutter glasses are working properly. <ul style="list-style-type: none"> – Turn the 3D LCD shutter glasses off and then on again. – Check the batteries of the 3D LCD shutter glasses. – Check that the 3D LCD shutter glasses are set to 3D viewing mode. Some 3D LCD shutter glasses are equipped with a special viewing mode (such as “dual view mode”) in addition to the normal 3D viewing mode. See the operation manual of your 3D LCD shutter glasses. 	–
	<ul style="list-style-type: none"> • Check the settings of the projector. <ul style="list-style-type: none"> – Turn the DLP® Link™ function “On”. – Use “DLP® Link™ Invert” to change the setting. 	–
	<ul style="list-style-type: none"> • Check whether a signal that is not supported is being input. <ul style="list-style-type: none"> – Configure your 3D application at the correct resolution and refresh rate. Make sure you are running your 3D application in resolutions that support 3D. To support 3D, your 3D application must be configured to run at the correct settings for this projector. For details on the supported signals, see “3D Supported Signals” of the Compatibility Chart. 	72
	<ul style="list-style-type: none"> • If the projector is connected to a computer for 3D image playback, check that a stereoscopically-enabled application is being used. <ul style="list-style-type: none"> – Use the applicable software. – Set the applicable software to the field sequential format. 	–
	<ul style="list-style-type: none"> • Check that there are no obstructions between the screen and the 3D LCD shutter glasses. <ul style="list-style-type: none"> – Remove any obstructions. Any obstructions may cause the glasses not to function properly causing the lenses to flicker or turn off. Do not place your hand or other objects in front of the 3D control signal sensor on the glasses. 	–
	<ul style="list-style-type: none"> • Check whether there is a source of high intensity lighting nearby. <ul style="list-style-type: none"> – Block the light or turn it off. High intensity lighting can interfere with communication between the 3D LCD shutter glasses and the screen resulting in some flicker. 	–
<ul style="list-style-type: none"> • Check whether two or more projectors are projecting 3D images at the same time. <ul style="list-style-type: none"> – Use only one projector at a time. 	–	

This unit is equipped with a microprocessor. Its performance could be adversely affected by incorrect operation or interference. If this should happen, unplug the Unit and plug it in again after more than 5 minutes.

For SHARP Assistance

If you encounter any problems during setup or operation of this projector, first refer to the “Troubleshooting” section on pages 73 to 75. If this operation manual does not answer your question, please contact the SHARP Service departments listed below.

U.S.A.	Sharp Electronics Corporation 1-888-GO-SHARP (1-888-467-4277) lcdsupport@sharpsec.com http://www.sharpusa.com	Benelux	SHARP Electronics Benelux BV 0900-SHARPC (0900-7427723) Nederland 9900-0159 Belgium http://www.sharp.nl http://www.sharp.be http://www.sharp.lu
Canada	Sharp Electronics of Canada Ltd. (905) 568-7140 http://www.sharp.ca	Australia	Sharp Corporation of Australia Pty. Ltd. 1300-135-022 http://www.sharp.net.au
Mexico	Sharp Electronics Corporation Mexico Branch (525) 716-9000 http://www.sharp.com.mx	New Zealand	Sharp Corporation of New Zealand Phone: (09) 573-0111 Fax: (09) 573-0112 http://www.sharp.net.nz
Latin America	Sharp Electronics Corp. Latin American Group (305) 264-2277 www.servicio@sharpsec.com http://www.sharpla.com	Singapore	Sharp-Roxy Sales (S) Pte. Ltd. 65-226-6556 ckng@srs.global.sharp.co.jp http://www.sharp.com.sg
Germany	Sharp Electronics (Europe) GMBH 01805-234675 http://www.sharp.de	Hong Kong	Sharp-Roxy (HK) Ltd. (852) 2410-2623 dcmktg@srh.global.sharp.co.jp http://www.sharp.com.hk
U.K.	Sharp Electronics (U.K.) Ltd. 08705 274277 http://www.sharp.co.uk/customersupport	Taiwan	Sharp Corporation (Taiwan) 0800-025111 http://www.sharp-scot.com.tw
Italy	Sharp Electronics (Italy) S.P.A. (39) 02-89595-1 http://www.sharp.it	Malaysia	Sharp-Roxy Sales & Service Co. (60) 3-5125678
France	Sharp Electronics France 01 49 90 35 40 hotlined@sef.sharp-eu.com http://www.sharp.fr	U.A.E.	Sharp Middle East Fze 971-4-81-5311 helpdesk@smef.global.sharp.co.jp
Spain	Sharp Electronica Espana, S.A. 93 5819700 sharp lcd@sees.sharp-eu.com http://www.sharp.es	Thailand	Sharp Thebnakorn Co. Ltd. 02-236-0170 svc@stcl.global.sharp.co.jp http://www.sharp-th.com
Switzerland	Sharp Electronics (Schweiz) AG 0041 1 846 63 11 cattaneo@sez.sharp-eu.com http://www.sharp.ch	Korea	Sharp Electronics Incorporated of Korea (82) 2-3660-2002 lcd@sharp-korea.co.kr http://www.sharpkorea.co.kr
Sweden	Sharp Electronics (Nordic) AB (46) 8 6343600 vision.support@sen.sharp-eu.com http://www.sharp.se	India	Sharp Business Systems (India) Limited (91) 11- 6431313 service@sharp-oa.com
Austria	Sharp Electronics (Europe) GMBH Branch Office Austria 0043 1 727 19 123 pogats@sea.sharp-eu.com http://www.sharp.at		

Specifications

Model		XG-PH80W-N	XG-PH80X-N
Display devices		0.65" DLP® Chip	0.7" DLP® Chip
Resolution		WXGA (1280 × 800)	XGA (1024 × 768)
Optional Lens (Standard) (AN-PH818EZ)	F number	F 1.7 – 1.9	
	Zoom	Power, ×1.3 (f = 26.0 – 34.0 mm)	
	Focus	Power	
Lens shift		Power (V : +50% / H : ±10%)	
Input terminals	DVI-D (Compatible with HDCP)	×1	
	Computer/Component (5BNC)	×1	
	Computer/Component (D-sub 15 pin)	×1	
	Component (RCA)	×1 (Y/Pb (Cb)/Pr (Cr))	
	S-Video (mini DIN 4 pin)	×1	
	Video (RCA)	×1	
	Audio (ø3.5 mm stereo minijack)	×3	
	Audio (RCA)	×2 (L/R)	
Output terminals	Computer/Component (D-sub 15 pin)	×1	
	Audio (ø3.5 mm stereo minijack)	×1 (variable audio output)	
	TRIGGER	×1 (DC 12 V output)	
Control and communication terminals	LAN (RJ-45)	×1	
	USB (Type B)	×1	
	RS-232C (D-sub 9 pin)	×1	
Speaker		3 W × 2 (Stereo)	
Projection lamp		280 W × 2 lamps	
Rated voltage		AC 100 – 240 V	
Rated frequency		50/60 Hz	
Input current		7.3 A	
Power consumption (STANDBY Mode: Standard/Eco)		715 W (20.3 W/0.28 W) with AC 100 V 675 W (21.3 W/0.41 W) with AC 240 V	
Operation temperature		41°F to 104°F (+5°C to +40°C)	
Cabinet		Plastic	
Dimensions (main body only) [W × H × D]		19 ⁵⁷ / ₆₄ " × 7 ⁴¹ / ₆₄ " × 15 ¹¹ / ₆₄ " (505 × 194 × 385 mm)	
Weight (approx.)		36.4 lbs. (16.5 kg)	

As a part of policy of continuous improvement, SHARP reserves the right to make design and specification changes for product improvement without prior notice. The performance specification figures indicated are nominal values of production units. There may be some deviations from these values in individual units.

This SHARP projector uses a DLP® chip. This very sophisticated panel contains 1,024,000 (XG-PH80W-N) or 786,432 (XG-PH80X-N) pixels (micromirrors). As with any high technology electronic equipment such as large screen TVs, video systems and video cameras, there are certain acceptable tolerances that the equipment must conform to. This unit has some inactive pixels within acceptable tolerances which may result in inactive dots on the picture screen. This will not affect the picture quality or the life expectancy of the unit.



Dimensions

Units: inches (mm)

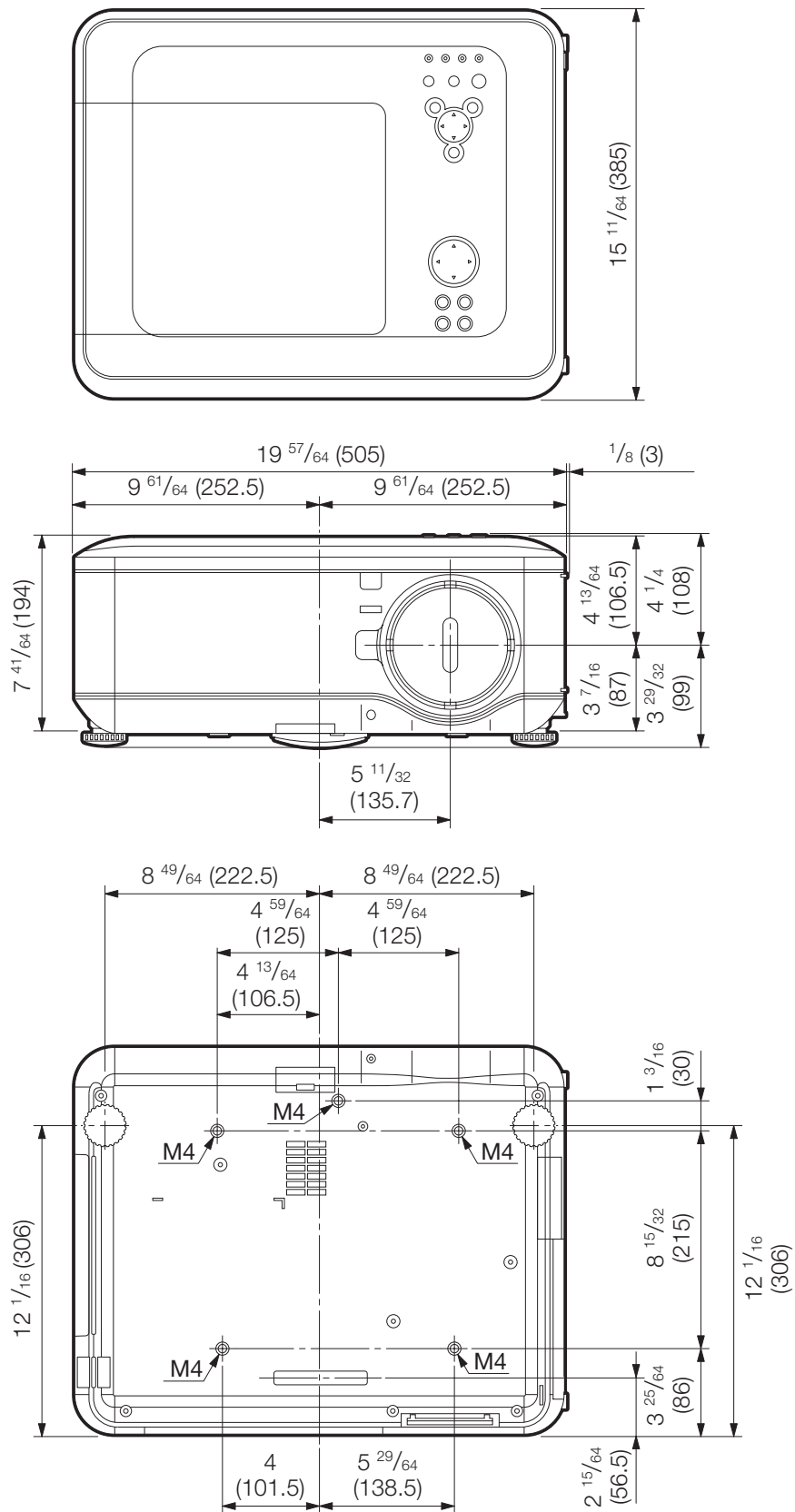

Index

4:3	35	Lamp	66
16:9	34	LAMP indicator	64
3D MODE	54	Lamp Mode	53
3D MODE button	15	Lamp Timer (Life)	55
Accessories	11	Lamp unit	67
AC socket	27	Language (on-screen display language)	49
Adjustment buttons	41, 42	LAN/RS232C	54
Adjustment foot	30	LAN terminal	25
All Reset	55	LENS SHIFT button	30
Apply	54	Link	54
Aspect ratio	34	MENU button	41
AUDIO terminals	21-23	MONITOR OUT terminal	23
AUDIO output terminal	23	Native	35
Auto Power Off	52	Network	54
Auto Restart	52	Normal	34
Auto Search	52	Optional accessories	11
Auto Sync (Auto Sync adjustment)	36, 46	Overscan	47
AUTO SYNC button	36	PAGE DOWN button	37
AV MUTE button	33	PAGE UP button	37
Background	49	Password	51
Batteries	16	PDF	10
Blue	44	Phase	46
Bright	44	Picture Adjustment	43
Bright Boost	44	Picture Mode	43
Clock	46	Power cord	27
Closed Caption	48	POWER indicator	64
CLR Temp (Color Temperature)	44	PRJ-ADJ	52
C.M.S.	45	PRJ Mode	20, 49
Color	44	Red	44
COMPONENT terminal	22	Remote control	15
COMPUTER/COMPONENT1, 2 input terminals	21-23	Remote control sensor	16
Contrast	44	Replacing the lamp	66, 67
DHCP Client	54	Resize	34, 49
DLP® Link™	59	Resolution	46
DLP® Link™ Invert	59	RETURN button	41
DNR	45	RGB cable	21
DNS	54	RS-232C terminal	24
DVI-D terminal	21, 22	SCR-ADJ	49
Dynamic Black	45	Security Lock	51
Eco+Quiet	52	Sharp	44
ENTER button	33	SIG-ADJ	46
Exhaust vent	8, 62	Signal Info	55
Fan Mode	53	Signal Type	44
Film Mode	45	Speaker	53
Filter Message	54	STANDBY Audio Out	53
Filter Timer Reset	55	STANDBY Mode	53
FOCUS buttons	31	STANDBY/ON button	28
FREEZE button	36	Supplied accessories	11
Full	34	S-VIDEO terminal	23
H-Pos	46	TEMP. (temperature warning)/STATUS indicator	64
Image Capture	51	Tint	44
Image Resizing	32, 50	TRIGGER terminal	14
Information	55	USB terminal	37
INPUT modes	33	Video menu	47
Intake vent	8, 62	Video Setup	48
IP Address	54	Video System	47
Kensington Security Standard connector	14	VIDEO terminal	23
KEYBOARD CURSOR buttons	37	VOL (Volume) buttons	33
Keypad lock	51	V-Pos	46
Keystone Correction	32, 50	Wall Color	50
		ZOOM buttons	31

SHARP[®]

SHARP CORPORATION