

SHARP®

DATA PROJECTOR

MODEL

XG-P610X

(Standard zoom lens attached)

XG-P610X-N

(No lens attached)

OPERATION MANUAL

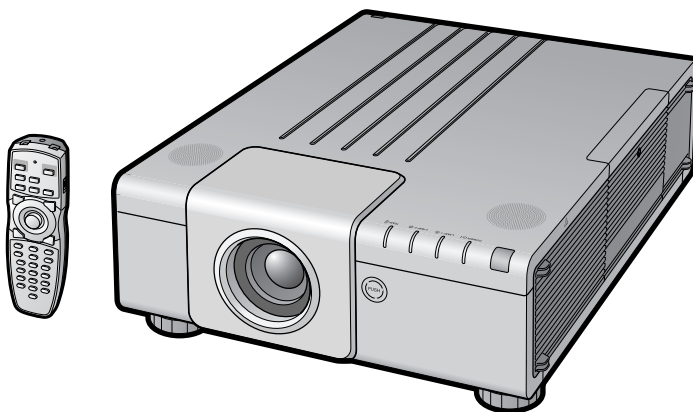

Conference Series



HDMI™
HIGH-DEFINITION MULTIMEDIA INTERFACE

Introduction

Quick Start

Setup

Connections

Basic Operation

Useful Features

Appendix



IMPORTANT

- For your assistance in reporting the loss or theft of your Projector, please record the Model and Serial Numbers located on the side of the projector and retain this information.
- Before recycling the packaging, please ensure that you have checked the contents of the carton thoroughly against the list of "Supplied accessories" on page 11.

Model No.:

Serial No.:

SPECIAL NOTE FOR USERS IN THE U.K.

The mains lead of this product is fitted with a non-rewireable (moulded) plug incorporating a 13A fuse. Should the fuse need to be replaced, a BSI or ASTA approved BS 1362 fuse marked  or  and of the same rating as above, which is also indicated on the pin face of the plug, must be used.

Always refit the fuse cover after replacing the fuse. Never use the plug without the fuse cover fitted.

In the unlikely event of the socket outlet in your home not being compatible with the plug supplied, cut off the mains plug and fit an appropriate type.

DANGER:

The fuse from the cut-off plug should be removed and the cut-off plug destroyed immediately and disposed of in a safe manner. Under no circumstances should the cut-off plug be inserted elsewhere into a 13A socket outlet, as a serious electric shock may occur.

To fit an appropriate plug to the mains lead, follow the instructions below:

WARNING:

THIS APPARATUS MUST BE EARTHED.

IMPORTANT:

The wires in this mains lead are coloured in accordance with the following code:

Green-and-yellow : Earth
Blue : Neutral
Brown : Live

As the colours of the wires in the mains lead of this apparatus may not correspond with the coloured markings identifying the terminals in your plug proceed as follows:

- The wire which is coloured green-and-yellow must be connected to the terminal in the plug which is marked by the letter E or by the safety earth symbol  or coloured green or green-and-yellow.
- The wire which is coloured blue must be connected to the terminal which is marked with the letter N or coloured black.
- The wire which is coloured brown must be connected to the terminal which is marked with the letter L or coloured red.

IF YOU HAVE ANY DOUBT, CONSULT A QUALIFIED ELECTRICIAN.

The supplied CD-ROM contains operation instructions in English, German, French, Spanish, Italian, Dutch, Swedish, Portuguese, Chinese, Korean and Japanese. Carefully read through the operation instructions before operating the projector.

Die mitgelieferte CD-ROM enthält Bedienungsanleitungen in Englisch, Deutsch, Französisch, Spanisch, Italienisch, Niederländisch, Schwedisch, Portugiesisch, Chinesisch, Koreanisch und Japanisch. Bitte lesen Sie die Bedienungsanleitung vor der Verwendung des Projektors sorgfältig durch.

Le CD-ROM fourni contient les instructions de fonctionnement en anglais, allemand, français, espagnol, italien, néerlandais, suédois, portugais, chinois, coréen et japonais. Veuillez lire attentivement ces instructions avant de faire fonctionner le projecteur.

El CD-ROM suministrado contiene instrucciones de operación en inglés, alemán, francés, español, italiano, holandés, sueco, portugués, chino, coreano y japonés. Lea cuidadosamente las instrucciones de operación antes de utilizar el proyector.

Il CD-ROM in dotazione contiene istruzioni per l'uso in inglese, tedesco, francese, spagnolo, italiano, olandese, svedese, portoghese, cinese, coreano e giapponese. Leggere attentamente le istruzioni per l'uso prima di usare il proiettore.

De meegeleverde CD-ROM bevat handleidingen in het Engels, Duits, Frans, Spaans, Italiaans, Nederlands, Zweeds, Portugees, Chinees, Koreaans en Japans. Lees de handleiding zorgvuldig door voor u de projector in gebruik neemt.

Den medföljande CD-ROM-skivan innehåller bruksanvisningar på engelska, tyska, franska, spanska, italienska, holländska, svenska, portugisiska, kinesiska, koreanska och japanska. Läs noga igenom bruksanvisningen innan projektorn tas i bruk.

O CD-ROM fornecido contém instruções de operação em Inglês, Alemão, Francês, Espanhol, Italiano, Holandês, Sueco, Português, Chinês, Coreano e Japonês. Leia cuidadosamente todas as instruções de operação antes de operar o projetor.

附送之CD-ROM光碟中，有用英文、德文、法文、西班牙文、意大利文、荷蘭文、瑞典文、葡萄牙文、中文、韓國文和日文所寫的使用說明書。在操作本投影機之前，請務必仔細閱讀整本使用說明書。

제공된 CD-ROM에는 영어, 독일어, 프랑스어, 스페인어, 이탈리아어, 네덜란드어, 스웨덴어, 포르투갈어, 중국어, 한국어, 일본어로 작성된 조작 설명서가 수록되어 있습니다. 프로젝터를 조작하기 전에 조작 지침을 상세하게 숙지하십시오.

本機に付属のCD-ROMには、英語・ドイツ語・フランス語・スペイン語・イタリア語・オランダ語・スウェーデン語・ポルトガル語・中国語・韓国語・日本語の取扱説明書が収録されています。本機をご使用の前に、この取扱説明書をよくお読みください。

Before using the projector, please read this operation manual carefully.

Introduction

ENGLISH

There are two important reasons for prompt warranty registration of your new SHARP Projector, using the REGISTRATION CARD packed with the projector.

1. WARRANTY

This is to assure that you immediately receive the full benefit of the parts, service and labor warranty applicable to your purchase.

2. CONSUMER PRODUCT SAFETY ACT

To ensure that you will promptly receive any safety notification of inspection, modification, or recall that SHARP may be required to give under the 1972 Consumer Product Safety Act, PLEASE READ CAREFULLY THE IMPORTANT "LIMITED WARRANTY" CLAUSE.



U.S.A. ONLY

WARNING: High brightness light source. Do not stare into the beam of light, or view directly. Be especially careful that children do not stare directly into the beam of light.



WARNING: To reduce the risk of fire or electric shock, do not expose this product to rain or moisture.

See side of projector.

	CAUTION RISK OF ELECTRIC SHOCK. DO NOT REMOVE SCREWS EXCEPT SPECIFIED USER SERVICE SCREW.	
CAUTION: TO REDUCE THE RISK OF ELECTRIC SHOCK, DO NOT REMOVE COVER. NO USER-SERVICEABLE PARTS EXCEPT LAMP UNIT. REFER SERVICING TO QUALIFIED SERVICE PERSONNEL.		



The lightning flash with arrowhead symbol, within an equilateral triangle, is intended to alert the user to the presence of uninsulated "dangerous voltage" within the product's enclosure that may be of sufficient magnitude to constitute a risk or electric shock to persons.



The exclamation point within a triangle is intended to alert the user to the presence of important operating and maintenance (servicing) instructions in the literature accompanying the product.

WARNING: FCC Regulations state that any unauthorized changes or modifications to this equipment not expressly approved by the manufacturer could void the user's authority to operate this equipment.

U.S.A. ONLY

INFORMATION

This equipment has been tested and found to comply with the limits for a Class A digital device, pursuant to Part 15 of the FCC Rules. These limits are designed to provide reasonable protection against harmful interference when the equipment is operated in a commercial environment. This equipment generates, uses, and can radiate radio frequency energy and, if not installed and used in accordance with the operation manual, may cause harmful interference to radio communications. Operation of this equipment in a residential area is likely to cause harmful interference, in which case the user will be required to correct the interference at his own expense.

U.S.A. ONLY

The enclosed computer cable must be used with the device. The cable is provided to ensure that the device complies with FCC Class A verification.

U.S.A. ONLY

WARNING:

This is a Class A product. In a domestic environment this product may cause radio interference in which case the user may be required to take adequate measures.

PRODUCT DISPOSAL

This product utilizes tin-lead solder, and lamp containing a small amount of mercury. Disposal of these materials may be regulated due to environmental considerations. For disposal or recycling information, please contact your local authorities, the Electronics Industries Alliance: www.eiae.org, the lamp recycling organization www.lamprecycle.org, or Sharp at 1-800-BE-SHARP.

U.S.A. ONLY

Caution Concerning Lamp Replacement

See "Replacing the Lamp" on page 71.

This SHARP projector uses a DLP® chip. This very sophisticated panel contains 786,432 pixels (micromirrors). As with any high technology electronic equipment such as large screen TVs, video systems and video cameras, there are certain acceptable tolerances that the equipment must conform to.

This unit has some inactive pixels within acceptable tolerances which may result in inactive dots on the picture screen. This will not affect the picture quality or the life expectancy of the unit.

- DLP® and the DLP logo are registered trademarks of Texas Instruments.
- Microsoft® and Windows® are registered trademarks of Microsoft Corporation in the United States and/or other countries.
- PC/AT is a registered trademark of International Business Machines Corporation in the United States.
- Adobe® Reader® is a trademark of Adobe Systems Incorporated.
- Macintosh® is a registered trademark of Apple Computer, Inc. in the United States and/or other countries.
- HDMI, the HDMI logo and High-Definition Multimedia Interface are trademarks or registered trademarks of HDMI Licensing LLC.
- All other company or product names are trademarks or registered trademarks of their respective companies.
- Some IC chips in this product include confidential and/or trade secret property belonging to Texas Instruments. Therefore you may not copy, modify, adapt, translate, distribute, reverse engineer, reverse assemble or discompile the contents thereof.

Authorized representative responsible for the European Union Community Market

SHARP ELECTRONICS (Europe) GmbH
Sonninstraße 3, D-20097 Hamburg

E.U. ONLY

How to Read This Operation Manual

- In this operation manual, the illustrations and on-screen displays are simplified for explanation. This may differ from the actual on-screen display.

Using the Menu Screen

Buttons used in this operation

Buttons used in this operation

Menu Selections

• This operation can also be performed by using the buttons on the projector.

1 Press **MENU**.

- The "Picture" menu screen for the selected input mode is displayed.

2 Press **◀** or **▶** to display the other menu items.

Menu items

• Menu items are as shown below.

Menu Item
Picture
CNR
File Type
Audio
Options 1
Options 2
Language
Status

Note

- The "Fine Sync" menu is not available for VIDEO or S-VIDEO.

Example: "Picture" screen menu for **COMPUTER1 (RGB) mode**

On-screen display

Useful Features

© 47

InfoIndicates safeguards when using the projector.

NoteIndicates additional information for setting up and operating the projector.

For Future Reference

Maintenance

Troubleshooting

Index

➔ **Page 66**

➔ **Pages 79 and 80**

➔ **Page 83**

Contents

Preparing

Introduction

How to Read This Operation Manual	3	Using the Remote Control	16
Contents	4	Usable Range	16
How to Access the PDF		Inserting the Batteries	16
Operation Manuals	7	Using the Remote Control with	
IMPORTANT SAFEGUARDS	8	a Signal Cable	17
Accessories	11	Switching the Remote Control Mode	17
Part Names and Functions	13	Using the Remote Control as	
		a Wireless Computer Mouse	18

Quick Start

Quick Start	19
--------------------------	-----------

Setup

Setting Up the Projector	21
Setting Up the Projector	21
Standard Zoom Lens (AN-P18EZ : Standard	
Equipment with XG-P610X)	22
Projecting a Reversed Image	23

Connections

Connecting the Projector to Other	
Equipment	24
Controlling the Projector by a Computer ...	27

Using

Basic Operation

Turning the Projector On/Off	28	Correcting Trapezoidal Distortion	32
Connecting the Power Cord	28	Switching the Input Mode	36
Turning the Projector On	28	Adjusting the Volume	36
Turning the Power Off (Putting the Projector		Turning Off the Sound Temporarily	37
into Standby Mode)	28	Displaying an Enlarged Portion of an Image	37
Image Projection	29	Freezing a Moving Image	38
Shifting the Lens	29	Selecting the Picture Mode	38
Using the Adjustment Feet	30	Resize Mode	39
Adjusting the Focus	31	Hiding the Projected Image	
Adjusting the Projected Image Size	31	(Shutter function)	41
		Displaying and Setting the Break Timer	41

Useful Features

Menu Items	42
Using the Menu Screen	47
Menu Selections	47
Picture Adjustment (“Picture” menu)	49
Selecting the Picture Mode	49
Adjusting the Image	49
Adjusting the Color Temperature	50
Selecting the Progressive Mode	50
Reducing Image Noise (DNR)	50
Selecting the Signal Type	51
Selecting the Dynamic Range	51
Selecting the Color Space	51
Color Management System	
(“C. M. S.” menu)	52
Selecting the Color Reproduction Mode	52
Selecting the Target Color	52
Setting the Brightness of the Target Color	52
Setting the Chromatic Value of	
the Target Color	52
Setting the Hue of the Target Color	52
Resetting User-defined Color Settings	52
Overview of All Color Settings	52
Computer Image Adjustment	
(“Fine Sync” menu)	53
Adjusting the Computer Image	53
Saving Adjustment Settings	53
Accessing Adjustment Settings	53
Setting the Resolution	53
Checking the Input Signal	54
Auto Sync Adjustment	54
Setting the Auto Sync Display Function	54
Audio Adjustment (“Audio” menu)	55
Adjusting the Audio	55
Setting the Audio Output Type	55
Setting the Speaker	55
Using the “Options 1” Menu	56
Displaying Dual Pictures (Pict in Pict)	56
Setting the Resize Mode	56
Shifting the Projected Image Vertically	
(Digital Shift)	57
Setting On-screen Display	57
Setting the Video System	57
Capturing Projected Images	57
Selecting the Background Image	58
Selecting the Startup Image	58
Setting the Eco Mode	58
Detecting the Input Signals Automatically	58
Setting the Auto Power Off Function	58
Setting the System Lock Function	59
Helpful Functions Set during Installation	
(“Options 2” menu)	61
Setting a Password	61
Setting the Lamp Mode	62
Selecting the Lens Type	62
Reversing/Inverting Projected Images	62
Controlling Multiple Projectors with the One	
Remote Control	62
Shortcut to Make Projector Stack Settings	63
Locking the Operation Buttons	
on the Projector	63
Bypassing Unused Input Selections	63
Selecting the Fan Mode	63
Setting the Auto Restart Function	63
Selecting the Transmission Speed	
(RS-232C)	64
Setting the Monitor Output	64
Setting the LAN/RS232C	64
Setting the DHCP Client	64
Helpful Functions Set during Installation	
(“Options 2” menu)/Using the Other Menus	
(“Language” and “Status” menus)	65
Setting the TCP/IP	65
Service Mode	65
Returning to the Default Settings	65
Selecting the On-screen Display Language	65
Overview of All Menu Settings and the Lamp Life	65

Reference

Appendix

Maintenance	66
Cleaning and Replacing the Dust Filters ...	67
Cleaning the Dust Filters	67
Replacing the Dust Filters	68
Maintenance Indicators	69
Regarding the Lamp	71
Lamp	71
Caution Concerning the Lamp	71
Replacing the Lamp	71
Removing and Installing the Lamp Unit	72
Resetting the Lamp Timer	74
Computer Compatibility Chart	75
Attaching the Optional Lens	77
Troubleshooting	79
For SHARP Assistance	81
Specifications	82
Index	83

The optional lenses are introduced on page 12. Please purchase the lens for your desired usage.

SETUP MANUAL

Refer to the “SETUP MANUAL” contained on the supplied CD-ROM for details.

Setting up the Screen	2	Controlling the Projector Using RS-232C	
Screen Size and Projection Distance	3	or Telnet	34
Connecting Pin Assignments	11	Stack Projection	41
Wired Remote Control Terminal		Video Wall Projection	44
Specifications	13	Resetting the Lamp Timer of the Projector	
RS-232C Specifications and Commands ...	14	via LAN	53
Setting up the Projector Network		Troubleshooting	55
Environment	20	Dimensions	58
Controlling the Projector via LAN	26		
Setting the Projector Using			
RS-232C or Telnet	31		

How to Access the PDF Operation Manuals

PDF operation manuals in several languages are included in the CD-ROM, so that you can work with the projector. To utilize these manuals, you need to install Adobe® Reader® on your computer (Windows® or Macintosh®).

Please download Adobe® Reader® from the Internet (<http://www.adobe.com>).

Accessing the PDF manuals

For Windows®:

- ① Insert the CD-ROM in the CD-ROM drive.
- ② Double click the “My Computer” icon.
- ③ Double click the “CD-ROM” drive.
- ④ **When you want to view the operation manual**
 - 1) Double click the “MANUALS” folder.
 - 2) Double click the language (name of the folder) that you want to view.
 - 3) Double click the pdf file to access the projector manuals.

When you want to view the setup manual

- 1) Double click the “SETUP” folder.
- 2) Double click the language (name of the folder) that you want to view.
- 3) Double click the pdf file to access the SETUP MANUAL.

For Macintosh®:

- ① Insert the CD-ROM in the CD-ROM drive.
- ② Double click the “CD-ROM” icon.
- ③ **When you want to view the operation manual**
 - 1) Double click the “MANUALS” folder.
 - 2) Double click the language (name of the folder) that you want to view.
 - 3) Double click the pdf file to access the projector manuals.

When you want to view the setup manual

- 1) Double click the “SETUP” folder.
- 2) Double click the language (name of the folder) that you want to view.
- 3) Double click the pdf file to access the SETUP MANUAL.

Info

- If the desired pdf file cannot be opened by double clicking the mouse, start Adobe® Reader® first, then specify the desired file using the “File”, “Open” menu.

IMPORTANT SAFEGUARDS

CAUTION: Please read all of these instructions before you operate this product and save these instructions for later use.

Electrical energy can perform many useful functions. This product has been engineered and manufactured to assure your personal safety. BUT IMPROPER USE CAN RESULT IN POTENTIAL ELECTRICAL SHOCK OR FIRE HAZARDS. In order not to defeat the safeguards incorporated in this product, observe the following basic rules for its installation, use and servicing.

1. Read Instructions

All the safety and operating instructions should be read before the product is operated.

2. Retain Instructions

The safety and operating instructions should be retained for future reference.

3. Heed Warnings

All warnings on the product and in the operating instructions should be adhered to.

4. Follow Instructions

All operating and use instructions should be followed.

5. Cleaning

Unplug this product from the wall outlet before cleaning. Do not use liquid cleaners or aerosol cleaners. Use a damp cloth for cleaning.

6. Attachments

Do not use attachments not recommended by the product manufacturer as they may cause hazards.

7. Water and Moisture

Do not use this product near water—for example, near a bath tub, wash bowl, kitchen sink, or laundry tub; in a wet basement; or near a swimming pool; and the like.

8. Accessories

Do not place this product on an unstable cart, stand, tripod, bracket, or table. The product may fall, causing serious injury to a child or adult, and serious damage to the product. Use only with a cart, stand, tripod, bracket, or table recommended by the manufacturer, or sold with the product. Any mounting of the product should follow the manufacturer's instructions, and should use a mounting accessory recommended by the manufacturer.

9. Transportation

A product and cart combination should be moved with care. Quick stops, excessive force, and uneven surfaces may cause the product and cart combination to overturn.



10. Ventilation

Slots and openings in the cabinet are provided for ventilation to ensure reliable operation of the product and to protect it from overheating, and these openings must not be blocked or covered. The openings should never be blocked by placing the product on a bed, sofa, rug, or other similar surface. This product should not be placed in a built-in installation such as a bookcase or rack unless proper ventilation is provided or the manufacturer's instructions have been adhered to.

11. Power Sources

This product should be operated only from the type of power source indicated on the marking label. If you are not sure of the type of power supply to your home, consult your product dealer or local power company. For products intended to operate from battery power, or other sources, refer to the operating instructions.

12. Grounding or Polarization

This product is provided with one of the following types of plugs. If the plug should fail to fit into the power outlet, please contact your electrician.

Do not defeat the safety purpose of the plug.

- Two-wire type (mains) plug.
- Three-wire grounding type (mains) plug with a grounding terminal.
This plug will only fit into a grounding type power outlet.

13. Power-Cord Protection

Power-supply cords should be routed so that they are not likely to be walked on or pinched by items placed upon or against them, paying particular attention to cords at plugs, convenience receptacles, and the point where they exit from the product.

14. Lightning

For added protection for this product during a lightning storm, or when it is left unattended and unused for long periods of time, unplug it from the wall outlet and disconnect the cable system. This will prevent damage to the product due to lightning and power-line surges.

15. Overloading

Do not overload wall outlets, extension cords, or integral convenience receptacles as this can result in a risk of fire or electric shock.

16. Object and Liquid Entry

Never push objects of any kind into this product through openings as they may touch dangerous voltage points or short-out parts that could result in a fire or electric shock. Never spill liquid of any kind on the product.

17. Servicing

Do not attempt to service this product yourself as opening or removing covers may expose you to dangerous voltage or other hazards. Refer all servicing to qualified service personnel.

18. Damage Requiring Service

Unplug this product from the wall outlet and refer servicing to qualified service personnel under the following conditions:

- When the power-supply cord or plug is damaged.
- If liquid has been spilled, or objects have fallen into the product.
- If the product has been exposed to rain or water.
- If the product does not operate normally by following the operating instructions. Adjust only those controls that are covered by the operating instructions, as an improper adjustment of other controls may result in damage and will often require extensive work by a qualified technician to restore the product to normal operation.
- If the product has been dropped or damaged in any way.
- When the product exhibits a distinct change in performance, this indicates a need for service.

19. Replacement Parts

When replacement parts are required, ensure that the service technician has used replacement parts specified by the manufacturer or have the same characteristics as the original part. Unauthorized substitutions may result in fire, electric shock, or other hazards.

20. Safety Check

Upon completion of any service or repairs to this product, ask the service technician to perform safety checks to determine that the product is in proper operating condition.

21. Wall or Ceiling Mounting

This product should be mounted to a wall or ceiling only as recommended by the manufacturer.

22. Heat

This product should be situated away from heat sources such as radiators, heat registers, stoves, or other products (including amplifiers) that produce heat.

Ensure that you read the following safeguards when setting up your projector.

Caution concerning the lamp unit

- Potential hazard of glass particles if lamp ruptures. In case of lamp rupture, contact your nearest Sharp Authorized Projector Dealer or Service Center for replacement. See “Regarding the Lamp” on page 71.

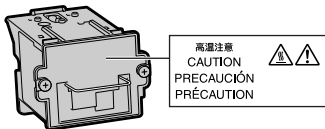

Caution concerning the setup of the projector

- For minimal servicing and to maintain high image quality, SHARP recommends that this projector be installed in an area free from humidity, dust and cigarette smoke. When the projector is subjected to these environments, the vents and lens must be cleaned more often. As long as the projector is regularly cleaned, use in these environments will not reduce the overall operation life of the unit. Internal cleaning should only be performed by a Sharp Authorized Projector Dealer or Service Center.

Do not set up the projector in places exposed to direct sunlight or bright light.

- Position the screen so that it is not in direct sunlight or room light. Light falling directly on the screen washes out the colors, making viewing difficult. Close the curtains and dim the lights when setting up the screen in a sunny or bright room.

The projector may be safely tilted to a maximum angle of 9 degrees.

- Placement should be within 9 degrees of horizontal. If you have application requiring tilt angle exceeding 9 degrees, please check with your local Sharp sales office.

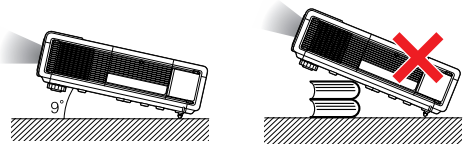

When using the projector in high-altitude areas such as mountains (at altitudes of approximately 1,500 meters (4,900 feet) or more)

- When you use the projector in high-altitude areas with thin air, set “Fan Mode” to “High”. Neglecting this can affect the longevity of the optical system.

Warning about placing the projector in a high position

- When placing the projector in a high position, make certain it is carefully secured to avoid personal injury caused by the projector falling down.

Do not subject the projector to hard impact and/or vibration.

- Take care with the lens so as not to hit or damage the surface of the lens.

Rest your eyes occasionally.

- Continuously watching the screen for long hours will cause eye strain. Take regular breaks to rest your eyes.

Avoid locations with extremes of temperature.

- The operating temperature of the projector is from 41°F to 104°F (+5°C to +40°C).
- The storage temperature of the projector is from -4°F to 140°F (-20°C to +60°C).

IMPORTANT SAFEGUARDS

Do not block the intake and exhaust vents.

- Allow at least 11 ¹³/₁₆ inches (30 cm) of space between the exhaust vent and the nearest wall or obstruction.
- Set up the projector where air will not stay near its exhaust vent. In order to avoid allowing the heat from the exhaust vent to enter the intake vent area, leave at least more than 11 ¹³/₁₆ inches (30 cm) of space between the intake vent and the surrounding walls or objects.
- If the cooling fan becomes obstructed, a protection circuit will automatically put the projector into standby mode to prevent overheat damage. This does not indicate a malfunction (See pages 69 and 70.). Remove the projector power cord from the wall outlet and wait at least 10 minutes. Place the projector where the intake and exhaust vents are not blocked, plug the power cord back in and turn on the projector. This will return the projector to the normal operating condition.

Caution regarding usage of the projector

- When using the projector, take care not to subject it to hard impact and/or vibration, as this can result in damage. Take extra care with the lens. If you are not to use the projector for a long time, make certain you unplug the power cord from the wall outlet, and disconnect any other cables connected to it.
- Do not carry the projector by holding the lens.
- When storing the projector, ensure you attach the lens cap or dustproof cap to the projector. (See page 13.)
- Do not expose the projector to direct sunlight or near heat sources. The projector may change color or become deformed.

Other connected equipment

- When connecting a computer or other audio-visual equipment to the projector, make the connections AFTER unplugging the power cord of the projector from the AC outlet and turning off the equipment to be connected.
- Please read the operation manuals of the projector and the equipment to be connected for instructions on how to make the connections.

Using the projector in other countries

- The power supply voltage and the shape of the plug may vary depending on the region or country you are using the projector in. When using the projector overseas, make sure you use an appropriate power cord for the country you are in.

Temperature monitor function

- If the projector starts to over-heat due to setup problems or blockage of the air vents, “” and “TEMP.” will illuminate in the lower left corner of the picture. If the temperature continues to rise, the lamp will turn off, the temperature warning indicator on the projector will blink, and after a 90-second cooling-off period the projector will enter the standby mode. Refer to “Maintenance Indicators” on page 69 for details.



Info

- The cooling fan regulates the internal temperature, and its performance is automatically controlled. The sound of the fan may change during projector operation due to changes in the fan speed. This does not indicate malfunction.
- Even if you unplug the power cord after projector operation, the cooling fan continues to run for a while. When you place the projector into the storage case, make sure that the cooling fan has stopped.

Optional lens installation

- For installing an optional lens, refer to “Attaching the Optional Lens” on page 77 or the lens installation manual (supplied with the optional lens).
- Remove the optional lens when carrying the projector. Carrying the projector with an optional lens attached can cause the projector to be damaged by vibration or other factors.

Supplied accessories



Remote control
<9NK5041816900>



Two R-6 batteries
("AA" size, UM/SUM-3, HP-7 or similar)

Power cord*

(1)



For U.S., Canada, etc.
(6' (1.8 m))
<9NK3090204900>

(2)

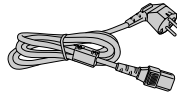

For Europe, except U.K.
(6' (1.8 m))
<9NK3090152700>

(3)

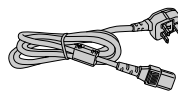

For U.K., Hong Kong
and Singapore
(6' (1.8 m))
<9NK3090152900>

(4)

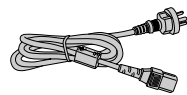

For Australia, New
Zealand and Oceania
(6' (1.8 m))
<9NK3090152600>

* Use the power cord that corresponds to the wall outlet in your country.

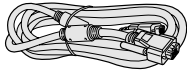

RGB cable
(10' (3.0 m))
<9NK3080431000>



Lens cap
(Only supplied with XG-P610X)
<9NK3392072800>

Dustproof cap
(Only supplied with XG-P610X-N)
<9NK3392072900>

- Projector manual and technical reference CD-ROM
<9NK3534059900>
- Operation manual (this manual)
<9NK5010071200>

Note

- Codes in "< >" are Replacement parts codes.
- When the lens is attached, use the lens cap supplied with the lens.
- You can attach the dustproof cap to the projector only when no lens is attached. (Do not attach the dustproof cap when the lens is attached.)

Optional accessories

■ Lamp unit	AN-P610LP
■ Ceiling-mount adaptor	AN-P610T
■ Ceiling-mount unit	AN-TK201
	AN-TK202
■ Remote receiver	AN-MR2
■ 3 RCA to mini D-sub 15 pin cable (10' (3.0 m))	AN-C3CP2

Note

- Some of the optional accessories may not be available depending on the region. Please check with your nearest Sharp Authorized Projector Dealer or Service Center.

Optional lenses

■ Lens		Projection distance for 100" screen size
Fixed wide lens (× 0.8)	AN-P8EX	5'4" (1.6 m)
Fixed wide lens (× 1.2)	AN-P12EX	8' (2.4 m)
Wide-zoom lens (× 1.5 – 1.8)	AN-P15EZ	10' – 12' (3.0 m – 3.7 m)
Standard zoom lens (× 1.8 – 2.25) (attached to XG-P610X)	AN-P18EZ	12' – 15' (3.7 m – 4.6 m)
Tele-zoom lens (× 2.25 – 3.0)	AN-P23EZ	15' – 20' (4.6 m – 6.1 m)
Tele-zoom lens (× 3.0 – 4.5)	AN-P30EZ	20' – 30' (6.1 m – 9.1 m)
Tele-zoom lens (× 4.5 – 7.0)	AN-P45EZ	30' – 46'8" (9.1 m – 14.2 m)

No lens is attached to XG-P610X-N. The standard zoom lens is attached to XG-P610X. The optional lenses from Sharp are also available for specialized application. Please see your nearest Sharp Authorized Projector Dealer for details on all the lenses. (Refer to the lens operation manual when using a lens.)

Throw Distance

The graph below is for 100-inch (254 cm) screen with 4:3 normal mode.

Screen

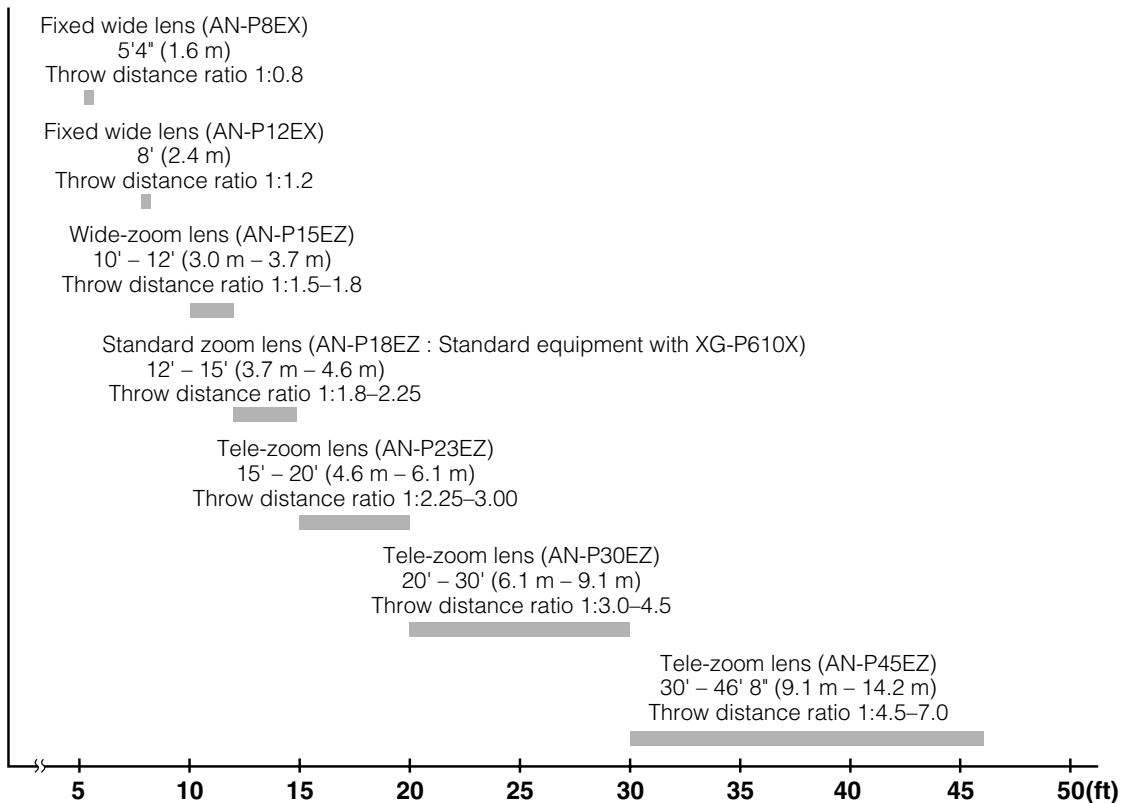

Part Names and Functions

Numbers in refer to the main pages in this operation manual where the topic is explained.

Projector

Rear View

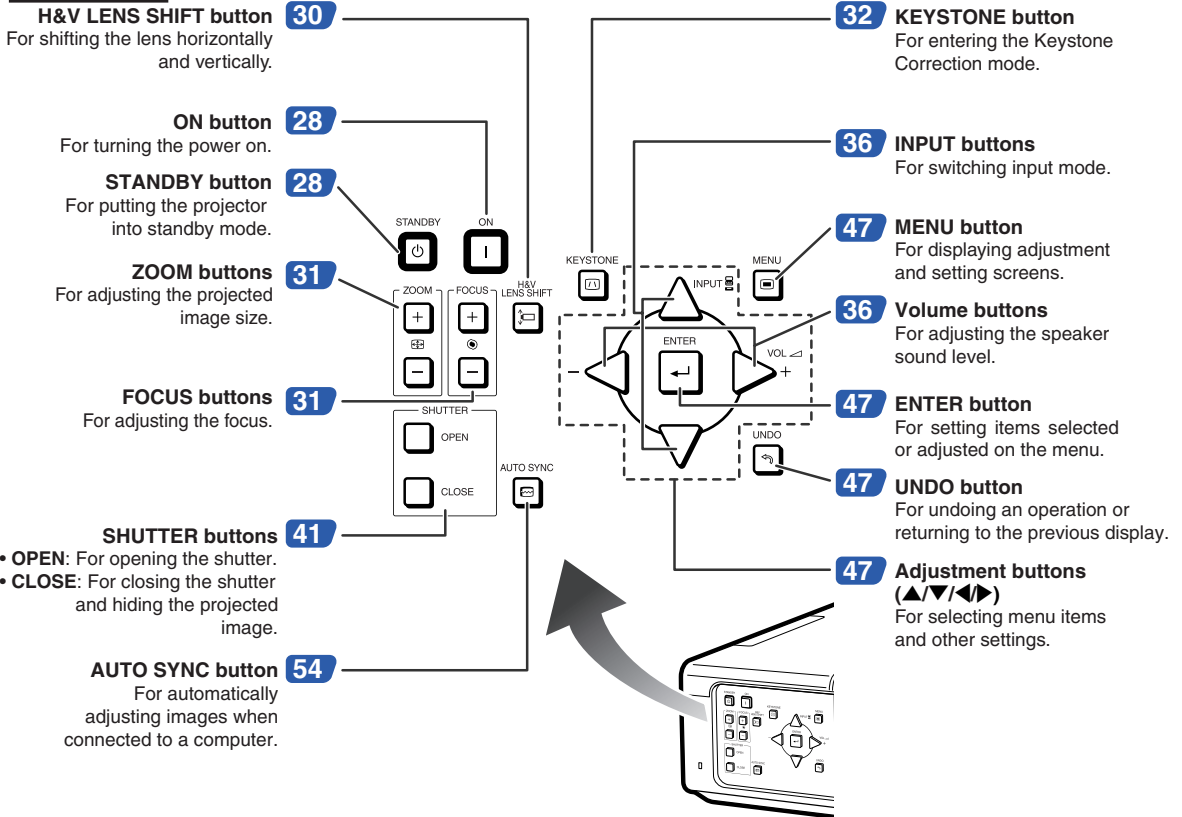

Front View

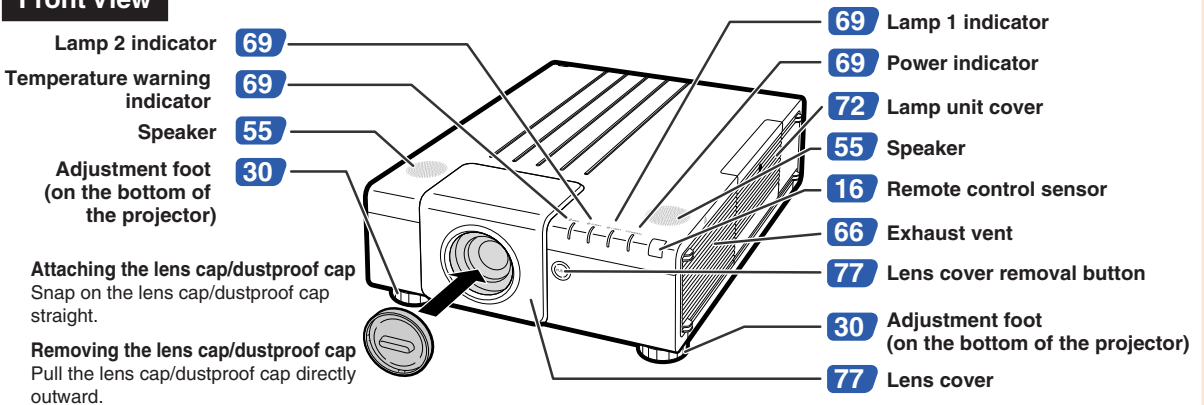

Numbers in refer to the main pages in this operation manual where the topic is explained.

Projector (Rear View)

Terminals Refer to “Connecting the Projector to Other Equipment” on pages 24–26.

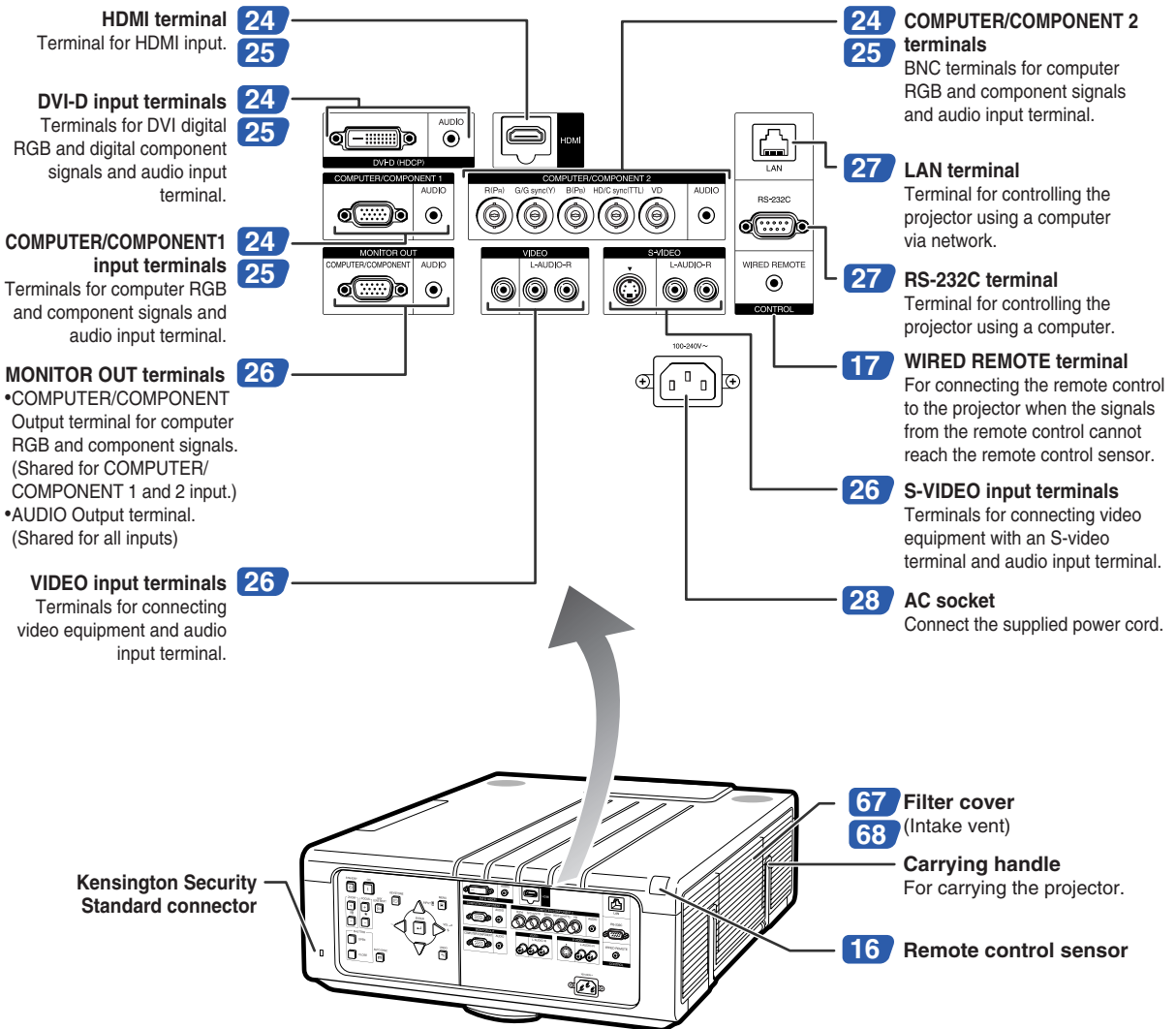

Using the Kensington Lock

- This projector has a Kensington Security Standard connector for use with a Kensington MicroSaver Security System. Refer to the information that came with the system for instructions on how to use it to secure the projector.

Numbers in  refer to the main pages in this operation manual where the topic is explained.

Remote Control

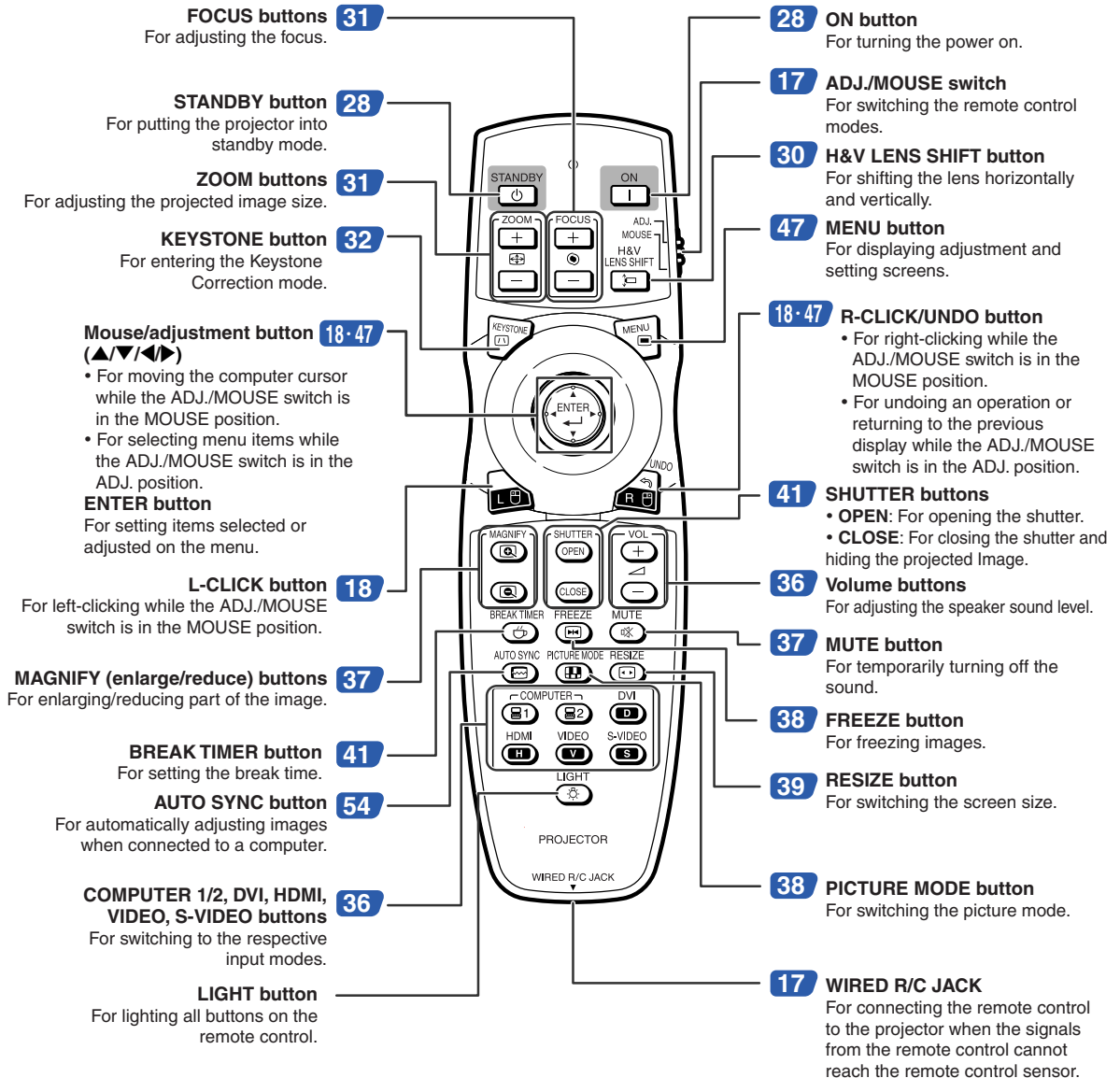

Note

- The **LIGHT** button on the remote control is made of luminous material that is visible in the dark. Visibility will diminish over time. Exposure to light will recharge the luminous buttons.

Using the Remote Control

Usable Range

The remote control can be used to control the projector within the ranges shown in the illustration.

Note

- The signal from the remote control can be reflected off a screen for easy operation. However, the effective distance of the signal may differ depending on the screen material.

When using the remote control:

- Ensure that you do not drop it or expose it to moisture or high temperature.
- The remote control may malfunction under a fluorescent lamp. In this case, move the projector away from the fluorescent lamp.

Inserting the Batteries

1 Press the tab and lift open the battery cover in the direction of the arrow.

2 Insert the batteries.

- Insert the batteries making sure the polarities correctly match the \oplus and \ominus marks inside the battery compartment.

3 Insert the tabs on the end of the battery cover into their slots and press the cover into position.

Front View

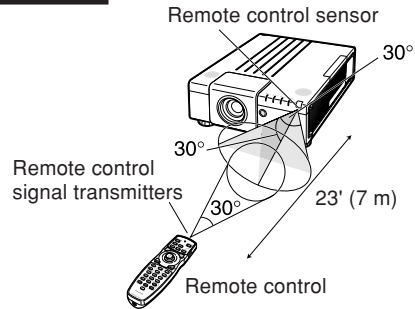

Rear View

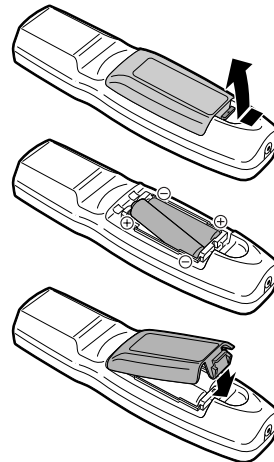
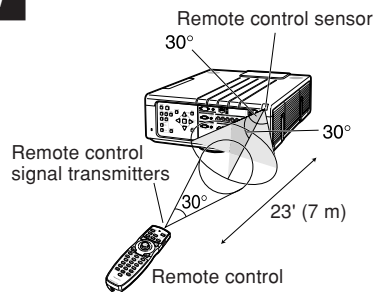

Incorrect use of the batteries may cause them to leak or explode. Please follow the precautions below.

Caution

- Danger of explosion if battery is incorrectly replaced. Replace only with the alkaline or manganese batteries.
- Insert the batteries making sure the polarities correctly match the \oplus and \ominus marks inside the battery compartment.
- Batteries of different types have different properties, therefore do not mix batteries of different types.
- Do not mix new and old batteries. This may shorten the life of new batteries or may cause old batteries to leak.
- Remove the batteries from the remote control once they have run out, as leaving them in can cause them to leak. Battery fluid from leaked batteries is harmful to skin, therefore ensure you wipe them first and then remove them using a cloth.
- The batteries included with this projector may run down in a short period, depending on how they are kept. Be sure to replace them as soon as possible with new batteries.
- Remove the batteries from the remote control if you will not be using the remote control for a long time.
- Comply with the rules (ordinance) of each local government when disposing of worn-out batteries.

Using the Remote Control with a Signal Cable

When the signals from the remote control cannot be reached due to the positioning of the projector, use a $\varnothing 3.5$ mm minijack cable to connect the remote control to the projector. Now you can control the projector with the remote control.

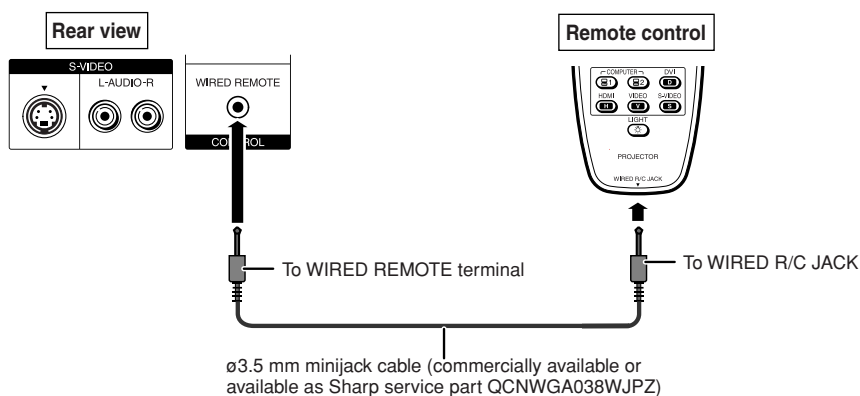

Note

- The wireless remote function is not possible when the $\varnothing 3.5$ mm minijack cable is connected to the projector. Should the wireless remote operation be required, the $\varnothing 3.5$ mm minijack cable should be disconnected from the projector.

Switching the Remote Control Mode

The remote control has two functions. One is projector control and the other is wireless computer mouse. Slide the ADJ./MOUSE switch on the remote control to other side compatible to the desired usage.

Projector control

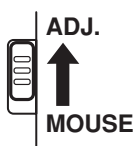

Wireless computer mouse

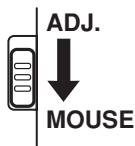

Info

- When using the remote control as the wireless computer mouse, connect the optional remote receiver (AN-MR2) to the computer. (See page 18.)

Using the Remote Control as a Wireless Computer Mouse

When connecting the optional remote receiver (AN-MR2) to the computer, you can use the remote control as the wireless computer mouse.

1 Connect the optional remote receiver to the USB terminal on the computer.

2 Slide the ADJ./MOUSE switch on the remote control to the MOUSE position.



3 Use the mouse function.
 • Point the remote control at the remote receiver.

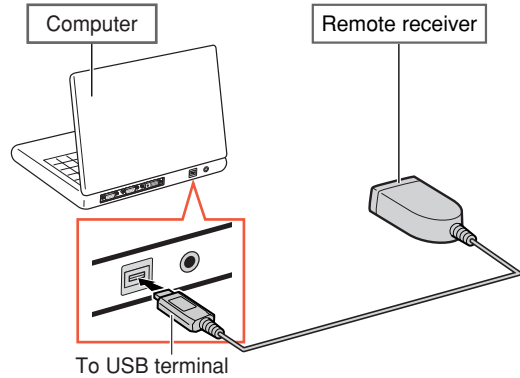

■ **When moving the cursor**

Press ▲/▼/◀/▶.

■ **When left-clicking**

Press L-CLICK.

■ **When right-clicking**

Press R-CLICK.

■ **When your computer supports only a one-click mouse (such as Macintosh®)**
 Press L-CLICK or R-CLICK. (L-CLICK and R-CLICK have common function.)

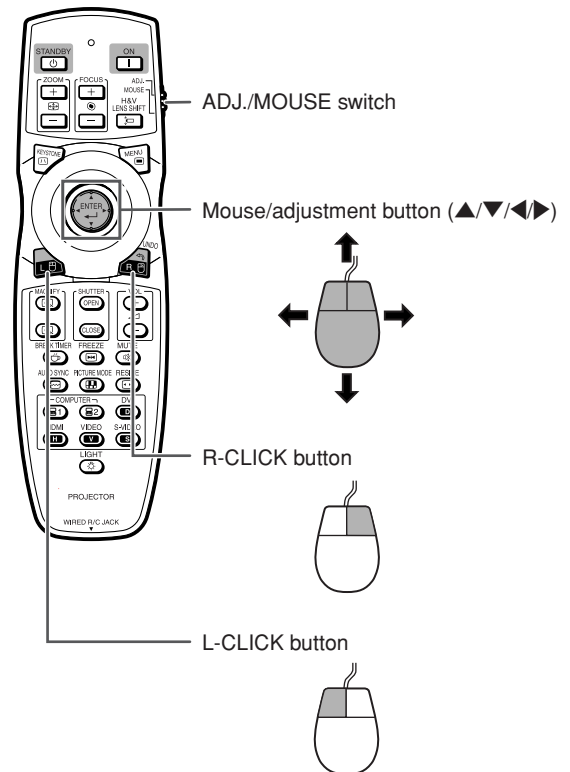

Note

- This function only works with the Microsoft® Windows® OS and Mac OS®. However, this function does not work with the following operation systems that do not support USB.
 - Versions earlier than Windows® 95.
 - Versions earlier than Windows® NT4.0.
 - Versions earlier than Mac OS® 8.5.
- Confirm that the computer recognizes the USB connection.
- While the remote control is connected to the projector with a signal cable, you cannot use the wireless computer mouse function.

Quick Start

This section shows the basic operation (projector connecting with the computer). For details, see the page described below for each step.

Setup and Projection

In this section, connection of the projector and the computer is explained using one example.

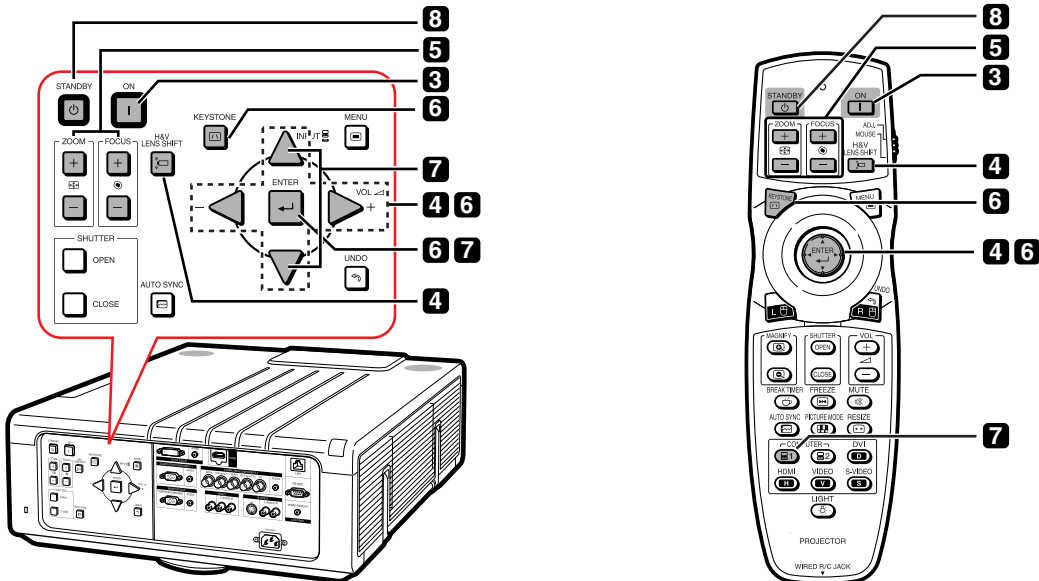

1. Place the projector facing a screen

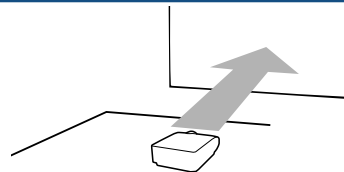

→ Page 21

2. Connect the projector to the computer and plug the power cord into the AC socket of the projector

When connecting equipment other than the computer, see pages 25 and 26.

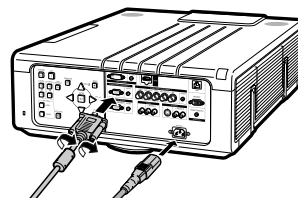

→ Pages 24, 28

3. Remove the lens cap and turn the projector on

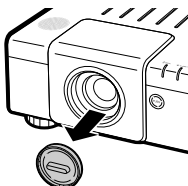

Press **ON** on the projector or on the remote control.

→ Page 28

4. Adjust the angle

Adjust the projector angle:

- Shift the lens horizontally and vertically.
 - ① Press **H&V LENS SHIFT** on the projector or on the remote control.
 - ② Press **▲**, **▼**, **◀** or **▶** on the projector or the remote control.
- Adjust the projector angle by rotating the adjustment feet.

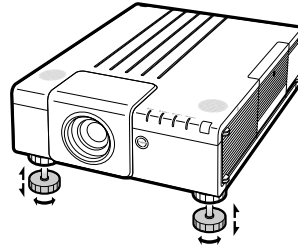

➔ Pages 29, 30

5. Adjust the focus and the zoom

- ① Press **FOCUS +/-** on the projector or on the remote control to adjust the focus.
- ② Press **ZOOM +/-** on the projector or on the remote control to adjust the zoom.

➔ Page 31

6. Correcting the image distortion due to the projection angle

- ① Press **KEYSTONE** on the projector or on the remote control.
- ② Press **ENTER** on the projector or on the remote control.
- ③ Press **▲**, **▼**, **◀** or **▶** to move the position for the upper left of the image.
- ④ Press **ENTER** to set the position.
- ⑤ Repeat the same procedure with the positions for the upper right, lower right and lower left of the image.
 - When the position of the lower left is set, the correction is made and the display disappears.

➔ Page 32

7. Select the input mode

Press **INPUT** on the projector or **COMPUTER1** on the remote control to select the “COMPUTER1” mode.

On the projector

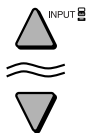

On the remote control



INPUT list

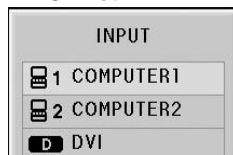

On-screen display (RGB)



- When you press **INPUT** on the projector, the INPUT list appears. Press **▲/▼** to switch the INPUT mode and then press **ENTER**.
- When using the remote control, press **COMPUTER1/2**, **DVI**, **HDMI**, **VIDEO** or **S-VIDEO** to switch the input mode.

➔ Page 36

8. Turn the power off

Press **STANDBY** on the projector or on the remote control. While the confirmation message is displayed, press **STANDBY** again.

▼ On-screen display

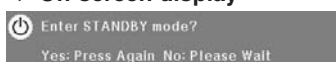

- You can unplug the power cord even if the projector is operating.
- Even if you unplug the power cord from the AC outlet, the cooling fan continues to run for a while.

➔ Page 28

Setting Up the Projector

Setting Up the Projector

For optimal image quality, position the projector perpendicular to the screen with the projector's feet flat and level. Doing so will eliminate the need for Keystone correction and provide the best image quality.

Note

- The projector lens should be centered in the middle of the screen. If the horizontal line passing through the lens center is not perpendicular to the screen, the image will be distorted, making viewing difficult.
- For an optimal image, position the screen so that it is not in direct sunlight or room light. Light falling directly on the screen washes out the colors, making viewing difficult. Close the curtains and dim the lights when setting up the projector in a sunny or bright room.

Standard Setup (Front Projection)

- Place the projector at the required distance from the screen according to the desired picture size. (For details, refer to "SETUP MANUAL" contained on the supplied CD-ROM.)

Side View

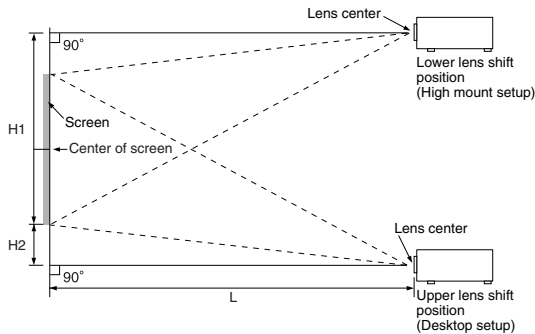

Top View

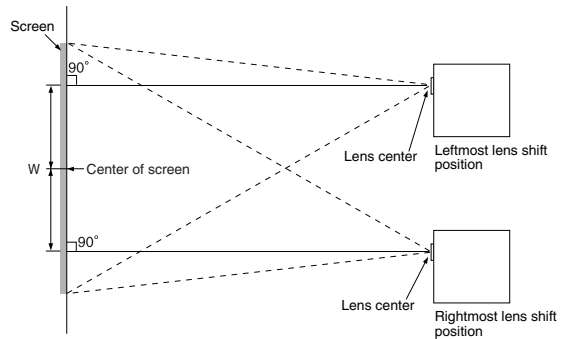

Indication of the Projection Image Size and Projection Distance

For details, refer to "SETUP MANUAL" contained on the supplied CD-ROM.

Example : NORMAL Mode (4:3) for the standard zoom lens (AN-P18EZ)

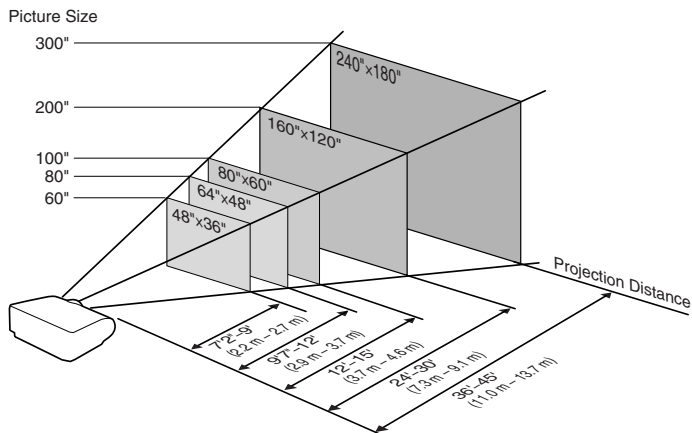

Standard Zoom Lens (AN-P18EZ : Standard Equipment with XG-P610X) F2.5, f=25.5-32 mm

4:3 Signal Input (Normal Mode)

Picture (Screen) size			Projection distance [L]		Distance from the lens center to the bottom of the image [H]		Distance from the lens center to the center of the image [W]
Diag. [X]	Width	Height	Minimum [L1]	Maximum [L2]	Lower [H1]	Upper [H2]	
300" (762 cm)	610 cm (240")	457 cm (180")	11.0 m (36' 0")	13.7 m (45' 0")	-480.1 cm (-189")	22.9 cm (9")	±213.4 cm (84")
250" (635 cm)	508 cm (200")	381 cm (150")	9.1 m (30' 0")	11.4 m (37' 6")	-400.1 cm (-157 1/2")	19.1 cm (7 1/2")	±177.8 cm (70")
200" (508 cm)	406 cm (160")	305 cm (120")	7.3 m (24' 0")	9.1 m (30' 0")	-320.0 cm (-126")	15.2 cm (6")	±142.2 cm (56")
150" (381 cm)	305 cm (120")	229 cm (90")	5.5 m (18' 0")	6.9 m (22' 6")	-240.0 cm (-94 1/2")	11.4 cm (4 1/2")	±106.7 cm (42")
120" (305 cm)	244 cm (96")	183 cm (72")	4.4 m (14' 5")	5.5 m (18' 0")	-192.0 cm (-75 9/32")	9.1 cm (3 19/32")	±85.3 cm (33 19/32")
100" (254 cm)	203 cm (80")	152 cm (60")	3.7 m (12' 0")	4.6 m (15' 0")	-160.0 cm (-63")	7.6 cm (3")	±71.1 cm (28")
80" (203 cm)	163 cm (64")	122 cm (48")	2.9 m (9' 7")	3.7 m (12' 0")	-128.0 cm (-50 13/32")	6.1 cm (2 13/32")	±56.9 cm (22 13/32")
70" (178 cm)	142 cm (56")	107 cm (42")	2.6 m (8' 5")	3.2 m (10' 6")	-112.0 cm (-44 3/32")	5.3 cm (2 3/32")	±49.8 cm (19 19/32")
60" (152 cm)	122 cm (48")	91 cm (36")	2.2 m (7' 2")	2.7 m (9' 0")	-96.0 cm (-37 51/64")	4.6 cm (1 51/64")	±42.7 cm (16 51/64")

X: Picture size (diag.) (in/cm)
 L1: Minimum projection distance (m/ft)
 L2: Maximum projection distance (m/ft)
 H1: Lower distance from the lens center to the bottom of the image (cm/in)
 H2: Upper distance from the lens center to the bottom of the image (cm/in)
 W: Distance from the lens center to the center of the image (cm/in)

The formula for picture size and projection distance
[m/cm]
 L1 (m) = 0.03658X
 L2 (m) = 0.04572X
 H1 (cm) = -1.6002X
 H2 (cm) = 0.0762X
 W (cm) = ±0.7112X
[Feet/inches]
 L1 (ft) = 0.03658X / 0.3048
 L2 (ft) = 0.04572X / 0.3048
 H1 (in) = -1.6002X / 2.54
 H2 (in) = 0.0762X / 2.54
 W (in) = ±0.7112X / 2.54

16:9 Signal Input (Stretch Mode)

Picture (Screen) size			Projection distance [L]		Distance from the lens center to the bottom of the image [H]		Distance from the lens center to the center of the image [W]
Diag. [X]	Width	Height	Minimum [L1]	Maximum [L2]	Lower [H1]	Upper [H2]	
250" (635 cm)	553 cm (218")	311 cm (123")	10.0 m (32' 8")	12.5 m (40' 10")	-384.0 cm (-151 11/64")	72.6 cm (28 7/8")	±193.7 cm (76 17/64")
200" (508 cm)	443 cm (174")	249 cm (98")	8.0 m (26' 2")	10.0 m (32' 8")	-307.2 cm (-120 15/16")	58.1 cm (22 7/8")	±155.0 cm (61 1/64")
150" (381 cm)	332 cm (131")	187 cm (74")	6.0 m (19' 7")	7.5 m (24' 6")	-230.4 cm (-90 45/64")	43.6 cm (17 5/32")	±116.2 cm (45 3/4")
120" (305 cm)	266 cm (105")	149 cm (59")	4.8 m (15' 8")	6.0 m (19' 7")	-184.3 cm (-72 9/16")	34.9 cm (13 7/16")	±93.0 cm (36 39/64")
100" (254 cm)	221 cm (87")	125 cm (49")	4.0 m (13' 1")	5.0 m (16' 4")	-153.6 cm (-60 15/32")	29.1 cm (11 7/16")	±77.5 cm (30 1/2")
80" (203 cm)	177 cm (70")	100 cm (39")	3.2 m (10' 6")	4.0 m (13' 1")	-122.9 cm (-48 3/8")	23.2 cm (9 5/32")	±62.0 cm (24 19/32")
60" (152 cm)	133 cm (52")	75 cm (29")	2.4 m (7' 10")	3.0 m (9' 10")	-92.1 cm (-36 9/32")	17.4 cm (6 55/64")	±46.5 cm (18 19/64")

X: Picture size (diag.) (in/cm)
 L1: Minimum projection distance (m/ft)
 L2: Maximum projection distance (m/ft)
 H1: Lower distance from the lens center to the bottom of the image (cm/in)
 H2: Upper distance from the lens center to the bottom of the image (cm/in)
 W: Distance from the lens center to the center of the image (cm/in)

The formula for picture size and projection distance
[m/cm]
 L1 (m) = 0.03985X
 L2 (m) = 0.04981X
 H1 (cm) = -1.53583X
 H2 (cm) = 0.29056X
 W (cm) = ±0.77483X
[Feet/inches]
 L1 (ft) = 0.03985X / 0.3048
 L2 (ft) = 0.04981X / 0.3048
 H1 (in) = -1.53583X / 2.54
 H2 (in) = 0.29056X / 2.54
 W (in) = ±0.77483X / 2.54

Note

- Allow a margin of error in the value in the diagrams above.
- When the distance from the lens center to the bottom of the image [H] is a negative number, this indicates that the bottom of the image is below the lens center.
- See page 21 about projection distance [L] and distance from the lens center to the bottom of the image [H].

Projecting a Reversed Image

Projection from behind the Screen

- Place a translucent screen between the projector and the audience.
- Reverse the image by selecting “Rear” in the “PRJ Mode” menu. (See page 62.)

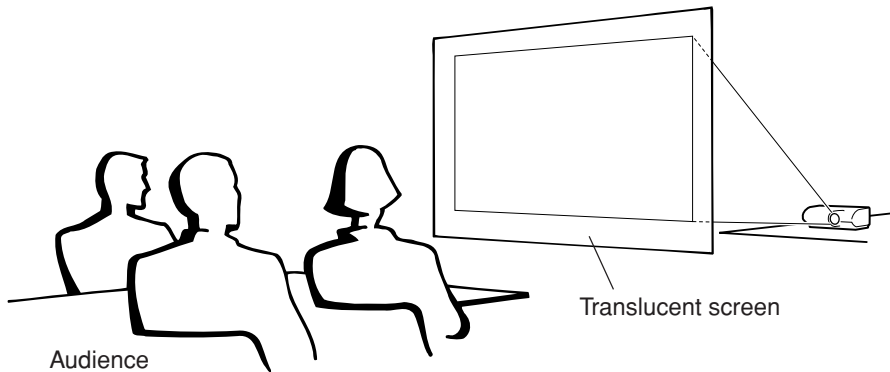

Projection Using a Mirror

- Place a mirror (normal flat type) in front of the lens.
- When the translucent screen is placed between the mirror and audience, select “Front” in the “PRJ Mode” menu. (See page 62.)
- When the mirror is placed on the audience side, select “Rear” in the “PRJ Mode” menu. (See page 62.)

Set to “Front”

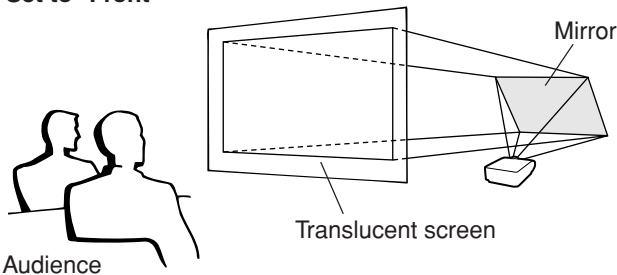

Set to “Rear”

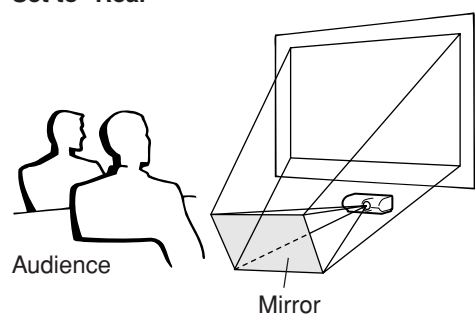

Info

- When using a mirror, ensure that both the projector and the mirror are carefully placed so the projected light does not shine into the eyes of the audience.

Ceiling-mount Setup

- It is recommended that you use the optional Sharp ceiling-mount adaptor and unit for this installation.
Before mounting the projector, contact your nearest Sharp Authorized Projector Dealer or Service Center to obtain the recommended ceiling-mount adaptor and unit (sold separately).
- Invert the image by selecting “Ceiling + Front” in “PRJ Mode”. See page 62 for use of this function.

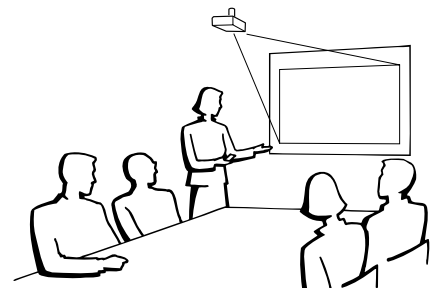

Connecting the Projector to Other Equipment









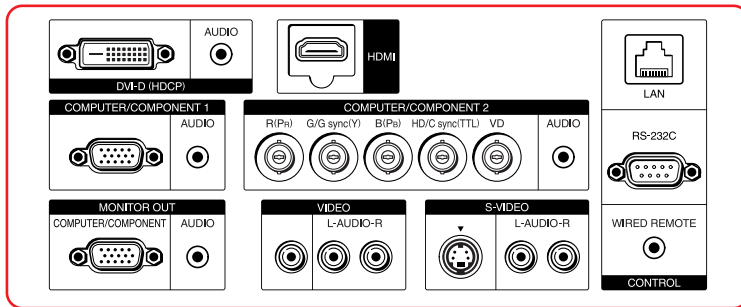



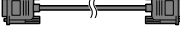
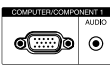

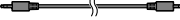
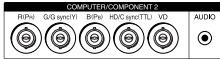
Before connecting, ensure that the power cord of the projector is unplugged from the AC outlet and turn off the equipment to be connected. After making all connections, turn on the projector and then the other pieces of equipment. When connecting a computer, ensure that it is the last equipment to be turned on after all the connections are made.

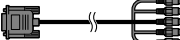
IMPORTANT: Ensure that the appropriate input mode has been selected on the projector before you turn on the connected equipment.

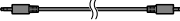
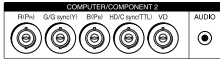
- For more details of connection and cables, refer to the operation manual of the connected equipment.
- You may need other cables or connectors not listed below.

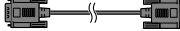

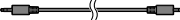

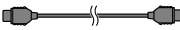







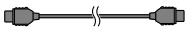

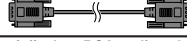
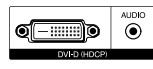

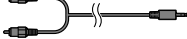

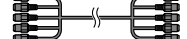
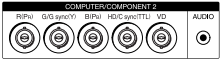
Terminals on the Projector

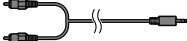

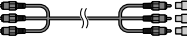
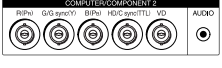
Equipment	Terminal on connected equipment	Cable	Terminal on the projector
 Computer	RGB output terminal 	RGB cable (supplied) 	COMPUTER/COMPONENT1 
	Computer audio output terminal 	Computer audio cable (ø3.5 mm stereo minijack, commercially available) 	COMPUTER/COMPONENT2 
	RGB output terminal 	Mini D-sub 15 pin/5 BNC cable (commercially available) 	
	Computer audio output terminal 	Computer audio cable (ø3.5 mm stereo minijack, commercially available) 	COMPUTER/COMPONENT2 
 DVI digital output terminal	Computer audio output terminal 	DVI Digital cable (commercially available) 	DVI-D 
		HDMI digital output terminal 	HDMI cable (commercially available) 

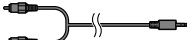
Note

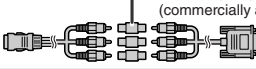
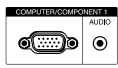

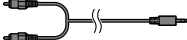







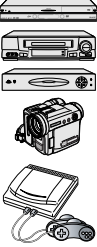

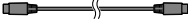
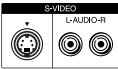
- When connecting the projector to a compatible computer other than a PC (VGA/SVGA/XGA/SXGA/UXGA) or Macintosh (i.e. Workstation), a separate cable may be needed. Please contact your dealer for more information.
- With the DVI digital connection, select “D. PC RGB” for “Signal Type” in the “Picture” menu.
- See page 75 “Computer Compatibility Chart” for a list of computer signals compatible with the projector. Use with computer signals other than those listed may cause some of the functions to not work.
- A Macintosh adaptor may be required for use with some Macintosh computers. Contact your nearest Macintosh Dealer.
- **Depending on the computer you are using, an image may not be projected unless the computer’s external output port is switched on (e.g. Press “Fn” and “F5” keys simultaneously when using a SHARP notebook computer). Refer to the specific instructions in your computer’s operation manual to enable your computer’s external output port.**

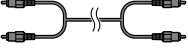
Equipment	Terminal on connected equipment	Cable	Terminal on the projector
Video equipment, Camera, Video game 	HDMI digital output terminal 	HDMI cable (commercially available) 	HDMI 
	DVI digital output terminal 	DVI Digital cable (commercially available) 	DVI-D 
	Audio output terminal 	ø3.5 mm stereo minijack to RCA audio cable (commercially available) 	
	RGB video output terminal 	5 BNC cable (commercially available) 	COMPUTER/COMPONENT2 
	Audio output terminal 	ø3.5 mm stereo minijack to RCA audio cable (commercially available) 	
	Component video output terminal 	Component cable (commercially available) + BNC-RCA adaptor plug (commercially available) 	COMPUTER/COMPONENT2 
	Audio output terminal 	ø3.5 mm stereo minijack to RCA audio cable (commercially available) 	
D-video output terminal 	Cables for a camera or a video game/3 RCA to mini D-sub 15 pin cable (optional, AN-C3CP2)  RCA adaptor plug (commercially available)	COMPUTER/COMPONENT1 	
Audio output terminal 	ø3.5 mm stereo minijack to RCA audio cable (commercially available) 		

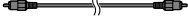
Note

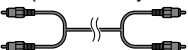
- Select the input signal type of the video equipment when connecting to the COMPUTER1/2, DVI-D or HDMI terminal. See page 51.
- The HD/C sync and VD terminals may be used depending on the specifications of the DTV decoder connected to this projector. Please refer to the operation manual of the DTV decoder for details.
- The HD/C sync terminal of the 5 BNC terminal is only for TTL signal.
- Select “480P” or “576P” for “Resolution” on the “Fine Sync” menu, if necessary. (See page 53.)
- While the projector is connected to video equipment that has an HDMI output terminal, only the video signal can be input to the projector. (Connect the AUDIO input terminal for audio input.)
- Depending on specifications of video equipment or HDMI to DVI digital cable, the signal transmission may not work properly. (The HDMI specification does not support all connections to video equipment that has HDMI digital output terminal using HDMI to DVI digital cable.)
- For details on compatibility for connection, see support information on DVI connection provided by the video equipment manufacturer.
- When you connect video equipment with a 21-pin RGB output (Euro-scart) to the projector, use a commercially available cable that fits in the projector terminal you want to connect.
- The projector does not support RGBC signals via the Euro-scart.

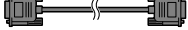
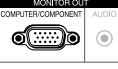
Connecting the Projector to Other Equipment

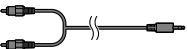
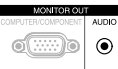
Equipment	Terminal on connected equipment	Cable	Terminal on the projector
Video equipment, Camera, Video game 	S-video output terminal 	S-video cable (commercially available) 	S-VIDEO 
	Audio output terminal 	RCA audio cable (commercially available) 	
	Video output terminal 	Video cable (commercially available) 	VIDEO 
	Audio output terminal 	RCA audio cable (commercially available) 	
Monitor 	RGB input terminal 	RGB cable (supplied or commercially available) 	MONITOR OUT 
Amplifier 	Audio output terminal 	ø3.5 mm stereo minijack to RCA audio cable (commercially available) 	MONITOR OUT 

Note

- When using the ø3.5 mm mono audio cable, the volume level will be half of when using the ø3.5 mm stereo audio cable.
- Video signal for monitor output is analog RGB signal as well as component signal (COMPUTER1/2). DVI and HDMI input video signals would not be output.
- When the audio from HDMI input is directed to the MONITOR OUT (AUDIO) terminal, output will be generated as Linear PCM audio.
- HDMI (High-Definition Multimedia Interface) is a digital AV interface that can deliver a high-definition video signal, multi-channel audio signal, and bi-directional control signal all in just one cable.
- Because it is compatible with the HDCP (High-bandwidth Digital Content Protection) system, the digital video signal does not degrade when transmitted, and a high-quality image with a simple connection can be enjoyed.
- The HDMI terminal does not support the CEC signal.

This projector is able to process the following signals when connected to HDMI equipment:

- Video signal: For details, see "HDMI Support" in the list of "Computer Compatibility Chart" on page 75.
- Audio signal: Linear PCM audio
- Sampling frequency: 48kHz/44.1kHz/32kHz

Controlling the Projector by a Computer

When the RS-232C terminal on the projector is connected to the RS-232C serial terminal on the computer, or when the LAN terminal on the projector is connected to the LAN terminal on the computer, the computer can be used to control the projector. Refer to the “SETUP MANUAL” contained on the supplied CD-ROM for details.

When connecting to a computer using an RS-232C serial control cable

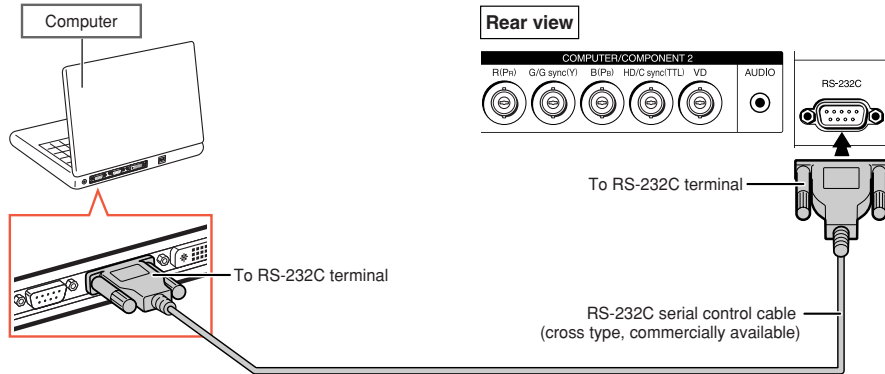

Note

- The RS-232C function may not operate if your computer terminal is not correctly set up. Refer to the operation manual of the computer for details.
- Refer to “SETUP MANUAL” contained on the supplied CD-ROM for the RS-232C specifications and commands.

Info

- Do not connect the RS-232C cable to a terminal other than the RS-232C terminal on the computer. This may damage your computer or projector.
- Do not connect or disconnect an RS-232C serial control cable to or from the computer while it is on. This may damage your computer.

When connecting to the LAN terminal using a LAN cable

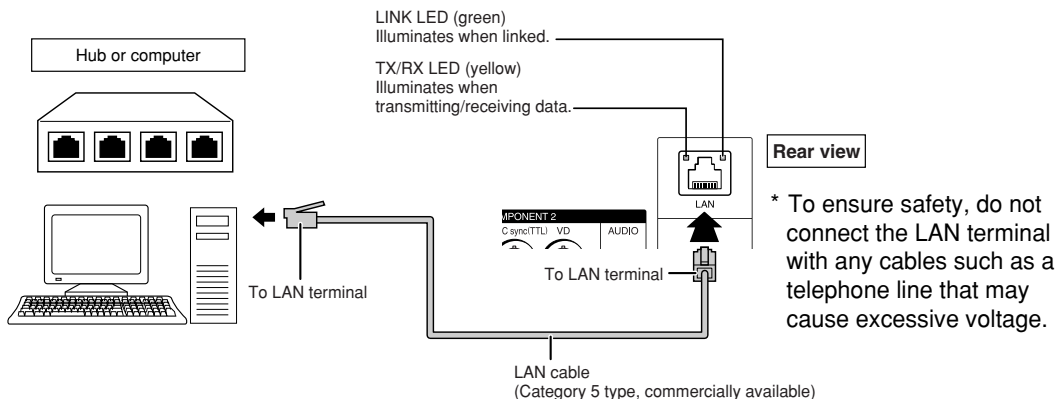

Note

- When connecting to a hub, use **straight-through** Category 5 (CAT.5) type cable (commercially available).
- When connecting to a computer, use **cross-over** Category 5 (CAT.5) type cable (commercially available).

Turning the Projector On/Off

Connecting the Power Cord

Plug the supplied power cord into the AC socket on the rear of the projector. Then plug into the AC outlet.

Turning the Projector On

Before performing the steps in this section, connect any equipment that you use with the projector. (See pages 24–27.)

Remove the lens cap and press **ON** on the projector or on the remote control.

- The power indicator illuminates green.
- After the lamp indicator illuminates, the projector is ready to start operation.
- When System Lock is set, the keycode input screen appears. Enter the right keycode to start projection. See page 60 for details.

Note

- The lamp indicator illuminates or blinks, indicating the status of the lamp.
Green: The lamp is on.
Blinking green: The lamp is warming up.
Red: The lamp is shut down abnormally or the lamp should be replaced.
- When switching on the projector, a slight flickering of the image may be experienced within the first minute after the lamp has been illuminated. This is normal operation as the lamp's control circuitry is stabilizing the lamp output characteristics. This does not indicate malfunction.
- If the projector is put into standby mode and immediately turned on again, the lamp may take some time to illuminate.

Turning the Power Off (Putting the Projector into Standby Mode)

Press **STANDBY** on the projector or on the remote control, then press that button again while the confirmation message is displayed, to put the projector into standby mode.

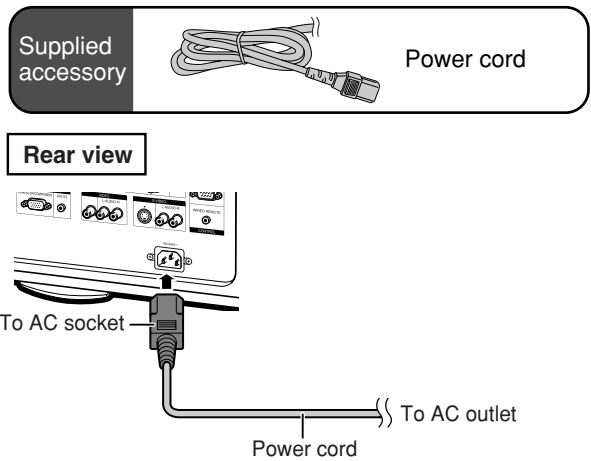

Info

- **When “Auto Restart” is set to “On”:**
If the power cord is unplugged from the AC outlet or the breaker switch is turned off when the projector is on, then the projector automatically turns on when the power cord is plugged into the AC outlet or the breaker switch is turned on. (See page 63.)
- English is the factory preset language. If you want to change the on-screen display to another language, change the language according to the procedure on page 65.

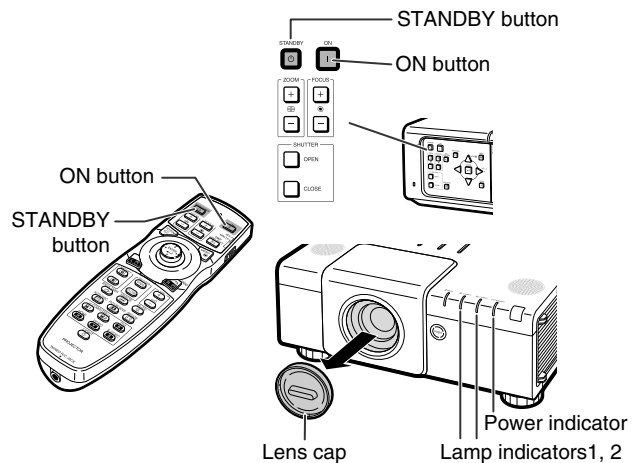

▼On-screen display

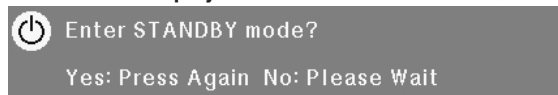

Info

- You can unplug the power cord from the AC outlet even if the cooling fan is still running. Even if you unplug the power cord from the projector, the cooling fan continues to run for a while.

Shifting the Lens

In addition to the zoom function and adjustment of projection angle using the adjustment feet, you can adjust the position of the projection using the lens shift function. This is a useful function in cases such as when the screen cannot be moved.

When moving upward or downward

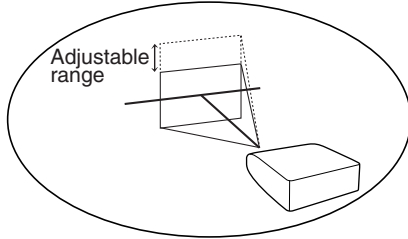

When moving in the left and right direction

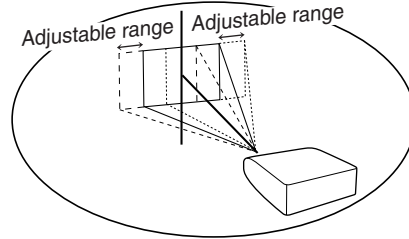

Adjustable range

- The adjustable range is shown below.

Horizontal range: $\pm 35\%$

Vertical range: $\pm 55\%$

The adjustable range has limitations even within the range shown above.

Select the correct type of lens that match with the installed lens (see page 62).

- The image can be adjusted as shown on the diagram.

AN-P15EZ, AN-P18EZ, AN-P23EZ, AN-P30EZ, AN-P45EZ

Position of the image when the image is centered, both vertically and horizontally, in lens shift

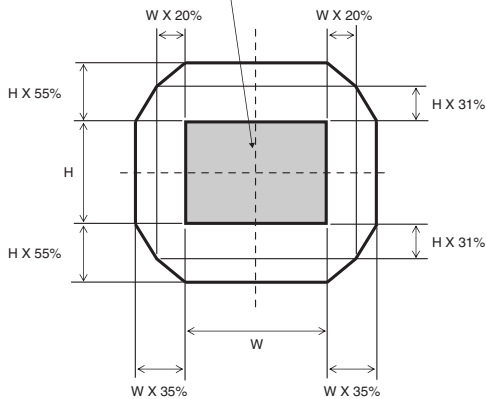

H : Height of the image
W : Width of the image

AN-P8EX, AN-P12EX

Position of the image when the image is centered, both vertically and horizontally, in lens shift

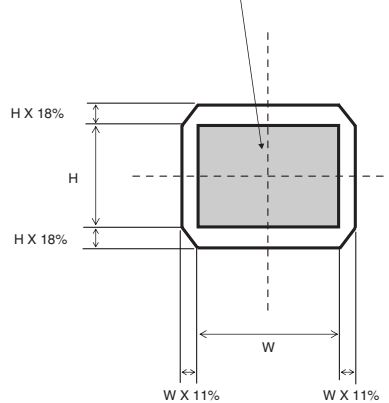

H : Height of the image
W : Width of the image

1 Press **H&V LENS SHIFT** on the projector or on the remote control.

- Pressing **ENTER** on the projector or on the remote control displays the test pattern. Checking the test pattern is useful for more accurate adjustment.

▼On-screen display

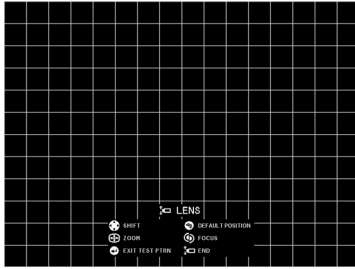

2 Press **▲, ▼, ◀ or ▶** on the projector or the remote control to adjust the image position.

Note

- When **UNDO** is pressed, the lens shift reset screen is displayed. Lens shift can be reset to factory default with this screen.

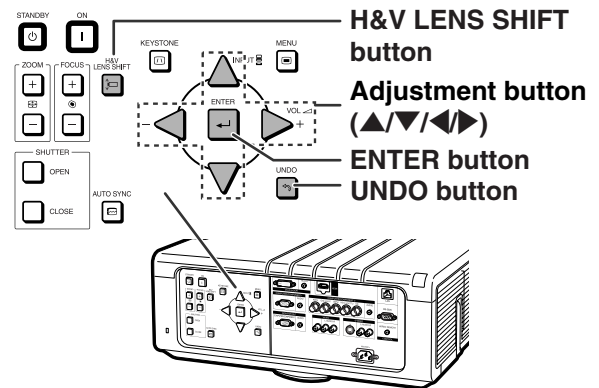
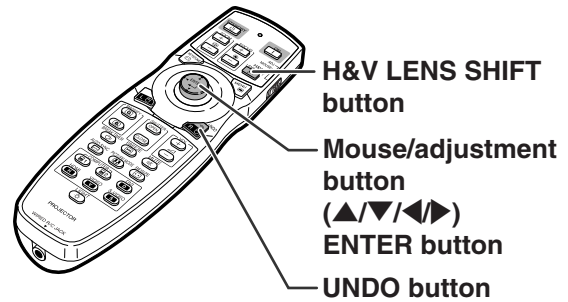

Using the Adjustment Feet

- When the position of the projected image cannot be adjusted with the lens shift function, use the adjustment feet to adjust the projected angle.
- The height of the projector can be adjusted using the adjustment feet when the screen is located higher than the projector, the screen is inclined or when the installation site is slightly inclined.
- Install the projector so that it is as perpendicular to the screen as possible.

1 Rotate the adjustment feet to adjust the projected angle.

- The projector is adjustable up to approximately 5 degrees.

Warning!

- Do not hold the lens and lens cover when projector angle is adjusted.
- Use caution not to pinch your finger in the space between the adjustment foot and the projector when the projector angle is lowered.

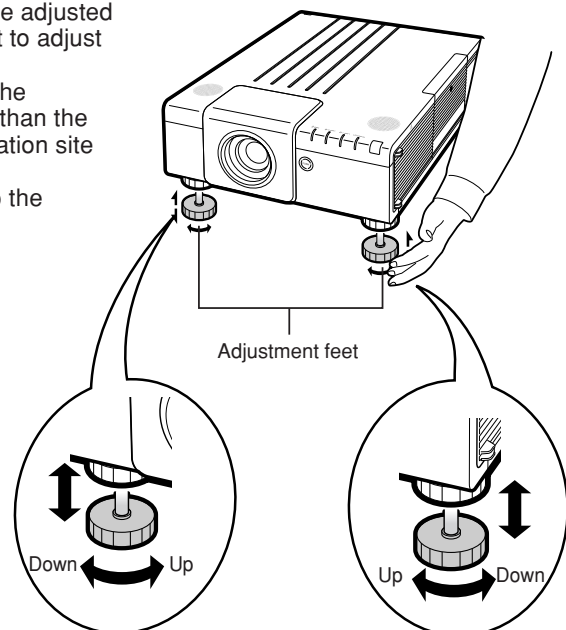

Adjusting the Focus

Press **FOCUS +/-** on the projector or on the remote control to adjust the focus.

▼On-screen display



Info

- It is recommended that the focus be adjusted after the projector has warmed up for at least 30 minutes.

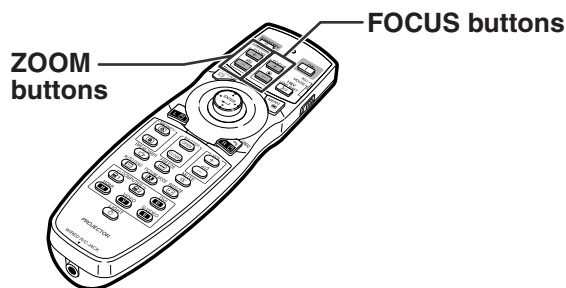
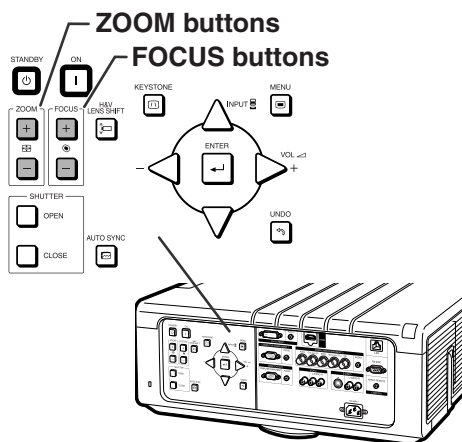

Adjusting the Projected Image Size

Press **ZOOM +/-** on the projector or on the remote control to adjust the projected image size.

▼On-screen display



Note

- After you have pressed **FOCUS** or **ZOOM** on the remote control or the projector, you can display the test pattern by pressing **ENTER**. The test pattern is useful for making more accurate adjustments.
- For fine adjustments, when **H&V LENS SHIFT**, **FOCUS** or **ZOOM** is pressed, the projected image moves a small amount in the desired direction for approximately one second. Hold down the buttons to move the projected image quickly.

Correcting Trapezoidal Distortion

When the image is projected either from the top or from the bottom towards the screen at an angle, the image becomes distorted trapezoidally.

The function for correcting trapezoidal distortion is called **Keystone Correction**.

There are the two types of the Keystone Correction.

- 1) "GEOMETRIC ADJUSTMENT" for correcting an image designating the corner of the projected image
- 2) "H&V KEYSTONE" for designating the correction of the horizontal and vertical axes

Selecting the Type of the Correction

Select the type of the keystone correction.

Press **KEYSTONE** on the projector or on the remote control.

- "GEOMETRIC ADJUSTMENT" will be displayed.
- Each time **KEYSTONE** is pressed, the display toggles as follows:

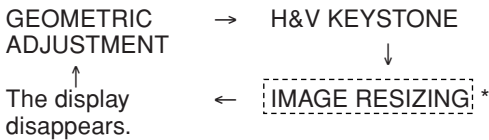

GEOMETRIC ADJUSTMENT	For correcting an image designating the corner of the projected image
H&V KEYSTONE	For correcting an image designating the horizontal or vertical axes
IMAGE RESIZING	For correcting the image distortion which cannot be corrected with "H&V KEYSTONE". *Only when "H&V KEYSTONE" is set to the values other than "0", "IMAGE RESIZING" can be adjusted. (This function cannot be used when correcting with "GEOMETRIC ADJUSTMENT".)

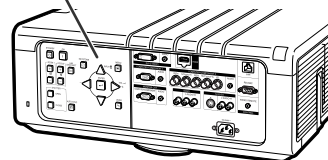
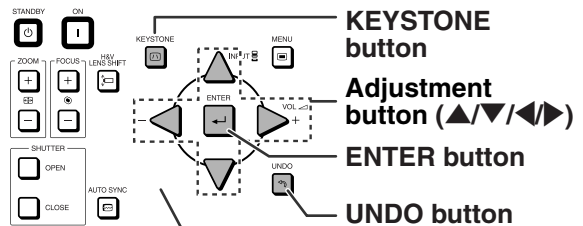
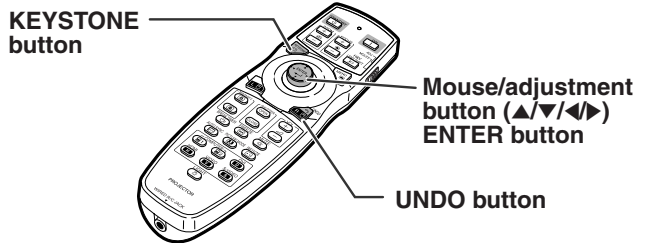

GEOMETRIC ADJUSTMENT

1 Press **KEYSTONE** on the projector or on the remote control repeatedly until “GEOMETRIC ADJUSTMENT” is displayed.

2 Press the buttons below to adjust the position, size or focus of the projected image.

- Match screen’s four sides to green test pattern.
- Pressing **▲**, **▼**, **◀** or **▶** on the projector or **H&V LENS SHIFT** on the remote control allows you to shift the lens.
- Pressing **ZOOM +/-** on the projector or on the remote control allows you to adjust the projected image size.
- Pressing **FOCUS +/-** on the projector or on the remote control allows you to adjust the focus.

3 Press **ENTER** on the projector or on the remote control.

4 Press **▲**, **▼**, **◀** or **▶** to move the position for the upper left of the image.

- Move the upper left of the yellow frame onto the upper left of the screen.

5 Press **ENTER** to set the position.

6 Repeat the same procedure with the positions for the upper right, lower right and lower left of the image.

- At this time, pressing **UNDO** on the projector or on the remote control returns to the previous screen.
- Before correcting the upper left of the image, pressing **UNDO** returns to the reset confirmation screen.
- **When the position of the lower left is set, the correction is made and the display disappears.**
- If the message “Can not correct.” is displayed, step 2 may have been performed incorrectly. In this case, go back to step 2 and try the procedure again.

▼On-screen display



Geometric Adjustment

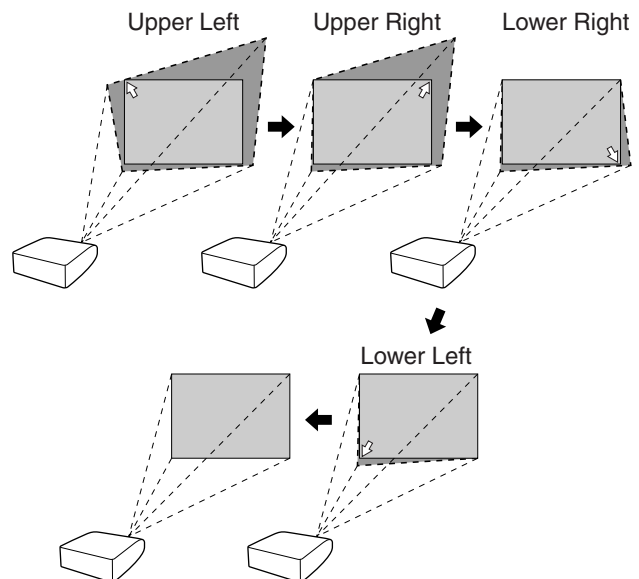

H&V KEYSTONE

1 Press **KEYSTONE** on the projector or on the remote control repeatedly until “H&V KEYSTONE” is displayed.

- When the correction has already been made with “GEOMETRIC ADJUSTMENT”, the confirmation message for resetting the correction before “H&V KEYSTONE” is displayed, and then reset.

2 Press **▲** or **▼** to parallelize the left and right sides of the projected image.

3 Press **◀** or **▶** to parallelize the upper and lower sides of the projected image.

4 Press **KEYSTONE** to display “IMAGE RESIZING”.

- Only when “H&V KEYSTONE” is set to the values other than “0”, “IMAGE RESIZING” works.

▼On-screen display



Vertical Keystone Correction (Adjustment with ▲ / ▼)

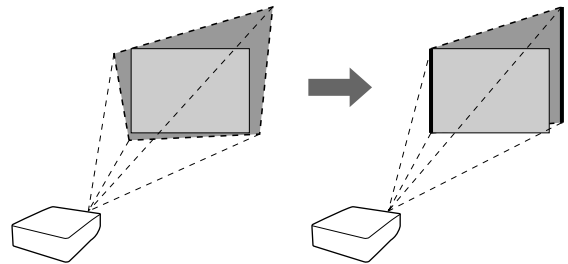

Horizontal Keystone Correction (Adjustment with ◀ / ▶)

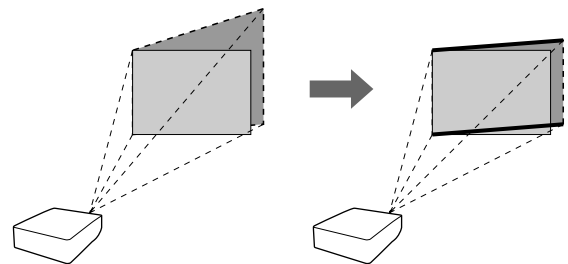

▼On-screen display



5 Press ▲, ▼, ◀ or ▶ to correct the image distortion.

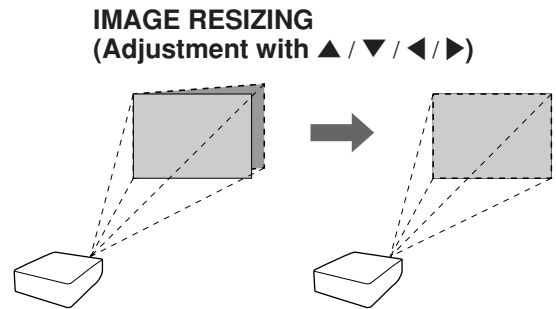

6 Press **KEYSTONE** to set the position.

Switching the Input Mode

Select the appropriate input mode for the connected equipment.

Press **COMPUTER1/2**, **DVI**, **HDMI**, **VIDEO** or **S-VIDEO** on the remote control to select the input mode.

- When you select the input mode with **INPUT ▲/▼** on the projector or **▲/▼** on the remote control:
 - When **▲/▼** is pressed, the Input list appears. While the Input list is displayed, follow the procedure below to switch the input mode.
 - Press **▲/▼** to select the desired input mode and then press **ENTER**.
 - When “AUTO SEARCH” is selected, input signal is automatically detected.
 - If **ENTER** is not pressed, the projector switches to the selected input mode in a few seconds.

Note

- When no signal is received, “NO SIGNAL” will be displayed. When non-supported signal is received, “NOT REG.” is displayed.
- The input mode is not displayed when “OSD Display” of the “Options1” menu is set to “Level A” or “Level B”. (See page 57.)

Adjusting the Volume

Press **VOL +/-** on the projector or on the remote control to adjust the volume.

Note

- Pressing **VOL-** will lower the volume. Pressing **VOL+** will raise the volume.
- When “Pict in Pict” (see page 56) is set to “On”, audio volume cannot be adjusted on the projector. The audio volume buttons will instead function as location shift button for the smaller screen.

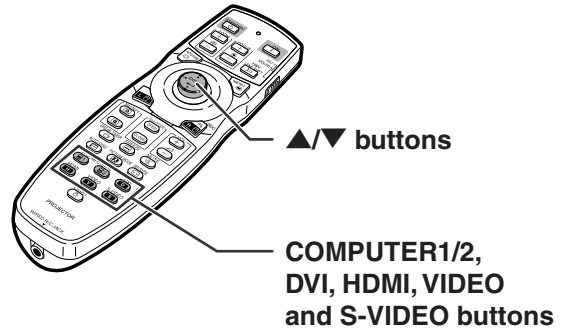

Input mode menu

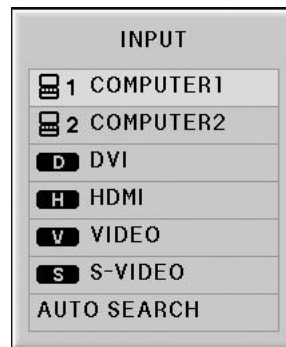

▼ On-screen display



Turning Off the Sound Temporarily

Press **MUTE** on the remote control to temporarily turn off the sound.

Note

- Pressing **MUTE** again will turn the sound back on.

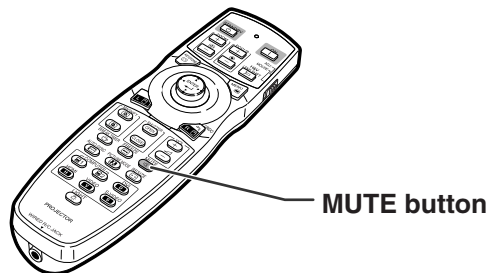



▼ On-screen display



Displaying an Enlarged Portion of an Image

Graphs, tables and other portions of projected images can be enlarged. This is helpful when providing more detailed explanations.

1 Press **MAGNIFY** on the remote control.

- Enlarges the image.
- Pressing  or  enlarges or reduces the projected image.

Note

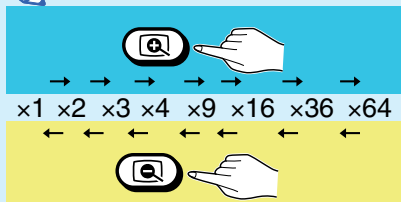

- You can change the location of the enlarged image using **▲**, **▼**, **◀** and **▶**.

MAGNIFY
(enlarge/reduce)
buttons

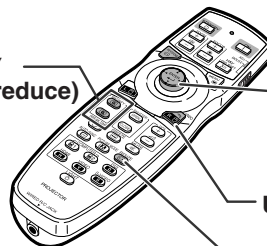

Mouse/adjustment
button (**▲**/**▼**/**◀**/**▶**)

UNDO button

RESIZE button

2 Press **UNDO** on the remote control to cancel the operation.

- The magnification then returns to x1.

Note

In the following cases, the image will return to the normal size (x1).

- When switching the input mode.
- When **UNDO** has been pressed.
- When the input signal is changed.
- When the input signal resolution and refresh rate (vertical frequency) change.
- When **RESIZE** has been pressed.

Freezing a Moving Image

1 Press **FREEZE** on the remote control.

- The projected image is frozen.

2 Press **FREEZE** again to return to the moving image from the currently connected equipment.



Selecting the Picture Mode

You can select the suitable picture mode for the projected image, such as movie or video game.

Press **PICTURE MODE** on the remote control.

- When pressing **PICTURE MODE**, the picture mode changes in order of

→ STANDARD → PRESENTATION → MOVIE → CUSTOM →

Note

- Press **UNDO** to return to the “STANDARD” mode while the selected picture mode is displayed.
- This function can also be accessed from the OSD menu (see page 49).

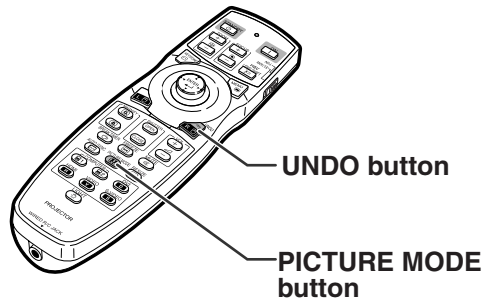

This function allows you to modify or customize the resize mode to enhance the input image. Depending on the input signal, you can choose a desired image.

Resize Mode

Press **RESIZE** on the remote control.

- Pressing **RESIZE** changes the display as shown in the tables below.
- To return to the standard image, press **UNDO** while “**RESIZE**” is displayed on the screen.
- This function can also be accessed from the OSD menu (see page 56).

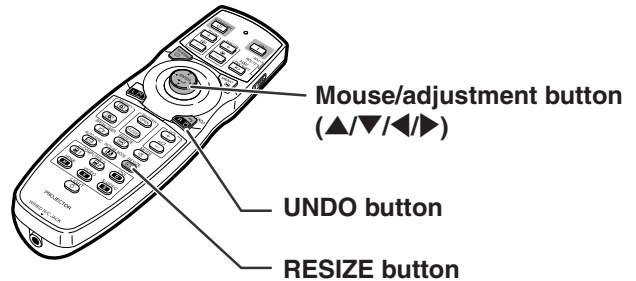

COMPUTER

	Main resolution	NORMAL	FULL	DOT BY DOT	BORDER	STRETCH
4:3 aspect ratio	SVGA (800 × 600)	1024 × 768	—	800 × 600	768 × 576	1024 × 576
	XGA (1024 × 768)			—		
	SXGA (1152 × 864)			1152 × 864		
	SXGA+ (1400 × 1050)			1400 × 1050		
Other aspect ratios	SXGA (1280 × 1024)	968 × 768	1024 × 768	1280 × 1024	720 × 576	—
	1280 × 720	1024 × 576		1280 × 720	960 × 576	
	1360 × 768	1024 × 578		1360 × 768		
	1366 × 768	1024 × 576		1366 × 768		
	1280 × 768	1024 × 614		1280 × 768		922 × 576
	1280 × 800	1024 × 640		1280 × 800	922 × 576	1024 × 576

Input signal		For 4:3 screen			For 16:9 screen		
Computer	Image type	NORMAL	FULL	DOT BY DOT	BORDER	STRETCH	
Resolution lower than XGA	 4:3 aspect ratio		— *2		*1	*1	
XGA				— *2			—
SXGA (1152 × 864)				Resolution higher than SXGA			
SXGA (1280 × 1024)	 5:4 aspect ratio					*1	*1
1280 × 720	 16:9 aspect ratio	*1			— *2	— *2	
1360 × 768 1366 × 768	 16:10 aspect ratio	*1			*1	*1	
1280 × 768							
1280 × 800	 16:10 aspect ratio	*1			*1	*1	
1280 × 800					*1		





























■: Cutout area on which images cannot be projected



⋯: Area where the signals are off screen

*1 The Digital Shift function can be used for these images.

*2 Same as NORMAL mode.

VIDEO/DTV

Input signal		For 4:3 screen			For 16:9 screen		
Video/DTV	Image type	NORMAL	AREA ZOOM	V-STRETCH	BORDER	STRETCH	SMART STRETCH
480I, 480P, 576I, 576P, NTSC, PAL, SECAM	 4:3 aspect ratio				 *1	 *1	 *1
	 Squeeze				 *1	 *1	 *1
	 Letter box					 *1	 *1
720P, 1035I, 1080I, 1080P	 16:9 aspect ratio						
540P	 16:9 aspect ratio				—*2	—*2	—*2
	 (4:3 aspect ratio in 16:9)						

 : Cutout area on which images cannot be projected
 : Area on which the image is not included in the original signals

*1 The Digital Shift function can be used for these images.

*2 Same as NORMAL mode.

About Copyrights

- When using the RESIZE function to select an image size with a different aspect ratio to a TV program or video image, the image will look different from its original appearance. Keep this in mind while choosing an image size.
- The use of the Resize or Keystone Correction function to compress or stretch the image for commercial purposes/public displays in a café, hotel, etc. may be an infringement of copyright protected by law for copyright holders. Please use caution.

Hiding the Projected Image (Shutter function)

This function allows you to temporarily hide the projected image.

- 1 Press **SHUTTER CLOSE**.
 - The projected image is hidden.

- 2 Pressing **SHUTTER OPEN** will turn the projected image back on.

Note

In the following cases, hiding will be cancelled automatically.

- When **STANDBY** on the projector or on the remote control is pressed.
- When a caution or information message is displayed.
- When the power is turned on.



Displaying and Setting the Break Timer

This function allows you to show the remaining time for break during meeting.

- 1 Press **BREAK TIMER**.

- 2 While “☕” is displayed, press ▲, ▼, ◀ or ▶ to set the break timer.
 - You can set anywhere between 1 and 60 minutes (in 1 units).
 - The break timer starts to count down as soon as ▲, ▼, ◀ or ▶ is pressed.

Note

- Pressing **UNDO** will cancel the break timer.
 - Auto Power Off function will be temporarily disabled during the break timer.
- When no input signal is detected for more than 15 minutes, the projector will automatically enter the standby mode if the break timer has elapsed.
- The break timer will be displayed on the startup image. To change the screen displayed during the break timer, change the setting of “Startup Image” (see page 58).
 - When “Slave” is set for “Stack Setting”, the break timer is not displayed. (See page 62.)

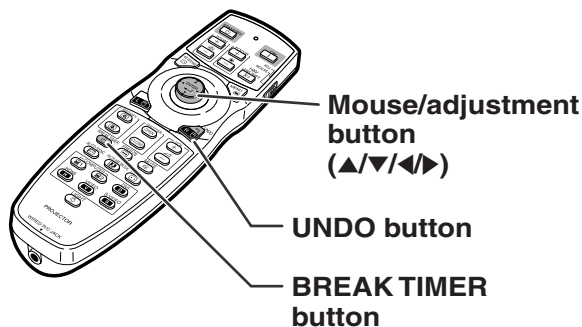

▼On-screen display



Menu Items

The following shows the items that can be set in the projector.

“Picture” menu

COMPUTER1/2, DVI, HDMI

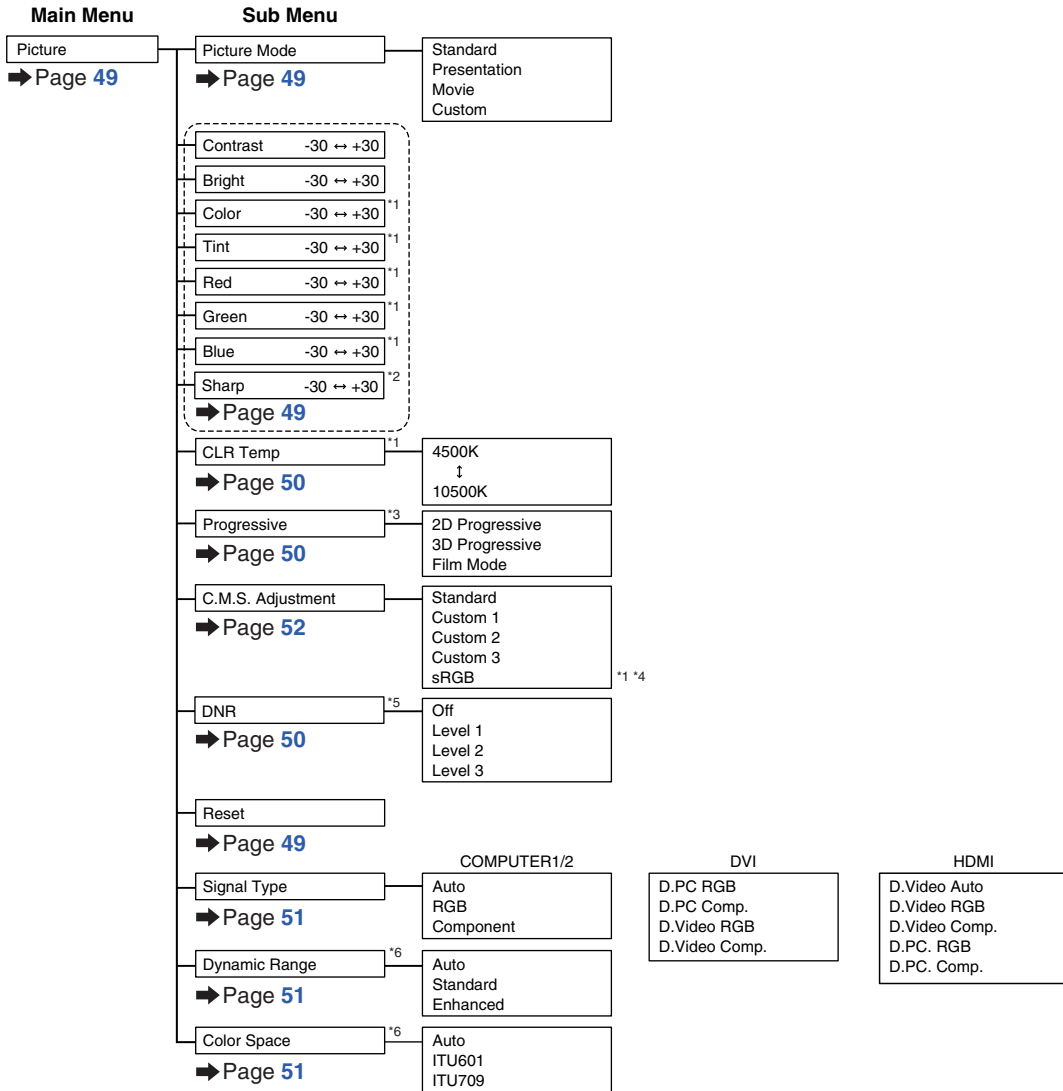

*1 “Color”, “Tint”, “Red”, “Green”, “Blue” and “CLR Temp” cannot be adjusted when “C. M. S. Adjustment” is set to “sRGB”.

*2 “Sharp” can be adjusted only when 480I, 480P, 540P, 576I, 576P, 720P, 1035I, 1080I or 1080P signal is input.

*3 “Progressive” can be adjusted only when 480I or 576I signal is input.

*4 “sRGB” can be selected under the conditions below.

- When “Signal Type” is set to “RGB”, “D. PC. RGB” or “D. Video RGB”.
- When “Signal Type” is set to “Auto” or “D. Video Auto” and the input signal is distinguished as “RGB”.

*5 “DNR” can be adjusted only when 480I, 480P, 576I or 576P signal is input.

*6 “Dynamic Range” and “Color Space” can be worked only when DVI or HDMI signal is input.

“Picture” menu

VIDEO/S-VIDEO

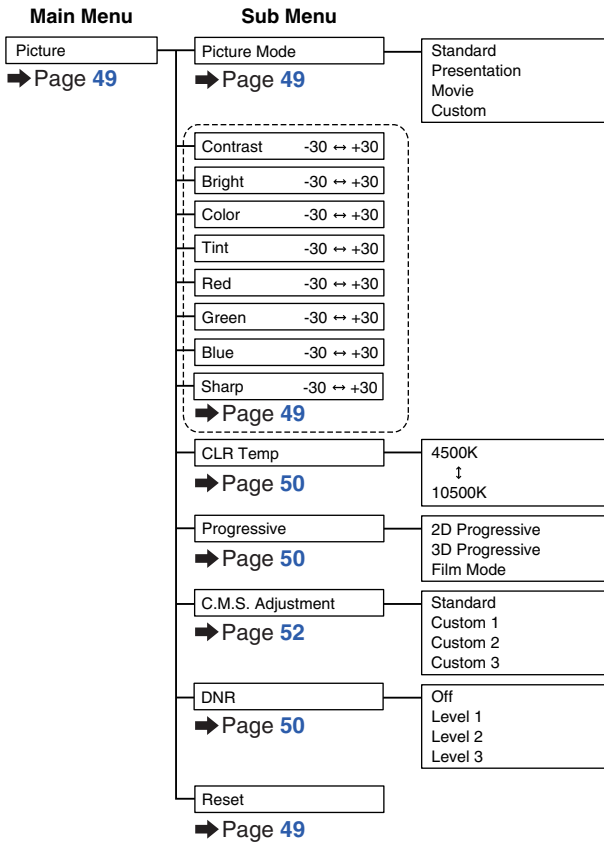

“C.M.S.” menu

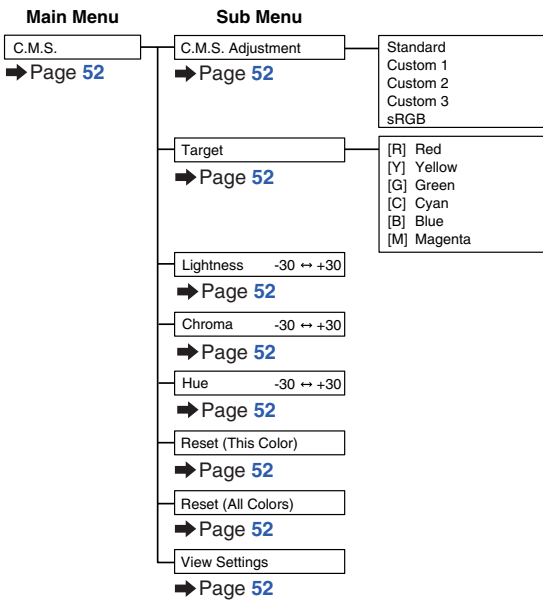

“Fine Sync” menu

COMPUTER1/2, DVI, HDMI

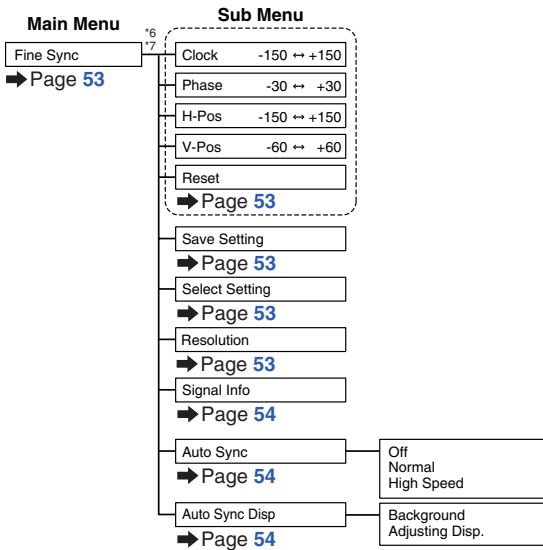

*6 The “Fine Sync” menu is displayed only while the input mode is COMPUTER1/2, DVI or HDMI.

*7 “Clock”, “Phase”, “H-Pos”, “V-Pos”, “Reset”, “Save Setting”, “Select Setting” and “Resolution” can be adjusted only while the input mode is COMPUTER1 or 2.

“Audio” menu

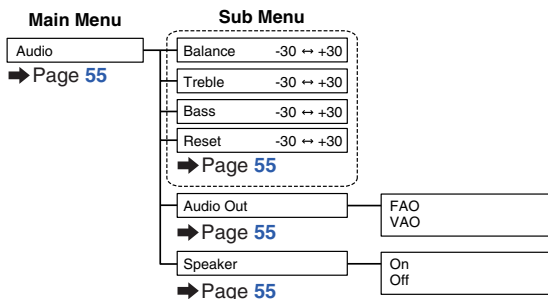

“Options 1” menu

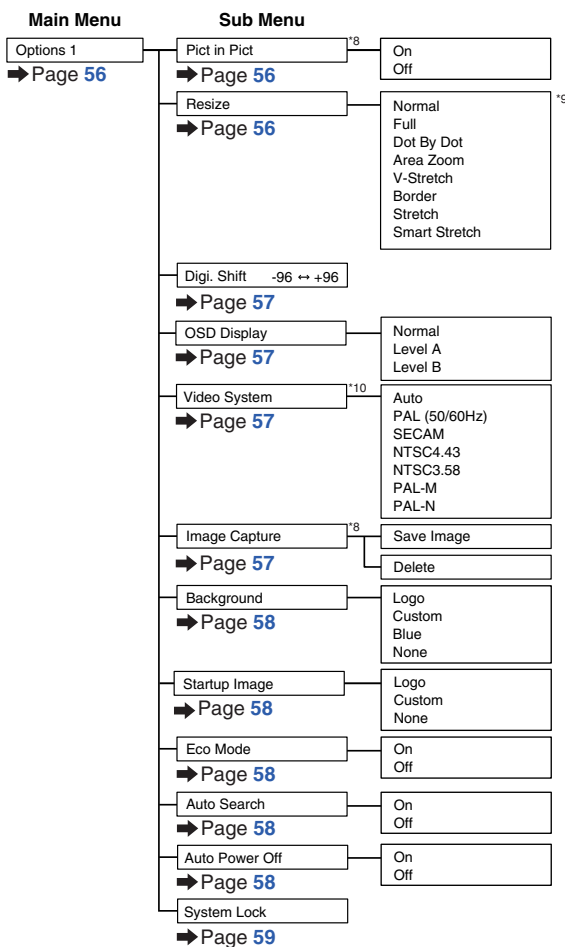

*8 Item when inputting RGB signal through COMPUTER1/2, DVI or HDMI.

*9 Selectable items in “Resize” mode may differ depending on the signal.

*10 Item when selecting VIDEO or S-VIDEO.

“Options 2” menu

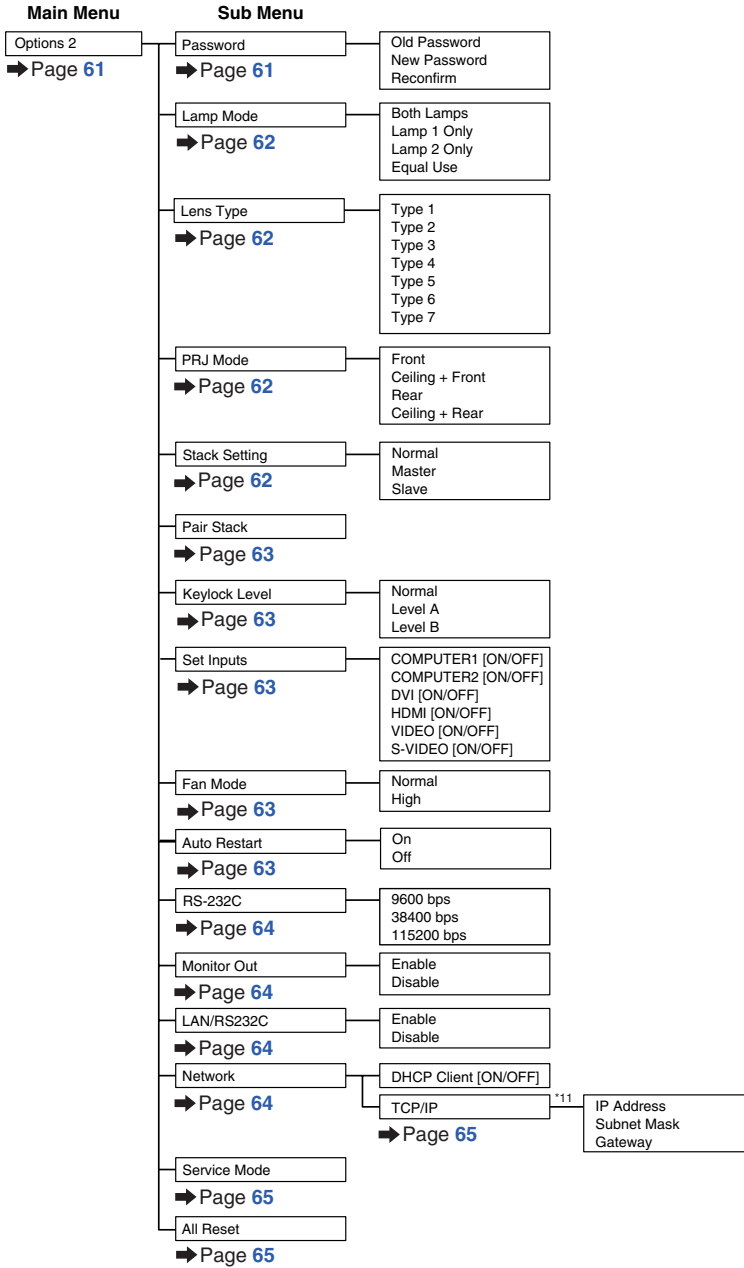

*11 Adjustable only when “DHCP Client” is set to “OFF”

“Language” menu

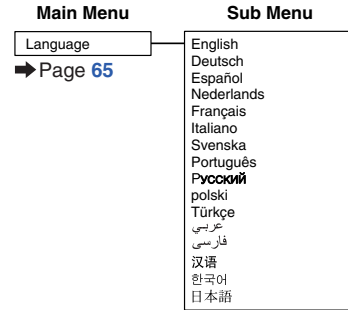

“Status” menu

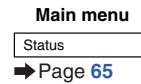

Using the Menu Screen

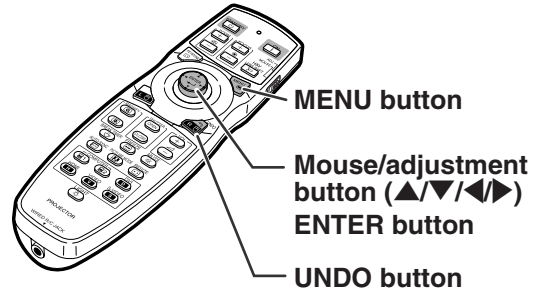
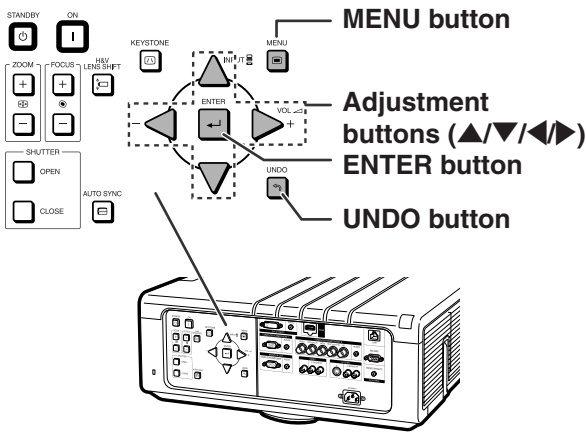

Menu Selections

• This operation can also be performed by using the buttons on the projector.

1 Press **MENU**.

• The “Picture” menu screen for the selected input mode is displayed.

2 Press **◀** or **▶** to display the other menu items.



• Menu items are as shown below.

Menu item
Picture
C.M.S.
Fine Sync
Audio
Options 1
Options 2
Language
Status

Note

• The “Fine Sync” menu is not available for VIDEO or S-VIDEO.

Example: “Picture” screen menu for **COMPUTER1 (RGB) mode**

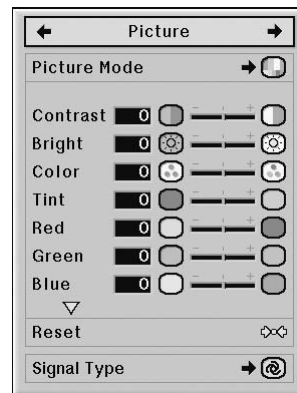

Using the Menu Screen

There are two methods of adjustment depending on the menu item. Use the applicable method from Example 1 or 2 shown below.

Example 1: Adjusting “Bright”

3 Press ▲ or ▼ to select the item you want to adjust.

- Pressing ▼ displays the items on the lower part of the “Picture” menu.

To adjust the projected image while viewing it

Press ENTER.

- The selected single adjustment item (e.g. “Bright”) appears instead of the menu.
- When pressing ▲ or ▼, the following item (“Color” after “Bright”) will be displayed.

Note

- Press **UNDO** to return to the previous screen.

4 Press ◀ or ▶ to adjust the item selected.

- The adjustment is stored.

5 Press MENU.

- The menu screen will disappear.

Example 2: Selecting “Signal Type”

3 Press ▲ or ▼ to select the item you want to set and then press ENTER.

4 Press ▲ or ▼ to select the desired item and then press ENTER.

5 Press MENU.

- The menu screen will disappear.

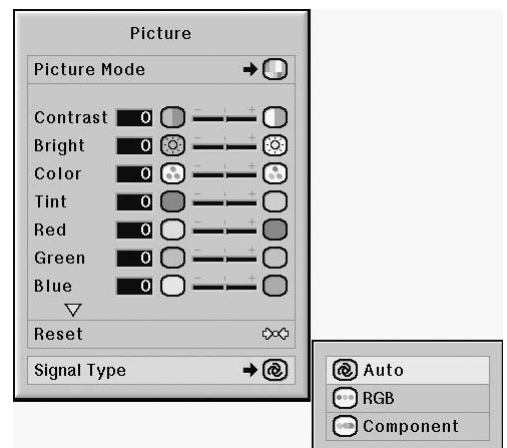
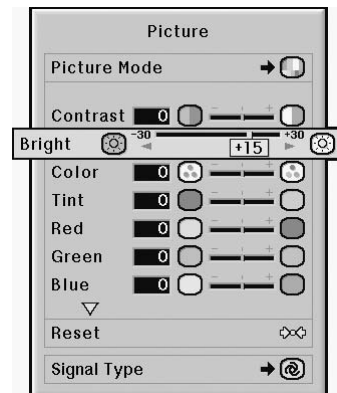
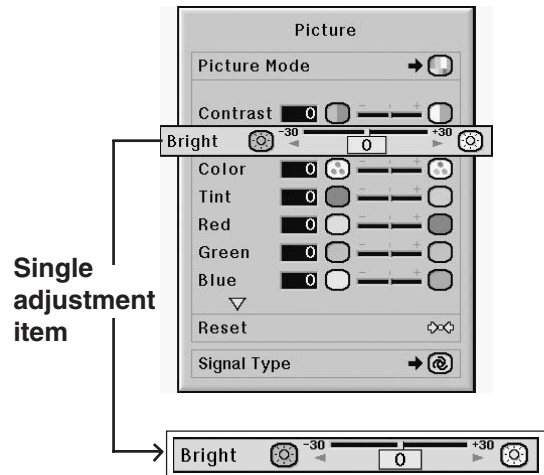

Picture Adjustment (“Picture” menu)

Menu operation ➡ Page 47

▶ Page 1

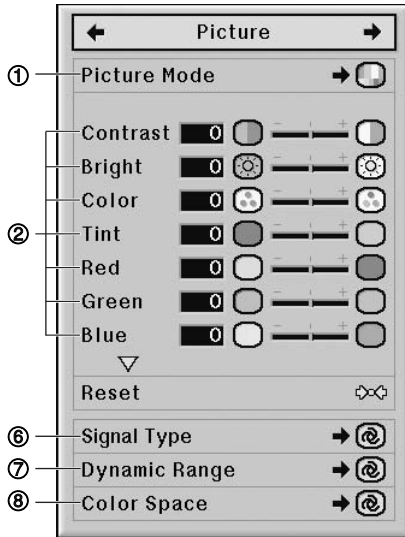

▶ Page 2

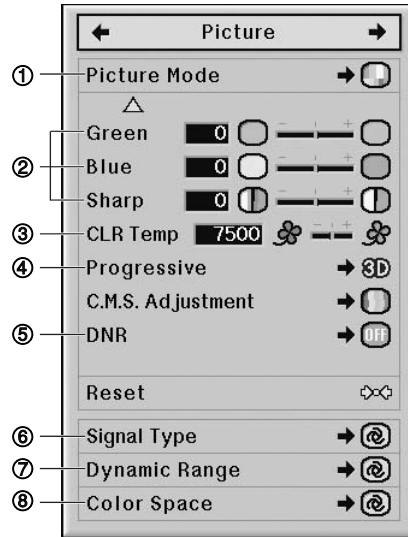

① Selecting the Picture Mode

This function allows you to select the picture mode in accordance with brightness of the room or content of the image to be projected. In all picture modes, items on the “Picture” menu can be adjusted and saved.

Selectable items	Description
Standard	For standard image
Presentation	Brightens darker portions of image for more enhanced presentations.
Movie	Gives greater depth to darker portions of image for a more exciting theater experience.
Custom	The factory preset value is the same as the one of “Standard”. Using the dedicated software “Sharp Gamma Manager” allows you to adjust the gamma curve. Visit “ http://sharp-world.com/projector/ ” for details.

Note

- You can also press **PICTURE MODE** on the remote control to select the picture mode. (See page 38.)

② Adjusting the Image

Select a picture mode before adjusting the image.

Selectable items	Press ◀	Press ▶
Contrast	For less contrast	For more contrast
Bright	For less brightness	For more brightness
Color ^{*1}	For less color intensity	For more color intensity
Tint ^{*1}	For making skin tones purplish	For making skin tones greenish
Red ^{*1}	For weaker red	For stronger red
Green ^{*1}	For weaker green	For stronger green
Blue ^{*1}	For weaker blue	For stronger blue
Sharp ^{*2}	For less sharpness	For more sharpness

*1 “Color”, “Tint”, “Red”, “Green” and “Blue” cannot be adjusted when “C.M.S. Adjustment” on the “C.M.S.” menu is set to “sRGB”. (See page 52.)

*2 “Sharp” can be adjusted only when 480I, 480P, 540P, 576I, 576P, 720P, 1035I, 1080I or 1080P DTV signal is input during the COMPUTER1/2, DVI, HDMI mode; or the input mode is set to VIDEO or S-VIDEO.

Note

- To reset all adjustment items, select “Reset” and press **ENTER**.

③ Adjusting the Color Temperature

Selectable items	Description
4500K	For lower color temperature for warmer, reddish incandescent-like images.
↕	↕
10500K	For higher color temperature for cooler, bluish, fluorescent-like images.

Note

- “CLR Temp” cannot be set when “C.M.S. Adjustment” on the “C.M.S.” menu is set to “sRGB”. (See page 52.)

④ Selecting the Progressive Mode

Selectable items	Description
2D Progressive	Useful to display fast-moving images such as sports and action films.
3D Progressive	Useful to display relatively slowmoving images such as drama and documentary more clearly.
Film Mode	Reproduces the image of film source* clearly. Displays the optimized image of film transformed with three-two pull down (NTSC and PAL60Hz) or two-two pull down (PAL50Hz and SECAM) enhancement to progressive mode images.

* The film source is a digital video recording with the original encoded as is at 24 frames/second. The projector can convert this film source to progressive video at 60 frames/second with NTSC and PAL60Hz or at 50 frames/second with PAL50Hz and SECAM to play back a high-definition image.

Note

- In NTSC or PAL60Hz, even if the 3D Progressive mode has been set, the three-two pull down enhancement will be enabled automatically when the film source has been entered.
- When the image is blurred or noisy, switch to the optimal mode.
- When using progressive inputs, inputs are directly displayed so that “2D Progressive”, “3D Progressive” and “Film Mode” cannot be selected.

⑤ Reducing Image Noise (DNR)

Video digital noise reduction (DNR) provides high quality images with minimal dot crawl and cross color noise.

Selectable items	Description
Off	DNR does not function.
Level 1–3	Sets the DNR level.

Note

- Set a level so as to view a clearer picture.
- Make sure to set “DNR” to “Off” in the following cases:**
- When the image is blurry.
 - When the contours and colors of moving images drag.
 - When TV broadcasts with weak signals are projected.

Info

- This function is available for all signals with VIDEO or S-VIDEO.
- This function is available for 480I, 480P, 576I and 576P signals with COMPUTER1/2, DVI or HDMI.

⑥ Selecting the Signal Type

When using an input mode other than S-VIDEO or VIDEO input, set the signal type setting to the corresponding input signal type (RGB or Component).

■ When COMPUTER1/2 is selected for the input mode

Selectable items	Description
Auto	Automatically selects the appropriate input signal between RGB and Component.
RGB	Set when RGB signals are received.
Component	Set when component signals are received.

■ When DVI is selected for the input mode

Selectable items	Description
D. PC RGB	Set when digital PC RGB signals are received from the computer.
D. PC Comp.	Set when digital PC component signals are received from the computer.
D. Video RGB	Set when digital video RGB signals are received from video equipment.
D. Video Comp.	Set when digital video component signals are received from video equipment.

■ When HDMI is selected for the input mode

This function sets the type of picture signal input from HDMI-compatible equipment.

Selectable items	Description
D. Video Auto	Automatically set the RGB or component signal when digital video signals are received from video equipment.
D. Video RGB	Set when digital video RGB signals are received from video equipment.
D. Video Comp.	Set when digital video component signals are received from video equipment.
D. PC RGB	Set when digital PC RGB signals are received from the computer.
D. PC Comp.	Set when digital PC component signals are received from the computer.

⑦ Selecting the Dynamic Range

An optimum picture may not be displayed if a DVI-D or HDMI capable device's output signal type and the projector's input signal type do not match. If this should occur, switch the "Dynamic Range" mode.

Selectable items	Description
Auto	In most circumstances, "Auto" should be selected.
Standard	When the black levels of the image show banding or appear faded, select the item that results in the better picture quality.
Enhanced	

⑧ Selecting the Color Space

This function select the color space for signals input from a DVI-D- or HDMI-compatible device.

Selectable items	Description
Auto	In most circumstances, "Auto" should be selected.
ITU601	Select the item that results in the better picture quality.
ITU709	

Color Management System (“C. M. S.” menu)

Menu operation ➡ Page 47

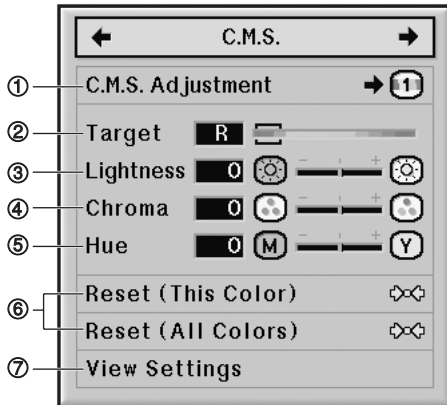

① Selecting the Color Reproduction Mode

This function allows you to select the color reproduction mode for the projected images.

Selectable items	Description
Standard	Standard settings
Custom 1 – 3	“Lightness”, “Chroma” and “Hue” can be adjusted for each of the six colors.
sRGB	A natural tint based on an original image from the computer.

Note

- sRGB is an international standard of color reproduction regulated by the IEC (International Electrotechnical Commission). As the fixed color area has been decided by the IEC, the images are displayed in a natural tint based on an original image, when “C.M.S. Adjustment” is set to “sRGB”.
- You cannot set “Color”, “Tint”, “Red”, “Green”, “Blue”, “CLR Temp” on the “Picture” menu, when “C.M.S. Adjustment” is set to “sRGB”.
- For additional information about the sRGB function, visit “<http://www.srgb.com/>”.

Info

- When “C.M.S. Adjustment” is set to “sRGB”, the projected image may become dark, but this does not indicate a malfunction.

② Selecting the Target Color

This function allows you to select the target color for adjusting the display characteristics.

R	Red	C	Cyan
Y	Yellow	B	Blue
G	Green	M	Magenta

③ Setting the Brightness of the Target Color

This function allows you to set the brightness of the selected target color.

Press ◀	Press ▶
For less brightness of the target color	For more brightness of the target color

④ Setting the Chromatic Value of the Target Color

This function allows you to set the chromatic value of the selected target color.

Press ◀	Press ▶
For less chromatic value of the target color	For more chromatic value of the target color

⑤ Setting the Hue of the Target Color

This function allows you to set the hue of the selected target color.

Press ◀	Press ▶
For stronger red of the target color	For stronger yellow of the target color

⑥ Resetting User-defined Color Settings

This function allows you to reset the specific target color or all of the six colors.

Selectable items	Description
Reset (This Color)	“Lightness”, “Chroma” and “Hue” of the color selected for “Target” are reset.
Reset (All Colors)	“Lightness”, “Chroma” and “Hue” of all colors are reset.

⑦ Overview of All Color Settings

This function allows you to confirm the settings of all the colors.

Computer Image Adjustment (“Fine Sync” menu)

Menu operation ➡ Page 47

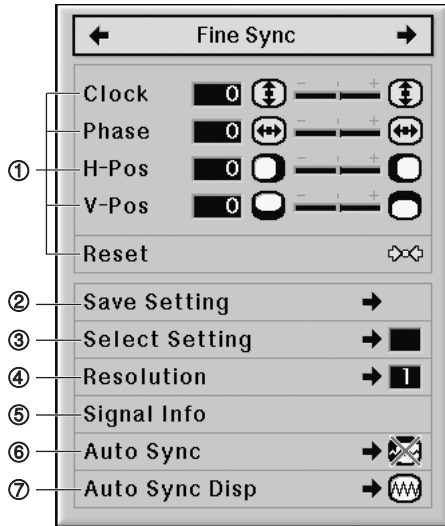

① Adjusting the Computer Image

Use the Fine Sync function in case of irregularities such as vertical stripes or flickering in portions of the screen.

Selectable items	Description
Clock	Adjusts vertical noise.
Phase	Adjusts horizontal noise (similar to tracking on your VCR).
H-Pos	Centers the on-screen image by moving it to the left or right.
V-Pos	Centers the on-screen image by moving it up or down.

Note

- You can automatically adjust the computer image by setting “Auto Sync” on the “Fine Sync” menu to “Normal” or “High Speed”, or by pressing **AUTO SYNC** on the projector or on the remote control. See page 54 for details.
- To reset all adjustment items, select “Reset” and press **ENTER**.

② Saving Adjustment Settings

This projector allows you to store up to seven adjustment settings for use with various computers.

③ Accessing Adjustment Settings

Adjustment settings stored in the projector can be easily accessed.

Note

- If a memory has not been set, the resolution and frequency setting will not be displayed.
- When selecting a stored adjustment setting with “Select Setting”, you can set the projector in the stored adjustments.

④ Setting the Resolution

Ordinarily, the type of input signal is detected and the correct resolution mode is automatically selected. However, for some signals, the optimal resolution mode in “Resolution” on the “Fine Sync” menu may need to be selected to match the computer display mode.

Note

- If your computer displays patterns which repeat every other line (horizontal stripes), flickering may occur which makes the image hard to see.
- See “Checking the Input Signal” on page 54 for information on the currently selected input signal.

⑤ Checking the Input Signal

You can check the input signal information.

⑥ Auto Sync Adjustment

Used to automatically adjust a computer image.

Selectable items	Description
Off	Auto Sync adjustment is not automatically performed.
Normal	Auto Sync adjustment will occur when the projector is turned on or when the input signals are switched, when connected to a computer.
High Speed	“Normal” takes more time than “High Speed” for more accurate Auto Sync adjustment.

Note

- Auto Sync adjustment is also performed by pressing **AUTO SYNC** on the projector or on the remote control.
- The Auto Sync adjustment may take some time to complete, depending on the image of the computer connected to the projector.
- When the optimum image cannot be achieved with Auto Sync adjustment, use manual adjustments. (See page 53.)
- When **AUTO SYNC** is pressed while “Auto Sync” is “High Speed” or “Off”, Auto Sync will be executed in “High Speed” mode. If the button is pressed again within one minute, Auto Sync will be executed in “Normal” mode.

⑦ Setting the Auto Sync Display Function

Used to set the display during Auto Sync.

Selectable items	Description
Background	The image set as a background image is projected. See page 58.
Adjusting Disp.	The computer image being adjusted is displayed.

Audio Adjustment (“Audio” menu)

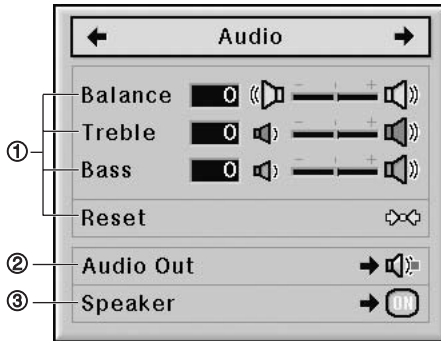

① Adjusting the Audio

This function allows you to adjust the projector’s audio.

Selectable items	Press ◀	Press ▶
Balance	Increased audio from the left speaker	Increased audio from the right speaker
Treble	For weaker treble	For stronger treble
Bass	For weaker bass	For stronger bass

Note

- To reset all adjustment items, select “Reset” and press **ENTER**.

② Setting the Audio Output Type

This function determines whether the audio level output from the AUDIO OUTPUT terminal is fixed or variable by linking with VOLUME.

Selectable items	Description
FAO (Fixed Audio Output)	Audio output that does not vary in strength with the volume level of the source projector.
VAO (Variable Audio Output)	Audio output that varies in strength with the volume level of the source projector.

Info

- When “Audio Out” has been set to “VAO”, first make sure to lower the volume of the projector before turning the power on or off and when switching the input.

Note

- When the projector is connected to audio equipment:
 - It is recommended that “FAO” be selected on “Audio Out”. Because the audio signal from the audio equipment does not vary in strength with the volume level of the projector, you can enjoy better sound.
 - When “FAO” is selected on “Audio Out”, video and audio may not synchronize.
 - When connecting audio equipment that has a function for adjusting audio delay time, adjust the delay time for synchronizing video and audio.
 - When the audio equipment does not have such a function and the unsynchronized video and audio bothers you, select “VAO” on “Audio Out”. Selecting “VAO” synchronizes video and audio automatically.
 - The HDMI audio will not output from the MONITOR OUT AUDIO terminal when the projector is in the standby mode.

③ Setting the Speaker

This function allows you to turn the audio output of the internal speaker on or off when the projector is connected to an external amplifier.

Selectable items	Description
On	The audio signal is output from the internal speaker.
Off	The audio signal is not output from the internal speaker.

Note

- The HDMI audio will not output from the MONITOR OUT AUDIO terminal when the projector is in the standby mode.

Using the “Options 1” Menu

COMPUTER1/2, DVI, HDMI

Menu operation ➡ Page 47

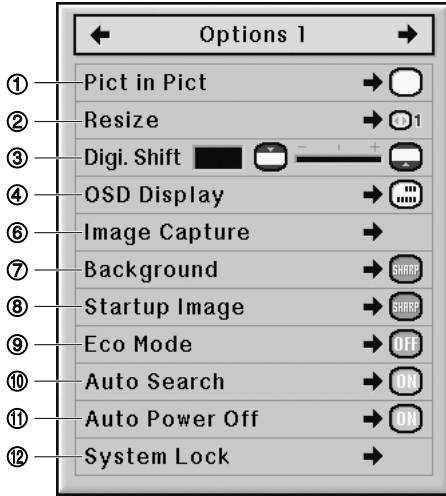

VIDEO, S-VIDEO

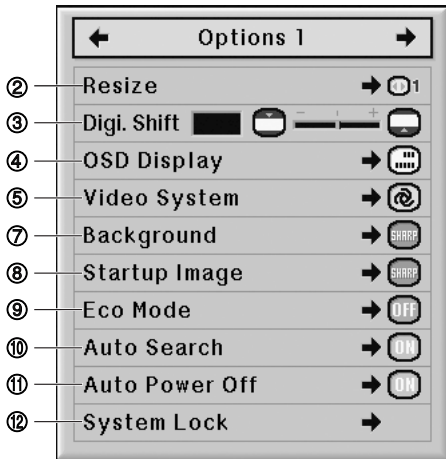

① Displaying Dual Pictures (Pict in Pict)

The Pict in Pict (picture in picture) function allows you to display two pictures on the same screen. You can display the image input from VIDEO or S-VIDEO as an inset picture overlapping the main picture input from COMPUTER1/2, DVI or HDMI.

Note

- You can press ▲ / ▼ / ◀ / ▶ on the projector or on the remote control to change the location of the inset picture image. (The inset picture frame will be displayed. To display the inset picture to the desired position, move the frame and press **ENTER** on the projector or on the remote control.)
- When “On” is selected, **INPUT** and **VOL** on the projector will function as location shift button for the inset picture.
- Inset picture can only be displayed in composite video or S-video signal of NTSC/PAL/SECAM.
- The audio of the inset picture will come out of the projector’s speakers.
- While the “Pict in Pict” function is working, the “FREEZE” function only works for the inset picture.
- The “Pict in Pict” function does not work when the following signals are input to the main picture.
 - UXGA/SXGA+/SXGA/WXGA signal
 - 480I/480P/540P/576I/576P/720P/1035I/1080I/1080P signal
 - Interlaced RGB signal
 - All signals (when “Resize” is set to “Dot by Dot”)
 - No signal (or when the resolution or refresh rate (vertical frequency) of the signal is changed)

② Setting the Resize Mode

Depending on the input signal, you can select the screen image.

When inputting RGB signal	When inputting HDMI/DTV/video signal
Normal	Normal
Full	Area Zoom
Dot By Dot	V-Stretch
Border	Border
Stretch	Stretch
	Smart Stretch

Note

- For details of the Resize mode, see pages 39 and 40.
- You can also press **RESIZE** on the remote control to change the Resize mode. (See page 39.)

③ Shifting the Projected Image Vertically (Digital Shift)

For easier viewing, this function shifts the image projected on the screen up or down eliminating either the upper or lower black band found in 16:9 and other wide aspect ratios.

Press ◀	Press ▶
Shifts the projected image down.	Shifts the projected image up.

Note

- This function will not work depending on the type of resize mode. See pages 39 and 40 for details.

④ Setting On-screen Display

This function allows you to turn the on-screen messages on or off.

Selectable items	Description
Normal	All on-screen displays are displayed.
Level A	INPUT/VOLUME/MUTE/FREEZE/AUTO SYNC/MAGNIFY/ "An invalid button has been pressed." are not displayed.
Level B	All on-screen displays are not displayed (except the menu, H&V LENS SHIFT, KEYSTONE, FOCUS, ZOOM, "All buttons on Projector are locked." and warning displays).

Note

- When "Keylock Level" is set to "Level A" or "Level B", pressing **STANDBY** displays "All buttons on Projector are locked." regardless of the "OSD Display" setting.

⑤ Setting the Video System

The video input system mode is factory preset to "Auto"; however, a clear picture from the connected audio-visual equipment may not be received, depending on the video signal difference. In that case, switch the video signal.

Selectable items	Description
PAL (50/60 Hz)	When connected to PAL video equipment.
SECAM	When connected to SECAM video equipment.
NTSC4.43	When reproducing NTSC signals in PAL video equipment.
NTSC3.58	When connected to NTSC video equipment.

Note

- The video signal can only be set in VIDEO or S-VIDEO mode.
- When "Video System" is set to "Auto", you may not receive a clear picture due to signal differences. Should this occur, switch to the video system of the source signal.
- While "Video System" is set to "Auto", when PAL-M or PAL-N signal is input, the image from PAL signal will be displayed.

⑥ Capturing Projected Images

This projector allows you to capture projected images (RGB signals) and set them as a startup image, or background image when no signals are being received.

Note

- Images can be captured only when they are from XGA (1024 × 768) non-interlace signals in COMPUTER1/2, DVI or HDMI mode with "RESIZE" set to "Normal".
- The saved image is reduced to 256 colors.
- Images from equipment connected to VIDEO or S-VIDEO terminal cannot be captured.
- Only one image can be captured and saved.
- The color of images may differ before and after saving if an image is captured on which image adjustment has been performed using the "C.M.S." function.
- To delete the captured image, select "Delete", and then press **ENTER**.

⑦ Selecting the Background Image

Selectable items	Description
Logo	Default image
Custom	User customized image (e.g. company logo)
Blue	Blue screen
None	Black screen

Note

- When “Custom” is selected, an image saved using “Image Capture” can be displayed as a background image.

⑧ Selecting the Startup Image

Selectable items	Description
Logo	Default image
Custom	User customized image (e.g. company logo)
None	Black screen

Note

- When “Custom” is selected, an image saved using “Image Capture” can be displayed as a startup image.

⑨ Setting the Eco Mode

When the two lamps are lit at the same time

Selectable items	Brightness	Power consumption (When using AC 100V)	Lamp life
On	Approx. 77%	82%	Approx. 3,000 hours*
Off	100%	100%	Approx. 2,000 hours*

* This is a reference value and is not guaranteed.

Note

- When “Eco Mode” is set to “On”, the power consumption will decrease and the lamp life will extend.

⑩ Detecting the Input Signals Automatically

Selectable items	Description
On	Automatically searches for and switches to the input mode in which signals are being received.
Off	“Auto Search” does not function.

Note

- While the “Auto Search” function is detecting the input signal, pressing a button on the projector or the remote control stops the “Auto Search” function. After the “Auto Search” function finishes completely, press the desired button.

⑪ Setting the Auto Power Off Function

Selectable items	Description
On	The projector automatically enters the standby mode when no input signal is detected for 15 minutes or longer.
Off	The “Auto Power Off” function will be disabled.

Note

- When “Auto Power Off” is set to “On”, 5 minutes before the projector enters the standby mode, the message “Enter STANDBY mode in X min.” will appear on the screen to indicate the remaining minutes.

12 Setting the System Lock Function

This function prevents unauthorized use of the projector. Once this function is activated, users must enter the correct keycode each time the projector is turned on. We suggest you record the keycode in a safe place where only authorized users have access.

Info

- If you lose or forget your keycode, contact your nearest Sharp Authorized Projector Dealer or Service Center (see page 81). Even if the product warranty is valid, the keycode reset will incur a charge.

Setting the keycode

1 Select “System Lock” on the “Options 1” menu, then press **▶**.

- A message is displayed.
- Read this message, and press **ENTER**.

2 Press the 4 buttons on the remote control or on the projector to enter the preset keycode in “Old Code”.

- When setting the keycode for the first time, press **▼** on the projector for four times.

Old Code	 - - -
New Code	- - - -
Reconfirm	- - - -

Note

- If you input a wrong keycode, the cursor returns to the first point of the “Old Code”.
- The preset keycode is 4 **▼** buttons on the projector. If this keycode is set, the keycode input screen does not appear when turning the power on.

3 Press the 4 buttons on the remote control or on the projector to enter the new keycode in “New Code”.

Note

- You cannot use the following buttons for keycode:
ON, STANDBY, ENTER, L-CLICK, R-CLICK/UNDO, MENU, ZOOM, FOCUS, H&V LENS SHIFT
- **System Lock function recognizes each button on the remote control or on the projector as an individual button, even if they share the same button name. If you set the keycode with the buttons on the projector, use only those buttons on the projector. If you set the keycode with the buttons on the remote control, use only those buttons on the remote control.**

4 Enter the same keycode in “Reconfirm”.

Note

Not displaying the keycode input screen when turning the projector on

- Press **▼** on the projector for four times in steps 3 and 4 above.

When the System Lock is set

- When System Lock is set, the keycode input screen appears after the power is turned on. When it appears, enter the right keycode to start projection. Failure to enter the keycode will cause images not to be projected even when signals are entered to the projector.

Changing the keycode

Old Code	■ - - -
New Code	- - - -
Reconfirm	- - - -

- 1** Press the 4 buttons on the remote control or on the projector to enter the preset keycode in “Old Code”.
- 2** Press the 4 buttons on the remote control or on the projector to enter the new keycode in “New Code”.
- 3** Enter the same keycode in “Reconfirm”.

When the system lock is set

If you have set the system lock, enter the keycode and follow the procedure below to release the system lock.

▼Input screen for keycode

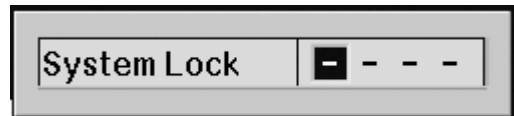

Note

- When System Lock is set, the keycode input screen appears after the power is turned on.
- If no keycode is entered, the image will not be displayed, even if the projector receives the input signal.

- 1** Press **ON** on the remote control or on the projector to turn on the projector.
- 2** When the keycode input screen appears, enter the right keycode to start projection.

Note

- System Lock function recognizes each button on the remote control or on the projector as an individual button, even if they share the same button name. If you set the keycode with the buttons on the projector, use only those buttons on the projector. If you set the keycode with the buttons on the remote control, use only those buttons on the remote control.

Helpful Functions Set during Installation (“Options 2” menu)

Menu operation ➡ Page 47

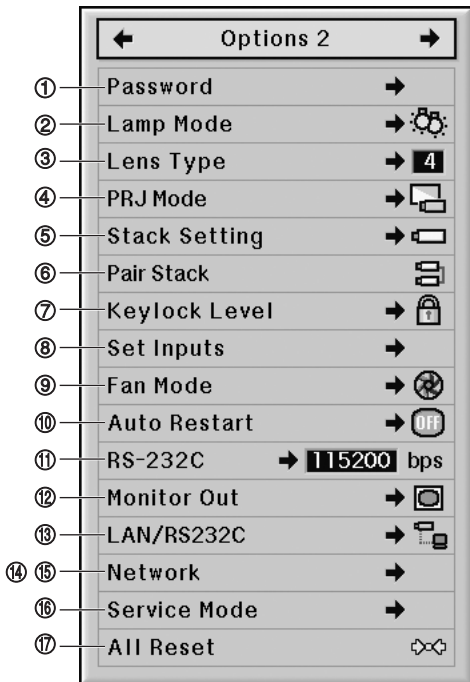

① Setting a Password

- There is no factory preset for the password, so the “Options 2” menu is enabled.
- If you do not want others to operate the “Options 2” menu, set a password.

1 Select “Password” from the “Options 2” menu, and press ►.

2 Press ▲ or ▼ to set the first digit in “New Password” and then press ►.

3 Enter the remaining 3 digits and press **ENTER**.

4 Enter the same password in “Reconfirm” and press **ENTER**.

Info

- The password must be entered to use the “Options 2” menu when a password has been set.

Changing the password

Old Password	■ - - -
New Password	- - - -
Reconfirm	- - - -

1 Press ▲, ▼ and ► to enter the password in “Old Password” and press **ENTER**.

2 Press ▲, ▼ and ► to set the new password in “New Password” and press **ENTER**.

3 Enter the same 4-digit password in “Reconfirm” and press **ENTER**.

Note

- If you do not want to set a password, leave the fields blank in steps 2 and 3 and press **ENTER**.
- To cancel the password settings, press **UNDO**.

If You Forget Your Password

If you forget the password, delete it using the following procedure and set a new password.

Press → → → → → → on the projector.

② Setting the Lamp Mode

This function allows you to select the usage of the two lamps installed in the projector.

Selectable items	Description
Both Lamps	Both lamps are used for greater brightness.
Lamp 1 Only	The lamp 1 is used. When the lamp 1 burns out, the lamp 2 automatically switches in use.
Lamp 2 Only	The lamp 2 is used. When the lamp 2 burns out, the lamp 1 automatically switches in use.
Equal Use	Both lamps are used alternately for certain periods.

③ Selecting the Lens Type

When you change the lens, you need to set the lens type. See the table below to select the lens type.

Selectable items	Attached lens
Type 1	AN-P8EX
Type 2	AN-P12EX
Type 3	AN-P15EZ
Type 4	AN-P18EZ
Type 5	AN-P23EZ
Type 6	AN-P30EZ
Type 7	AN-P45EZ

Info

- The Lens Shift, Keystone Correction, etc. may not properly function if the correct lens type is not selected.

Note

- When “Lens Type” is changed, “GEOMETRIC ADJUSTMENT”, “H&V KEYSTONE” and “IMAGE RESIZING” will be reset.

④ Reversing/Inverting Projected Images

This projector is equipped with a reverse/invert image function that allows you to reverse or invert the projected image for various applications.

Selectable items	Description
Front	Normal image
Ceiling + Front	Inverted image
Rear	Reversed image
Ceiling + Rear	Reversed and inverted image

Note

- This function is used for the reversed image and ceiling-mount setups. (See page 23.)

⑤ Controlling Multiple Projectors with the One Remote Control

This function allows you to control multiple projectors with the one remote control during the stack projection or the video wall projection. When using this function, connect the projectors with LAN cables and assign a projector as the master and the other projectors as the slaves. See page 27 for connecting LAN cables.

Selectable items	Description
Normal	The stack setting is not available.
Master	Set the projector as the master.
Slave	Set the projector as the slave.

Note

- When controlling multiple projectors with the one remote control, settings via web browser are required. Refer to the “SETUP MANUAL” contained on the supplied CD-ROM for details.
- Only when controlling two projectors with the one remote control, using “Pair Stack” allows you to skip settings via web browser. (See page 63.)
- When “Slave” is selected on “Stack Setting”, the slave projector cannot be controlled with the remote control. To control the slave projector with the remote control, connect the remote control to the projector. (See page 17.)

⑥ Shortcut to Make Projector Stack Settings

Normally, settings via web browser are required for the stack projection. You can skip the settings via web browser by using “Pair Stack”, only when you use the two projectors for the stack projection.

Note

- Before setting “Pair Stack”, select “Master” or “Slave” on “Stack Setting”.

1 Select “Pair Stack” on the “Option 2” menu, and then press **ENTER**.

- The confirmation screen will be displayed.

2 Select “OK”, and then press **ENTER**.

- The network settings of the projector will change as shown below.

	Master	Slave
IP Address	192.168.150.2	192.168.150.3
Subnet Mask	255.255.255.0	255.255.255.0
DHCP Client	OFF	OFF
Gateway	0.0.0.0	0.0.0.0
User Name	(Reset)	(Reset)
Password	(Reset)	(Reset)
Data Port	10002	10002

⑦ Locking the Operation Buttons on the Projector

This function can be used to lock the use of certain operation buttons on the projector.

Selectable items	Description
Normal	All operation buttons are functional.
Level A	Only INPUT/VOLUME buttons on the projector are available.
Level B	All operation buttons on the projector are unavailable.

⑧ Bypassing Unused Input Selections

This function allows you to skip the input mode that you rarely use. You can skip the input modes when “Auto Search” works.

Selectable items		Description
COMPUTER 1	ON	Sets each input mode selectable respectively.
COMPUTER 2		
DVI, HDMI, VIDEO, S-VIDEO	OFF	Sets each input mode unavailable respectively.

⑨ Selecting the Fan Mode

This function changes the fan rotation speed.

Selectable items	Description
Normal	Suitable for normal environments.
High	Select this when using the projector at attitudes of approximately 1,500 meters (4,900 feet) or more.

Note

- When “Fan Mode” is set to “High”, the fan rotation speeds up, and the fan noise becomes louder.

⑩ Setting the Auto Restart Function

Selectable items	Description
On	If the power cord is unplugged from the outlet or the breaker switch is turned off when the projector is on, then the projector automatically turns on when the power cord is plugged into the AC outlet or the breaker switch is turned on.
Off	The projector does not turn on automatically when the power cord is plugged into the AC outlet or the breaker switch is turned on.

11 Selecting the Transmission Speed (RS-232C)

Make sure that both the projector and computer are set for the same baud rate.

Selectable items	Description
9600 bps	Transmission speed is slow. ↑↓ Transmission speed is rapid.
38400 bps	
115200 bps	

Note

- Refer to the “SETUP MANUAL” contained on the supplied CD-ROM for RS-232C Specifications and Command Settings.
- Refer to the computer’s operation manual for instructions for setting the computer’s baud rate.

12 Setting the Monitor Output

When the Monitor Out has been set to “Enable”, the monitor output is activated and power is consumed even in the standby mode. It is recommended that the Monitor Out be set to “Disable” when it is not connected. This reduces power consumption when the projector is in the standby mode.

Selectable items	Description
Enable	The monitor output function is activated even if the projector is in standby mode.
Disable	The monitor output function is switched off when the projector is in standby mode.

13 Setting the LAN/RS232C

When the LAN/RS232C has been set to “Enable”, the LAN/RS232C is activated and power is consumed even in the standby mode. It is recommended that the LAN/RS232C be set to “Disable” when it is not connected. This reduces power consumption when the projector is in the standby mode.

Selectable items	Description
Enable	The LAN/RS232C function is activated even if the projector is in standby mode.
Disable	The LAN/RS232C function is switched off when the projector is in standby mode.

Note

- When you want to control the projector using the LAN/RS232C function, select “Enable.”
- The item “LAN/RS232C” will be made unavailable for setting when “Master” or “Slave” is selected on “Stack Setting”. (“LAN/RS232C” will be set to “Enable” automatically.) (See page 62.)

14 Setting the DHCP Client

Connect the LAN cable before turning the projector on. If not, the DHCP Client function does not work.

Selectable items	Description
ON	Obtains configuration parameters for TCP/IP network automatically.
OFF	Sets the TCP/IP manually.

Note

- Select “ON” for “DHCP Client”. “Obtaining IP Address...” appears, then the message “The network settings have been changed.”, IP Address, Subnet Mask and Gateway will be displayed.
- If the DHCP server is not available, “Could not obtain IP Address.” appears. In this case, set the TCP/IP manually. (See “Setting the TCP/IP” on page 65.)

Helpful Functions Set during Installation (“Options 2” menu)/Using the Other Menus (“Language” and “Status” menus)

15 Setting the TCP/IP

Set the TCP/IP manually.

1 Select “TCP/IP”, then press **ENTER**.

2 Enter “IP Address” using ▲, ▼, ► and ◀, then press **ENTER**.

TCP/IP	
IP Address	192.168.150.002
Subnet Mask	255.255.255.000
Gateway	000.000.000.000

3 Enter “Subnet Mask” using ▲, ▼, ► and ◀, then press **ENTER**.

4 Enter “Gateway” using ▲, ▼, ► and ◀, then press **ENTER**.

Selectable items	Description
IP Address	Factory default setting: 192.168.150.002 Enter an IP address appropriate for the network.
Subnet Mask	Factory default setting: 255.255.255.000 Set the subnet mask to the same as that of the computer and equipment on the network.
Gateway	Factory default setting: 000.000.000.000 * When not in use, set to: “000.000.000.000”.

Note

- Before setting “TCP/IP”, select “OFF” for “DHCP Client”.
- Confirm the existing network’s segment (IP address group) to avoid setting an IP address that duplicates the IP addresses of other network equipment or computers. If “192.168.150.002” is not used in a network with an IP address of “192.168.150.XXX”, you don’t have to change the projector IP address.
- For details about each setting, consult your network administrator.

16 Service Mode

Only the service centers use the menu. Do not use the menu.

17 Returning to the Default Settings

This function allows you to initialize the settings you have made in the projector.

Note

About the network settings

- “IP Address”, “Subnet Mask”, “Gateway” and other network setting items are initialized.

The following items or menu cannot be initialized.

- “C. M. S.” menu
 - “Lightness”, “Chroma” and “Hue” respectively saved for Custom 1-3 on the “C.M.S.” menu.
- “Fine Sync” menu
 - Resolution
- “Options 1” menu
 - System Lock
- “Options 2” menu
 - Lens Type
- “Language” menu
- Image stored using “Image Capture”
- Lamp Timer (Life)

Selecting the On-screen Display Language

The projector can switch the on-screen display language among 16 languages.

Overview of All Menu Settings and the Lamp Life

This function can be used to display all the adjusted settings as a list on the screen and you can confirm the lamp life.

Maintenance

Cleaning the projector

- Ensure the power cord is unplugged before cleaning the projector.
- The cabinet as well as the operation panel is made of plastic. Avoid using benzene or thinner, as these can damage the finish on the cabinet.
- Do not use volatile agents such as insecticides on the projector.

Do not attach rubber or plastic items to the projector for long periods.

The effects of some of the agents in the plastic may cause damage to the quality or finish of the projector.

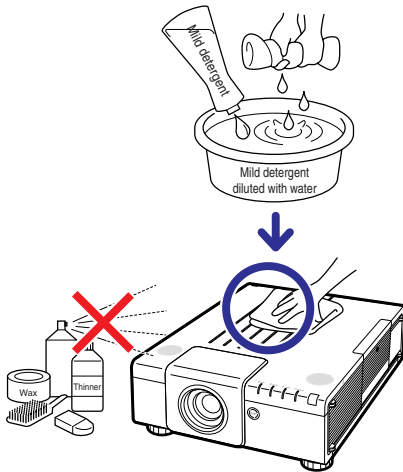

- Wipe off dirt gently with a soft flannel cloth.
- When the dirt is hard to remove, soak a cloth in a mild detergent diluted with water, wring the cloth well and then wipe the projector.

Strong cleaning detergents may discolor, warp or damage the coating on the projector. Make sure to test on a small, inconspicuous area on the projector before use.

Cleaning the lens

- Use a commercially available blower or lens cleaning paper (for glasses and camera lenses) for cleaning the lens. Do not use any liquid type cleaning agents, as they may wear off the coating film on the surface of the lens.
- As the surface of the lens can easily get damaged, be careful not to scrape or hit the lens.

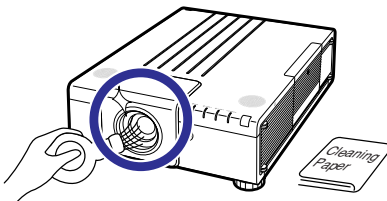

Cleaning the air vents and the intake vent cover

- Use a vacuum cleaner to clean dust from the exhaust vent, the intake vents and the intake vent cover (on the bottom of the projector).

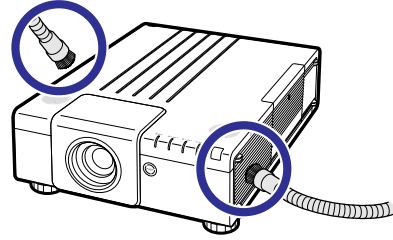

Info

- If you want to clean the air vents and the intake vent cover during projector operation, ensure you press **STANDBY** on the projector or on the remote control and put the projector into standby mode. After the cooling fan has stopped, unplug the power cord from the AC socket and clean the air vents and the intake vent cover.

Cleaning and Replacing the Dust Filters

Cleaning the Dust Filters

Info

- The dust filters should be cleaned every 100 hours of use. Clean the filters more often when the projector is used in a dusty or smoky location.

1 Press **STANDBY on the projector or on the remote control to put the projector into standby mode.**

- Disconnect the power cord and unplug the power cord from the AC socket after the cooling fan stops.

2 Remove the filter cover.

- Remove the filter cover as shown in the figures while pressing down the tabs.

3 Clean the dust off the dust filters and the cover with a hand broom.

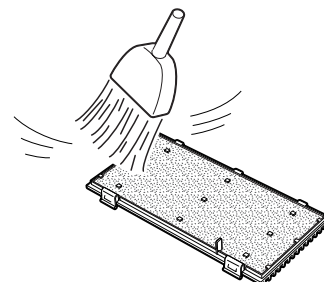
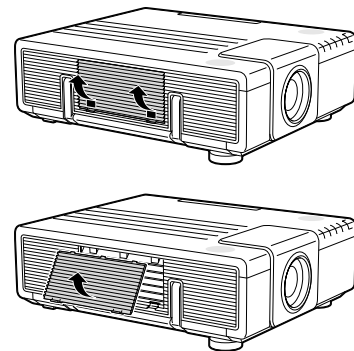
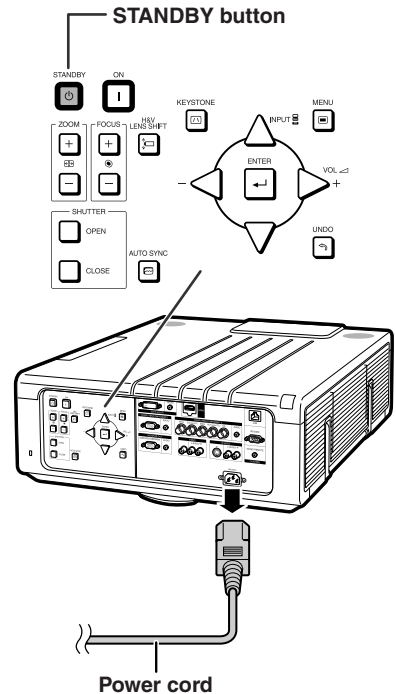

Cleaning and Replacing the Dust Filters

4 Replace the filter cover.

- Insert the filter cover as shown in the figure and push both the two tabs until you hear a click.

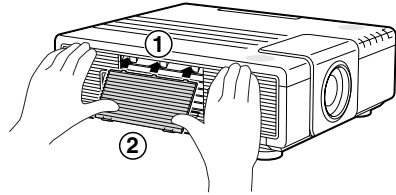

Note

- Be sure the filter cover is securely installed. The power will not turn on unless it is correctly installed.

Replacing the Dust Filters

Info

- If the filters become too dirty to clean effectively, purchase new ones (9NK3243101400) from your nearest Sharp Authorized Projector Dealer or Service Center.

After removing the filter cover (see step 2 of “Cleaning the Dust Filters”), remove the dust filters, then replace with new ones.

- Pick the dust filters up with your fingers and lift them out of the filter cover.
- When attaching the dust filters, make sure that these are inserted below the tabs on both left and right, and that the slits are pierced through.

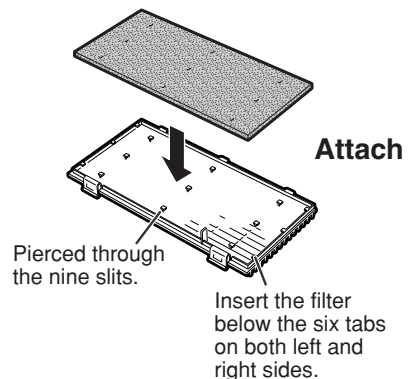
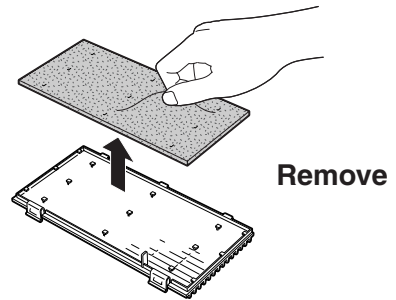

Maintenance Indicators

- The warning lights on the projector indicate problems inside the projector.
- If a problem occurs, either the temperature warning indicator or the lamp indicator will illuminate red, and the projector will enter the standby mode. After the projector has entered the standby mode, follow the procedures given below.

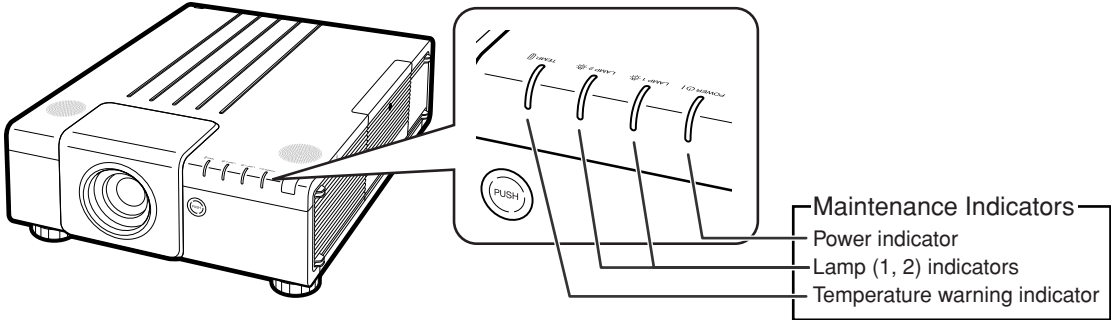



About the temperature warning indicator



If the temperature inside the projector increases, due to blockage of the air vents, or the setting location, “TEMP.” will illuminate in the lower left corner of the picture. If the temperature keeps on rising, the lamp will turn off and the temperature warning indicator will blink, the cooling fan will run for a further 90 seconds, and then the projector will enter the standby mode. After “TEMP.” appears, ensure you perform the measures described on page 70.

About the lamp indicator

“Change The Lamp. (LAMP 2)” is displayed when the remaining life of the lamp 2 becomes 5% or less.

- When the remaining lamp life becomes 5% or less, “” (yellow) and “Change The Lamp. (LAMP 1/ 2)” will be displayed on the screen.
- When the percentage becomes 0%, it will change to “” (red), the lamp will automatically turn off. At this time, the lamp indicator will illuminate in red.
If you try to turn on the projector a fourth time without replacing the lamp, the lamp whose life is 0% will not light up.

Indicators on the Projector

Power indicator	Red on	Normal (Standby)
	Green on	Normal (Power on)
	Red blinks	Abnormal (See page 70.)
	Green blinks	Normal (Cooling)
Lamp (1, 2) indicators	Green on	Normal
	Green blinks	The lamp is warming up.
	Red on	The lamp is shut down abnormally or requires to be changed. (See page 70.)
Temperature warning indicator	Off	Normal
	Red on	The internal temperature is abnormally high. (See page 70.)

Maintenance Indicators

	Maintenance indicator		Problem	Cause	Possible solution
	Normal	Abnormal			
Temperature warning indicator	Off	Red on (Standby)	The internal temperature is abnormally high.	• Blocked air intake	• Relocate the projector to an area with proper ventilation. (See page 10 .)
				• Cooling fan break-down • Internal circuit failure • Clogged air intake • Clogged dust filter	• Take the projector to your nearest Sharp Authorized Projector Dealer or Service Center for repair. (See page 81 .) • Clean the air vents and the dust filter. (See page 67 .)
Lamp (1, 2) indicators	Green on (Green blinks when the lamp is warming up.)	Red on	The lamp does not illuminate.	• The lamp is shut down abnormally.	• Disconnect the power cord from the AC outlet, and then connect it again.
			Time to change the lamp.	• Remaining lamp life becomes 5% or less.	• Carefully replace the lamp. (See page 72 .) • Take the projector to your nearest Sharp Authorized Projector Dealer or Service Center for repair. (See page 81 .)
		Red on (Standby)	The lamp does not illuminate.	• Burnt-out lamp • Lamp circuit failure	• Please exercise care when replacing the lamp.
Power indicator	Green on/ Red on	Red blinks	The power indicator blinks in red when the projector is on.	• The filter cover is open. • The lens cover is open.	• Securely install the filter cover or lens cover. • If the power indicator blinks even when the filter cover or lens cover is securely installed, contact your nearest Sharp Authorized Projector Dealer or Service Center for advice. (See page 81 .)

Info

- If the temperature warning indicator blinks and the projector enters the standby mode, the temperature warning indicator starts to illuminate. Check whether any of the ventilation holes are blocked (see page [10](#)) and then try turning the power back on. Wait until the projector has cooled down completely before plugging in the power cord and turning the power back on. (At least 10 minutes.)
- If the power is turned off for a brief moment due to power outage or some other cause while using the projector, and the power supply recovers immediately after that, the lamp indicator will illuminate in red and the lamp may not be lit. In this case, unplug the power cord from the AC outlet, replace the power cord in the AC outlet and then turn the power on again.
- The cooling fan keeps the internal temperature of the projector constant and this function is controlled automatically. The sound of the cooling fan may change during operation because the fan speed may change and this is not a malfunction.

Regarding the Lamp

Lamp

- It is recommended that the lamp unit (sold separately) be replaced when the remaining lamp life becomes 5% or less, or when you notice a significant deterioration in the picture and color quality. The lamp life (percentage) can be checked with the on-screen display. See page 65.
- Purchase a replacement lamp unit of type AN-P610LP from your place of purchase, nearest Sharp Authorized Projector Dealer or Service Center.

IMPORTANT NOTE TO U.S. CUSTOMERS:

The lamp included with this projector is backed by a 90-day parts and labor limited warranty. All service of this projector under warranty, including lamp replacement, must be obtained through a Sharp Authorized Projector Dealer or Service Center. For the name of the nearest Sharp Authorized Projector Dealer or Service Center, please call toll-free: 1-888-GO-SHARP (1-888-467-4277).

Hg LAMP CONTAINS MERCURY For State Lamp Disposal Information
www.lamprecycle.org or 1-800-BE-SHARP

U.S.A. ONLY

Caution Concerning the Lamp

- This projector utilizes a pressurized mercury lamp. A loud sound may indicate lamp failure. Lamp failure can be attributed to numerous sources such as: excessive shock, improper cooling, surface scratches or deterioration of the lamp due to a lapse of usage time. The period of time up to failure largely varies depending on the individual lamp and/or the condition and the frequency of use. It is important to note that failure can often result in the bulb cracking.
- When the lamp indicator and on-screen display icon are illuminated, it is recommended that the lamp be replaced with a new one immediately, even if the lamp appears to be operating normally.
- Should the lamp break, the glass particles may spread inside the lamp cage or gas contained in the lamp may be vented into the room from the exhaust vent. Because the gas in this lamp includes mercury, ventilate the room well if the lamp breaks and avoid all exposure to the released gas. In case of exposure to the gas, consult a doctor as soon as possible.
- Should the lamp break, there is also a possibility that glass particles may spread inside of the projector. In such a case, it is recommended you contact your nearest Sharp Authorized Projector Dealer or Service Center to assure safe operation.

Replacing the Lamp

Caution

- Do not remove the lamp unit from the projector right after use. The lamp will be very hot and may cause burn or injury.
 - Wait at least one hour after the power cord is disconnected to allow the surface of the lamp unit to fully cool before removing the lamp unit.
 - **Carefully change the lamp by following the instructions described in this section. *If you wish, you may have the lamp replaced at your nearest Sharp Authorized Projector Dealer or Service Center.**
- * If the new lamp does not illuminate after replacement, take your projector to the nearest Sharp Authorized Projector Dealer or Service Center for repair.

Removing and Installing the Lamp Unit

Warning!

- Do not remove the lamp unit from the projector right after use. The lamp and parts around the lamp will be very hot and may cause burn or injury.

Info

- Make sure the lamp unit is removed using the handle. Make sure the glass surface of the lamp unit or the inside of the projector are not touched.
- To avoid injury to yourself and damage to the lamp, make sure you carefully follow the steps below.
- Do not loosen other screws except for the lamp unit cover and lamp unit.

1 Press **STANDBY** on the projector or on the remote control to put the projector into standby mode.

- Disconnect the power cord and unplug the power cord from the AC socket after the cooling fan stops.
- The cooling fan may continue to run for a while even after the power cord is removed.
- Leave the lamp until it has fully cooled down (about 1 hour).

2 Remove the lamp unit cover.

- Loosen the user service screw (①) that secures the lamp unit cover. Remove the lamp unit cover to slide it in the direction of the arrow (②).

Optional accessory

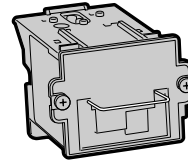

Lamp unit
AN-P610LP

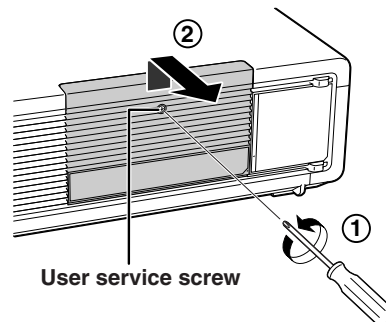
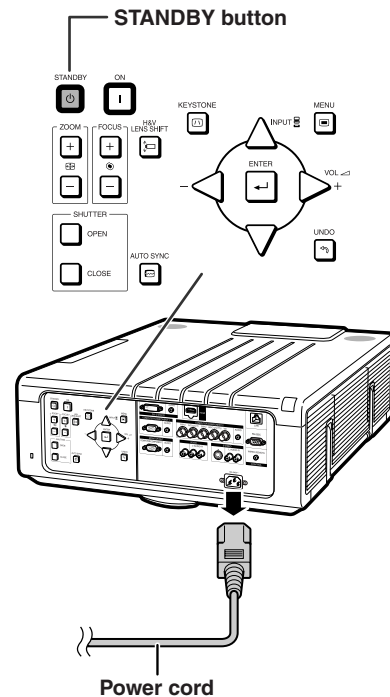

3 Remove the lamp unit.

- Loosen the securing screws (two for each lamp) from the lamp unit. Hold the lamp unit by the handle and pull it in the direction of the arrow. At this time, keep the lamp unit horizontal and do not tilt it.

Securing screws

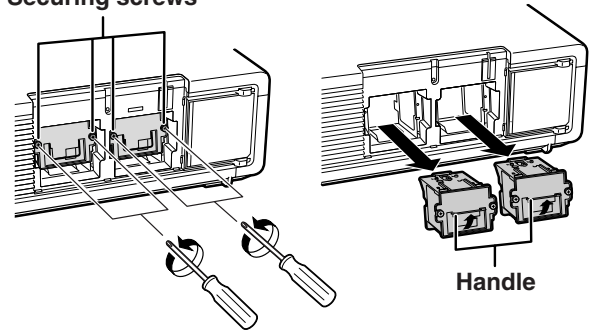

4 Insert the new lamp unit.

- Fully insert the lamp unit into the lamp unit compartment. Press the handles back to their positions, and tighten the securing screws.

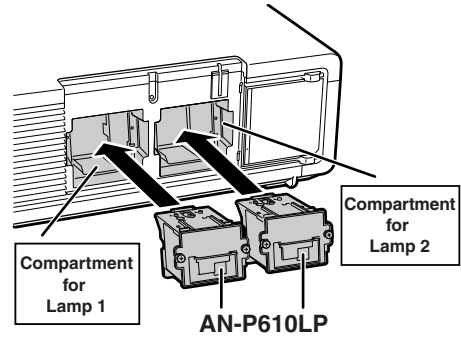

5 Replace the lamp unit cover.

- Slide the lamp unit cover to the position where the indicator "▶" of the lamp cover unit and the "◀" of the projector will meet to close the cover. Then tighten the user service screw to secure the lamp unit cover.

Info

- If the lamp unit and lamp unit cover are not correctly installed, the power will not turn on, even if the power cord is connected to the projector.

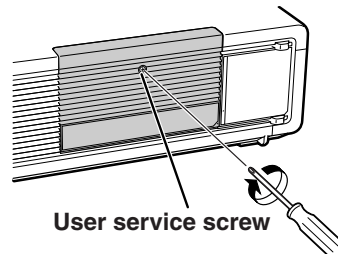
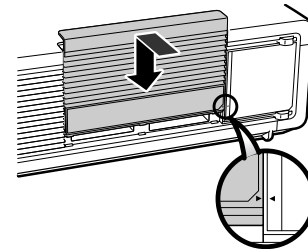
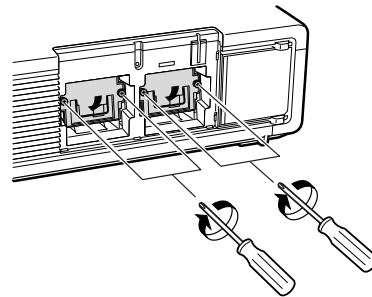

User service screw

Resetting the Lamp Timer

Reset the lamp timer after replacing the lamp.

Info

- Make sure to reset the lamp timer only when replacing the lamp. If you reset the lamp timer and continue to use the same lamp, this may cause the lamp to become damaged or explode.

1 Connect the power cord.

- Plug the power cord into the AC socket of the projector.

2 Reset the lamp timer.

For Lamp 1

- When you reset the timer, while simultaneously holding down **◀**, **▼** and **ENTER**, press **ON** on the projector.
- “LAMP 1 0000H” is displayed, indicating that the lamp timer is reset.

For Lamp 2

- When you reset the timer, while simultaneously holding down **▶**, **▼** and **ENTER**, press **ON** on the projector.
- “LAMP 2 0000H” is displayed, indicating that the lamp timer is reset.

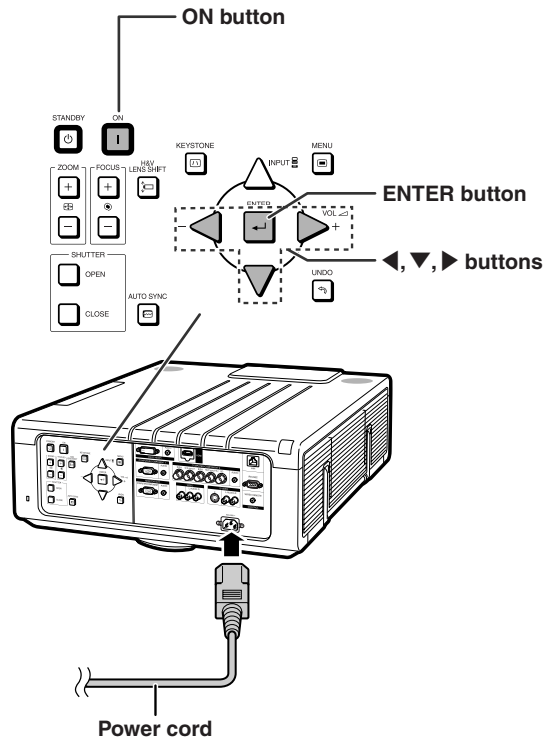

Computer Compatibility Chart

The table below lists signal codes that are compatible with the projector. When the images are distorted or cannot be projected, adjust the output signal of your computer and so forth while referring to the table below.

Computer

- Multiple signal support

Horizontal Frequency: 15–126 kHz

Vertical Frequency: 43–200 Hz

Pixel Clock: 12–230 MHz

Sync signal: Compatible with TTL level

- Compatible with sync on green signal

The following is a list of modes that conform to VESA. However, this projector supports other signals that are not VESA standards.

PC/MAC/WS	Resolution	Horizontal Frequency (kHz)	Vertical Frequency (Hz)	VESA Standard	DVI Support	HDMI Support	Display		
PC	640 × 350	27.0	60				Upscale		
		31.5	70						
		37.9	85	✓					
	720 × 350	27.0	60						
		31.5	70						
	640 × 400	27.0	60						
		31.5	70		✓	✓			
		37.9	85	✓	✓	✓			
	720 × 400	27.0	60						
		31.5	70		✓	✓			
		37.9	85	✓	✓	✓			
	VGA	640 × 480	26.2	50		✓		✓	
			31.5	60	✓	✓		✓	
			34.7	70		✓		✓	
			37.9	72	✓	✓		✓	
			37.5	75	✓	✓		✓	
			43.3	85	✓	✓		✓	
		800 × 600	48.0	90					
			53.0	100					
			63.6	120					
			79.5	150					
			81.3	160					
			100.4	200					
	SVGA	800 × 600	31.3	50		✓		✓	
			35.2	56	✓	✓		✓	
			37.9	60	✓	✓		✓	
			46.6	70		✓		✓	
			48.1	72	✓	✓		✓	
			46.9	75	✓	✓		✓	
			53.7	85	✓	✓		✓	
			57.0	90					
			64.5	101					
			76.2	120					
			95.6	150					
			101.9	160					
	127.4	200							
	XGA	1024 × 768	35.5	43		✓		✓	
			40.3	50		✓		✓	
			48.4	60	✓	✓		✓	
			56.5	70	✓	✓		✓	
			58.1	72		✓		✓	
			60.0	75	✓	✓		✓	
			68.7	85	✓	✓		✓	
			72.9	90					
			77.0	95					
80.8			100						
96.8			120						
113.3			140						
PC			WXGA	1280 × 720	45.0	60		✓	✓
				1280 × 768	47.8	60	✓	✓	✓
				1280 × 800	49.7	60	✓	✓	✓
	1280 × 800	62.8		75	✓	✓	✓		
	1360 × 768	47.7		60		✓	✓		
	1366 × 768	47.8		60		✓	✓		
	SXGA	1152 × 864	55.0	60		✓	✓		
			66.2	70		✓	✓		
			64.9	72		✓	✓		
			67.5	75	✓	✓	✓		
			76.6	80					
			77.1	85					
		1152 × 882	90.2	100					
			54.5	60					
			65.9	72					
			67.4	74					
			64.0	60	✓	✓	✓		
			74.6	70					
	1280 × 1024	78.9	74						
		80.0	75	✓					
		91.1	85	✓					
		107.2	100						
		64.0	60	✓	✓	✓			
		65.3	60	✓	✓	✓			
	SXGA+	1400 × 1050	64.0	60		✓	✓		
	UXGA	1600 × 1200	65.3	60	✓	✓	✓		
			74.7	52					
			75.0	60	✓				
			81.3	65	✓				
			87.5	70	✓				
90.0			72	✓					
93.8			75	✓					
106.3			85	✓					
MAC 13"			VGA	640 × 480	35.0	67			Upscale
MAC 16"			SVGA	832 × 624	49.7	75			Upscale
MAC 19"	XGA	1024 × 768	60.2	75			True		
MAC 21"	SXGA	1152 × 870	68.7	75			True		
HP (WS)		1280 × 1024	78.1	72			Advanced Intelligent Compression		
PC (WS)		1280 × 1024	78.1	72			Advanced Intelligent Compression		
WS	SXGA	1280 × 960	60.0	60	✓		Advanced Intelligent Compression		
SUN (WS)	SXGA	1280 × 960	85.9	85			Advanced Intelligent Compression		
			61.8	66			Advanced Intelligent Compression		
			71.7	76			Advanced Intelligent Compression		

Computer Compatibility Chart

Note

- This projector may not be able to display images from notebook computers in simultaneous (CRT/LCD) mode. Should this occur, turn off the LCD display on the notebook computer and output the display data in “CRT only” mode. Details on how to change display modes can be found in your notebook computer’s operation manual.
- When this projector receives 640 × 350 VESA format VGA signals, “640 × 400” appears on the screen.
- When projecting the RGB interlace signal using COMPUTER 1/2 with “Signal Type” set to “Auto” or “RGB”, the image may not be projected as desired. In this case, select either VIDEO or S-VIDEO.
- When “Screen resolution” of the computer is different from the resolution displayed on the projected image, follow the procedures shown below.
 - Refer to “Setting the Resolution” on page 53 and select the same resolution as the resolution in “Screen resolution” of the computer.
 - Depending on the computer you are using, the output signal may not be faithful to the “Screen resolution” adjustment. Check the settings of the computer’s signal output. If the settings cannot be changed, it is recommended that the resolution be set to the one that corresponds to “True” in the “Display” column.

DTV

Signal	Horizontal Frequency (kHz)	Vertical Frequency (Hz)	DVI/HDMI Support (Compatible with HDCP)
480I	15.7	60	✓
480P	31.5	60	✓
540P	33.8	60	
576I	15.6	50	✓
576P	31.3	50	✓
720P	45.0	60	✓
	37.5	50	✓
1035I	33.8	60	✓
	33.8	60	✓
1080I	28.1	50	✓
	67.5	60	✓
1080P*	56.3	50	✓

* When 1080P signal is input, the image is compressed before it is displayed on the screen.

Attaching the Optional Lens

Do not attempt to exchange the lens when the projector is installed hanging from the ceiling. Injury may occur if the lens cover and lens fall.

Before exchanging the lens, reset lens shift to the center position. (The lens shift is located at the center in the factory preset.)

When resetting the lens shift to the center position, press **H&V LENS SHIFT** and then press **UNDO**.

- The lens shift reset screen will be displayed.
- Select "Yes" to reset.

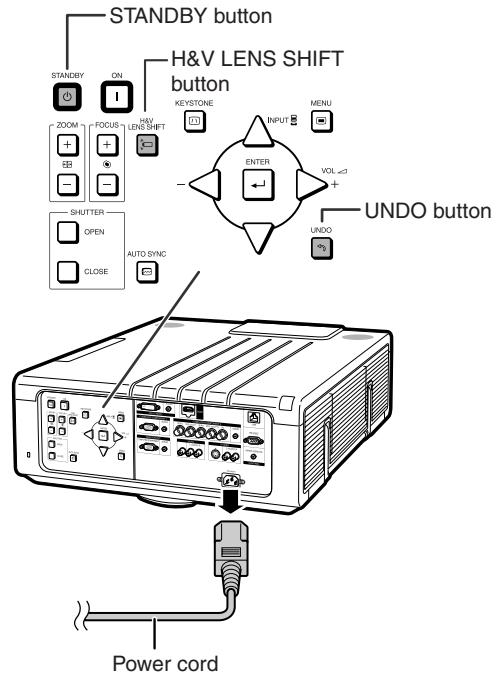

1 Press **STANDBY on the projector or on the remote control to put the projector into standby mode.**

- Disconnect the power cord and unplug the power cord from the AC socket after the cooling fan stops.

2 Remove the lens cover.

- Press the lens cover removal button (①).
- Slide the lens cover forward (②).

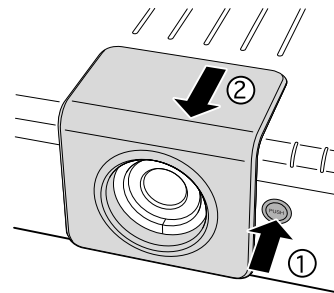

3 Turn the lens in the direction of the arrow while pressing the lens removal lever to pull the lens out.

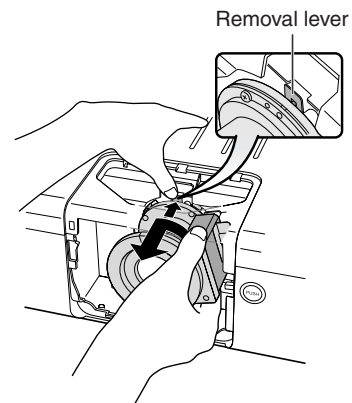

Attaching the Optional Lens

- 4** Remove the lens cap from a replacement lens.

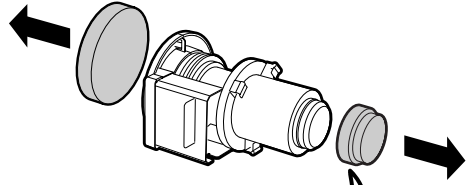

Info

If you try to attach the lens to the projector without removing this cap, the optional lens attachment part can be damaged.

- 5** Insert the hook of the replacement lens to the notch, and turn the lens in the direction of the arrow.

- Make sure that the lens is locked with the lens removal lever when you hear a click sound.

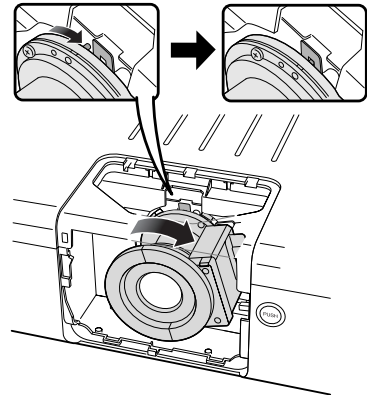
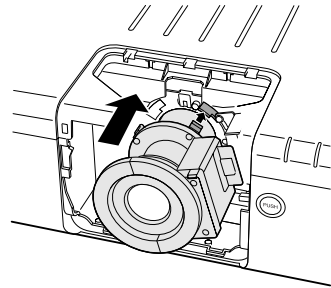

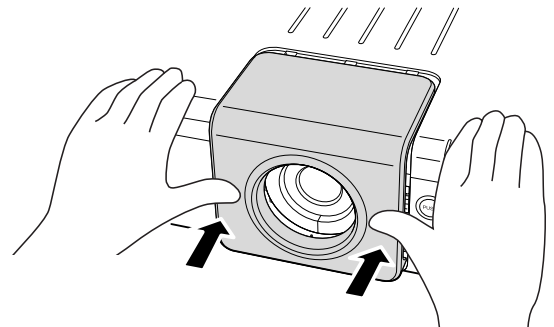

- 6** Slide and attach the lens cover.

- The power cannot be turned on unless the lens cover is fully inserted.



- 7** After changing (setting) the lens, select the correct lens type. (See page 62.)

Troubleshooting

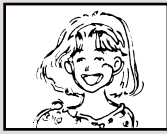
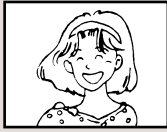
Problem	Check	Page
 <p>No picture and no sound or projector does not start.</p>	<ul style="list-style-type: none"> • Projector power cord is not plugged into the wall outlet. 	28
	<ul style="list-style-type: none"> • Power to the external connected devices is off. 	—
	<ul style="list-style-type: none"> • The selected input mode is wrong. 	36
	<ul style="list-style-type: none"> • Cables are incorrectly connected to the projector. 	24–27
	<ul style="list-style-type: none"> • Remote control batteries have run out. 	16
	<ul style="list-style-type: none"> • External output has not been set when connecting notebook computer. • When the connected DVI digital equipment is turned on before the “DVI” input mode is selected on the projector, the image may not be projected properly or may not be displayed at all. Ensure that the appropriate input mode has been selected and set the input signal type on the projector before you turn on the connected equipment. 	24
	<ul style="list-style-type: none"> • Is the lens cover correctly attached? 	78
	<ul style="list-style-type: none"> • Is the filter cover correctly attached? 	68
	<ul style="list-style-type: none"> • Is the lamp unit cover correctly attached? 	73
 <p>Sound is heard but no picture appears.</p>	<ul style="list-style-type: none"> • Cables are incorrectly connected to the projector. 	24–27
	<ul style="list-style-type: none"> • “Bright” is set to minimum position. 	49
	<ul style="list-style-type: none"> • The “Shutter” is closed. 	41
 <p>Color is faded or poor.</p>	<ul style="list-style-type: none"> • Image adjustments are incorrectly set. 	49
	(COMPUTER 1/2, DVI, HDMI only) <ul style="list-style-type: none"> • Input signal type (RGB/Component) is incorrectly set. 	51
	(VIDEO, S-VIDEO only) <ul style="list-style-type: none"> • Video Input system is incorrectly set. 	57
 <p>Picture is blurred; noise appears.</p>	<ul style="list-style-type: none"> • Adjust the focus. 	31
	<ul style="list-style-type: none"> • The projection distance exceeds the focus range. • When an optional lens is attached, refer to the operation manual of the lens. 	22
	<ul style="list-style-type: none"> • There is fog on the lens. If the projector is carried from a cold room into a warm room, or if it is suddenly heated, condensation may form on the surface of the lens and the image will become blurred. Please set up the projector at least one hour before it is to be used. If condensation should form, remove the power cord from the wall outlet and wait for it to clear. 	—
	(Computer Input only) <ul style="list-style-type: none"> • Perform “Fine Sync” Adjustments. (“Clock” Adjustment) 	53
	<ul style="list-style-type: none"> • Perform “Fine Sync” Adjustments. (“Phase” Adjustment) 	53
	<ul style="list-style-type: none"> • Turn off the LCD display of the notebook computer. 	76
	<ul style="list-style-type: none"> • Noise may appear depending on the computer. 	—
<ul style="list-style-type: none"> • The “DNR” (Digital Noise Reduction) setting is not correct. 	50	
 <p>Picture appears but no sound is heard.</p>	<ul style="list-style-type: none"> • Cables are incorrectly connected to the projector. 	24–27
	<ul style="list-style-type: none"> • Volume is set to minimum. 	36
	<ul style="list-style-type: none"> • The “MUTE” function is working. 	37
	<ul style="list-style-type: none"> • The “Speaker” menu is set to “Off”. 	55

Problem	Check	Page
An unusual sound is occasionally heard from the cabinet.	<ul style="list-style-type: none"> If the picture is normal, the sound is due to cabinet shrinkage caused by room temperature changes. This will not affect operation or performance. 	—
Maintenance indicator illuminates or blinks in red.	<ul style="list-style-type: none"> See “Maintenance Indicators”. 	69
The projector cannot be turned on or put into the standby mode using the ON or STANDBY button on the projector.	<ul style="list-style-type: none"> If the “Keylock Level” menu is set to “Level A” or “Level B”, all or specific buttons on the projector are unavailable. Use the remote control to operate the projector. 	63
All buttons on the projector and the remote control are unavailable.	<ul style="list-style-type: none"> If the “Stack Setting” menu is set to “Slave” and the “Keylock Level” menu is set to “Level B”, all buttons on the projector and the remote control are unavailable. Connect the remote control to the projector, and then use the remote control to operate the projector. 	17 62 63
Picture is green on COMPUTER 1 or 2 (COMPONENT).	<ul style="list-style-type: none"> Change the input signal type setting. 	51
Picture is pink (no green) on COMPUTER 1/ 2 or DVI (RGB).		
The black levels of the image show banding or appear faded when DVI or HDMI is selected.	<ul style="list-style-type: none"> Make adjustments that result in the best picture quality in the “Dynamic Range” setting. 	51
Picture is too bright and whitish.	<ul style="list-style-type: none"> Image adjustments are incorrectly set. 	49
The cooling fan becomes noisy.	<ul style="list-style-type: none"> When temperature inside the projector increases, the cooling fan runs faster. 	9, 10 66, 69, 70
The lamp does not light up even after the projector turns on.	<ul style="list-style-type: none"> The lamp indicator is illuminating in red. Replace the lamp. 	69
The lamp suddenly turns off during projection.		
The image sometimes flickers.	<ul style="list-style-type: none"> Cables are incorrectly connected to the projector or the connected equipment works improperly. If this happens frequently, replace the lamp. 	24–27 72
The lamps take a long time to turn on.		72
Picture is dark.	<ul style="list-style-type: none"> Operate the remote control while pointing it at the projector’s remote control sensor. The remote control may be too far away from the projector. If direct sunlight or a strong fluorescent light is shining on the projector’s remote control sensor, place the projector where it will not be affected by strong light. Is a ø3.5 mm minijack cable plugged into the WIRED REMOTE terminal? 	16
The remote control cannot be used.		<ul style="list-style-type: none"> The batteries may be depleted or inserted incorrectly. Make sure the batteries are inserted correctly or insert new ones.

This projector is equipped with a microprocessor. Its performance could be adversely affected by incorrect operation or interference. If this should happen, unplug the projector and plug it in again after more than 5 minutes.

For SHARP Assistance

If you encounter any problems during setup or operation of this projector, first refer to the “Troubleshooting” section on pages 79 and 80. If this operation manual does not answer your question, please contact the SHARP Service departments listed below.

U.S.A.	Sharp Electronics Corporation 1-888-GO-SHARP (1-888-467-4277) lcdsupport@sharpsec.com http://www.sharppusa.com	Benelux	SHARP Electronics Benelux BV 0900-SHARPCE (0900-7427723) Nederland 9900-0159 Belgium http://www.sharp.nl http://www.sharp.be http://www.sharp.lu
Canada	Sharp Electronics of Canada Ltd. (905) 568-7140 http://www.sharp.ca	Australia	Sharp Corporation of Australia Pty. Ltd. 1300-135-022 http://www.sharp.net.au
Mexico	Sharp Electronics Corporation Mexico Branch (525) 716-9000 http://www.sharp.com.mx	New Zealand	Sharp Corporation of New Zealand Phone:(09) 573-0111 Fax:(09) 573-0112 http://www.sharp.net.nz
Latin America	Sharp Electronics Corp. Latin American Group (305) 264-2277 www.servicio@sharpsec.com http://www.siemprfresharp.com	Singapore	Sharp-Roxy Sales (S) Pte. Ltd. 65-226-6556 ckng@srs.global.sharp.co.jp http://www.sharp.com.sg
Germany	Sharp Electronics (Europe) GMBH 01805-234675 http://www.sharp.de	Hong Kong	Sharp-Roxy (HK) Ltd. (852) 2410-2623 dcmktg@srh.global.sharp.co.jp http://www.sharp.com.hk
U.K.	Sharp Electronics (U.K.) Ltd. 08705 274277 http://www.sharp.co.uk/customersupport	Taiwan	Sharp Corporation (Taiwan) 0800-025111 http://www.sharp-scot.com.tw
Italy	Sharp Electronics (Italy) S.P.A. (39) 02-89595-1 http://www.sharp.it	Malaysia	Sharp-Roxy Sales & Service Co. (60) 3-5125678
France	Sharp Electronics France 01 49 90 35 40 hotlinecd@sef.sharp-eu.com http://www.sharp.fr	U.A.E.	Sharp Middle East Fze 971-4-81-5311 helpdesk@smef.global.sharp.co.jp
Spain	Sharp Electronica Espana, S.A. 93 5819700 sharpplcd@sees.sharp-eu.com http://www.sharp.es	Thailand	Sharp Thebnakorn Co. Ltd. 02-236-0170 svc@stcl.global.sharp.co.jp http://www.sharp-th.com
Switzerland	Sharp Electronics (Schweiz) AG 0041 1 846 63 11 cattaneo@sez.sharp-eu.com http://www.sharp.ch	Korea	Sharp Electronics Incorporated of Korea (82) 2-3660-2002 lcd@sharp-korea.co.kr http://www.sharpkorea.co.kr
Sweden	Sharp Electronics (Nordic) AB (46) 8 6343600 vision.support@sen.sharp-eu.com http://www.sharp.se	India	Sharp Business Systems (India) Limited (91) 11- 6431313 service@sharp-oa.com
Austria	Sharp Electronics (Europe) GMBH Branch Office Austria 0043 1 727 19 123 pogats@sea.sharp-eu.com http://www.sharp.at		

Specifications

Model		XG-P610X (Standard zoom lens attached) / XG-P610X-N (No lens attached)
Display devices		0.7" DLP® Chip ×3
Resolution		XGA (1024 × 768)
Lens (Standard)	F number	F 2.5
	Zoom	Power, ×1.25 (f = 25.5 – 32.0 mm)
	Focus	Power
Lens shift		Power (V : ±55% / H : ±35%)
Input terminals	HDMI	×1
	DVI-D (Compatible with HDCP)	×1
	Computer / Component (5BNC)	×1
	Computer/Component (mini D-sub 15 pin)	×1
	S-Video (mini DIN 4 pin)	×1
	Video (RCA)	×1
	Audio (ø3.5 mm stereo minijack)	×3
	Audio (RCA)	×2 (L/R)
Output terminals	Computer/Component (mini D-sub 15 pin)	×1
	Audio (ø3.5 mm stereo minijack)	×1 (variable audio output)
Control and communication terminals	LAN (RJ-45)	×1
	RS-232C (mini DIN 9 pin)	×1
	Wired Remote (ø3.5mm stereo minijack)	×1
Speakers		3 W × 2 (Stereo)
Projection lamp		280 W × 2 lamps
Rated voltage		AC 100 – 240 V
Rated frequency		50/60 Hz
Input current		7.7 A
Power consumption (Standby)		755 W (16.7 W) with AC 100 V 710 W (16.9 W) with AC 240 V
Operation temperature		41°F to 104°F (+5°C to +40°C)
Cabinet		Plastic
Dimensions (main body only) [W × H × D]		19 22/32" × 25 3/32" × 7 31/64" (500 × 637 × 190 mm)
Weight (approx.)		XG-P610X: 57.4 lbs. (26.0 kg) XG-P610X-N: 54.1 lbs. (24.5 kg)

As a part of policy of continuous improvement, SHARP reserves the right to make design and specification changes for product improvement without prior notice. The performance specification figures indicated are nominal values of production units. There may be some deviations from these values in individual units.

Index

AC socket	28
ADJ./MOUSE switch	17
Adjustment buttons	47
Adjustment feet	30
Advanced intelligent compression	75
All Reset	65
Area zoom	40
Aspect ratio	39
Audio	55
Audio Out	55
Auto Power Off	58
Auto Restart	63
Auto Search	58
Auto Sync (Auto Sync adjustment)	54
AUTO SYNC button	54
Auto Sync Disp	54
Background	58
Border	39
BREAK TIMER button	41
C.M.S. (Color Management System)	52
C.M.S. Adjustment	52
Carrying handle	14
Clock	53
CLR Temp (Color Temperature)	50
COMPUTER1 button	36
COMPUTER2 button	36
COMPUTER/COMPONENT1 terminals	24
COMPUTER/COMPONENT2 terminals	24
DHCP Client	64
Digi. Shift	57
DNR	50
Dot By Dot	39
Dustproof cap	13
DVI button	36
DVI-D terminals	24
Eco Mode	58
ENTER button	47
Exhaust vent	66
Fan Mode	63
Filter cover	67
Fine Sync	53
FOCUS buttons	31
FREEZE button	38
Gateway	65
Geometric adjustment	33
H-Pos	53
H & V keystone	34
H & V LENS SHIFT button	30
HDMI button	36
HDMI terminal	24
Image Capture	57
Image resizing	35
INPUT buttons	36
Intake vent	66
IP Address	65
Kensington Security Standard connector	14
Keypcode	59
Keylock Level	63
KEYSTONE button	32
Keystone Correction	32
Lamp	71
Lamp indicators 1, 2	69
Lamp Mode	62
Lamp Timer (Life)	65
Lamp unit cover	72
LAN terminal	27
LAN/RS232C	64
Language	65
L-CLICK button	18
Lens cover	77
MAGNIFY buttons	37
MENU button	47
Monitor Out	64
MONITOR OUT terminals	26
Mouse button	18
MUTE button	37
Network	64
Normal	39
ON button	28
Options 1	56
Options 2	61
OSD Display	57
Pair Stack	63
Password	61
Phase	53
Pict in Pict	56
Picture	49
Picture Mode	49
PICTURE MODE button	38
Power cord	28
Power indicator	69
PRJ Mode	62
Progressive	50
R-CLICK button	18
Remote control	16
Remote control sensor	16
Remote receiver	18
Resize	39
RESIZE button	39
Resolution	53
RGB cable	24
RS-232C	64
RS-232C terminal	27
S-VIDEO button	36
S-VIDEO terminals	26
Save Setting	53
Select Setting	53
Service Mode	65
Set Inputs	63
SHUTTER buttons	41
Signal Info	54
Signal Type	51
Smart Stretch	40
Speaker	55
sRGB	52
Stack Setting	62
STANDBY button	28
Startup Image	58
Status	65
Stretch	39
Subnet Mask	65
System Lock	59
TCP/IP	65
Temperature warning indicator	69
UNDO button	47
V-Pos	53
V-stretch	40
VIDEO button	36
VIDEO terminals	26
Video System	57
Volume buttons	36
WIRED R/C JACK	17
WIRED REMOTE terminal	17
ZOOM buttons	31

SHARP®

SHARP CORPORATION