



XV-Z90U

# SHARP®

# XV-Z90U

PROJECTOR  
PROJECTEUR  
PROYECTOR  
PROJETOR

OPERATION MANUAL  
MODE D'EMPLOI  
MANUAL DE OPERACION  
MANUAL DE OPERAÇÃO

ENGLISH

FRANÇAIS

ESPAÑOL

PORTUGUÊS

# SHARP CORPORATION

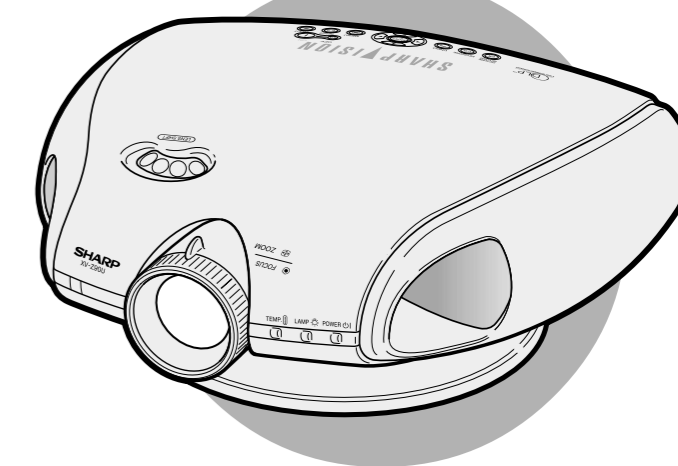
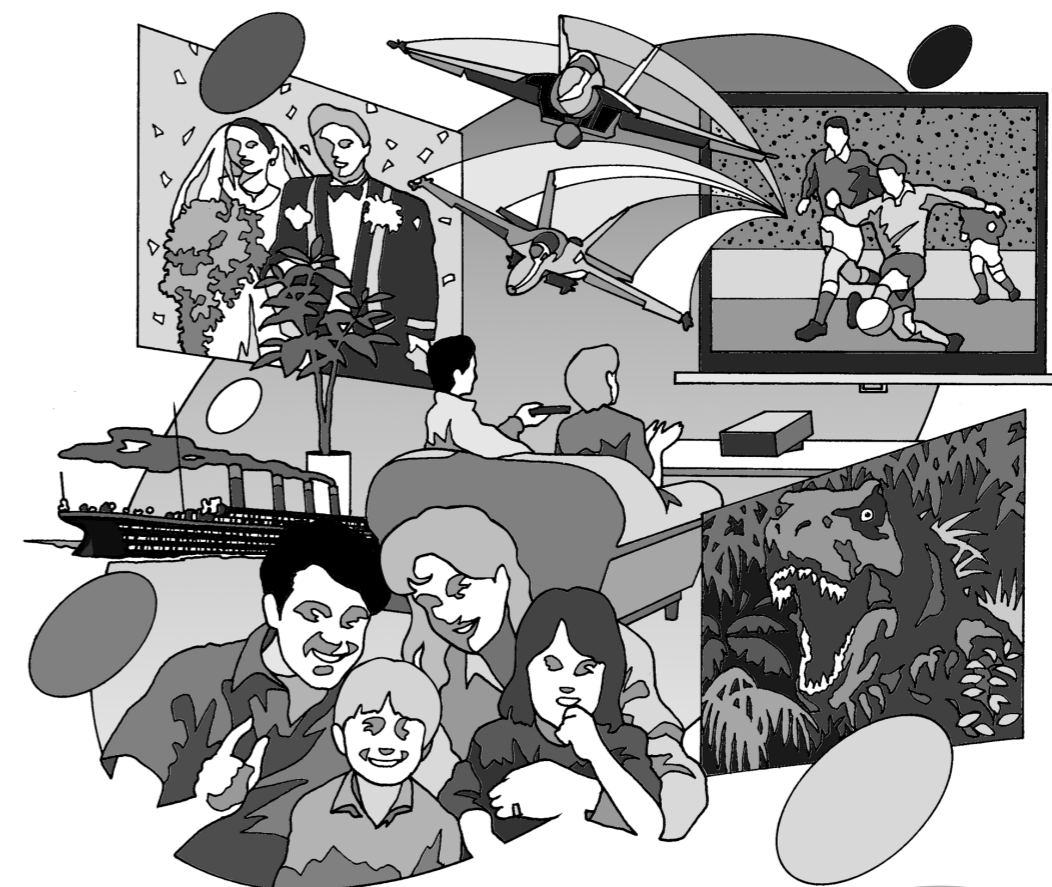

Printed in Japan  
Imprimé au Japon  
Impreso en Japón  
Impresso no Japão  
TINS-A286WJZZ

SHARP®

Before using the projector, please read this operation manual carefully.

# OPERATION MANUAL

ENGLISH

## IMPORTANT

For your assistance in reporting the loss or theft of your Projector, please record the Serial Number located on the bottom of the projector and retain this information. Before recycling the packaging, please be sure that you have checked the contents of the carton thoroughly against the list of "Supplied Accessories" on page 11.

**Model No.: XV-Z90U**

**Serial No.:**

There are two important reasons for prompt warranty registration of your new SHARP Projector, using the REGISTRATION CARD packed with the projector.

### 1. WARRANTY



This is to assure that you immediately receive the full benefit of the parts, service and labor warranty applicable to your purchase.

### 2. CONSUMER PRODUCT SAFETY ACT

To ensure that you will promptly receive any safety notification of inspection, modification, or recall that SHARP may be required to give under the 1972 Consumer Product Safety Act, PLEASE READ CAREFULLY THE IMPORTANT "LIMITED WARRANTY" CLAUSE. U.S.A. ONLY

**WARNING:** High brightness light source. Do not stare into the beam of light, or view directly. Be especially careful that children do not stare directly into the beam of light.

**WARNING:** To reduce the risk of fire or electric shock, do not expose this product to rain or moisture.

	<b>CAUTION</b> RISK OF ELECTRIC SHOCK. DO NOT REMOVE SCREWS EXCEPT SPECIFIED USER SERVICE SCREWS.	
<b>CAUTION: TO REDUCE THE RISK OF ELECTRIC SHOCK, DO NOT REMOVE COVER. NO USER-SERVICEABLE PARTS EXCEPT LAMP UNIT. REFER SERVICING TO QUALIFIED SERVICE PERSONNEL.</b>		



The lightning flash with arrowhead symbol, within an equilateral triangle, is intended to alert the user to the presence of uninsulated "dangerous voltage" within the product's enclosure that may be of sufficient magnitude to constitute a risk or electric shock to persons.



The exclamation point within a triangle is intended to alert the user to the presence of important operating and maintenance (servicing) instructions in the literature accompanying the product.

**WARNING:** FCC Regulations state that any unauthorized changes or modifications to this equipment not expressly approved by the manufacturer could void the user's authority to operate this equipment. U.S.A. ONLY

## PRODUCT DISPOSAL

This product utilizes tin-lead solder, and high intensity discharge lamp (HID lamp) containing a small amount of mercury. Disposal of these materials may be regulated due to environmental considerations. For disposal or recycling information, please contact your local authorities or the Electronic Industries Alliance: [www.eiae.org](http://www.eiae.org) .



### INFORMATION

This equipment has been tested and found to comply with the limits for a Class B digital device, pursuant to Part 15 of the FCC Rules. These limits are designed to provide reasonable protection against harmful interference in a residential installation. This equipment generates, uses, and can radiate radio frequency energy and, if not installed and used in accordance with the operation manual, may cause harmful interference to radio communications. However, there is no guarantee that interference will not occur in a particular installation. If this equipment does cause harmful interference to radio or television reception, which can be determined by turning the equipment off and on, the user is encouraged to try to correct the interference by one or more of the following measures:

- Reorient or relocate the receiving antenna.
- Increase the separation between the equipment and the receiver.
- Connect the equipment into an outlet on a circuit different from that to which the receiver is connected.
- Consult the dealer or an experienced radio/TV technician for help.

U.S.A. ONLY

### Declaration of Conformity

SHARP PROJECTOR, MODEL XV-Z90U

This device complies with Part 15 of the FCC rules. Operation is subject to the following conditions: (1) This device may not cause harmful interference, and (2) this device must accept any interference received, including interference that may cause undesired operation.

Responsible Party:

SHARP ELECTRONICS CORPORATION  
Sharp Plaza, Mahwah, New Jersey 07430  
TEL: 1-800-BE-SHARP (1-800-237-4277)

U.S.A. ONLY

### WARNING:

The cooling fan in this projector continues to run for about 90 seconds after the projector is turned off. During normal operation, when turning the power off always use the **OFF** button on the projector or on the remote control. Ensure the cooling fan has stopped before disconnecting the power cord.  
**DURING NORMAL OPERATION, NEVER TURN THE PROJECTOR OFF BY DISCONNECTING THE POWER CORD. FAILURE TO OBSERVE THIS WILL RESULT IN PREMATURE LAMP FAILURE.**

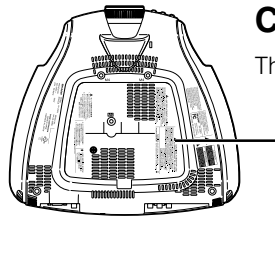

### Caution Concerning the Lamp Replacement

There is potential glass particles hazard if the lamp ruptures.

<p><b>⚠ LAMP REPLACEMENT CAUTION</b></p> <p>BEFORE REMOVING THE SCREW, DISCONNECT POWER CORD. HOT SURFACE INSIDE. ALLOW 1 HOUR TO COOL BEFORE REPLACING THE LAMP. REPLACE WITH SAME SHARP LAMP UNIT TYPE BQC-XVZ90+++1 ONLY. UV RADIATION : CAN CAUSE EYE DAMAGE. TURN OFF LAMP BEFORE SERVICING. MEDIUM PRESSURE LAMP : RISK OF EXPLOSION. POTENTIAL HAZARD OF GLASS PARTICLES IF LAMP HAS RUPTURED. HANDLE WITH CARE. SEE OPERATION MANUAL.</p>	<p><b>⚠ PRECAUTIONS A OBSERVER LORS DU REMPLACEMENT DE LA LAMPE.</b></p> <p>DEBRANCHER LE CORDON D'ALIMENTATION AVANT DE RETIRER LES VIS. L'INTERIEUR DU BOITIER ETANT EXTREMEMENT CHAUD, ATTENDRE 1 HEURE AVANT DE PROCEDER AU REMPLACEMENT DE LA LAMPE. NE REMPLACER QUE PAR UNE LAMPE SHARP DE TYPE BQC-XVZ90+++1. RAYONS ULTRAVIOLETS : PEUVENT ENDOMMAGER LES YEUX. ETEINDRE LA LAMPE AVANT DE PROCEDER A L'ENTRETIEN. LAMPE A MOYENNE PRESSION : RISQUE D'EXPLOSION. DANGER POTENTIEL DE PARTICULES DE VERRE EN CAS D'ECLATEMENT DE LA LAMPE. A MANIPULER AVEC PRECAUTION, SE REPORTER AU MODE D'EMPLOI.</p>
---	--

### WARNING:

Some IC chips in this product include confidential and/or trade secret property belonging to Texas Instruments. Therefore you may not copy, modify, adapt, translate, distribute, reverse engineer, reverse assemble or discompile the contents thereof.



# IMPORTANT SAFEGUARDS

Electrical energy can perform many useful functions. This product has been engineered and manufactured to ensure your personal safety. However IMPROPER USE CAN RESULT IN POTENTIAL ELECTRICAL SHOCK OR FIRE HAZARD. In order not to defeat the safeguards incorporated into this Projector, observe the following basic rules for its installation, use and servicing. For your own protection and reliable usage of your Projector, please be sure to read these "IMPORTANT SAFEGUARDS" carefully before use.

## 1. Read Instructions

All the safety and operating instructions should be read before the product is operated.

## 2. Retain Instructions

The safety and operating instructions should be retained for future reference.

## 3. Heed Warnings

All warnings on the product and in the operating instructions should be adhered to.

## 4. Follow Instructions

All operating and use instructions should be followed.

## 5. Cleaning

Unplug this product from the wall outlet before cleaning. Do not use liquid cleaners or aerosol cleaners. Use a damp cloth for cleaning.

## 6. Attachments

Do not use attachments not recommended by the product manufacturer as they may cause hazards.

## 7. Water and Moisture

Do not use this product near water – for example, near a bathtub, wash bowl, kitchen sink, or laundry tub; in a wet basement; or near a swimming pool; and the like.

## 8. Accessories

Do not place this product on an unstable cart, stand, tripod, bracket, or table. The product may fall, causing serious injury to a child or adult, and serious damage to the product. Use only with a cart, stand, tripod, bracket, or table recommended by the manufacturer, or sold with the product. Any mounting of the product should follow the manufacturer's instructions, and should use a mounting accessory recommended by the manufacturer.

## 9. Transportation

A product and cart combination should be moved with care. Quick stops, excessive force, and uneven surfaces may cause the product and cart combination to overturn.



## 10. Ventilation

Slots and openings in the cabinet are provided for ventilation to ensure reliable operation of the product and to protect it from overheating. The openings should never be covered or blocked by placing the product on a bed, sofa, rug, or other similar surface. This product should not be placed in a built-in installation such as a bookcase or rack unless proper ventilation is provided or the manufacturer's instructions have been adhered to.

## 11. Power Sources

This product should be operated only from the type of power source indicated on the marking label. If you are not sure of the type of power supply to your home, consult your product dealer or local power company. For products intended to operate from battery power, or other sources, refer to the operating instructions.

## 12. Grounding or Polarization

This product is equipped with a three-wire grounding-type plug, a plug having a third (grounding) pin. This plug will only fit into a grounding-type power outlet. This is a safety feature. If you are unable to insert the plug into the outlet, contact your electrician to replace your obsolete outlet. Do not defeat the safety purpose of the grounding-type plug.

## 13. Power-Cord Protection

Power-supply cords should be routed so that they are not likely to be walked on or pinched by items placed upon or against them, paying particular attention to cords at plugs, convenience receptacles, and the point where they exit from the product.

## 14. Lightning

For added protection for this product during a lightning storm, or when it is left unattended and unused for long periods of time, unplug it from the wall outlet and disconnect the power cord. This will prevent damage to the product due to lightning and power-line surges.

## 15. Overloading

Do not overload wall outlets, extension cords, or integral convenience receptacles as this can result in a risk of fire or electric shock.

## 16. Object and Liquid Entry

Never push objects of any kind into this product through openings as they may touch dangerous voltage points or short-out parts that could result in a fire or electric shock. Never spill liquid of any kind on the product.

## 17. Servicing

Do not attempt to service this product yourself as opening or removing covers may expose you to dangerous voltage or other hazards. Refer all servicing to qualified service personnel.

## 18. Damage Requiring Service

Unplug this product from the wall outlet and refer servicing to qualified service personnel under the following conditions:

- If the power-supply cord or plug is damaged.
- If liquid has been spilled, or objects have fallen into the product.
- If the product has been exposed to rain or water.
- If the product does not operate normally by following the operating instructions. Adjust only those controls that are covered by the operating instructions, as an improper adjustment of other controls may result in damage and will often require extensive work by a qualified technician to restore the product to normal operation.
- If the product has been dropped or damaged in any way.
- If the product exhibits a distinct change in performance.

## 19. Replacement Parts

When replacement parts are required, be sure the service technician has used replacement parts specified by the manufacturer or with the same characteristics as the original part. Unauthorized substitutions may result in fire, electric shock, or other hazards.

## 20. Safety Check

Upon completion of any service or repairs to this product, ask the service technician to perform safety checks to determine that the product is in proper operating condition.

## 21. Wall or Ceiling Mounting

This product should be mounted to a wall or ceiling only as recommended by the manufacturer.

## 22. Heat

This product should be situated away from heat sources such as radiators, heat registers, stoves, or other products (including amplifiers) that produce heat.



## IMPORTANT SAFEGUARDS

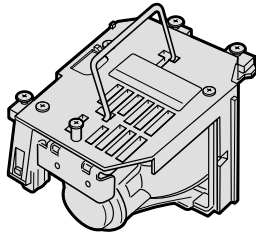

### Caution Concerning the Lamp Unit

There is a potential hazard of glass particles if the lamp ruptures. In case of lamp rupture, contact your nearest Authorized SharpVision Service Center or Dealer for a replacement. See "Replacing the Lamp" on page 46.



This caution is found at the bottom of the projector. See "Caution Concerning the Lamp Replacement" on page 2 for its location.

<p><b>LAMP REPLACEMENT CAUTION</b></p> <p>BEFORE REMOVING THE SCREW, DISCONNECT POWER CORD. HOT SURFACE INSIDE. ALLOW 1 HOUR TO COOL BEFORE REPLACING THE LAMP. REPLACE WITH SAME SHARP LAMP UNIT TYPE BQC-XVZ90+++1 ONLY. UV RADIATION : CAN CAUSE EYE DAMAGE. TURN OFF LAMP BEFORE SERVICING. MEDIUM PRESSURE LAMP : RISK OF EXPLOSION. POTENTIAL HAZARD OF GLASS PARTICLES IF LAMP HAS RUPTURED. HANDLE WITH CARE. SEE OPERATION MANUAL.</p>	<p><b>PRECAUTIONS A OBSERVER LORS DU REMPLACEMENT DE LA LAMPE.</b></p> <p>DEBRANCHER LE CORDON D'ALIMENTATION AVANT DE RETIRER LES VIS. L'INTERIEUR DU BOITIER ETANT EXTREMEMENT CHAUD, ATTENDRE 1 HEURE AVANT DE PROCEDER AU REMPLACEMENT DE LA LAMPE. NE REMPLACER QUE PAR UNE LAMPE SHARP DE TYPE BQC-XVZ90+++1. RAYONS ULTRAVIOLETS : PEUVENT ENDOMMAGER LES YEUX. ETEINDRE LA LAMPE AVANT DE PROCEDER A L'ENTRETIEN. LAMPE A MOYENNE PRESSION : RISQUE D'EXPLOSION. DANGER POTENTIEL DE PARTICULES DE VERRE EN CAS D'ECLATEMENT DE LA LAMPE. A MANIPULER AVEC PRECAUTION, SE REPORTER AU MODE D'EMPLOI.</p>
---	--

### Cautions Concerning the Setup of the Projector

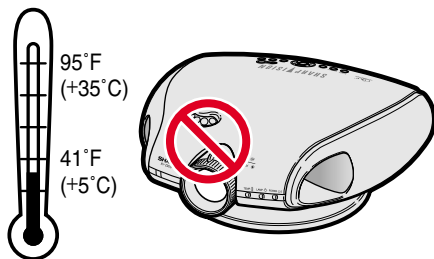

For minimal servicing and to maintain high image quality, SHARP recommends that this projector be installed in an area free from humidity, dust and cigarette smoke. When the projector is subjected to these environments, the lens and part of filter must be cleaned more often than usual. As long as the projector is properly maintained in this manner, use in these environments will not reduce the overall operation life. Please note that all internal cleaning must be performed by an Authorized SharpVision Service Center or Dealer.

- Do not expose the projector to extreme heat or cold.  
Operating temperature: 41°F to 95°F (+5°C to 35°C)  
Storage temperature: -4°F to 140°F (-20°C to +60°C)

### Notes on Operation

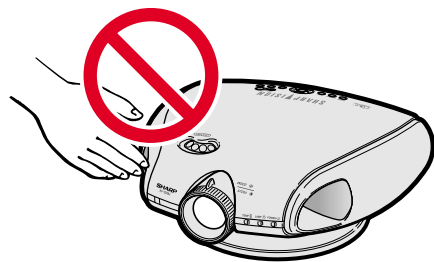

- The exhaust ventilative hole, the lamp cage cover and adjacent areas may get extremely hot during projector operation. To prevent injury, do not touch these areas until they have sufficiently cooled down.
- Allow at least 1 foot (30 cm) of space between the exhaust ventilative hole and the nearest wall or obstruction.
- If the cooling fan becomes obstructed, a protection device will automatically turn off the projector lamp. This does not indicate a malfunction. Remove the projector power cord from the wall outlet and wait at least 10 minutes. Then turn on the power by plugging the power cord back in. This will return the projector to the normal operating condition.

**WARNING:** High brightness light source. Do not stare into the beam of light, or view directly. Be especially careful that children do not stare directly into the beam of light.

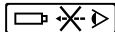



## IMPORTANT SAFEGUARDS



TEMP

### Temperature Monitor Function

If the projector starts to overheat due to setup problems “TEMP” and “

#### NOTE

- The cooling fan regulates the internal temperature, and its performance is automatically controlled. The sound of the fan may change during projector operation due to changes in the fan speed.



LAMP

### Lamp Monitor Function

When the projector is turned on after the lamp has been used for 2,400 hours, “LAMP” and “

### Using the Terminal Cover

When the projector is used on a desktop, high mounted or ceiling mounted, attach the terminal cover (supplied) to hide the connecting cables.

#### Attaching the Terminal Cover

- ① Align with the tabs on the projector and then press the terminal cover in the direction of the arrow.
- ② Tighten the two screws on the bottom of the projector.

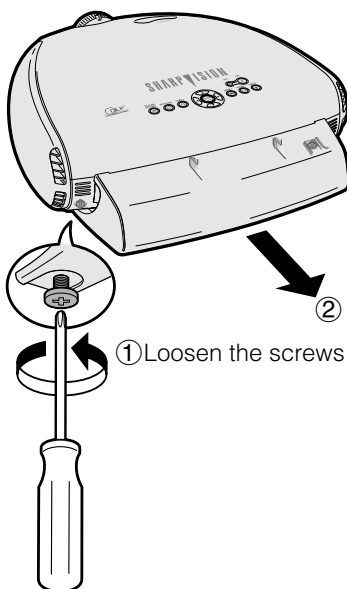
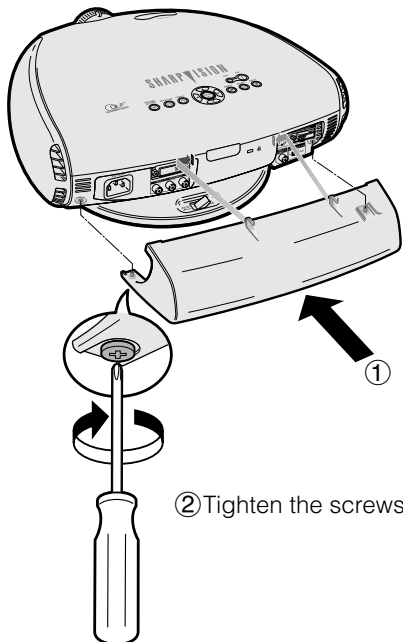

E-5



# Contents



## Important Information

<b>IMPORTANT SAFEGUARDS</b> .....	<b>3</b>
<b>Contents</b> .....	<b>6</b>
<b>Outstanding Features</b> .....	<b>7</b>
<b>Part Names</b> .....	<b>8</b>
<b>Supplied Accessories</b> .....	<b>11</b>



## Setup & Connections

<b>Connections</b> .....	<b>12</b>
Power Supply .....	12
Connecting to Video Equipment .....	12
Connecting to a DVD Player and DTV Decoder .....	13
Connecting to a Computer .....	14
Operating the Remote Control .....	15
Power ON/OFF .....	16
Zooming and Focusing .....	16
<b>Setting Up the Screen</b> .....	<b>17</b>
Using the Swivel Stand .....	17
Using the Lens Shift .....	18
Keystone Correction .....	19
Placement of the Projected Image Using the Keystone Correction .....	20
Adjusting the Projection Distance .....	21
<b>Image Projection</b> .....	<b>23</b>
Rear Projection .....	23
Projection Using a Mirror .....	23
Ceiling-mount Projection .....	23



## Operation Buttons

<b>Using the Operation Buttons</b> .....	<b>24</b>
Selecting the Input Signal Source .....	24
Adjusting the Picture Aspect Ratio .....	24



## Basic Operation

<b>Using the Menu Screen</b> .....	<b>26</b>
Basic Operations .....	26
Menu Bars .....	27
Adjusting the Picture .....	29
Adjusting the Computer and DVD/DTV Images .....	33

Turning On/Off the On-screen Display .....	36
Selecting the Signal Type .....	36
Setting the Video Signal (VIDEO menu only) .....	37
Selecting a Background Image .....	37
Adjustments for the Screen Position and Size .....	38
Selecting the Menu Screen Position .....	40
Selecting the Menu Color .....	40
Automatic Power Shut-off Function .....	41
Reversing/Inverting Projected Images .....	42
Selecting the On-screen Display Language .....	42
Advanced Picture Adjustment .....	43



## Maintenance & Troubleshooting

<b>Lamp/Maintenance Indicators</b> .....	<b>44</b>
<b>Lamp Maintenance</b> .....	<b>45</b>
Confirming the Lamp Usage Time .....	45
Replacing the Lamp .....	46
<b>Cleaning the Ventilative Holes</b> .....	<b>49</b>
<b>Using the Kensington Lock</b> .....	<b>50</b>
<b>Troubleshooting</b> .....	<b>50</b>
<b>For SHARP Assistance (U.S.A. only)</b> .....	<b>50</b>



## Appendix

<b>Connecting Pin Assignments</b> .....	<b>51</b>
<b>(RS-232C) Specifications and Command Settings</b> .....	<b>52</b>
<b>Computer Compatibility Chart</b> .....	<b>54</b>
<b>Dimensions</b> .....	<b>55</b>
<b>Specifications</b> .....	<b>56</b>
<b>Glossary</b> .....	<b>57</b>
<b>Index</b> .....	<b>58</b>

Important Information



Setup & Connections



Operation Buttons



Basic Operation



Maintenance & Troubleshooting



Appendix





## Outstanding Features

### 1. **DMD™\* (Digital Micromirror Device) Chip**

The DMD Chip allows for a higher contrast image. It enables smoother expression of details of an image, and high picture quality for an exciting theater experience.

\* Digital Light Processing, DLP, Digital Micromirror Device and DMD are trademarks of Texas Instruments.

### 2. **Five Speed Primary Color Wheel**

The color wheel consists of only the three primary colors of the light and creates a higher contrast image with high color purity.

### 3. **Advanced Video Circuitry**

The video circuit setup is designed for obtaining optimal images from audiovisual equipment. The circuit optimizes high optical performance that originates in the DMD chip and the five speed primary color wheel, to realize outstanding video images.

### 4. **Low Noise Design**

A new optical engine has been developed for this product to minimize fan noise for undisturbed viewing.

### 5. **Lens Shift Function**

The digital shift function optically adjusts the vertical position of images. The function allows for simple adjustment when setting up the projector for the first time.

### 6. **2D Keystone Correction**

The 2D keystone correction function electrically corrects the size of projected images. The function enables diagonal projection and the wider range settings.

### 7. **HDCP (High-bandwidth Digital Content Protection) System**

Digital entertainment content is protected from copying with the HDCP system.

### 8. **For Use with DTV**

Allows projection of DTV images and 16:9 wide-screen images when connected to a DTV decoder or similar video system.

### 9. **Easy-to-use Graphical User Interface (GUI)**

A multi-color menu system, which allows for simple image adjustments.

### 10. **Color Temperature Adjustment**

The function can be used to adjust the color temperature to suit the type of image input to the projector.

### 11. **Gamma Correction Function**

The gamma value setting can be adjusted according to the input source for optimal image contrast.

### 12. **Picture Setting Function**

The values in various adjustment settings can be stored. The function can be used to select the values to suit the type of image input to the projector by pressing the **PICTURE SETTING** button on the projector or on the remote control.

### 13. **Component Video Input**

Utilizes a component video input signal (Y, P<sub>B</sub>, P<sub>R</sub>). The video signal is input as separate components to provide superior color and image quality.

### 14. **Direct Computer Compatibility**

A multi-scan RGB input accepts signals from VGA (640 dots × 480 lines) and Macintosh (from 13" compatible computers) without the need for any additional hardware.





# Part Names

Important Information



Numbers next to the part names refer to the main pages in this manual where the topic is explained.

## Projector

### Front and Top View

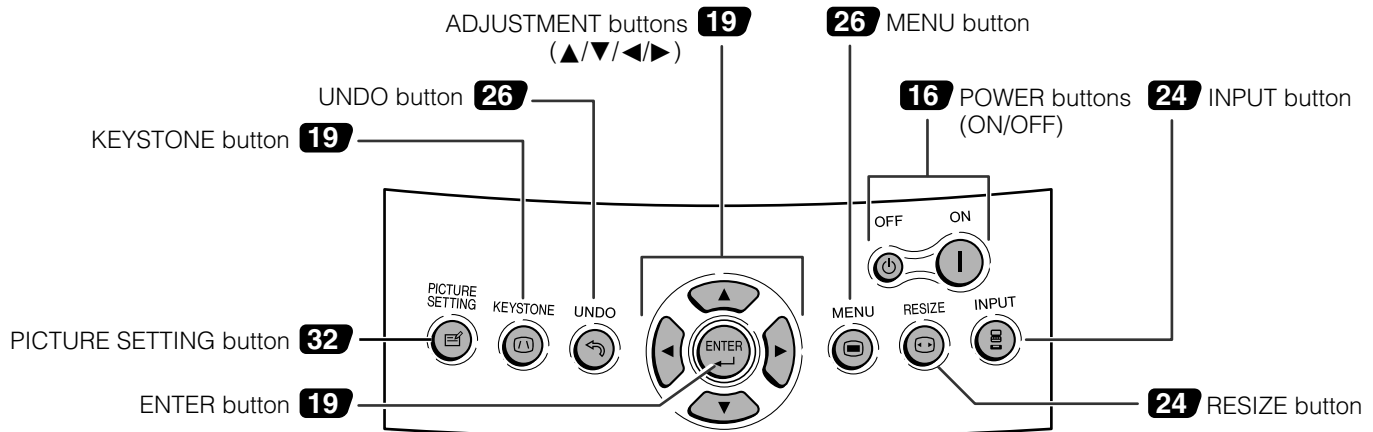
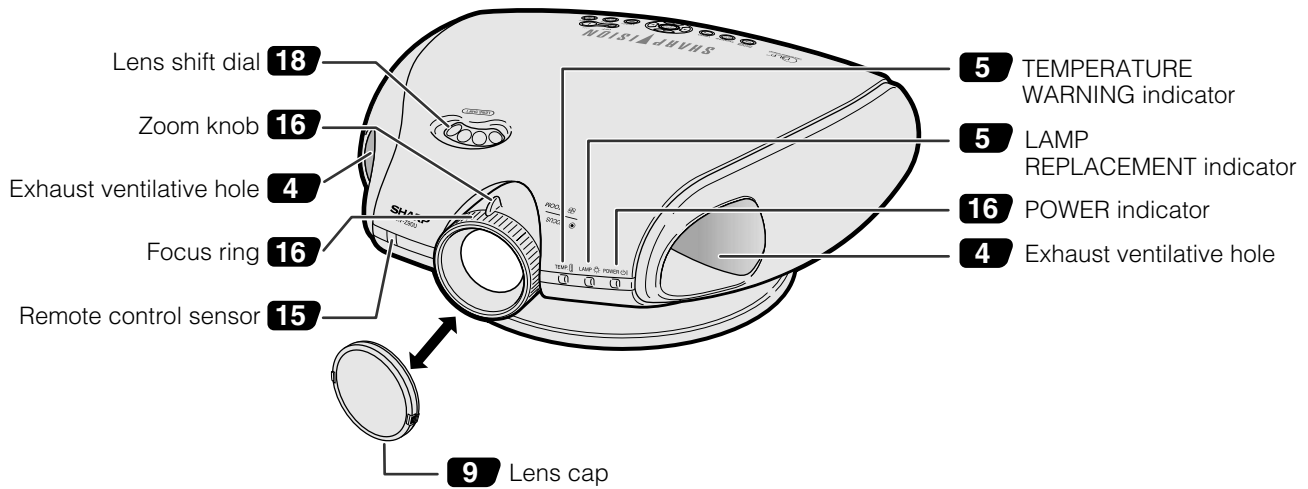

### Side and Rear View

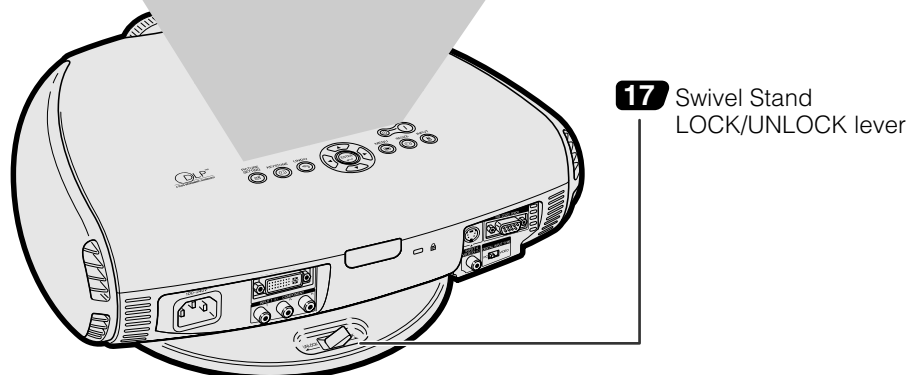



## Part Names

Numbers next to the part names refer to the main pages in this manual where the topic is explained.

### Projector

#### Side and Rear View

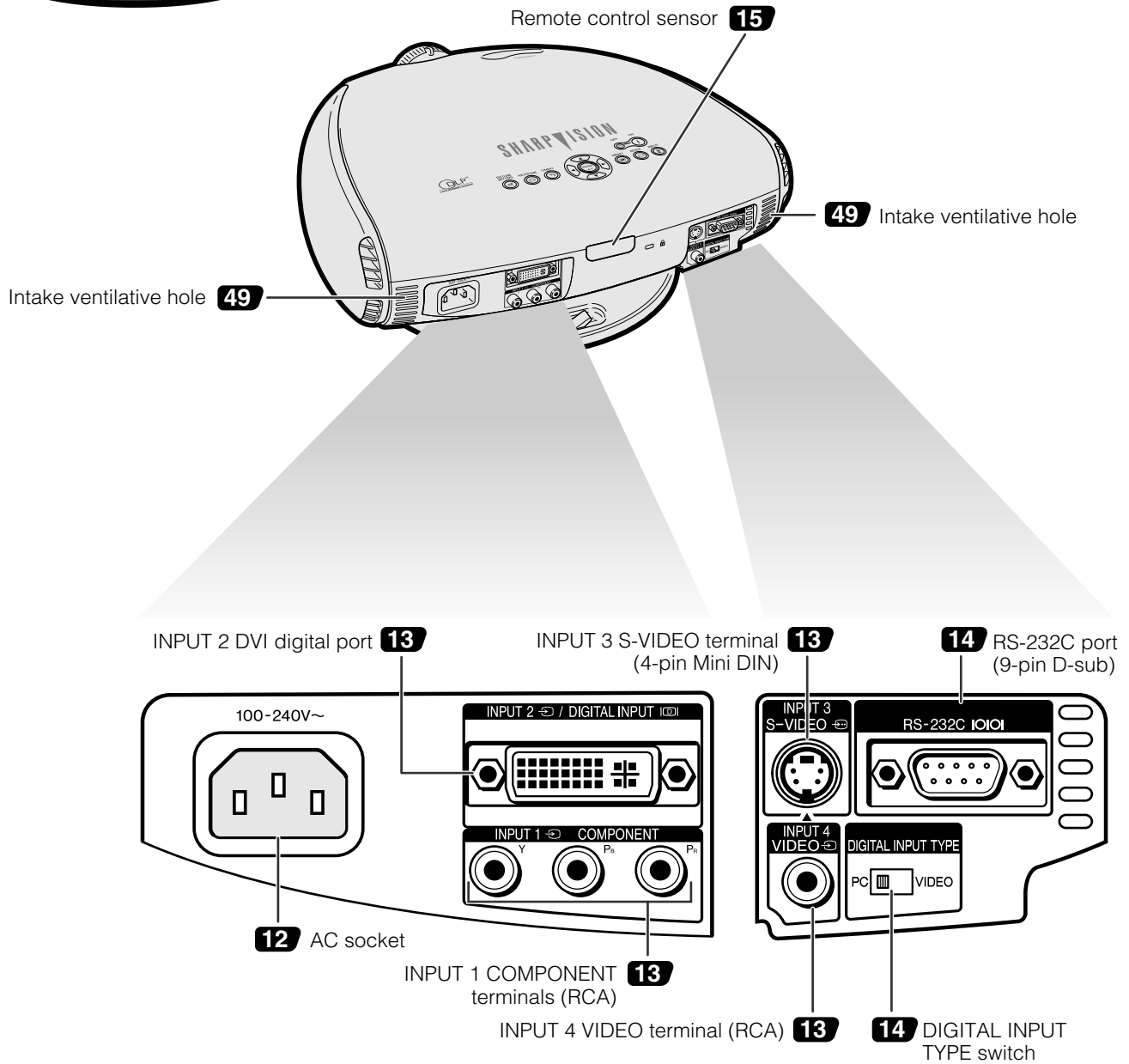

#### Attaching the Lens Cap

After putting the lens cap strap on the lens cap, pass the other end of the strap through the hole under the projector, next to the lens.

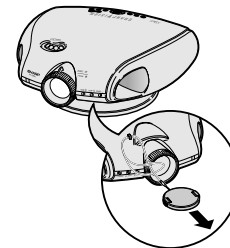



## Part Names

Important Information



### Remote Control

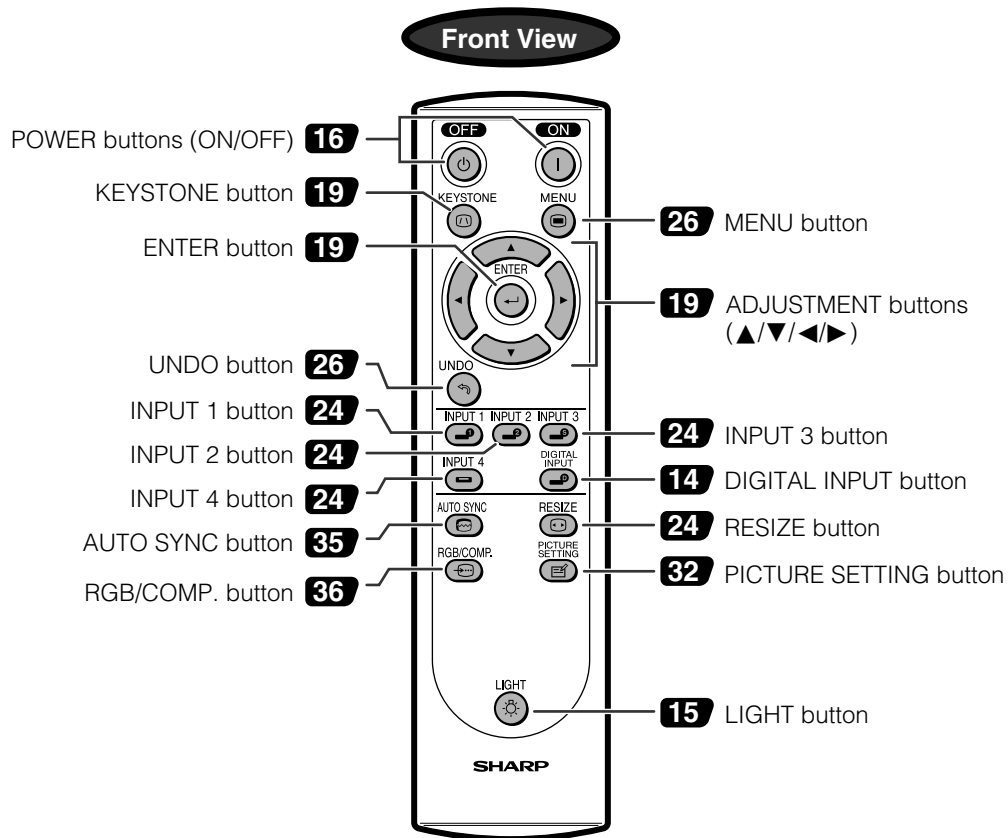

### Top View

Remote control signal transmitters

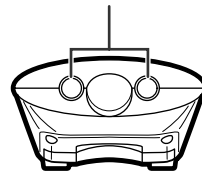

### Inserting the batteries

**1** Pull down the tab on the battery cover and remove the cover towards the direction of the arrow.

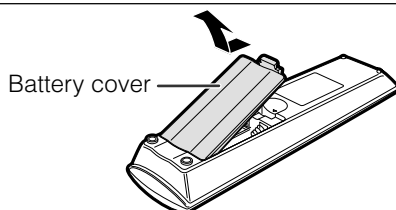

**2** Insert two AA size batteries, making sure the polarities match the + and - marks inside the battery compartment.

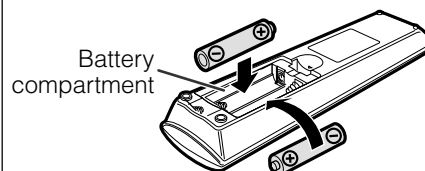

**3** Insert the lower tab of the battery cover into the opening, and press the cover until it clicks in place.

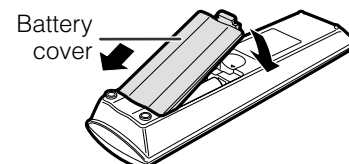



# Supplied Accessories

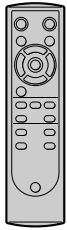

Remote control  
RRMCGA064WJSA



Two AA size batteries

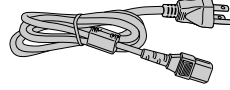

Power cord  
QACDA007WJPZ

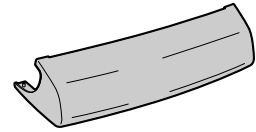

Terminal cover  
GCOVAA116WJKA



Lens cap  
CCAPHA004WJ01



Lens cap strap  
UBNDT0013CEZZ

Operation manual  
TINS-A286WJZZ

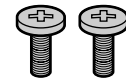

Screws for terminal cover  
XBBSN40P10000

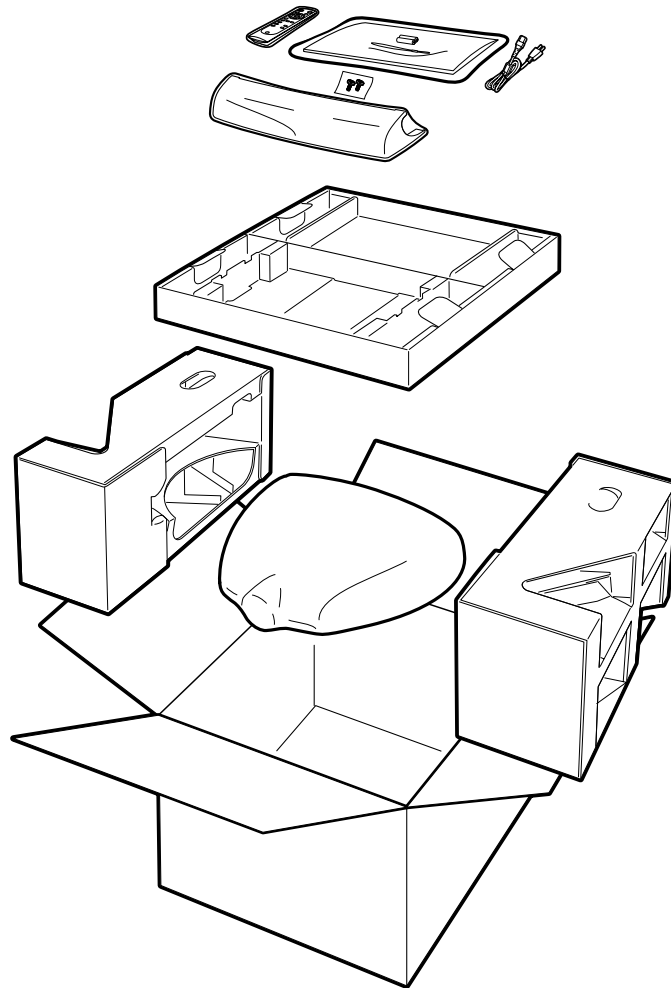



# Connections



## Power Supply

### Connecting the Power Cord

Plug the supplied power cord into the AC socket on the back of the projector.

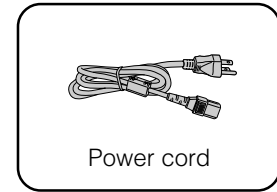
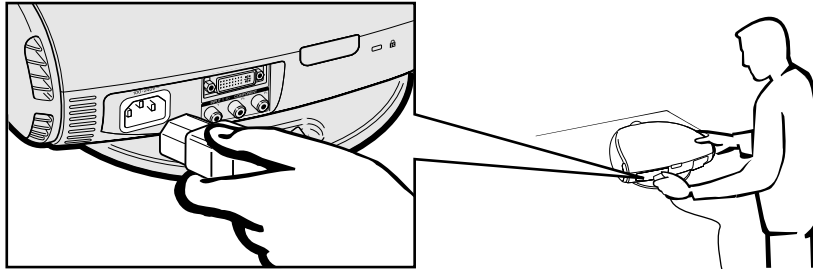

#### CAUTION

- Make sure the power cord is firmly connected into the AC socket.

#### NOTE

- The projector will enter the standby mode as you re-plug it into the AC socket, when unplugging the power cord after turning the power off by pressing the **POWER** button. However, if the projector was turned off by disconnecting the power cord or by a power failure, the projector will automatically turn on when plugging the power cord again.



## Connecting to Video Equipment

You can connect your projector to a VCR, laser disc player, DVD player, DTV\* decoder and other video equipment.

\* DTV is the umbrella term used to describe the new digital television system in the United States.

#### CAUTION

- Make sure to turn both the projector and the video equipment off, before connecting.

#### NOTE

- As this projector is not equipped with audio input terminals, commercially available audio equipment or your own equipment (such as speakers or amplifiers) should be used.

### Connecting a video source (VCR, laser disc player, DVD player or DTV decoder) using the INPUT 3 S-VIDEO and INPUT 4 VIDEO terminals

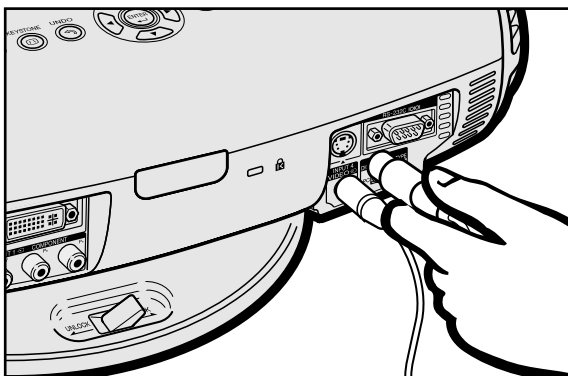

- ① Connect one end of the S-video cable (commercially available) to the **INPUT 3 S-VIDEO** terminal, or one end of the video cable (commercially available) to the **INPUT 4 VIDEO** terminal on the projector.
- ② Connect the other end of the S-video cable or the video cable to the S-video output or Video output terminal of the video source.

The S-video input terminal uses a video signal system where the picture is separated into a color and luminance signal to realize a higher-quality image.

#### NOTE

- For higher quality video, you may use the S-video input terminal on the projector. An S-video cable is commercially available.
- If your video equipment does not have an S-video output terminal, use the composite video output terminal.





## Connecting to Video Equipment

### Projector

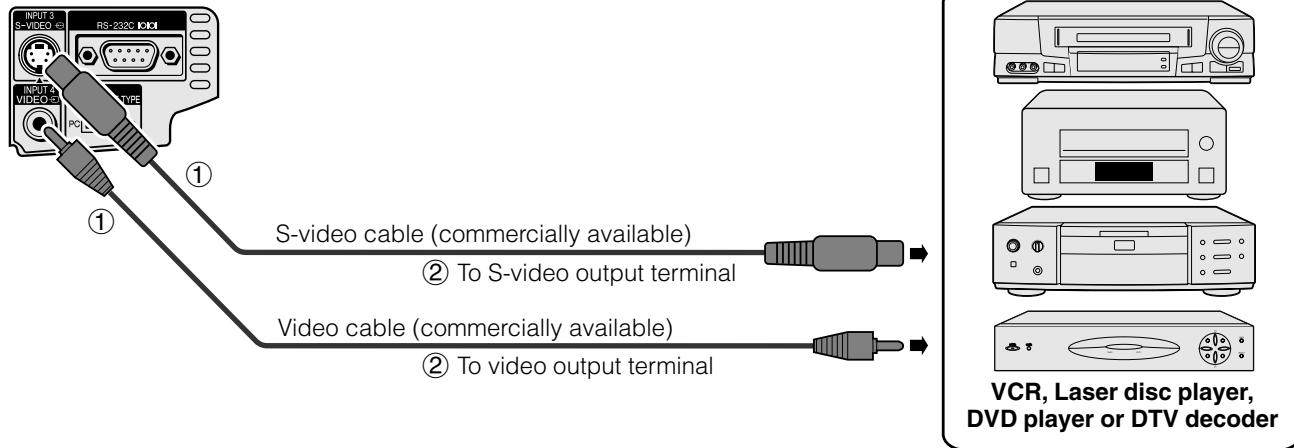

## Connecting to a DVD Player and DTV Decoder

### Connecting to a DVD player and DTV decoder with Component output (for INPUT 1)

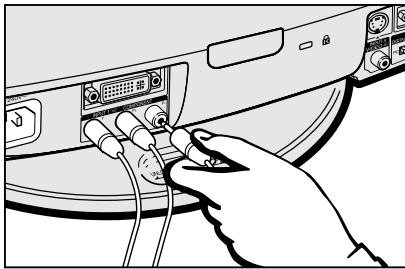

- ① Connect each RCA connector of a component cable to the corresponding RCA INPUT 1 terminals on the projector.
- ② Connect the other end of the cable to the corresponding terminals on a DVD player or DTV decoder.

#### CAUTION

- Make sure to turn both the projector and the video equipment off, before switching the "DIGITAL INPUT TYPE" switch and connecting.

### Projector

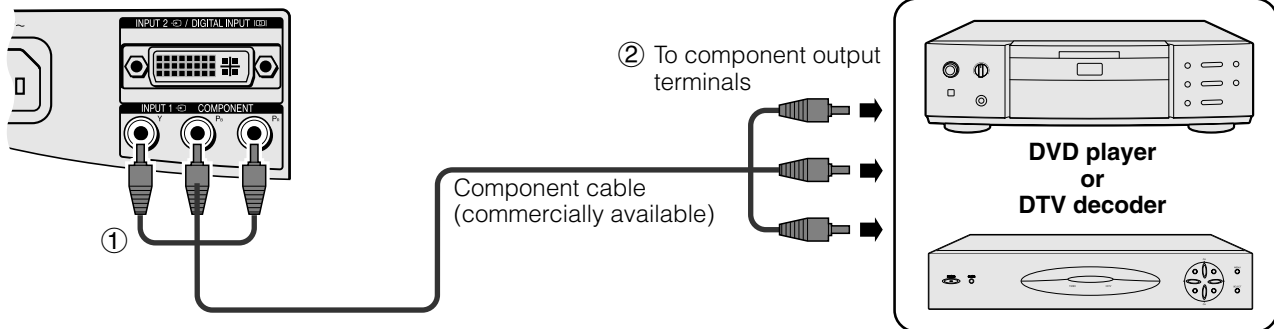

### Connecting to a DVD player and DTV decoder with component output (for INPUT 2)

- ① Connect the 3 RCA to 15-pin D-Sub cable using the DVI to 15-pin D-Sub adaptor.
- ② Use the above cables to connect the projector and the DTV decoder.

When connecting this projector to analog RGB output of the DTV decoder, select "Component" for "Signal Type" on the OSD menu or press **RGB/COMP.** on the remote control. (See page 36.)

#### CAUTION

- Make sure to turn both the projector and the video equipment off, before switching the "DIGITAL INPUT TYPE" switch and connecting.

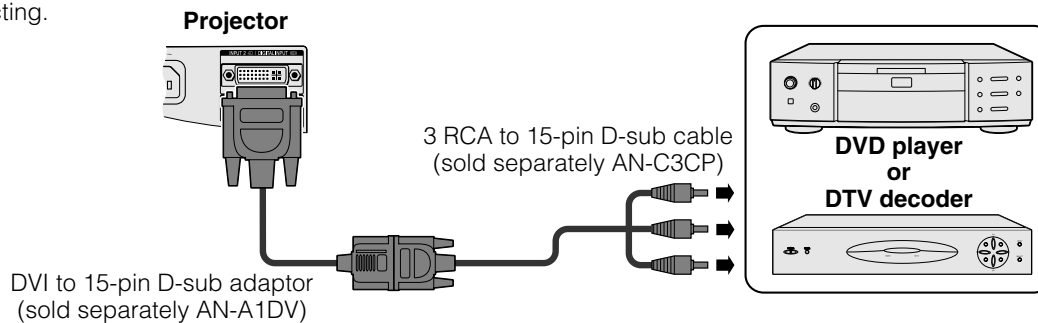



## Connecting to a DVD Player and DTV Decoder

### Connecting to a DTV decoder with DVI output

- ① Slide the "DIGITAL INPUT TYPE" switch on the back terminal board to "VIDEO".
- ② Connect the DVI cable to the DIGITAL INPUT terminal.
- ③ Connect the other end to the Corresponding terminal on a DVD player and DTV decoder.

When connecting this projector to analog RGB output of the DTV decoder, select "Component" for "Signal Type" on the OSD menu or press **RGB/COMP.** on the remote control. (See page 36.)

#### CAUTION

- Make sure to turn both the projector and the video equipment off, before switching the "DIGITAL INPUT TYPE" switch and connecting.

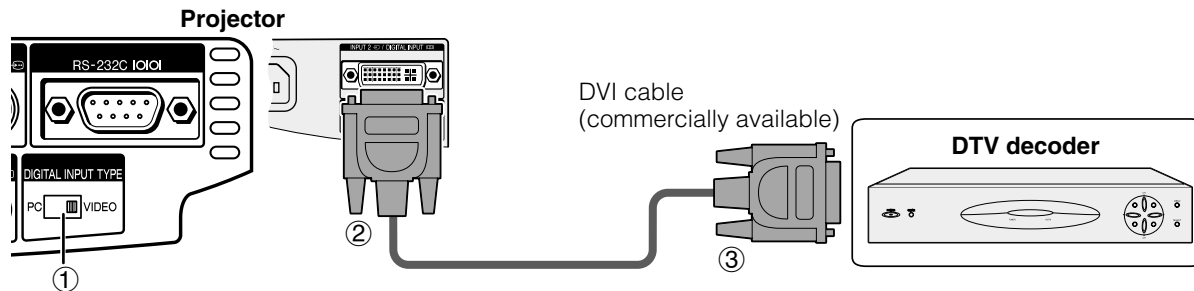

### Connecting to a DTV decoder with analog RGB output

- ① Connect the DVI to 15-pin D-Sub adaptor.
- ② Use the above cables to connect the projector and the DTV decoder.

When connecting this projector to analog RGB output of the DTV decoder, select "Component" for "Signal Type" on the OSD menu or press **RGB/COMP.** on the remote control. (See page 36.)

#### CAUTION

- Make sure to turn both the projector and the video equipment off, before switching the "DIGITAL INPUT TYPE" switch and connecting.

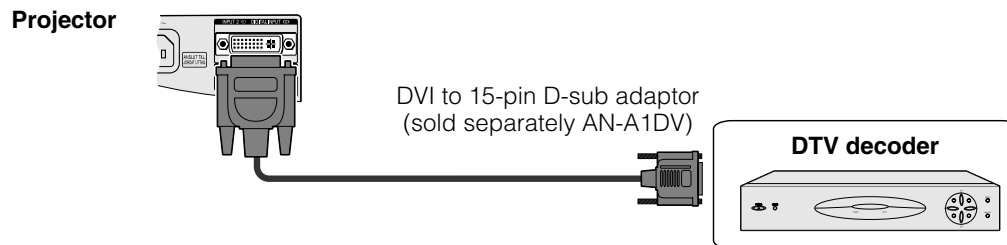

## Connecting to a Computer

When the RS-232C port on the projector is connected to a computer with an RS-232C cable (null modem, cross type, commercially available), the computer can be used to control the projector and check the status of the projector. See pages 52 and 53 for details.

### Connecting a computer with analog RGB output

- ① Connect the DVI end of the DVI to 15-pin D-sub adaptor to the INPUT 2 port on the projector.
- ② Connect the D-sub end of the DVI to 15-pin D-sub adaptor to the computer.

When connecting this projector to a DVD player or DTV decoder, select "RGB" for "Signal Type" on the OSD menu or press **RGB/COMP.** on the remote control. (See page 36.)

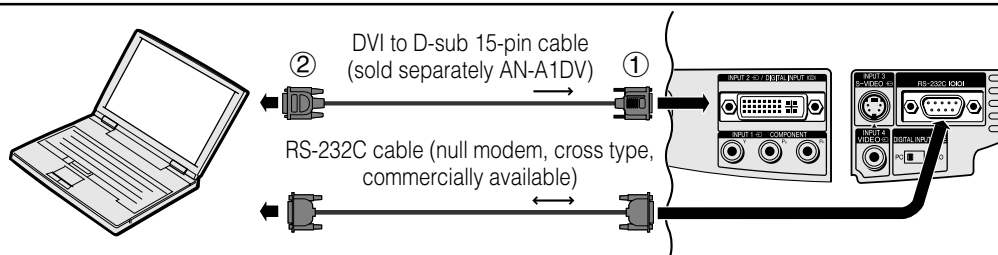



## Connecting to a Computer

### Connecting a computer with DIGITAL RGB output

- ① Slide the "DIGITAL INPUT TYPE" switch on the back terminal board to "PC".
  - ② Connect one of the DVI cable (commercially available) to the DIGITAL INPUT port on the projector.
  - ③ Connect the other end to the Corresponding terminal on a computer.
- Make sure to turn both the projector and the video equipment off, before switching the "DIGITAL INPUT TYPE" switch and connecting.

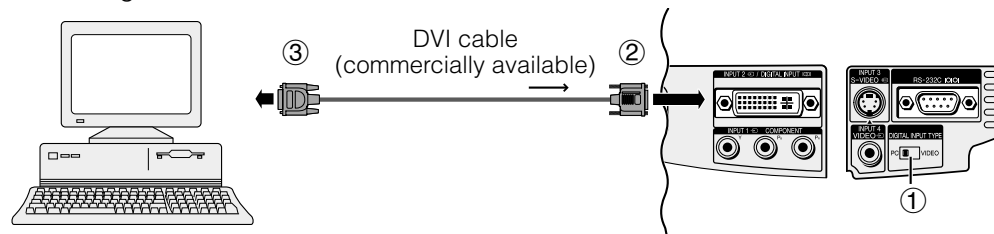

Connect an RS-232C cable (null modem, cross type, commercially available) to the serial port on the computer.

#### CAUTION

- Do not connect or disconnect an RS-232C cable to or from the computer while it is on. This may damage your computer.

#### NOTE

- Refer to "Computer Compatibility Chart" on page 54 for a list of computer signals compatible with the projector. Use with computer signals other than those listed may cause some of the functions not to work.
- The RS-232C function may not operate if your computer port is not correctly set up. Please refer to the operation manual of the computer for details.
- The arrows (→, ↔) in the configuration above indicate the direction of the signals.
- A Macintosh adaptor may be required for use with some Macintosh computers. Contact your nearest Authorized SharpVision Service Center or Dealer.



## Operating the Remote Control

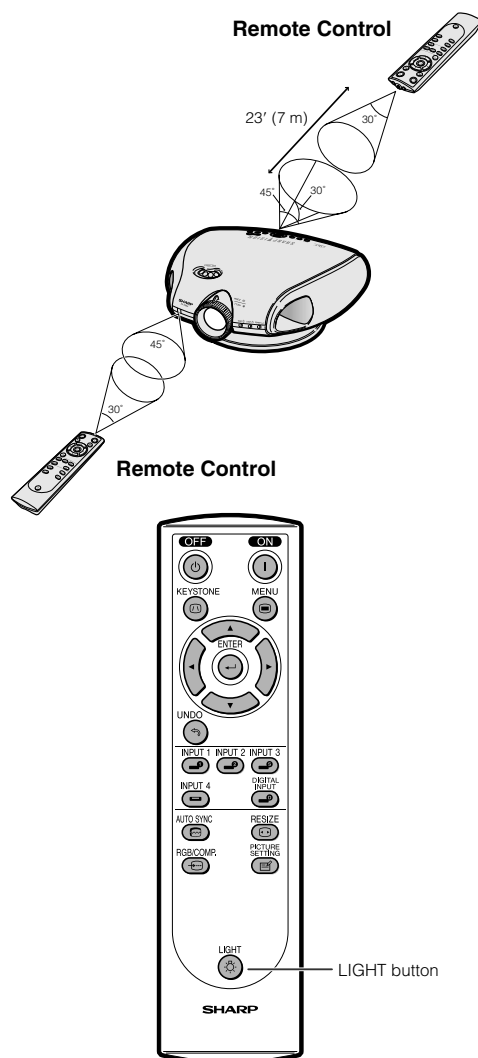

The remote control can be used to control the projector within the range shown on the left.

#### NOTE

- The signal from the remote control can be reflected off a screen for easy operation. However, the effective distance of the signal may differ due to the screen material.

### Using the remote control in a dark room

The backlights of the operation buttons can be turned on for five seconds and off by pressing **LIGHT**. If you want to turn off the backlights while they are on, press **LIGHT** again.





## Power ON/OFF

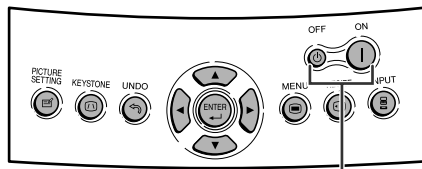

POWER buttons

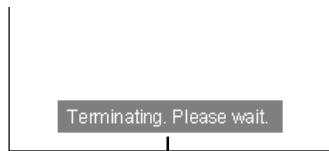
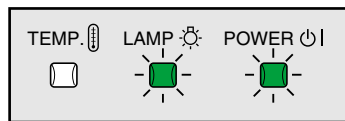
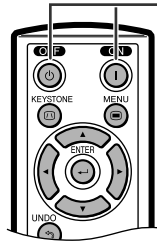

A dimly lit screen is displayed for a short time (about 20 seconds) to reduce lamp damage.

### Press **POWER ON**.

- The blinking green LAMP REPLACEMENT indicator shows that the lamp is warming up. Wait until the indicator stops blinking before operating the projector.
- If the power is turned off and then immediately turned on again, it may take a short while before the lamp turns on.

#### **NOTE**

- After the projector is unpacked and turned on for the first time, a slight odor may be emitted from the exhaust ventilative hole. This odor will soon disappear with use.

When the power is on, the LAMP REPLACEMENT indicator illuminates, indicating the status of the lamp.

**Green:** Lamp is ready.

**Green blinking:** Warming up. / Cooling down.

**Red:** Change the lamp.

### Press **POWER OFF**.

- Press **POWER OFF** again while the confirmation message is displayed. Then, message "Terminating. Please wait." will appear.

#### **NOTE**

- If you accidentally pressed **POWER OFF** and do not want to turn off the power, wait until the confirmation message disappears.
- When **POWER OFF** is pressed twice, the POWER indicator will illuminate in red and the cooling fan will run for about 90 seconds. The projector will then enter standby mode.
- Wait until the cooling fan stops running before disconnecting the power cord.
- The power can be turned on again by pressing **POWER ON**. When the power is turned on, the POWER indicator and the LAMP REPLACEMENT indicators illuminate in green.



## Zooming and Focusing

The picture can be zoomed in or out, and focused by the Zoom knob and the Focus ring.

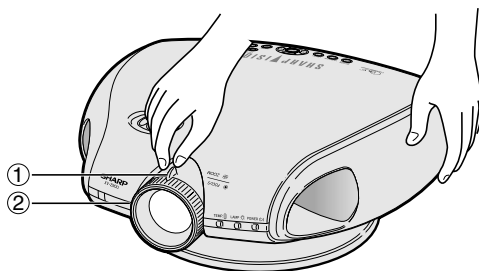

- ① Slide the Zoom knob. The image can be adjusted to the desired size within the zoom range.
- ② Rotate the Focus ring until the image on the screen becomes clear.





# Setting Up the Screen



## Using the Swivel Stand

①



You can adjust the angle and direction of the projected image by using the Swivel Stand.

① Unlock the lever on the Swivel Stand.

②

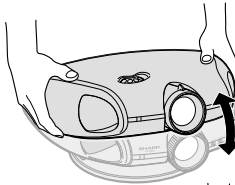

② Adjust the angle and direction of the projected image as you want by lifting up the projector and rotating the projector on the Swivel Stand.

③ Lock the lever on the Swivel Stand.

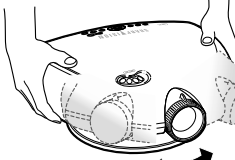

Adjustable up to  $\pm 10^\circ$  from the standard position.

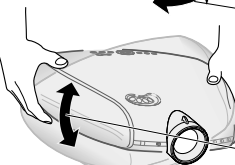

Adjustable up to  $\pm 25^\circ$  from the standard position.

③

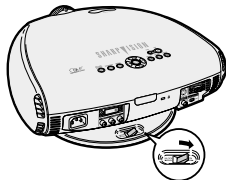

Adjustable up to  $\pm 3^\circ$  from the standard position.

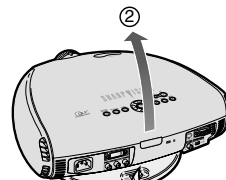

### Removing the Swivel Stand

Lift the projector (②) with pressing the removing-stand button on the back of the projector (①).

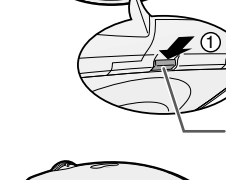

### Attaching the Swivel Stand

Align the tabs on the front bottom of the projector (①). While holding down the button (②), place the projector onto the Swivel Stand (③) to attach.

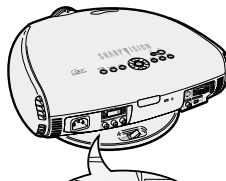

Removing-stand button

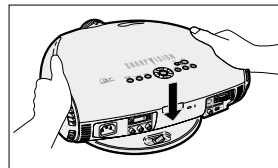

Press the projector down firmly to attach it to the Swivel Stand to make sure it is securely attached to the Swivel Stand.

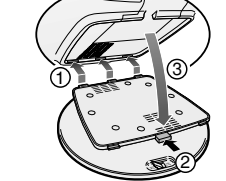

#### CAUTION

- Do not hold the lens when lifting, lowering or rotating the projector.
- When lowering the projector, be careful not to get your fingers caught in the area between the Swivel Stand and the projector.

#### NOTE

- When the height or direction of the projector is adjusted, the image may become distorted (keystoned), depending on the relative positions of the projector and the screen. See page 19 for details on the keystone correction.



# Using the Lens Shift

The picture can be adjusted within the shift range of the lens by rotating the lens shift dial on the top of the projector using your finger.

**Projector**

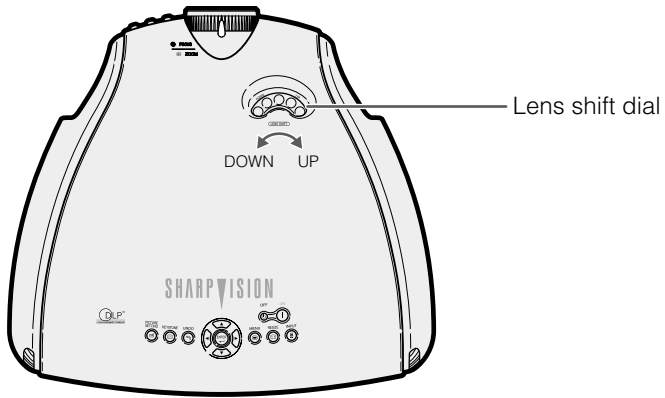

**Projected Image**

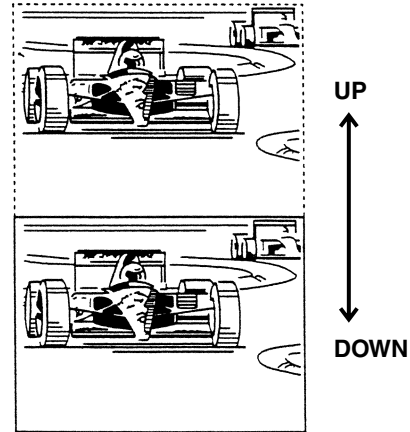



# Keystone Correction

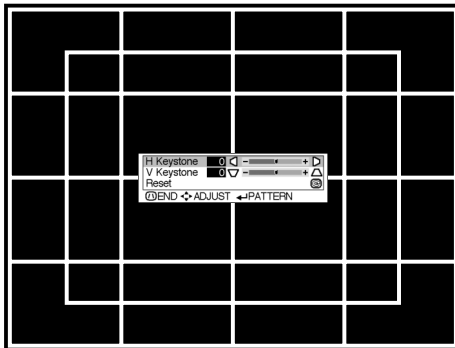
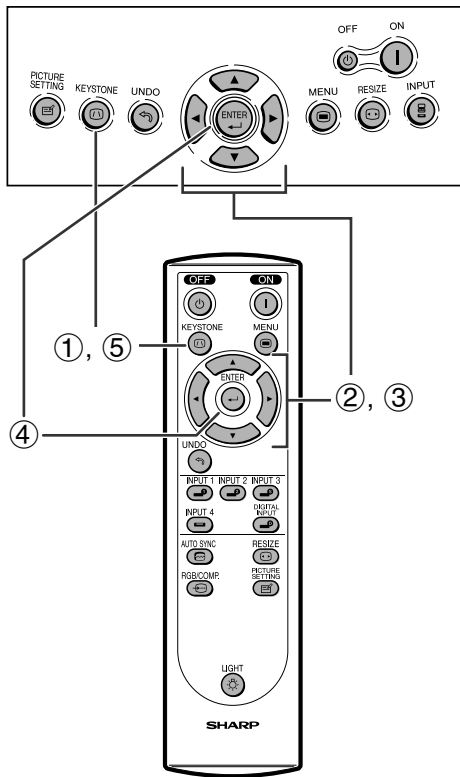

This function can be used to adjust the Keystone settings.

### NOTE

- For details about using the menu screen, see page 26.

### Description of 2D Keystone Correction

Selected item	Description
H Keystone	Horizontally adjusts the keystone settings.
V Keystone	Vertically adjusts the keystone settings.
Reset	V and H Keystone adjustments are returned to the factory preset settings.

### Horizontal Keystone Correction

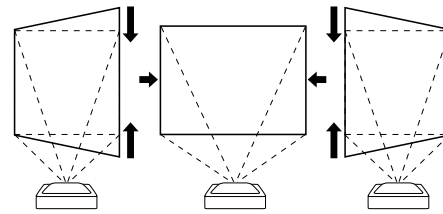

### Vertical Keystone Correction

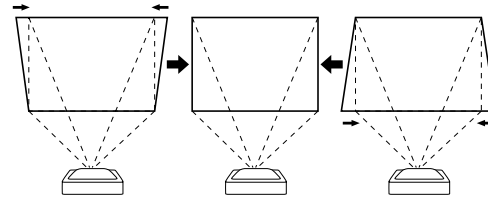

- ① Press **KEYSTONE** on the projector or on the remote control.
- ② Press **▲/▼** to select “H Keystone” or “V Keystone”.
- ③ Press **◀/▶** to move the **■** mark on the selected adjustment item to the desired setting.
- ④ The test pattern is displayed when **ENTER** is pressed. This test pattern can then be used to make fine adjustments in the same manner as described in the step 3.
- ⑤ To return to the normal screen, press **KEYSTONE** again.

### NOTE

- You can display the blue screen by pressing **ENTER** when adjusting the Keystone setting.
- Straight lines and the edges of the displayed image may appear jagged, when adjusting the Keystone setting.
- When adjusting “H Keystone” and “V Keystone” at the same time, the values of adjustable angles for each setting become smaller.
- The adjustment range may be limited depending on the Digital Shift and Subtitle adjustment values.



# Placement of the Projected Image Using the Keystone Correction



■ : Screen area

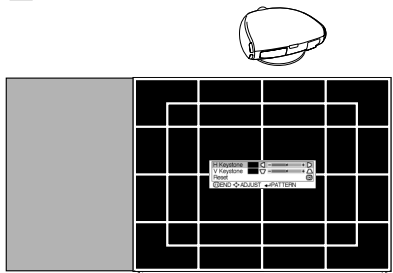

① Project the test pattern of the Keystone correction function onto the screen. Rotate the Focus ring until the image on the screen becomes clear. (See page 16.)

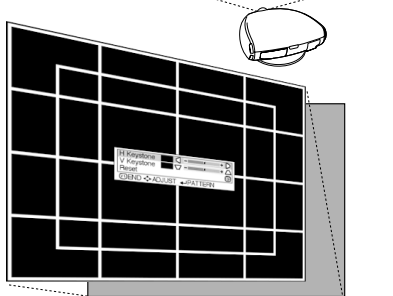

② Change the projection angle using the Swivel Stand to properly project images onto the screen. (See page 17.)

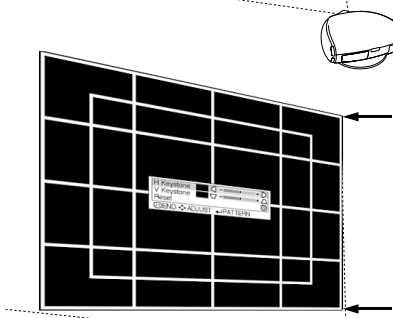

③ Align the edge of the screen closest to the projector with the test pattern by adjusting the zoom and the Swivel Stand. (See pages 16 and 17.)

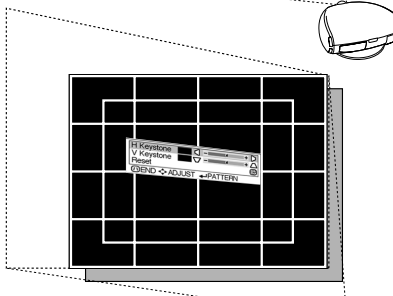

④ Adjust the Keystone function so that the size of the projected image matches the screen size. (See page 19.)

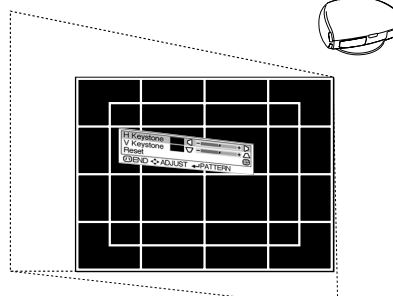

⑤ Align the image on the screen by adjusting the zoom function and the Swivel Stand. If the vertical length of the projected image does not match the screen use the "Subtitle" function. (See page 39.)



⑥ Adjust the focus so that the projected image is in focus at the center of the screen. (See page 16.)

### NOTE

- The aspect ratio of the projected image shifts slightly when the lens shift is at a position other than the top position.
- The aspect ratio of the projected image also shifts slightly when the "H Keystone" and "V Keystone" functions are adjusted simultaneously.





# Adjusting the Projection Distance

Position the projector perpendicular to the screen with all feet flat and leveled to achieve an optimal image. Move the projector forward or backward if the edges of the image are distorted.

## NOTE

- The projector lens should be centered in the middle of the screen. If the lens center is not perpendicular to the screen, the image will be distorted, making viewing difficult.
- Position the screen so that it is not in direct sunlight or room light. Light falling directly onto the screen washes out colors, making viewing difficult. Close the curtains and dim the lights when setting up the screen in a sunny or bright room.
- A polarizing screen cannot be used with this projector.

## Standard Setup (Front Projection)

Place the projector at the required distance from the screen according to the desired screen size. (See the tables below.)

The figures in the tables are based upon projecting an image so that it occupies the entire screen.

Center of the screen

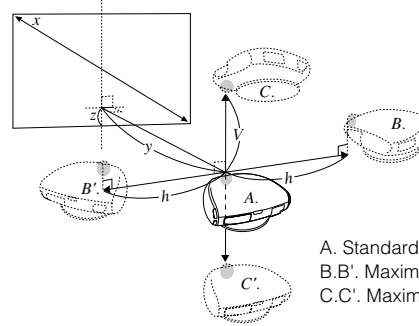

Placement range as determined by Keystone correction

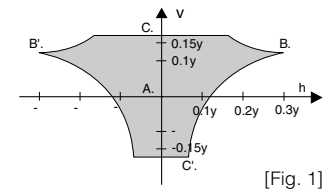

[Fig. 1]

- A. Standard placement range
- B.B'. Maximum horizontal placement range
- C.C'. Maximum vertical placement range

## When using a normal screen (4:3)

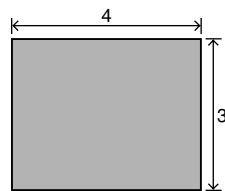

Screen area

Screen size (4:3)			Projection distance and Keystone correction						Distance from the lens center to the bottom edge of the image (z)		
Diag. (x)	Width	Height	Maximum (y <sub>1</sub> )	Maximum horizontal placement range (h)	Maximum vertical placement range (v)	Minimum (y <sub>2</sub> )	Maximum horizontal placement range (h)	Maximum vertical placement range (v)	Upper (z <sub>1</sub> )	Lower (z <sub>2</sub> )	
200"	160"	120"	-						33'9" (10.3 m)	10' 5" (3.18m)	5' 10" (-304.8 cm)
150"	120"	90"	30'5" (9.3 m)	9' 5" (2.86m)	5' 3" (1.61m)	25'4" (7.7 m)	7' 10" (2.38m)	4' 5" (1.34m)	0" (0 cm)	-7'6" (-228.6 cm)	
100"	80"	60"	20'3" (6.2 m)	6' 3" (1.91m)	3' 6" (1.07m)	16'10" (5.1 m)	5' 2" (1.59m)	2' 11" (0.89m)	0" (0 cm)	-5' (-152.4 cm)	
84"	67"	50"	16'12" (5.2 m)	5' 3" (1.60m)	2' 11" (0.90m)	14'11" (4.3 m)	4' 4" (1.33m)	2' 5" (0.75m)	0" (0 cm)	-4'2" (-128.0 cm)	
72"	58"	43"	14'6" (4.4 m)	4' 6" (1.37m)	2' 6" (0.77m)	12'11" (3.7 m)	3' 9" (1.14m)	2' 1" (0.64m)	0" (0 cm)	-3'7" (-109.7 cm)	
60"	48"	36"	12'11" (3.7 m)	3' 9" (1.14m)	2' 1" (0.64m)	10'11" (3.1 m)	3' 1" (0.95m)	1' 9" (0.53m)	0" (0 cm)	-3' (-91.4 cm)	
40"	32"	24"	8' (2.4 m)	2' 6" (0.75m)	1' 5" (0.42m)	6'8" (2.0 m)	2' 1" (0.63m)	1' 2" (0.35m)	0" (0 cm)	-2' (-61.0 cm)	

The formula for screen size and projection distance

$$y_1 (\text{Max.}) = (0.062085x - 0.038555) / 0.3048$$

$$y_2 (\text{Min.}) = (0.051672x - 0.038495) / 0.3048$$

$$z_1 (\text{Upper}) = 0 \quad h : 0.309y$$

$$z_2 (\text{Lower}) = -0.6x \quad v : 0.174y$$

x : Screen size (diag.) (inches)  
 y : Projection distance (feet)  
 z : Distance from the lens center to the lower edge of the screen (feet)

## NOTE

- There is an error of ±3% in the formula above.
- The values of horizontal and vertical values may be limited when Keystone correction is applied simultaneously in the horizontal and vertical directions. (See the diagram [fig. 1] above.)

## When using a wide screen (16:9)

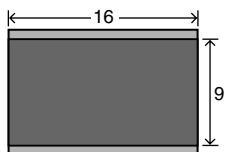

Picture area  
Area covered by the projection panel of the projector

Screen size (16:9)			Projection distance and Keystone correction						Distance from the lens center to the bottom edge of the image (z)		
Diag. (x)	Width	Height	Maximum (y <sub>1</sub> )	Maximum horizontal placement range (h)	Maximum vertical placement range (v)	Minimum (y <sub>2</sub> )	Maximum horizontal placement range (h)	Maximum vertical placement range (v)	Upper (z <sub>1</sub> )	Lower (z <sub>2</sub> )	
200"	174"	98"	-						36'10" (11.2 m)	11' 4" (3.46m)	6' 5" (1.94m)
150"	131"	74"	33'2" (10.1 m)	10' 3" (3.12m)	5' 9" (1.75m)	27'7" (8.4 m)	8' 6" (2.60m)	4' 9" (1.46m)	1" (31.1 cm)	-7'2" (-271.9 cm)	
133"	116"	65"	29'5" (9.0 m)	9' 1" (2.78m)	5' 2" (1.56m)	24'5" (7.4 m)	7' 6" (2.29m)	4' 3" (1.28m)	11" (27.6 cm)	-6'4" (-193.2 cm)	
106"	92"	52"	23'5" (7.1 m)	7' 2" (2.19m)	4' 1" (1.23m)	19'5" (5.9 m)	5' 12" (1.82m)	3' 4" (1.02m)	9" (22.0 cm)	-5'1" (-154.0 cm)	
100"	87"	49"	22'11" (6.7 m)	6' 10" (2.07m)	3' 10" (1.16m)	18'4" (5.6 m)	5' 8" (1.73m)	3' 2" (0.97m)	8" (20.8 cm)	-4'9" (-145.3 cm)	
92"	80"	45"	20'3" (6.2 m)	6' 3" (1.92m)	3' 6" (1.08m)	16'10" (5.1 m)	5' 2" (1.58m)	2' 11" (0.89m)	8" (19.1 cm)	-4'5" (-133.7 cm)	
84"	73"	41"	18'6" (5.6 m)	5' 8" (1.73m)	3' 2" (0.97m)	15'5" (4.7 m)	4' 9" (1.45m)	2' 8" (0.82m)	7" (17.4 cm)	-4' (-122.0 cm)	
72"	63"	35"	15'10" (4.8 m)	4' 10" (1.48m)	2' 9" (0.83m)	13'2" (4.0 m)	4' 1" (1.24m)	2' 3" (0.69m)	6" (14.9 cm)	-3'5" (-104.6 cm)	
60"	52"	29"	13'2" (4.0 m)	4' 1" (1.24m)	2' 3" (0.69m)	10'11" (3.3 m)	3' 4" (1.02m)	1' 11" (0.57m)	5" (12.5 cm)	-2'10" (-87.2 cm)	
40"	35"	20"	8'9" (2.7 m)	2' 9" (0.83m)	1' 6" (0.47m)	7'3" (2.2 m)	2' 3" (0.68m)	1' 3" (0.38m)	3" (8.3 cm)	-1'11" (-58.1 cm)	

The formula for screen size and projection distance

$$y_1 (\text{Max.}) = (0.06764x - 0.038555) / 0.3048$$

$$y_2 (\text{Min.}) = (0.056295x - 0.038495) / 0.3048$$

$$z_1 (\text{Upper}) = 0.08171x \quad h : 0.309y$$

$$z_2 (\text{Lower}) = -0.57197x \quad v : 0.174y$$

x : Screen size (diag.) (inches)  
 y : Projection distance (feet)  
 z : Distance from the lens center to the lower edge of the screen (feet)

## NOTE

- There is an error of ±3% in the formula above.
- The values of horizontal and vertical values may be limited when Keystone correction is applied simultaneously in the horizontal and vertical directions. (See the diagram [fig. 1] above.)



## Adjusting the Projection Distance

### Upper and Lower Lens Shift Position

- This projector is equipped with a lens shift function that lets you adjust the projection height.
- Adjust it to match the setup configuration.
- The screen can be moved maximum the length of one screen vertically using the lens shift.

#### NOTE

- Optimal image quality is produced with the projector positioned perpendicular to the screen with all feet flat and level. Tilting or angling the projector will reduce the effectiveness of the lens shift function.

Screen size: 100 inches (254 cm)

Aspect ratio: 4:3

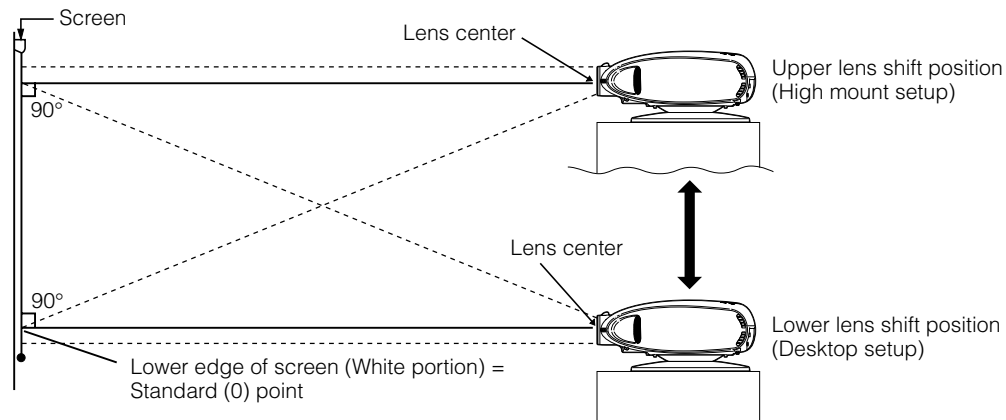

### Upper and Lower Lens Shift Position (Ceiling Mount)

When the projector is in the inverted position, use the upper edge of the screen as the base line, and exchange the lower and upper lens shift values.

Screen size: 100 inches (254 cm)

Aspect ratio: 4:3

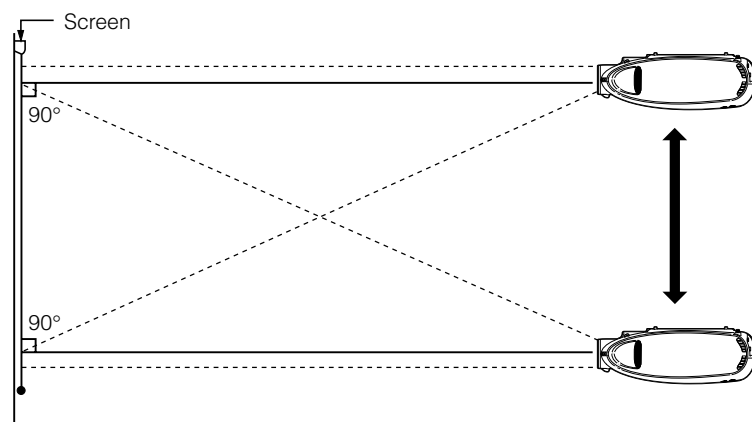



## Image Projection



## Rear Projection

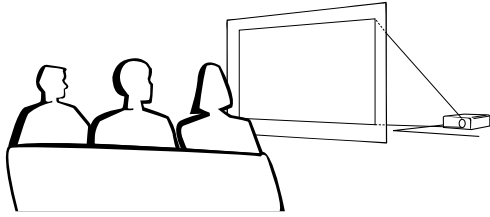

- Place a translucent screen between the projector and the audience.
- Use the projector's menu screen to reverse the projected image. (See page 42 for use of this function.)

### NOTE

- Optimal image quality can be achieved when the projector is positioned perpendicular to the screen with all feet flat and leveled.



## Projection Using a Mirror

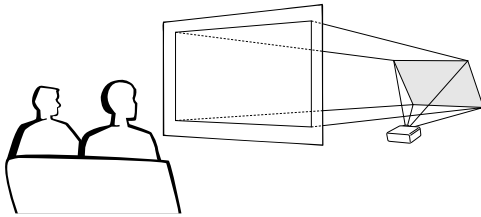

- When the distance between the projector and a screen is not sufficient for normal rear projection, you can use a mirror to reflect the image onto the screen.
- Place a mirror (normal flat type) in front of the lens.
- Project the normal image onto the mirror.
- The image reflected from the mirror is projected onto the translucent screen.

### CAUTION

- When using a mirror, be sure to carefully position both the projector and the mirror so the light does not shine into the eyes of the audience.



## Ceiling-mount Projection

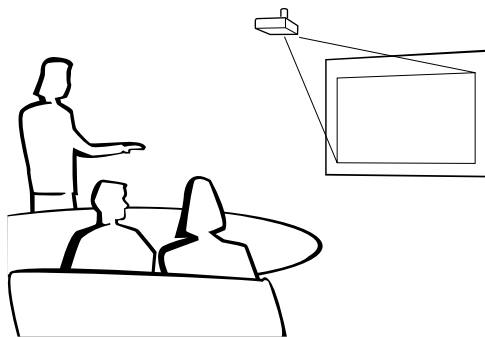

- It is recommended that you use the optional Sharp ceiling-mount bracket for this installation.
- Before mounting the projector, remove the Swivel Stand. (See page 17 for removing and attaching the Swivel Stand.)
- Before mounting the projector, contact your nearest Authorized SharpVision Service Center or Dealer to obtain the recommended ceiling-mount bracket (commercially available). (AN-CM260 ceiling-mount bracket, AN-EP101B extension tube for AN-CM260.)
- When the projector is in the inverted position, use the upper edge of the screen as the base line.
- Use the projector's menu screen to select the appropriate projection mode. (See page 42 for use of this function.)





# Using the Operation Buttons



## Selecting the Input Signal Source

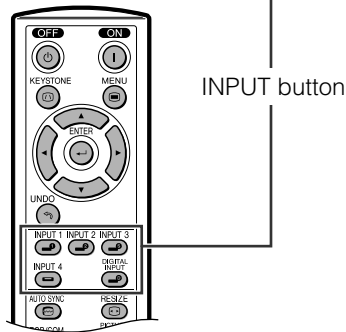
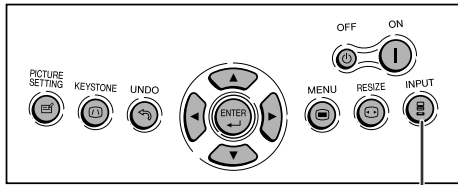

Press **INPUT** on the projector, **INPUT 1**, **INPUT 2**, **INPUT 3**, **INPUT 4** or **DIGITAL INPUT** on the remote control to select the desired input mode.

### NOTE

- When no signal is received, "NO SIGNAL" will be displayed.
- When a signal that the projector is not preset to receive is received, "NOT REG." will be displayed.

### On-screen Display

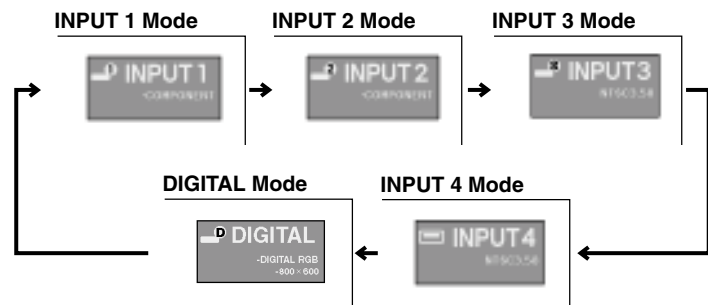

## Adjusting the Picture Aspect Ratio

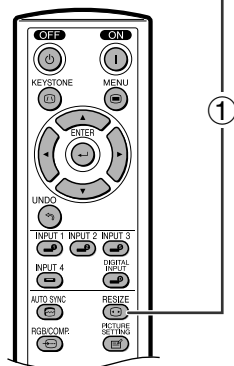
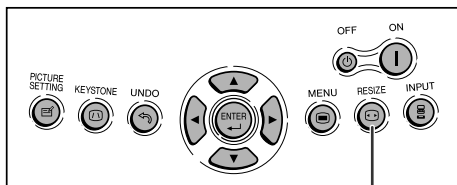

This function allows you to modify or customize the picture display mode to enhance the input image. Depending on the input signal, you can choose NORMAL, BORDER or STRETCH image.

- 1 Press **RESIZE**. Each time **RESIZE** is pressed, the picture mode changes as shown on the next page.





## Adjusting the Picture Aspect Ratio

Input Signal			Output screen image		
DVD / VIDEO	COMPUTER	Image Type	NORMAL Projects the image fully on a screen while maintaining the aspect ratio.	BORDER Projects the image on the screen whose surrounding areas are cut out to make a 4:3 screen while maintaining the aspect ratio.	STRETCH Projects the image on the screen whose upper and lower areas are cut out to make a 16:9 screen while the image is horizontally enlarged.
480i 480P 540P NTSC PAL SECAM	VGA (640x480) SVGA (800x600) XGA (1024x768)	 4:3 aspect ratio	*	 *	 *
		 Letter Box	*	 *	 *
		 Squeezed 16:9  Squeezed 4:3 image		  *	  *
720P 1080i	—	 16 : 9 aspect ratio  *			 *  *

\* Mode for projecting an image with the original aspect ratio without cutting any portions.

: Cutout area on which images cannot be projected.

: Area on which the image is not included in the original signals.





# Using the Menu Screen



## Basic Operations

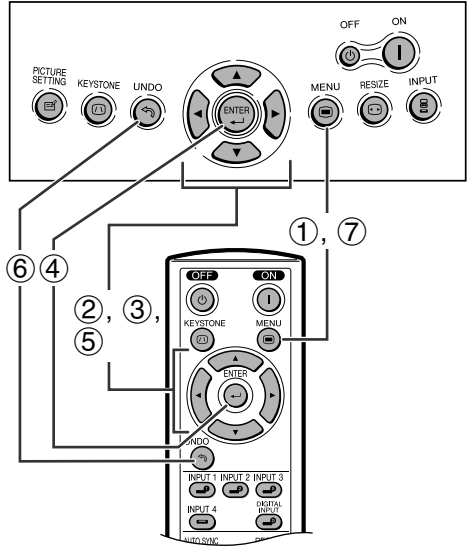

This projector has two sets of menu screens that allow you to adjust the image and various projector settings. These menu screens can be operated from the projector or the remote control with the following procedure.

### On-screen Display

**INPUT 1 (COMPONENT), 2 (COMPONENT or analog RGB) or DIGITAL INPUT (digital RGB) mode**

**INPUT 3 or 4 (VIDEO) mode**

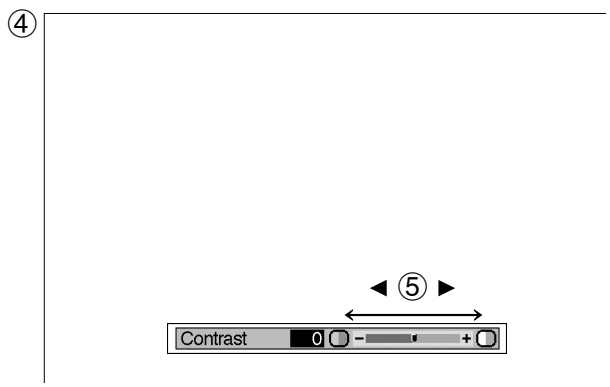
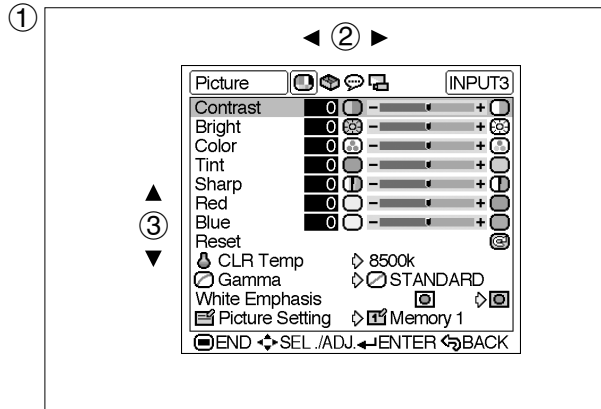
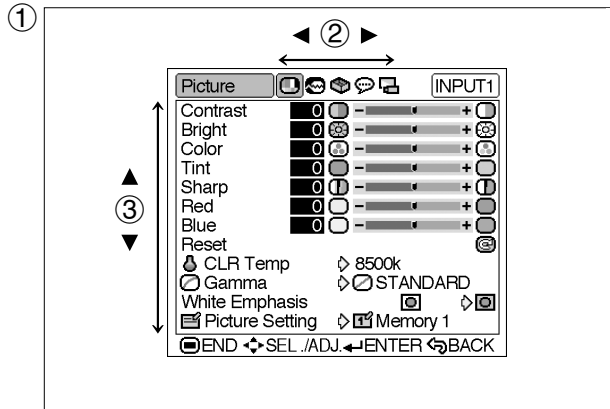

- ① Press **MENU**. The "Picture" menu screen for the selected INPUT mode appears.
- ② Press ◀/▶ to display the other menu screen, if you want. The icon for the selected menu screen will be highlighted.
- ③ Press ▲/▼ to select a specific adjustment item.
- ④ Press **ENTER** after selecting the item if you want to display a single adjustment item. Only the selected adjustment item will appear.
- ⑤ Press ◀/▶ to adjust the item.
- ⑥ Press **UNDO** to return to the previous screen.
- ⑦ To exit the menu screen, press **MENU**.

### NOTE

- For details on items on the menu screen, see the tree charts on pages 27 and 28.

Basic Operation

# Menu Bars

## Items on the INPUT 1 or 2 Mode Menu Bar

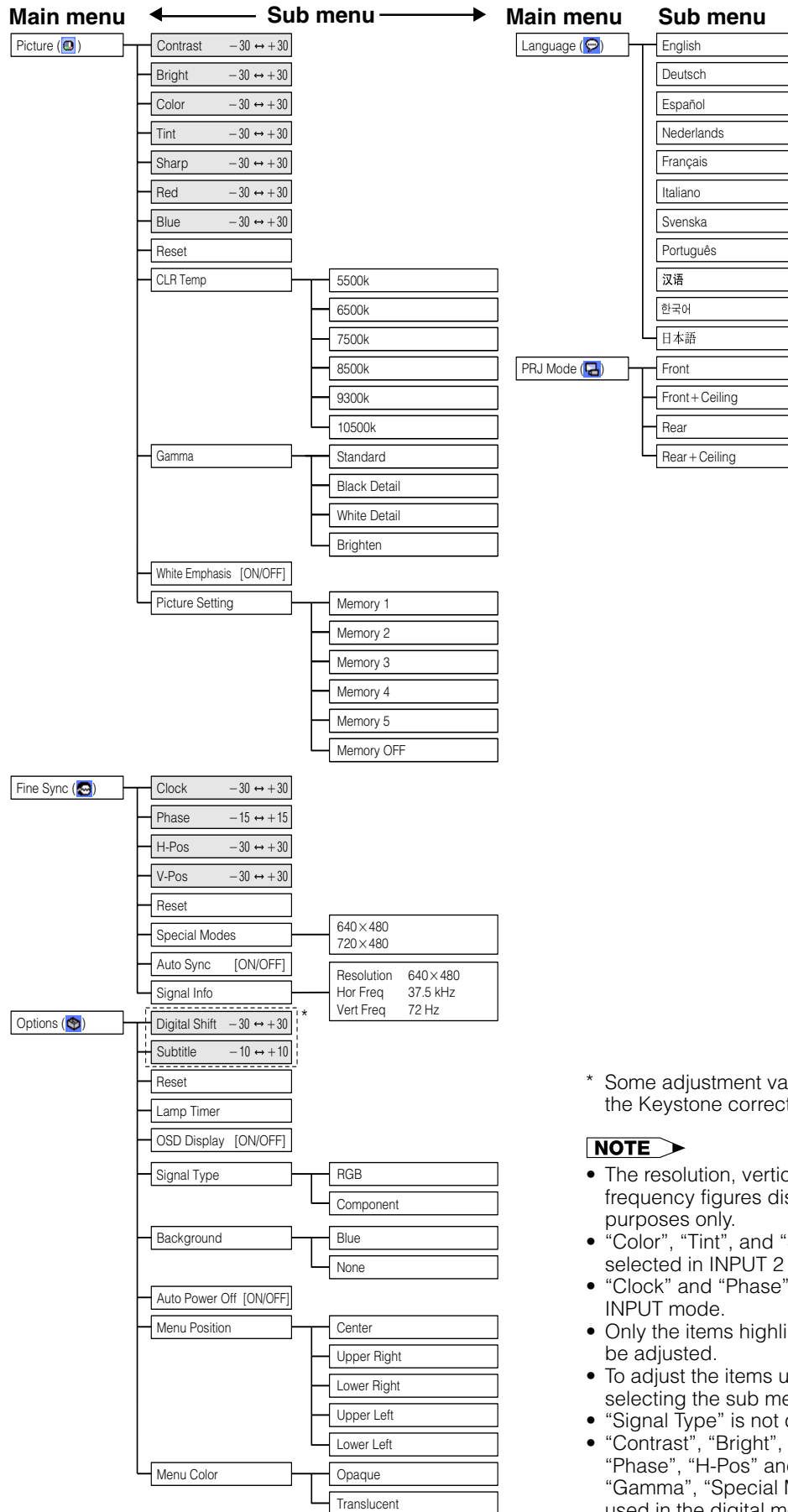

\* Some adjustment values may be limited depending on the Keystone correction value.

### NOTE

- The resolution, vertical frequency and horizontal frequency figures displayed above are for example purposes only.
- “Color”, “Tint”, and “Sharp” do not appear when “RGB” is selected in INPUT 2 mode.
- “Clock” and “Phase” cannot be adjusted in the DIGITAL INPUT mode.
- Only the items highlighted in the tree charts above can be adjusted.
- To adjust the items under the sub menu, press ► after selecting the sub menu.
- “Signal Type” is not displayed when using INPUT 1.
- “Contrast”, “Bright”, “Color”, “Tint” and “Sharp”, “Clock”, “Phase”, “H-Pos” and “V-Pos”, and “CLR-Temp”, “Gamma”, “Special Modes” and “Auto Sync” cannot be used in the digital mode.



# Menu Bars

## Items on the INPUT 3 or 4 Mode Menu Bar

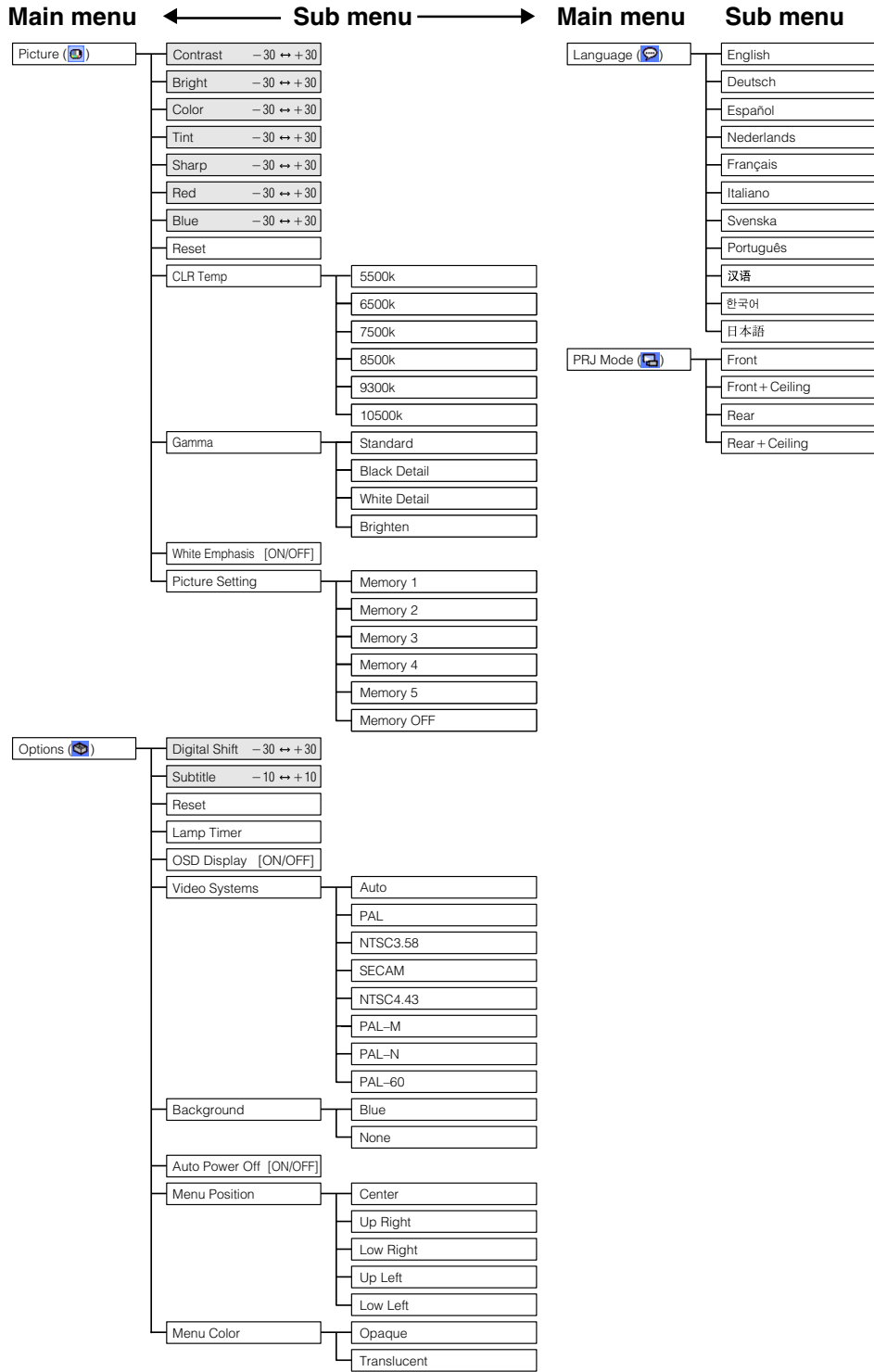

### NOTE

- Only the items highlighted in the tree charts above can be adjusted.
- To adjust the items under the sub menu, press ► after selecting the sub menu.
- "Tint" cannot be used with PAL, SECAM, PAL-M, PAL-N or PAL-60.





# Adjusting the Picture

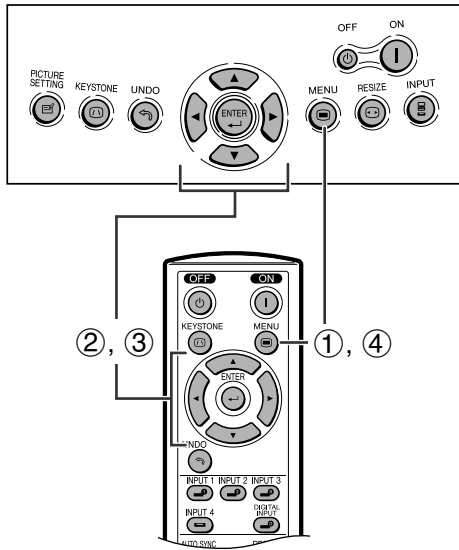

**On-screen Display**  
e. g. (VIDEO input in INPUT 3 or 4 mode)

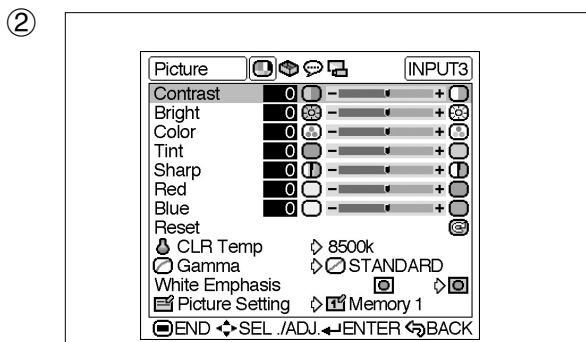
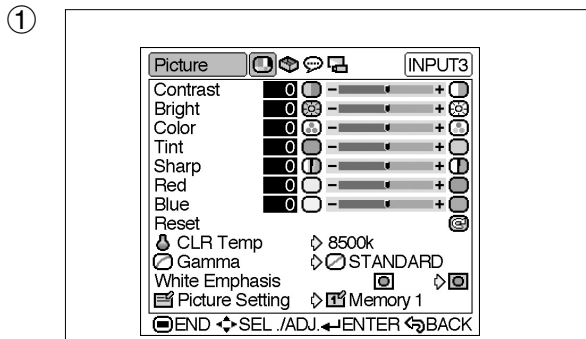

You can adjust the projector's picture to your preferences with the following picture settings. To save the settings, select a memory from 1 to 5 and OFF (see page 32) and then adjust the settings.

## Description of Adjustment Items

Selected item	◀ button	▶ button
<b>Contrast</b>	For less contrast	For more contrast
<b>Brightness</b>	For less brightness	For more brightness
<b>Color</b>	For less color intensity	For more color intensity
<b>Tint</b>	Skin tones become purplish	Skin tones become greenish
<b>Sharp</b>	For less sharpness	For more sharpness
<b>Red</b>	For weaker red	For stronger red
<b>Blue</b>	For weaker blue	For stronger blue
<b>CLR Temp</b>	For selecting a desired item from six color temperature settings	
<b>Gamma</b>	For selecting a desired item from four gamma positions	
<b>White Emphasis</b>	For switching "on" or "off" the function that emphasizes bright portions of the image	
<b>Picture Setting</b>	For storing all items set in "Picture"	
<b>Reset</b>	All image adjustment items are returned to the factory preset settings.	

### NOTE

- "Color", "Tint" and "Sharp" do not appear for RGB input in INPUT 2 mode.
- For details on "Gamma", see "Gamma Correction Function" on page 31.
- For details on "CLR Temp", see "Adjusting the Color Temperature" on page 30.
- For details on "White Emphasis", see "Description of White Emphasis" on page 30.
- For details on "Picture Setting", see "Picture Setting Function" on page 32.

- ① Press **MENU**. The "Picture" menu screen appears.
- ② Press ▲/▼ to select a specific adjustment item.
- ③ Press ◀/▶ to move the ▣ mark of the selected adjustment item to the desired setting.
- ④ To exit the menu screen, press **MENU**.

### NOTE

- To reset all adjustment items, select "Reset" on the "Picture" menu screen and press **ENTER**.
- "Tint" cannot be used with PAL, SECAM, PAL-M, PAL-N or PAL-60.
- "Contrast", "Bright", "Color", "Tint" and "Sharp" cannot be used in the digital mode.



## Adjusting the Picture

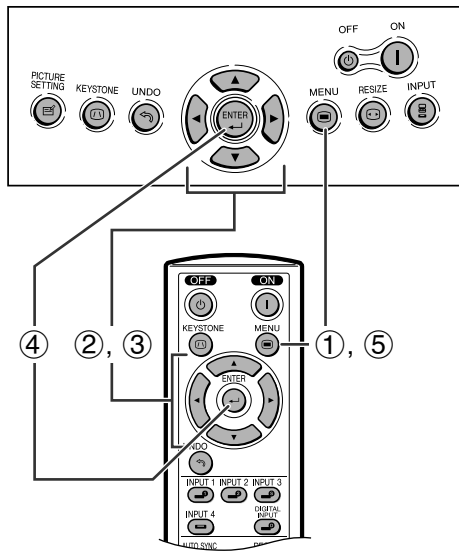

### On-screen Display

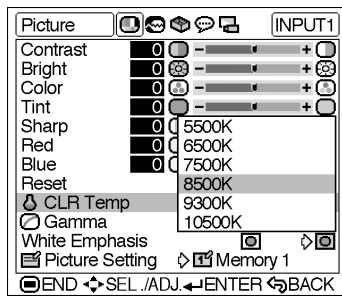

## Adjusting the Color Temperature

This function allows for selecting the desired color temperature from six settings. With the lower value selected, the projected image becomes warmer, reddish and incandescent-like while with the higher value, the image becomes cooler, bluish and fluorescent-like.

### Description of Color Temperature

- 1 Press **MENU**. The "Picture" menu screen appears.
- 2 Press **▲/▼** to select "CLR Temp", and then press **▶**.
- 3 Press **▲/▼** to select the desired color temperature setting.
- 4 Press **ENTER** to save the setting.
- 5 To exit the menu screen, press **MENU**.

### NOTE

- Values on "CLR Temp" are only for general standard purposes. The less the value is set to, the warmer, reddish, incandescent-like the image becomes. The more the value is set to, the cooler, bluish, fluorescent-like the image becomes.
- "CLR-Temp" cannot be used in the digital mode.

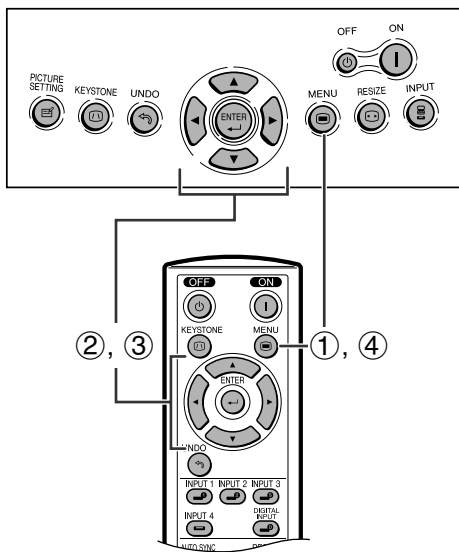

### On-screen Display

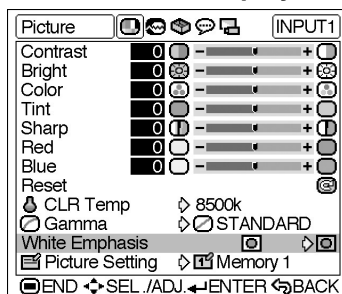

## Emphasizing the Contrast

This function emphasizes the bright portions of images to obtain a higher contrast image.

### Description of White Emphasis

Selected item	Description
<b>ON</b>	For emphasizing the bright portions of images
<b>OFF</b>	For disabling "White Emphasis"

- 1 Press **MENU**. The "Picture" menu screen appears.
- 2 Press **▲/▼** to select "White Emphasis".
- 3 Press **◀/▶** to select the desired white emphasis setting.
- 4 To exit the menu screen, press **MENU**.





## Adjusting the Picture

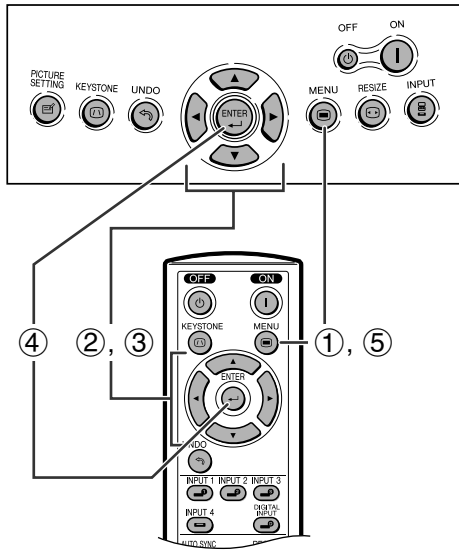

### On-screen Display

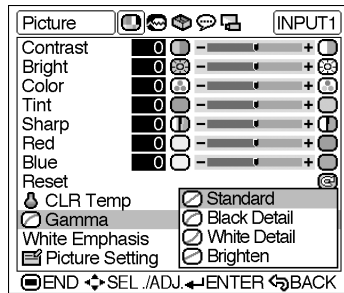

## Gamma Correction Function

Gamma is an image quality enhancement function. Four gamma settings are available to allow for differences in the brightness of the room.

### Description of Gamma Modes

Selected Mode	Description
<b>Standard</b>	Standard picture without gamma correction
<b>Black Detail</b>	Gives greater depth to darker portions of images for a more exciting theater experience.
<b>White Detail</b>	Emphasizes the gradation of the intermediate to high brightness portions of the image for more detailed expression.
<b>Brighten</b>	Brighten the darker portions of images for easier viewing in a dimly lit room.

- ① Press **MENU**. The "Picture" menu screen appears.
- ② Press **▲/▼** to select "Gamma", and then press **▶**.
- ③ Press **▲/▼** to select the desired gamma mode.
- ④ Press **ENTER** to save the setting.
- ⑤ To exit the menu screen, press **MENU**.

### NOTE

- Gamma cannot be used in the digital mode.

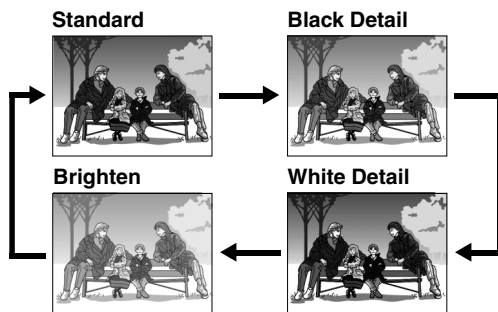





## Adjusting the Picture

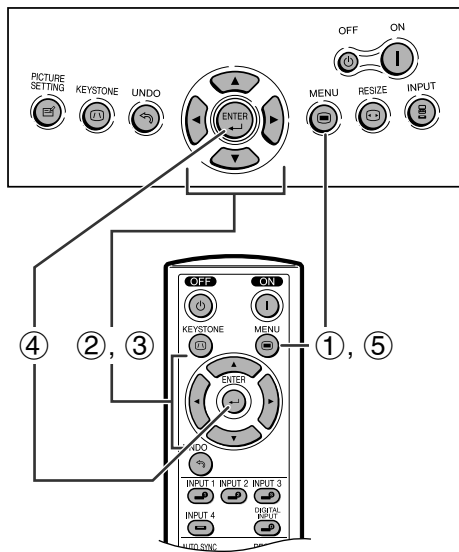
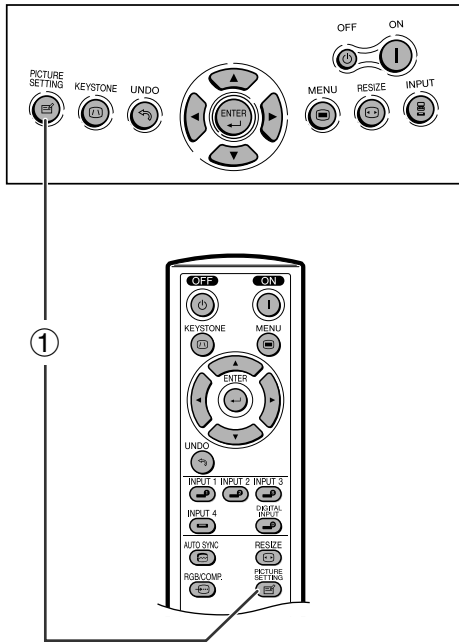

### On-screen Display

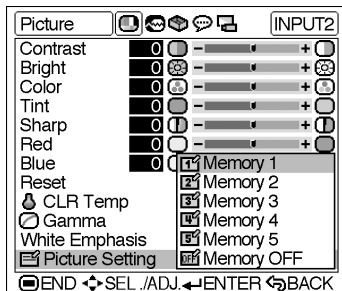

## Picture Setting Function

This function stores all items set in "Picture". Five settings can be stored separately in "Memory 1" to "Memory 5". Each stored setting is reassigned to each input mode (INPUT 1 to INPUT 4 and DIGITAL). Even when the input mode or signal is changed, you can easily select optimal settings from the stored settings.

### NOTE

- This function can be operated using the **PICTURE SETTING** button on the projector or on the remote control, as well as the OSD menu screen.

### Description of Picture Setting

Selected item	Description
<b>Memory 1-5</b>	Settings of all items in "Picture" can be stored for the respective input modes. The stored settings can be selected in any input modes.
<b>Memory OFF</b>	Besides "Memory 1" to "Memory 5", other settings can be stored for each input mode. "Memory OFF" can be selected for each input mode.

## Selecting "Memory 1-5" or "Memory OFF" Using the PICTURE SETTING Button

- Press **PICTURE SETTING**. Each time **PICTURE SETTING** is pressed, the memory number changes as shown below.

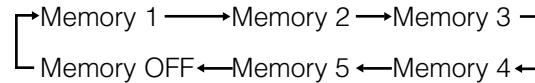

## Storing the Adjustment Values for each Memory Number

- Press **MENU**. The "Picture" menu screen appears.
- Press **▲/▼** to select "Picture Setting", and then press **▶**.
- Press **▲/▼** to select the desired memory number for the picture settings.
- Press **ENTER** to save the settings. Adjust the settings described on pages 29 to 31. The values that are adjusted are stored.
- To exit the menu screen, press **MENU**.





# Adjusting the Computer and DVD/DTV Images

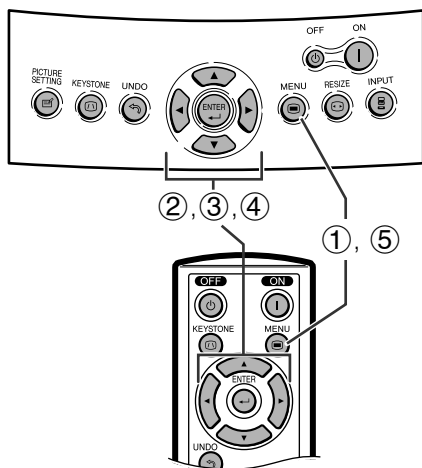

## On-screen Display

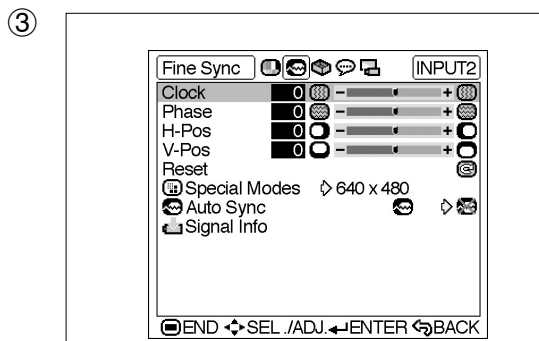
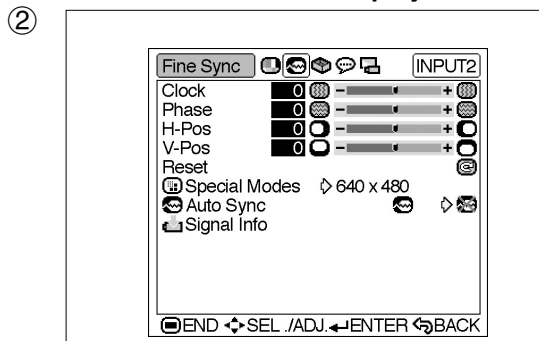

When displaying computer patterns which are very detailed (tiling, vertical stripes, etc.), interference may occur between the DMD pixels, causing flickering, vertical stripes, or contrast irregularities in portions of the screen. Should this occur, adjust "Clock", "Phase", "H-Pos" and "V-Pos" for the optimum computer image.

### Description of Adjustment Items

Selected item	Description
<b>Clock</b>	Adjusts vertical noise.
<b>Phase</b>	Adjusts horizontal noise (similar to tracking on your VCR).
<b>H-Pos</b>	Centers the on-screen image by moving it to the left or right.
<b>V-Pos</b>	Centers the on-screen image by moving it up or down.
<b>Reset</b>	All computer image adjustment items are returned to the factory preset settings.

### NOTE

- "Clock", "Phase", "H-Pos" and "V-Pos" cannot be used in the digital mode.
- Computer image adjustments can be made easily by pressing **AUTO SYNC** (📺) on the remote control. See page 35 for details.

- 1 Press **MENU**. The "Picture" menu screen appears.
- 2 Press **◀/▶** to display the "Fine Sync" menu screen.
- 3 Press **▲/▼** to select a specific adjustment item.
- 4 Press **◀/▶** to move the **█** mark of the selected adjustment item to the desired setting.
- 5 To exit the menu screen, press **MENU**.

### NOTE

- To reset all adjustment items, select "Reset" on the "Fine Sync" menu screen and press **ENTER**.
- The adjustable area of each item may be changed according to the input signal.
- "Clock" and "Phase" can be adjusted in the Component mode.



## Adjusting the Computer and DVD/DTV Images

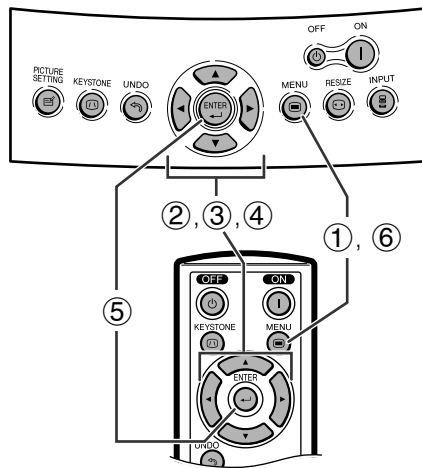

### On-screen Display

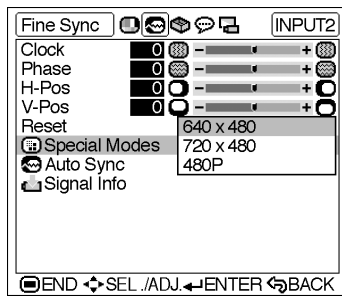

## Special Modes Adjustment

Ordinarily, the type of input signal is detected and the correct resolution mode is automatically selected. However, for some signals, the optimal resolution mode in "Special Modes" on the "Fine Sync" menu screen may need to be selected to match the computer display mode.

- ① Press **MENU**. The "Picture" menu screen appears.
- ② Press ◀/▶ to display the "Fine Sync" menu screen.
- ③ Press ▲/▼ to select "Special Modes", and then press ▶.
- ④ Press ▲/▼ to select the optimal resolution.
- ⑤ Press **ENTER** to save the setting.
- ⑥ To exit the menu screen, press **MENU**.

### NOTE

- Avoid displaying computer patterns which repeat every other line (horizontal stripes). (Flickering may occur, making the image hard to see.)
- When inputting DTV 1080i signal, select the corresponding type of signal in step 4 above.
- When inputting 720P RGB signal, select the corresponding type of signal in step 4 above.
- "Special modes" cannot be used in the digital mode.

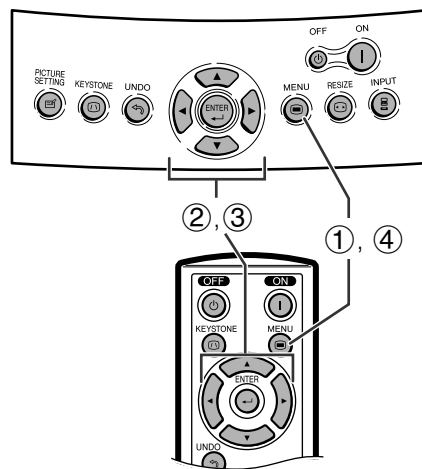

### On-screen Display

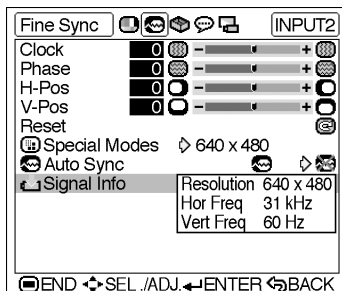

## Checking the Input Signal

This function allows you to check the current input signal information.

- ① Press **MENU**. The "Picture" menu screen appears.
- ② Press ◀/▶ to display the "Fine Sync" menu screen.
- ③ Press ▲/▼ to select "Signal Info" to display the current input signal.
- ④ To exit the menu screen, press **MENU**.





## Adjusting the Computer and DVD/DTV Images

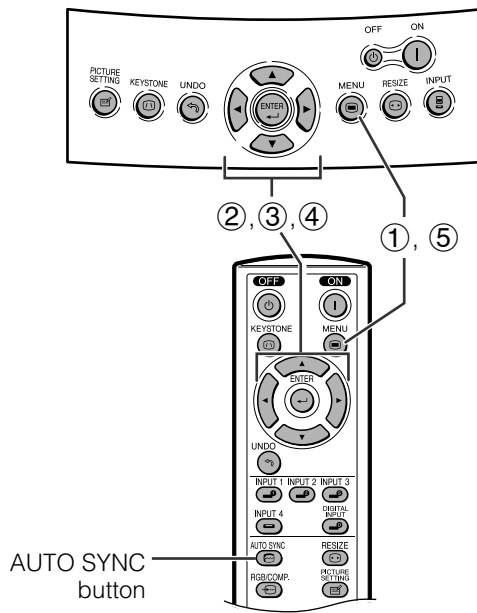

AUTO SYNC button

### On-screen Display

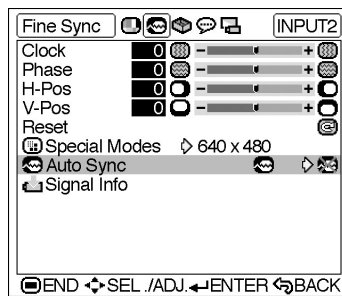

## Auto Sync Adjustment

- Used to automatically adjust a computer image.
- Select whether the image is to be synchronized automatically when switching the signal with "ON" or "OFF".

### OFF (OFF)

- Synchronized adjustment is not automatically performed.
- Press **AUTO SYNC** to perform manual adjustment.

### ON (ON)

- Synchronized adjustment is automatically performed.

- ① Press **MENU**. The "Picture" menu screen appears.
- ② Press **◀/▶** to display the "Fine Sync" menu screen.
- ③ Press **▲/▼** to select "Auto Sync".
- ④ Press **◀/▶** to select "ON" or "OFF".
- ⑤ To exit the menu screen, press **MENU**.

### NOTE

- When the optimum image cannot be achieved with Auto Sync adjustment, use manual adjustments. (See page 33.)
- The Auto Sync adjustment may take some time to complete, depending on the image of the computer connected to the projector.
- "Auto Sync" cannot be used in the digital mode.

## Auto Sync Adjustment Using the Remote Control

- ① Press **AUTO SYNC** button on the Remote Control. Synchronized adjustment starts.

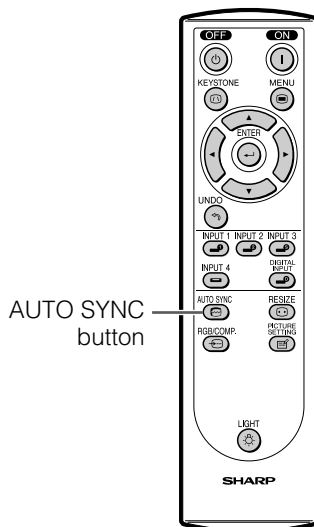

AUTO SYNC button

## Turning On/Off the On-screen Display

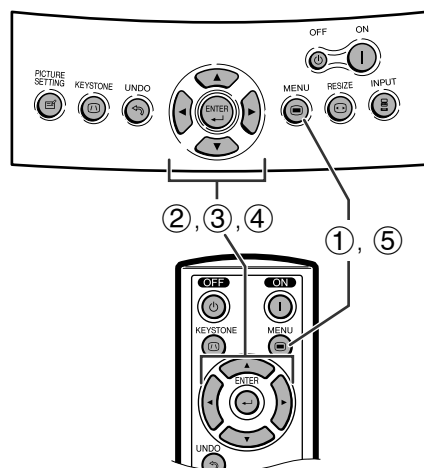

### On-screen Display

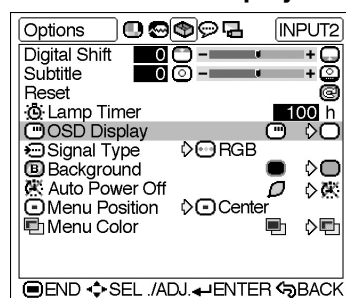

This function allows you to turn on or off the on-screen messages that appear during input select.

### Description of OSD Display

Selected item	Description
ON (☑)	All On-screen Display are displayed.
OFF (☐)	INPUT is not displayed.

- 1 Press **MENU**. The "Picture" menu screen appears.
- 2 Press ◀/▶ to display the "Options" menu screen.
- 3 Press ▲/▼ to select "OSD Display".
- 4 Press ◀/▶ to select "ON" (☑) or "OFF" (☐).
- 5 To exit the menu screen, press **MENU**.

## Selecting the Signal Type

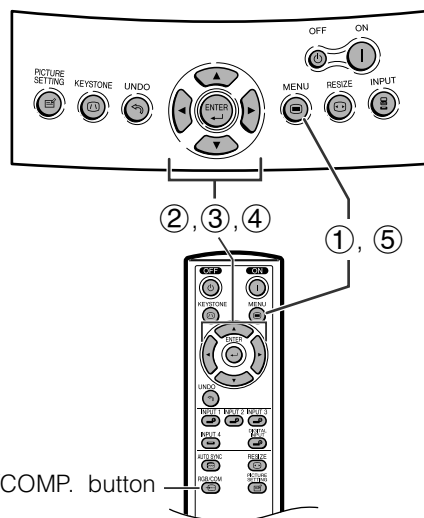

### On-screen Display

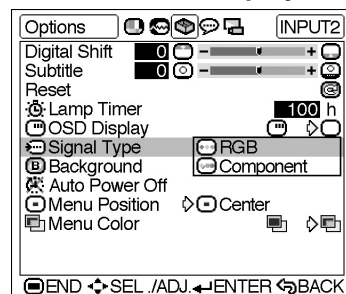

This function allows you to select the input signal type Component or RGB for INPUT 2.

- 1 Press **MENU**. The "Picture" menu screen appears.
- 2 Press ◀/▶ to display the "Options" menu screen.
- 3 Press ▲/▼ to select "Signal Type", and then press ▶.
- 4 Press ▲/▼ to select "RGB" or "Component".
- 5 To exit the menu screen, press **MENU**.

"RGB" or "Component" can be selected with the **RGB/COMP.** button on the remote control only in INPUT 2.



## Setting the Video Signal (VIDEO menu only)

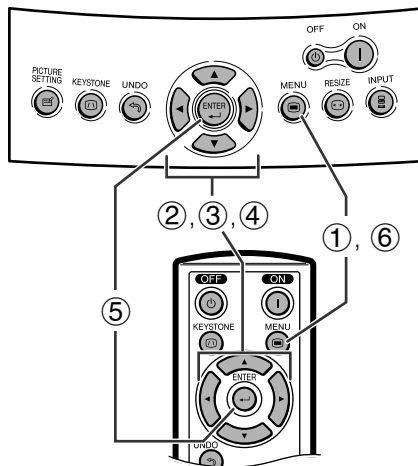

### On-screen Display

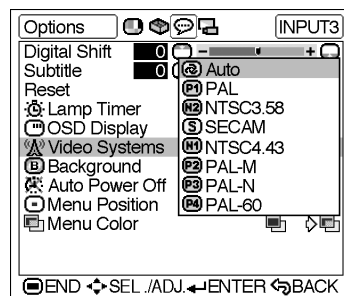

The video input system mode is preset to “Auto”; however, it can be changed to a specific system mode if the selected system mode is not compatible with the connected audiovisual equipment.

- 1 Press **MENU**. The “Picture” menu screen appears.
- 2 Press ◀/▶ to display the “Options” menu screen.
- 3 Press ▲/▼ to select “Video Systems”, and then press ▶.
- 4 Press ▲/▼ to select the desired video system mode.
- 5 Press **ENTER** to save the setting.
- 6 To exit the menu screen, press **MENU**.

### NOTE

- When the system mode is set to “Auto”, you may not receive a clear picture due to signal differences. Should this occur, switch to the video system of the source signal.
- AUTO cannot be set for PAL-M and PAL-N input signals. Select “PAL-M” or “PAL-N” in “Video Systems” menu for PAL-M and PAL-N input signals.



## Selecting a Background Image

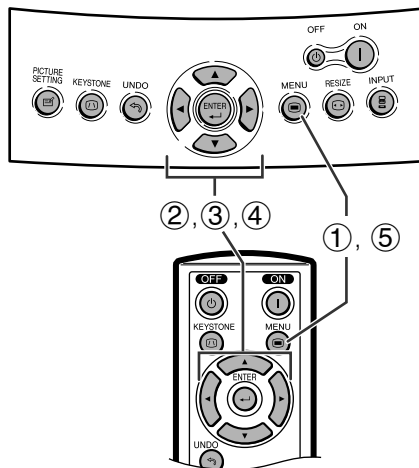

### On-screen Display

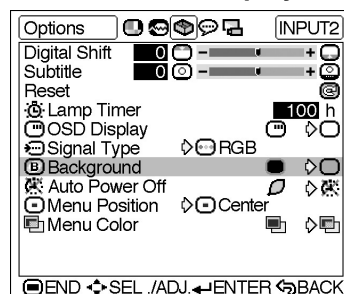

This function allows you to select the image displayed when no signal is being sent to the projector.

### Description of Background Images

Selected item	Description
Blue (□)	Blue screen
None (■)	Black screen

- 1 Press **MENU**. The “Picture” menu screen appears.
- 2 Press ◀/▶ to display the “Options” menu screen.
- 3 Press ▲/▼ to select “Background”.
- 4 Press ◀/▶ to select the background image you want to display on the screen.
- 5 To exit the menu screen, press **MENU**.



# Adjustments for the Screen Position and Size

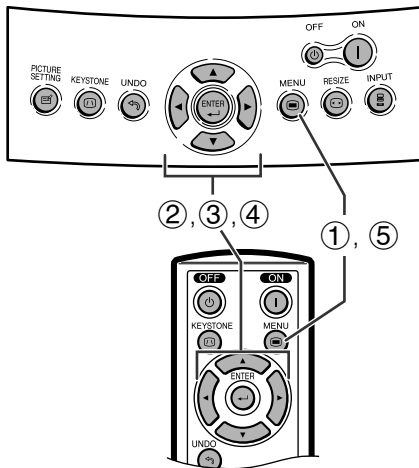

## On-screen Display

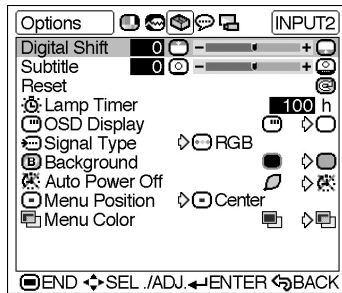

You can adjust settings according to the position and size of the screen.

### Description of Adjustment Items

Selected item	Description
Digital Shift	Adjusts the vertical position of the image.
Subtitle	Adjusts the vertical size of the image.
Reset	Digital Shift and Subtitle adjustments are returned to the factory preset settings.

### Digital Shift Setting

This function allows you to adjust the vertical position of the image.

### Description of Digital Shift

- [button] +	
The image moves up.	The image moves down.

- 1 Press **MENU**. The "Picture" menu screen appears.
- 2 Press **◀/▶** to display the "Options" menu screen.
- 3 Press **▲/▼** to select "Digital Shift".
- 4 Press **◀/▶** to move the **▣** mark of the Digital Shift setting.
- 5 To exit the menu screen, press **MENU**.

### NOTE

- The value that can be set may be limited depending on the adjustment value of Keystone correction.





## Adjustments for the Screen Position and Size

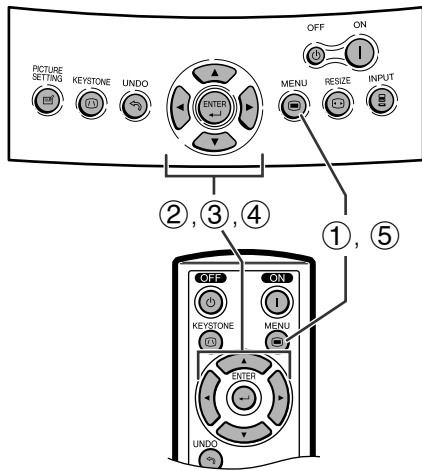

### On-screen Display

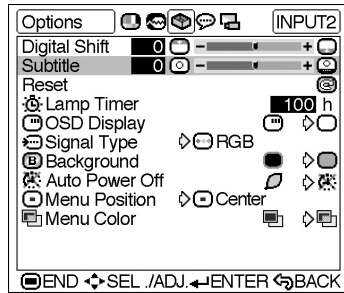

## Subtitle Setting

With this function, you can adjust the vertical size of the display to allow for subtitles.

### Description of Subtitle Setting

- button      + button	
The image is compressed by adjusting the vertical size of the display.	The image is enlarged by adjusting the vertical size of the display.

- ① Press **MENU**. The "Picture" menu screen appears.
- ② Press ◀/▶ to display the "Options" menu screen.
- ③ Press ▲/▼ to select "Subtitle".
- ④ Press ◀/▶ to move the ▾ mark of the Subtitle setting.
- ⑤ To exit the menu screen, press **MENU**.

### NOTE

- When changing the screen with the Subtitle setting, not only the bottom of the screen rises, but also the upper part is changed to a certain point.
- The subtitle setting can be adjusted more effectively with the Digital Shift function.
- The value that can be set may be limited depending on the adjustment value of Keystone correction.





## Selecting the Menu Screen Position

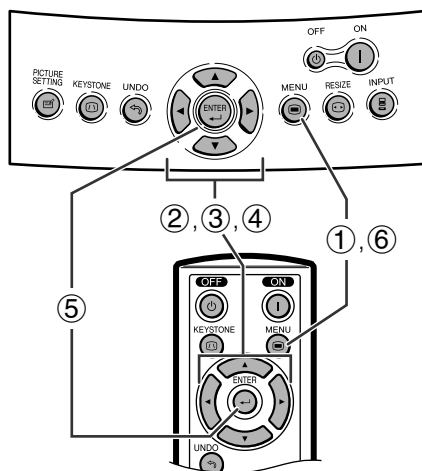

### On-screen Display

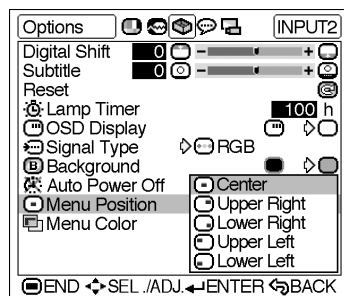

This function allows you to select the desired position of the menu screen.

### Description of Menu Position

Selected item	Description
<b>Center</b>	The menu is displayed on the center of the image.
<b>Upper Right</b>	The menu is displayed on the upper right of the image.
<b>Lower Right</b>	The menu is displayed on the lower right of the image.
<b>Upper Left</b>	The menu is displayed on the upper left of the image.
<b>Lower Left</b>	The menu is displayed on the lower left of the image.

- 1 Press **MENU**. The "Picture" menu screen appears.
- 2 Press **◀/▶** to display the "Options" menu screen.
- 3 Press **▲/▼** to select "Menu Position", and then press **▶**.
- 4 Press **▲/▼** to select the desired menu position.
- 5 Press **ENTER** to save the setting.
- 6 To exit the menu screen, press **MENU**.



## Selecting the Menu Color

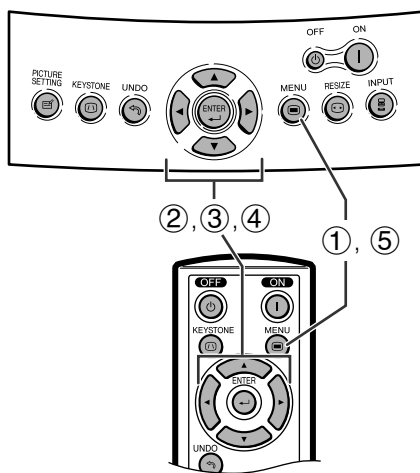

### On-screen Display

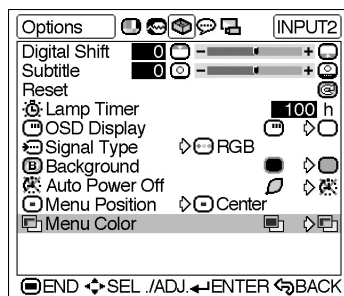

This function allows you to select the color of the menu screen.

### Description of Menu color

Selected item	Description
<b>Opaque</b>	The menu is displayed opaquely.
<b>Translucent</b>	The menu is displayed translucently. The part of the menu on the image becomes transparent.

- 1 Press **MENU**. The "Picture" menu screen appears.
- 2 Press **◀/▶** to display the "Options" menu screen.
- 3 Press **▲/▼** to select "Menu Color".
- 4 Press **◀/▶** to select "Opaque" () or "Translucent" ()
- 5 To exit the menu screen, press **MENU**.





# Automatic Power Shut-off Function

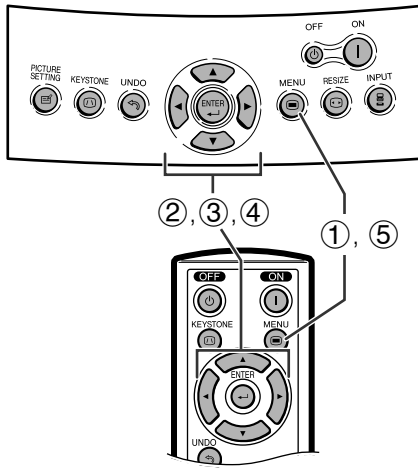

When no input signal is detected for more than 15 minutes, the projector will automatically shut off. The on-screen message on the left will appear five minutes before the power is automatically turned off.

## Description of Automatic Power Shut-off

Selected item	Description
	Power automatically shuts off after 15 minutes without an input signal.
	Automatic Power Shut-off disabled.

- ① Press **MENU**. The "Picture" menu screen appears.
- ② Press ◀/▶ to display the "Options" menu screen.
- ③ Press ▲/▼ to select "Auto Power Off".
- ④ Press ◀/▶ to select or .
- ⑤ To exit the menu screen, press **MENU**.



### NOTE

- "Auto Power Off" is factory preset to .
- When the Auto Power Off function is set to (On), 5 minutes before the power turns off, the message "Power OFF in X min." will appear on the screen to indicate the remaining minutes.

## On-screen Display

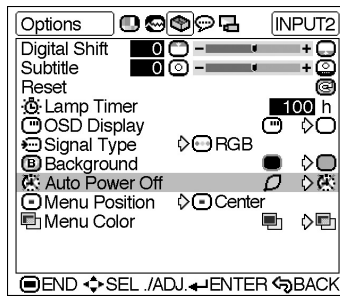



## Reversing/Inverting Projected Images

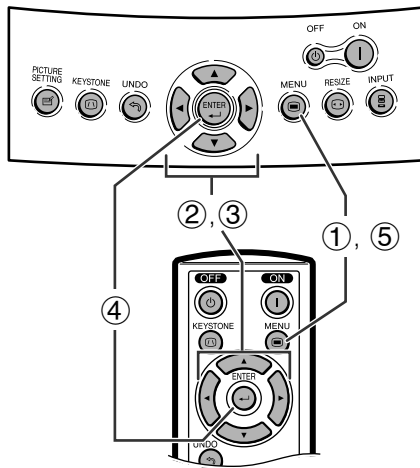

### On-screen Display

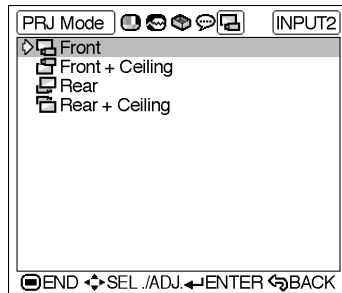

This projector is equipped with a reverse/invert image function which allows you to reverse or invert the projected image for various applications.

### Description of Projected Images

Selected item	Description
Front	Normal image
Front + Ceiling	Inverted image
Rear	Reversed image
Rear + Ceiling	Reversed and inverted image

- ① Press **MENU**. The "Picture" menu screen appears.
- ② Press ◀/▶ to display the "PRJ Mode" menu screen.
- ③ Press ▲/▼ to select the desired projection mode.
- ④ Press **ENTER** to save the setting.
- ⑤ To exit the menu screen, press **MENU**.

### NOTE

- This function is used for the reversed image and ceiling-mount setups. See page 23 for these setups.



## Selecting the On-screen Display Language

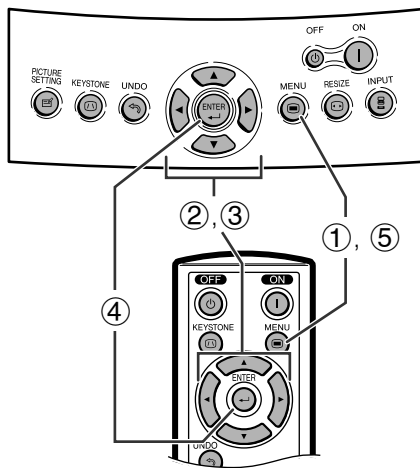

### On-screen Display



English is the preset language for the On-screen Display; however, this can be changed to German, Spanish, Dutch, French, Italian, Swedish, Portuguese, Chinese, Korean or Japanese.

- ① Press **MENU**. The "Picture" menu screen appears.
- ② Press ◀/▶ to display the "Language" menu screen.
- ③ Press ▲/▼ to select the desired language.
- ④ Press **ENTER** to save the setting. The On-screen Display is now programmed to display in the language selected.
- ⑤ To exit the menu screen, press **MENU**.





# Advanced Picture Adjustment

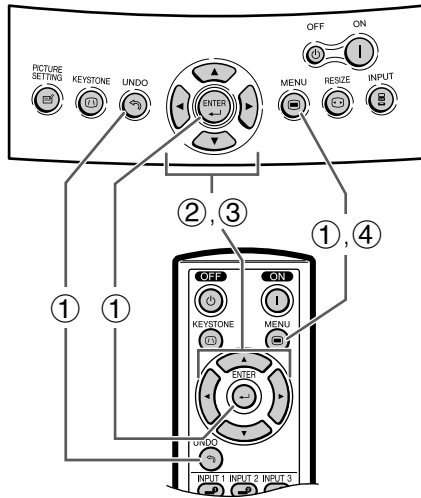

Detailed picture adjustments can be made in addition to the adjustments on the normal menu screen.

Selected	◀ button	▶ button
<b>R-Contrast</b>	For less contrast of red component	For more contrast of red component
<b>G-Contrast</b>	For less contrast of green component	For more contrast of green component
<b>B-Contrast</b>	For less contrast of blue component	For more contrast of blue component
<b>R-Brightness</b>	For less brightness of red component	For more brightness of red component
<b>G-Brightness</b>	For less brightness of green component	For more brightness of green component
<b>B-Brightness</b>	For less brightness of blue component	For more brightness of blue component
<b>Reset</b>	All image adjustment items are returned to the factory preset settings.	

## On-screen Display

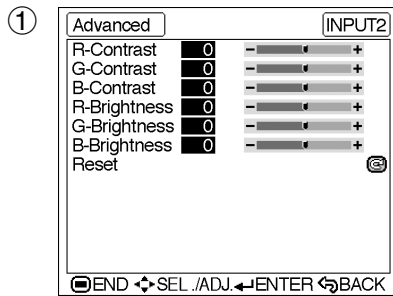

- ① The "Advanced" menu appears when the buttons are pressed in the order shown below.



- ② Press ▲/▼ to select a specific adjustment item.
- ③ Press ◀/▶ to move the ▣ mark of the selected adjustment item to the desired setting.
- ④ To exit the menu screen, press **MENU**.

### NOTE

- To reset all adjustment items, "Reset" in the "Picture" menu screen and press **ENTER**.
- Advanced adjustment values are stored in all modes.

## On-screen Display

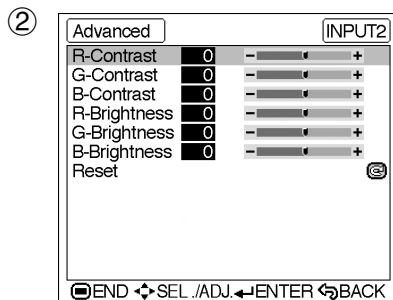



# Lamp/Maintenance Indicators

## Maintenance Indicators

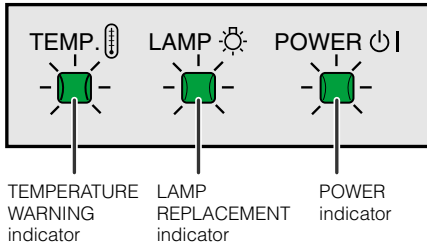

- The warning lights on the projector indicate problems inside the projector.
- There are two types of warning lights: a TEMPERATURE WARNING indicator that warns you when the projector is too hot, and a LAMP REPLACEMENT indicator that warns you when to change the lamp.
- If a problem occurs, either the TEMPERATURE WARNING indicator or the LAMP REPLACEMENT indicator will illuminate in red. After turning off the power, follow the procedures given below.

Maintenance Indicator	Condition	Problem	Possible Solution
TEMPERATURE WARNING indicator	The internal temperature is abnormally high.	• Blocked air intake.	• Relocate the projector to an area with proper ventilation.
		• Clogged ventilative hole.	• Clean the ventilative holes. (See page 49.)
		• Cooling fan breakdown. • Internal circuit failure.	• Take the projector to your nearest Authorized SharpVision Service Center or Dealer for repair.
LAMP REPLACEMENT indicator	The lamp does not light up.	• Burnt-out lamp. • Lamp circuit failure.	• Carefully replace the lamp. (See page 46.) • Take the projector to your nearest Authorized SharpVision Service Center or Dealer for repair.
	The lamp requires replacement.	• Lamp has been used for over 2,400 hours.	

### NOTE

- If the TEMPERATURE WARNING indicator lights up, follow the above possible solutions and then wait until the projector has cooled down completely before turning the power back on. (At least 5 minutes.)
- If the power is turned off and then turned on again, for example during a brief rest, the LAMP REPLACEMENT indicator may be triggered, preventing the power from going on. Should this occur, unplug the power cord from the wall outlet and plug it back in again.





# Lamp Maintenance



## Confirming the Lamp Usage Time

The lamp in this projector operates for approximately 2,500 cumulative hours, depending on the usage environment. (As the usage environment can vary significantly, the projector lamp may not operate for 2,500 hours.) It is recommended that the lamp be replaced after approximately 2,400 cumulative hours of use or when you notice a significant deterioration of the picture and color quality. The lamp usage time can be checked with the On-screen Display.

### CAUTION

- Intense light hazard. Do not attempt to look into the aperture and lens while the projector is operating.

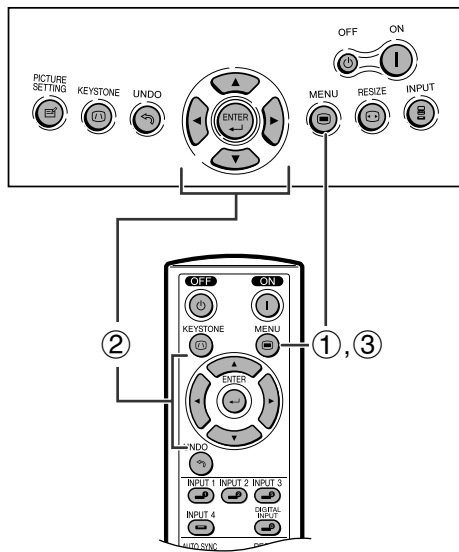

This function allows you to check the accumulated lamp usage time.

- 1 Press **MENU**. The "Picture" menu screen appears.
- 2 Press **◀/▶** to display the "Options" menu screen. The lamp usage time will be displayed in "Lamp Timer".
- 3 To exit the menu screen, press **MENU**.

### NOTE

- It is recommended that the lamp be replaced after approximately 2,400 cumulative hours of use. See page 46 for lamp replacement.

### On-screen Display

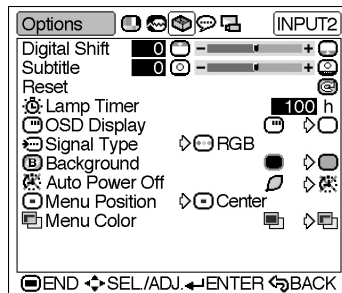

Condition	Problem	Possible Solution
The LAMP REPLACEMENT indicator illuminates in red, and "LAMP" and "■" will blink in yellow in the lower-left corner of the image.	<ul style="list-style-type: none"> <li>• Lamp has been used for over 2,400 hours.</li> </ul>	<ul style="list-style-type: none"> <li>• Purchase a replacement lamp unit (lamp/cage module) of the current type BQC-XVZ90+++1 from your nearest Authorized SharpVision Service Center or Dealer.</li> <li>• Replace the lamp. (See page 46.) If you wish, you may have the lamp replaced at your nearest Authorized SharpVision Service Center or Dealer.</li> </ul>
A significant deterioration of the picture and color quality occurs.		
The power will automatically turn off and the projector will enter standby mode.	<ul style="list-style-type: none"> <li>• Lamp has been used for over 2,500 hours.</li> </ul>	
"LAMP" and "■" will blink in red in the lower-left corner of the image, and the power will turn off.		



## Replacing the Lamp

### CAUTION

- There is potential glass particles hazard if the lamp ruptures. In case of lamp rupture, contact your nearest Authorized SharpVision Service Center or Dealer for replacement.
- Do not remove the lamp cage directly after operation of the projector. The lamp may be extremely hot. Wait at least one hour after the power cord is disconnected to allow the surface of the lamp cage to fully cool down before removing the lamp cage.

It is recommended that the lamp be replaced after approximately 2,400 cumulative hours of use or when you notice a significant deterioration of the picture and color quality. Carefully change the lamp by following the steps on the next page.

If the new lamp does not light after replacement, take your projector to the nearest Authorized SharpVision Service Center or Dealer for repair. Purchase a replacement lamp unit (lamp/cage module) of the current type BQC-XVZ90+++1 from your nearest Authorized SharpVision Service Center or Dealer. Then carefully change the lamp by following the instructions on the next page. If you wish, you may have the lamp replaced at your nearest Authorized SharpVision Service Center.

### IMPORTANT NOTE TO U.S. CUSTOMERS:

The lamp included with this projector is backed by a 90-day parts and labor limited warranty. All service of this projector under warranty, including lamp replacement, must be obtained through an Authorized SharpVision Service Center or Dealer. For the name of the nearest Authorized SharpVision Service Center or Dealer, please call toll-free: 1-877-DTV-SHARP (1-877-388-7427).

U.S.A. ONLY





## Replacing the Lamp

### Removing and installing the lamp unit

#### CAUTION

- Be sure to remove the lamp cage by the handle. Do not touch the glass surface of the lamp cage or the inside of the projector.
- To avoid injury to yourself and damage to the lamp, carefully follow the steps below.
- Replace the lamp after turning off the power and unplugging the power cord.

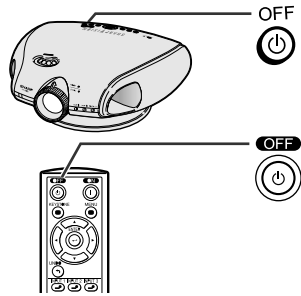
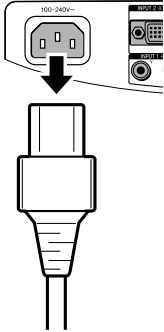
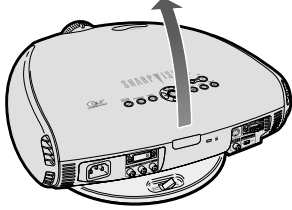
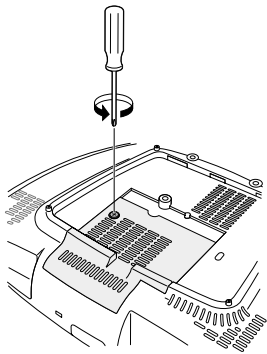
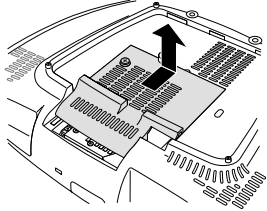
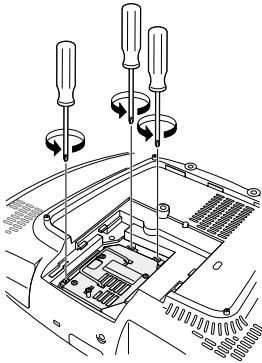
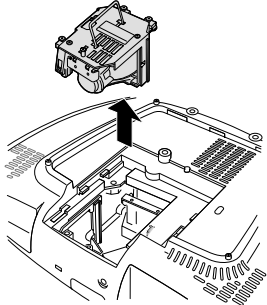
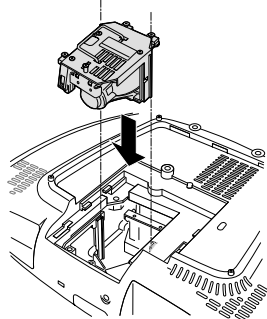
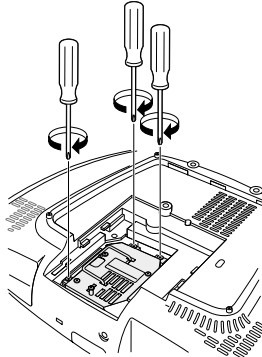
<p><b>1 Turn off the power.</b></p> <p>Press <b>POWER OFF</b>. Wait until the cooling fan stops running.</p> 	<p><b>2 Unplug the power cord.</b></p> 	<p><b>3 Remove the Swivel Stand. (See page E-17.)</b></p> 
<p><b>4 Loosen the user service screw that secures the lamp cage cover.</b></p> 	<p><b>5 Slide the lamp cage cover in the direction of the arrow.</b></p> 	<p><b>6 Loosen and remove the three-securing screws from the lamp cage.</b></p>  <p>User service screws</p>
<p><b>7 Remove the lamp cage.</b></p> 	<p><b>8 Insert the new lamp cage firmly into the lamp cage compartment.</b></p> 	<p><b>9 Tighten the three-securing screws to fasten the lamp cage.</b></p> 







## Replacing the Lamp

**10** Attach the lamp unit cover.

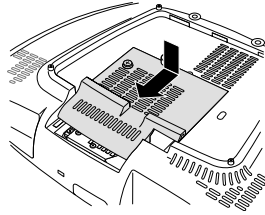

**11** Tighten the user service screw to fasten the lamp cage cover.

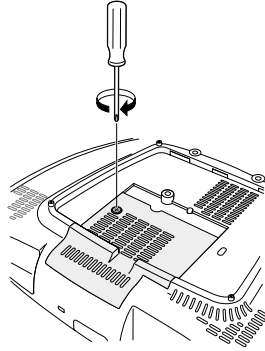

**12** Plug the power cord.

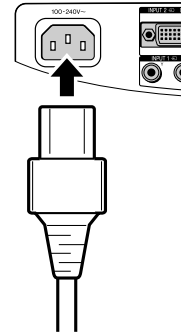

**13** Press **POWER ON** on the projector to reset the lamp timer.

Press **ON**, **INPUT**, **UNDO**, **ENTER** and **ON** in order. Then press **ON**.

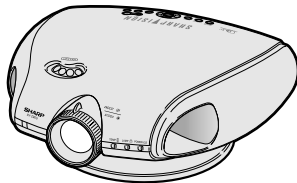

"LAMP 0000H" is displayed on the screen.

### NOTE

- You need to reset the lamp timer every time you replace the lamp and confirm it is reset on the "Lamp Timer" menu.





# Cleaning the Ventilative Holes

- This projector is equipped with ventilative holes to ensure the optimal operating condition of the projector.
- Periodically clean the ventilative hole by vacuuming it off with a vacuum cleaner.
- The ventilative holes should be cleaned every 100 hours of use. Clean the ventilative holes more often when the projector is used in a dirty or smoky location.

## Side and Rear view

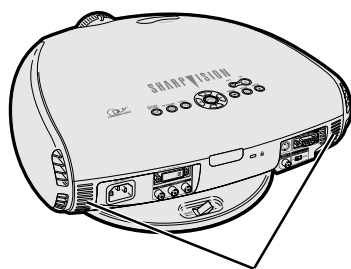

Intake ventilative holes

## Bottom view

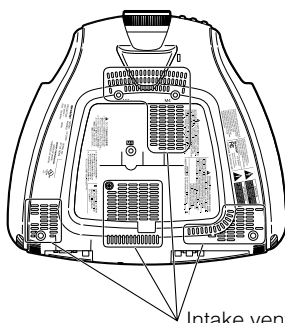

Intake ventilative holes

## Swivel stand

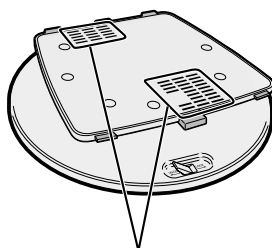

Intake ventilative holes

## How to clean the ventilative holes

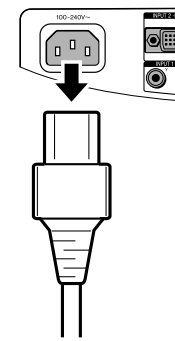
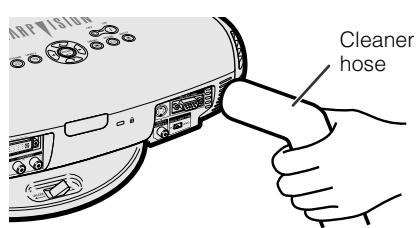
<b>1 Unplug the power cord.</b>	<b>2 Cleaning.</b>
	<p>Clean the dust off by putting the cleaner hose on the intake ventilative holes.</p> 





## Using the Kensington Lock

### Rear View

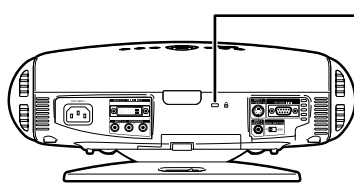

Kensington Security Standard connector

This projector has a Kensington Security Standard connector for use with a Kensington MicroSaver Security System. Refer to the information that came with the system for instructions on how to use it to secure the projector.



## Troubleshooting

Problem	Check
No picture appears.	<ul style="list-style-type: none"> <li>Projector power cord is not plugged into the wall outlet.</li> <li>Selected input is wrong. (See page 24.)</li> <li>Cables incorrectly connected to back panel of the projector. (See pages 12–15.)</li> <li>“Contrast” and “Bright” adjustments are set to minimum position. (See page 43.)</li> </ul>
Color is faded or poor.	<ul style="list-style-type: none"> <li>Picture adjustments are not correct. (See page 43.)</li> </ul>
Picture is blurred.	<ul style="list-style-type: none"> <li>Adjust the focus. (See page 16.)</li> <li>Projection distance is too long or too short to allow for proper focus. (See pages 21 and 22.)</li> </ul>
No OSD appears.	<ul style="list-style-type: none"> <li>OSD Display is set to “OFF”, preventing to display some or all On-screen Displays. (See page 36.)</li> </ul>
An unusual sound is occasionally heard from the cabinet.	<ul style="list-style-type: none"> <li>If the picture is normal, the sound is due to cabinet shrinkage caused by temperature changes. This will not affect operation or performance of the projector.</li> </ul>
Maintenance indicator illuminates.	<ul style="list-style-type: none"> <li>Refer to “Lamp/Maintenance Indicators” on page 44.</li> </ul>
Picture noise appears.	<ul style="list-style-type: none"> <li>Adjust the “Phase” setting. (See page 33.)</li> </ul>
Image is green on INPUT 2 Component. Image is pink (no green) on INPUT 2 RGB.	<ul style="list-style-type: none"> <li>Change the input signal type. (See page 36.)</li> </ul>



## For SHARP Assistance (U.S.A. only)

If you encounter any problems during setup or operation of this projector, first refer to the “Troubleshooting” section on this page. If this operation manual does not answer your question, please call toll free 1-877-DTV-SHARP (1-877-388-7427) for further assistance. Or, send us an e-mail at [lcdsupport@sharpsec.com](mailto:lcdsupport@sharpsec.com). Our World Wide Web address is <http://www.sharpusa.com/>.





# Connecting Pin Assignments

**DVI-I (INPUT 2 / DIGITAL INPUT) port : 29 pin connector**

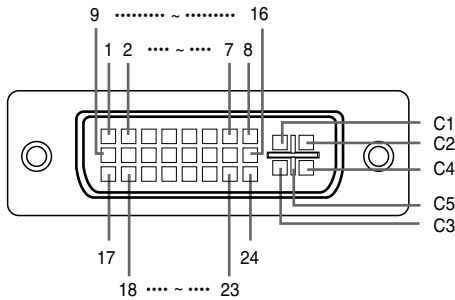

## • DVI Digital INPUT

Pin No.	Signal	Pin No.	Signal
1	T.M.D.S data 2-	16	Hot plug detection
2	T.M.D.S data 2+	17	T.M.D.S data 0-
3	T.M.D.S data 2 shield	18	T.M.D.S data 0+
4	Not connected	19	T.M.D.S data 0 shield
5	Not connected	20	Not connected
6	DDC clock	21	Not connected
7	DDC data	22	T.M.D.S clock shield
8	Not connected	23	T.M.D.S clock+
9	T.M.D.S data 1-	24	T.M.D.S clock-
10	T.M.D.S data 1+	C1	Not connected
11	T.M.D.S data 1 shield	C2	Not connected
12	Not connected	C3	Not connected
13	Not connected	C4	Not connected
14	+5V power	C5	Ground
15	Ground		

## • DVI Analog RGB Input

Pin No.	Signal	Pin No.	Signal
1	Not connected	16	Hot plug detection
2	Not connected	17	Not connected
3	Not connected	18	Not connected
4	Not connected	19	Not connected
5	Not connected	20	Not connected
6	DDC clock	21	Not connected
7	DDC data	22	Not connected
8	Vertical sync	23	Not connected
9	Not connected	24	Not connected
10	Not connected	C1	Analog input Red
11	Not connected	C2	Analog input Green
12	Not connected	C3	Analog input Blue
13	Not connected	C4	Horizontal sync
14	+5V power	C5	Ground
15	Ground		

## • DVI Analog Component Input

Pin No.	Signal	Pin No.	Signal
1	Not connected	16	Not connected
2	Not connected	17	Not connected
3	Not connected	18	Not connected
4	Not connected	19	Not connected
5	Not connected	20	Not connected
6	Not connected	21	Not connected
7	Not connected	22	Not connected
8	Not connected	23	Not connected
9	Not connected	24	Not connected
10	Not connected	C1	Analog input Pr/Cr
11	Not connected	C2	Analog input Y
12	Not connected	C3	Analog input Pb/Cb
13	Not connected	C4	Not connected
14	Not connected	C5	Ground
15	Ground		

**RS-232C Port:** 9-pin D-sub male connector of the DIN-D-sub RS-232C cable

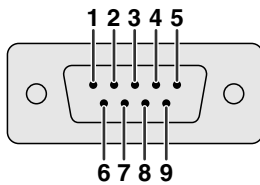

Pin No.	Signal	Name	I/O	Reference
1				Not connected
2	RD	Receive Data	Input	Connected to internal circuit
3	SD	Send Data	Output	Connected to internal circuit
4		Reserved		Connected to internal circuit
5	SG	Signal Ground		Connected to internal circuit
6		Reserved		Connected to internal circuit
7		Reserved		Connected to internal circuit
8		Reserved		Connected to internal circuit
9				Not connected





# (RS-232C) Specifications and Command Settings

## PC control

A computer can be used to control the projector by connecting an RS-232C cable (null modem, cross type, commercially available) to the projector. (See page 14 for connection.)

## Communication conditions

Set the serial port settings of the computer to match those of the table on the next page.

Signal format: Conforms to RS-232C standard.

Baud rate: 9,600 bps

Data length: 8 bits

Parity bit: NON

Stop bit: 1 bit

Flow control: None

## Basic format

Commands from the computer are sent in the following order: command, parameter, and return code. After the projector processes the command from the computer, it sends a response code to the computer.

### Command format

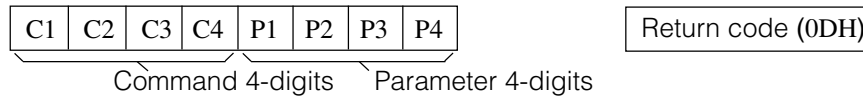

### Response code format

Normal response



Problem response (communication error or incorrect command)



When more than one code is being sent, send each command only after the OK response code for the previous command from the projector is verified.

### NOTE

- When using the computer control function of the projector, the projector operating status cannot be read to the computer. Therefore, confirm the status by transmitting the display commands for each adjustment menu and checking the status with the On-screen Display.

## Commands

### EXAMPLE

- When power on.

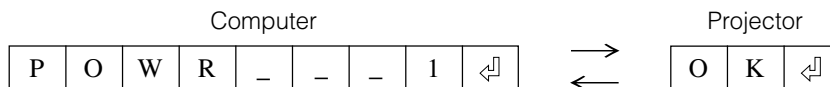



## (RS-232C) Specifications and Command Settings

	CONTROL CONTENTS	COMMAND	PARAMETER	RETURN
BUTTONS & REMOTE CONTROL KEY	POWER ON	P O W R	_ _ _	1 OK OR ERR
	POWER OFF	P O W R	_ _ 0	0 OK OR ERR
	INPUT 1 (COMPONENT 1)	I V E D	_ _ _	1 OK OR ERR
	INPUT 2 (COMPONENT 2)	I V E D	_ _ 2	2 OK OR ERR
	INPUT 3 (S-VIDEO)	I V E D	_ _ 3	3 OK OR ERR
	INPUT 4 (VIDEO)	I V E D	_ _ 4	4 OK OR ERR
	DIGITAL MODE	I V E D	_ _ 5	5 OK OR ERR

### NOTE

- If an underbar ( \_ ) appears in the parameter column, enter a space.





# Computer Compatibility Chart

Horizontal Frequency: 15–70 kHz  
 Vertical Frequency: 43–75 Hz  
 Pixel Clock: 12–110 MHz  
 Compatible with sync on green  
 XGA compatible in intelligent compression

PC/ MAC/ WS	Resolution	Horizontal Frequency (kHz)	Vertical Frequency (Hz)	VESA Standard	DVI Support	Display	
PC	VGA	640 × 350	27.0	60			Upscale
			31.5	70			
		720 × 350	27.0	60			
			31.5	70			
		640 × 400	27.0	60			
			31.5	70			
	640 × 480	720 × 400	26.2	50			
			31.5	60	✓	✓	
		640 × 480	34.7	70			
			37.9	72	✓	✓	
			37.5	75	✓	✓	
	SVGA	800 × 600	31.4	50			
			35.1	56	✓	✓	
			37.9	60	✓	✓	
			44.5	70			
			48.1	72	✓	✓	
			46.9	75	✓	✓	
XGA	1,024 × 768	35.5	43	✓		Intelligent Compression	
		40.3	50				
		56.5	70	✓			
		58.1	72				
—	1,280 × 720	45.0	60				
PC/ MAC 13"	VGA	640 × 480	34.9	67			Upscale
PC/ MAC 19"	XGA	1,024 × 768	48.4	60	✓		Intelligent Compression
			60.0	75	✓		
MAC 16"	SVGA	832 × 624	46.8	75			
			49.6	75			

## NOTE

- This projector may not be able to display images from notebook computers in simultaneous (CRT/LCD) mode. Should this occur, turn off the LCD display on the notebook computer and output the display data in "CRT only" mode. Details on how to change display modes can be found in your notebook computer's operation manual.





# Dimensions

Rear View

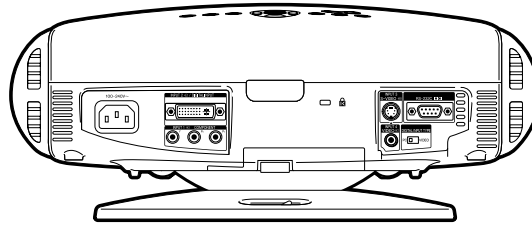

Side View

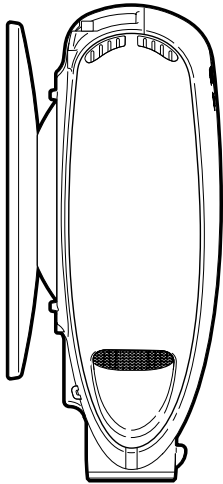

Top View

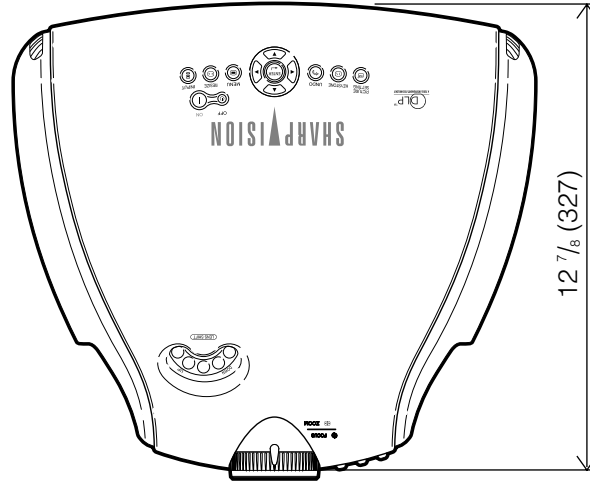

Side View

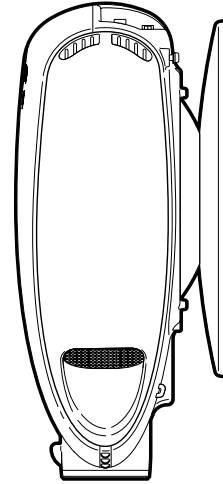

Front View

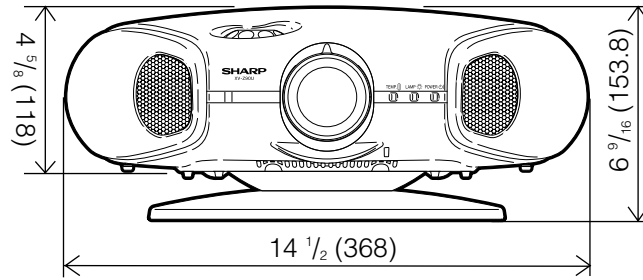

Bottom View

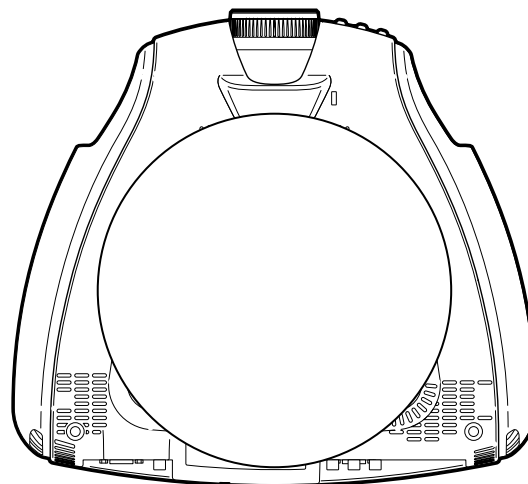

Units: inches (mm)





# Specifications

Product type	Projector
Model	XV-Z90U
Video system	PAL/PAL 60/PAL-M/PAL-N/SECAM/NTSC 3.58/NTSC 4.43 DTV 480i/480P/720P/1080i
Display method	DLP chip, RGB optical shutter method
DLP panel	Panel size: 0.55" Display method: Single Panel Digital Micromirror Device (DMD™) by Texas Instruments Drive method: Digital Light Processing (DLP™) No. of dots: 480,000 dots (800 [H] x 600 [V])
Lens	1-1.2 x zoom lens, F3.0, f=32.5-44.0 mm
Projection lamp	150 W SHP lamp
Video input signal	RCA Connector: VIDEO (INPUT 4), composite video, 1.0 Vp-p, sync negative, 75 Ω terminated
S-video input signal	4-pin Mini DIN connector (INPUT 3) Y (luminance signal): 1.0 Vp-p, sync negative, 75 Ω terminated C (chrominance signal): Burst 0.286 Vp-p, 75 Ω terminated
Component input signal (INPUT 1)	RCA Connector Y: 1.0 Vp-p, sync negative, 75 Ω terminated PB: 0.7 Vp-p, 75 Ω terminated PR: 0.7 Vp-p, 75 Ω terminated
Component input signal (INPUT 2)	29-pin connector DVI input signal: Digital 250-1,000 mV 50 Ω Analog 0.7 Vp-p 75 Ω Y: 1.0 Vp-p, sync negative, 75 Ω terminated Pb: 0.7 Vp-p, 75 Ω terminated Pr: 0.7 Vp-p, 75 Ω terminated
Component RGB input signal (INPUT 2)	29-pin connector RGB separate/sync on green type analog input: 0-0.7 Vp-p, positive, 75 Ω terminated HORIZONTAL SYNC. SIGNAL: TTL level (positive/negative) VERTICAL SYNC. SIGNAL: Same as above
Horizontal resolution	520 TV lines (NTSC 3.58 input)
RGB input signal	15-PIN MINI D-SUB CONNECTOR (INPUT 2): RGB separate/composite sync/sync on green type analog input: 0-0.7 Vp-p, positive, 75 Ω terminated HORIZONTAL SYNC. SIGNAL: TTL level (positive/negative) or composite sync (Apple only) VERTICAL SYNC. SIGNAL: Same as above
Pixel clock	12-110 MHz
Vertical frequency	43-75 Hz
Horizontal frequency	15-70 kHz
Computer control signal	9-pin D-sub connector (RS-232C Port)
Rated voltage	AC 100-240 V
Input current	3.6 A
Rated frequency	50/60 Hz
Power consumption	200 W
Heat dissipation	1,400 BTU/hour
Operating temperature	41°F to 95°F (~5°C to ~35°C)
Storage temperature	14°F to 140°F (120°C to ~60°C)
Cabinet	Plastic
I/R carrier frequency	38 kHz
Dimensions (approx.)	14 <sup>1</sup> / <sub>29</sub> (W) x 6 <sup>9</sup> / <sub>16</sub> (H) x 12 <sup>7</sup> / <sub>8</sub> (D) (368 x 153.8 x 327 mm) (including swivel stand) 14 <sup>1</sup> / <sub>29</sub> (W) x 4 <sup>5</sup> / <sub>8</sub> (H) x 12 <sup>7</sup> / <sub>8</sub> (D) (368 x 118 x 327 mm) (main body only)
Weight (approx.)	9.5 lbs. (4.3 kg) (including swivel stand) 8.4 lbs. (3.8kg) (main body only)
Supplied accessories	Remote control, Two AA size batteries, Power cord (118 109, 3.6 m), Terminal cover, Lens cap (attached on the body), Lens cap strap, Operation manual, Screws for terminal cover
Replacement parts	Lamp unit (Lamp/cage module) (BQC-XVZ90+++1), Remote control (RRMCGA064WJSA), AA size batteries, Power cord (QACCDA007WJPZ), Terminal cover (GCOVAA116WJKA), Lens cap (CCAPHA004WJ01), Lens cap strap (UBNDT0013CEZZ), Operation manual (TINS-A286WJZZ), Screws for terminal cover (XBBSN40P10000)

This SHARP projector uses a DMD chip. This very sophisticated chip contains 480,000 pixels. As with any high technology electronic equipment such as large screen TVs, video systems and video cameras, there are certain acceptable tolerances that the equipment must conform to.

This unit has some inactive pixels within acceptable tolerances which may result in inactive dots on the picture screen. This will not affect the picture quality or the life expectancy of the unit. If you have any questions about this matter, please call toll free 1-877-DTV-SHARP (1-877-388-7427). U.S.A. ONLY

*Specifications are subject to change without notice.*





# Glossary

**Aspect ratio**

Width and height ratio of an image. The normal aspect ratio of a computer and video image is 4 : 3. There are also wide images with an aspect ratio of 16 : 9 and 21 : 9.

**Auto Sync**

Optimizes projected computer images by automatically adjusting certain characteristics.

**Background**

Initial setting image projected when no signal is being input.

**Clock**

Clock adjustment is used to adjust vertical noise when clock level is incorrect.

**CLR Temp (Color temperature)**

Function that can be used to adjust the color temperature to suit the type of image input to the projector. Decrease the color temperature to create warmer, reddish images for natural flesh tones, or increase to create cooler, bluish images for a brighter picture.

**Composite sync**

Signal combining horizontal and vertical sync pulses.

**Digital keystone correction**

Function to digitally correct a distorted image when the projector is set up at an angle, smoothes out jaggies on keystone images and compresses the image not only horizontally but vertically keeping the 4 : 3 aspect ratio.

**Digital shift**

Shifts image up or down easily by ▲/▼ buttons when RESIZE mode of input image is NORMAL, BORDER, or STRETCH of COMPUTER, VIDEO and DTV inputs.

**DVI (Digital Visual Interface)**

Display digital interface that also supports Analog interfaces.

**GAMMA**

Image quality enhancement function that offers a richer image by brightening the darker portions of the image without altering the brightness of the brighter portions. You can select from four different modes: Standard, Black Detail, White Detail and Brighten.

**HDCP**

Digital entertainment content is protected from copying with the HDCP system.

**Intelligent compression and expansion**

High quality resizing of lower and higher resolution images to fit the projector's native resolution.

**Phase**

Phase shift is a timing shift between isomorphic signals with the same resolution. When phase level is incorrect, the projected image typically displays horizontal flicker.

**RESIZE**

Allows you to modify or customize the picture display mode to enhance the input image. You can select from four different modes: NORMAL, FULL, BORDER and STRETCH.

**RS-232C**

Function to control the projector from the computer by using the RS-232C ports on the projector and computer.

**Stretch**

Mode that stretches the 4:3 image horizontally to display it on the wide screen.

**Sync on green**

Video signal mode of a computer which overlaps horizontal and vertical sync signal to green color signal pin.





# Index

<b>A</b>		
AC socket .....	12	
ADJUSTMENT buttons .....	26	
Adjusting the Picture .....	29	
Aspect ratio .....	24	
Automatic power shutoff function .....	41	
Auto sync adjustment .....	35	
AUTO SYNC button .....	35	
<b>B</b>		
Background .....	37	
<b>C</b>		
Ceiling-mount .....	22	
Clock .....	33	
COMPONENT terminals .....	13	
<b>D</b>		
Digital shift .....	38	
DVI .....	14	
<b>E</b>		
ENTER button .....	19	
Exhaust ventilative hole .....	4	
<b>F</b>		
Focus ring .....	16	
<b>H</b>		
HDCP .....	7	
<b>I</b>		
INPUT buttons .....	24	
<b>K</b>		
Kensington Lock .....	50	
KEystone button .....	19	
<b>L</b>		
LAMP REPLACEMENT indicator .....	44	
Lens shift .....	18	
LIGHT button .....	15	
<b>M</b>		
MENU button .....	26	
<b>O</b>		
On-screen display .....	36	
On-screen display Language .....	42	
<b>P</b>		
Phase .....	33	
POWER buttons .....	16	
Power cord .....	12	
POWER indicator .....	44	
<b>R</b>		
Rear+Ceiling .....	42	
Rear projection .....	23	
Remote control .....	10	
Remote control sensor .....	15	
Remote control signal transmitter .....	10	
RESIZE button .....	24	
INPUT 2 DVI digital port .....	13	
RS-232C port .....	51	
<b>S</b>		
STRETCH .....	24	
Subtitle .....		39
S-VIDEO INPUT terminal .....		12
Sync .....		35
Sync on green .....		54
<b>T</b>		
TEMPERATURE WARNING indicator .....		44
<b>U</b>		
UNDO button .....		26
<b>V</b>		
VIDEO INPUT terminal .....		12
Video Systems .....		37
<b>Z</b>		
Zoom knob .....		16



### CONSUMER LIMITED WARRANTY

SHARP ELECTRONICS CORPORATION warrants to the first consumer purchaser that this Sharp brand product (the "Product"), when shipped in its original container, will be free from defective workmanship and materials, and agrees that it will, at its option, either repair the defect or replace the defective Product or part thereof with a new or remanufactured equivalent at no charge to the purchaser for parts or labor for the period(s) set forth below.

This warranty does not apply to any appearance items of the Product nor to the additional excluded item(s) set forth below nor to any Product the exterior of which has been damaged or defaced, which has been subjected to improper voltage or other misuse, abnormal service or handling, or which has been altered or modified in design or construction.

In order to enforce the rights under this limited warranty, the purchaser should follow the steps set forth below and provide proof of purchase to the servicer.

The limited warranty described herein is in addition to whatever implied warranties may be granted to purchasers by law. ALL IMPLIED WARRANTIES INCLUDING THE WARRANTIES OF MERCHANTABILITY AND FITNESS FOR USE ARE LIMITED TO THE PERIOD(S) FROM THE DATE OF PURCHASE SET FORTH BELOW. Some states do not allow limitations on how long an implied warranty lasts, so the above limitation may not apply to you.

Neither the sales personnel of the seller nor any other person is authorized to make any warranties other than those described herein, or to extend the duration of any warranties beyond the time period described herein on behalf of Sharp.

The warranties described herein shall be the sole and exclusive warranties granted by Sharp and shall be the sole and exclusive remedy available to the purchaser. Correction of defects, in the manner and for the period of time described herein, shall constitute complete fulfillment of all liabilities and responsibilities of Sharp to the purchaser with respect to the Product, and shall constitute full satisfaction of all claims, whether based on contract, negligence, strict liability or otherwise. In no event shall Sharp be liable, or in any way responsible, for any damages or defects in the Product which were caused by repairs or attempted repairs performed by anyone other than an authorized servicer. Nor shall Sharp be liable or in any way responsible for any incidental or consequential economic or property damage. Some states do not allow the exclusion of incidental or consequential damages, so the above exclusion may not apply to you.

THIS WARRANTY GIVES YOU SPECIFIC LEGAL RIGHTS. YOU MAY ALSO HAVE OTHER RIGHTS WHICH VARY FROM STATE TO STATE.

**Model Specific Section (In-Home Service)**

**Your Product Model Number & Description:** XV-Z90U Projector  
(Be sure to have this information available when you need service for your Product.)

**Warranty Period for this Product:** One (1) year parts and labor from date of purchase except for the Projector Lamp for which the warranty period is ninety (90) days from date of purchase. After the ninety (90) day warranty period on the Projector Lamp, parts and labor for a lamp replacement are the responsibility of the consumer.

**Additional Item(s) Excluded from Warranty Coverage (if any):** Cleaning of Optical System and/or replacement of any filter. Labor & materials required to remove and reinstall a suspended projector in installations not accessible with a standard (8' step) ladder or ceilings exceeding 12' in height.

**Where to Obtain Service:** Labor & materials required to remove and reinstall a projector in complex systems including, but not limited to, projectors installed in custom enclosures, projectors connected to third party control and automation systems, and realignment of projectors installed in "mirrored" rear projection enclosures.

**What to do to Obtain Service:** From a Sharp Authorized Servicer located in the United States. To find the location of the nearest Sharp Authorized Servicer, call Sharp toll free at 1-800-BE-SHARP. Contact your Sharp Authorized Servicer to obtain in-home service for this Product. The Servicer will come to your home and if necessary to remove the Product for repair at the Servicer's facility, the Servicer will reinstall it upon completion of repair. Be sure to have **Proof of Purchase** available.

TO OBTAIN PRODUCT INFORMATION, CALL 1-877-DTV-SHARP OR VISIT [www.sharppusa.com](http://www.sharppusa.com).

VALID IN CANADA ONLY

# SHARP®

## LIMITED WARRANTY

### *Consumer Electronics Products*

### **Congratulations on your purchase!**

Sharp Electronics of Canada Ltd. (hereinafter called "Sharp") gives the following express warranty to the first consumer purchaser for this Sharp brand product, when shipped in its original container and sold or distributed in Canada by Sharp or by an Authorized Sharp Dealer:

Sharp warrants that this product is free, under normal use and maintenance, from any defects in material and workmanship. If any such defects should be found in this product within the applicable warranty period, Sharp shall, at its option, repair or replace the product as specified herein.

This warranty shall not apply to:

- (a) Any defects caused or repairs required as a result of abusive operation, negligence, accident, improper installation or inappropriate use as outlined in the owner's manual.
- (b) Any Sharp product tampered with, modified, adjusted or repaired by any party other than Sharp, Sharp's Authorized Service Centres or Sharp's Authorized Servicing Dealers.
- (c) Damage caused or repairs required as a result of the use with items not specified or approved by Sharp, including but not limited to head cleaning tapes and chemical cleaning agents.
- (d) Any replacement of accessories, glassware, consumable or peripheral items required through normal use of the product including but not limited to earphones, remote controls, AC adapters, batteries, temperature probe, stylus, trays, filters, belts, ribbons, cables and paper.
- (e) Any cosmetic damage to the surface or exterior that has been defaced or caused by normal wear and tear.
- (f) Any damage caused by external or environmental conditions, including but not limited to transmission line/power line voltage or liquid spillage.
- (g) Any product received without appropriate model, serial number and CSA/cUL markings.
- (h) Any products used for rental or commercial purposes.
- (i) Any installation, setup and/or programming charges.

Should this Sharp product fail to operate during the warranty period, warranty service may be obtained upon delivery of the Sharp product together with proof of purchase and a copy of this LIMITED WARRANTY statement to an Authorized Sharp Service Centre or an Authorized Sharp Servicing Dealer. In home warranty service may be provided at Sharp's discretion on any Sharp television with the screen size of 27" or larger and on any Sharp Over The Range Microwave Oven.

This warranty constitutes the entire express warranty granted by Sharp and no other dealer, service centre or their agent or employee is authorized to extend, enlarge or transfer this warranty on behalf of Sharp. To the extent the law permits, Sharp disclaims any and all liability for direct or indirect damages or losses or for any incidental, special or consequential damages or loss of profits resulting from a defect in material or workmanship relating to the product, including damages for the loss of time or use of this Sharp product or the loss of information. The purchaser will be responsible for any removal, reinstallation, transportation and insurance costs incurred. Correction of defects, in the manner and period of time described herein, constitute complete fulfillment of all obligations and responsibilities of Sharp to the purchaser with respect to the product and shall constitute full satisfaction of all claims, whether based on contract, negligence, strict liability or otherwise.

#### WARRANTY PERIODS

Projector	1 years (bulb 90 days)
-----------	------------------------

To obtain the name and address of the nearest Authorized Sharp Service Centre or Dealer, please contact:  
SHARP ELECTRONICS OF CANADA LTD.

SHARP ELECTRONICS OF CANADA LTD  
335 Britannia Road East  
Mississauga, Ontario  
L4Z 1W9  
(905) 568-7140 or 1-(877) SHARP-CC  
Web site: [www.sharp.ca](http://www.sharp.ca)



Appendix

