

***myprojectorlamps.com***

**The most trusted, dependable name  
in projector lamp sales.**



<http://www.myprojectorlamps.com>



<http://www.myprojectorlamps.ca>



<http://www.myprojectorlamps.eu>

The following projector manual has not been modified or altered in any way.

# SHARP®

# XV-Z201E

PROJECTOR  
PROJEKTOR  
PROJECTEUR  
PROJEKTOR  
PROYECTOR  
PROIETTORE  
PROJECTOR

OPERATION MANUAL  
BEDIENUNGSANLEITUNG  
MODE D'EMPLOI  
BRUKSANVISNING  
MANUAL DE MANEJO  
MANUALE DI ISTRUZIONI  
GEBRUIKSAANWIJZING

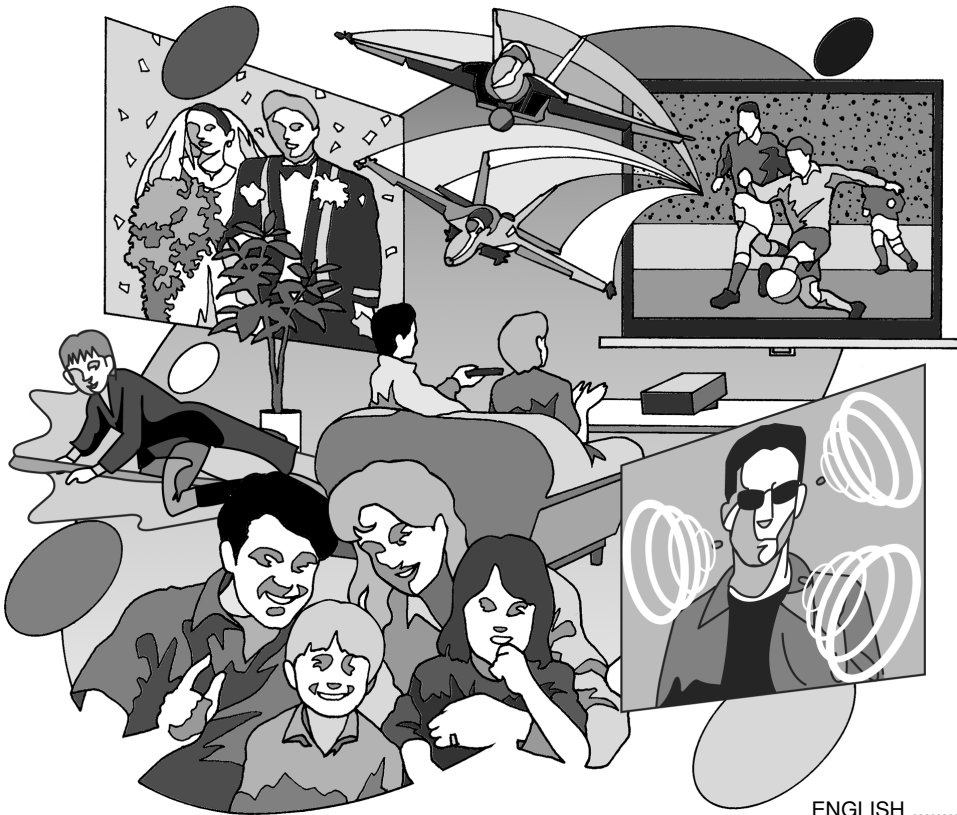

ENGLISH ..... (GB) -1 - (GB) -70  
DEUTSCH ..... (D) -1 - (D) -70  
FRANÇAIS ..... (F) -1 - (F) -70  
SVENSKA ..... (S) -1 - (S) -70  
ESPAÑOL ..... (ES) -1 - (ES) -70  
ITALIANO ..... (I) -1 - (I) -70  
NEDERLANDS .... (NL) -1 - (NL) -70

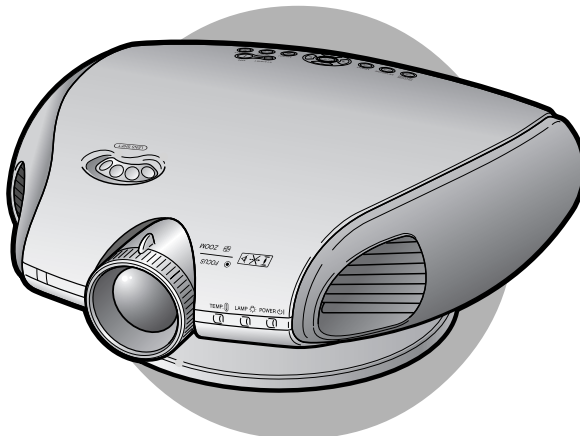

This equipment complies with the requirements of Directive 89/336/EEC and 73/23/EEC as amended by 93/68/EEC.

Dieses Gerät entspricht den Anforderungen der EG-Richtlinien 89/336/EWG und 73/23/EWG mit Änderung 93/68/EWG.

Ce matériel répond aux exigences contenues dans les directives 89/336/CEE et 73/23/CEE modifiées par la directive 93/68/CEE.

Dit apparaat voldoet aan de eisen van de richtlijnen 89/336/EEG en 73/23/EEG, gewijzigd door 93/68/EEG.

Dette udstyr overholder kravene i direktiv nr. 89/336/EEC og 73/23/EEC med tillæg nr. 93/68/EEC.

Quest' apparecchio è conforme ai requisiti delle direttive 89/336/EEC e 73/23/EEC come emendata dalla direttiva 93/68/EEC.

Η εγκατάσταση αυτή ανταποκρίνεται στις απαιτήσεις των οδηγιών της Ευρωπαϊκής Ένωσης 89/336/EOK και 73/23/EOK, όπως οι κανονισμοί αυτοί συμπληρώθηκαν από την οδηγία 93/68/EOK.

Este equipamento obedece às exigências das directivas 89/336/CEE e 73/23/CEE, na sua versão corrigida pela directiva 93/68/CEE.



Este aparato satisface las exigencias de las Directivas 89/336/CEE y 73/23/CEE, modificadas por medio de la 93/68/CEE.

Denna utrustning uppfyller kraven enligt riktlinjerna 89/336/EEC och 73/23/EEC så som kompletteras av 93/68/EEC.

Dette produktet oppfyller betingelsene i direktivene 89/336/EEC og 73/23/EEC i endringen 93/68/EEC.

Tämä laite täyttää direktiivin 89/336/EEC ja 73/23/EEC vaatimukset, joita on muutettu direktiivillä 93/68/EEC.

### **SPECIAL NOTE FOR USERS IN THE U.K.**

The mains lead of this product is fitted with a non-rewireable (moulded) plug incorporating a 10A fuse. Should the fuse need to be replaced, a BSI or ASTA approved BS 1362 fuse marked  or  and of the same rating as above, which is also indicated on the pin face of the plug, must be used.

Always refit the fuse cover after replacing the fuse. Never use the plug without the fuse cover fitted.

In the unlikely event of the socket outlet in your home not being compatible with the plug supplied, cut off the mains plug and fit an appropriate type.

### **DANGER**

The fuse from the cut-off plug should be removed and the cut-off plug destroyed immediately and disposed of in a safe manner.

Under no circumstances should the cut-off plug be inserted elsewhere into a 10A socket outlet, as a serious electric shock may occur.

To fit an appropriate plug to the mains lead, follow the instructions below:

### **WARNING:**

THIS APPARATUS MUST BE EARTHED.

### **IMPORTANT:**

The wires in this mains lead are coloured in accordance with the following code:

Green-and-yellow : Earth  
Blue : Neutral  
Brown : Live

As the colours of the wires in the mains lead of this apparatus may not correspond with the coloured markings identifying the terminals in your plug proceed as follows:

- The wire which is coloured green-and-yellow must be connected to the terminal in the plug which is marked by the letter E or by the safety earth symbol  or coloured green or green-and-yellow.
- The wire which is coloured blue must be connected to the terminal which is marked with the letter N or coloured black.
- The wire which is coloured brown must be connected to the terminal which is marked with the letter L or coloured red.

IF YOU HAVE ANY DOUBT, CONSULT A QUALIFIED ELECTRICIAN.

Before using the projector, please read this operation manual carefully.

# Introduction

ENGLISH

## IMPORTANT

For your assistance in reporting the loss or theft of your Projector, please record the Serial Number located on the bottom of the projector and retain this information. Before recycling the packaging, please be sure that you have checked the contents of the carton thoroughly against the list of "Supplied accessories" on page 12.

**Model No.: XV-Z201E**

**Serial No.:**

**WARNING:** Intense light source. Do not look into the beam or view it directly. Be especially careful that children do not look directly into the beam.



**WARNING:** To reduce the risk of fire or electric shock, do not expose this product to rain or moisture.

**CAUTION:** To reduce the risk of electric shock, do not remove cabinet. No user-serviceable parts are inside. Refer servicing to qualified service personnel.

## WARNING:

The cooling fan in this projector continues to run for about 90 seconds after the projector enters the standby mode. During normal operation, when putting the projector into the standby mode always use the STANDBY button on the projector or on the remote control. Ensure the cooling fan has stopped before disconnecting the power cord. DURING NORMAL OPERATION, NEVER TURN THE PROJECTOR OFF BY DISCONNECTING THE POWER CORD. FAILURE TO OBSERVE THIS WILL RESULT IN PREMATURE LAMP FAILURE.

## WARNING:

This is a Class A product. In a domestic environment this product may cause radio interference in which case the user may be required to take adequate measures.

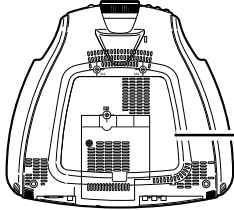

## Caution Concerning the Lamp Replacement

There is potential glass particles hazard if the lamp ruptures.



### LAMP REPLACEMENT CAUTION

BEFORE REMOVING THE SCREW, DISCONNECT POWER CORD.  
HOT SURFACE INSIDE. ALLOW 1 HOUR TO COOL BEFORE  
REPLACING THE LAMP. REPLACE WITH SAME SHARP LAMP  
UNIT TYPE BQC-XVZ200++1 ONLY. UV RADIATION : CAN CAUSE  
EYE DAMAGE. TURN OFF LAMP BEFORE SERVICING.  
HIGH PRESSURE LAMP : RISK OF EXPLOSION.  
POTENTIAL HAZARD OF GLASS PARTICLES IF LAMP HAS  
RUPTURED. HANDLE WITH CARE. SEE OPERATION MANUAL.



### PRECAUTIONS A OBSERVER LORS DU REMPLACEMENT DE LA LAMPE.

DEBRANCHER LE CORDON D'ALIMENTATION AVANT DE RETIRER LES VIS.  
L'INTERIEUR DU BOITIER ETANT EXTREMEMENT CHAUD, ATTENDRE  
1 HEURE AVANT DE PROCEDER AU REMPLACEMENT DE LA LAMPE.  
NE REMPLACER QUE PAR UNE LAMPE SHARP DE TYPE BQC-XVZ200++1.  
RAYONS ULTRAVIOLETS : PEUVENT ENDOMMAGER LES YEUX.  
ETEINDRE LA LAMPE AVANT DE PROCEDER A L'ENTRETIEN.  
LAMPE A HAUTE PRESSION : RISQUE D'EXPLOSION.  
DANGER POTENTIEL DE PARTICULES DE VERRE EN CAS D'ECLATEMENT DE LA LAMPE.  
A MANIPULER AVEC PRECAUTION, SE REPORTER AU MODE D'EMPLOI.

### WARNING:

Some IC chips in this product include confidential and/or trade secret property belonging to Texas Instruments. Therefore you may not copy, modify, adapt, translate, distribute, reverse engineer, reverse assemble or discompile the contents thereof.

# Contents

## Introduction

<b>Contents</b> .....	<b>3</b>
<b>IMPORTANT SAFEGUARDS</b> .....	<b>4</b>
<b>Quick Guide</b> .....	<b>7</b>
<b>Part Names</b> .....	<b>8</b>
<b>Operating the Remote Control</b> .....	<b>11</b>
<b>Accessories</b> .....	<b>12</b>

## Connections & Setup

<b>Connecting the Projector to Other Devices</b> ....	<b>14</b>
Connecting the Power Cord .....	14
Connecting to Video Equipment .....	15
Connecting to a DVD Player and DTV Decoder ...	17
Connecting to a Computer .....	21
Controlling the Projector by a Computer .....	23
<b>Setup</b> .....	<b>24</b>
Using the Swivel Stand .....	24
Removing the Swivel Stand .....	24
Attaching the Swivel Stand .....	25
Focusing and Zooming .....	25
Using the Lens Shift .....	25
Adjusting the Projection Distance .....	26
Image Projection .....	28

## Basic Operation

<b>Image Projection</b> .....	<b>30</b>
Basic Procedure .....	30
Selecting the On-screen Display Language .....	31
Turning the Power off .....	32
Keystone Correction .....	33
Placement of the Projected Image	
Using the Keystone Correction .....	34
Freezing a Moving Image .....	35
Adjusting the Picture Aspect Ratio .....	35

## Adjustments and Settings

<b>Using the Menu Screen</b> .....	<b>38</b>
Menu Selections (Adjustment) .....	38
Menu Selections (Settings) .....	40
<b>Menu Bar Items</b> .....	<b>42</b>
<b>Adjusting the Picture</b> .....	<b>44</b>
Adjusting Image Preferences .....	44
Adjusting the Colour Temperature .....	45
Gamma Correction Function .....	46
Emphasizing the Contrast .....	46
Picture Setting Function .....	47
<b>Adjusting the Computer and</b>	
<b>DVD/DTV Images</b> .....	<b>48</b>
When Auto Sync is OFF .....	48
Special Modes Adjustment .....	49
Auto Sync Adjustment .....	50
Checking the Input Signal .....	50

<b>Using the “Options” Menu</b> .....	<b>51</b>
Checking the Lamp Life Status .....	51
Turning on/off the On-screen Display .....	51
Selecting the Signal Type .....	52
Setting the Video Signal (VIDEO menu only) .....	52
Selecting a Background Image .....	53
Setting the Eco Mode .....	53
Automatic Power Shut-off Function .....	54
Selecting the Menu Screen Position .....	54
Selecting the Menu Colour .....	55
<b>Reversing/Inverting Projected Images</b> .....	<b>56</b>

## Appendix

<b>Maintenance Indicators</b> .....	<b>58</b>
<b>Regarding the Lamp</b> .....	<b>59</b>
Lamp .....	59
Caution Concerning the Lamp .....	59
Replacing the Lamp .....	59
Removing and Installing the Lamp Unit .....	60
Resetting the Lamp Timer .....	61
<b>Cleaning the Ventilative Holes</b> .....	<b>62</b>
<b>Using the Kensington Lock</b> .....	<b>63</b>
<b>Troubleshooting</b> .....	<b>63</b>
<b>Connecting Pin Assignments</b> .....	<b>64</b>
<b>(RS-232C) Specifications</b>	
<b>and Command Settings</b> .....	<b>65</b>
<b>Computer Compatibility Chart</b> .....	<b>66</b>
<b>Specifications</b> .....	<b>67</b>
<b>Dimensions</b> .....	<b>68</b>
<b>Glossary</b> .....	<b>69</b>
<b>Index</b> .....	<b>70</b>

# IMPORTANT SAFEGUARDS

**ATTENTION:** Please read all of these instructions before you operate your Projector for the first time. Save these instructions for future reference.

For your own protection and prolonged operation of your Projector, be sure to read the following “IMPORTANT SAFEGUARDS” carefully, before use.

This projector has been engineered and manufactured to ensure your personal safety. But IMPROPER USE CAN RESULT IN POTENTIAL ELECTRICAL SHOCK OR FIRE HAZARDS. In order not to defeat the safeguards incorporated into this Projector, observe the following basic rules for its installation, use and servicing.

1. Unplug the Projector from the wall outlet before cleaning.
2. Do not use liquid cleaners or aerosol cleaners. Use a damp cloth for cleaning.
3. Do not use attachments not recommended by the Projector manufacturer, as they may cause hazards.
4. Do not use the Projector near water; for example, near a bathtub, washbowl, kitchen sink, laundry tub, in a wet basement, near a swimming pool, etc. Never spill liquid into the projector.
5. Do not place the Projector on an unstable cart, stand, or table. The Projector may fall, which may cause serious injury to a child or an adult, and/or serious damage to the unit.
6. Wall or Ceiling Mounting—The product should be mounted to a wall or ceiling only as recommended by the manufacturer.
7. Projector equipment and cart combinations should be moved with care. Quick stops, excessive force, and uneven surfaces may cause the equipment and cart combination to overturn. 
8. Slots and openings in the cabinet back and bottom are provided for ventilation. To ensure reliable operation of the Projector and to protect it from overheating, these openings must not be blocked or covered. The openings should never be covered with cloth or other material.
9. This Projector should never be placed near or over a radiator or heating vent. The Projector should not be placed in a built-in installation such as a bookcase unless proper ventilation is provided.
10. The Projector should be operated only from the type of power source indicated on the back of the projector or in the specifications. If you are not sure of the type of power supplied to your home, consult your Projector dealer or local power company.
11. Do not place the Projector where the cord will be abused by persons walking on it.
12. Follow all warnings and instructions marked on the Projector.
13. To prevent damage to the projector due to lightning and power-line surges, unplug the projector from the power outlet, when not in use.
14. Do not overload wall outlets and extension cords with too many products, because this can result in fire or electric shock.
15. Never push objects of any kind into the Projector through the cabinet slots as they may touch high-voltage points or cause a short circuit. This could result in a fire or electric shock.
16. Do not attempt to service the Projector yourself. Opening or removing covers may expose you to dangerous voltage or other hazards. Refer all servicing to qualified service personnel.
17. Unplug the Projector equipment from the wall outlet and refer servicing to qualified service personnel under the following conditions:
  - a. When the power cord or plug is damaged or frayed.
  - b. If liquid has been spilled into the Projector.
  - c. If the Projector has been exposed to rain or water.
  - d. If the Projector does not operate normally when you follow the operating instructions. Adjust only those controls that are covered by the operating instructions, as improper adjustment of other controls may cause damage and will often require extensive work by a qualified technician to restore the Projector to normal operation.
  - e. If the Projector has been dropped or the cabinet has been damaged.
  - f. When the Projector exhibits a distinct change in performance—this indicates a need for service.
18. When replacement parts are required, be sure the service technician has used replacement parts specified by the manufacturer that have the same characteristics as the original parts. Unauthorised substitutions may result in fire, electric shock, or other hazards.

19. This Projector is provided with one of the following types of plugs. If the plug should fail to fit into the power outlet, please contact your electrician.  
Do not defeat the safety purpose of the plug.
- a. Two-wire type mains plug.
  - b. Three-wire grounding type mains plug with a grounding terminal.  
This plug will only fit into a grounding type power outlet.

- Digital Light Processing, DLP, Digital Micromirror Device and DMD are trademarks of Texas Instruments.
- Microsoft and Windows are registered trademarks of Microsoft Corporation in the United States and/or other countries.
- PC/AT is a registered trademark of International Business Machines Corporation in the United States.
- Macintosh is a registered trademark of Apple Computer, Inc. in the United States and/or other countries.
- All other company or product names are trademarks or registered trademarks of their respective companies.



## IMPORTANT SAFEGUARDS

### Be sure to read the following safeguards when setting up your projector.

#### Caution concerning the lamp unit

- There is a potential hazard of glass particles if the lamp ruptures. In case of lamp rupture, contact your nearest Sharp Authorised Projector Dealer or Service Centre for replacement.

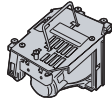

See "Replacing the Lamp" on page 59.

#### Cautions concerning the setup of the projector

- For minimal servicing and to maintain high image quality, SHARP recommends that this projector be installed in an area free from humidity, dust and cigarette smoke. When the projector is subjected to these environments, the lens and part of filter must be cleaned more often than usual. As long as the projector is properly maintained in this manner, use in these environments will not reduce the overall operation life. Please note that all internal cleaning must be performed by a Sharp Authorised Projector Dealer or Service Centre.

#### Do not set up the projector in places exposed to direct sunlight or bright light.

- Position the screen so that it is not in direct sunlight or room light. Light falling directly on the screen washes out the colours, making viewing difficult. Close the curtains and dim the lights when setting up the screen in a sunny or bright room.

#### Do not subject the projector to hard impact and/or vibration.

- Take care with the lens so as not to hit or damage the surface of the lens.

#### Rest your eyes occasionally.

- Watching the screen for long hours continuously will make your eyes tired. Be sure to occasionally rest your eyes.

#### Do not expose the projector to extreme heat or cold.

- Operating temperature: +5°C to 35°C
- Storage temperature: -20°C to +60°C

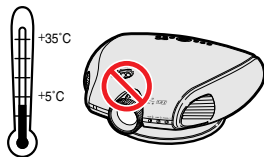

#### Notes on Operation

- The exhaust ventilative holes, the lamp unit cover and adjacent areas may get extremely hot during projector operation. To prevent injury, do not touch these areas until they have sufficiently cooled down.
- Allow at least 30 cm of space between the exhaust ventilative hole and the nearest wall or obstruction.



- If the cooling fan becomes obstructed, a protection device will automatically turn off the projector lamp. This does not indicate a malfunction. Remove the projector power cord from the wall outlet and wait at least 10 minutes. Then turn on the power by plugging the power cord back in. This will return the projector to the normal operating condition.

#### Cautions regarding the transportation of the projector

- When transporting the projector, be sure not to subject it to hard impact and/or vibration, as this can result in damage. Take extra caution with the lens. Before moving the projector, be sure to unplug the power cord from the wall outlet, and disconnect any other cables connected to it.

#### Other connected equipment

- When connecting other audio-visual equipment or a computer to the projector, make the connections AFTER turning off the projector and the equipment to be connected.
- Please read the operation manuals of the projector and the equipment to be connected for instructions on how to make the connections.

#### Temperature monitor function

- If the projector starts to overheat due to setup problems or blockage of the air vents, "X" and "TEMP." will blink in the lower left corner of the picture. If the temperature continues to rise, the lamp will turn off, the temperature warning indicator on the projector will blink, and after a 90-second cooling-off period the projector will enter the standby mode. Refer to "Maintenance Indicators" on page 58 for details.



#### Info

- The cooling fan regulates the internal temperature, and its performance is automatically controlled. The sound of the fan may change during projector operation due to changes in the fan speed. This does not indicate malfunction.

# Quick Guide

In this page, connection of the projector and the video equipment is explained as an example for the procedure from setup to projection. Refer to each page for details.

## Required equipments

Projector

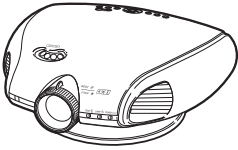

Remote control

- Insert the batteries. (Page 11)

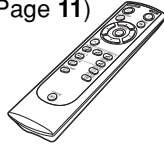

Power cord

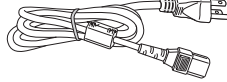

Video equipment

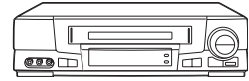

Video cable

1. Place the projector facing a wall or a screen.
2. Connect to video equipment. (Page 16)

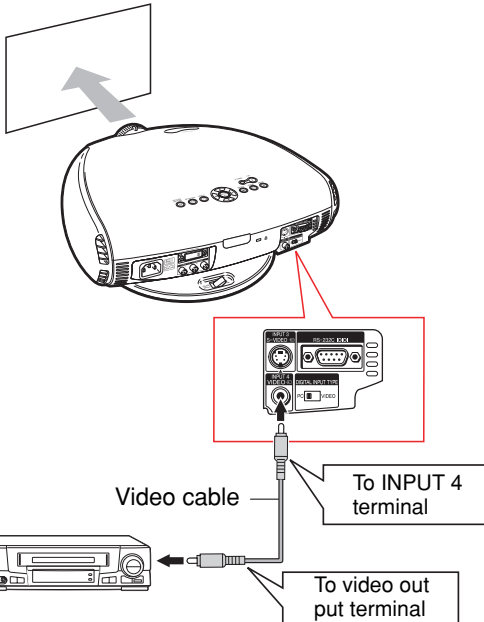

3. Connect the output terminal of the video equipment to the input terminal of the audio equipment using an audio cable.
4. Plug the power cord into the AC socket of the projector and into the wall outlet. (Page 14)

5. Remove the lens cap from the lens.

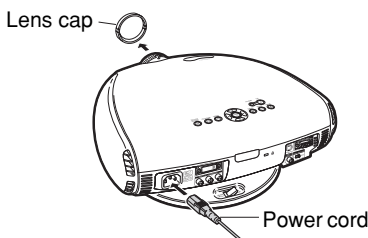

6. Turn the projector on using **ON** on the remote control. (Page 30)

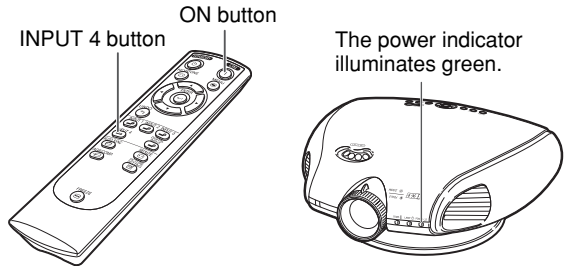

7. Press **INPUT 4** on the remote control to select the INPUT 4 mode. (Page 31)

### ▼ On-screen Display



8. Turn on the video equipment.

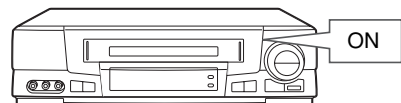

9. Play the video.

10. Adjust the image size, image position and the focus. (Page 25)

Adjust the zooming by moving the zoom knob. Adjust the height of the image by rotating the lens shift dial.

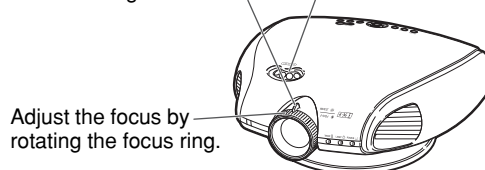

### Note

- This projector can also be connected to a computer as well as to video equipment. (Page 21)

# Part Names

Numbers in **■** refer to the main pages in this operation manual where the topic is explained.

## Projector (Front and Top View)

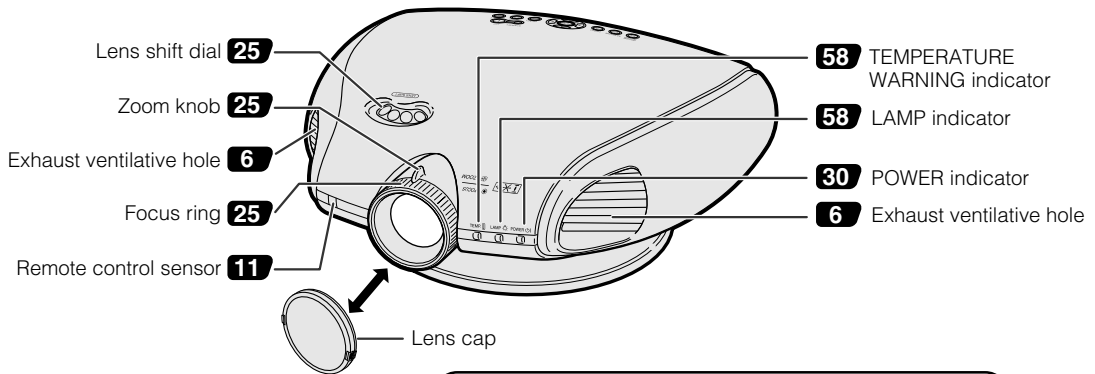

### Attaching the Lens Cap

The lens cap can be attached to the projector using commercially available straps (for cellular phones etc.), as shown in the figure.

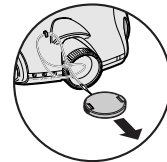

## Projector (Side and Rear View)

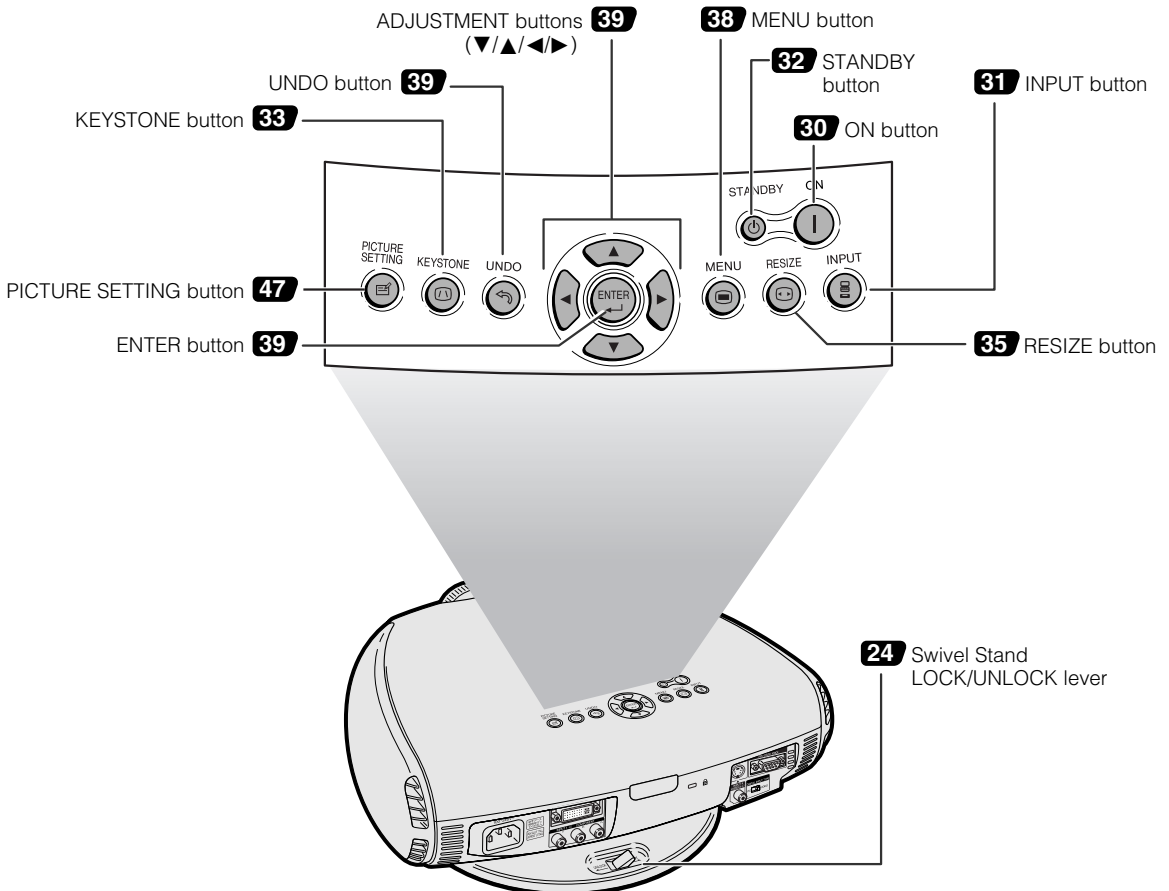

# Projector (Rear View)

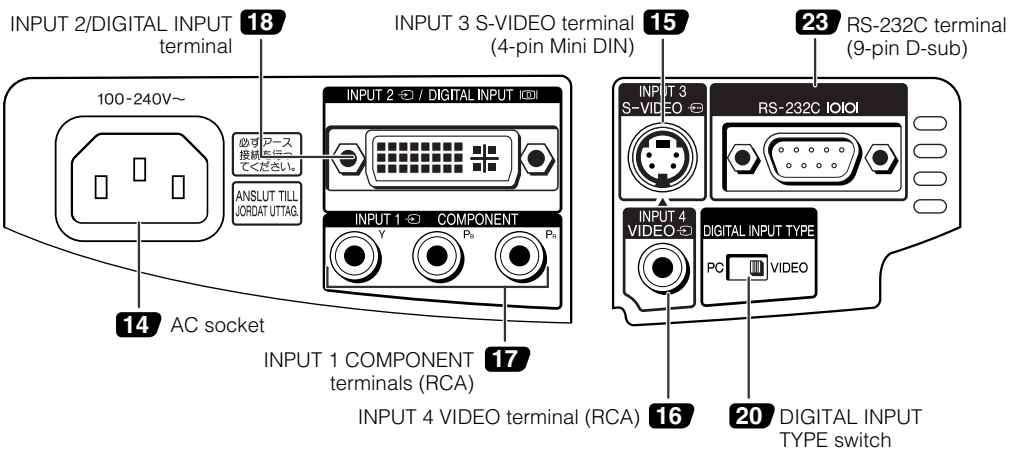
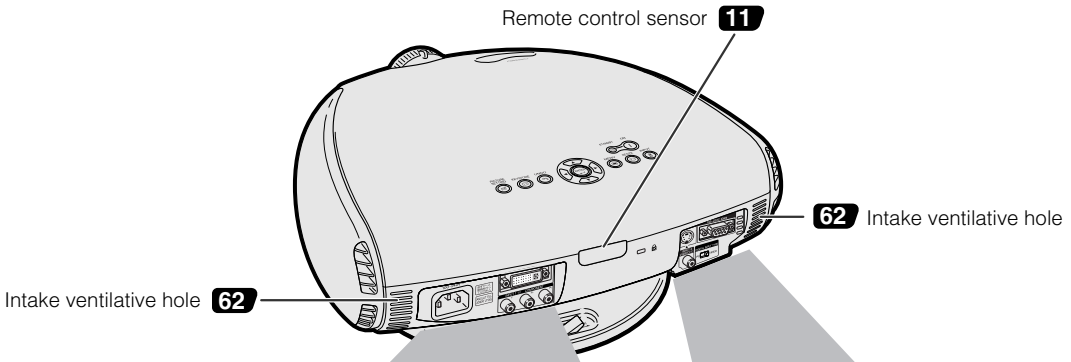

**Using the Terminal Cover**  
 When the projector is used on a desktop, high mounted or ceiling mounted, attach the terminal cover (supplied) to hide the connecting cables.

**Attaching the Terminal Cover**

- ① Align with the tabs on the projector and then press the terminal cover in the direction of the arrow.
- ② Tighten the two screws on the bottom of the projector.

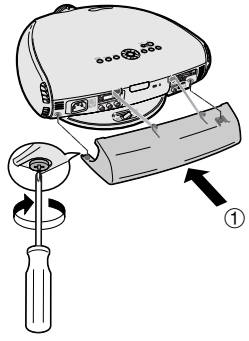

② Tighten the screws

**Removing the Terminal Cover**

- ① Loosen the two screws on the bottom of the projector.
- ② Raise the terminal cover and pull it out in the direction of the arrow.

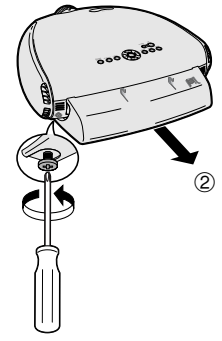

① Loosen the screws



# Part Names

## Remote Control (Front View)

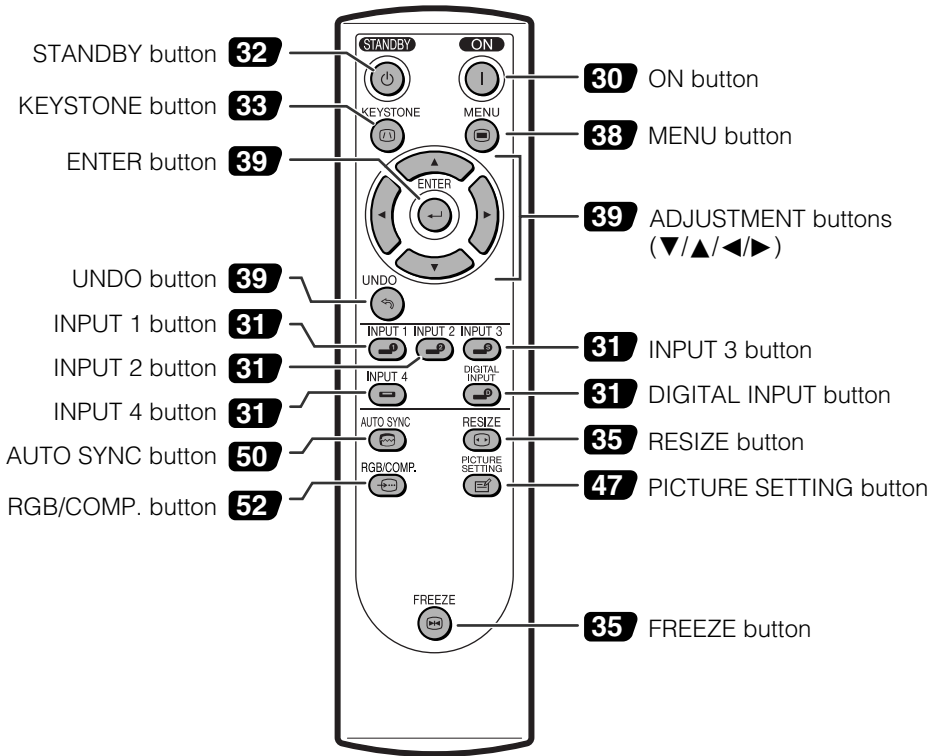

## Remote Control (Top View)

Remote control signal transmitters

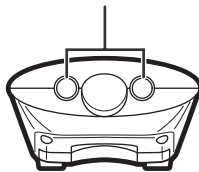

# Operating the Remote Control

## Available Range of the Remote Control

- The remote control can be used to control the projector within the ranges shown in the illustration.

### Note

- The signal from the remote control can be reflected off a screen for easy operation. However, the effective distance of the signal may differ due to the screen material.

### When using the remote control:

- Be sure not to drop, or expose to moisture or high temperature.
- The remote control may malfunction under a fluorescent lamp. Under that circumstance, move the projector away from the fluorescent lamp.

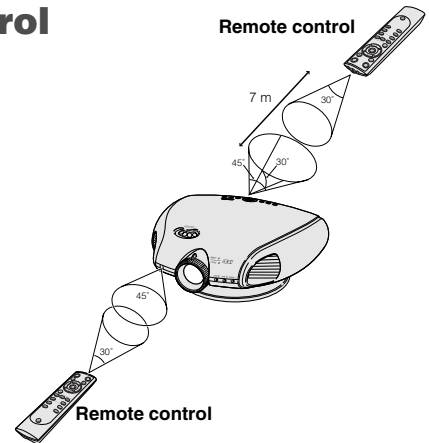

## Inserting the Batteries

The batteries (two “AA” size) are included in the package.

- 1 Pull down the tab on the cover and remove the cover towards the direction of the arrow.**

- 2 Insert the included batteries.**
  - Insert the batteries making sure the polarities correctly match the  $\oplus$  and  $\ominus$  marks inside the battery compartment.

- 3 Insert the lower tab of the cover into the opening, and lower the cover until it clicks in place.**

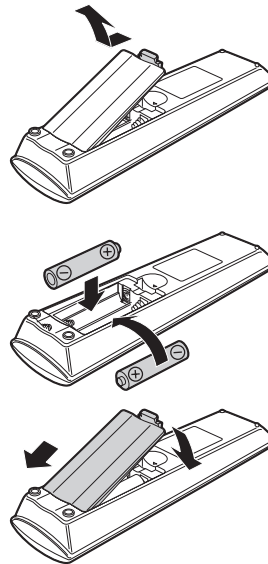

**Incorrect use of the batteries may cause them to leak or explode. Please follow the precautions below.**

### ⚠ Caution

- Insert the batteries making sure the polarities correctly match the  $\oplus$  and  $\ominus$  marks inside the battery compartment.
- Batteries of different types have different properties, therefore do not mix batteries of different types.
- Do not mix new and old batteries.  
This may shorten the life of new batteries or may cause old batteries to leak.
- Remove the batteries from the remote control once they have run out, as leaving them can cause them to leak. Battery fluid from leaked batteries is harmful to your skin, therefore be sure to first wipe them and then remove them using a cloth.

- The batteries included with this projector may exhaust over a short period, depending on how they are kept. Be sure to replace them as soon as possible with new batteries when they have run out.
- Remove the batteries from the remote control if you will not be using the remote control for a long time.

# Accessories

## Supplied accessories

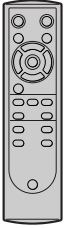

Remote control



Two AA size batteries

## Power cord

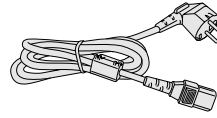

(For Europe except U.K.)

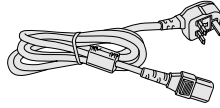

(For U.K., Hong Kong and Singapore)

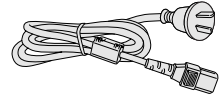

(For Australia and New Zealand)



### Note

- Depending on the region, projectors are shipped with only one power cord (see above). Use the power cord that corresponds to the wall outlet in your country.

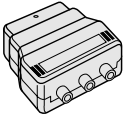

21 pin RCA conversion adaptor  
(Supplied for Europe only)

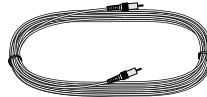

Video cable

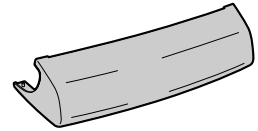

Terminal cover

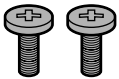

Screws for terminal cover

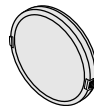

Lens cap

Projector Operation manual

## Optional accessories

3 RCA to 15-pin D-sub cable (3.0 m)  
DVI to 15-pin D-sub adaptor (20 cm)  
DVI cable (3.0 m)

AN-C3CP  
AN-A1DV  
AN-C3DV



### Note

- Some of the cables may not be available depending on the region. Please check with your nearest Sharp Authorised Projector Dealer or Service Centre for replacement.

# Connections and Setup

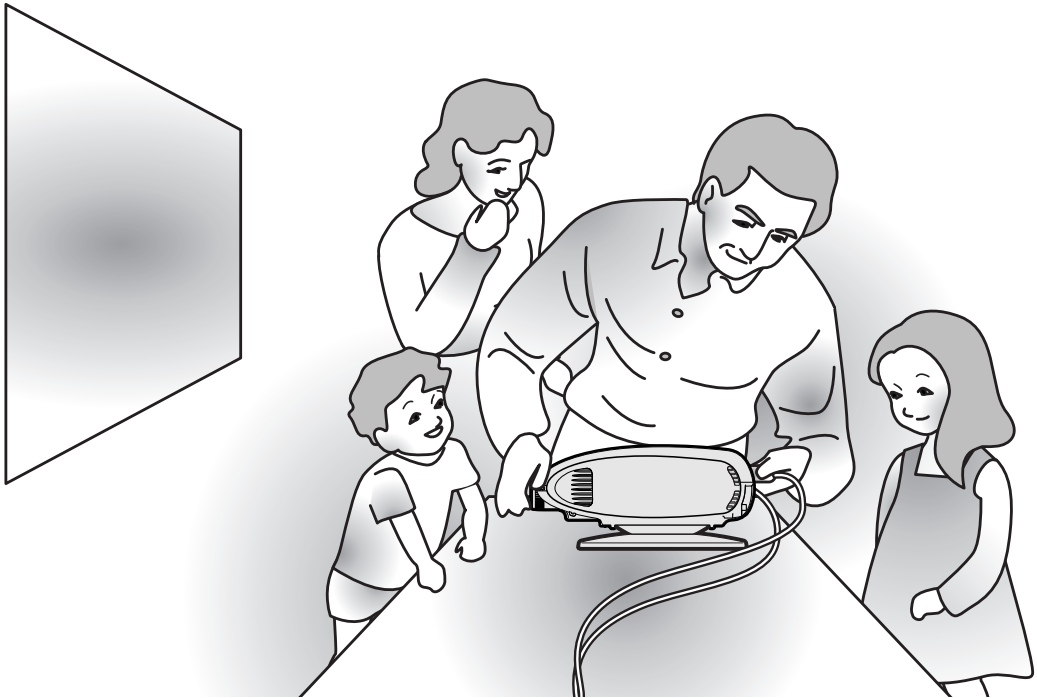



# Connecting the Projector to Other Devices

## Before Connecting



Note

- Before connecting, be sure to unplug the power cord of the projector from the AC outlet and turn off the devices to be connected. After making all connections, turn on the projector and then the other devices.  
When connecting a computer, be sure that it is the last device to be turned on after all the connections are made.
- Be sure to read the operation manuals of the devices to be connected before making connections.

### This projector can be connected to:

#### Video equipment:

- A VCR, DVD player or other video equipment (See page 15.)
- A DVD player or DTV\* decoder (See page 17.)

\*DTV is the umbrella term used to describe the new digital television system in the United States.

#### A computer using:

- DVI to 15-Pin D-sub adapter (See page 21.)
- A DVI cable (See page 22.)
- An RS-232C cable (See page 23.)

## Connecting the Power Cord

Plug in the supplied power cord into the AC socket on the rear of the projector.

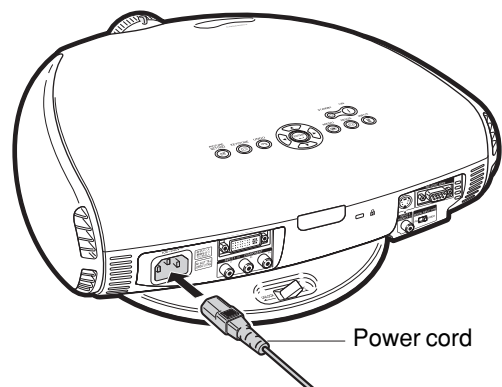

# Connecting to Video Equipment

## Connecting to Video Equipment Using an S-video Cable (INPUT 3)

Using an S-video cable, a VCR, DVD player or other video equipment can be connected to INPUT 3 input terminal.

**1** Connect an S-video cable to the projector.

**2** Connect the S-video cable to the video equipment.

### Note

- The INPUT 3 (S-VIDEO) terminal uses a video signal system in which the picture is separated into color and luminance signals to realize a higher-quality image. To view a higher-quality image, use a commercially available S-video cable to connect the INPUT 3 terminal on the projector and the S-video output terminal on the video equipment.

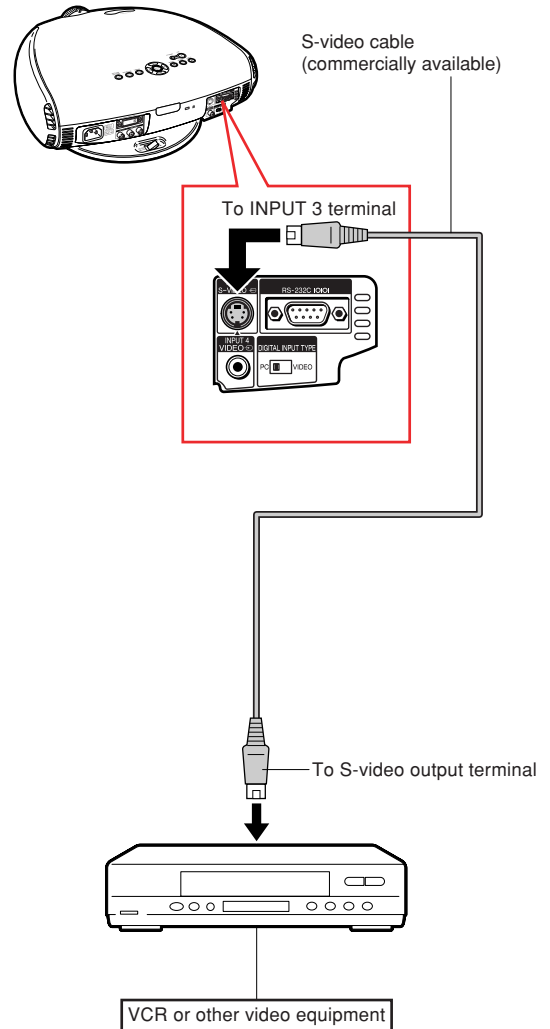

## Connecting the Projector to Other Devices

### Connecting to Video Equipment Using a Composite Video Cable (INPUT 4)

Using a composite video cable, a VCR, DVD player or other video equipment can be connected to INPUT 4 input terminal.

**1** Connect a composite video cable to the projector.

**2** Connect the composite video cable to the video equipment.

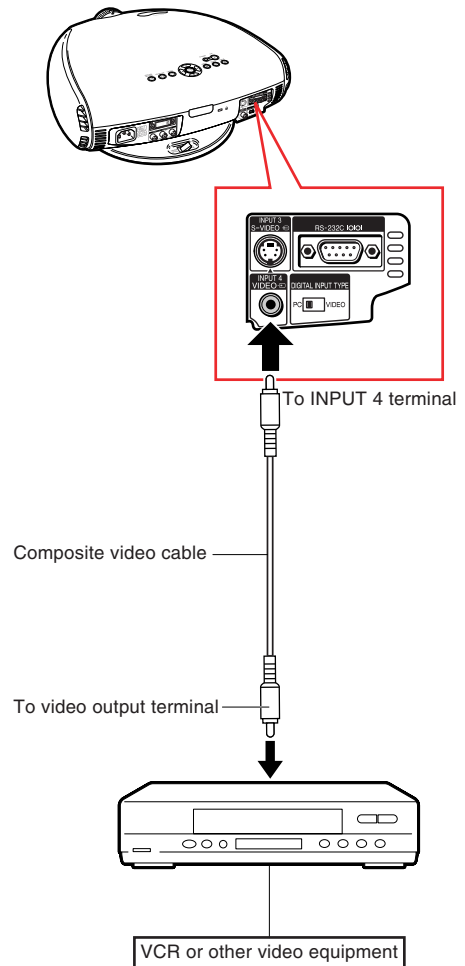

# Connecting to a DVD Player and DTV Decoder

## Connecting to Component Video Equipment Using a Component Cable (INPUT 1)

Use a component cable when connecting component video equipment such as DVD players and DTV decoders to INPUT 1 terminals.

**1** Connect a component cable to the projector.

**2** Connect the above cable to the component video equipment.

### Note

- Make sure to turn both the projector and the video equipment off before connecting.

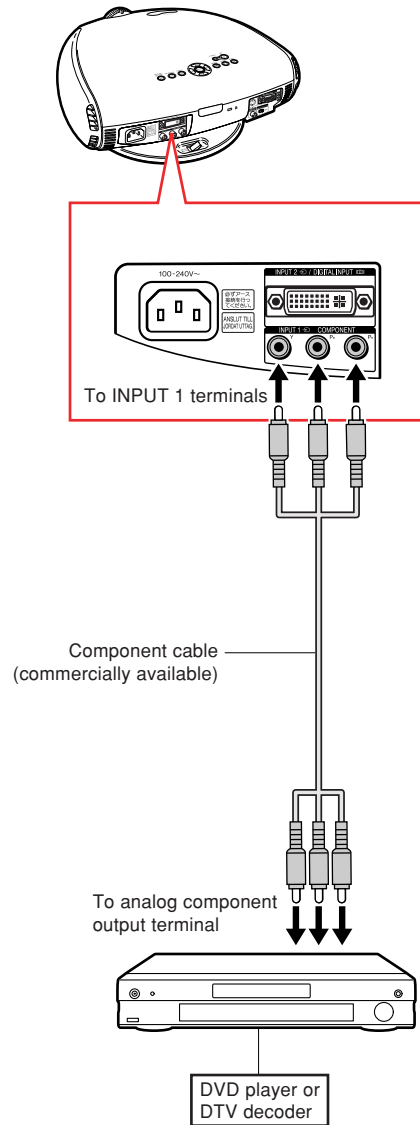

## Connecting the Projector to Other Devices

### Connecting to Component Video Equipment Using a 3 RCA to 15-pin D-sub Cable and the DVI to 15-pin D-sub Adaptor (INPUT 2)

Use a 3 RCA to 15-pin D-sub cable and the DVI to 15-pin D-sub adaptor when connecting component video equipment such as DVD players and DTV decoders to INPUT 2 terminal.

**1** Connect a DVI to 15-pin D-sub adaptor to the projector.

**2** Connect a 3 RCA to 15-pin D-sub cable to the above adaptor.

- Secure the connectors by tightening the thumbscrews.

**3** Connect the above cable to the video equipment.

#### Note

- When connecting this projector to component output terminal of the DTV decoder, select "Component" for "Signal Type" on the OSD menu or press **RGB/COMP.** on the remote control. (See page 52.)
- Make sure to turn both the projector and the video equipment off before connecting.

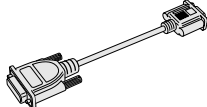
Optional accessories		3 RCA to 15-pin D-sub cable Type: AN-C3CP (3.0 m)
		DVI to 15-pin D-sub adaptor Type: AN-A1DV (20 cm)

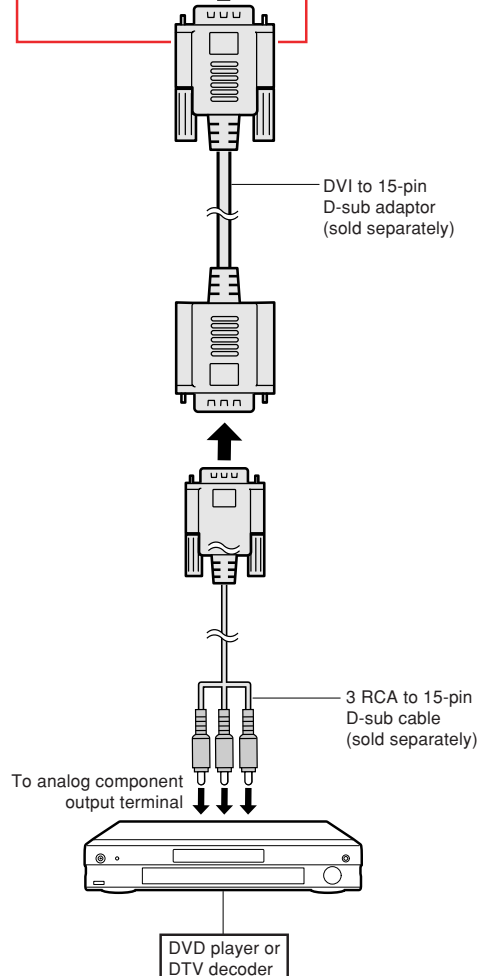
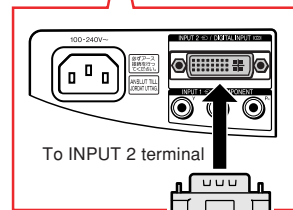
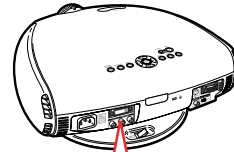

## Connecting to RGB Video Equipment Using the DVI to 15-pin D-sub Adaptor and the RGB Cable (INPUT 2)

Use the DVI to 15-pin D-sub adaptor and the RGB cable when connecting RGB video equipment such as DVD players and DTV decoders to INPUT 2 terminal.

- 1** Connect a DVI to 15-pin D-sub adaptor to the projector.
- 2** Connect the above adaptor to an RGB cable.
- 3** Connect the above cable to the video equipment.

- Secure the connectors by tightening the thumbscrews.

### Note

- When connecting this projector to DVI output of the DTV decoder, select "RGB" for "Signal Type" on the OSD menu or press  on the remote control. (See page 52.)

Optional accessory

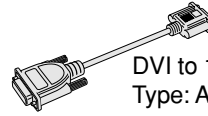

DVI to 15-pin D-sub adaptor  
Type: AN-A1DV (20 cm)

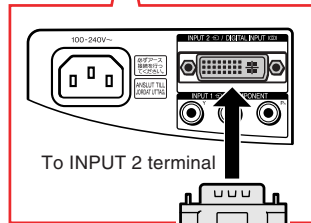
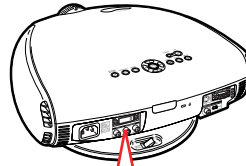

To INPUT 2 terminal

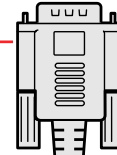

DVI to 15-pin  
D-sub adaptor  
(sold separately)

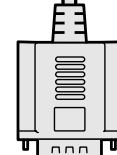

RGB cable  
(commercially  
available)

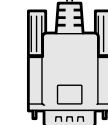
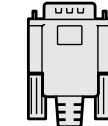

To RGB output terminal

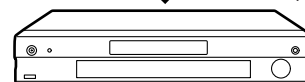

DVD player or  
DTV decoder

## Connecting the Projector to Other Devices

### Connecting to Video Equipment with the DVI Output Terminal Using a DVI Cable (DIGITAL INPUT)

Use the DVI cable when connecting video equipment with the DVI output terminal such as DVD players and DTV decoders to DIGITAL INPUT terminal.

**1** Slide the “DIGITAL INPUT TYPE” switch on the back terminal board to “VIDEO”.

**2** Connect the DVI cable to the DIGITAL INPUT terminal.

**3** Connect the other end to the corresponding terminal on the DVD player or DTV decoder.

- Secure the connectors by tightening the thumbscrews.

#### Note

- Select DIGITAL INPUT mode when connecting to video equipment with the digital output terminal. (See page 31.)
- Make sure to turn both the projector and the video equipment off before switching the “DIGITAL INPUT TYPE” switch and connecting.

Optional  
accessory

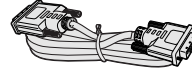

DVI cable  
Type: AN-C3DV  
(3.0 m)

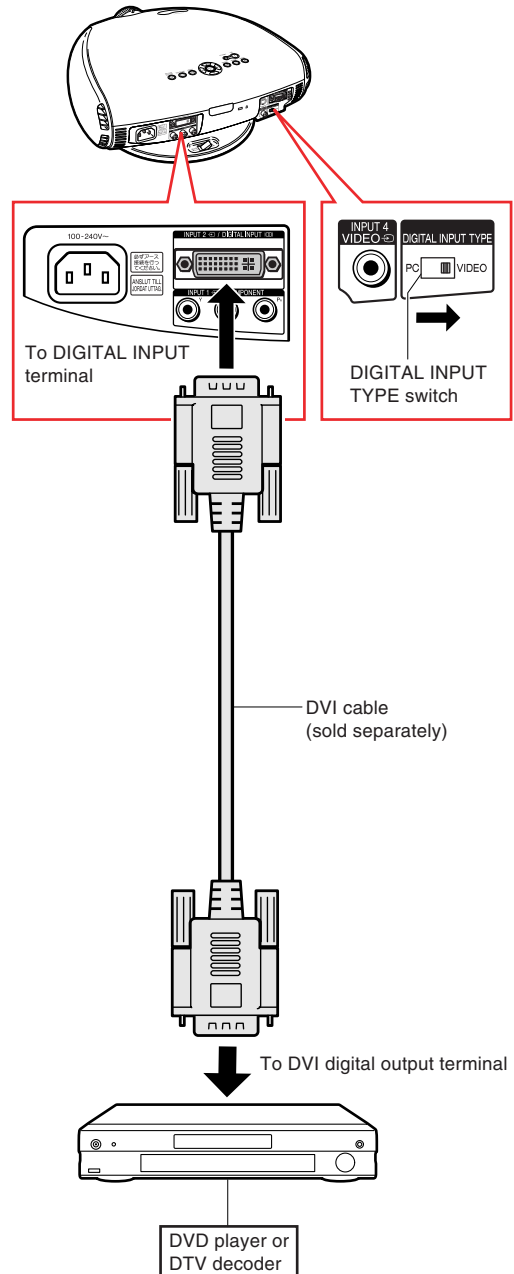

# Connecting to a Computer

## Connecting to a Computer Using the DVI to 15-pin D-sub Adaptor and the RGB Cable (INPUT 2)

- 1** Connect a DVI to 15-pin D-sub adaptor to the projector.
- 2** Connect the above adaptor to an RGB cable.
- 3** Connect the above cable to the computer.

- Secure the connectors by tightening the thumbscrews.

### Note

- Refer to "Computer Compatibility Chart" on page 66 for a list of computer signals compatible with the projector. Use with computer signals other than those listed may cause some of the functions not to work.
- When connecting the projector to a computer in this way, select "RGB" for "Signal Type" on the OSD menu or press  on the remote control. (See page 52.)
- A Macintosh adaptor may be required for use with some Macintosh computers. Contact your nearest Sharp Authorised Projector Dealer or Service Centre.
- Depending on the computer you are using, an image may not be projected unless the signal output setting of the computer is switched to the external output. Refer to the computer operation manual for switching the computer signal output settings.

Optional accessory

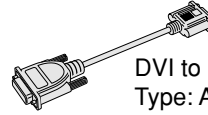

DVI to 15-pin D-sub adaptor  
Type: AN-A1DV (20 cm)

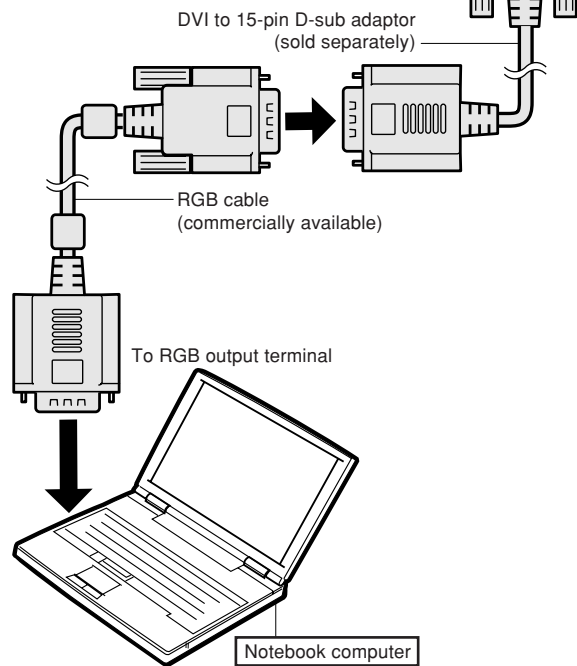
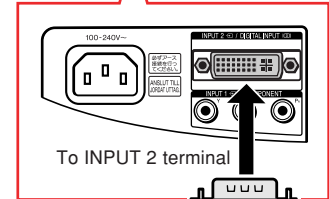
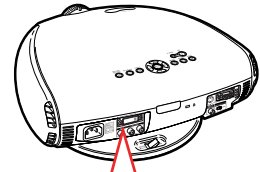

## Connecting the thumbscrew cables

- Connect the thumbscrew cable making sure that it fits correctly into the terminal. Then, firmly secure the connectors by tightening the screws on both sides of the plug.
- Do not remove the ferrite core attached to the RGB cable.

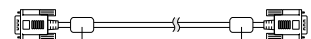
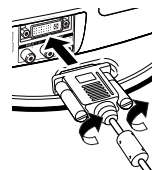

Ferrite core



## Connecting the Projector to Other Devices

### Connecting to a computer with DIGITAL RGB output Terminal (DIGITAL INPUT)

- 1 Slide the “DIGITAL INPUT TYPE” switch on the back terminal board to “PC”.
- 2 Connect a DVI cable to the projector.
- 3 Connect the above cable to the computer.

- Secure the connectors by tightening the thumbscrews.

#### Note

- Select DIGITAL INPUT mode when connecting to digital output terminal of the computer. (See page 31.)
- Before switching the “DIGITAL INPUT TYPE” switch and connecting, be sure to unplug the power cord of the projector from the AC outlet and turn off the computer to be connected. After making all connections, turn on the projector and then the computer.
- Be sure that the computer is the last device to be turned on after all the connections are made.

Optional  
accessory

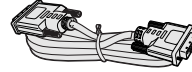

DVI cable  
Type: AN-C3DV  
(3.0 m)

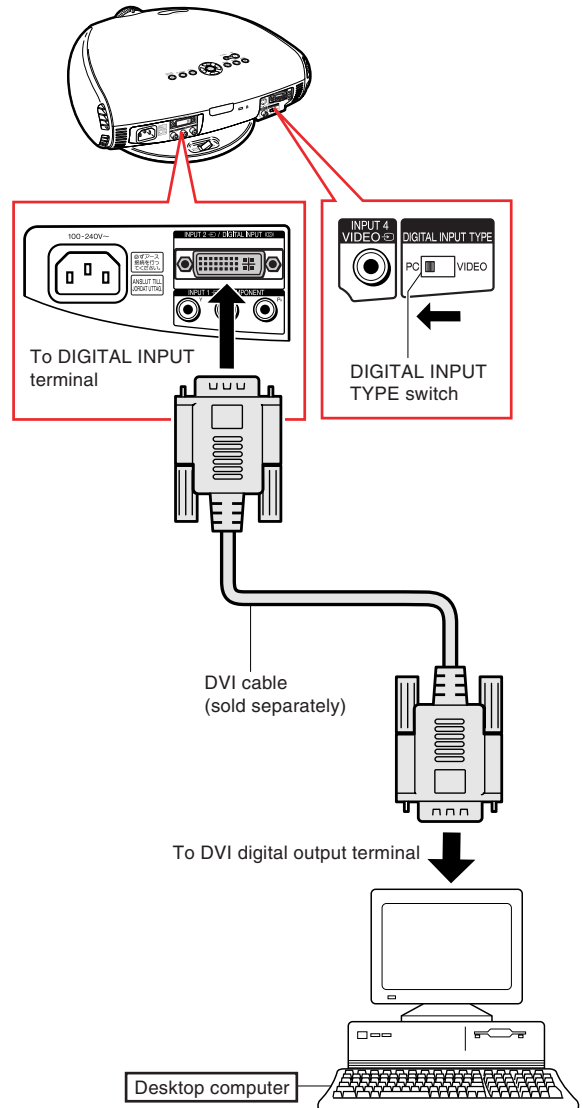

### “Plug and Play” function

- This projector is compatible with VESA-standard DDC 1/DDC 2B. The projector and a VESA DDC compatible computer will communicate their setting requirements, allowing for quick and easy setup.
- Before using the “Plug and Play” function, be sure to turn on the projector first and the connected computer last.

#### Note

- The DDC “Plug and Play” function of this projector operates only when used in conjunction with a VESA DDC compatible computer.

# Controlling the Projector by a Computer

## Controlling the Projector Using an RS-232C Cable

When the RS-232C terminal on the projector is connected to a computer with an RS-232C cable (null modem, cross type, commercially available), the computer can be used to control the projector and check the status of the projector. See page 65 for details.

**1** Connect an RS-232C cable to the projector.

**2** Connect the above cable to the computer.

### Note

- Do not connect or disconnect an RS-232C cable to or from the computer while it is on. This may damage your computer.
- The RS-232C function may not operate if your computer terminal is not correctly set up. Refer to the operation manual of the computer for details.
- Refer to "Computer Compatibility Chart" on page 66 for a list of computer signals compatible with the projector. Use with computer signals other than those listed may cause some of the functions not to work.

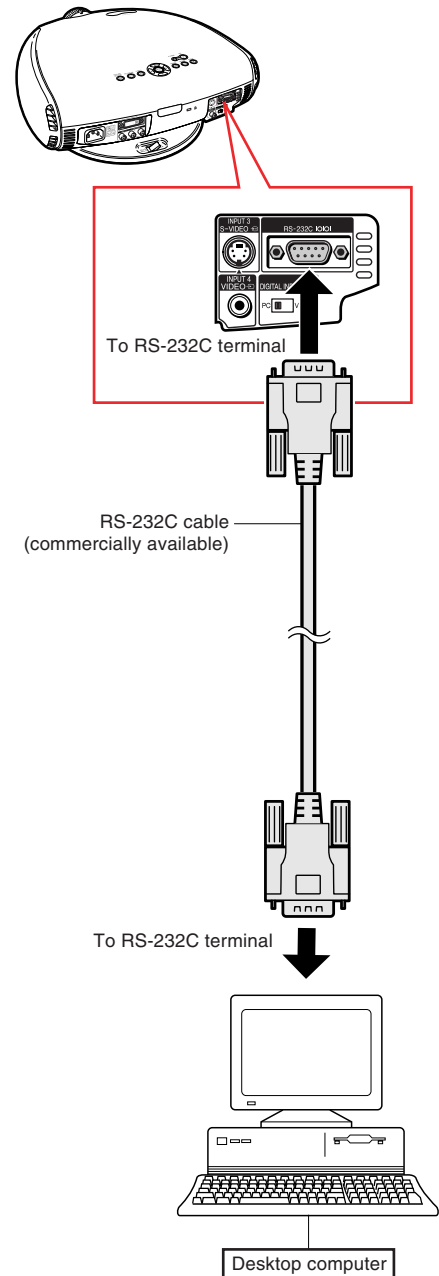

# Setup

## Using the Swivel Stand

You can adjust the angle and direction of the projected image by using the Swivel Stand.

**1** Unlock the lever on the Swivel Stand.

**2** Adjust the angle and direction of the projected image as you want by lifting up the projector and rotating the projector on the Swivel Stand.

### ⚠ Caution

- Do not hold the lens when lifting, lowering or rotating the projector.
- When lowering the projector, be careful not to get your fingers caught in the area between the Swivel Stand and the projector.

### Note

- When the height or direction of the projector is adjusted, the image may become distorted (keystoned), depending on the relative positions of the projector and the screen. See page 33 for details on the keystone correction.

**3** Lock the lever on the Swivel Stand.

## Removing the Swivel Stand

**1** Lift the projector (2) with pressing the removing-stand button on the back of the projector (1).

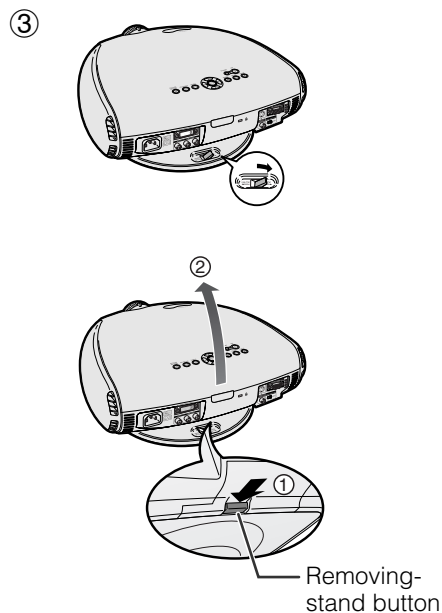
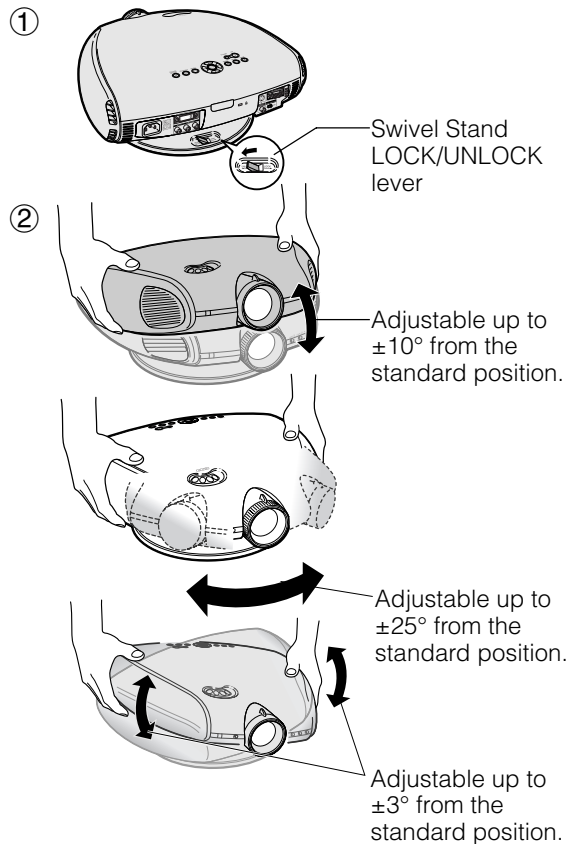

## Attaching the Swivel Stand

- 1** Align the tabs on the front bottom of the projector (①).
- 2** While holding down the button (②), place the projector onto the Swivel Stand (③) to attach.
- 3** Press the projector down firmly to attach it to the Swivel Stand to make sure it is securely attached to the Swivel Stand.

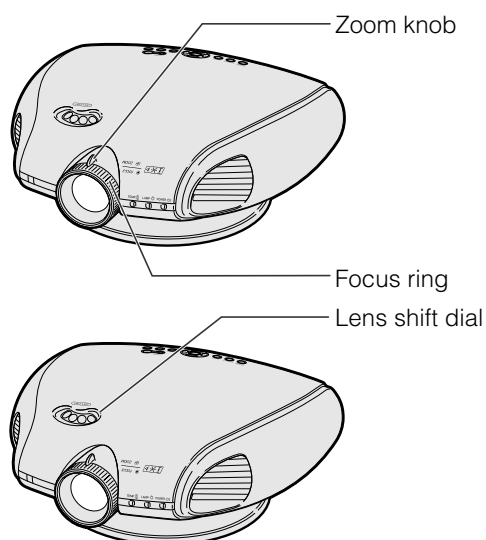
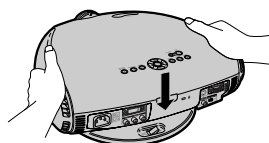
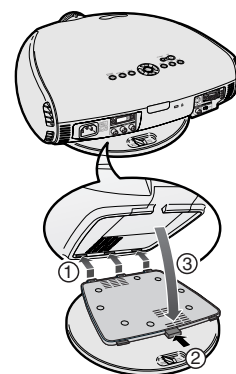

## Focusing and Zooming

The picture can be focused and zoomed in or out by using the Focus ring and the Zoom knob.

- 1** Rotate the Focus ring until the image on the screen comes into focus.
- 2** Slide the Zoom knob. The image can be adjusted to the desired size within the zoom range.

## Using the Lens Shift

The picture can be adjusted within the shift range of the lens by rotating the lens shift dial on the top of the projector using your finger.

### Projected Image

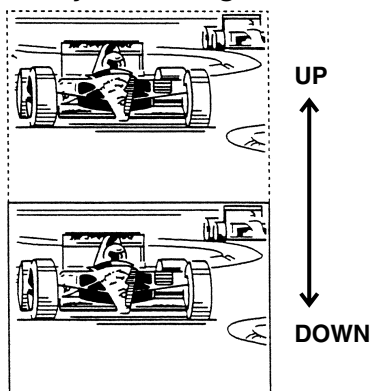

## Adjusting the Projection Distance

- Refer to pages **33** and **34** about the function of Keystone correction and placement of projector using the correction.
- Decide the placement of the projector referring to the figures on the table and the diagram below according to the size of your screen and input signal.

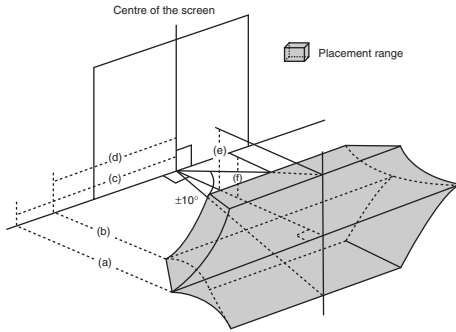

- (a) Maximum projection distance
- (b) Minimum projection distance
- (c) Horizontal placement range when projection distance is maximum.
- (d) Horizontal placement range when projection distance is minimum.
- (e) Vertical placement range when projection distance is maximum.
- (f) Vertical placement range when projection distance is minimum.

### Note

- The aspect ratio of the projected image shifts slightly when the lens shift is at a position other than the top position.
- The aspect ratio of the projected image also shifts slightly when the “H Keystone” and “V Keystone” functions are adjusted simultaneously.
- When adjusting “H Keystone” and “V Keystone” at the same time, the values of adjustable angles for each setting become smaller.
- Keystone correction cannot be applied to On-screen Display.
- When Keystone correction is applied, the resolution of image can be deteriorated to some extent.
- There are errors of  $\pm 3\%$  in the formulas below.

### When using a wide screen (16:9)

In case of displaying the 16:9 picture on the whole of the 16:9 screen.

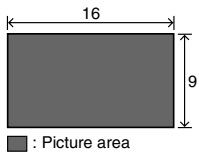

Screen size (16:9)(x)	Projection distance and Keystone correction										
	Diag.	Projection distance (a)	Horizontal Placement range (c)			Vertical placement range (e)	Projection distance (b)	Horizontal Placement range (d)			Vertical placement range (f)
			Composite, S-video 480i/P, 1080i	720P	RGB			Composite, S-video 480i/P, 1080i	720P	RGB	
200" (508cm)	6.4m (20'10")	1.3m (4' 3")	1.5m (4' 11")	1.1m (3' 7")	1.1m (3' 7")	5.3m (17' 4")	0.9m (2' 11")	1.0m (3' 3")	0.7m (2' 4")	0.9m (2' 11")	
150" (381cm)	4.8m (15' 7")	0.9m (2' 11")	1.1m (3' 7")	0.8m (2' 7")	0.8m (2' 7")	3.9m (12' 11")	0.6m (1' 12")	0.7m (2' 4")	0.5m (1' 8")	0.6m (1' 12")	
133" (338cm)	4.2m (13'10")	0.8m (2' 7")	0.9m (2' 11")	0.7m (2' 4")	0.7m (2' 4")	3.5m (11' 6")	0.6m (1' 12")	0.6m (1' 12")	0.4m (1' 4")	0.6m (1' 12")	
106" (269cm)	3.4m (11' )	0.6m (1' 12")	0.7m (2' 4")	0.6m (1' 12")	0.5m (1' 8")	2.8m (9' 1")	0.4m (1' 4")	0.5m (1' 8")	0.3m ( 12")	0.4m (1' 4")	
100" (254cm)	3.2m (10' 4")	0.6m (1' 12")	0.7m (2' 4")	0.5m (1' 8")	0.5m (1' 8")	2.6m (8' 7")	0.4m (1' 4")	0.5m (1' 8")	0.3m ( 12")	0.4m (1' 4")	
92" (234cm)	2.9m (9' 6")	0.5m (1' 8")	0.6m (1' 12")	0.5m (1' 8")	0.5m (1' 8")	2.4m (7' 11")	0.4m (1' 4")	0.4m (1' 4")	0.3m ( 12")	0.4m (1' 4")	
84" (213cm)	2.7m (8' 8")	0.5m (1' 8")	0.6m (1' 12")	0.4m (1' 4")	0.4m (1' 4")	2.2m (7' 2")	0.3m ( 12")	0.4m (1' 4")	0.3m ( 12")	0.3m ( 12")	
72" (183cm)	2.3m (7' 5")	0.4m (1' 4")	0.5m (1' 8")	0.4m (1' 4")	0.4m (1' 4")	1.9m (6' 2")	0.3m ( 12")	0.3m ( 12")	0.2m ( 8")	0.3m ( 12")	
60" (152cm)	1.9m (6' 2")	0.3m ( 12")	0.4m (1' 4")	0.3m ( 12")	0.3m ( 12")	1.6m (5' 1")	0.2m ( 8")	0.3m ( 12")	0.2m ( 8")	0.2m ( 8")	
40" (102cm)	1.2m (4' 1")	0.2m ( 8")	0.2m ( 8")	0.2m ( 8")	0.2m ( 8")	1.0m (3' 4")	0.1m ( 4")	0.1m ( 4")	0.1m ( 4")	0.1m ( 4")	

(a) = (0.031954888x - 0.034060187) x: Screen size (diag.)(in)  
 (b) = (0.026528341x - 0.034646716)

### When using a normal screen (4:3)

In case of setting the 16:9 picture to the full horizontal width of the 4:3 screen.

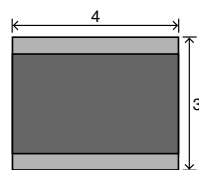

Screen size (4:3)(x)	Projection distance and Keystone correction										
	Diag.	Projection distance (a)	Horizontal Placement range (c)			Vertical placement range (e)	Projection distance (b)	Horizontal Placement range (d)			Vertical placement range (f)
			Composite, S-video 480i/P, 1080i	720P	RGB			Composite, S-video 480i/P, 1080i	720P	RGB	
200" (508cm)	-	-	-	-	-	4.8m (15' 10")	0.8m (2' 7")	0.9m (2' 11")	0.6m (1' 12")	0.8m (2' 7")	
150" (381cm)	4.4m (14' 4")	0.8m (2' 7")	1.0m (3' 3")	0.7m (2' 4")	0.7m (2' 4")	3.6m (11' 10")	0.6m (1' 12")	0.7m (2' 4")	0.5m (1' 8")	0.6m (1' 12")	
100" (254cm)	2.9m (9' 6")	0.5m (1' 8")	0.6m (1' 12")	0.5m (1' 8")	0.5m (1' 8")	2.4m (7' 11")	0.4m (1' 4")	0.4m (1' 4")	0.3m ( 12")	0.4m (1' 4")	
84" (213cm)	2.4m (7' 12")	0.4m (1' 4")	0.5m (1' 8")	0.4m (1' 4")	0.4m (1' 4")	2.0m (6' 7")	0.3m ( 12")	0.4m (1' 4")	0.2m ( 8")	0.3m ( 12")	
72" (183cm)	2.1m (6' 10")	0.4m (1' 4")	0.4m (1' 4")	0.3m ( 12")	0.3m ( 12")	1.7m (5' 8")	0.3m ( 12")	0.3m ( 12")	0.2m ( 8")	0.3m ( 12")	
60" (152cm)	1.7m (5' 8")	0.3m ( 12")	0.4m (1' 4")	0.3m ( 12")	0.3m ( 12")	1.4m (4' 8")	0.2m ( 8")	0.2m ( 8")	0.1m ( 4")	0.2m ( 8")	
40" (102cm)	1.1m (3' 9")	0.2m ( 8")	0.2m ( 8")	0.2m ( 8")	0.2m ( 8")	0.9m (3' 1")	0.1m ( 4")	0.1m ( 4")	0.1m ( 4")	0.1m ( 4")	

(a) = (0.029330688x - 0.039639669) x: Screen size (diag.)(in)  
 (b) = (0.02434978x - 0.034646716)

■ : Screen area  
 ■ : Picture area

## Upper and Lower Lens Shift Position

- This projector is equipped with a lens shift function that lets you adjust the projection height.
- Adjust the projection height to match the setup configuration.
- The screen can be moved maximum the length of one screen vertically using the lens shift.

### Note

- Optimal image quality is produced with the projector positioned perpendicular to the screen with all feet flat and level. Tilting or angling the projector will reduce the effectiveness of the lens shift function.

Screen size: 254 cm

Aspect ratio: 16:9

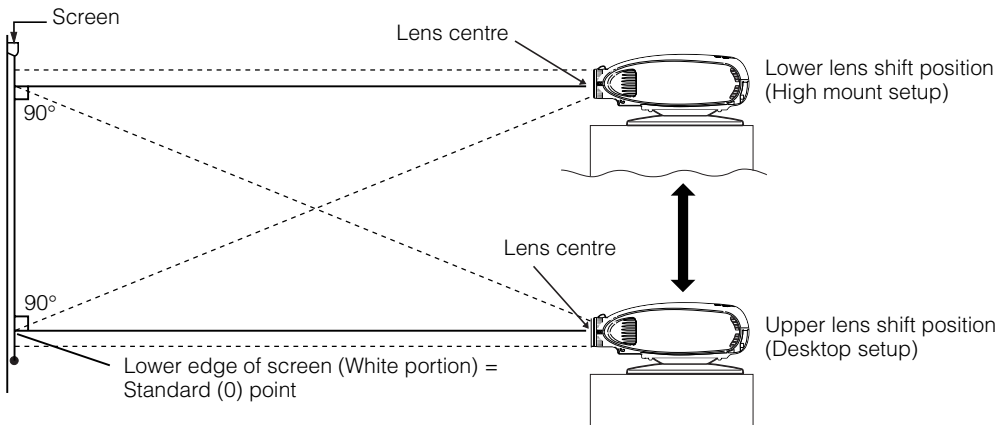

## Upper and Lower Lens Shift Position (Ceiling Mount)

When the projector is in the inverted position, use the upper edge of the screen as the base line, and exchange the lower and upper lens shift values.

Screen size: 254 cm

Aspect ratio: 16:9

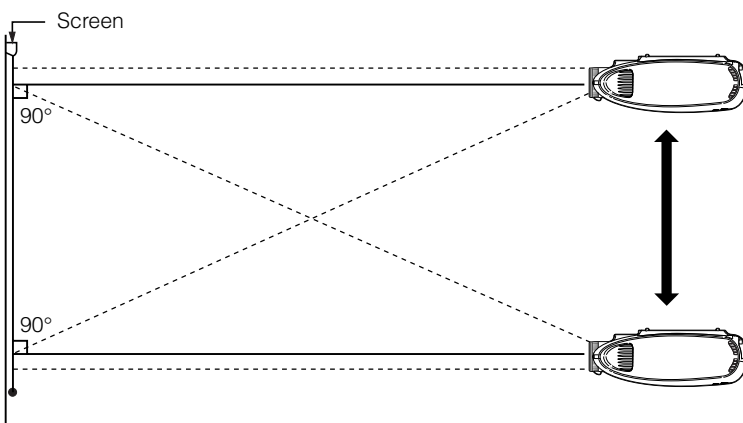

## Image Projection

### Rear Projection

- Place a translucent screen between the projector and the audience.
- Use the projector's menu screen to reverse the projected image. (See page 56 for use of this function.)

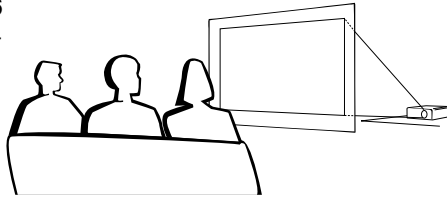

- Optimal image quality can be achieved when the projector is positioned perpendicular to the screen with all feet flat and leveled.

### Projection using a mirror

- Place a mirror (normal flat type) in front of the lens.

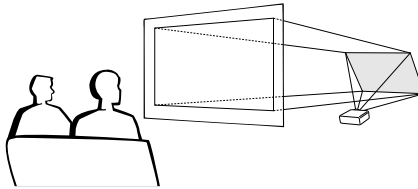

- When using a mirror, be sure to carefully position both the projector and the mirror so the light does not shine into the eyes of the audience.

### Ceiling-mount setup

- It is recommended that you use the optional Sharp ceiling-mount bracket for this installation.
- Before mounting the projector, remove the Swivel Stand. (See pages 24 and 25 for removing and attaching the Swivel Stand.)
- Before mounting the projector, contact your nearest Sharp Authorised Projector Dealer or Service Centre to obtain the recommended ceiling-mount bracket (sold separately). (AN-TK202 ceiling-mount bracket, AN-TK201 extension tube, AN-60KT ceiling adaptors for AN-TK202 or AN-TK201)
- When the projector is in the inverted position, use the upper edge of the screen as the base line.
- Use the projector's menu screen to select the appropriate projection mode. (See page 56 for use of this function.)

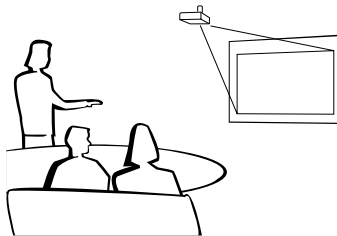

When using the default setting.

#### ▼On-screen Display

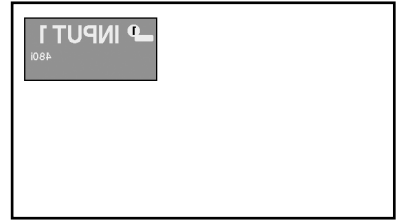

The image is reversed.

When using the default setting.

#### ▼On-screen Display



The image is inverted.

# Basic Operation

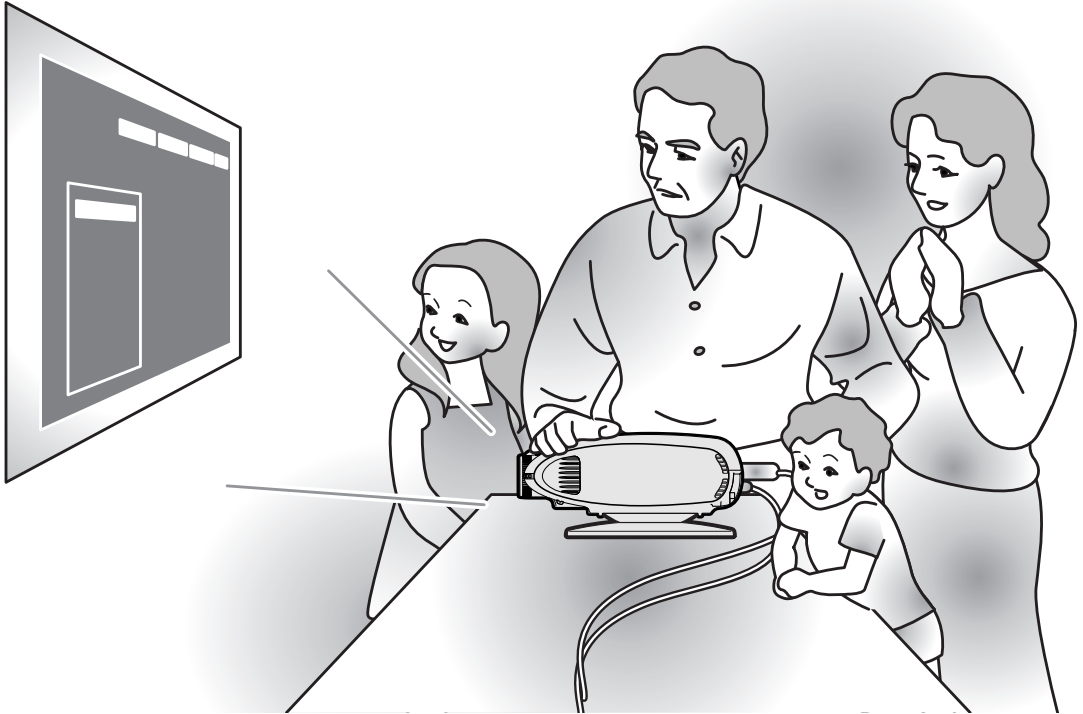



# Image Projection

## Basic Procedure

Connect the required external equipment to the projector before operating the following procedures.

### Info

- The language preset at the factory is English. If you want to change the on-screen display to another language, reset the language according to the procedure on page 31.

## 1 Plug the power cord into the wall outlet.

- The POWER indicator illuminates red, and the projector enters standby mode.

## 2 Press on the remote control or on the projector.

- The blinking green LAMP indicator shows that the lamp is warming up. Wait until the indicator stops blinking before operating the projector.
- If the power is turned off and then immediately turned on again, it may take a short while before the lamp turns on.

### Note

- After the projector is unpacked and turned on for the first time, a slight odour may be emitted from the exhaust ventilative holes. This odour will soon disappear with use.

When the power is on, the LAMP indicator illuminates, indicating the status of the lamp.

**Green:** Lamp is ready.

**Green blinking:** Warming up. / Cooling down.

**Red:** Change the lamp.

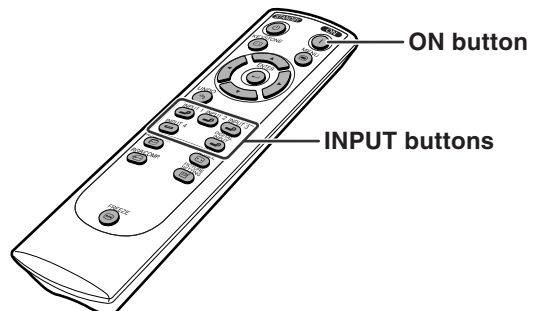
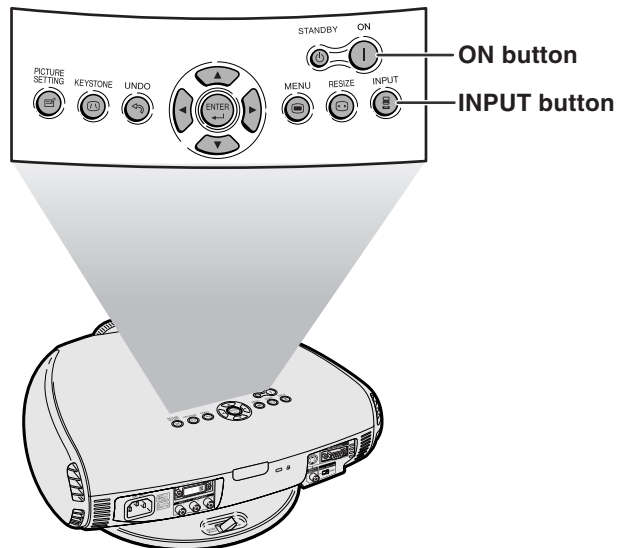
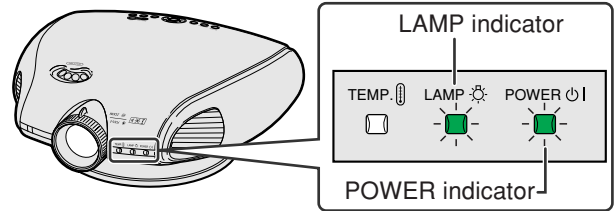

**3** Press , , , or on the remote control or on the projector to select the **INPUT mode**.

- After pressing once on the projector, use to select the desired input mode.

**Note**

- When no signal is received, “NO SIGNAL” will be displayed. When a signal that the projector is not preset to receive is received, “NOT REG.” will be displayed.

**About the INPUT modes**

INPUT 1 (Component)	Used for projecting images from equipment connected to INPUT 1 terminals.
INPUT 2 (Component/RGB)	Used for projecting images from equipment connected to INPUT 2 terminal.
INPUT 3 (S-Video)	Used for projecting images from equipment connected to INPUT 3 terminal.
INPUT 4 (Video)	Used for projecting images from equipment connected to INPUT 4 terminal.
DIGITAL	Used for projecting images from equipment connected to DIGITAL INPUT terminal.

## Selecting the On-screen Display Language

English is the preset language for the On-screen Display; however, this can be changed to German, Spanish, Dutch, French, Italian, Swedish, Portuguese, Chinese, Korean or Japanese.

Display the “Language” menu and select the desired Language.

→For operating the menu screen, see pages 38 to 41.



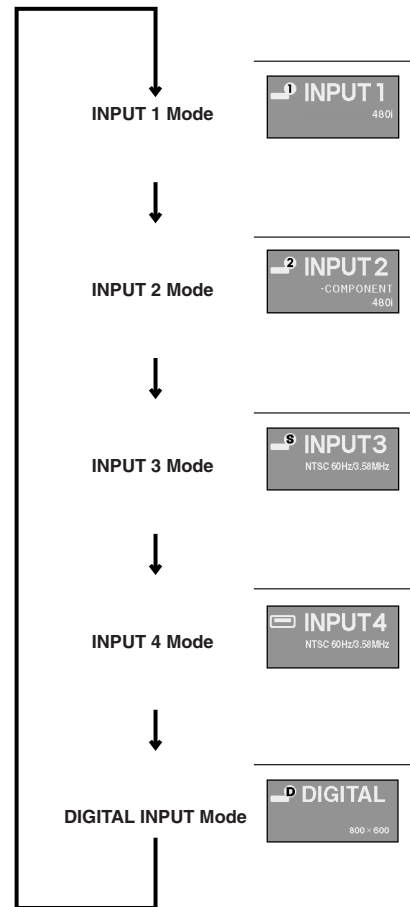

▼On-screen Display (Example)



**On-screen Display**



## Turning the Power off

**1** Press  on the remote control or  on the projector, then press  or  again while the confirmation message is displayed, to put the projector into the standby mode.

- A dimly-lit screen is displayed for a short time to reduce lamp damage.

### Note

- If you accidentally pressed  and do not want to put the projector into the standby mode, wait until the confirmation message disappears.

**2** Unplug the power cord from the AC outlet after the cooling fan stops.

### Info

- Do not unplug the power cord during projection or cooling fan operation. This can cause damage due to the rise in internal temperature, as the cooling fan also stops.
- When connected to equipment such as an amplifier, be sure to turn off the power to the equipment connected first and then to the projector.

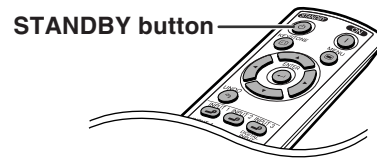
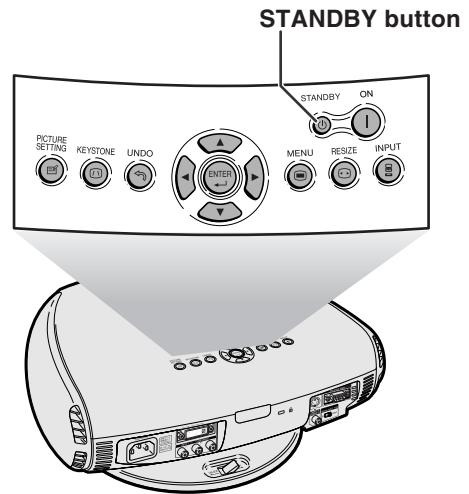

Enter STANDBY mode?

Yes: Press Again. No: Please Wait.



Shutting down. Please wait.

# Keystone Correction

This function can be used to adjust the Keystone settings.

## Note

- For details about using the menu screen, see pages 38 to 41.

**1** Press **KEYSTONE** on the projector or on the remote control.

**2** Press **▲/▼** to select “H Keystone” or “V Keystone”.

Selected Item	Description
H Keystone	Horizontally adjusts the keystone settings.
V Keystone	Vertically adjusts the keystone settings.
Reset	V and H Keystone adjustments are returned to the factory preset settings.

**3** Press **◀/▶** to move the **▀** mark on the selected adjustment item to the desired setting.

## Note

- Straight lines and the edges of the displayed image may appear jagged, when adjusting the Keystone setting.
- When adjusting “H Keystone” and “V Keystone” at the same time, the values of adjustable angles for each setting become smaller.
- The adjustable value of the “V Keystone” becomes extremely small when “H Keystone” is made to be the maximum value.
- Keystone correction is disabled while the picture mode is set to “SMART STRETCH”. (See page 35.)

**4** To return to the normal screen, press **KEYSTONE** again.

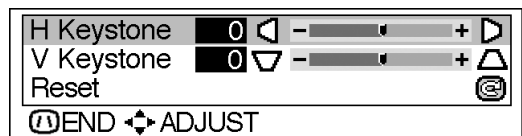
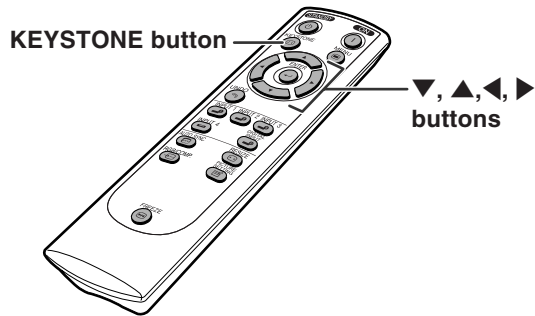
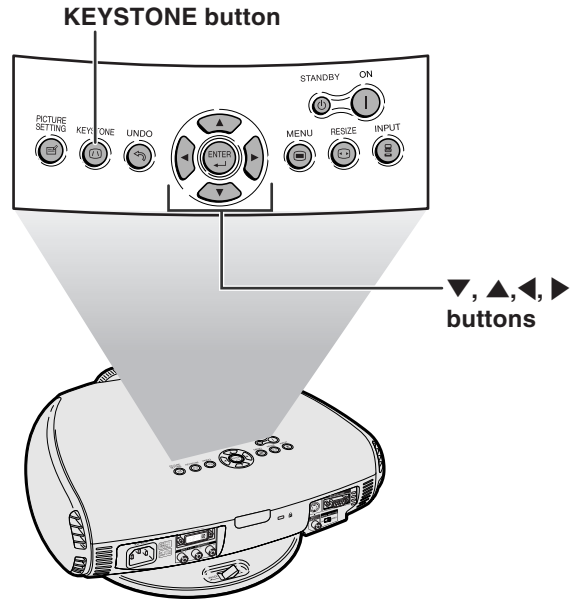

## Horizontal Keystone Correction

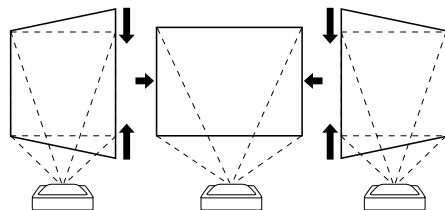

## Vertical Keystone Correction

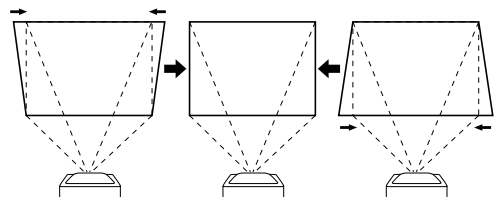

## Placement of the Projected Image Using the Keystone Correction

Place the projector at a distance from the screen that allows images to be projected onto the screen by referring to “Adjusting the Projection Distance” on pages 26 and 27.

- 1** Project the test pattern of the Keystone correction function onto the screen. Rotate the Focus ring until the image on the screen comes into focus. (See page 25.)
- 2** Change the projection angle using the Swivel Stand to properly project images onto the screen. (See page 24).
- 3** Align the edge of the screen closest to the projector with the test pattern by adjusting the zoom and the Swivel Stand. (See pages 24 and 25.)
- 4** Adjust the Keystone function so that the size of the projected image matches the screen size. (See page 33.)
- 5** Align the image on the screen by adjusting the zoom function and the Swivel Stand.
- 6** Adjust the focus so that the projected image is in focus at the centre of the screen. (See page 25.)

### Note

- The aspect ratio of the projected image shifts slightly when the lens shift is at a position other than the top position.
- The aspect ratio of the projected image also shifts slightly when the “H Keystone” and “V Keystone” functions are adjusted simultaneously.

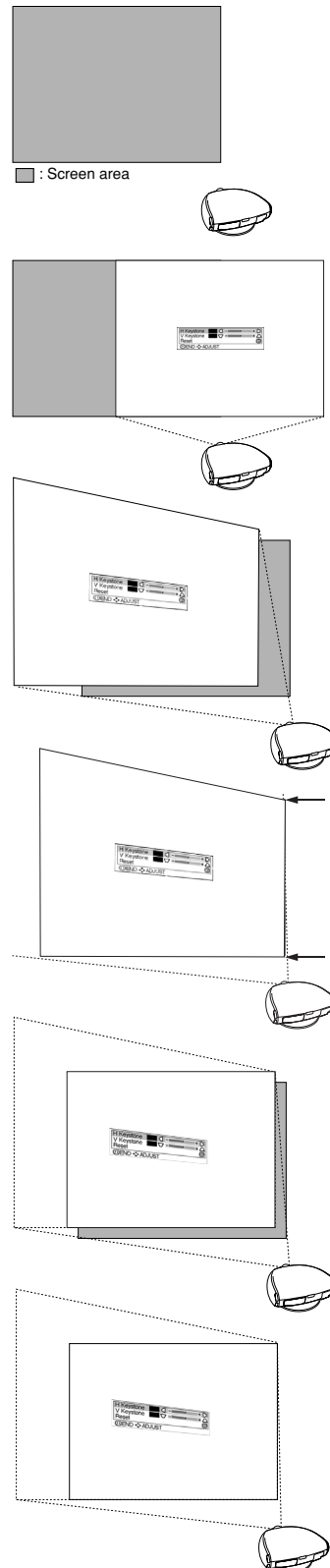

## Freezing a Moving Image

You can instantly freeze a moving image with the remote control.

- 1 Press .
  - The projected image is frozen.

- 2 Press  again to return to the moving image from the currently connected device.

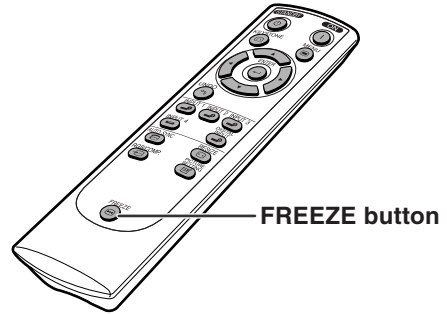

## Adjusting the Picture Aspect Ratio

This function allows you to modify or customize the picture display mode to enhance the input image. Depending on the input signal, you can choose SIDE BAR, SMART STRETCH, CINEMA ZOOM or STRETCH image.

Press . Each time  is pressed, the picture mode changes as shown on the next page.

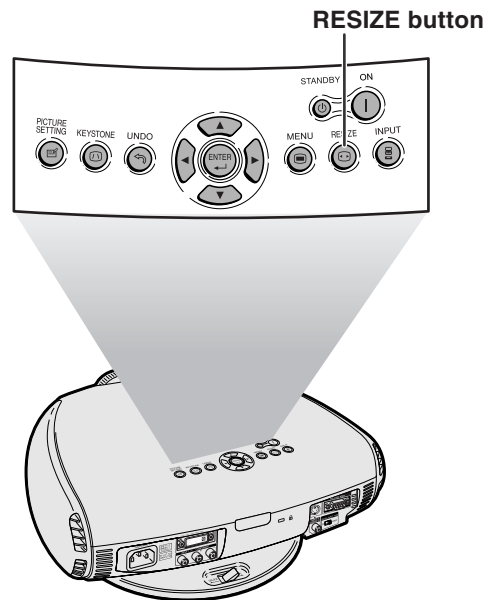

# Image Projection

		SIDE BAR	SMART STRETCH	CINEMA ZOOM	STRETCH
For 4:3 aspect ratio	480I 480P 576I 576P NTSC PAL SECAM	VGA SVGA XGA 768 × 576	1024 × 576	1024 × 576	1024 × 576
For 16:9 aspect ratio	480P	768 × 576	1024 × 576	1024 × 576	1024 × 576
	720P	-	-	-	1024 × 576
	1080I	-	-	-	1024 × 576

- “STRETCH” is fixed when 540P, 720P or 1080I signal is entered.
- “SMART STRETCH” cannot be selected while input signal from a computer (VGA, SVGA or XGA) is entered.

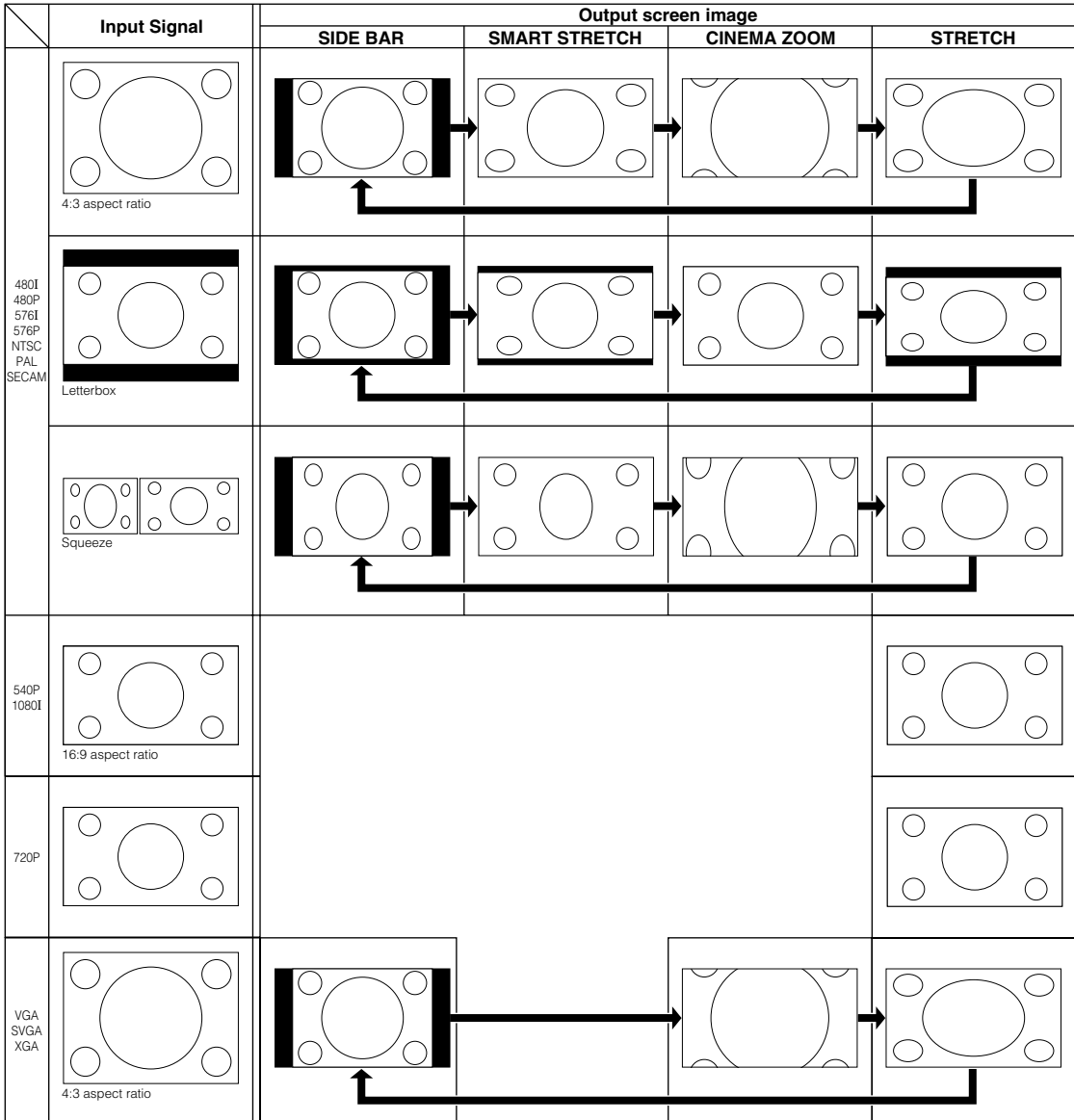

## Note

- “SMART STRETCH” cannot be selected while the Keystone correction (page 33) is being adjusted.
- Keystone correction (page 33) is disabled while the picture mode is set to “SMART STRETCH”.
- 580I/580P is displayed on the screen when signal 576I/576P is input.

# Adjustments and Settings

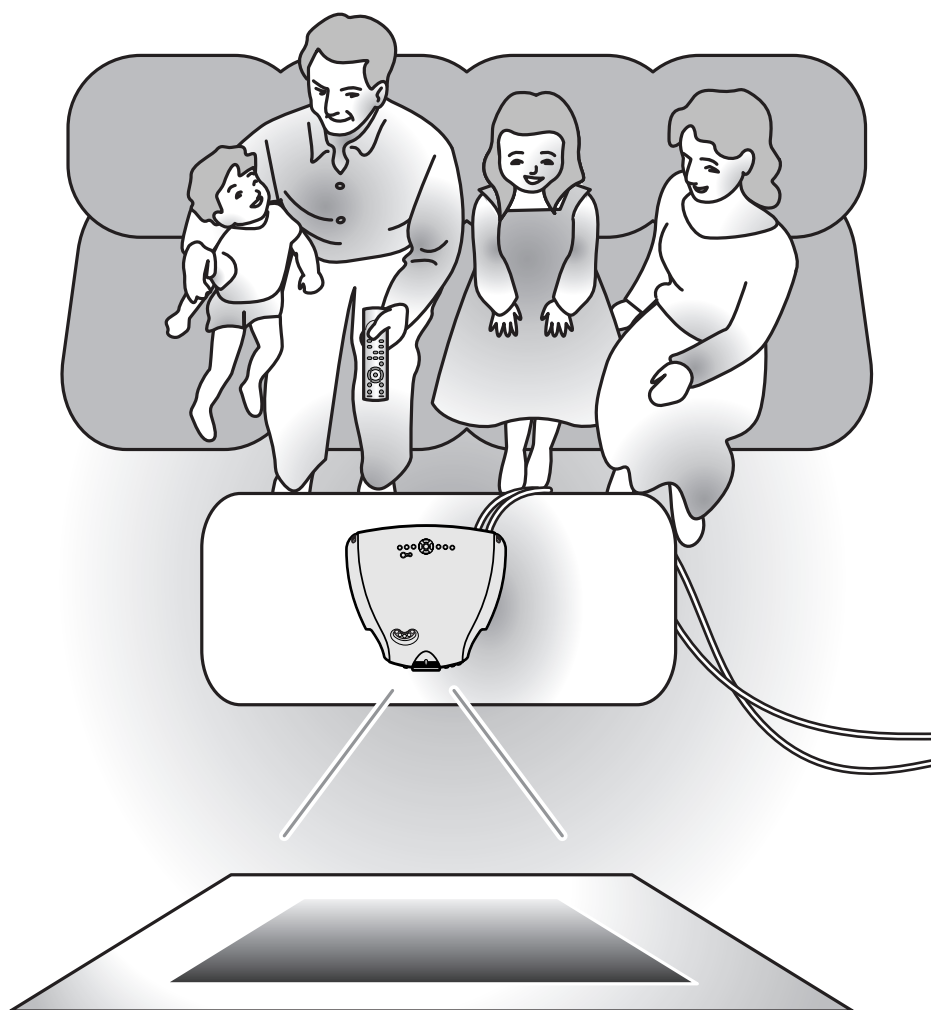



# Using the Menu Screen

The menu screens allow you to adjust the image and various projector settings. The menu can be operated to achieve two functions, adjustment and setting. (For adjusting the menu items, see pages 38 and 39. For setting the menu items, see pages 40 and 41.)

## Menu screen (example)

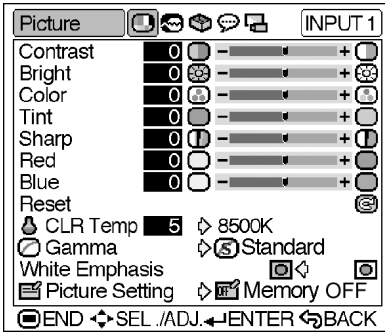

## Menu Selections (Adjustments)

**1** Press .

- The menu screen is displayed.

### Note

- The "Picture" menu screen for the selected input mode is displayed.

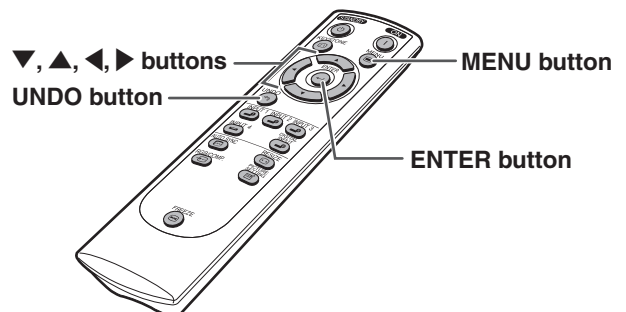
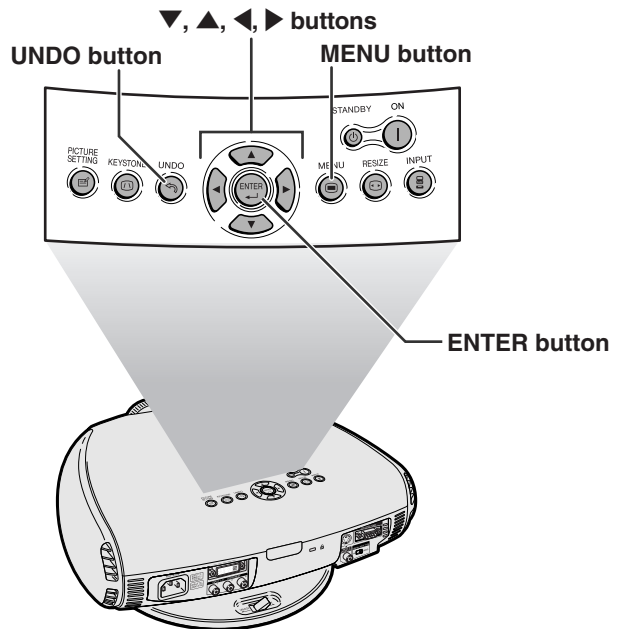

## 2 Press ◀ or ▶ to display the other menu screens.

- The menu icon for the selected menu screen is highlighted.

Menu icon	Menu screen
	Picture
	Fine Sync
	Options
	Language
	PRJ Mode

### Note

- The “Fine Sync” menu is not available for INPUT 3 or 4.
- For items on the menus, see the tree charts on pages 42 and 43.

## 3 Press ▼ or ▲ to select the item you want to adjust.

### Note

- To display a single adjustment item, press after selecting the item. Only the menu bar and the selected adjustment item will be displayed. Then if you press ▼ or ▲, the following item (“Bright” after “Contrast”) will be displayed.
- Press to return to the previous screen.

## 4 Press ◀ or ▶ to adjust the item selected.

- The adjustment is stored.

## 5 Press .

- The menu screen will disappear.

Select the menu icon.

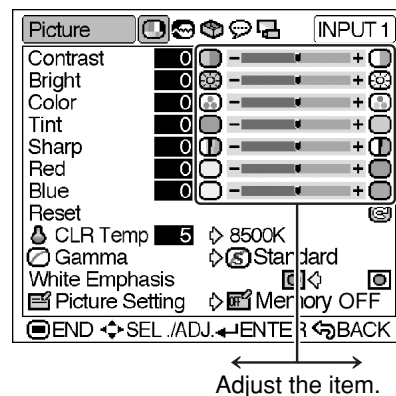
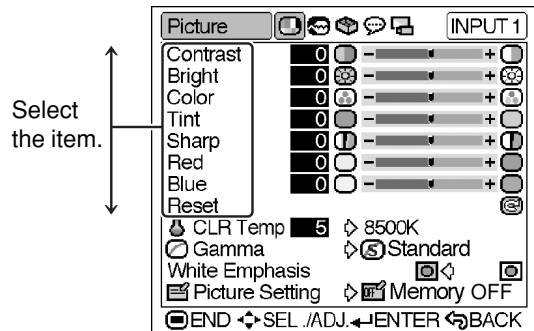
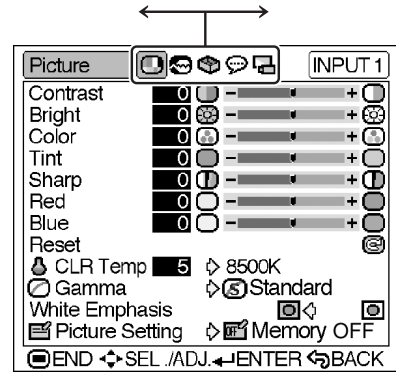

## Menu Selections (Settings)

### 1 Press .





- The menu screen is displayed.

#### Note

- The “Picture” menu screen for the selected input mode is displayed.

### 2 Press or to display the other menu screens.

- The menu icon for the selected menu screen is highlighted.

Menu icon	Menu screen
	Picture
	Fine Sync
	Options
	Language
	PRJ Mode

#### Note

- The “Fine Sync” menu is not available for INPUT 3 or 4.
- For items on the menus, see the tree charts on pages 42 and 43.

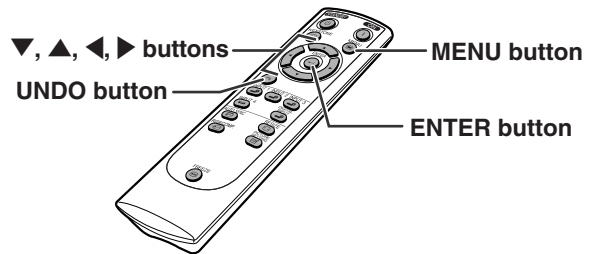
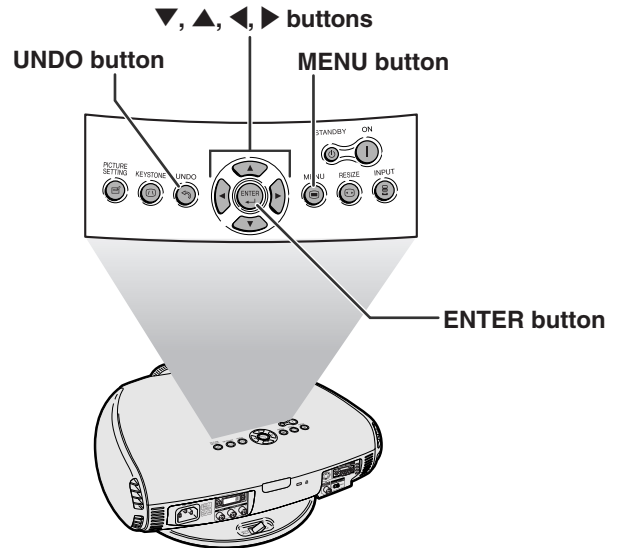

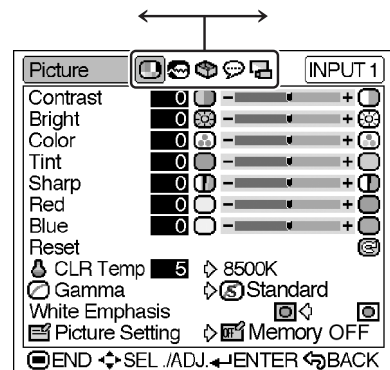

Select the menu icon.



### 3 Press ▼ or ▲ to select the item you want to set.

#### Note

- Press  to return to the previous screen.
- In some menus, select the icon using .

### 4 Press ►.

- The sub menu is displayed.

### 5 Press ▼ or ▲ to select the setting of the item displayed in the sub menu.

### 6 Press .

- The item selected is set.

### 7 Press .

- The menu screen will disappear.

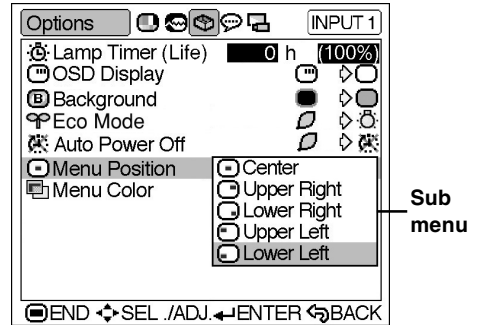
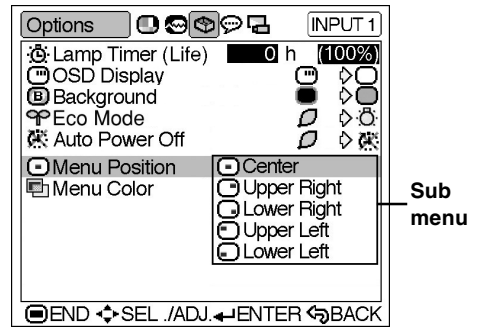
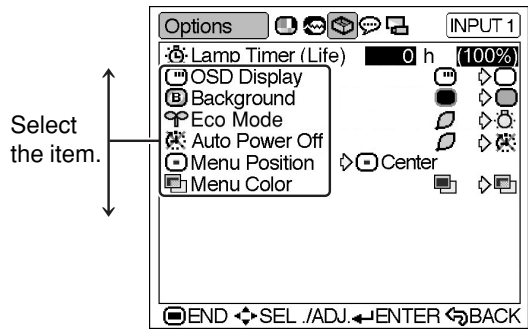

# Menu Bar Items

## INPUT 1 / 2 / DIGITAL INPUT Mode

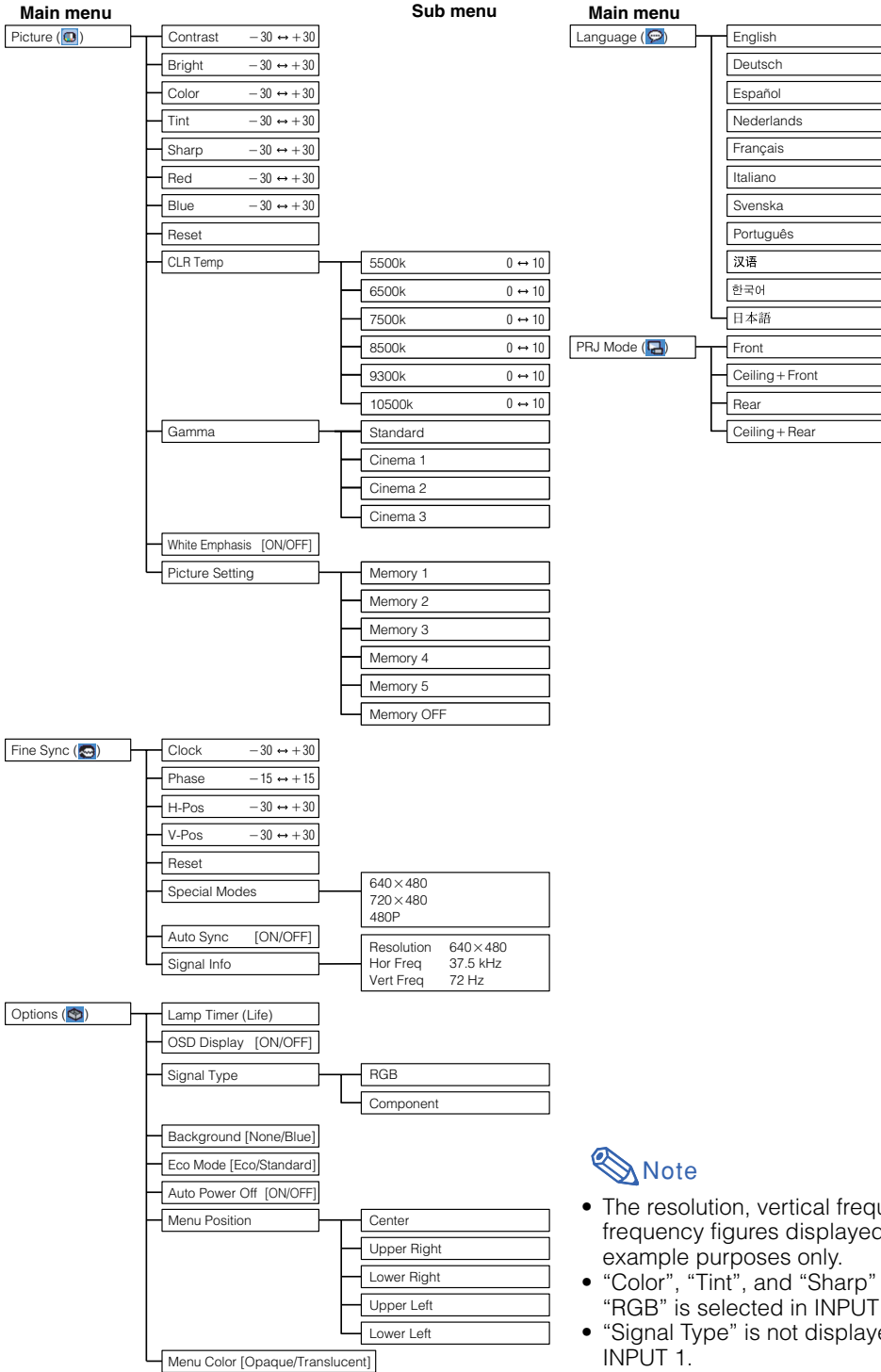

### Note

- The resolution, vertical frequency and horizontal frequency figures displayed above are for example purposes only.
- “Color”, “Tint”, and “Sharp” do not appear when “RGB” is selected in INPUT 2 mode.
- “Signal Type” is not displayed when using INPUT 1.
- “Color”, “Tint”, “Sharp”, “Clock”, “Phase”, “H-Pos”, “V-Pos”, “Special Modes” and “Auto Sync” cannot be used in the DIGITAL INPUT mode.
- “Clock”, “Phase” and “Auto Sync” cannot be used in the Component mode.

## INPUT 3 / 4 Mode

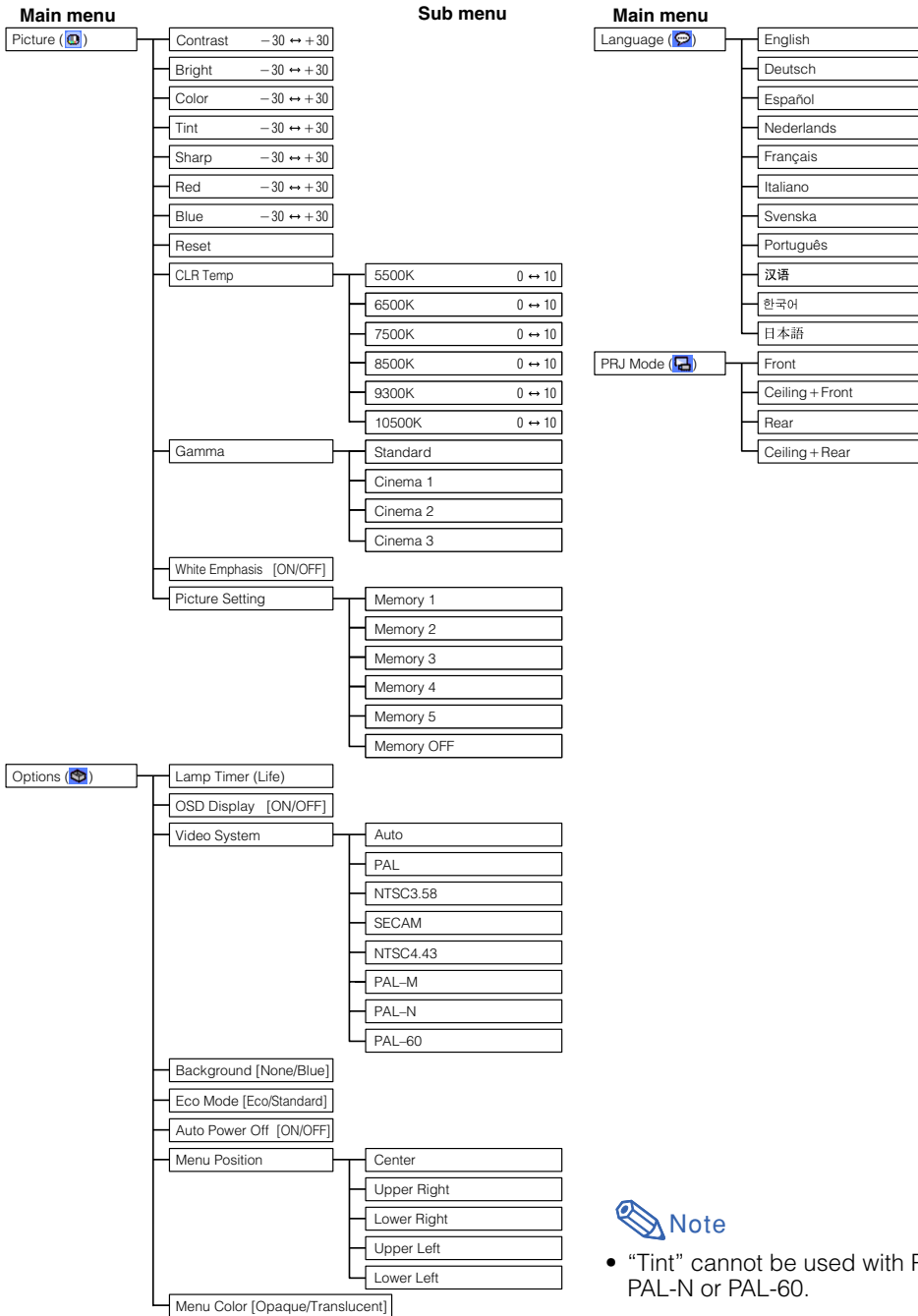

### Note

- "Tint" cannot be used with PAL, SECAM, PAL-M, PAL-N or PAL-60.

# Adjusting the Picture

You can adjust the projector's picture to your preferences with the following picture settings.

## Adjusting Image Preferences

### Note

- First select "Memory 1-5" or "Memory OFF" when you want to save the "Picture" menu settings. See page 47 for details.

Adjust the "Picture" menu on the menu screen.

→ For operating the menu screen, see pages 38 to 41.

### On-screen Display

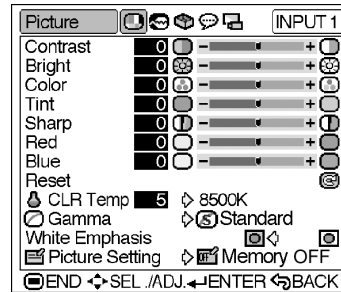

Selected Item	Description	◀ button	▶ button
Contrast	For adjusting the contrast level	For less contrast	For more contrast
Bright	For adjusting the brightness of an image	For less brightness	For more brightness
Color	For adjusting the colour intensity of an image	For less colour intensity	For more colour intensity
Tint	For adjusting the tones of an image	Skin tones become purplish	Skin tones become greenish
Sharp	For making sharper or softer the contour of an image	For less sharpness	For more sharpness
Red	For adjusting the redness of an image	For weaker red	For stronger red
Blue	For adjusting the blueness of an image	For weaker blue	For stronger blue

### Note

- "Color", "Tint" and "Sharp" do not appear for RGB input in INPUT 2 mode.
- To reset all adjustment items, select "Reset" on the "Picture" menu screen and press .
- "Tint" cannot be used with PAL, SECAM, PAL-M, PAL-N or PAL-60.
- "Color", "Tint" and "Sharp" cannot be used in the DIGITAL INPUT mode.

## Adjusting the Colour Temperature

This function allows for selecting the desired colour temperature. With the lower value selected, the projected image becomes warmer, reddish and incandescent-like while with the higher value, the image becomes cooler, bluish and fluorescent-like.

Select “CLR Temp” in the “Picture” menu on the menu screen.

→For operating the menu screen, see pages 38 to 41.

Selected Item	Description
5500K	<p>The less the value is set to, the warmer, reddish, incandescent-like the image becomes.</p> <p style="text-align: center;">↑</p> <p style="text-align: center;">↓</p> <p>The more the value is set to, the cooler, bluish, fluorescent-like the image becomes.</p>
6500K	
7500K	
8500K	
9300K	
10500K	

“CLR Temp” is fine adjusted by following the procedure below.

**1** Select “CLR Temp” in the “Picture” menu on the menu screen and press .

- A single menu bar of “CLR Temp” is displayed.

**2** Press ▲ or ▼ to fine adjust the colour temperature.

- With the lower value selected, the projected image becomes magenta-tinged. With the higher value selected, the projected image becomes green-tinged.
- Pressing ◀ or ▶ changes the value of the colour temperature in the sub menu.

### Note

- Values on “CLR Temp” are only for general standard purposes.

## On-screen Display

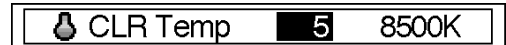
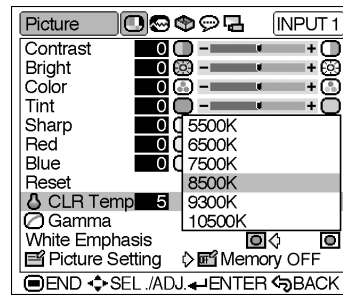



## Gamma Correction Function

Gamma is an image quality enhancement function.

Four gamma settings are available to allow for differences in the brightness of the room.

Select “Gamma” in the “Picture” menu on the menu screen.

→For operating the menu screen, see pages 38 to 41.

Selected Item	Description
Standard	Standard picture without gamma correction
Cinema 1	Gives greater depth to darker portions of images.
Cinema 2	Brightness is toned down and the image becomes more balanced.
Cinema 3	Brighten the darker portions of images for easier viewing in a dimly lit room.

## Emphasizing the Contrast

This function emphasizes the bright portions of images to obtain a higher contrast image.

Select “White Emphasis” in the “Picture” menu on the menu screen.

→For operating the menu screen, see pages 38 to 41.

Selected Item	Description
<input checked="" type="checkbox"/> (ON)	For emphasizing the bright portions of images
<input type="checkbox"/> (OFF)	For disabling “White Emphasis”

### On-screen Display

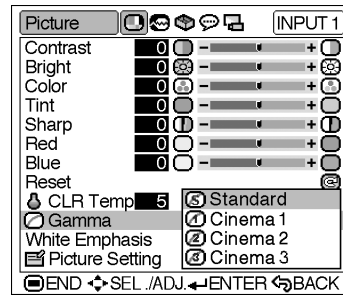

### On-screen Display

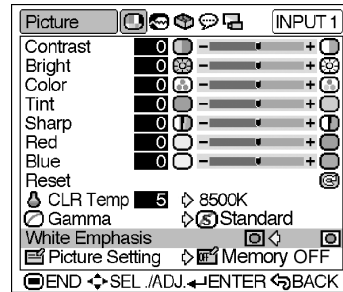

# Picture Setting Function

This function stores all items set in "Picture". Five settings can be stored separately in "Memory 1" to "Memory 5". Each stored setting is reassigned to each input mode (INPUT 1 to INPUT 4 and DIGITAL). Even when the input mode or signal is changed, you can easily select optimal settings from the stored settings.

## ■ Storing the Adjustment Values for Each Memory Number

Select "Picture Setting" on the "Picture" menu and the memory location where you want to store the settings. Then adjust the setting items on the "Picture" menu.





→For operating the menu screen, see pages 38 to 41.

Selected Item	Description
Memory 1-5	Settings of all items in "Picture" can be stored for the respective input modes. The stored settings can be selected in any input modes.
Memory OFF	Besides "Memory 1" to "Memory 5", other settings on the "Picture" menu can be stored for each input mode. The settings stored in "Memory OFF" cannot be applied when another input mode is selected.

## ■ Applying the Stored Settings

If you want to apply the stored settings on the "Picture" menu, select "Picture Setting" on the "Picture" menu and the memory location where you have stored the settings.

### Note

- This function can be operated using the  on the projector or  on the remote control, as well as the OSD menu screen. Each time  or  is pressed, the memory number changes as shown below.

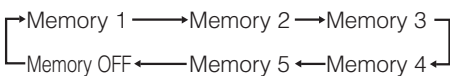

## On-screen Display

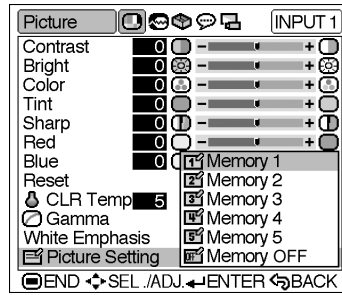

## PICTURE SETTING button

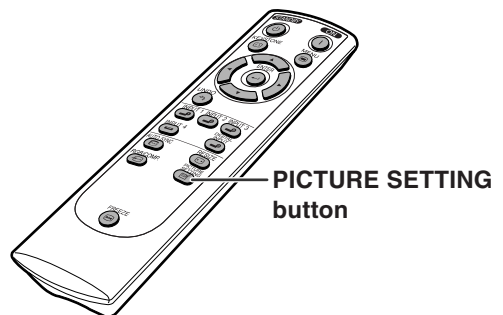
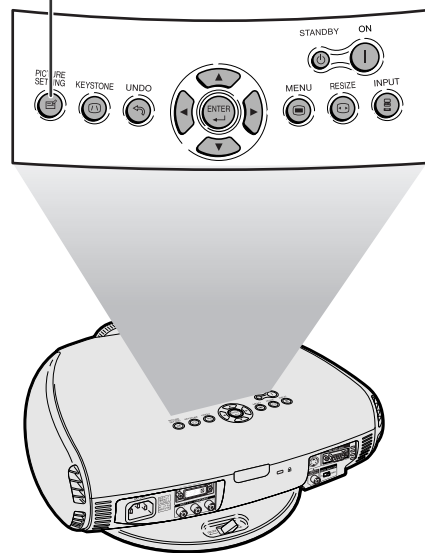

# Adjusting the Computer and DVD/DTV Images

Use the Fine Sync function in case of irregularities such as vertical stripes or flickering in portions of the screen.

## When Auto Sync is OFF

When “Auto Sync” is “OFF”, interference such as flickering or vertical stripes may occur if displaying tilings or vertical stripes. Should this occur, adjust “Clock”, “Phase”, “H-Pos” and “V-Pos” for obtaining an optimum image.

Select “Clock”, “Phase”, “H-Pos” or “V-Pos” in the “Fine Sync” menu on the menu screen.

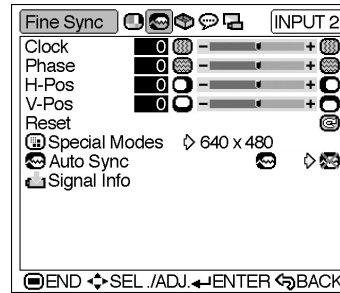

→For operating the menu screen, see pages 38 to 41.

## On-screen Display



Selected Item	Description
Clock	Adjusts vertical noise.
Phase	Adjusts horizontal noise (similar to tracking on your VCR).
H-Pos	Centres the on-screen image by moving it to the left or right.
V-Pos	Centres the on-screen image by moving it up or down.

### Note

- “Clock”, “Phase”, “H-Pos” and “V-Pos” cannot be used in the DIGITAL INPUT mode.
- “Clock” and “Phase” cannot be used in the Component mode.
- Computer image adjustments can be made easily by pressing  on the remote control. See page 50 for details.
- To reset all adjustment items, select “Reset” on the “Fine Sync” menu screen and press .
- The adjustable area of each item may be changed according to the input signal.

## Special Modes Adjustment

Ordinarily, the type of input signal is detected and the correct resolution mode is automatically selected. However, for some signals, the optimal resolution mode in “Special Modes” on the “Fine Sync” menu screen may need to be selected to match the computer display mode.

**Set the resolution by selecting “Special Modes” in the “Fine Sync” menu on the menu screen.**

→For operating the menu screen, see pages 38 to 41.

### Note

- Avoid displaying computer patterns which repeat every other line (horizontal stripes). (Flickering may occur, making the image hard to see.)
- When inputting DTV 1080I signal, select the corresponding type of signal.
- When inputting 720P signal from the video equipment, select “720P”. When inputting 1280 × 720 signal from the computer, select “HTPC”.
- “Special Modes” cannot be used in the DIGITAL INPUT mode.

### On-screen Display

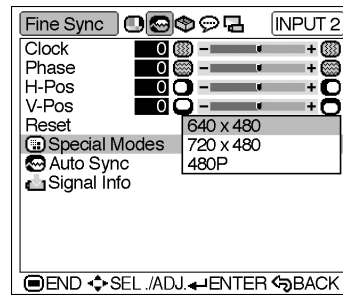



## Auto Sync Adjustment

Used to automatically adjust a computer image.

Select whether the image is to be synchronized automatically when switching the signal with “ON” or “OFF”.

Select “Auto Sync” in the “Fine Sync” menu on the menu screen.

→For operating the menu screen, see pages 38 to 41.

Selected Item	Description
 (ON)	Auto Sync adjustment will occur when the projector is turned on or when the input signals are switched, when connected to a computer.
 (OFF)	Auto Sync adjustment is not automatically performed.

### Note

- When the optimum image cannot be achieved with Auto Sync adjustment, use manual adjustments. (See page 48.)
- The Auto Sync adjustment may take some time to complete, depending on the image of the computer connected to the projector.
- “Auto Sync” cannot be used in the DIGITAL INPUT mode.
- Auto Sync adjustment is also performed by pressing  on the remote control.

## Checking the Input Signal

This function allows you to check the current input signal information.

Select “Signal Info” in the “Fine Sync” menu on the menu screen.

→For operating the menu screen, see pages 38 to 41.

### Note

- 540P is displayed on the screen when signal 1080I is inputted during DVI connection.

### On-screen Display

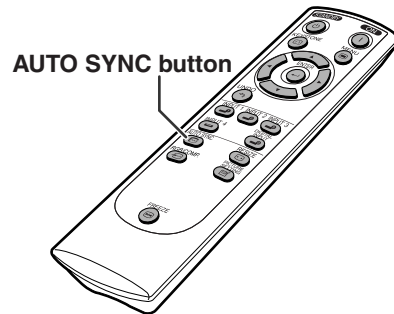
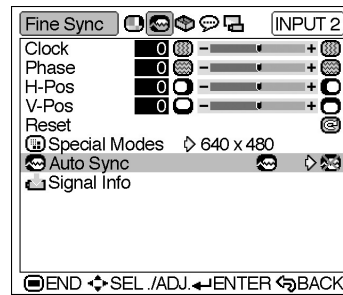

### On-screen Display

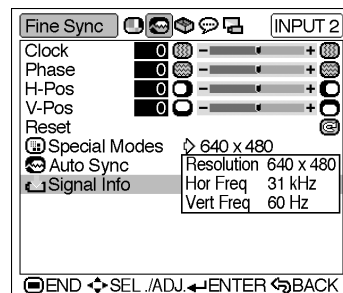

# Using the “Options” Menu

## Checking the Lamp Life Status

You can confirm the cumulative lamp usage time and the remaining lamp life (percentage).

Display the “Options” menu to check the lamp life status.

→For operating the menu screen, see pages 38 to 41.

Lamp usage condition	Remaining lamp life	
	100%	5%
Operated exclusively in Eco mode ( )	Approx. 4,000 hours	Approx. 200 hours
Operated exclusively in Standard mode ( )	Approx. 3,000 hours	Approx. 150 hours

### Note

- It is recommended that the lamp be changed when the remaining lamp life becomes 5%. For lamp replacement, contact your nearest Sharp Authorised Projector Dealer or Service Centre.
- The table above indicates rough estimates in the case of using only in each mode shown. Remaining lamp life changes within the range of the values shown depending on the frequency at which “Eco Mode” is switched to “ ” (Eco mode) and “ ” (Standard mode) (see page 53).

## Turning on/off the On-screen Display

This function allows you to turn on or off the on-screen messages that appear during input select.

Select “OSD Display” in the “Options” menu on the menu screen.

→For operating the menu screen, see pages 38 to 41.

Selected Item	Description
<input checked="" type="checkbox"/> (ON)	All On-screen Displays are displayed.
<input type="checkbox"/> (OFF)	INPUT/FREEZE/AUTO SYNC/“An invalid button has been pressed.” are not displayed.

### On-screen Display

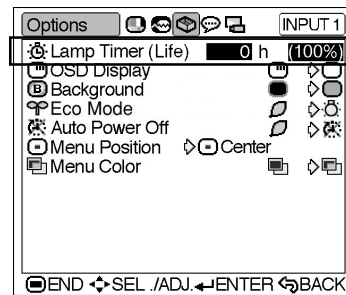

### On-screen Display

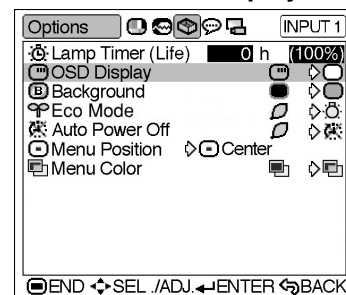

## Selecting the Signal Type

This function allows you to select the input signal type Component or RGB for INPUT 2.

Select “Signal Type” in the “Options” menu on the menu screen.

→For operating the menu screen, see pages 38 to 41.

Selected Item	Description
RGB	Set when RGB signals are received.
Component	Set when Component signals are received.

### Note

- “RGB” or “Component” can be selected with  on the remote control only in INPUT 2.

### On-screen Display

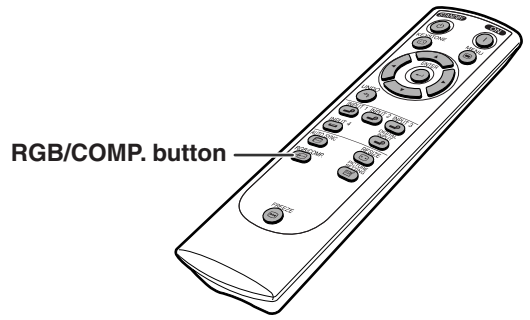
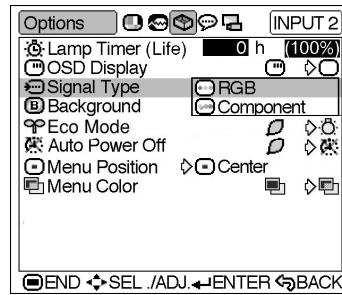

### On-screen Display

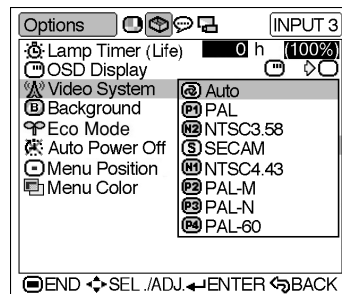

## Setting the Video Signal (VIDEO menu only)

The video input system mode is preset to “Auto”; however, it can be changed to a specific system mode if the selected system mode is not compatible with the connected audiovisual equipment.

Select “Video System” in the “Options” menu on the menu screen.

→For operating the menu screen, see pages 38 to 41.

### Note



- When the system mode is set to “Auto”, you may not receive a clear picture due to signal differences. Should this occur, switch to the video system of the source signal.
- “Auto” cannot be set for PAL-M and PAL-N input signals. Select “PAL-M” or “PAL-N” in “Video System” menu for PAL-M and PAL-N input signals.

## Selecting a Background Image

This function allows you to select the image displayed when no signal is being sent to the projector.

Select “Background” in the “Options” menu on the menu screen.

→For operating the menu screen, see pages 38 to 41.

Selected Item	Description
 (Blue)	Blue screen
 (None)	Black screen

## On-screen Display

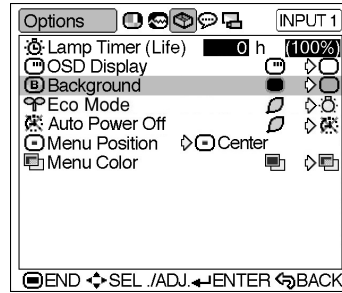



## Setting the Eco Mode

This function allows you to select the desired power consumption mode.

Select “Eco Mode” in the “Options” menu on the menu screen.



→For operating the menu screen, see pages 38 to 41.

Selected Item	Brightness	Power consumption	Lamp life
 (Eco mode)	80%	230 W	Approx. 4,000 hours
 (Standard mode)	100%	285 W	Approx. 3,000 hours

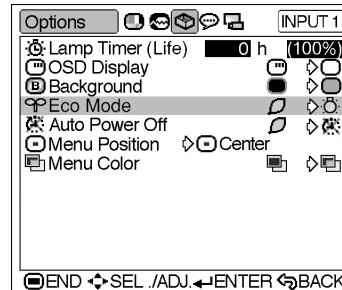
## On-screen Display



### Note

- Although lamp life and noise are improved when “Eco Mode” is set to “” (Eco mode), brightness decreases by 20%.
- “Eco Mode” is factory preset to “” (Standard mode).





## Automatic Power Shut-off Function



When no input signal is detected for more than 15 minutes, the projector will automatically enter the standby mode if set to “” (ON).

Select “Auto Power Off” in the “Options” menu on the menu screen.

→For operating the menu screen, see pages 38 to 41.

Selected Item	Description
	Projector automatically enters the standby mode after 15 minutes without an input signal.
	Automatic Power Shut-off disabled.

### Note

- “Auto Power Off” is factory preset to “”.
- When the Auto Power Off function is set to “ (ON)”, 5 minutes before the projector enters the standby mode, the message “Enter STANDBY mode in X min.” will appear on the screen to indicate the remaining minutes.

## Selecting the Menu Screen Position

This function allows you to select the desired position of the menu screen.

Select “Menu Position” in the “Options” menu on the menu screen.

→For operating the menu screen, see pages 38 to 41.

Selected Item	Description
Center	The menu is displayed on the center of the image.
Upper Right	The menu is displayed on the upper right of the image.
Lower Right	The menu is displayed on the lower right of the image.
Upper Left	The menu is displayed on the upper left of the image.
Lower Left	The menu is displayed on the lower left of the image.

### On-screen Display

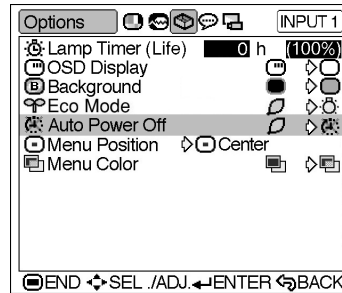

Enter STANDBY mode in 1 min.



### On-screen Display

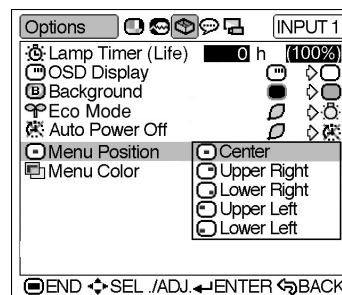



## Selecting the Menu Colour

This function allows you to select the colour of the menu screen.

Select “Menu Color” in the “Options” menu on the menu screen.

→For operating the menu screen, see pages 38 to 41.

Selected Item	Description
 (Opaque)	The menu is displayed opaquely.
 (Translucent)	The menu is displayed translucently. The part of the menu on the image becomes transparent.

### On-screen Display

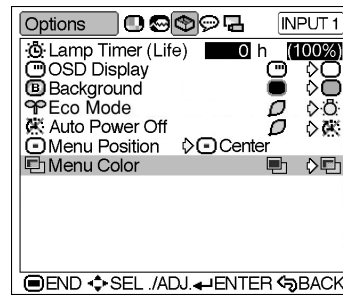







# Reversing/Inverting Projected Images

This projector is equipped with a reverse/invert image function that allows you to reverse or invert the projected image for various applications.

## Setting the Projection Mode

Display the “PRJ Mode” menu and select the desired projection mode.

→For operating the menu screen, see pages 38 to 41.

Selected Item	Description
 Front	Normal image
 Ceiling + Front	Inverted image
 Rear	Reversed image
 Ceiling + Rear	Reversed and inverted image

### Note

- This function is used for the reversed image and ceiling-mount setups. See page 28 for these setups.

### On-screen Display

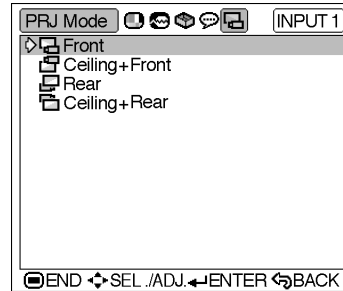

# Appendix



# Maintenance Indicators

- The warning lights on the projector indicate problems inside the projector.
- If a problem occurs, either the temperature warning indicator or the lamp indicator will illuminate red, and the projector will enter the standby mode. After the projector has entered the standby mode, follow the procedures given below.

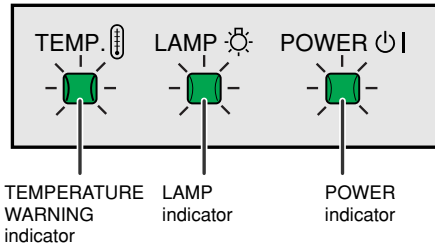

## About the temperature warning indicator



If the temperature inside the projector increases, due to blockage of the air vents, or the setting location, “TEMP.” will

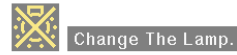

illuminate in the lower left corner of the picture. If the temperature keeps on rising, the lamp will turn off and the temperature warning indicator will blink, the cooling fan will run for a further 90 seconds, and then the projector will enter the standby mode. After “TEMP.” appears, be sure to perform the following measures.

## About the lamp indicator



- The lamp life becomes 0%, when used for approximately 4,000 hours with “Eco mode” or when used for approximately 3,000 hours with “Standard mode” (see page 53).
- When the remaining lamp life becomes 5% or less, “” (yellow) will be displayed on the screen. When the percentage becomes 0%, “” (red), the lamp will automatically turn off and then the projector will automatically enter the standby mode. At this time, the lamp indicator will illuminate in red.
- If you try to turn on the projector a fourth time without replacing the lamp, the projector will not turn on.

Maintenance indicator	Condition		Problem	Possible Solution
	Normal	Abnormal		
Temperature warning indicator	Off	Red on/ Standby	<ul style="list-style-type: none"> <li>• Blocked air intake</li> <li>• Cooling fan breakdown</li> <li>• Internal circuit failure</li> <li>• Clogged air intake</li> </ul>	<ul style="list-style-type: none"> <li>• Relocate the projector to an area with proper ventilation.</li> <li>• Take the projector to your nearest Sharp Authorised Projector Dealer or Service Centre for repair.</li> </ul>
Lamp indicator	Green on (Green blinks when the lamp is warming up.)	Red on	<ul style="list-style-type: none"> <li>• Remaining lamp life becomes 5% or less.</li> </ul>	<ul style="list-style-type: none"> <li>• Carefully replace the lamp. (See page 59.)</li> <li>• Take the projector to your nearest Sharp Authorised Projector Dealer or Service Centre for repair.</li> <li>• Please exercise care when replacing the lamp.</li> </ul>
		Red on/ Standby	<ul style="list-style-type: none"> <li>• The lamp does not illuminate.</li> <li>• Burnt-out lamp</li> <li>• Lamp circuit failure</li> </ul>	
Power indicator	Green on/ Red on	Off	<ul style="list-style-type: none"> <li>• The lamp unit cover is open.</li> </ul>	<ul style="list-style-type: none"> <li>• Securely install the cover.</li> <li>• If the power is not turned on even when the lamp unit cover is securely installed, contact your nearest Sharp Authorised Projector Dealer or Service Centre for advice.</li> </ul>

## Info

- If the temperature warning indicator illuminates, and the projector enters the standby mode, follow the possible solutions on the previous page and then wait until the projector has cooled down completely before plugging in the power cord and turning the power back on. (At least 5 minutes.)
- If the power is turned off for a brief moment due to power outage or some other cause while using the projector, and the power supply recovers immediately after that, the lamp indicator will illuminate in red and the lamp may not be lit. In this case, unplug the power cord from the AC outlet, replace the power cord in the AC outlet and then turn the power on again.
- If you want to clean the air vents during projector operation, be sure to put the projector into the standby mode. After the cooling fan has stopped, clean the vents.
- The cooling fan keeps the internal temperatures of the projector constant and this function is controlled automatically. The sound of the cooling fan may change during operation because the fan speed may change and this is not a malfunction.
- Do not unplug the power cord after the projector has entered the standby mode and while the cooling fan is running. The cooling fan runs for about 90 seconds.

## Regarding the Lamp

### Lamp

- It is recommended that the lamp (sold separately) be replaced when the remaining lamp life becomes 5% or less, or when you notice a significant deterioration in the picture and color quality. The lamp life (percentage) can be checked with the on-screen display. See page 51.
- For lamp replacement, please consult your nearest Sharp Authorised Projector Dealer or Service Centre.

### Caution Concerning the Lamp

- This projector utilizes a pressurized mercury lamp. A loud sound may indicate lamp failure. Lamp failure can be attributed to numerous sources such as: excessive shock, improper cooling, surface scratches or deterioration of the lamp due to a lapse of usage time. The period of time up to failure largely varies depending on the individual lamp and/or the condition and the frequency of use. It is important to note that failure can often result in the bulb cracking.
- When the lamp replacement indicator and on-screen display icon are illuminated, it is recommended that the lamp be replaced with a new one immediately, even if the lamp appears to be operating normally.
- Should the lamp break, the glass particles may spread inside the lamp unit or gas contained in the lamp may be vented into the room from the exhaust vent. Because the gas in this lamp includes mercury, ventilate the room well if the lamp breaks and avoid all exposure to the released gas. In case of exposure to the gas, consult a doctor as soon as possible.
- Should the lamp break, there is also a possibility that glass particles may spread inside of the projector. In such a case, it is recommended you contact your nearest Sharp Authorised Projector Dealer or Service Centre to remove the damaged lamp and assure safe operation.

### Replacing the Lamp

#### Caution

- Do not remove the lamp unit immediately after operation of the projector. The lamp will be hot and touching it can lead to burn or injury.
- Wait at least one hour after the power cord is disconnected to allow the surface of the lamp unit to fully cool before removing the lamp unit.
- If the new lamp does not light after replacement, take your projector to the nearest Sharp Authorised Projector Dealer or Service Centre for repair. Purchase a replacement lamp unit of type BQC-XVZ200++1 from your nearest Sharp Authorised Projector Dealer or Service Centre. Then carefully change the lamp by following the instructions described in this section. If you wish, you may have the lamp replaced at your nearest Sharp Authorised Projector Dealer or Service Centre.

### Removing and Installing the Lamp Unit

#### ⚠ Caution

- Be sure to remove the lamp unit by the handle. Do not touch the glass surface of the lamp unit or the inside of the projector.
- To avoid injury to yourself and damage to the lamp, carefully follow the steps below.
- Replace the lamp after turning off the power and unplugging the power cord.

#### 1 Put the projector into the standby mode.

- Press <sup>STANDBY</sup> .
- Wait until the cooling fan stops.

#### 2 Unplug the power cord.

- Unplug the power cord from the AC socket.
- Leave the lamp until it has fully cooled down (about 1 hour).

#### 3 Remove the Swivel Stand. (See page 24.)

#### 4 Remove the lamp unit cover.

- Loosen the user service screw that secures the lamp unit cover.
- Slide the lamp unit cover in the direction of the arrow.

#### 5 Remove the lamp unit.

- Loosen the securing screws from the lamp unit. Hold the lamp unit by the handle and pull it in the direction of the arrow.

Lamp unit

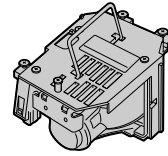

BQC-XVZ200++1

STANDBY button

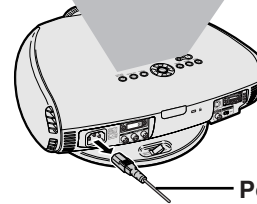
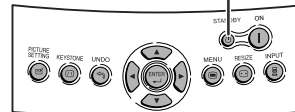

Power cord

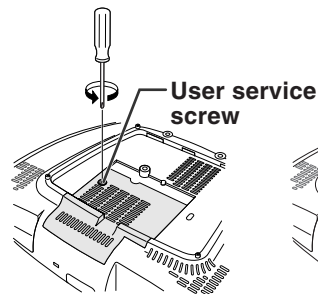
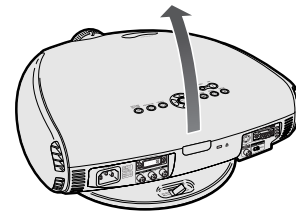

User service screw

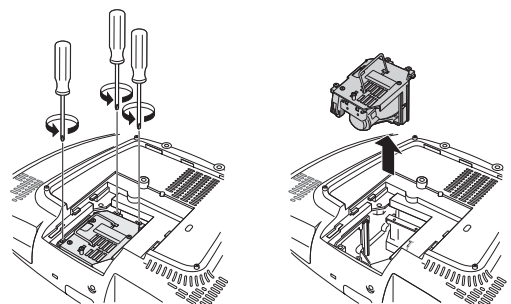

## 6 Insert the new lamp unit.

- Press the lamp unit firmly into the lamp unit compartment. Fasten the securing screws.

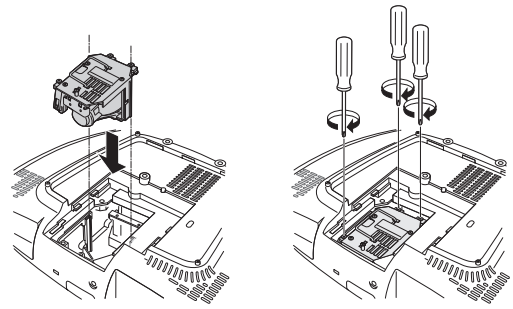

## 7 Attach the lamp unit cover.

- Slide the lamp unit cover in the direction of the arrow.
- Fasten the user service screw.

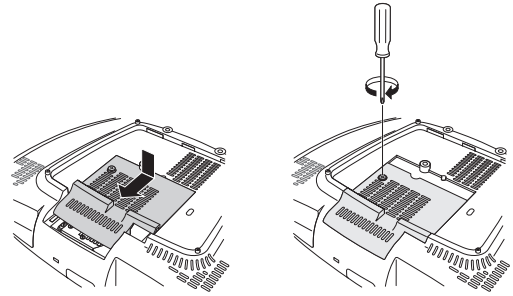

## Resetting the Lamp Timer

Reset the lamp timer after replacing the lamp.

### 1 Plug the power cord.

- Confirm that the POWER indicator illuminates red.

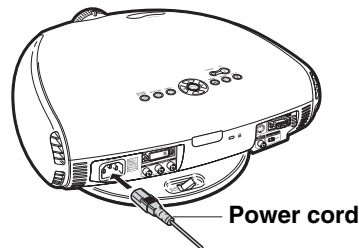

### 2 Reset the lamp timer.

- Press , , , , and in order. Then press .
- "LAMP 0000H" is displayed on the screen.

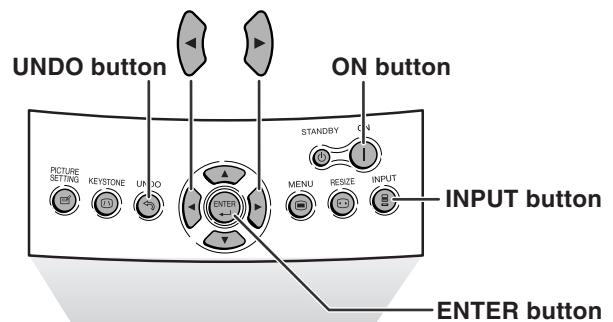

### Info

- Make sure to reset the lamp timer only when replacing the lamp. If you reset the lamp timer and continue to use the same lamp, the lamp may become damaged or explode.



# Cleaning the Ventilative Holes

- This projector is equipped with ventilative holes to ensure the optimal operating condition of the projector.
- Periodically clean the ventilative hole by vacuuming it off with a vacuum cleaner.
- The ventilative holes should be cleaned every 100 hours of use. Clean the ventilative holes more often when the projector is used in a dirty or smoky location.

Side and Rear view

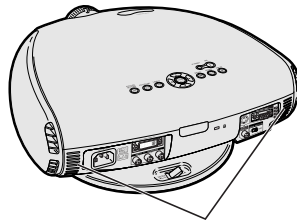

Intake ventilative holes

Bottom view

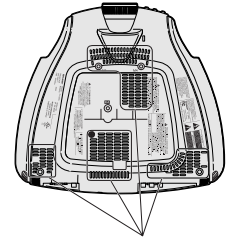

Intake ventilative holes

Swivel stand

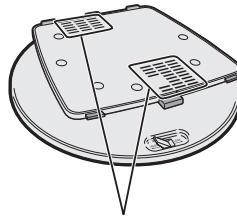

Intake ventilative holes

## Cleaning the Ventilative Holes

- 1** Put the projector into the standby mode.

- Press  .
- Wait until the cooling fan stops.

- 2** Unplug the power cord.

- 3** Clean the dust off by putting the cleaner hose on the intake ventilative holes.

STANDBY button

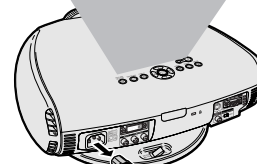
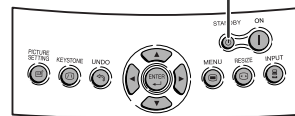

Power cord

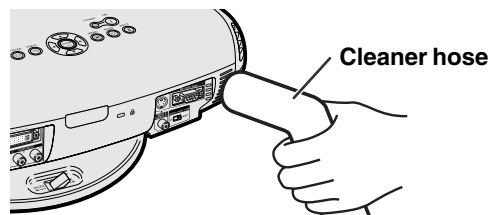

Cleaner hose

# Using the Kensington Lock

This projector has a Kensington Security Standard connector for use with a Kensington MicroSaver Security System. Refer to the information that came with the system for instructions on how to use it to secure the projector.

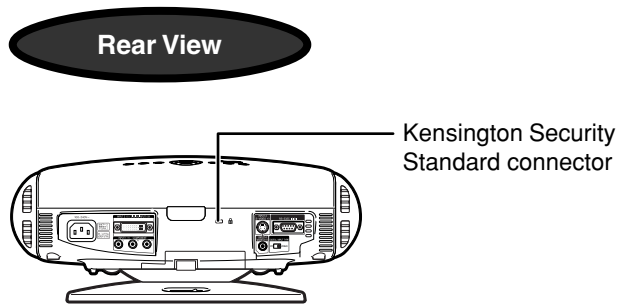

# Troubleshooting

Problem	Check
No picture appears.	<ul style="list-style-type: none"> <li>• Projector power cord is not plugged into the wall outlet.</li> <li>• Selected input is wrong. (See page 31.)</li> <li>• Cables incorrectly connected to back panel of the projector. (See pages 14–23.)</li> <li>• “Contrast” and “Bright” adjustments are set to minimum position. (See page 44.)</li> </ul>
Colour is faded or poor.	<ul style="list-style-type: none"> <li>• Picture adjustments are not correct. (See page 44.)</li> </ul>
Picture is blurred.	<ul style="list-style-type: none"> <li>• Adjust the focus. (See page 25.)</li> <li>• Projection distance is too long or too short to allow for proper focus. (See pages 26 and 27.)</li> </ul>
No OSD appears.	<ul style="list-style-type: none"> <li>• OSD Display is set to “OFF”, preventing to display some or all On-screen Displays. (See page 51.)</li> </ul>
An unusual sound is occasionally heard from the cabinet.	<ul style="list-style-type: none"> <li>• If the picture is normal, the sound is due to cabinet shrinkage caused by temperature changes. This will not affect operation or performance of the projector.</li> </ul>
Maintenance indicator illuminates.	<ul style="list-style-type: none"> <li>• Refer to “Maintenance Indicators” on page 58.</li> </ul>
Picture noise appears.	<ul style="list-style-type: none"> <li>• Adjust the “Phase” setting. (See page 48.)</li> </ul>
Image is green on INPUT 2 Component. Image is pink (no green) on INPUT 2 RGB.	<ul style="list-style-type: none"> <li>• Change the input signal type. (See page 52.)</li> </ul>

# Connecting Pin Assignments

## DVI-I (INPUT 2 / DIGITAL INPUT) port : 29 pin connector

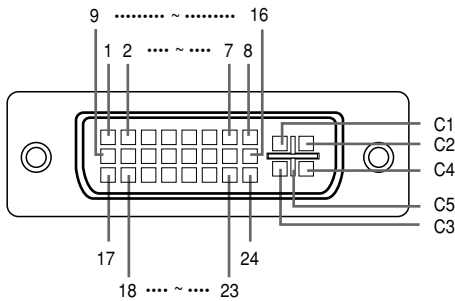

### • DVI Digital INPUT

Pin No.	Signal	Pin No.	Signal
1	T.M.D.S data 2-	16	Hot plug detection
2	T.M.D.S data 2+	17	T.M.D.S data 0-
3	T.M.D.S data 2 shield	18	T.M.D.S data 0+
4	Not connected	19	T.M.D.S data 0 shield
5	Not connected	20	Not connected
6	DDC clock	21	Not connected
7	DDC data	22	T.M.D.S clock shield
8	Not connected	23	T.M.D.S clock+
9	T.M.D.S data 1-	24	T.M.D.S clock-
10	T.M.D.S data 1+	C1	Not connected
11	T.M.D.S data 1 shield	C2	Not connected
12	Not connected	C3	Not connected
13	Not connected	C4	Not connected
14	+5V power	C5	Ground
15	Ground		

### • DVI Analog RGB Input

Pin No.	Signal	Pin No.	Signal
1	Not connected	16	Hot plug detection
2	Not connected	17	Not connected
3	Not connected	18	Not connected
4	Not connected	19	Not connected
5	Not connected	20	Not connected
6	DDC clock	21	Not connected
7	DDC data	22	Not connected
8	Vertical sync	23	Not connected
9	Not connected	24	Not connected
10	Not connected	C1	Analog input Red
11	Not connected	C2	Analog input Green
12	Not connected	C3	Analog input Blue
13	Not connected	C4	Horizontal sync
14	+5V power	C5	Ground
15	Ground		

### • DVI Analog Component Input

Pin No.	Signal	Pin No.	Signal
1	Not connected	16	Not connected
2	Not connected	17	Not connected
3	Not connected	18	Not connected
4	Not connected	19	Not connected
5	Not connected	20	Not connected
6	Not connected	21	Not connected
7	Not connected	22	Not connected
8	Not connected	23	Not connected
9	Not connected	24	Not connected
10	Not connected	C1	Analog input Pr/Cr
11	Not connected	C2	Analog input Y
12	Not connected	C3	Analog input Pb/Cb
13	Not connected	C4	Not connected
14	Not connected	C5	Ground
15	Ground		

## RS-232C Port: 9-pin D-sub male connector

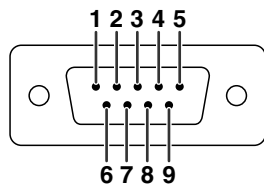

Pin No.	Signal	Name	I/O	Reference
1				Not connected
2	RD	Receive Data	Input	Connected to internal circuit
3	SD	Send Data	Output	Connected to internal circuit
4		Reserved		Connected to internal circuit
5	SG	Signal Ground		Connected to internal circuit
6		Reserved		Connected to internal circuit
7		Reserved		Connected to internal circuit
8		Reserved		Connected to internal circuit
9				Not connected

# (RS-232C) Specifications and Command Settings

## PC control

A computer can be used to control the projector by connecting an RS-232C cable (null modem, cross type, commercially available) to the projector. (See page 23 for connection.)

## Communication conditions

Set the serial port settings of the computer to match that of the table.

Signal format: Conforms to RS-232C standard.

Baud rate: 9,600 bps

Data length: 8 bits

Parity bit: None

Stop bit: 1 bit

Flow control: None

## Basic format

Commands from the computer are sent in the following order: command, parameter, and return code. After the projector processes the command from the computer, it sends a response code to the computer.

Command format

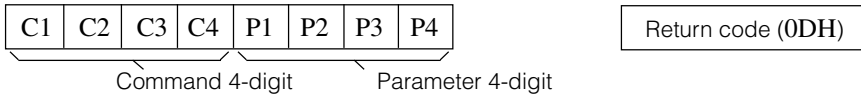

Response code format

Normal response



Problem response (communication error or incorrect command)



### Info

- When more than one code is being sent, send each command only after the OK response code for the previous command from the projector is verified.

### Note

- When using the computer control function of the projector, the projector's operating status cannot be read by the computer. Therefore, confirm the status by transmitting the display commands for each adjustment menu and checking the status with the on-screen display.

## Commands

### Example:

- When power on.

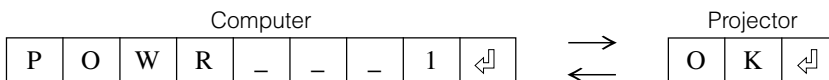

CONTROL CONTENTS		COMMAND	PARAMETER	RETURN
BUTTONS & REMOTE CONTROL BUTTONS	POWER ON	P O W R	_ _ _	1 OK OR ERR
	STANDBY	P O W R	_ _ _	0 OK OR ERR
	INPUT 1 (COMPONENT 1)	I V E D	_ _ _	1 OK OR ERR
	INPUT 2 (COMPONENT 2)	I V E D	_ _ _	2 OK OR ERR
	INPUT 3 (S-VIDEO)	I V E D	_ _ _	3 OK OR ERR
	INPUT 4 (VIDEO)	I V E D	_ _ _	4 OK OR ERR
	DIGITAL INPUT MODE	I V E D	_ _ _	5 OK OR ERR

### Note

- If an underbar ( \_ ) appears in the parameter column, enter a space.

# Computer Compatibility Chart

Horizontal Frequency: 15–70 kHz  
 Vertical Frequency: 43–75 Hz  
 Pixel Clock: 12–80 MHz  
 Compatible with sync on green  
 XGA compatible in intelligent compression

PC/ MAC/ WS	Resolution		Horizontal Frequency (kHz)	Vertical Frequency (Hz)	VESA Standard	DVI Support	Display
PC	VGA	640 × 350	27.0	60			Upscale
			31.5	70			
		720 × 350	27.0	60			
			31.5	70			
		640 × 400	27.0	60			
			31.5	70			
		720 × 400	27.0	60			
			31.5	70			
		640 × 480	26.2	50		✓	
			31.5	60	✓	✓	
	34.7		70		✓		
	37.9		72	✓	✓		
	37.5		75	✓	✓		
	SVGA	800 × 600	31.4	50		✓	Intelligent Compression
			35.1	56	✓	✓	
			37.9	60	✓	✓	
			44.5	70		✓	
48.1			72	✓	✓		
46.9			75	✓	✓		
XGA	1,024 × 768	35.5	43	✓	✓		
		40.3	50		✓		
		56.5	70	✓	✓		
		58.1	72		✓		
—	1,280 × 720	45.0	60		✓		
PC/ MAC 13"	VGA	640 × 480	34.9	67			Upscale
MAC 16"	SVGA	832 × 624	46.8	75			Intelligent Compression
			49.6	75			
PC/ MAC 19"	XGA	1,024 × 768	48.4	60	✓		
			60.0	75	✓		

## Note

- This projector may not be able to display images from notebook computers in simultaneous (CRT/LCD) mode. Should this occur, turn off the LCD display on the notebook computer and output the display data in “CRT only” mode. Details on how to change display modes can be found in your notebook computer’s operation manual.

# Specifications

Product type	Projector
Model	XV-Z201E
Video system	PAL/PAL 60/PAL-M/PAL-N/SECAM/NTSC 3.58/NTSC 4.43 DTV 480I/480P/720P/1080I
Display method	DLP chip, RGB optical shutter method
DLP panel	Panel size: 0.6" Display method: Single Panel Digital Micromirror Device (DMD™) by Texas Instruments Drive method: Digital Light Processing (DLP™) No. of dots: 589,824 dots (1,024 [H] × 576 [V])
Lens	1–1.2 × zoom lens, F2.0–2.4 f=16.9–20.2 mm
Projection lamp	210 W/168 W SHP lamp
Video input signal	RCA Connector: VIDEO (INPUT 4), composite video, 1.0 Vp-p, sync negative, 75 Ω terminated
S-video input signal	4-pin Mini DIN connector (INPUT 3) Y (luminance signal): 1.0 Vp-p, sync negative, 75 Ω terminated C (chrominance signal): Burst 0.286 Vp-p, 75 Ω terminated
Component input signal (INPUT 1)	RCA Connector Y: 1.0 Vp-p, sync negative, 75 Ω terminated Pb: 0.7 Vp-p, 75 Ω terminated Pr: 0.7 Vp-p, 75 Ω terminated
Component input signal (INPUT 2)	29-pin connector DVI input signal: Digital 250–1,000 mV 50 Ω Analog 0.7 Vp-p 75 Ω Y: 1.0 Vp-p, sync negative, 75 Ω terminated Pb: 0.7 Vp-p, 75 Ω terminated Pr: 0.7 Vp-p, 75 Ω terminated
Horizontal resolution	520 TV lines (NTSC 3.58 input)
RGB input signal	DVI-I terminal <Digital> Input impedance 50 Ω Input level 250-1000 mV <Analog> Input impedance 75 Ω Input level 0.7 Vp-p <Synchronization signal> • Separate sync/Composite sync Input level TTL level Input impedance 1 KΩ • Green on sync Input level (Synchronizing input) 0.286 Vp-p Input impedance 75 Ω
Pixel clock	12–80 MHz
Vertical frequency	43–75 Hz
Horizontal frequency	15–70 kHz
Computer control signal	9-pin D-sub connector (RS-232C Port)
Rated voltage	AC 100–240 V
Input current	3.2 A
Rated frequency	50/60 Hz
Power consumption	285 W
Heat dissipation	1,070 BTU/hour
Operating temperature	+5°C to +35°C
Storage temperature	–20°C to +60°C
Cabinet	Plastic
I/R carrier frequency	38 kHz
Dimensions (approx.)	368 (W) × 153.8 (H) × 327 (D) mm (including swivel stand) 368 (W) × 118 (H) × 327 (D) mm (main body only)
Weight (approx.)	4.6 kg (including swivel stand) 4.1 kg (main body only)
Supplied accessories	Remote control, Two AA size batteries, Power cord, 21 pin RCA conversion adaptor, Video cable, Terminal cover, Screws for terminal cover, Lens cap (attached on the body), Operation manual
Replacement parts	Lamp unit (Lamp/cage module) (BQC-XVZ200++1), Remote control (RRMCGA218WJSA), AA size batteries, Power cord for Europe except U.K. (QACCV4002CEZZ), Power cord for U.K., Hong Kong and Singapore (QACCBAA012WJPZ), Power cord for Australia and New Zealand (QACCLA018WJPZ), 21 pin RCA conversion adaptor (QSOCZ0361CEZZ), Video cable (QCNWGA001WJZZ), Terminal cover (GCOVAA116WJKB), Screws for terminal cover (XBBSN40P10000), Lens cap (CCAPHA004WJ01), Operation manuals; for European 7 languages (TINS-B009WJZZ) / for Chinese, Korean and Arabic (TINS-B010WJZZ)

This SHARP projector uses a DMD chip. This very sophisticated chip contains 589,824 pixels. As with any high technology electronic equipment such as large screen TVs, video systems and video cameras, there are certain acceptable tolerances that the equipment must conform to.

*Specifications are subject to change without notice.*

# Dimensions

Units: mm

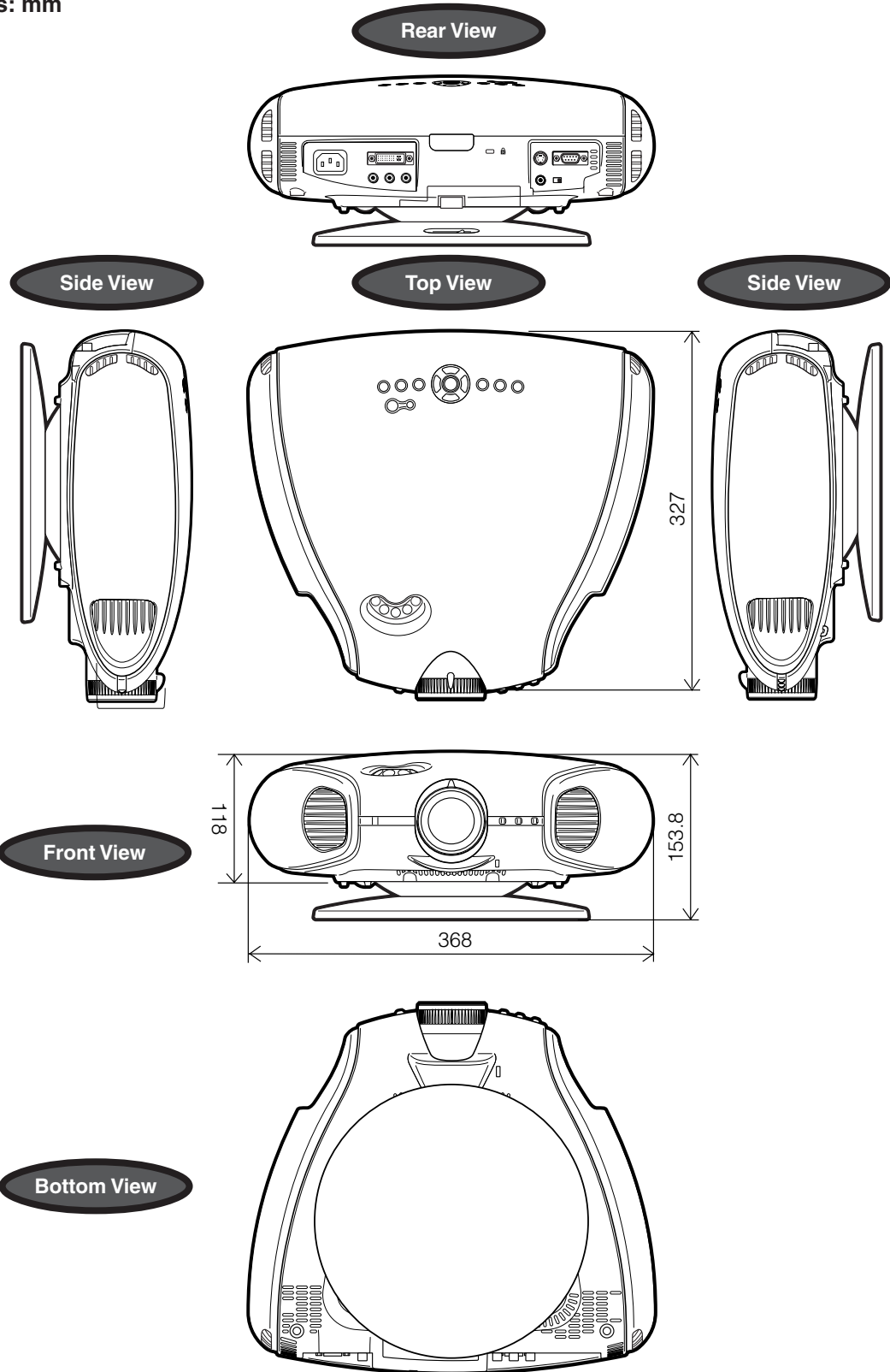

## **Aspect Ratio**

Width and height ratio of an image. The normal aspect ratio of a computer and video image is 4:3. There are also wide images with an aspect ratio of 16:9 and 21:9.

## **Auto Sync**

Optimizes projected computer images by automatically adjusting certain characteristics.

## **Background**

Initial setting image projected when no signal is being output.

## **Clock**

Clock adjustment is used to adjust vertical noise when clock level is incorrect.

## **CLR Temp (Colour temperature)**

Function that can be used to adjust the colour temperature to suit the type of image input to the projector. Decrease the colour temperature to create warmer, reddish images for natural flesh tones, or increase to create cooler, bluish images for a brighter picture.

## **Composite sync**

Signal combining horizontal and vertical sync pulses.

## **Digital keystone correction**

Function to digitally correct a distorted image when the projector is set up at an angle, smoothes out jaggies on keystone images and compresses the image not only horizontally but vertically keeping the 16 : 9 aspect ratio.

## **DVI (Digital Visual Interface)**

Display digital interface that also supports analog interfaces.

## **Gamma**

Image quality enhancement function that offers a richer image by brightening the darker portions of the image without altering the brightness of the brighter portions. You can select from four different modes: Standard, Cinema 1, Cinema 2 and Cinema 3.

## **Intelligent compression and expansion**

High quality resizing of lower and higher resolution images to fit the projector's native resolution.

## **Phase**

Phase shift is a timing shift between isomorphic signals with the same resolution. When phase level is incorrect, the projected image typically displays horizontal flicker.

## **Resize**

Allows you to modify or customize the picture display mode to enhance the input image. You can select from four different modes: SIDE BAR, SMART STRETCH, CINEMA ZOOM and STRETCH.

## **RS-232C**

Function to control the projector from the computer by using the RS-232C ports on the projector and computer.

## **Stretch**

Mode that stretches the 4:3 image horizontally to display it on the wide screen.

## **Sync on green**

Video signal mode of a computer which overlaps horizontal and vertical sync signal to green colour signal pin.



# Index

<b>A</b>	
AC socket .....	14
Adjusting the Picture .....	44
ADJUSTMENT buttons .....	39
Aspect ratio .....	35
Automatic power shut-off function .....	54
Auto sync adjustment .....	50
AUTO SYNC button .....	50
<b>B</b>	
Background .....	53
<b>C</b>	
Ceiling-mount .....	28
Ceiling+Rear .....	56
Clock .....	48
COMPONENT terminals .....	17
<b>D</b>	
DIGITAL INPUT terminal .....	20
DVI .....	20
<b>E</b>	
Eco mode .....	53
ENTER button .....	39
Exhaust ventilative hole .....	6
<b>F</b>	
Focus ring .....	25
FREEZE button .....	35
<b>I</b>	
INPUT buttons .....	31
<b>K</b>	
Kensington Lock .....	63
KEYSTONE button .....	33
<b>L</b>	
LAMP indicator .....	58
Lens shift .....	25
<b>M</b>	
MENU button .....	38
<b>O</b>	
ON button .....	30
On-screen display .....	51
On-screen display language .....	31
<b>P</b>	
Phase .....	48
Power cord .....	14
POWER indicator .....	30
<b>R</b>	
Rear projection .....	28
Remote control .....	10
Remote control sensor .....	11
Remote control signal transmitter .....	10
RESIZE button .....	35
RS-232C terminal .....	23
<b>S</b>	
STANDBY button .....	32
STRETCH .....	36
S-VIDEO INPUT terminal .....	15
Sync on green .....	66
<b>T</b>	
TEMPERATURE WARNING indicator .....	58
<b>U</b>	
UNDO button .....	39
<b>V</b>	
VIDEO INPUT terminal .....	16
Video System .....	52
<b>Z</b>	
Zoom knob .....	25

# SHARP®

## SHARP CORPORATION

Printed on 100% post-consumer recycled paper.  
Gedruckt auf 100% wiederverwertungs Papier.  
Imprimé sur 100% de papier recyclé.  
Utskrift på återvunnet papper av 100% återvunnet material.  
Impreso en 100% de papel reciclado de postconsumo.  
Stampato su carta riciclata al 100%.  
Gedruckt op 100% kringlooppapier.



Printed in Japan  
In Japan gedruckt  
Imprimé au Japon  
Triykt i Japan  
Impreso en Japón  
Stampato in Giappone  
Gedruckt in Japan  
TINS-B009WJZZ  
03P11-JWM