

myprojectorlamps.com

**The most trusted, dependable name
in projector lamp sales.**



<http://www.myprojectorlamps.com>



<http://www.myprojectorlamps.ca>



<http://www.myprojectorlamps.eu>

The following projector manual has not been modified or altered in any way.

SHARP®

XV-Z10E

PROJECTOR
PROJEKTOR
PROJECTEUR
PROJEKTOR
PROYECTOR
PROIETTORE
PROJECTOR

OPERATION MANUAL
BEDIENUNGSANLEITUNG
MODE D'EMPLOI
BRUKSANVISNING
MANUAL DE MANEJO
MANUALE DI ISTRUZIONI
GEBRUIKSAANWIJZING

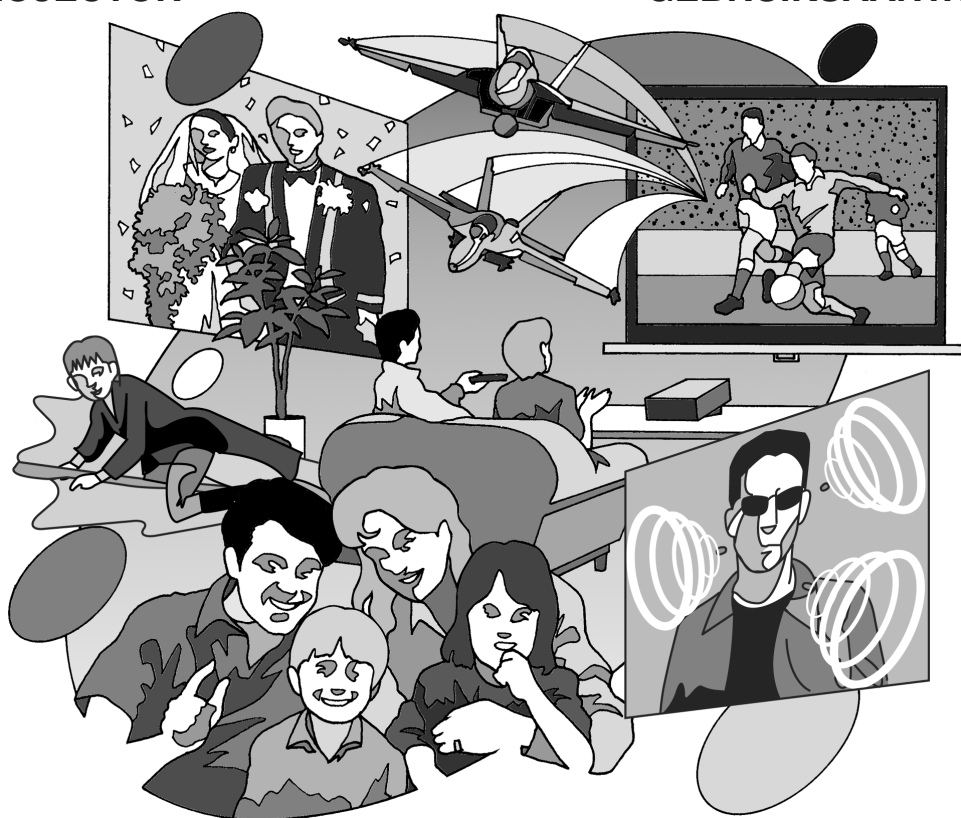

ENGLISH	GB	-1 -	GB	-68
DEUTSCH	D	-1 -	D	-68
FRANÇAIS	F	-1 -	F	-68
SVENSKA	S	-1 -	S	-68
ESPAÑOL	ES	-1 -	ES	-68
ITALIANO	I	-1 -	I	-68
NEDERLANDS	NL	-1 -	NL	-68

This equipment complies with the requirements of Directive 89/336/EEC and 73/23/EEC as amended by 93/68/EEC.

Dieses Gerät entspricht den Anforderungen der EG-Richtlinien 89/336/EWG und 73/23/EWG mit Änderung 93/68/EWG.

Ce matériel répond aux exigences contenues dans les directives 89/336/CEE et 73/23/CEE modifiées par la directive 93/68/CEE.

Dit apparaat voldoet aan de eisen van de richtlijnen 89/336/EEG en 73/23/EEG, gewijzigd door 93/68/EEG.

Dette udstyr overholder kravene i direktiv nr. 89/336/EEC og 73/23/EEC med tillæg nr. 93/68/EEC.

Quest' apparecchio è conforme ai requisiti delle direttive 89/336/EEC e 73/23/EEC come emendata dalla direttiva 93/68/EEC.

Η εγκατάσταση αυτή ανταποκρίνεται στις απαιτήσεις των οδηγιών της Ευρωπαϊκής Ένωσης 89/336/EOK και 73/23/EOK, όπως οι κανονισμοί αυτοί συμπληρώθηκαν από την οδηγία 93/68/EOK.

Este equipamento obedece às exigências das directivas 89/336/CEE e 73/23/CEE, na sua versão corrigida pela directiva 93/68/CEE.



Este aparato satisface las exigencias de las Directivas 89/336/CEE y 73/23/CEE, modificadas por medio de la 93/68/CEE.

Denna utrustning uppfyller kraven enligt riktlinjerna 89/336/EEC och 73/23/EEC så som kompletteras av 93/68/EEC.

Dette produktet oppfyller betingelsene i direktivene 89/336/EEC og 73/23/EEC i endringen 93/68/EEC.

Tämä laite täyttää direktiivin 89/336/EEC ja 73/23/EEC vaatimukset, joita on muutettu direktiivillä 93/68/EEC.

SPECIAL NOTE FOR USERS IN THE U.K.

The mains lead of this product is fitted with a non-rewireable (moulded) plug incorporating a 5A fuse. Should the fuse need to be replaced, a BSI or ASTA approved BS 1362 fuse marked  or  and of the same rating as above, which is also indicated on the pin face of the plug, must be used.

Always refit the fuse cover after replacing the fuse. Never use the plug without the fuse cover fitted.

In the unlikely event of the socket outlet in your home not being compatible with the plug supplied, cut off the mains plug and fit an appropriate type.

DANGER

The fuse from the cut-off plug should be removed and the cut-off plug destroyed immediately and disposed of in a safe manner.

Under no circumstances should the cut-off plug be inserted elsewhere into a 5A socket outlet, as a serious electric shock may occur.

To fit an appropriate plug to the mains lead, follow the instructions below:

WARNING:

THIS APPARATUS MUST BE EARTHED.

IMPORTANT:

The wires in this mains lead are coloured in accordance with the following code:

Green-and-yellow : Earth
Blue : Neutral
Brown : Live

As the colours of the wires in the mains lead of this apparatus may not correspond with the coloured markings identifying the terminals in your plug proceed as follows:

- The wire which is coloured green-and-yellow must be connected to the terminal in the plug which is marked by the letter E or by the safety earth symbol  or coloured green or green-and-yellow.
- The wire which is coloured blue must be connected to the terminal which is marked with the letter N or coloured black.
- The wire which is coloured brown must be connected to the terminal which is marked with the letter L or coloured red.

IF YOU HAVE ANY DOUBT, CONSULT A QUALIFIED ELECTRICIAN.

Before using the projector, please read this operation manual carefully.

Introduction

ENGLISH

IMPORTANT

For your assistance in reporting the loss or theft of your Projector, please record the Serial Number located on the bottom of the projector and retain this information. Before recycling the packaging, please be sure that you have checked the contents of the carton thoroughly against the list of "Supplied accessories" on page 14.

Model No.: XV-Z10E

Serial No.:

WARNING: Intense light source. Do not look into the beam or view it directly. Be especially careful that children do not look directly into the beam.



WARNING: To reduce the risk of fire or electric shock, do not expose this product to rain or moisture.

CAUTION: To reduce the risk of electric shock, do not remove cabinet. No user-serviceable parts are inside. Refer servicing to qualified service personnel.

WARNING:

The cooling fan in this projector continues to run for about 90 seconds after the projector enters the standby mode. During normal operation, when putting the projector into the standby mode always use the STANDBY button on the projector or on the remote control. Ensure the cooling fan has stopped before disconnecting the power cord. DURING NORMAL OPERATION, NEVER TURN THE PROJECTOR OFF BY DISCONNECTING THE POWER CORD. FAILURE TO OBSERVE THIS WILL RESULT IN PREMATURE LAMP FAILURE.

Caution Concerning the Lamp Replacement

There is potential glass particles hazard if the lamp ruptures.

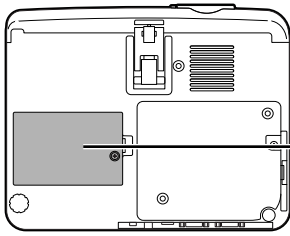

LAMP REPLACEMENT CAUTION

BEFORE REMOVING THE SCREW, DISCONNECT POWER CORD. HOT SURFACE INSIDE. ALLOW 1 HOUR TO COOL BEFORE REPLACING THE LAMP. REPLACE WITH SAME SHARP LAMP UNIT TYPE BQC-PGB10S/1 ONLY.

UV RADIATION : CAN CAUSE EYE DAMAGE. TURN OFF LAMP BEFORE SERVICING.

HIGH PRESSURE LAMP : RISK OF EXPLOSION. POTENTIAL HAZARD OF GLASS PARTICLES IF LAMP HAS RUPTURED. HANDLE WITH CARE. SEE OPERATION MANUAL.

PRECAUTIONS A OBSERVER LORS DU REMPLACEMENT DE LA LAMPE.

DEBRANCHER LE CORDON D'ALIMENTATION AVANT DE RETIRER LA VIS. L'INTERIEUR DU BOITIER ETANT EXTREMEMENT CHAUD, ATTENDRE 1 HEURE AVANT DE PROCEDER AU REMPLACEMENT DE LA LAMPE.

NE REMPLACER QUE PAR UNE LAMPE SHARP DE TYPE BQC-PGB10S/1.

RAYONS ULTRAVIOLETS : PEUVENT ENDOMMAGER LES YEUX. ETEINDRE LA LAMPE AVANT DE PROCEDER A L'ENTRETIEN.

LAMPE A HAUTE PRESSION : RISQUE D'EXPLOSION. DANGER POTENTIEL DE PARTICULES DE VERRE EN CAS D'ECLATEMENT DE LA LAMPE. A MANIPULER AVEC PRECAUTION, SE REPORTER AU MODE D'EMPLOI.

How to Read this Operation Manual

In this operation manual, the illustration and the screen display are simplified for explanation, and may differ slightly from actual display.

Using the Menu Screen

The menu screens allow you to adjust the image and various projector settings. (The menu items differ depending on the input mode.)
The menu can be operated with the projector or with the remote control.

On-screen display

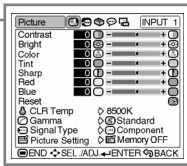

Button used in this step

Buttons used in this operation

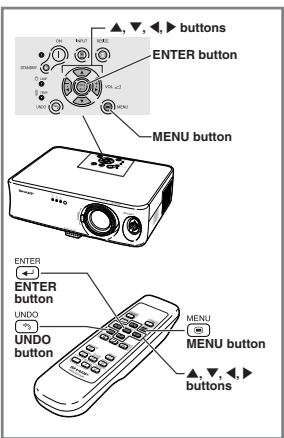

Buttons used in this operation

Menu Selections (Adjustments)

Press 

Note

- The "Picture" menu screen for the selected input mode is displayed.

© 2013-36

 **Info**Indicates safeguards when using the projector.

 **Note**Indicates additional information on setup and operation.

For Future Reference

Maintenance

➔ Page 60

Troubleshooting

➔ Pages 63 and 64

Glossary

➔ Page 67

Contents

Introduction

How to Read this Operation Manual	3
Contents	4
IMPORTANT SAFEGUARDS	5
Quick Reference	8
Part Names	10
Accessories	14
Using the Remote Control	15
Usable Range	15
Inserting the Batteries	15

Connections & Setup

Setting up the Screen	16
Screen Size and Projection Distance	17
Projecting a Reversed Image	18
Connecting the Projector to Other Devices	19
Before Connecting	19
Connecting the Power Cord	20
Connecting to Video Equipment	21
Connecting to Video Equipment with an S-video Output Terminal (INPUT 2)	21
Connecting to Video Equipment without an S-video Output Terminal (INPUT 3)	21
Connecting to Video Equipment with a Component Output Terminal (INPUT 1)	22
Connecting the Projector to a Computer	24
Connecting to a Computer Using the RGB Cable	24
Controlling the Projector Using a Computer	25
Connecting to a Computer Using an RS-232C Cable	25

Basic Operation

Image Projection	26
Truning the Projector on	26
Switching the INPUT Mode	27
Adjusting the Volume	27
Turning off the Sound Temporarily	28
Turning the Power off (Putting the Projector into the Standby Mode)	28
Correcting Trapezoidal Distortion	29
Adjusting the Lens	30
Using the Adjustment Feet	31
Variable Lens Shift Feature	32
Adjusting the Projected Image Position	33
Freeze Image	33
Freezing a Moving Image	33
Selecting the Picture Display Mode	34
Switching the Picture Display Using Different Input Signals	34

Adjustments and Settings

Using the Menu Screen	36
Menu Selections (Adjustments)	36
Menu Selection (Settings)	38
Menu Items	40
Picture Adjustment	42
Adjusting the Image	42
CLR Temp (Adjusting the Colour Temperature)	43
Gamma (Gamma Correction)	43
Signal Type (Signal Type Setting)	44
Memory (Storing and Selecting the Adjustment Settings)	44
Computer Image Adjustment	45
Adjusting the Computer Image	45
Special Modes (Special Mode Settings)	45
Auto Sync (Auto Sync Adjustment)	46
Signal Info (Checking the Input Signal)	46
Using the "Options" Menu	47
Lamp Timer (Life) (Checking the Lamp Life Status)	47
OSD Display (Setting On-screen Display)	47
Video System (Setting the Video System)	48
Background (Selecting a Startup and Background Image)	48
Eco Mode (Setting the Eco Mode)	49
Auto Power Off (Auto Power Off Function)	49
Menu Position (Selecting the Menu Screen Position) ...	50
Menu Color (Selecting the Menu Colour)	50
Selecting the On-screen Display Language and the Projection Mode	51
Selecting the On-screen Display Language	51
Reversing the Projected Image	51

Appendix

Maintenance Indicators	52
Replacing the Lamp	54
Lamp	54
Caution Concerning the Lamp	54
Replacing the Lamp	54
Removing and Installing the Lamp Unit	55
Resetting the Lamp Timer	56
Connecting Pin Assignments	57
RS-232C Specifications and Command Settings	58
Computer Compatibility Chart	59
Maintenance	60
Replacing the Air Filter	61
Cleaning and Replacing the Air Filter	61
Troubleshooting	63
Specifications	65
Dimensions	66
Glossary	67
Index	68

IMPORTANT SAFEGUARDS

CAUTION: Please read all of these instructions before you operate this product and save these instructions for later use.

Electrical energy can perform many useful functions. This product has been engineered and manufactured to assure your personal safety. BUT IMPROPER USE CAN RESULT IN POTENTIAL ELECTRICAL SHOCK OR FIRE HAZARDS. In order not to defeat the safeguards incorporated in this product, observe the following basic rules for its installation, use and servicing.

1. Read Instructions

All the safety and operating instructions should be read before the product is operated.

2. Retain Instructions

The safety and operating instructions should be retained for future reference.

3. Heed Warnings

All warnings on the product and in the operating instructions should be adhered to.

4. Follow Instructions

All operating and use instructions should be followed.

5. Cleaning

Unplug this product from the wall outlet before cleaning. Do not use liquid cleaners or aerosol cleaners. Use a damp cloth for cleaning.

6. Attachments

Do not use attachments not recommended by the product manufacturer as they may cause hazards.

7. Water and Moisture

Do not use this product near water—for example, near a bath tub, wash bowl, kitchen sink, or laundry tub; in a wet basement; or near a swimming pool; and the like.

8. Accessories

Do not place this product on an unstable cart, stand, tripod, bracket, or table. The product may fall, causing serious injury to a child or adult, and serious damage to the product. Use only with a cart, stand, tripod, bracket, or table recommended by the manufacturer, or sold with the product. Any mounting of the product should follow the manufacturer's instructions, and should use a mounting accessory recommended by the manufacturer.

9. Transportation

A product and cart combination should be moved with care. Quick stops, excessive force, and uneven surfaces may cause the product and cart combination to overturn.



10. Ventilation

Slots and openings in the cabinet are provided for ventilation to ensure reliable operation of the product and to protect it from overheating, and these openings must not be blocked or covered. The openings should never be blocked by placing the product on a bed, sofa, rug, or other similar surface. This product should not be placed in a built-in installation such as a bookcase or rack unless proper ventilation is provided or the manufacturer's instructions have been adhered to.

11. Power Sources

This product should be operated only from the type of power source indicated on the marking label. If you are not sure of the type of power supply to your home, consult your product dealer or local power company. For products intended to operate from battery power, or other sources, refer to the operating instructions.

12. Grounding or Polarization

This product is provided with one of the following types of plugs. If the plug should fail to fit into the power outlet, please contact your electrician.

Do not defeat the safety purpose of the plug.

- Two-wire type (mains) plug.
- Three-wire grounding type (mains) plug with a grounding terminal.
This plug will only fit into a grounding type power outlet.

13. Power-Cord Protection

Power-supply cords should be routed so that they are not likely to be walked on or pinched by items placed upon or against them, paying particular attention to cords at plugs, convenience receptacles, and the point where they exit from the product.

14. Lightning

For added protection for this product during a lightning storm, or when it is left unattended and unused for long periods of time, unplug it from the wall outlet and disconnect the cable system. This will prevent damage to the product due to lightning and power-line surges.

15. Overloading

Do not overload wall outlets, extension cords, or integral convenience receptacles as this can result in a risk of fire or electric shock.

16. Object and Liquid Entry

Never push objects of any kind into this product through openings as they may touch dangerous voltage points or short-out parts that could result in a fire or electric shock. Never spill liquid of any kind on the product.

17. Servicing

Do not attempt to service this product yourself as opening or removing covers may expose you to dangerous voltage or other hazards. Refer all servicing to qualified service personnel.

18. Damage Requiring Service

Unplug this product from the wall outlet and refer servicing to qualified service personnel under the following conditions:

- When the power-supply cord or plug is damaged.
- If liquid has been spilled, or objects have fallen into the product.
- If the product has been exposed to rain or water.
- If the product does not operate normally by following the operating instructions. Adjust only those controls that are covered by the operating instructions, as an improper adjustment of other controls may result in damage and will often require extensive work by a qualified technician to restore the product to normal operation.
- If the product has been dropped or damaged in any way.
- When the product exhibits a distinct change in performance, this indicates a need for service.

19. Replacement Parts

When replacement parts are required, be sure the service technician has used replacement parts specified by the manufacturer or have the same characteristics as the original part. Unauthorised substitutions may result in fire, electric shock, or other hazards.

20. Safety Check

Upon completion of any service or repairs to this product, ask the service technician to perform safety checks to determine that the product is in proper operating condition.

21. Wall or Ceiling Mounting

This product should be mounted to a wall or ceiling only as recommended by the manufacturer.

22. Heat

This product should be situated away from heat sources such as radiators, heat registers, stoves, or other products (including amplifiers) that produce heat.

- Microsoft and Windows are registered trademarks of Microsoft Corporation in the United States and/or other countries.
- PC/AT is a registered trademark of International Business Machines Corporation in the United States.
- Macintosh is a registered trademark of Apple Computer, Inc. in the United States and/or other countries.
- All other company or product names are trademarks or registered trademarks of their respective companies.

Be sure to read the following safeguards when setting up your projector.

Caution concerning the lamp unit

- Potential hazard of glass particles if lamp ruptures. In case of lamp rupture, contact your nearest Sharp Authorised Projector Dealer or Service Centre for a replacement.
See "Replacing the Lamp" on page 54.

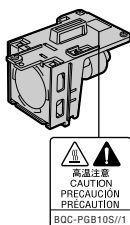

Caution concerning the setup of the projector

- For minimal servicing and to maintain high image quality, SHARP recommends that this projector be installed in an area free from humidity, dust and cigarette smoke. When the projector is subjected to these environments, the lens and part of filter must be cleaned more often than usual. As long as the projector is properly maintained in this manner, use in these environments will not reduce the overall operation life. Please note that all internal cleaning must be performed by a Sharp Authorised Projector Dealer or Service Centre.

Do not set up the projector in places exposed to direct sunlight or bright light.

- Position the screen so that it is not in direct sunlight or room light. Light falling directly on the screen washes out the colours, making viewing difficult. Close the curtains and dim the lights when setting up the screen in a sunny or bright room.

The projector may be safely tilted to a maximum angle of 12 degrees.

- Placement should be within ± 12 degrees of horizontal.

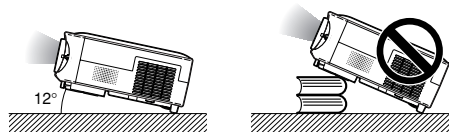

Do not subject the projector to hard impact and/or vibration.

- Take care with the lens so as not to hit or damage the surface of the lens.

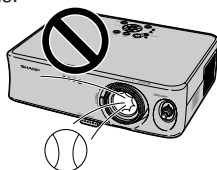

Do not mount the projector on a ceiling by turning it over.

- Use the lens shift feature when projecting the image from a high position.

Rest your eyes occasionally.

- Continuously watching the screen for long hours will cause eye strain. Be sure to occasionally rest your eyes.

Avoid locations with extremes of temperature.

- The operating temperature of the projector is from $+5^{\circ}\text{C}$ to $+35^{\circ}\text{C}$.
- The storage temperature of the projector is from -20°C to $+60^{\circ}\text{C}$.

Do not block the exhaust and intake vents.

- Allow at least 20 cm of space between the exhaust vent and the nearest wall or obstruction.
- Be sure that the intake vent and the exhaust vent are not obstructed.
- If the cooling fan becomes obstructed, a protection circuit will automatically put the projector into the standby mode. This does not indicate a malfunction. Remove the projector power cord from the wall outlet and wait at least 10 minutes. Place the projector where the intake and exhaust vents are not blocked, plug the power cord back in and turn on the projector. This will return the projector to the normal operating condition.

Caution regarding transportation of the projector

- When transporting the projector, be sure not to subject it to hard impact and/or vibration, as this can result in damage. Take extra care with the lens. Before moving the projector, be sure to unplug the power cord from the wall outlet, and disconnect any other cables connected to it.
- Do not carry the projector by holding the lens.
- When transporting the projector, be sure to attach the lens shipping block and the lens cap to the projector.

Other connected equipment

- When connecting a computer or other audio-visual equipment to the projector, make the connections AFTER unplugging the power cord of the projector from the wall outlet and turning off the equipment to be connected.
- Please read the operation manuals of the projector and the equipment to be connected for instructions on how to make the connections.

Using the projector in other countries

- The power supply voltage and the shape of the plug may vary depending on the region or country you are using the projector in. When using the projector overseas, be sure to use an appropriate power cord for the country you are in.

Temperature monitor function

- If the projector starts to overheat due to setup problems or blockage of the air vents, "X" and "TEMP." will illuminate in the lower left corner of the picture. If the temperature continues to rise, the lamp will turn off, the temperature warning indicator on the projector will blink, and after a 90-second cooling-off period the projector will enter the standby mode. Refer to "Maintenance Indicators" on page 52 for details.



Info

- The cooling fan regulates the internal temperature, and its performance is automatically controlled. The sound of the fan may change during projector operation due to changes in the fan speed. This does not indicate malfunction.
- Do not unplug the power cord during projection or cooling fan operation. This can cause damage due to rise in internal temperature, as the cooling fan also stops.

Quick Reference

This section introduces the quick reference for using the projector. Refer to the page for details on each procedure.

Setup and Projection

Connection of the projector and the video equipment with an S-video terminal is explained as an example below.

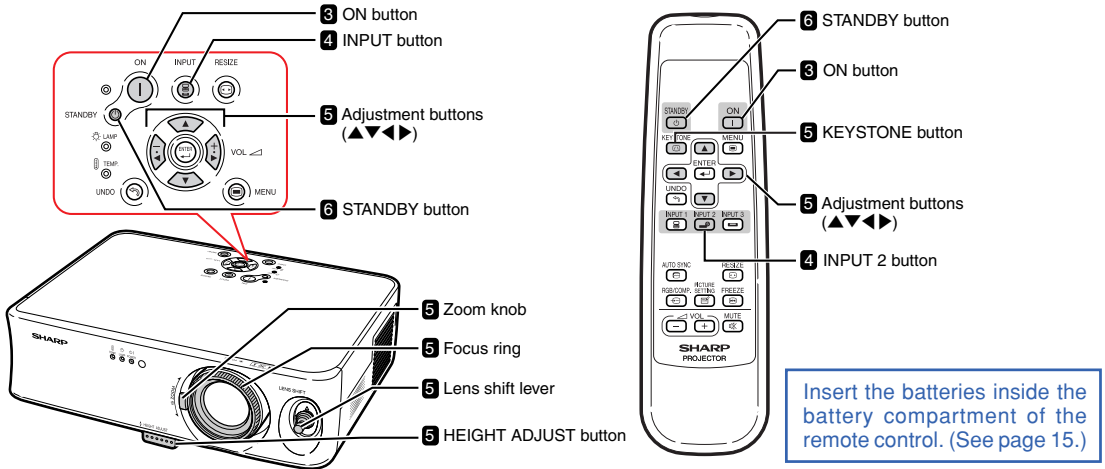

1. Place the projector facing a wall or a screen

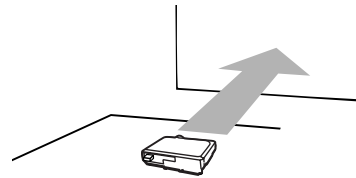

→ Page 16

2. Connect the projector to the video equipment and plug the power cord into the AC socket of the projector

After connecting, play back the video image.

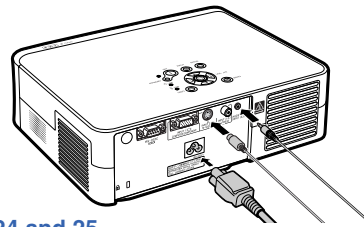

When connecting other devices, see pages 12, 22, 23, 24 and 25.

→ Pages 20, 21

3. Turn the projector on

Press the ON button to turn the projector on.

On the projector



On the remote control



→ Page 26

4. Select the INPUT mode

Select "INPUT 2" using the INPUT button on the projector or the INPUT 2 button on the remote control.

<p>On the projector</p> 	<p>On the remote control</p> 	<p>▼On-screen Display</p> 
---	--	---

- When pressing  on the projector, input mode switches in order of INPUT 1 → INPUT 2 → INPUT 3.
- When using the remote control, press  /  /  to switch the input mode.

➔ Page 27

5. Adjust the projected image

① Bring the projected image into focus and adjust the projected image size

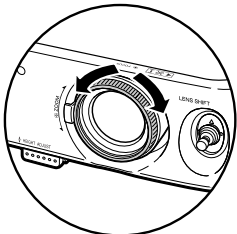
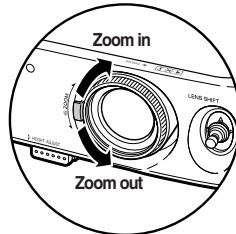
<p>Focus</p> <ul style="list-style-type: none"> • Bring the projected image into focus using the focus ring. 	<p>Zoom</p> <ul style="list-style-type: none"> • Adjust the projected image size using the zoom knob. 
--	--

➔ Page 30

➔ Page 30

② Adjust the projected image position and the projector angle

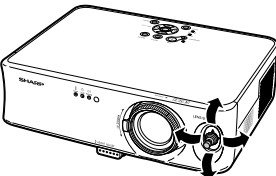
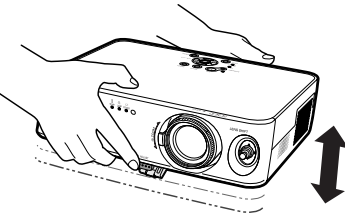
<p>Projection position</p> <ul style="list-style-type: none"> • Adjust the projected image position using the lens shift lever. 	<p>Angle</p> <ul style="list-style-type: none"> • Adjust the projector angle using the HEIGHT ADJUST button. 
---	--

➔ Page 32

➔ Page 31

③ Correct trapezoidal distortion

Correcting trapezoidal distortion using the Keystone Correction

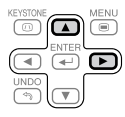
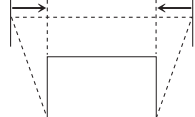
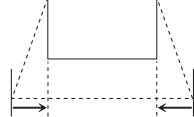
<p>On the remote control</p> <p>KEYSTONE </p> 	<p>Compresses upper side.</p> 	<p>Compresses lower side.</p> 
--	---	--

➔ Page 29

6. Turn the power off

Press the STANDBY button, then press that button again while the confirmation message is displayed, to put the projector into the standby mode.

<p>On the projector</p> 	<p>On the remote control</p> 	<p>▼On-screen Display</p> 
---	--	--

- Unplug the power cord from the wall outlet after the cooling fan stops.

➔ Page 28

Part Names

Numbers in **■** refer to the main pages in this operation manual where the topic is explained. The appearance of the product is subject to change without notice.

Projector (Front and Top View)

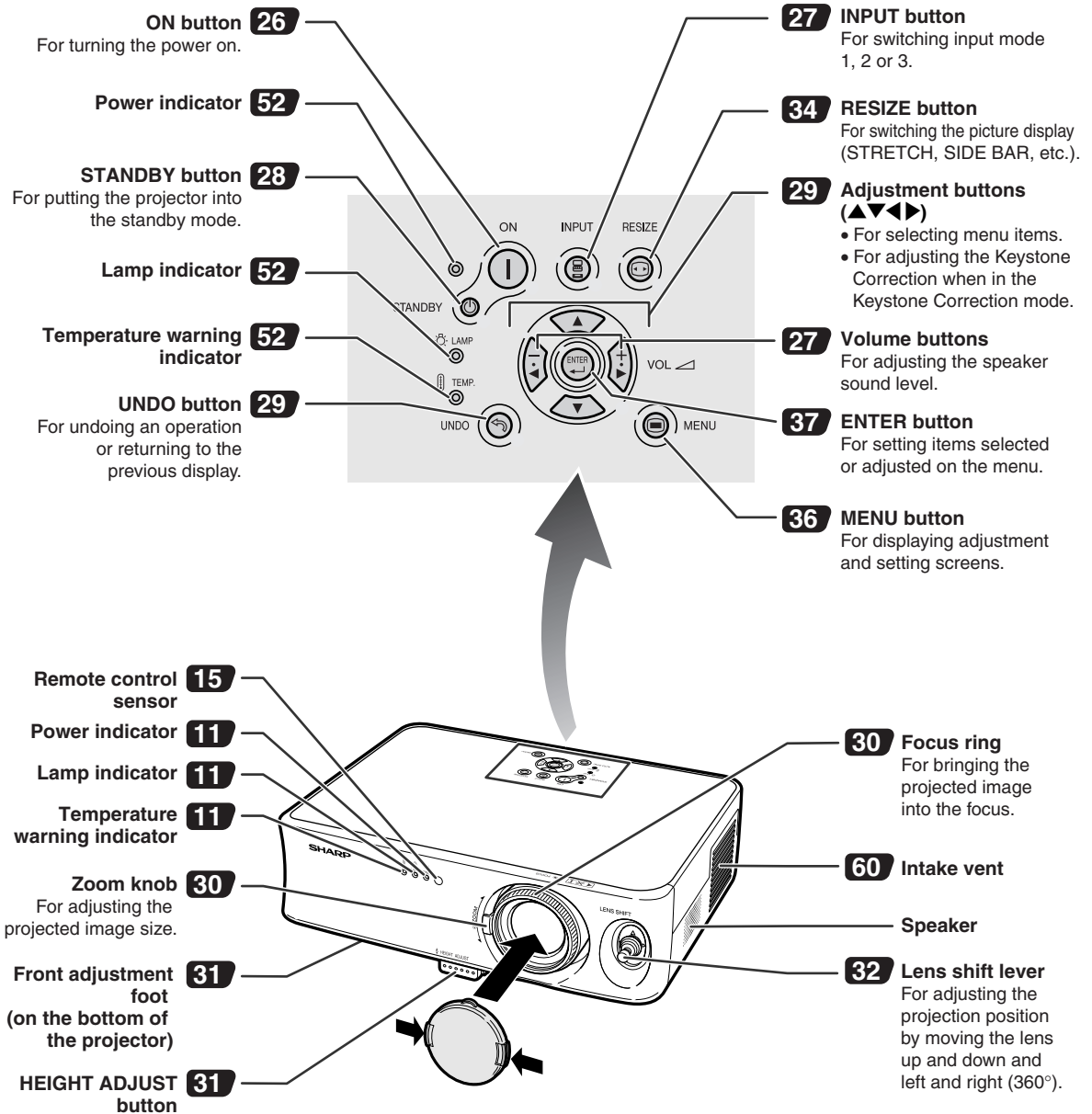

Attaching and removing the lens cap

- Press on the two buttons of the lens cap and attach it to the lens, then release the buttons to lock it in place.
- Press on the two buttons of the lens cap and remove it from the lens.

About the Indicators on the Projector

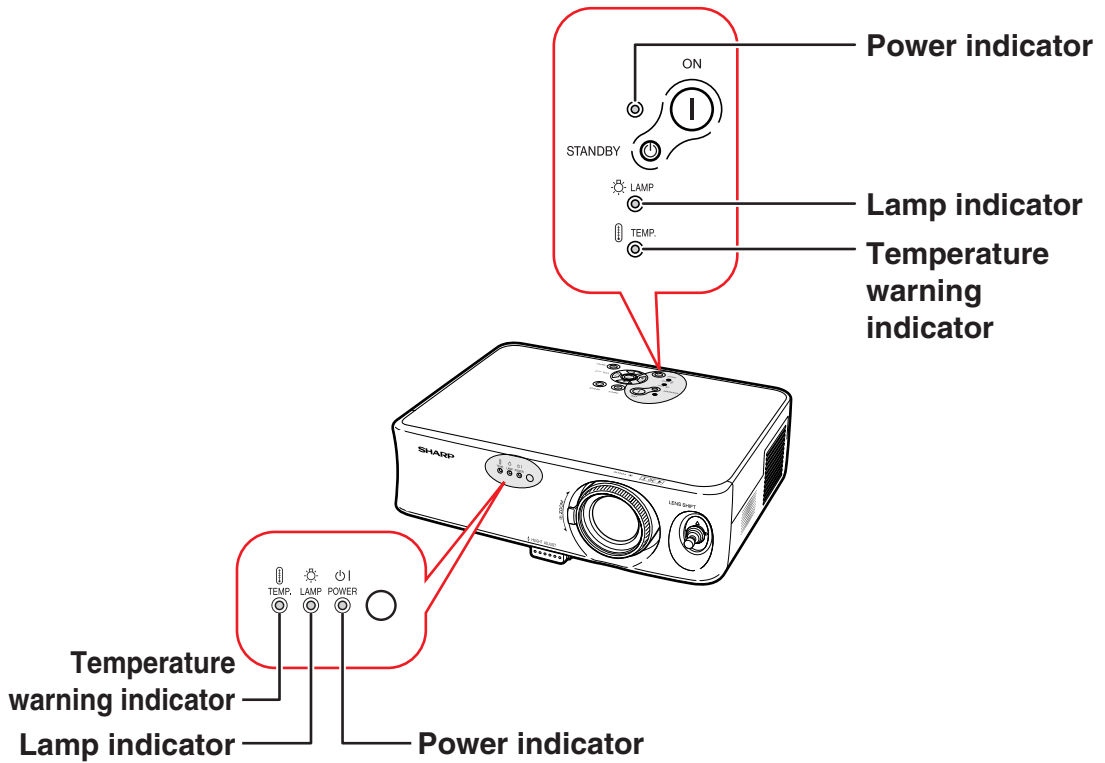

Maintenance indicators	Status of the lamp	Page
Power indicator	Green on/Red on ... Normal Red blinks ... Abnormal	52
Lamp indicator	Green on ... Normal Green blinks ... The lamp is warming up. Red on ... Change the lamp.	52
Temperature warning indicator	Off ... Normal Red on ... The internal temperature is abnormally high.	52

Attaching and Removing the Lens Shipping Block

When attaching the lens shipping block, be sure to return the lens shift lever to the centre position. If the lens is shifted upwards or downwards, the lens shipping block cannot be attached.



Projector (Rear View)

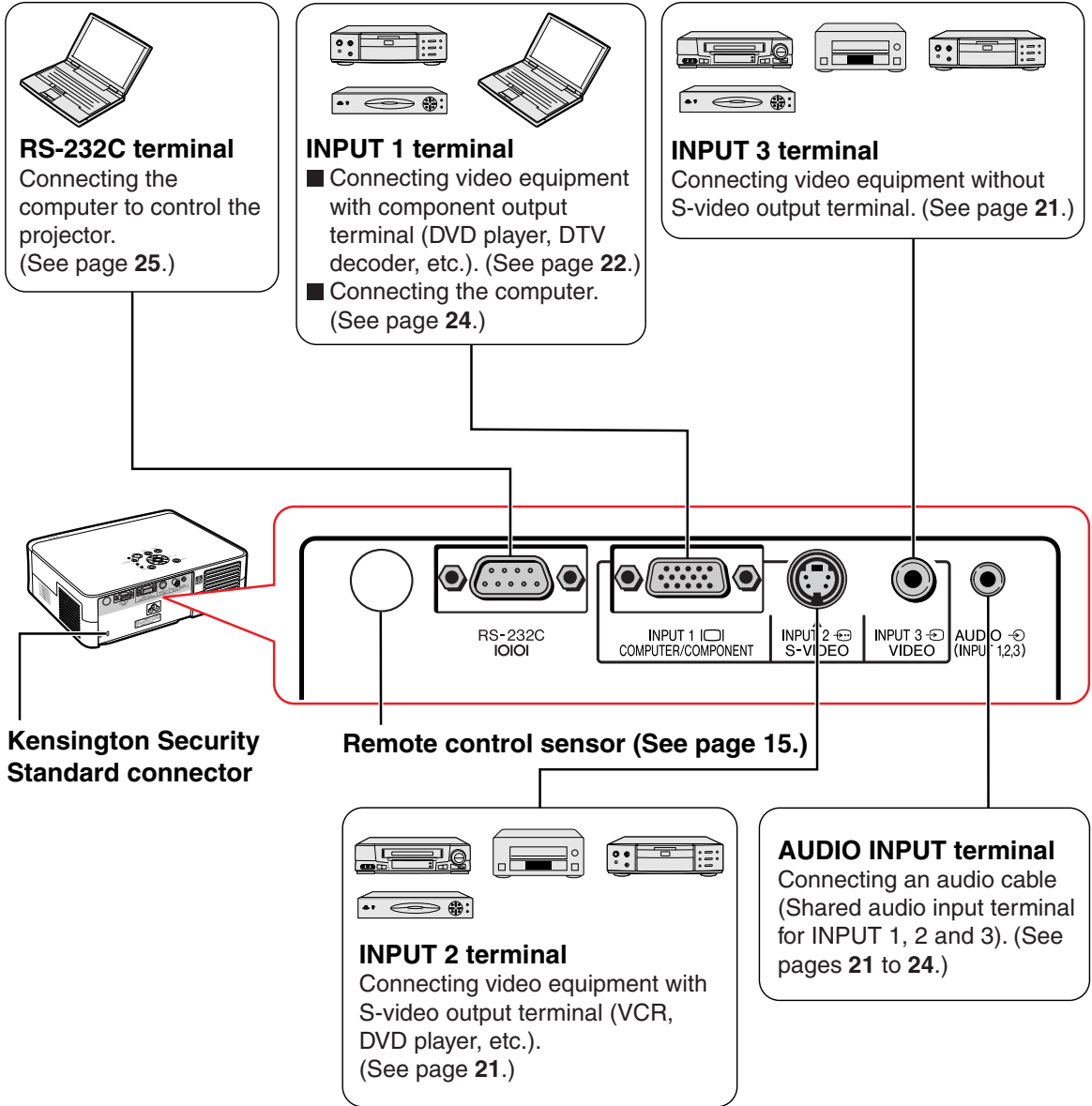

Using the Kensington Lock

- This projector has a Kensington Security Standard connector for use with a Kensington MicroSaver Security System. Refer to the information that came with the system for instructions on how to use it to secure the projector.

Numbers in **■** refer to the main pages in this operation manual where the topic is explained.

Remote Control (Front View)

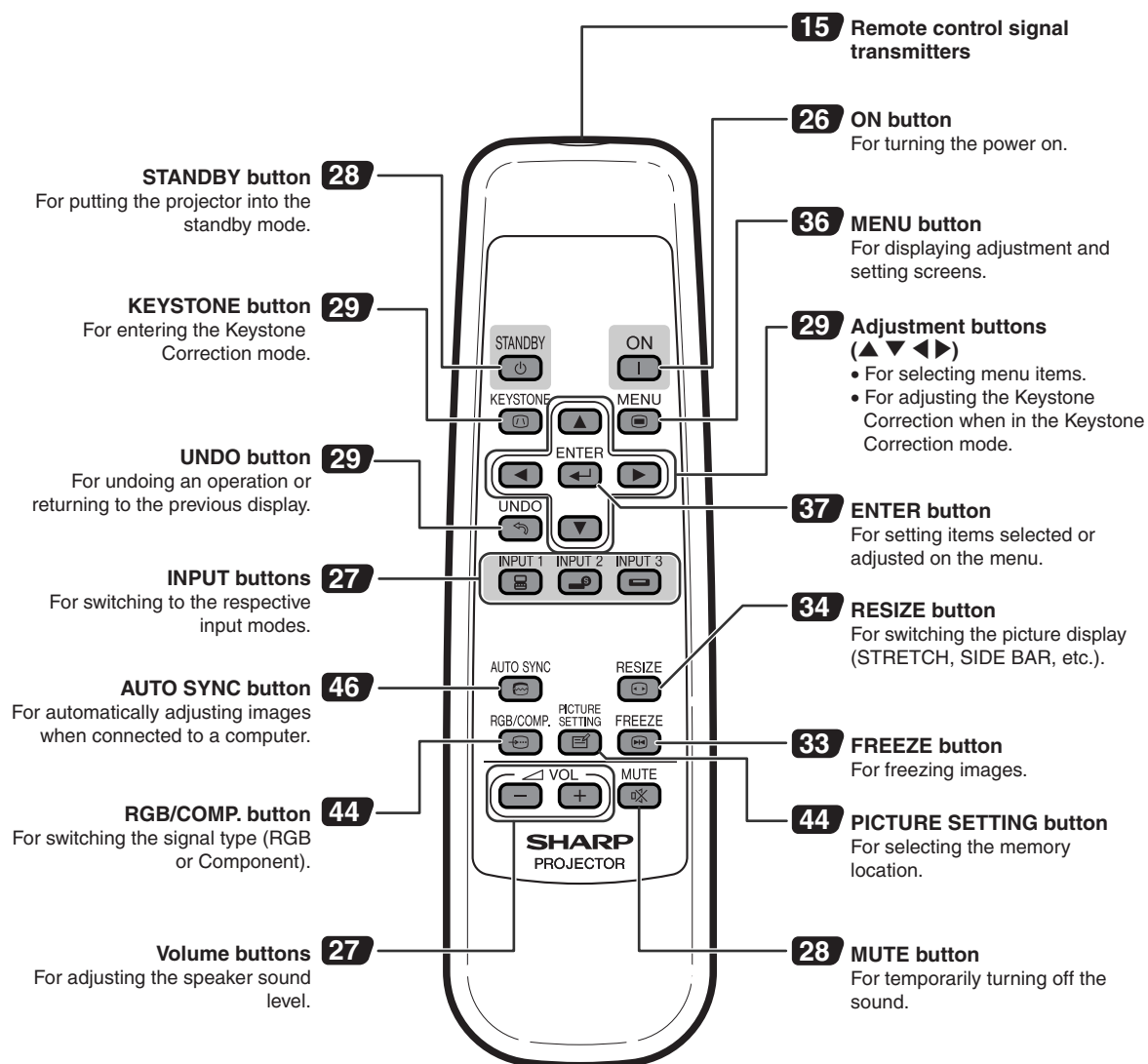

Accessories

Supplied accessories



Remote control



Two AA size batteries

Power cord*

(1)

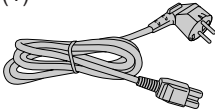

For Europe, except U.K.
(1.8 m)

(2)

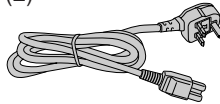

For U.K., Hong Kong and
Singapore
(1.8 m)

(3)

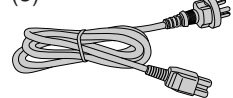

For Australia, New
Zealand and Oceania
(1.8 m)

* Use the power cord that corresponds to the wall outlet in your country.



Video cable

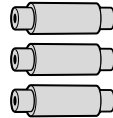

Three RCA adapter plugs

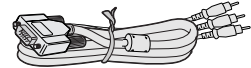

3 RCA to 15-pin D-sub cable
(3.0 m)

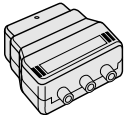

21 pin RCA
conversion adapter
(Supplied for Europe only)

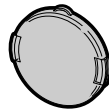

Lens cap (attached)

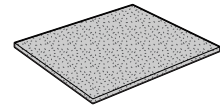

Extra air filter

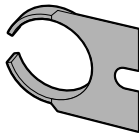

Lens shipping block (attached)

Operation manual

Optional accessory

■ Computer RGB cable (10.0 m) AN-C10BM (15-pin mini D-sub male connector)

- Some cables cannot be used because of the shape of the connector. Check the specification on the computer. You may need an adapter (commercially available) for connection.

Note

- Some of the accessories may not be available depending on the region. Please check with your nearest Sharp Authorised Projector Dealer or Service Centre.

Using the Remote Control

Usable Range

The remote control can be used to control the projector within the ranges shown in the illustration.

Note

- The signal from the remote control can be reflected off a screen for easy operation. However, the effective distance of the signal may differ depending on the screen material.

When using the remote control:

- Be sure not to drop, expose to moisture or high temperature.
- The remote control may malfunction under a fluorescent lamp. In this case, move the projector away from the fluorescent lamp.

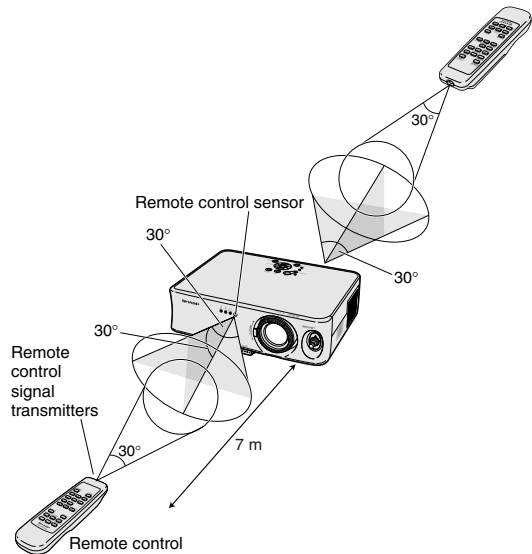

Inserting the Batteries

The batteries (two “AA” size) are supplied in the package.

- 1** Press the ▲ mark on the cover and slide it in the direction of the arrow.
- 2** Insert the batteries.
 - Insert the batteries making sure the polarities correctly match the ⊕ and ⊖ marks inside the battery compartment.
- 3** Attach the cover and slide it until it clicks into place.

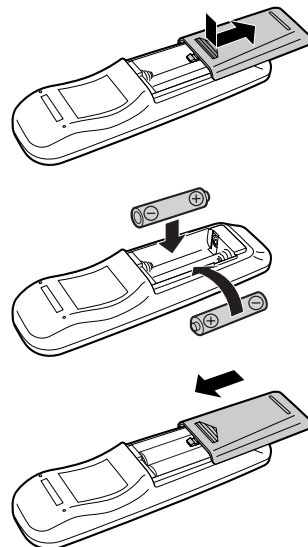

Incorrect use of the batteries may cause them to leak or explode. Please follow the precautions below.

⚠ Caution

- Insert the batteries making sure the polarities correctly match the ⊕ and ⊖ marks inside the battery compartment.
- Batteries of different types have different properties, therefore do not mix batteries of different types.
- Do not mix new and old batteries.
This may shorten the life of new batteries or may cause old batteries to leak.
- Remove the batteries from the remote control once they have run out, as leaving them in can cause them to leak. Battery fluid from leaked batteries is harmful to skin, therefore be sure to first wipe them and then remove them using a cloth.

- The batteries included with this projector may run down in a short period, depending on how they are kept. Be sure to replace them as soon as possible with new batteries.
- Remove the batteries from the remote control if you will not be using the remote control for a long time.

Setting up the Screen

Position the projector perpendicular to the screen with all feet flat and level (without using the adjustment feet) to achieve an optimal image.

Note

- The projector lens should be centred in the middle of the screen. If the horizontal line passing through the lens centre is not perpendicular to the screen, the image will be distorted, making viewing difficult.
- For an optimal image, position the screen so that it is not in direct sunlight or room light. Light falling directly on the screen washes out the colours, making viewing difficult. Close the curtains and dim the lights when setting up the screen in a sunny or bright room.
- A polarising screen cannot be used with this projector.

Standard Setup (Front Projection)

- Place the projector at the required distance from the screen according to the desired picture size. (See page 17.)

Example of standard setup

Screen size : 100 inch (254 cm) (when using a wide screen (16:9))

Side View

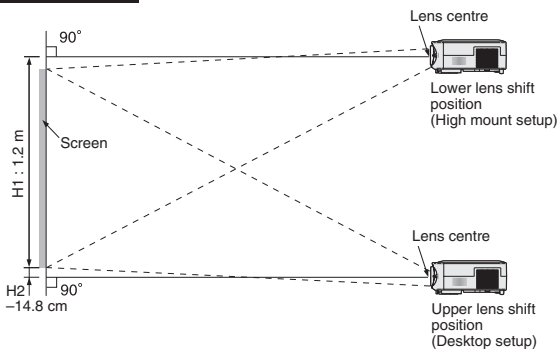

- The distance from the screen to the projector may vary depending on the size of the screen. **Page 17**

- The default setting can be used, when placing the projector in front of the screen. If the projected image is reversed, readjust the setting to "Front" in the "PRJ Mode" menu. **Page 51**

Top View

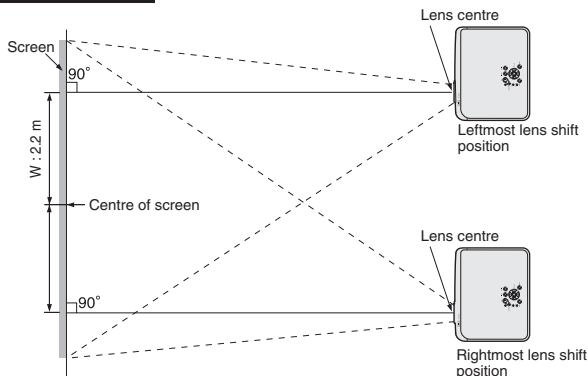

- Place the projector so that an imaginary horizontal line that passes through the centre of the lens is perpendicular to the screen.

Screen Size and Projection Distance

When using a wide screen (16:9)

In case of displaying the 16:9 picture on the whole of the 16:9 screen.

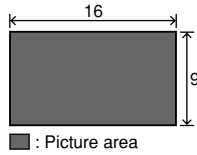

Picture (Screen) size			Projection distance [L]		Distance from the lens centre to the bottom of the image [H]		Distance from the lens centre to the centre of the image [W]	
Diag. [χ]	Width	Height	Minimum [L1]	Maximum [L2]	Lower [H1]	Upper [H2]	Left	Right
300	6.6 m	3.7 m	9.2 m	11.5 m	418.5 cm	-44.3 cm	178.5 cm	178.5 cm
250	5.5 m	3.1 m	7.7 m	9.6 m	348.8 cm	-36.9 cm	148.8 cm	148.8 cm
225	5.0 m	2.8 m	6.9 m	8.6 m	313.9 cm	-33.2 cm	133.9 cm	133.9 cm
200	4.4 m	2.5 m	6.1 m	7.7 m	279.0 cm	-29.5 cm	119.0 cm	119.0 cm
150	3.3 m	1.9 m	4.6 m	5.7 m	209.3 cm	-22.1 cm	89.3 cm	89.3 cm
133	2.9 m	1.7 m	4.1 m	5.1 m	185.5 cm	-19.6 cm	79.1 cm	79.1 cm
106	2.4 m	1.3 m	3.2 m	4.0 m	147.9 cm	-15.6 cm	63.1 cm	63.1 cm
100	2.2 m	1.3 m	3.0 m	3.8 m	139.5 cm	-14.8 cm	59.5 cm	59.5 cm
92	2.0 m	1.2 m	2.8 m	3.5 m	128.3 cm	-13.6 cm	54.7 cm	54.7 cm
84	1.9 m	1.1 m	2.6 m	3.2 m	117.2 cm	-12.4 cm	50.0 cm	50.0 cm
72	1.6 m	0.9 m	2.2 m	2.7 m	100.4 cm	-10.6 cm	42.8 cm	42.8 cm
60	1.3 m	0.7 m	1.8 m	2.3 m	83.7 cm	-8.9 cm	35.7 cm	35.7 cm
40	0.9 m	0.5 m	1.2 m	1.5 m	55.8 cm	-5.9 cm	23.8 cm	23.8 cm

χ: Picture size (diag.) (inch)
 L: Projection distance (m)
 L1: Minimum projection distance (m)
 L2: Maximum projection distance (m)
 H: Distance from the lens centre to the bottom of the image (cm)
 H1: Lower distance from the lens centre to the bottom of the image (cm)
 H2: Upper distance from the lens centre to the bottom of the image (cm)
 W: Distance from the lens centre to the centre of the image (cm)

The formula for picture size and projection distance
 $L1 (m) = 0.0308χ - 0.035$
 $L2 (m) = 0.0385χ - 0.035$
 $H1 (cm) = 1.395χ$
 $H2 (cm) = 0.1475χ$
 $W (cm) = 0.595χ$

When using a normal screen (4:3)

In case of setting the 16:9 picture to the full horizontal width of the 4:3 screen.

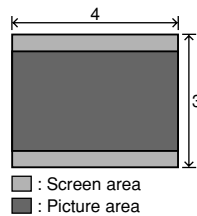

Picture (Screen) size			Projection distance [L]		Distance from the lens centre to the bottom of the image [H]		Distance from the lens centre to the centre of the image [W]	
Diag. [χ]	Width	Height	Minimum [L1]	Maximum [L2]	Lower [H1]	Upper [H2]	Left	Right
300	6.1 m	4.6 m	8.5 m	10.6 m	384.3 cm	-40.6 cm	163.5 cm	163.5 cm
250	5.1 m	3.8 m	7.0 m	8.8 m	320.3 cm	-33.8 cm	136.3 cm	136.3 cm
200	4.1 m	3.0 m	5.6 m	7.0 m	256.2 cm	-27.0 cm	109.0 cm	109.0 cm
150	3.0 m	2.3 m	4.2 m	5.3 m	192.2 cm	-20.3 cm	81.8 cm	81.8 cm
100	2.0 m	1.5 m	2.8 m	3.5 m	128.1 cm	-13.5 cm	54.5 cm	54.5 cm
84	1.7 m	1.3 m	2.3 m	2.9 m	107.6 cm	-11.4 cm	45.8 cm	45.8 cm
72	1.5 m	1.1 m	2.0 m	2.5 m	92.2 cm	-9.7 cm	39.2 cm	39.2 cm
60	1.2 m	0.9 m	1.7 m	2.1 m	76.9 cm	-8.1 cm	32.7 cm	32.7 cm
40	0.8 m	0.6 m	1.1 m	1.4 m	51.2 cm	-5.4 cm	21.8 cm	21.8 cm

χ: Picture size (diag.) (inch)
 L: Projection distance (m)
 L1: Minimum projection distance (m)
 L2: Maximum projection distance (m)
 H: Distance from the lens centre to the bottom of the image (cm)
 H1: Lower distance from the lens centre to the bottom of the image (cm)
 H2: Upper distance from the lens centre to the bottom of the image (cm)
 W: Distance from the lens centre to the centre of the image (cm)

The formula for picture size and projection distance
 $L1 (m) = 0.0283χ - 0.032$
 $L2 (m) = 0.0353χ - 0.032$
 $H1 (cm) = 1.281χ$
 $H2 (cm) = 0.1352χ$
 $W (cm) = 0.545χ$

Note

- There may be an error of $\pm 3\%$ in the above values.
- Values with a minus (-) sign indicate the distance from the lens centre below the bottom of the image.

Indication of the Projection Image Size and Projection Distance

Example : When using a wide screen (16:9)

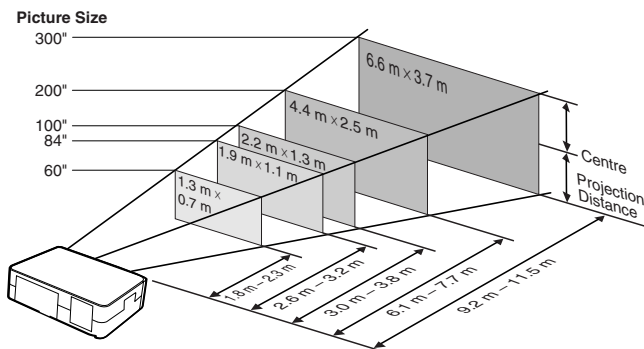

Projecting a Reversed Image

Projection from behind the Screen

- Place a translucent screen between the projector and the audience.
- Reverse the image by setting “Rear” in the “PRJ Mode” menu. (See page 51.)

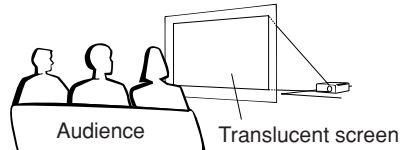

Projection Using a Mirror

- Place a mirror (normal flat type) in front of the lens.
- When the translucent screen is placed on between the mirror and audience, set to “Front” in the “PRJ Mode” menu. (See page 51.)
- When the mirror is placed on the audience side, set to “Rear” in the “PRJ Mode” menu. (See page 51.)

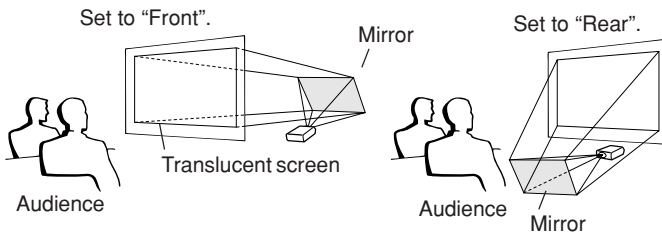

Info

- When using a mirror, be sure to carefully position both the projector and the mirror so the light does not shine into the eyes of the audience.

When the image is projected from behind the translucent screen using the default setting.

▼On-screen Display



Set to “Rear”.



▼On-screen Display

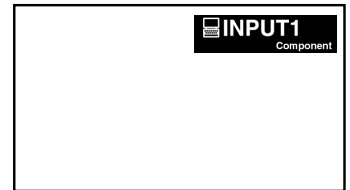

The image is reversed.

Connecting the Projector to Other Devices

Before Connecting



Note

- Before connecting, be sure to unplug the power cord of the projector from the wall outlet and turn off the devices to be connected. After making all connections, turn on the projector and then the other devices. When connecting a computer, be sure that it is the last device to be turned on after all the connections are made.
- Be sure to read the operation manuals of the devices to be connected before making connections.

This projector can be connected to:

Video equipment or audio-visual equipment:

- A VCR or other audio-visual equipment (See page 21.)
- A DVD player or DTV* decoder (See page 22.)

*DTV is the umbrella term used to describe the new digital television system in the United States.

A computer using:

- An RGB cable (commercially available or sold separately) (See page 24.)
- An RS-232C cable (null modem, cross type, commercially available) for controlling the projector (See page 25.)

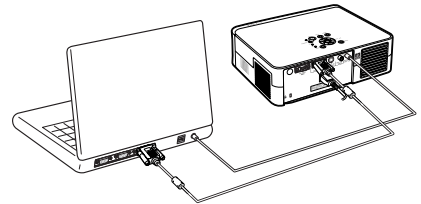
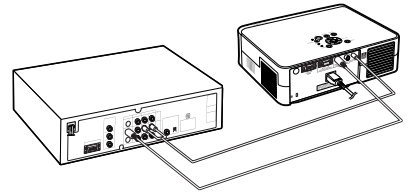

Connecting the thumbscrew cables

- Connect the thumbscrew cable making sure that it fits correctly into the terminal. Then, firmly secure the connectors by tightening the screws on both sides of the plug.

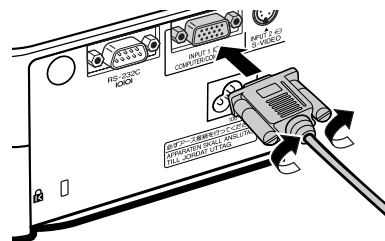

Connecting the Projector to Other Devices

Connecting the Power Cord

Plug the supplied power cord into the AC socket on the rear of the projector.

Note

- The projector is put into standby mode by plugging the power cord into the wall outlet after first turning the projector off and then unplugging the power cord from the wall outlet.

Supplied
accessory

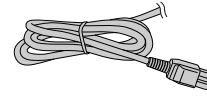

Power cord

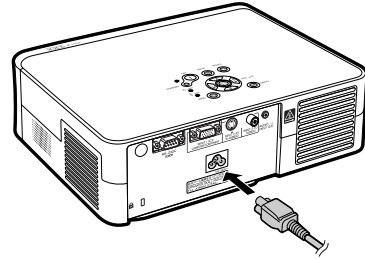

Connecting to Video Equipment

Connecting to Video Equipment with an S-video Output Terminal (INPUT 2)

Using a commercially available S-video or audio cable, a VCR or other audio-visual equipment can be connected to INPUT 2 and AUDIO INPUT terminals.

- 1 Connect the projector to the video equipment using an S-video cable (commercially available).
- 2 Connect the projector to the video equipment using a $\varnothing 3.5$ mm minijack to RCA audio cable (commercially available).

Note

- The INPUT 2 (S-VIDEO) terminal uses a video signal system in which the picture is separated into colour and luminance signals to realise a higher-quality image. To view a higher-quality image, use a commercially available S-video cable to connect the INPUT 2 terminal on the projector and the S-video output terminal on the video equipment.
- A $\varnothing 3.5$ mm minijack to RCA audio cable (commercially available) is required for audio input.

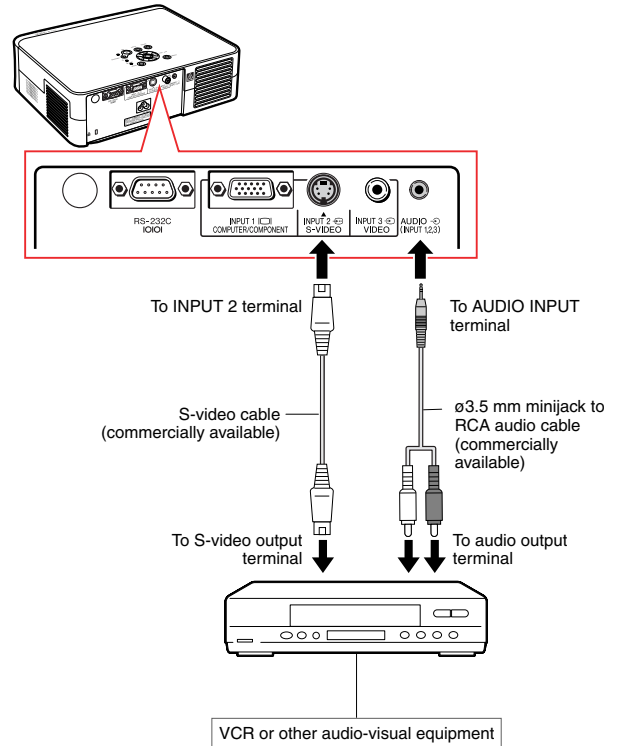

Connecting to Video Equipment without an S-video Output Terminal (INPUT 3)

Using a composite video cable or audio cable, a VCR or other audio-visual equipment can be connected to INPUT 3 and AUDIO INPUT terminals.

- 1 Connect the projector to the video equipment using a composite video cable.
- 2 Connect the projector to the video equipment using a $\varnothing 3.5$ mm minijack to RCA audio cable (commercially available).

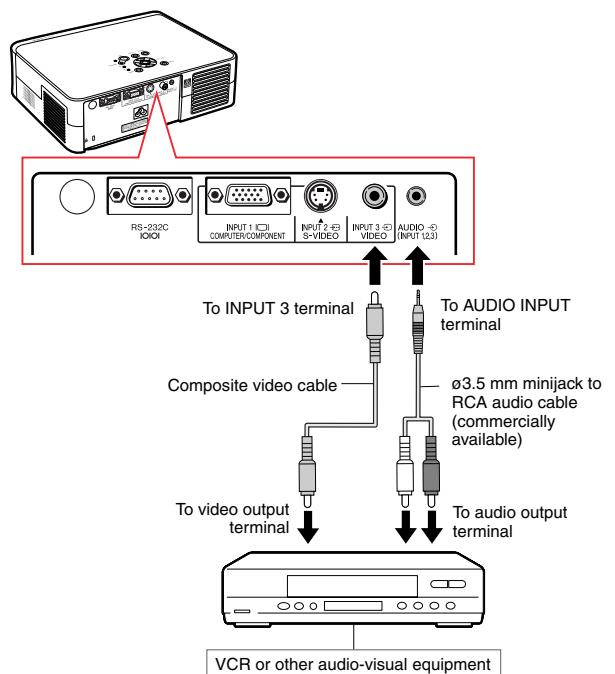

Connecting the Projector to Other Devices

Connecting to Video Equipment with a Component Output Terminal (INPUT 1)

Use a supplied 3 RCA to 15-pin D-sub cable when connecting to the INPUT 1 terminal, component video equipment such as DVD players and DTV* decoders.

*DTV is the umbrella term used to describe the new digital television system in the United States.

1 Connect the projector to the video equipment using the 3 RCA to 15-pin D-sub cable.

- Secure the connectors by tightening the thumbscrews.

2 Connect the projector to the video equipment using a ø3.5 mm minijack to RCA audio cable (commercially available).

Note

- When connecting the projector to the component video equipment, set “Signal Type” on the “Picture” menu to “Component” (page 44), or press  on the remote control to select the component input.
- Set “Special Mode” to “480P” for inputting the 525P signal (page 45).
- A ø3.5 mm minijack to RCA audio cable (commercially available) is required for audio input.

Supplied accessory

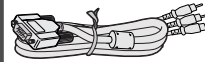

3 RCA to 15-pin D-sub cable (3.0 m)

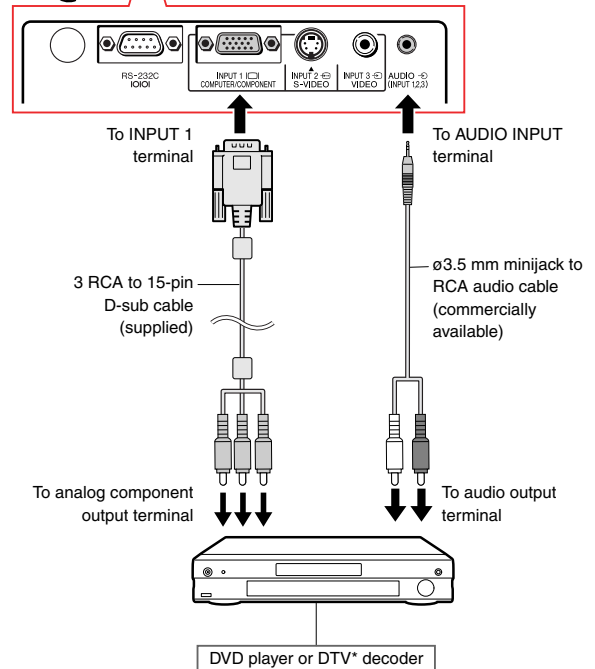
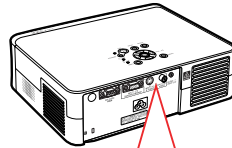

Extending the connecting cables

■ Use three RCA adapter plugs (supplied) for the following connection.

(Example)

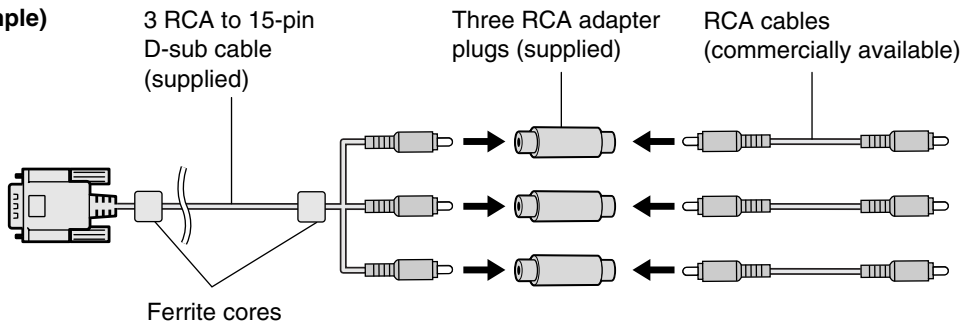

Info

- Do not remove ferrite cores attached to the 3 RCA to 15-pin D-sub cable.

Connecting the Projector to a Computer

- Before connecting, be sure to unplug the power cord of the projector from the wall outlet and turn off the devices to be connected. After making all connections, turn on the projector and then the other devices. When connecting a computer, be sure that it is the last device to be turned on after all the connections are made.
- Be sure to read the operation manuals of the devices to be connected before making connections.

Connecting to a Computer Using the RGB Cable

- 1 Connect the projector to the computer using the RGB cable (commercially available or sold separately).

- Secure the connectors by tightening the thumbscrews.

- 2 To input an audio signal, connect the projector to the computer using a $\varnothing 3.5$ mm stereo or mono audio cable (commercially available).

Note

- When connecting the projector to the computer, set “Signal Type” on the “Picture” menu to “RGB” (page 44), or press  on the remote control to select the RGB input.
- See page 59 “Computer Compatibility Chart” for a list of computer signals compatible with the projector. Use with computer signals other than those listed may cause some of the functions to not work.
- A Macintosh adapter may be required for using the computer cable to connect to some Macintosh computers. Contact your nearest Sharp Authorised Projector Dealer or Service Centre.
- Depending on the computer you are using, an image may not be projected unless the signal output setting of the computer is switched to the external output. Refer to the computer operation manual for switching the computer signal output settings.
- When using the $\varnothing 3.5$ mm mono audio cable, the volume level will be half of when using the $\varnothing 3.5$ mm stereo audio cable.

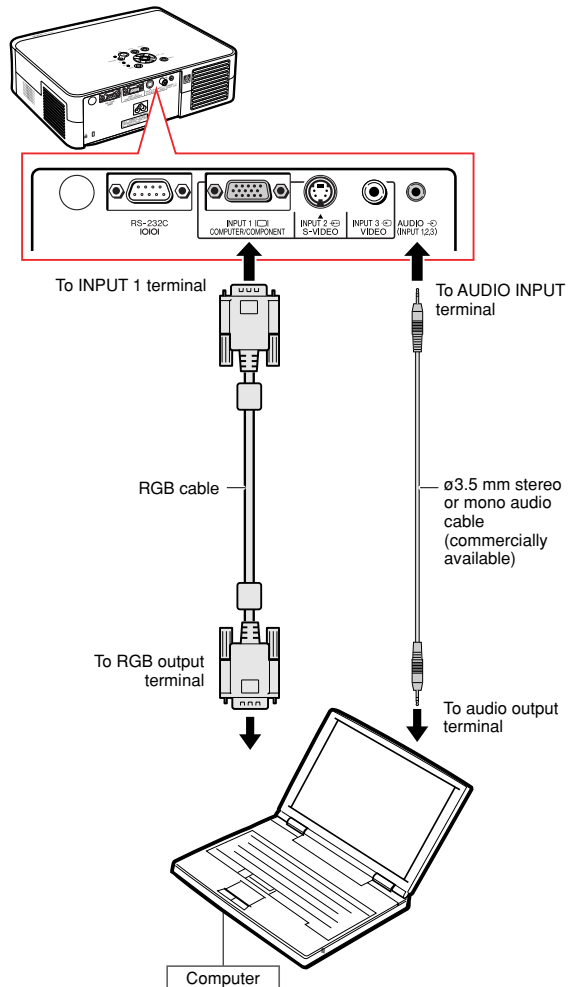

Controlling the Projector Using a Computer

Connecting to a Computer Using an RS-232C Cable

When the RS-232C terminal on the projector is connected to a computer with an RS-232C cable (null modem, cross type, commercially available), the computer can be used to control the projector. See page 58 for details.

- 1 Connect one end of the RS-232C cable (null modem, cross type) to the RS-232C terminal on the projector.
- 2 Connect the other end of the RS-232C cable to the RS-232C terminal on the computer.

Note

- The RS-232C function may not operate if your computer terminal is not correctly set up. Refer to the operation manual of the computer for details.
- See page 57 for connection of an RS-232C cable.
- A Macintosh adapter may be required for using the computer cable to connect to some Macintosh computers. Contact your nearest Sharp Authorised Projector Dealer or Service Centre.

Info

- Do not connect the RS-232C cable to a port other than the RS-232C terminal on the computer. This may damage your computer or projector.
- Do not connect or disconnect an RS-232C cable to or from the computer while it is on. This may damage your computer.

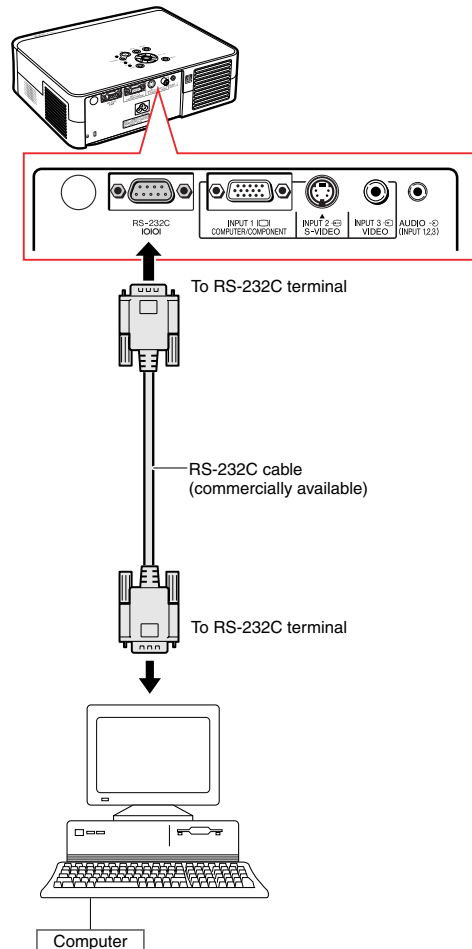

Image Projection

Turning the Projector on

Connect the required external equipment to the projector before carrying out the following procedures.

Info

- The language preset at the factory is English. If you want to change the on-screen display to another language, reset the language according to the procedure on page 51.

1 Plug the power cord into the wall outlet.

- The power indicator illuminates red, and the projector enters standby mode.

2 Press on the projector or on the remote control.

- The power indicator illuminates green.
- When the lamp turns on, the lamp indicator illuminates green. After the lamp indicator illuminates green, the projector is ready to start operation.

Note

- The lamp indicator illuminates, indicating the status of the lamp.
 - Green:** The lamp is ready.
 - Blinking in green:** The lamp is warming up.
 - Red:** The lamp should be replaced.
- If the projector is put into the standby mode and immediately turned on again, the lamp indicator may take some time to illuminate.

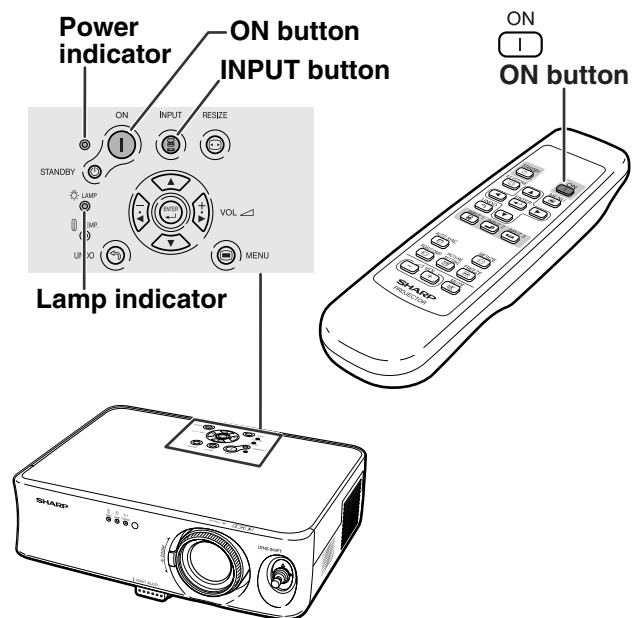

Info

- See page 30 for details about adjusting the focus and the size of the projected image.
- See "Using the Adjustment Feet" on page 31 for adjusting the projector angle and "Variable Lens Shift Feature" on page 32 for adjusting the projected image position.



Switching the INPUT Mode

Select the appropriate input mode for the connected equipment.

Press ,  or  on the remote control to select the INPUT mode.

- When pressing  on the projector, input mode switches in order of

→INPUT 1→INPUT 2→INPUT 3.

Note

- When no signal is received, "NO SIGNAL" will be displayed. When a signal that the projector is not preset to receive is received, "NOT REG." will be displayed.
- The INPUT mode is not displayed when "OSD Display" of the "Options" menu is set to  (OFF). (See page 47.)





About the INPUT mode

INPUT 1 (Component/RGB)	Used for projecting images from equipment that sends component signals or RGB signals connected to the INPUT 1 terminal.
INPUT 2 (S-Video)	Used for projecting images from equipment connected to the INPUT 2 terminal.
INPUT 3 (Video)	Used for projecting images from equipment connected to the INPUT 3 terminal.

Adjusting the Volume

Press  or  on the remote control to adjust the volume.

Note

- Pressing  will lower the volume. Pressing  will raise the volume.
- On the projector, the volume can be adjusted by pressing  or .

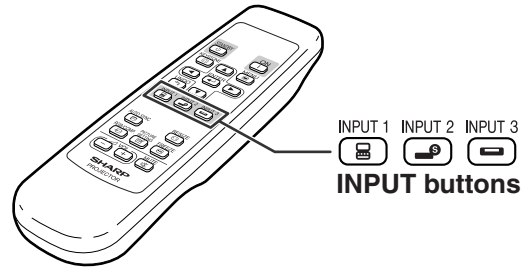

▼On-screen Display of INPUT Mode (Example)

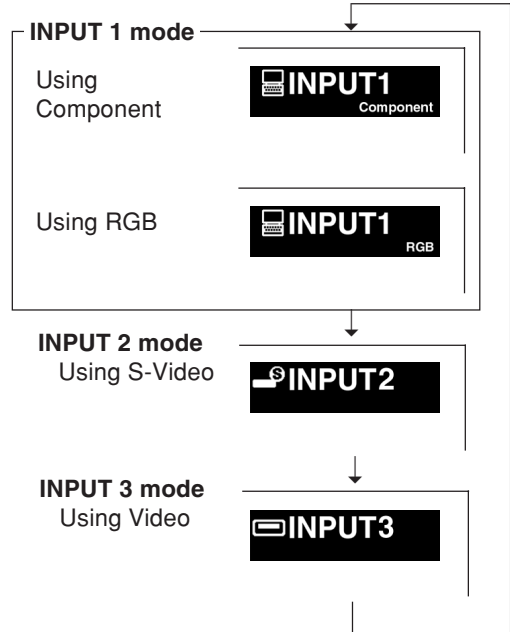

Volume buttons

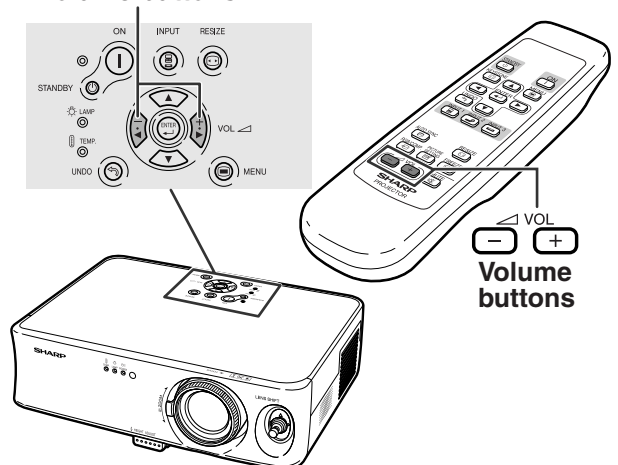

▼On-screen Display



Turning off the Sound Temporarily

Press  on the remote control to temporarily turn off the sound.

Note

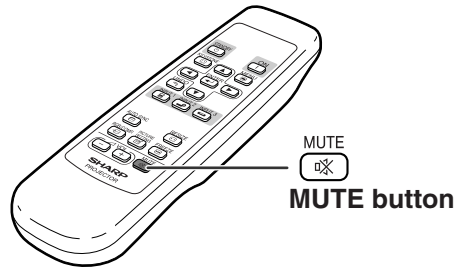

- Pressing  again will turn the sound back on.





▼ On-screen Display



Turning the Power off (Putting the Projector into the Standby Mode)

- 1 Press  on the projector or  on the remote control, then press that button again while the confirmation message is displayed, to put the projector into the standby mode.

Note

- If you accidentally pressed  or  and do not want to put the projector into the standby mode, wait until the confirmation message disappears.

- 2 Unplug the power cord from the wall outlet after the cooling fan stops.

Info

- Do not unplug the power cord during projection or cooling fan operation. The cooling fan in this projector continues to run for about 90 seconds after the projector enters the standby mode. This can cause damage due to rise in internal temperature, as the cooling fan also stops.

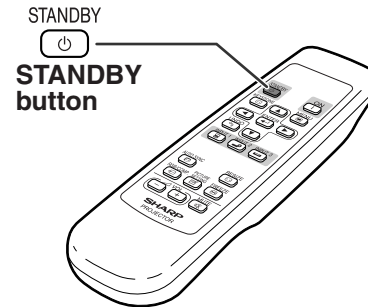

▼ On-screen Display

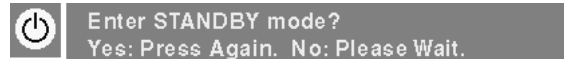

Correcting Trapezoidal Distortion

When the image is projected either from the top or from the bottom towards the screen at an angle, the image becomes distorted trapezoidally. The function for correcting trapezoidal distortion is called Keystone Correction.

Note

- The Keystone Correction can be adjusted up to an angle of approximately ± 30 degrees and the screen can also be set up to an angle of approximately ± 30 degrees (when the resize mode is set to "STRETCH" for the video signal input or "SIDE BAR" for the computer signal input).
- The Keystone Correction cannot be adjusted in the lateral direction.
- For details about the setup, see pages 7 and 16.

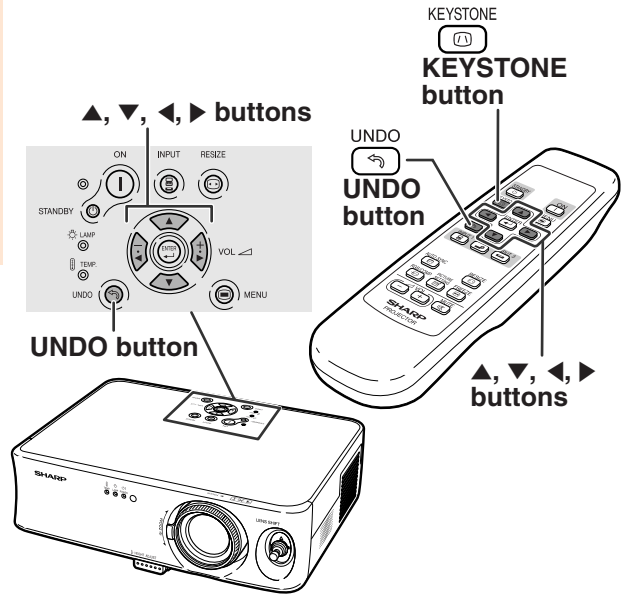

1 Press ^{KEYSTONE} to enter the Keystone Correction mode.

- The on-screen display of the Keystone Correction mode will appear.

2 Press , , and to adjust the Keystone Correction.

- You can also adjust the Keystone Correction using the , , and buttons on the projector.

Note

- Press ^{UNDO} to return to the default setting.
- Straight lines or the edges of images may appear jagged while adjusting the image.
- When correcting trapezoidal distortion, the aspect ratio of the image will change slightly.

3 Press ^{KEYSTONE} .

- The on-screen display of the Keystone Correction mode will disappear.

▼ On-screen display (Keystone Correction mode)



Compresses upper side.

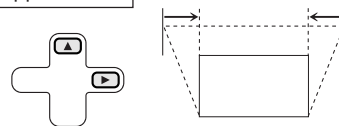

Compresses lower side.

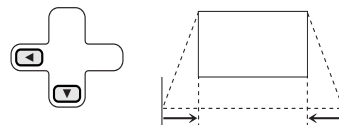

Adjusting the Lens

The image is focused and adjusted to the desired size using the focus ring or zoom knob on the projector.

- 1 Adjust the focus by rotating the focus ring.

- 2 Adjust zooming by moving the zoom knob.

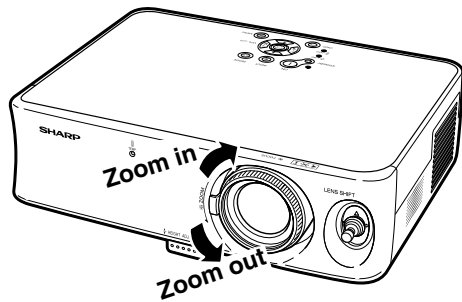
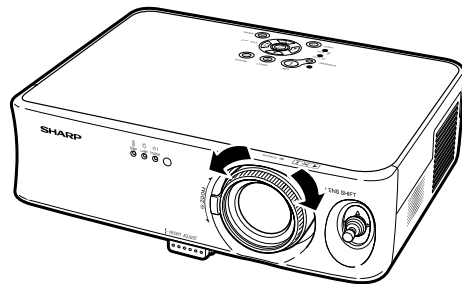
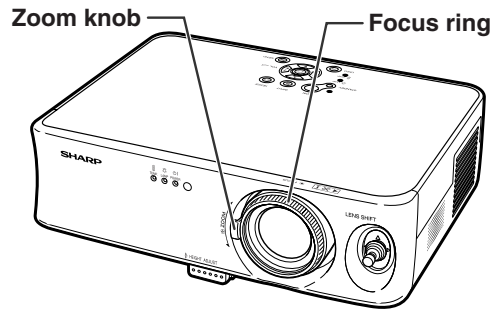

Using the Adjustment Feet

The height of the projector can be adjusted using the adjustment feet at the front and rear of the projector when the screen is not perpendicular to the lens centre of the projector, or when installation surface is slightly slanted. When the screen is in a higher position than the projector, the projection image can be made higher by adjusting the projector.

1 Press the HEIGHT ADJUST button.

- The front adjustment foot comes out.

2 Lift the projector to adjust its height while pressing the HEIGHT ADJUST button.

- The projector is adjustable up to approximately 12 degrees (5 steps).
- When lowering the projector, it may be difficult to move the front adjustment foot because the installation surface is difficult to slide. In this case, pull the projector back slightly and adjust its height.

3 Remove your hands from the HEIGHT ADJUST button of the projector after its height has been finely adjusted.

4 Use the rear adjustment foot to make the projector level.

- The projector is adjustable ± 1 degree from the standard position.

Note

- When the height of the image is being adjusted by the adjustment feet, the image becomes distorted trapezoidally. In this case, see "Correcting Trapezoidal Distortion" on page 29 to correct the trapezoidal distortion.

Info

- Do not press the HEIGHT ADJUST button when the front adjustment foot comes out without firmly holding the projector.
- Do not hold the lens when lifting or lowering the projector.
- When lowering the projector, be careful not to get your fingers caught in the area between the adjustment foot and the projector.

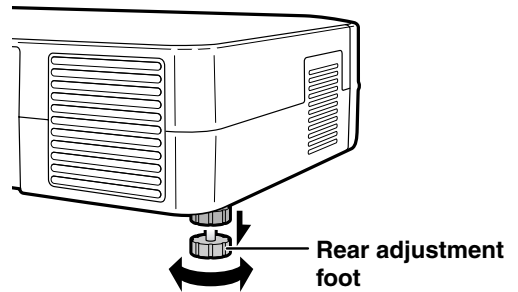
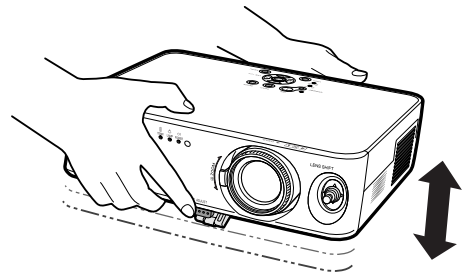
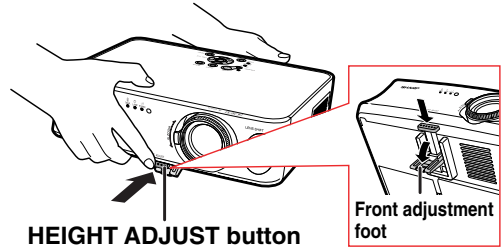
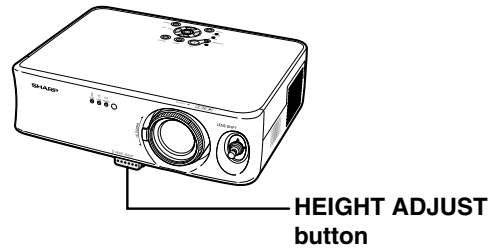

Variable Lens Shift Feature

In addition to the zoom function and adjustment of projection angle using the adjustment foot, it is possible to move the lens up and down and left and right (360°) to adjust the projection position simply by moving the lens shift lever on the front of the projector. This is a useful function in cases such as when the screen cannot be moved.

When moving upwards or downwards

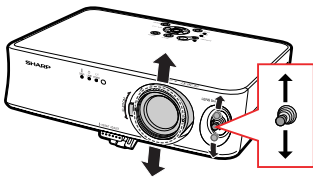
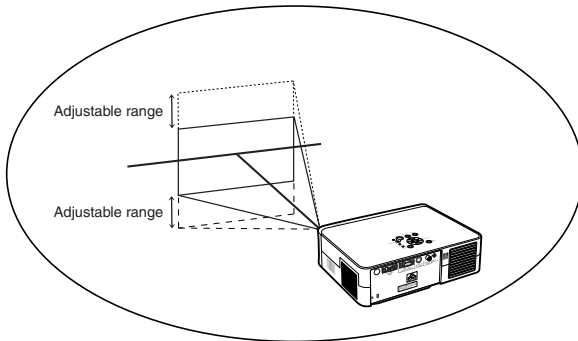

Lens shift lever

When moving in the left and right direction

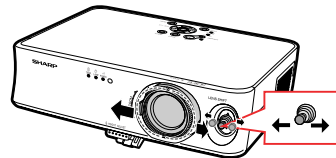
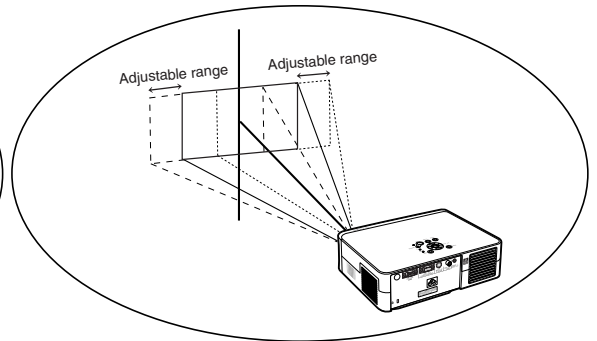

Lens shift lever

Adjustable range of the lens shift lever

The adjustable range using the lens shift lever has limitations. The image can be adjusted as shown below.

Image centre locus

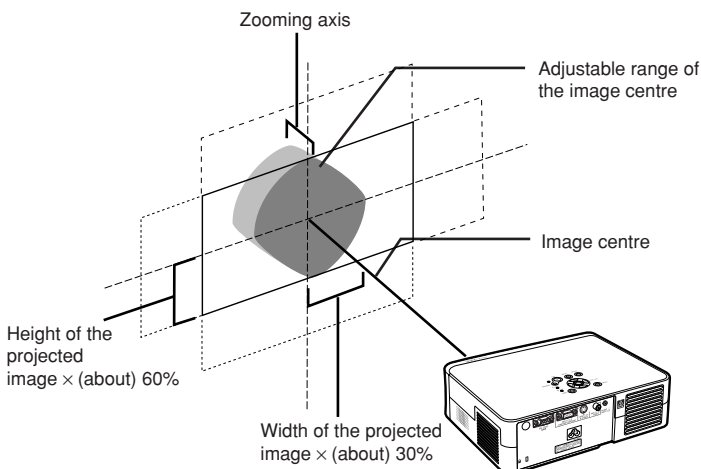

Adjusting the Projected Image Position

Adjust the projected image position using the lens shift lever.

Info

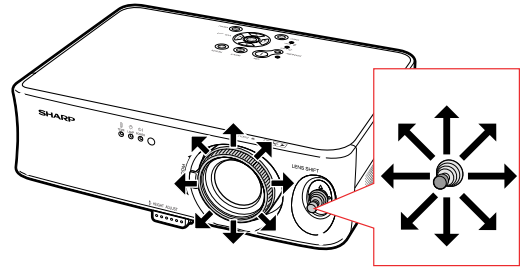

- When using the projector (during projection), be sure not to subject the projector to any impact. If the projector is subjected to impact, the projection image may deviate from the adjusted position.
- When transporting or carrying the projector, attach the lens shipping block and the lens cap to the projector.
- When the angle is being adjusted using the adjustment foot, deviation of the projected image arising when carrying out lens shift in the lateral direction cannot be corrected by the Keystone Correction.



Freeze Image

You can instantly freeze a moving image with the remote control.

Freezing a Moving Image

- 1** Press .
• The projected image is frozen.
- 2** Press  again to return to the moving image from the currently connected device.

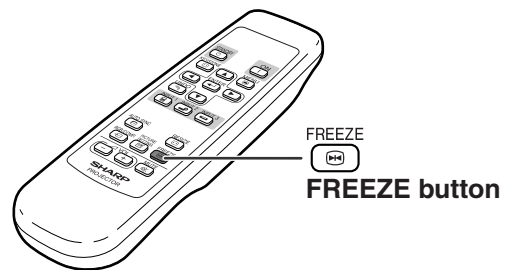



Selecting the Picture Display Mode

This function allows you to modify or customise the picture display mode to enhance the input image. Depending on the input signal, you can choose “STRETCH”, “SIDE BAR” or “CINEMA ZOOM” image.

Switching the Picture Display Using Different Input Signals

Press .

- Pressing  changes the picture display mode as shown on page 35.
- To return to the standard image (“STRETCH”), press  while “RESIZE” is displayed on the screen.
- You can also change the picture display mode by pressing  on the projector.

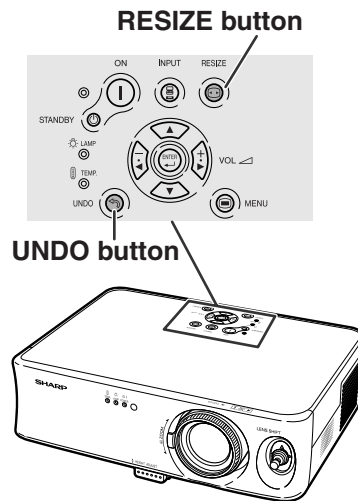

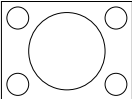
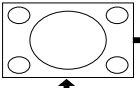
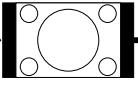
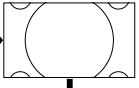
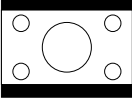
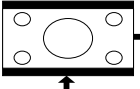
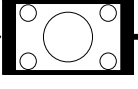
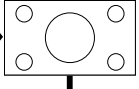
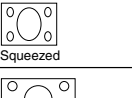
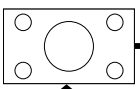
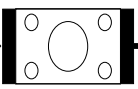
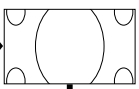
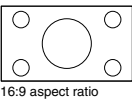
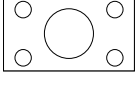
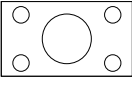
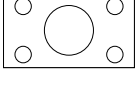
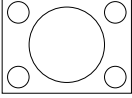
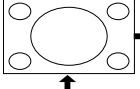
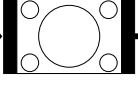
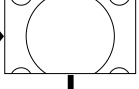
	Input Signal	Output screen image		
		STRETCH (Default setting)	SIDE BAR	CINEMA ZOOM
480I 480P NTSC PAL SECAM	 4:3 aspect ratio			
	 Letter box			
	 Squeezed			
1080I	 16:9 aspect ratio			
720P				
VGA SVGA XGA	 4:3 aspect ratio			

 : Cutout area on which images cannot be projected.

 **Note**

- "STRETCH" is fixed when 720P or 1080I signals are entered.

Using the Menu Screen

The menu screens allow you to adjust the image and various projector settings. (The menu items differ depending on the input mode.)

The menu can be operated with the projector or with the remote control.

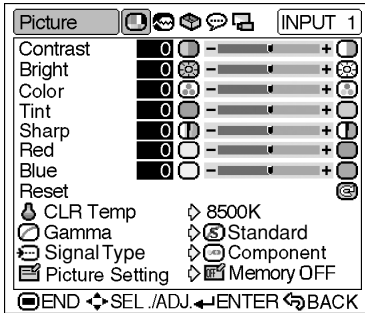

Menu Selections (Adjustments)

1 Press .

Note

- The "Picture" menu screen for the selected input mode is displayed.

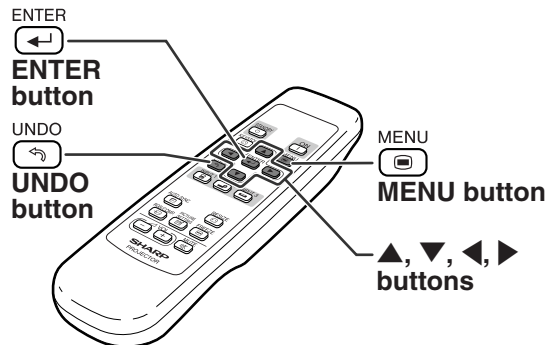
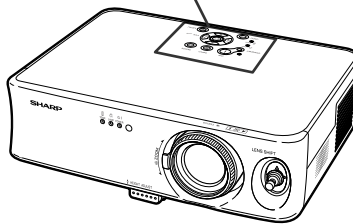
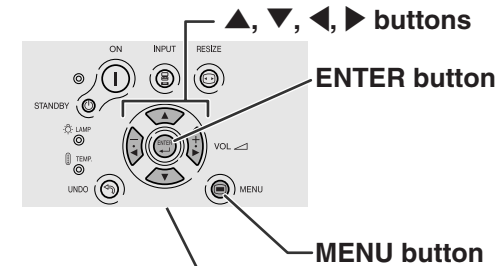

2 Press ◀ or ▶ to select the menu screen (icon) you want to set.

- The menu icon for the selected menu screen is highlighted.

Menu icon	Menu screen
	Picture
	Fine Sync
	Options
	Language
	PRJ Mode

Note

- The “Fine Sync” menu is not available for INPUT 2 or 3.
- For items on the menus, see the tree charts on pages 40 and 41.

Select the icon.

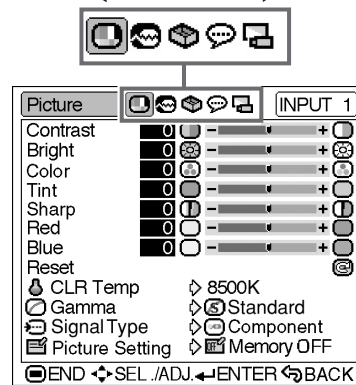

3 Press ▲ or ▼ to select the item you want to adjust.

- The selected item is highlighted.

Note

- If you want to adjust the item while viewing the projected image, press **ENTER** after selecting the item. Only the selected adjustment item will be displayed. When pressing ▲ or ▼, the following item (“Bright” after “Contrast”) will be displayed.
- Press **UNDO** to return to the previous screen.

Select the item.

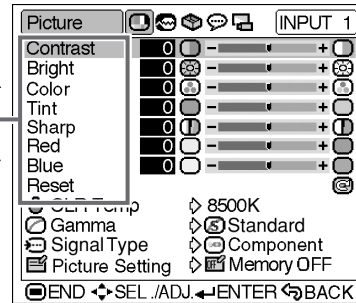

4 Press ◀ or ▶ to adjust the item selected.

- The adjustment is stored.

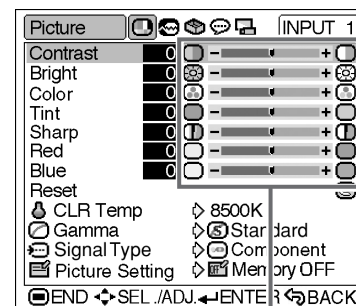

5 Press .



- The menu screen will disappear.

Menu Selections (Settings)





1 Press .

 **Note**

- The “Picture” menu screen for the selected input mode is displayed.

2 Press  or  to select the menu screen (icon) you want to set.

- The menu icon for the selected menu screen is highlighted.

Menu icon	Menu screen
	Picture
	Fine Sync
	Options
	Language
	PRJ Mode

 **Note**

- The “Fine Sync” menu is not available for INPUT 2 or 3.
- For items on the menus, see the tree charts on pages 40 and 41.

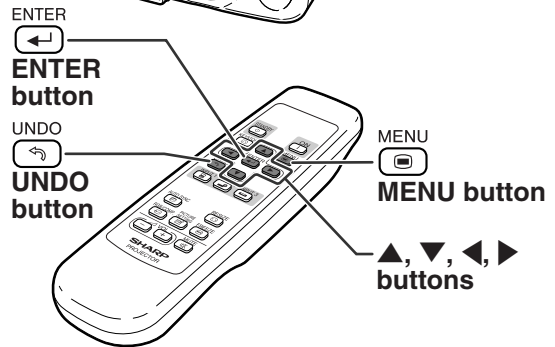
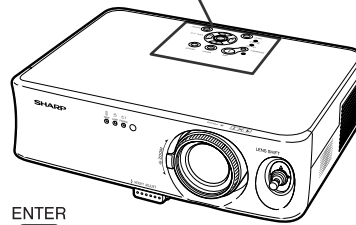
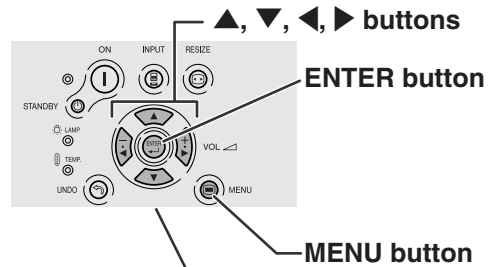

Select the icon.

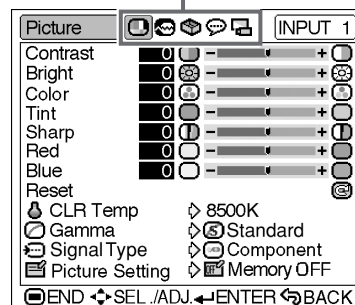

3 Press ▲ or ▼ to select the item you want to set.



- Note**
- Press or ◀ to return to the previous screen.

Select the item.

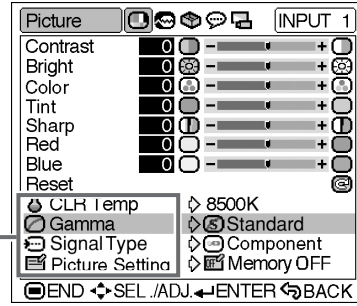

4 Press ▶.

- The cursor shifts to the sub menu.
- For some items, the sub menu cannot be displayed. In such cases, select the icon using ◀ or ▶ to make a setting, then go to step 7.

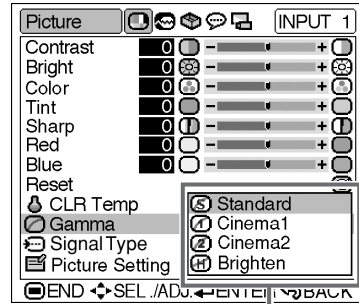

Sub menu

5 Press ▲ or ▼ to select the setting of the item displayed in the sub menu.

6 Press .

- The item selected is set.

7 Press .

- The menu screen will disappear.

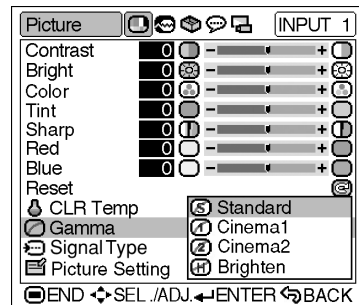

Menu Items

The following shows the items that can be set in the projector.

“Picture” menu

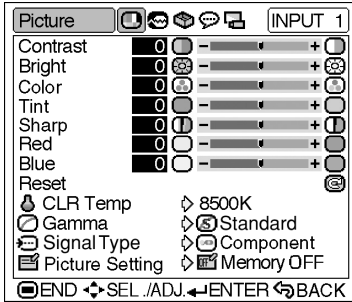

Note

When using the INPUT 1 mode:

- In the “Picture” menu of INPUT 1, “Color”, “Tint” and “Sharp” are only displayed when “Signal Type” is set to “Component”.
- “Signal Type” is displayed in the “Picture” menu only in the INPUT 1 mode.

When using the INPUT 2 or INPUT 3 mode:

- The “Signal Type” item does not appear in the “Picture” menu.
- “Sharp” is adjustable between -3 and +3.

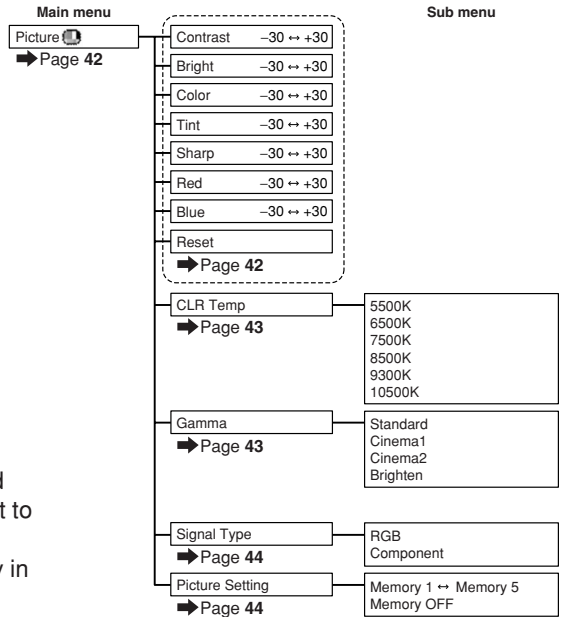

“Fine Sync” menu

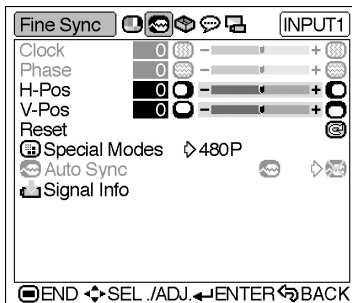

Note

When using the INPUT 1 mode:

- The “Fine Sync” menu is only displayed when the projector input is INPUT 1.
- The values for “Resolution”, “Hor Freq” and “Vert Freq” in the tree chart are examples only.
- “Clock”, “Phase” and “Auto Sync” cannot be adjusted when “Signal Type” is set to “Component”.

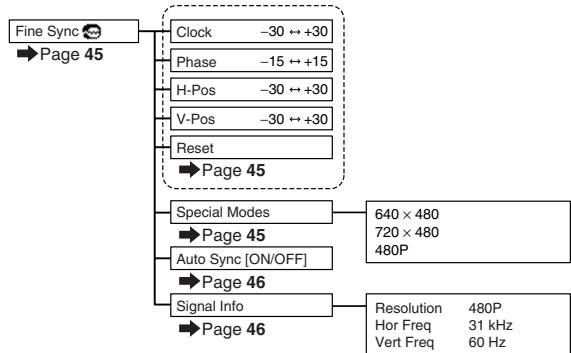

“Options” menu

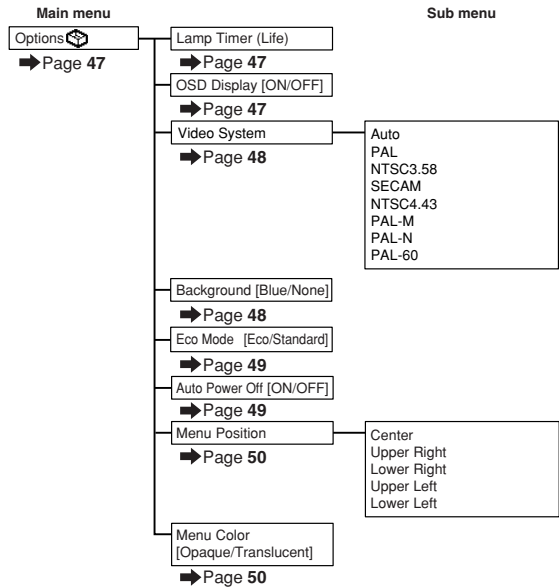
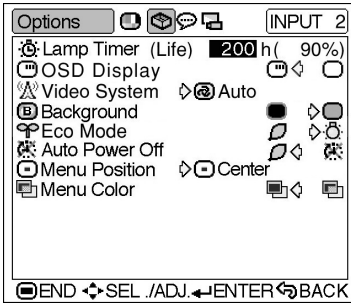

Note

When using the INPUT 1 mode:

- The “Video System” item does not appear in the “Options” menu.

When using the INPUT 2 or INPUT 3 mode:

- “Tint” cannot be adjusted in the “Picture” menu when “Video System” is set to “PAL”, “SECAM”, “PAL-M”, “PAL-N” or “PAL-60”.

“Language” menu

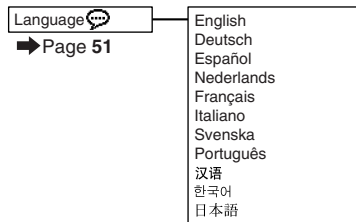

“PRJ Mode” menu

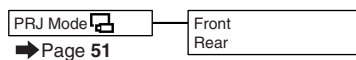
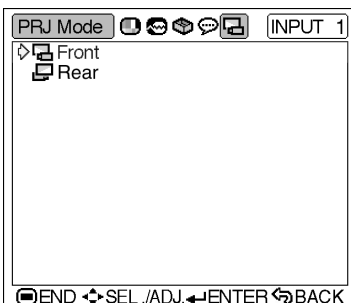

Picture Adjustment

Adjusting the Image

Note

- Select the memory location (Memory 1 to 5, or Memory OFF) first when you want to store the adjustment settings on the “Picture” menu. (See page 44.)

Select the item on the “Picture” menu and adjust the image.

Adjusting the menu screen ➡ Page 36

Example: “Picture” screen menu for INPUT 1 (Component) mode

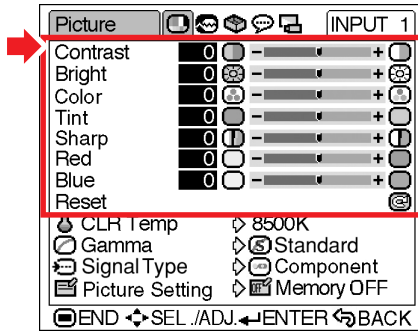

Info

- “Color”, “Tint” and “Sharp” are not displayed when selecting INPUT 1 and setting the “Signal Type” to “RGB”.
- “Tint” cannot be adjusted and “Sharp” is adjustable between -3 and +3 in the “Picture” menu when “Video System” is set to “PAL”, “SECAM”, “PAL-M”, “PAL-N” or “PAL-60” for the INPUT 2 or INPUT 3 mode.
- “Sharp” can be adjusted when 480I, 480P, 540P, 580I, 580P, 720P, 1035I or 1080I signals are detected while “Signal Type” for INPUT 1 is set to “Component”.
- To reset all adjustment items, select “Reset” and press ^{ENTER} (↵).

Description of Adjustment Items

Selectable items	Press ◀	Press ▶
Contrast	for less contrast.	for more contrast.
Bright	for less brightness.	for more brightness.
Color	for less colour intensity.	for more colour intensity.
Tint	for making skin tones purplish.	for making skin tones greenish.
Sharp	for less sharpness.	for more sharpness.
Red	for weaker red.	for stronger red.
Blue	for weaker blue.	for stronger blue.

CLR Temp (Adjusting the Colour Temperature)

Select “CLR Temp” on the “Picture” menu and the desired colour temperature setting.

Setting the menu screen ➡ Page 38

Example: “Picture” screen menu for INPUT 1 (Component) mode

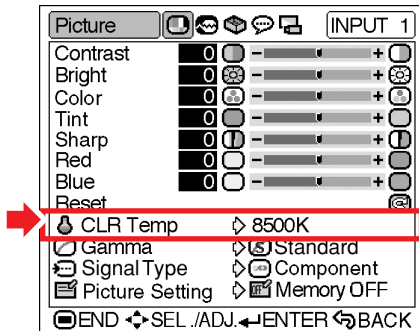

Description of Colour Temperature Settings

Selectable settings	Description
5500K	For lower colour temperature for warmer, reddish incandescent-like images.
6500K	
7500K	
8500K	
9300K	For higher colour temperature for cooler, bluish, fluorescent-like images.
10500K	

Note

- Values for “CLR Temp” are only approximations.

Gamma (Gamma Correction)

Gamma is an image quality enhancement function that offers a richer image by brightening the darker portions of the image without altering the brightness of the brighter portions.

When you are displaying images with frequent dark scenes, such as a film or concert, or when you are displaying images in a bright room, this feature makes the dark scenes easier to see and gives the impression of greater depth in the image.



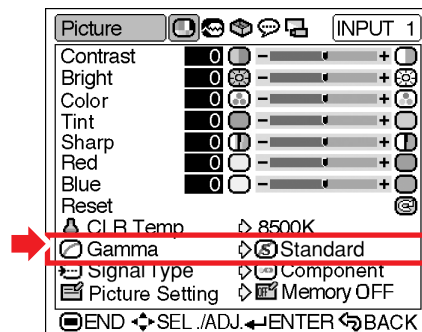

Select “Gamma” on the “Picture” menu and the desired gamma mode.

Setting the menu screen ➡ Page 38

Example: “Picture” screen menu for INPUT 1 (Component) mode



Description of Gamma Modes

Selectable settings	Description
 Standard	—
 Cinema1	Gives greater depth to darker portions of images.
 Cinema2	Brightness is toned down and the image becomes more balanced.
 Brighten	Brightens the darker portions of images for easier viewing in a dimly lit room.

Standard



Cinema1



Cinema2



Brighten



Picture Adjustment

Signal Type (Signal Type Setting)

In accordance with the input signal from the device connected to the INPUT 1 terminal on the projector, “Component” or “RGB” can be selected for the signal type setting.

Select “Signal Type” on the “Picture” menu and set it to “RGB” or “Component”.

Setting the menu screen ➡ Page 38

Example: “Picture” screen menu for INPUT 1 (Component) mode

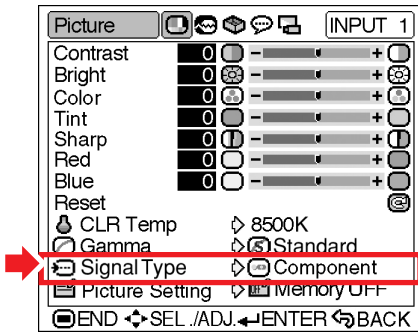

Description of Signal Type Settings

Selectable settings	Description
RGB	Set when RGB signals are received.
Component	Set when Component signals are received.

Note

- You can change the signal type setting on the “Signal Type” display by pressing on the remote control when the INPUT 1 mode is selected.

Picture Setting (Storing and Selecting the Adjustment Settings)

Use this function to store the adjustment settings on the “Picture” menu. No matter which input mode or signal type is selected, you can select and apply the settings you have stored in a memory location.

Select “Picture Setting” on the “Picture” menu and the memory location where you want to store the settings. Then adjust the setting items on the “Picture” menu.

Setting the menu screen ➡ Page 38

Example: “Picture” screen menu for INPUT 1 (Component) mode

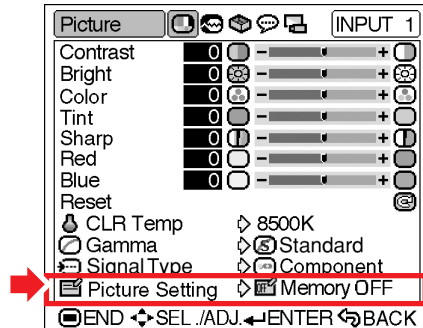

Description of Picture Setting

Selectable settings	Description
Memory 1	Settings of all items (except for “Signal Type”) on the “Picture” menu can be stored in memory location. The stored settings can be selected in any input mode.
Memory 2	
Memory 3	
Memory 4	
Memory 5	
Memory OFF	Settings on the “Picture” menu for each input mode can be stored. The settings stored in “Memory OFF” cannot be applied when another input mode is selected.

If you want to apply the stored settings on the “Picture” menu, select “Picture Setting” on the “Picture” menu and the memory location where you have stored the settings. If you want to change the stored settings, select the memory location for those settings and make settings on the “Picture” menu.

Note

- A memory location can be selected by pressing on the remote control. Pressing changes the memory location in order of “Memory 1” to “Memory 5” and “Memory OFF”.

Computer Image Adjustment

Using the “Fine Sync” menu, you can adjust the computer image, match the computer display mode, and check the input signal.

Adjusting the Computer Image

When “Auto Sync” is set to OFF or when vertical stripes or flickering occur in portions of the screen even if “Auto Sync” is set to “” (ON), adjust “Clock”, “Phase”, “H-Pos” or “V-Pos” to obtain the best computer image.

Select the item on the “Fine Sync” menu and adjust the computer image.

Adjusting the menu screen ➡ Page 36

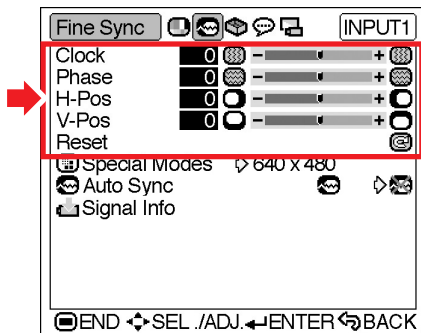

Example: “Fine Sync” menu screen for INPUT 1 (RGB) mode



Description of Adjustment Items

Selectable items	Use ◀ and ▶ to
Clock	adjust vertical noise.
Phase	adjust horizontal noise (similar to tracking on your VCR).
H-Pos	centre the on-screen image by moving it to the left or right.
V-Pos	centre the on-screen image by moving it up or down.

Note

- You can automatically adjust the computer image by setting “Auto Sync” to “” (ON) on the “Fine Sync” menu or pressing  on the remote control. See the next page for details.
- To reset all adjustment items, select “Reset” and press .
- “Clock” and “Phase” cannot be adjusted when “Signal Type” is set to “Component”.

Special Modes (Special Mode Settings)

Ordinarily, the type of input signal is detected and the correct resolution mode is automatically selected. However, for some signals, the optimal resolution mode in “Special Modes” on the “Fine Sync” menu may need to be selected to match the computer display mode.

Select “Special Modes” on the “Fine Sync” menu and the appropriate resolution.

Setting the menu screen ➡ Page 38

Example: “Fine Sync” menu screen for INPUT 1 (RGB) mode

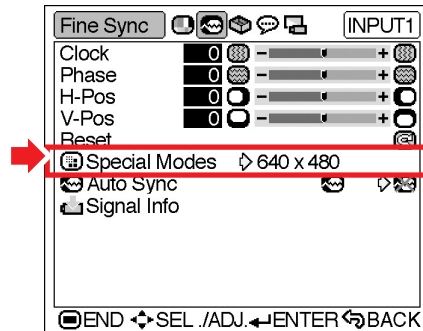

Note

- If your computer displays patterns which repeat every other line (horizontal stripes), flickering may occur which makes the image hard to see.
- When a DVD player or Digital Video is connected, select 480P as the input signal.
- When video equipment outputting 750P signal is connected, select 720P as the input signal. When inputting 1280 × 720 signal from the computer, select “HTPC”.
- See “Signal Info (Checking the Input Signal)” on page 46 for information on the currently selected input signal.

Computer Image Adjustment

Auto Sync (Auto Sync Adjustment)

Used to automatically adjust a computer image.

Select “Auto Sync” on the “Fine Sync” menu and set it to “” (ON) or “” (OFF).

Setting the menu screen ➡ Page 38

Example: “Fine Sync” menu screen for INPUT 1 (RGB) mode

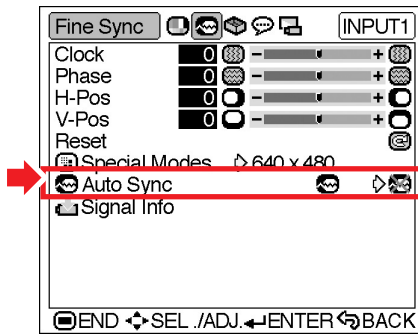

Signal Info (Checking the Input Signal)



Select “Signal Info” on the “Fine Sync” menu to check the current input signal information.

Checking the menu screen ➡ Page 38

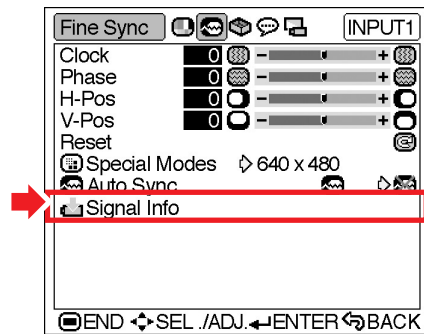
Example: “Fine Sync” menu screen for INPUT 1 (RGB) mode



Description of Auto Sync Adjustment

Selectable Settings	Description
 ON	Auto Sync adjustment will occur when the projector is turned on or when the input signals are switched, when connected to a computer.
 OFF	Auto Sync adjustment is not automatically performed.

Note

- Auto Sync adjustment is also performed by pressing  on the remote control.
- The Auto Sync adjustment may take some time to complete, depending on the image of the computer connected to the projector.
- When the optimum image cannot be achieved with Auto Sync adjustment, use manual adjustments. (See page 45.)
- Auto Sync adjustment is performed when “Signal Type” is set to “RGB”.

Note

- The projector will display the number of scanned lines available from audio-visual equipment such as a DVD player or Digital Video.

Using the “Options” Menu

Lamp Timer (Life) (Checking the Lamp Life Status)

You can confirm the cumulative lamp usage time and the remaining lamp life (percentage).



Display the “Options” menu to check the lamp life status.

Checking the menu screen ➡ Page 38

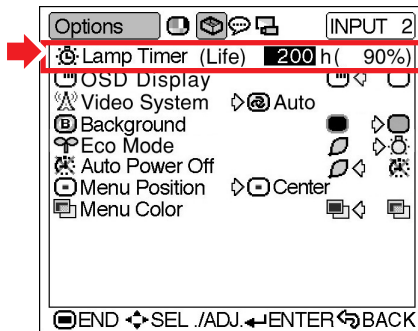

Example: “Options” menu screen for INPUT 2 (S-Video) mode



Description of Lamp Life

Lamp usage condition	Remaining lamp life	
	100%	5%
Operated exclusively in Eco mode ()	Approx. 4,000 hours	Approx. 200 hours
Operated exclusively in Standard mode ()	Approx. 2,000 hours	Approx. 100 hours

Note

- It is recommended that the lamp be changed when the remaining lamp life becomes 5%. For lamp replacement, contact your nearest Sharp Authorised Projector Dealer or Service Centre.
- The table above indicates rough estimates in the case of using only in each mode shown. Remaining lamp life changes within the range of the values shown depending on the frequency at which “Eco Mode” is switched to “” (Eco mode) and “” (Standard mode) (page 49).

OSD Display (Setting On-screen Display)

This function allows you to turn the on-screen messages on or off.



Select “” (ON) or “” (OFF) in “OSD Display” on the “Options” menu.

Setting the menu screen ➡ Page 38

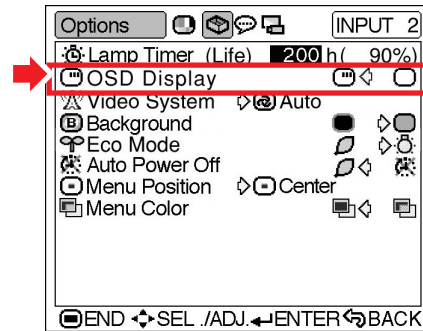
Example: “Options” menu screen for INPUT 2 (S-Video) mode



Description of “OSD Display” Settings

Selectable settings	Description
 ON	All On-screen Displays are displayed.
 OFF	INPUT/VOLUME/MUTE/FREEZE/AUTO SYNC/ “An invalid button has been pressed.” are not displayed.

Using the “Options” Menu

Video System (Setting the Video System)

The video input system mode is preset to “Auto”; however, a clear picture from the connected audio-visual equipment may not be received, depending on the video signal difference. In that case, switch the video signal.



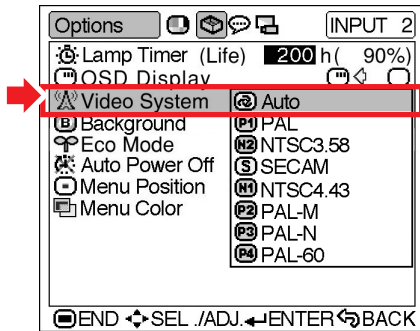

Select “Video System” on the “Options” menu and the appropriate video system.

Setting the menu screen ➡ Page 38

Example: “Options” menu screen for INPUT 2 (S-Video) mode



Description of Video Systems

Selectable settings	Description
 PAL	When connected to PAL video equipment.
 SECAM	When connected to SECAM video equipment.
 NTSC4.43	When reproducing NTSC signals in PAL video equipment.
 NTSC3.58	When connected to NTSC video equipment.

Note

- The video signal can only be set in INPUT 2 or INPUT 3 mode.
- When the system mode is set to “Auto”, you may not receive a clear picture due to signal differences. Should this occur, switch to the video system of the source signal.

Background (Selecting a Startup and Background Image)



Select “Background” on the “Options” menu and the image displayed upon the projector’s startup and when no signal is being sent to the projector.

Setting the menu screen ➡ Page 38

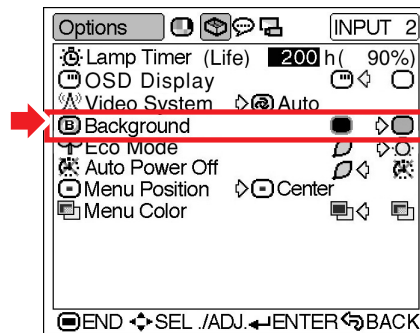
Example: “Options” menu screen for INPUT 2 (S-Video) mode





Description of Background Images

Selectable settings	Description
 Blue	Blue screen
 None	Black screen

Note

- If the input signal has interference, the screen will be displayed during interference.

Eco Mode (Setting the Eco Mode)



Select “” (Eco Mode) or “” (Standard Mode) in “Eco Mode” on the “Options” menu.

Setting the menu screen ➡ Page 38

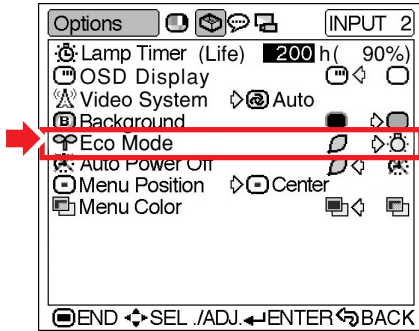

Example: “Options” menu screen for INPUT 2 (S-Video) mode





Description of Eco Mode



Selectable settings	Brightness	Power consumption (When using AC 100V)	Lamp life
 (Eco mode)	90%	170 W	Approx. 4,000 hours
 (Standard mode)	100%	185 W	Approx. 2,000 hours

Note

- Although lamp life and power consumption are improved when “Eco Mode” is set to “” (Eco mode), brightness decreases by 10%.
- “Eco Mode” is factory preset to “” (Standard mode).

Auto Power Off (Auto Power Off Function)

When no input signal is detected for more than 15 minutes, the projector will automatically enter the standby mode if set to “” (ON). The Auto Power Off function will be disabled if it has been set to “” (OFF).



Select “” (ON) or “” (OFF) in “Auto Power Off” on the “Options” menu.

Setting the menu screen ➡ Page 38

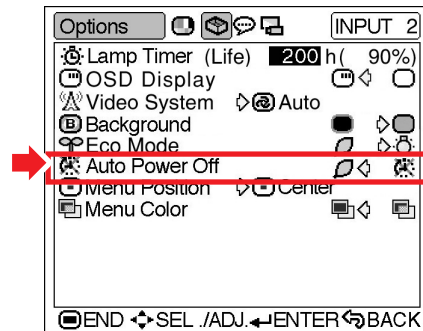
Example: “Options” menu screen for INPUT 2 (S-Video) mode



Description of Auto Power Off Function

Selectable setting	Description
 ON	Auto Power Off function is working.
 OFF	Auto Power Off function is disabled.

Note

- When the Auto Power Off function is set to “” (ON), 5 minutes before the projector enters the standby mode, the message “Enter STANDBY mode in X min.” will appear on the screen to indicate the remaining minutes.

Using the “Options” Menu

☐ Menu Position (Selecting the Menu Screen Position)

Select “Menu Position” on the “Options” menu and the desired position for the menu screen.

Setting the menu screen ➡ Page 38

Example: “Options” menu screen for INPUT 2 (S-Video) mode

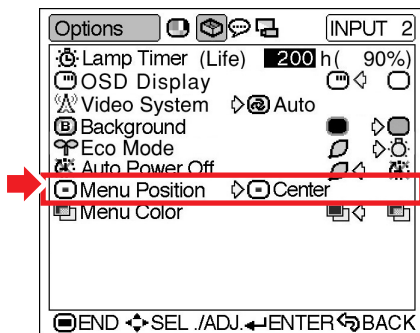

Description of Menu Positions

Selectable settings	Description
☐ Center	Displayed on the centre of the image.
☐ Upper Right	Displayed on the upper right of the image.
☐ Lower Right	Displayed on the lower right of the image.
☐ Upper Left	Displayed on the upper left of the image.
☐ Lower Left	Displayed on the lower left of the image.

☐ Menu Color (Selecting the Menu Colour)

Select “☐” (Opaque) or “☐” (Translucent) in “Menu Color” on the “Options” menu.

Setting the menu screen ➡ Page 38

Example: “Options” menu screen for INPUT 2 (S-Video) mode

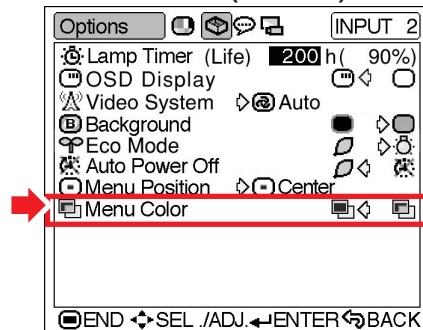

Description of Menu Colours

Selectable settings	Description
☐ Opaque	The menu is displayed opaquely.
☐ Translucent	The menu is displayed translucently.

Selecting the On-screen Display Language and the Projection Mode

Selecting the On-screen Display Language

The on-screen display language of the projector can be set to English, German, Spanish, Dutch, French, Italian, Swedish, Portuguese, Chinese, Korean or Japanese.

Display the “Language” menu and select the desired language as the on-screen display.

Setting the menu screen ➡ Page 38

Example: “Language” menu screen for INPUT 1 (Component) mode



Reversing the Projected Image

You can reverse the projected image for various applications using the “PRJ Mode” menu.

Display the “PRJ Mode” menu and select the desired projection mode.

Setting the menu screen ➡ Page 38

Example: “PRJ Mode” menu screen for INPUT 1 (Component) mode

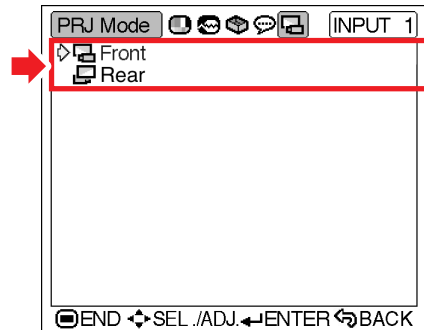

Description of Projection Modes

Selectable settings	Description
Front	Normal image
Rear	Reversed image

Note

- Set “PRJ Mode” to “Rear” when projecting the image from behind the translucent screen or using a mirror. See page 18 for this setup.

Maintenance Indicators

- The warning lights on the projector indicate problems inside the projector.
- If a problem occurs, either the temperature warning indicator or the lamp indicator will illuminate red, and the projector will enter the standby mode. After the projector has entered the standby mode, follow the procedures given below.

Temperature warning indicator

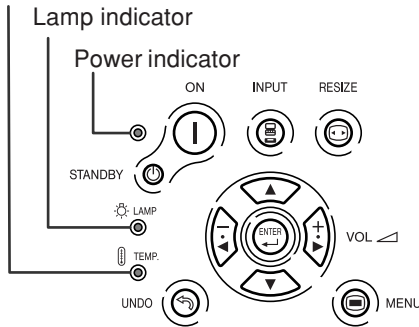

About the temperature warning indicator



If the temperature inside the projector increases, due to blockage of the air vents, or the setting location, “TEMP.” will



illuminate in the lower left corner of the picture. If the temperature keeps on rising, the lamp will turn off and the temperature warning indicator will blink, the cooling fan will run for a further 90 seconds, and then the projector will enter the standby mode. After “TEMP.” appears, be sure to perform the following measures.



About the lamp indicator



- The lamp life becomes 0%, when used for approximately 4,000 hours with “Eco Mode” or when used for approximately 2,000 hours with “Standard Mode” (see pages 47 and 49).
- When the remaining lamp life becomes 5% or less, “” (yellow) will be displayed on the screen. When the percentage becomes 0%, “” (red), the lamp will automatically turn off and then the projector will automatically enter the standby mode. At this time, the lamp indicator will illuminate in red.
- If you try to turn on the projector a fourth time without replacing the lamp, the projector will not turn on.

Maintenance indicator	Normal	Abnormal	Condition	Problem	Possible Solution
Temperature warning indicator	Off	Red on/ Standby	The internal temperature is abnormally high.	<ul style="list-style-type: none"> Blocked air intake Cooling fan breakdown Internal circuit failure Clogged air intake 	<ul style="list-style-type: none"> Relocate the projector to an area with proper ventilation. (See page 7.) Clean the air filter of the projector. (See page 61.) Take the projector to your nearest Sharp Authorised Projector Dealer or Service Centre for repair.
Lamp indicator	Green on (Green blinks when the lamp is warming up.)	Red on Red on/ Standby	Time to change the lamp. The lamp does not illuminate.	<ul style="list-style-type: none"> Remaining lamp life becomes 5% or less. Burnt-out lamp Lamp circuit failure 	<ul style="list-style-type: none"> Carefully replace the lamp. (See page 55.) Take the projector to your nearest Sharp Authorised Projector Dealer or Service Centre for repair. Please exercise care when replacing the lamp.
Power indicator	Green on/ Red on	Red blinks	The power indicator blinks in red when the projector is on.	<ul style="list-style-type: none"> The filter cover or lamp unit cover is open. 	<ul style="list-style-type: none"> Securely install the cover. If you want to turn the projector on afterwards, you need to unplug and then plug the power cord in again to reset the projector. If the power indicator blinks in red even when the filter cover and lamp unit cover is securely installed, contact your nearest Sharp Authorised Projector Dealer or Service Centre for advice.

Info

- If the temperature warning indicator blinks, and the projector enters the standby mode, follow the possible solutions on page **52** and then wait until the projector has cooled down completely before plugging in the power cord and turning the power back on. (At least 5 minutes.)
- If the power is turned off for a brief moment due to power outage or some other cause while using the projector, and the power supply recovers immediately after that, the lamp indicator will illuminate in red and the lamp may not be lit. In this case, unplug the power cord from the AC outlet, replace the power cord in the AC outlet and then turn the power on again.
- If you want to clean the air vents during projector operation, be sure to put the projector into the standby mode by pressing ^{STANDBY}  on the projector or ^{STANDBY}  on the remote control. After the cooling fan has stopped, clean the vents.
- The cooling fan keeps the internal temperatures of the projector constant and this function is controlled automatically. The sound of the cooling fan may change during operation because the fan speed may change and this is not a malfunction.
- Do not unplug the power cord after the projector has entered the standby mode and while the cooling fan is running. This can cause damage due to rise in internal temperature, as the cooling fan also stops.

Regarding the Lamp

Lamp

- It is recommended that the lamp (sold separately) be replaced when the remaining lamp life becomes 5% or less, or when you notice a significant deterioration in the picture and colour quality. The lamp life (percentage) can be checked with the on-screen display. See page 47.
- For lamp replacement, please consult your nearest Sharp Authorised Projector Dealer or Service Centre.

Caution Concerning the Lamp

- This projector utilises a pressurised mercury lamp. A loud sound may indicate lamp failure. Lamp failure can be attributed to numerous sources such as: excessive shock, improper cooling, surface scratches or deterioration of the lamp due to a lapse of usage time. The period of time up to failure largely varies depending on the individual lamp and/or the condition and the frequency of use. It is important to note that failure can often result in the bulb cracking.
- When the lamp indicator and on-screen display icon are illuminated, it is recommended that the lamp be replaced with a new one immediately, even if the lamp appears to be operating normally.
- Should the lamp break, the glass particles may spread inside the lamp cage or gas contained in the lamp may be vented into the room from the exhaust vent. Because the gas in this lamp includes mercury, ventilate the room well if the lamp breaks and avoid all exposure to the released gas. In case of exposure to the gas, consult a doctor as soon as possible.
- Should the lamp break, there is also a possibility that glass particles may spread inside of the projector. In such a case, it is recommended you contact your nearest Sharp Authorised Projector Dealer or Service Centre to remove the damaged lamp and assure safe operation.

Replacing the Lamp



Caution

- Do not remove the lamp unit immediately after operation of the projector. The lamp will be hot and touching it can lead to burn or injury.
- Wait at least one hour after the power cord is disconnected to allow the surface of the lamp unit to fully cool before removing the lamp unit.
- If the new lamp does not light after replacement, take your projector to the nearest Sharp Authorised Projector Dealer or Service Centre for repair. Purchase a replacement lamp unit of type BQC-PGB10S//1 from your nearest Sharp Authorised Projector Dealer or Service Centre. Then carefully change the lamp by following the instructions described in this section. If you wish, you may have the lamp replaced at your nearest Sharp Authorised Projector Dealer or Service Centre.

Removing and Installing the Lamp Unit

Info

- Be sure to remove the lamp unit using the handle. Be sure not to touch the glass surface of the lamp unit or the inside of the projector.
- To avoid injury to yourself and damage to the lamp, be sure to carefully follow the steps below.
- Do not loosen other screws except for the lamp unit cover and lamp unit.
- Please refer to the installation manual included with the lamp unit.

- 1 Press  on the projector or  on the remote control to put the projector into the standby mode.**

- Wait until the cooling fan stops.

Warning!

- Do not remove the lamp unit from the projector right after use. The lamp will be very hot and may cause burn or injury.

- 2 Disconnect the power cord.**

- Unplug the power cord from the AC socket.
- Leave the lamp until it has fully cooled down (about 1 hour).

- 3 Change the air filter.**

- Change the air filter whenever you install the lamp unit (see pages 61 and 62).

- 4 Remove the lamp unit cover.**

- Turn the projector over. Loosen the user service screw (for lamp unit cover) (①) that secures the lamp unit cover. Pressing the tab, remove the lamp unit cover (②).

Lamp unit

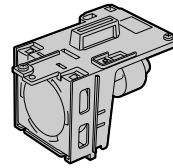

BQC-PGB10S//1

STANDBY button

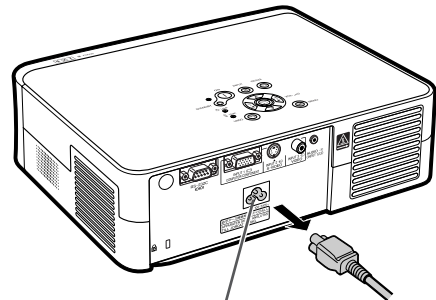
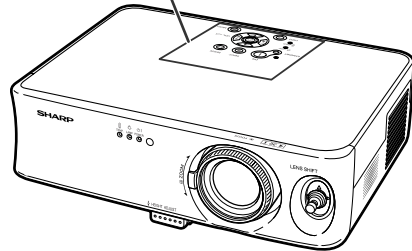
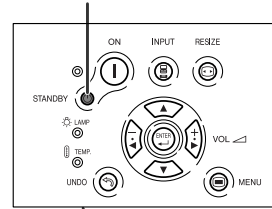

AC socket

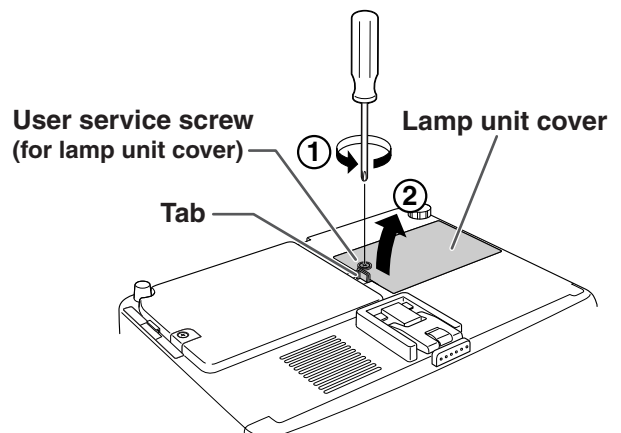

Regarding the Lamp

5 Remove the lamp unit.

- Loosen the securing screws from the lamp unit. Hold the lamp unit by the handle and pull it in the direction of the arrow. At this time, keep the lamp unit horizontal and do not tilt it.

6 Insert the new lamp unit.

- Press the lamp unit firmly into the lamp unit compartment. Fasten the securing screws.

7 Replace the lamp unit cover.

- Align the tab on the lamp unit cover (①) and place it while pressing the tab (②) to close it. Then tighten the user service screw (for lamp unit cover) (③) to secure the lamp unit cover.

Info

- If the lamp unit and lamp unit cover are not correctly installed, the power will not turn on, even if the power cord is connected to the projector.

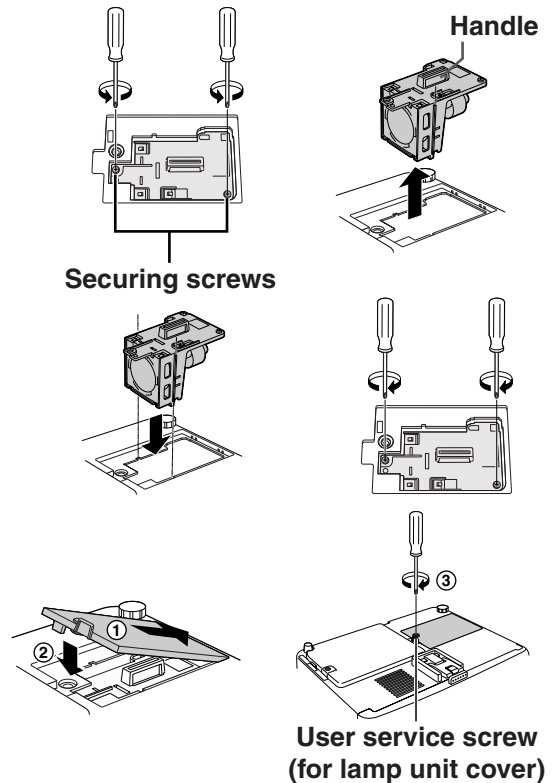







Resetting the Lamp Timer

Reset the lamp timer after replacing the lamp.

1 Connect the power cord.

- Plug the power cord into the AC socket of the projector.
- Make sure that the power indicator on the projector illuminates in red.

2 Reset the lamp timer.

- Press  (ON),  (INPUT),  (UNDO), , , and  on the projector in order, and then press  (ON) on the projector.
- "LAMP 0000H" is displayed, indicating that the lamp timer is reset.

Info

- Make sure to reset the lamp timer only when replacing the lamp. If you reset the lamp timer and continue to use the same lamp, this may cause the lamp to become damaged or explode.

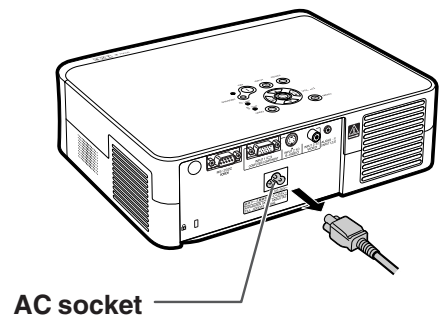

Connecting Pin Assignments

INPUT 1 COMPUTER/COMPONENT Signal Terminal: 15-pin Mini D-sub female connector

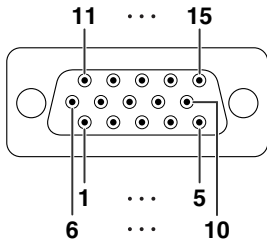

Component Input

1. P_R (C_R)
2. Y
3. P_B (C_B)
4. Not connected
5. Not connected
6. Earth (P_R)
7. Earth (Y)
8. Earth (P_B)
9. Not connected
10. Not connected
11. Not connected
12. Not connected
13. Not connected
14. Not connected
15. Not connected

RGB Input

1. Video input (red)
2. Video input (green/sync on green)
3. Video input (blue)
4. Not connected
5. Not connected
6. Earth (red)
7. Earth (green/sync on green)
8. Earth (blue)
9. Not connected
10. GND
11. Not connected
12. Not connected
13. Horizontal sync signal: TTL level
14. Vertical sync signal: TTL level
15. Not connected

RS-232C Port: 9-pin D-sub male connector

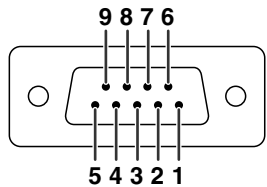

Pin No.	Signal	Name
1		
2	RD	Receive Data
3	SD	Send Data
4		Reserved
5	SG	Signal Ground
6		Reserved
7		Reserved
8		Reserved
9		

I/O	Reference
	Not connected
Input	Connected to internal circuit
Output	Connected to internal circuit
	Connected to internal circuit
	Connected to internal circuit
	Connected to internal circuit
	Connected to internal circuit
	Connected to internal circuit
	Not connected

RS-232C Specifications and Command Settings

PC control

It is recommended that the following operation system be used only for those familiar with the computer operation.

A computer can be used to control the projector by connecting an RS-232C cable (cross type, commercially available) to the projector. (See page 25 for connection.)

Communication conditions

Set the serial port settings of the computer to match that of the table.

Signal format: Conforms to RS-232C standard.

Parity bit: None

Baud rate: 9,600 bps

Stop bit: 1 bit

Data length: 8 bits

Flow control: None

Basic format

Commands from the computer are sent in the following order: command, parameter, and return code. After the projector processes the command from the computer, it sends a response code to the computer.

Command format

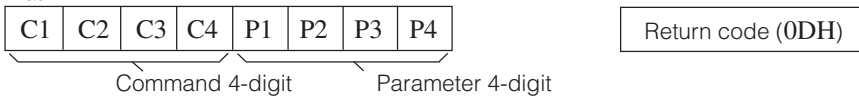

Response code format

Normal response

Problem response (communication error or incorrect command)



Info

- When controlling the projector using RS-232C commands from a computer, wait for at least 30 seconds after the power has been turned on, and then transmit the commands.
- When more than one code is being sent, send each command only after the response code for the previous command from the projector is verified.

Commands

Example: When turning on the projector, make the following setting.

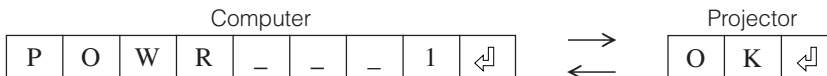

	COMMAND	PARAMETER	RETURN
Standby	P O W E R	- - -	0 OK or ERR
Power On	P O W E R	- - -	1 OK or ERR
INPUT1	I R G B	- - -	1 OK or ERR
INPUT2	I V E D	- - -	1 OK or ERR
INPUT3	I V E D	- - -	2 OK or ERR
INPUT1 SIGNAL TYPE : RGB	I A S I	- - -	1 OK or ERR
INPUT1 SIGNAL TYPE : COMPONENT	I A S I	- - -	2 OK or ERR
Lamp Usage Time (hour)	T L T T	- - -	1 0-9999
Remaining Lamp Life (Percentage)	T L T L	- - -	1 0-100
Lamp Status	T L P S	- - -	1 0:Off, 1:On, 2:Retry, 3:Waiting, 4:Lamp Error
Unit Status	T A B N	- - -	1 0:Normal, 1:Temp High, 2:Fan Err, 4:Filter or lamp Cover Err, 8:Lamp Life 5% or less, 16:Lamp Burnt-out, 32:Lamp Not Lit, 64:Temp Abnormally High
Model Name Check	T N A M	- - -	1 PROJECTOR NAME
Mute Off	M U T E	- - -	0 OK or ERR
Mute On	M U T E	- - -	1 OK or ERR
Auto Sync Start	A D J S	- - -	1 OK or ERR

Note

- If an underbar (_) appears in the parameter column, enter a space.

Computer Compatibility Chart

Computer

- Multiple signal support
Horizontal Frequency: 24–70 kHz, Vertical Frequency: 43–75 Hz, Pixel Clock: 12–80 MHz
- Compatible with sync on green signal
- SVGA, XGA compatible in intelligent compression

The following is a list of modes that conform to VESA. However, this projector supports other signals that are not VESA standards.

PC/MAC/WS	Resolution	Horizontal Frequency (kHz)	Vertical Frequency (Hz)	VESA Standard	Display	
PC	VGA	640 × 350	27.0	60		Upscale
			31.5	70		
		640 × 400	27.0	60		
			31.5	70		
		720 × 350	27.0	60		
			31.5	70		
		720 × 400	27.0	60		
			31.5	70		
		640 × 480	26.2	50		
			31.5	60	✓	
	34.7		70			
	37.9		72	✓		
	37.5		75	✓		
	31.4		50			
	SVGA	800 × 600	35.1	56	✓	Intelligent Compression
			37.9	60	✓	
			46.6	70		
			48.1	72	✓	
			46.9	75	✓	
			35.5	43		
XGA	1,024 × 768	40.3	50			
		48.4	60	✓		
		56.5	70	✓		
		60.0	75	✓		
MAC 13"	VGA	640 × 480	34.9	67		Upscale
MAC 16"	SVGA	832 × 624	49.7	75		Intelligent Compression
MAC 19"	XGA	1,024 × 768	60.2	75		

Note

- This projector may not be able to display images from notebook computers in simultaneous (CRT/LCD) mode. Should this occur, turn off the LCD display on the notebook computer and output the display data in “CRT only” mode. Details on how to change display modes can be found in your notebook computer’s operation manual.
- When this projector receives 640 × 350 VESA format VGA signals, “640 × 400” appears on the screen.
- When projecting the RGB interlace signal using INPUT 1 with “Signal Type” set to “RGB”, the image may not be projected as desired. In this case, select either INPUT 2 (S-Video) or INPUT 3 (Video).

DTV

Signal	Horizontal Frequency (kHz)	Vertical Frequency (Hz)
480I	15.7	60
480P	31.5	60
540P	33.8	60
580I	15.6	50
580P	31.3	50
720P	45.0	60
1035I	28.1	50
1035I	33.8	60
1080I	28.1	50
1080I	33.8	60

Maintenance

Cleaning the projector

- Be sure to unplug the power cord before cleaning the projector.
- The cabinet as well as the operation panel is made of plastic. Avoid using benzene or thinner, as these can damage the finish on the cabinet.
- Do not use volatile agents such as insecticides on the projector.
Do not attach rubber or plastic items to the projector for a long time.
The effects of some of the agents in the plastic may cause damage to the quality or finish of the projector.

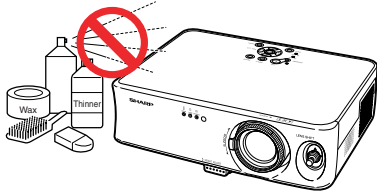

- Wipe off dirt gently with a soft flannel cloth.

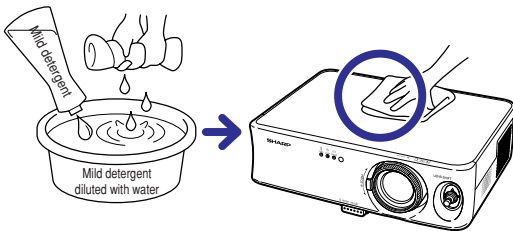

- When the dirt is hard to remove, soak a cloth in a mild detergent diluted with water, wring the cloth well and then wipe the projector.
Strong cleaning detergents may discolour, warp or damage the coating on the projector.
Make sure to test on a small, inconspicuous area on the projector before use.

Cleaning the lens

- Use a commercially available blower or lens cleaning paper (for glasses and camera lenses) for cleaning the lens. Do not use any liquid type cleaning agents, as they may wear off the coating film on the surface of the lens.
- As the surface of the lens can easily get damaged, be sure not to scrape or hit the lens.

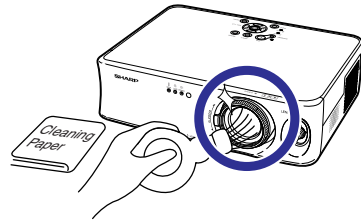

Cleaning the exhaust and intake vents

- Use a vacuum cleaner to clean dust from the exhaust vent and the intake vent.

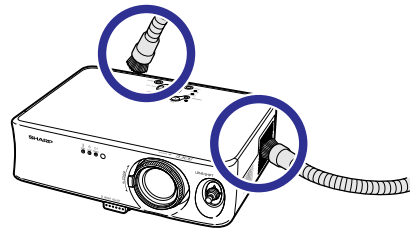

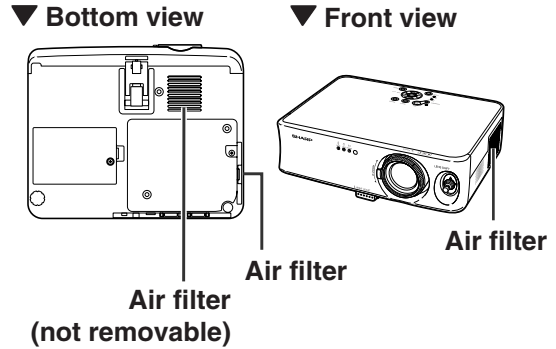

Replacing the Air Filter

- This projector is equipped with air filters to ensure the optimal operating condition of the projector.
- The air filters should be cleaned every 100 hours of use. Clean the filters more often when the projector is used in a dusty or smoky location.
- Ask your nearest Sharp Authorized Projector Dealer or Service Center to exchange the filter (PFILDA010WJZZ) when it is no longer possible to clean.



Cleaning and Replacing the Air Filter

- 1 Put the projector into the standby mode, and disconnect the power cord.**

- Press **STANDBY**  on the projector or **STANDBY**  on the remote control, and wait until the cooling fan stops.

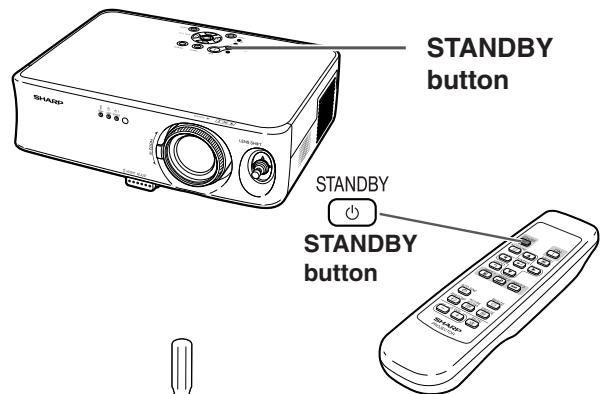

- 2 Remove the filter cover on the bottom of the projector.**

- Turn the projector over. Loosen the user service screw (for filter cover) (①) that secures the filter cover. Pressing the tab, remove the filter cover (②).

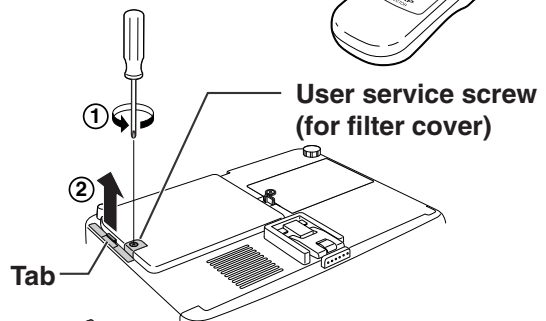

- 3 Remove the air filter.**

- Pick the air filter up with your fingers and lift it out of the filter cover.

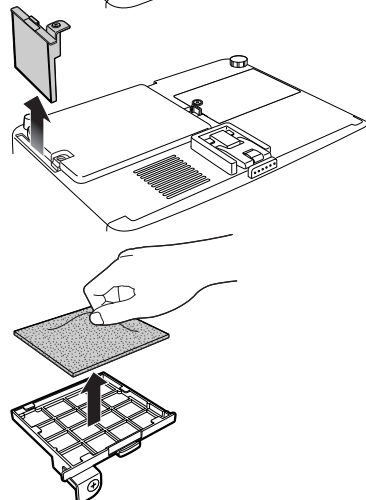

Replacing the Air Filter

4 Clean the air filter.

- Clean the dust off the air filter and cover with a vacuum cleaner extension hose.



5 Replace the air filter.

- Place the air filter underneath the tabs on the filter cover.

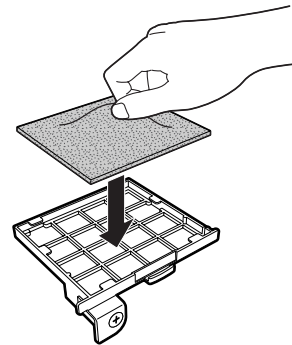

6 Replace the filter cover.

- Align the tab on the filter cover and place it while pressing the tab to close it (①). Then tighten the user service screw (for filter cover) (②) to secure the filter cover.

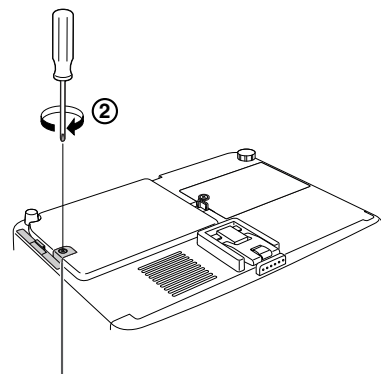
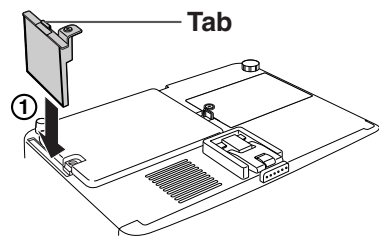





**User service screw
(for filter cover)**

Note

- Be sure the filter cover is securely installed. The power will not turn on unless it is correctly installed.
- If dust or dirt has collected inside the bottom air filter (not removable), clean the filter with a vacuum cleaner extension hose.

Troubleshooting

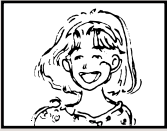
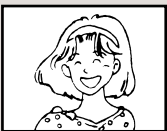
Problem	Check	Page
 Projector does not start or there is no picture and no sound.	<ul style="list-style-type: none"> • Projector power cord is not plugged into the wall outlet. 	20
	<ul style="list-style-type: none"> • Power to the external connected devices is off. 	—
	<ul style="list-style-type: none"> • The selected input mode is wrong. 	27
	<ul style="list-style-type: none"> • The MUTE function is working. 	28
	<ul style="list-style-type: none"> • Cables incorrectly connected to rear panel of the projector. 	20-25
	<ul style="list-style-type: none"> • Remote control batteries have run out. 	15
	<ul style="list-style-type: none"> • The filter cover or the lamp unit cover is not installed correctly. 	56, 62
 Sound is heard but no picture appears.	<ul style="list-style-type: none"> • Cables incorrectly connected to the rear panel of the projector. 	20-25
	<ul style="list-style-type: none"> • “Bright” is set to minimum position. 	42
On-screen display does not appear.	<ul style="list-style-type: none"> • “OSD Display” is set to “” (OFF). 	47
 Colour is faded or poor.	<ul style="list-style-type: none"> • Picture adjustments are incorrectly set. 	42
	(Video Input only) <ul style="list-style-type: none"> • Video input system is incorrectly set. 	48
	(INPUT 1 only) <ul style="list-style-type: none"> • Input signal type (Component/RGB) is incorrectly set. 	44
 Picture is blurred; noise appears.	<ul style="list-style-type: none"> • Adjust the focus. 	30
	<ul style="list-style-type: none"> • The projection distance exceeds the focus range. 	17
	(Computer Input only) <ul style="list-style-type: none"> • Perform “Fine Sync” Adjustments (“Clock” Adjustment) 	45
	<ul style="list-style-type: none"> • Perform “Fine Sync” Adjustments (“Phase” Adjustment) • Noise may appear depending on the computer. 	45 —
 Picture appears but no sound is heard.	<ul style="list-style-type: none"> • Cables incorrectly connected to rear panel of projector. 	20-25
	<ul style="list-style-type: none"> • Volume is set to minimum. 	27
An unusual sound is occasionally heard from the cabinet.	<ul style="list-style-type: none"> • If the picture is normal, the sound is due to cabinet shrinkage caused by room temperature changes. This will not affect operation or performance. 	—
Maintenance indicator illuminates.	<ul style="list-style-type: none"> • See “Maintenance Indicators”. 	52
Remote control does not operate.	<ul style="list-style-type: none"> • The batteries in the remote control have run out. • The batteries are inserted incorrectly into the remote control. 	15



Troubleshooting

Problem	Check	Page
Picture is green on INPUT 1 COMPONENT.	• Change the input signal type setting.	44
Picture is pink (no green) on INPUT 1 RGB.		
Picture is dark.	• The lamp indicator is illuminating in red. Replace the lamp.	52
Picture is too bright and whitish.	• Picture adjustments are incorrectly set.	42

Specifications

Product type	Projector
Model	XV-Z10E
Video system	NTSC3.58/NTSC4.43/PAL/PAL-M/PAL-N/PAL-60/SECAM/ DTV480I/DTV480P/DTV540P/DTV580I/DTV580P/DTV720P/DTV1035I/DTV1080I/ DTV1080I-50
Display method	LCD panel × 3, RGB optical shutter method
LCD panel	Panel size: 0.54" (6.766 [H] × 12.012 [W] mm) No. of dots: 409,920 dots (854 [H] × 480 [V])
Lens	1–1.25 × zoom lens, F1.6–1.9, f = 16.8–20.9 mm
Projection lamp	130 W AC lamp
Component input signal (INPUT1)	15-pin mini D-sub connector Y: 1.0 Vp-p, sync negative, 75 Ω terminated P _B : 0.7 Vp-p, 75 Ω terminated P _R : 0.7 Vp-p, 75 Ω terminated
Horizontal resolution	520 TV lines (DTV720P)
Computer RGB input signal (INPUT 1)	15-pin mini D-sub connector RGB separate/sync on green type analog input: 0–0.7 Vp-p, positive, 75 Ω terminated HORIZONTAL SYNC. SIGNAL: TTL level (positive/negative) VERTICAL SYNC. SIGNAL: Same as above
S-video input signal (INPUT 2)	4-pin mini DIN connector Y (luminance signal): 1.0 Vp-p, sync negative, 75 Ω terminated C (chrominance signal): Burst 0.286 Vp-p, 75 Ω terminated
Video input signal (INPUT 3)	RCA connector: VIDEO, composite video, 1.0 Vp-p, sync negative, 75 Ω terminated
Computer control signal (RS-232C)	9-pin D-sub male connector
Pixel clock	12–80 MHz
Vertical frequency	43–75 Hz
Horizontal frequency	24–70 kHz
Audio input signal	ø3.5 mm minijack: AUDIO, 0.5 Vrms, more than 22 kΩ (stereo)
Audio output	1.0 W (monaural)
Speaker system	2.8 cm round × 1
Rated voltage	AC 100–240 V
Input current	1.9 A
Rated frequency	50/60 Hz
Power consumption	185 W (Standard mode)/170 W (Eco mode) with AC 100 V 175 W (Standard mode)/160 W (Eco mode) with AC 240 V
Power consumption (standby)	4 W (AC 100 V) – 6 W (AC 240 V)
Heat dissipation	695 BTU/hour (Standard mode)/640 BTU/hour (Eco mode) with AC 100 V 660 BTU/hour (Standard mode)/600 BTU/hour (Eco mode) with AC 240 V
Operating temperature	+5°C to +35°C
Storage temperature	–20°C to +60°C
Cabinet	Plastic
I/R carrier frequency	38 kHz
Dimensions (approx.)	294 (W) × 92 (H) × 234.5 (D) mm (main body only)
Weight (approx.)	2.7 kg
Supplied accessories	Remote control, Two AA size batteries, Power cord, Video cable, Three RCA adapter plugs, 3 RCA to 15-pin D-sub cable, 21 pin RCA conversion adapter (for Europe), Lens cap (attached), Extra air filter, Lens shipping block (attached), Operation manual
Replacement parts	Lamp unit (Lamp/cage module) (BQC-PGB10S//1), Remote control (RRMCGA220WJSA), Batteries ("AA" size), Power cord for Europe, except U.K. (QACCVA006WJPZ), Power cord for U.K., Hong Kong and Singapore (QACCBAA015WJPZ), Power cord for Australia, New Zealand and Oceania (QACCLA005WJPZ), Video cable (QCNWGA001WJZZ), RCA adapter plugs (QPLGJA002WJZZ), 3 RCA to 15-pin D-sub cable (QCNWGA043WJPZ), 21 pin RCA conversion adapter (QSOCZ0361CEZZ), Lens cap (CCAPHA004WJ01), Air filter (PFILDA010WJZZ), Lens shipping block (SPAKXA333WJZZ), Operation manuals; for European 7 languages (TINS-B021WJZZ) / for Chinese, Korean and Arabic (TINS-B082WJZZ)

As a part of policy of continuous improvement, SHARP reserves the right to make design and specification changes for product improvement without prior notice. The performance specification figures indicated are nominal values of production units. There may be some deviations from these values in individual units.

Dimensions

Units: mm

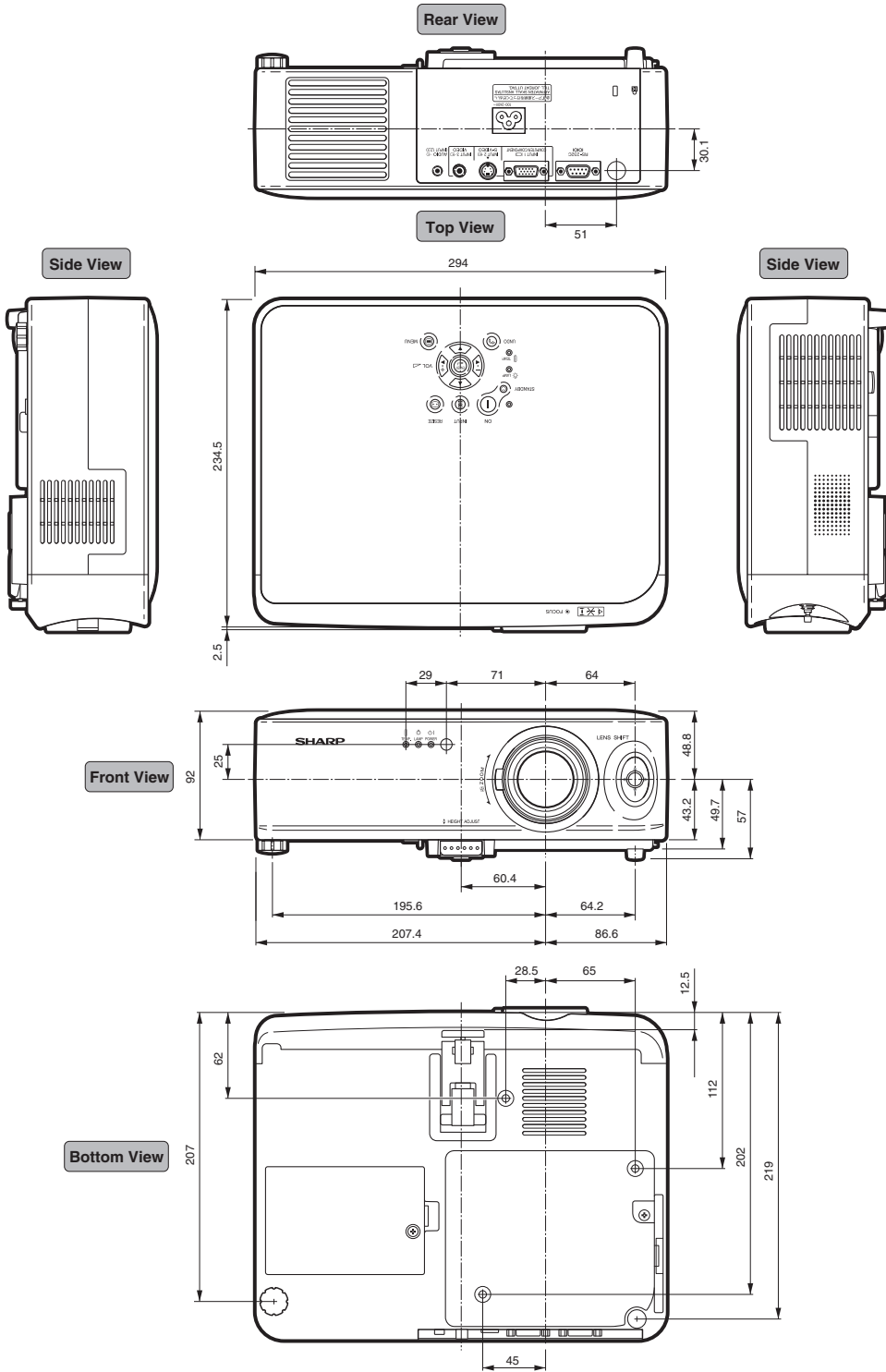

Glossary

Aspect Ratio

Width and height ratio of an image. The normal aspect ratio of a computer and video image is 4:3. There are also wide images with an aspect ratio of 16:9 and 21:9.

Auto Sync

Optimises projected computer images by automatically adjusting certain characteristics.

Background

Initial setting image projected when no signal is being output.

CINEMA ZOOM

Mode that cuts out the top/bottom blank bands and projects a wide screen image.

Clock

Clock adjustment is used to adjust vertical noise when clock level is incorrect.

CLR Temp (Colour temperature)

Function that can be used to adjust the colour temperature to suit the type of image input to the projector. Decrease the colour temperature to create warmer, reddish images for natural flesh tones, or increase to create cooler, bluish images for a brighter picture.

Gamma

Image quality enhancement function that offers a richer image by brightening the darker portions of the image without altering the brightness of the brighter portions. You can select four different modes: Standard, Cinema1, Cinema2 and Brighten.

Keystone Correction

Function to digitally correct a distorted image when the projector is set up at an angle.

Lens shift

Function to adjust the position of the projection image by using the lens shift lever to move the lens from side to side and up and down (360°).

Phase

Phase shift is a timing shift between isomorphic signals with the same resolution. When phase level is incorrect, the projected image typically displays horizontal flicker.

RS-232C terminal

Controls the projector from the computer.

Resize

Allows you to modify or customize the picture display mode to enhance the input image. You can select three different modes: STRETCH, SIDE BAR and CINEMA ZOOM.

STRETCH

Mode that displays the image fully on a 16:9 screen.

Index

3 RCA to 15-pin D-sub cable	22	ON button	26
21 pin RCA conversion adapter	14	Optional accessory	14
AC socket	20	Options	47
Adjustment buttons	29	OSD Display	47
Air filter	61	Phase	45
Aspect ratio	35	Picture Adjustment	42
AUDIO INPUT terminal	21	Picture Setting	44
Auto Power Off	49	PICTURE SETTING button	44
Auto Sync (Auto Sync adjustment)	46	Power cord	20
AUTO SYNC button	45, 46	Power indicator	11, 52
Background	48	PRJ mode (Reversing Projected Images)	51
Batteries	15	RCA adapter plug	23
Blue	42	Rear adjustment foot	31
Bright	42	Red	42
Clock	45	Remote control	15
CINEMA ZOOM	35	Remote control sensor	15
CLR Temp (Colour Temperature)	43	Replacing the lamp	54
Color	42	RESIZE button	34
Computer Image Adjustment	45	RGB cable	24
Contrast	42	RGB/COMP. button	44
Eco Mode	49	RS-232C terminal	25
ENTER button	37	Sharp	42
Exhaust vent	60	SIDE BAR	35
Ferrite core	23	Signal Info	46
Fine Sync	45	Signal Type	44
Focus ring	30	Special Modes	45
FREEZE button	33	STANDBY button	28
Front adjustment foot	31	STRETCH	35
Gamma	43	Supplied accessories	14
H-Pos	45	Temperature warning indicator	11, 52
HEIGHT ADJUST button	31	Tint	42
INPUT 1 terminal	22	Trapezoidal distortion	29
INPUT 1 – 3 modes	27	UNDO button	29
INPUT 2 terminal	21	Video cable	21
INPUT 3 terminal	21	Video System	48
INPUT button	27	Volume buttons	27
Intake vent	60	V-Pos	45
Kensington Security Standard connector	12	Zoom knob	30
KEYSTONE button	29		
Keystone Correction	29		
Lamp	54		
Lamp indicator	11, 52		
Lamp Timer (Life)	47		
Language (on-screen display language)	51		
Lens cap	10		
Lens shift lever	32		
Lens shipping block	11		
MENU button	36		
Menu Color	50		
Menu Position	50		
MUTE button	28		

SHARP®

SHARP CORPORATION

Printed on 100% post-consumer recycled paper.
Gedruckt auf 100% wiederverwertungs Papier.
Imprimé sur 100% de papier recyclé.
Utskrift på återvunnet papper av 100% återvunnet material.
Impreso en 100% de papel reciclado de postconsumo.
Stampato su carta riciclata al 100%.
Gedruckt op 100% kringlooppapier.



Printed in Japan
In Japan gedruckt
Imprimé au Japon
Triykt i Japan
Impreso en Japón
Stampato in Giappone
Gedruckt in Japan

TINS-B021WJZZ 
03P11-JWM