

myprojectorlamps.com

**The most trusted, dependable name
in projector lamp sales.**



<http://www.myprojectorlamps.com>



<http://www.myprojectorlamps.ca>



<http://www.myprojectorlamps.eu>

The following projector manual has not been modified or altered in any way.

SHARP®

DATA PROJECTOR

MODEL

XG-C465X

XG-C435X

OPERATION MANUAL

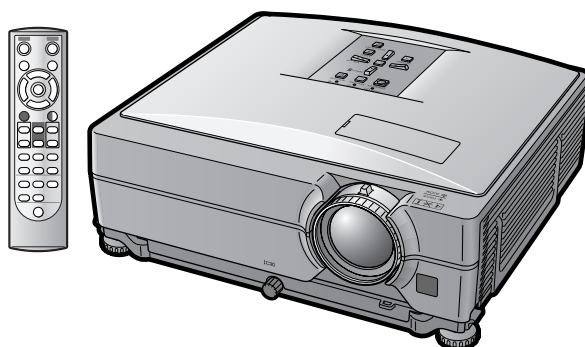

Introduction

Quick Start

Setup

Connections

Basic Operation

Useful Features

Appendix



IMPORTANT

- For your assistance in reporting the loss or theft of your Projector, please record the Model and Serial Numbers located on the bottom of the projector and retain this information.
- Before recycling the packaging, please ensure that you have checked the contents of the carton thoroughly against the list of “Supplied accessories” on page 10.

Model No.:

Serial No.:

SPECIAL NOTE FOR USERS IN THE U.K.

The mains lead of this product is fitted with a non-rewireable (moulded) plug incorporating a 10A fuse. Should the fuse need to be replaced, a BSI or ASTA approved BS 1362 fuse marked  or  and of the same rating as above, which is also indicated on the pin face of the plug, must be used.

Always refit the fuse cover after replacing the fuse. Never use the plug without the fuse cover fitted.

In the unlikely event of the socket outlet in your home not being compatible with the plug supplied, cut off the mains plug and fit an appropriate type.

DANGER:

The fuse from the cut-off plug should be removed and the cut-off plug destroyed immediately and disposed of in a safe manner.

Under no circumstances should the cut-off plug be inserted elsewhere into a 10A socket outlet, as a serious electric shock may occur.

To fit an appropriate plug to the mains lead, follow the instructions below:

WARNING:

THIS APPARATUS MUST BE EARTHED.

IMPORTANT:

The wires in this mains lead are coloured in accordance with the following code:

Green-and-yellow : Earth / Blue : Neutral / Brown : Live

As the colours of the wires in the mains lead of this apparatus may not correspond with the coloured markings identifying the terminals in your plug proceed as follows:

- The wire which is coloured green-and-yellow must be connected to the terminal in the plug which is marked by the letter E or by the safety earth symbol  or coloured green or green-and-yellow.
- The wire which is coloured blue must be connected to the terminal which is marked with the letter N or coloured black.
- The wire which is coloured brown must be connected to the terminal which is marked with the letter L or coloured red.

IF YOU HAVE ANY DOUBT, CONSULT A QUALIFIED ELECTRICIAN.

The supplied CD-ROM contains operation instructions in English, German, French, Spanish, Italian, Dutch, Swedish, Portuguese, Chinese and Korean. Carefully read through the operation instructions before operating the projector.

Die mitgelieferte CD-ROM enthält Bedienungsanleitungen in Englisch, Deutsch, Französisch, Spanisch, Italienisch, Niederländisch, Schwedisch, Portugiesisch, Chinesisch und Koreanisch. Bitte lesen Sie die Bedienungsanleitung vor der Verwendung des Projektors sorgfältig durch.

Le CD-ROM fourni contient les instructions de fonctionnement en anglais, allemand, français, espagnol, italien, néerlandais, suédois, portugais, chinois et coréen. Veuillez lire attentivement ces instructions avant de faire fonctionner le projecteur.

Den medföljande CD-ROM-skivan innehåller bruksanvisningar på engelska, tyska, franska, spanska, italienska, holländska, svenska, portugisiska, kinesiska och koreanska. Läs noga igenom bruksanvisningen innan projektorn tas i bruk.

El CD-ROM suministrado contiene instrucciones de operación en inglés, alemán, francés, español, italiano, holandés, sueco, portugués, chino y coreano. Lea cuidadosamente las instrucciones de operación antes de utilizar el proyector.

Il CD-ROM in dotazione contiene istruzioni per l'uso in inglese, tedesco, francese, spagnolo, italiano, olandese, svedese, portoghese, cinese e coreano. Leggere attentamente le istruzioni per l'uso prima di usare il proiettore.

De meegeleverde CD-ROM bevat handleidingen in het Engels, Duits, Frans, Spaans, Italiaans, Nederlands, Zweeds, Portugees, Chinees en Koreaans. Lees de handleiding zorgvuldig door voor u de projector in gebruik neemt.

O CD-ROM fornecido contém instruções de operação em Inglês, Alemão, Francês, Espanhol, Italiano, Holandês, Sueco, Português, Chinês e Coreano. Leia cuidadosamente todas as instruções de operação antes de operar o projetor.

附送之CD-ROM光碟中，有用英文、德文、法文、西班牙文、意大利文、荷蘭文、瑞典文、葡萄牙文、中文和韓國文所寫的使用說明書。在操作本投影機之前，請務必仔細閱讀整本使用說明書。

제공된 CD-ROM에는 영어, 독일어, 프랑스어, 스페인어, 이탈리아어, 네덜란드어, 스웨덴어, 포르투갈어, 중국어, 그리고 한국어로 작성된 조작 설명서가 포함되어 있습니다. 프로젝터를 조작하기 전에 조작 지침을 상세하게 숙지하십시오.

Before using the projector, please read this operation manual carefully.

Introduction

ENGLISH

There are two important reasons for prompt warranty registration of your new SHARP Projector, using the REGISTRATION CARD packed with the projector.

1. WARRANTY

This is to assure that you immediately receive the full benefit of the parts, service and labor warranty applicable to your purchase.

2. CONSUMER PRODUCT SAFETY ACT

To ensure that you will promptly receive any safety notification of inspection, modification, or recall that SHARP may be required to give under the 1972 Consumer Product Safety Act, PLEASE READ CAREFULLY THE IMPORTANT "LIMITED WARRANTY" CLAUSE.



U.S.A. ONLY

WARNING: High brightness light source. Do not stare into the beam of light, or view directly. Be especially careful that children do not stare directly into the beam of light.



WARNING: To reduce the risk of fire or electric shock, do not expose this product to rain or moisture.

See bottom of projector.

	CAUTION RISK OF ELECTRIC SHOCK. DO NOT REMOVE SCREWS EXCEPT SPECIFIED USER SERVICE SCREW.	
CAUTION: TO REDUCE THE RISK OF ELECTRIC SHOCK, DO NOT REMOVE COVER. NO USER-SERVICEABLE PARTS EXCEPT LAMP UNIT. REFER SERVICING TO QUALIFIED SERVICE PERSONNEL.		



The lightning flash with arrowhead symbol, within an equilateral triangle, is intended to alert the user to the presence of uninsulated "dangerous voltage" within the product's enclosure that may be of sufficient magnitude to constitute a risk or electric shock to persons.



The exclamation point within a triangle is intended to alert the user to the presence of important operating and maintenance (servicing) instructions in the literature accompanying the product.

WARNING: FCC Regulations state that any unauthorized changes or modifications to this equipment not expressly approved by the manufacturer could void the user's authority to operate this equipment.

U.S.A. ONLY

INFORMATION

This equipment has been tested and found to comply with the limits for a Class A digital device, pursuant to Part 15 of the FCC Rules. These limits are designed to provide reasonable protection against harmful interference when the equipment is operated in a commercial environment. This equipment generates, uses, and can radiate radio frequency energy and, if not installed and used in accordance with the operation manual, may cause harmful interference to radio communications. Operation of this equipment in a residential area is likely to cause harmful interference, in which case the user will be required to correct the interference at his own expense.

U.S.A. ONLY

The enclosed computer cable must be used with the device. The cable is provided to ensure that the device complies with FCC Class A verification.

U.S.A. ONLY

WARNING:

This is a Class A product. In a domestic environment this product may cause radio interference in which case the user may be required to take adequate measures.

WARNING:

The cooling fan in this projector continues to run for about 90 seconds after the projector enters the standby mode. During normal operation, when putting the projector into standby mode always use the STANDBY button on the projector or on the remote control. Ensure the cooling fan has stopped before storing the projector in the storage case.

DURING NORMAL OPERATION, NEVER TURN THE PROJECTOR OFF BY DISCONNECTING THE POWER CORD. FAILURE TO OBSERVE THIS WILL RESULT IN PREMATURE LAMP FAILURE.

PRODUCT DISPOSAL

This product utilizes tin-lead solder, and lamp containing a small amount of mercury. Disposal of these materials may be regulated due to environmental considerations. For disposal or recycling information, please contact your local authorities, the Electronics Industries Alliance: www.eiae.org, the lamp recycling organization www.lamprecycle.org, or Sharp at 1-800-BE-SHARP.

U.S.A. ONLY

Caution Concerning Lamp Replacement

See "Replacing the Lamp" on page 60.

This SHARP projector uses an LCD (Liquid Crystal Display) panel. This very sophisticated panel contains 786,432 pixels (x RGB) TFT's (Thin Film Transistors). As with any high technology electronic equipment such as large screen TVs, video systems and video cameras, there are certain acceptable tolerances that the equipment must conform to.

This unit has some inactive pixels within acceptable tolerances which may result in inactive dots on the picture screen. This will not affect the picture quality or the life expectancy of the unit.

- Microsoft® and Windows® are registered trademarks of Microsoft Corporation in the United States and/or other countries.
- PC/AT is a registered trademark of International Business Machines Corporation in the United States.
- Adobe® Reader® is a trademark of Adobe Systems Incorporated.
- Macintosh® is a registered trademark of Apple Computer, Inc. in the United States and/or other countries.
- All other company or product names are trademarks or registered trademarks of their respective companies.

Authorized representative responsible for the European Union Community Market

SHARP ELECTRONICS (Europe) GmbH
Sonninstraße 3, D-20097 Hamburg

E.U. ONLY

How to Read this Operation Manual

- In this operation manual, the illustrations and on-screen displays are simplified for explanation. This may differ from the actual on-screen display.

Using the Menu Screen

Buttons used in this operation

Buttons used in this operation

Menu Selections

Example: Adjusting "Bright"

- This operation can also be performed by using the buttons on the projector.

- 1 Press **MENU**.
 - The "Picture" menu screen for the selected input mode is displayed.
- 2 Press **▶** or **◀** to display the other menu screens.
 - The menu icon for the selected menu screen is highlighted.

Menu icon	Menu screen
	Picture
	Fine Sync
	Options1
	Options2
	Language

Note

 - The "Fine Sync" menu is not available for selecting VIDEO or S-VIDEO.

Example: "Picture" screen menu for COMPUTER/COMPONENT 1 (RGB) mode

On-screen display

©-42

InfoIndicates safeguards when using the projector.

NoteIndicates additional information for setting up and operating the projector.

For Future Reference

Maintenance

Troubleshooting

Index

➔ Page 55

➔ Pages 64 and 65

➔ Page 68

Contents

Preparing

Introduction

How to Read this Operation Manual	3
Contents	4
How to Access the PDF Operation Manuals ...	6
IMPORTANT SAFEGUARDS	7
Accessories	10
Part Names and Functions	12
Using the Remote Control	15
Usable Range	15
Inserting the Batteries	15

Quick Start

Quick Start	16
-------------------	----

Setup

Setting Up the Projector	18
Setting Up the Projector	18
Projection (PRJ) Mode	19
Storing the Projector	20
How to Use the Storage Case	20

Connections

Samples of Cables for Connection	21
Connecting to a Computer	23
Connecting to Video Equipment	25
Controlling the Projector by a Computer ...	27
Connecting to a Monitor with RGB	
Input Terminal	28
Connecting to an Amplifier or Other	
Audio Equipment	29

Using

Basic Operation

Turning the Projector On/Off	30
Connecting the Power Cord	30
Turning the Projector On	30
Turning the Power Off (Putting the Projector into Standby Mode)	30
Image Projection	31
Using the Adjustment Feet	31
Correcting Trapezoidal Distortion	32
Adjusting the Lens	33
Switching the INPUT Mode	34
Adjusting the Volume	35
Displaying the Black Screen and Turning Off the Sound Temporarily	35
Displaying an Enlarged Portion of an Image	35
Freezing an Image	35
Displaying and Setting the Break Timer	36

Switching the Eco+Quiet Mode	36
Selecting the Picture Mode	36
Resize Mode	37
Using the Remote Control as the Wireless Computer Mouse	39

Useful Features

Menu Items	40
Using the Menu Screen	42
Menu Selections	42
Picture Adjustment (“Picture” menu)	44
Selecting the Picture Mode	44
Adjusting the Image	44
Adjusting the Color Temperature	45
Selecting the Progressive Mode	45
Signal Type Setting	45
Selecting the Dynamic Range	45
Setting the Video System	45
Computer Image Adjustment (“Fine Sync” menu)	46
Adjusting the Computer Image	46
Resolution Setting	46
Auto Sync Adjustment	46
Checking the Input Signal	46
Using the “Options1” Menu	47
Checking the Lamp Life Status	47
Setting the Resize Mode	47
Adjusting the Image Position	47
Keystone Correction	48
Setting On-screen Display	48
Selecting a Startup and Background Image	48
Eco+Quiet Mode Setting	48
Auto Power Off Function	48
Setting the System Sound	49
Selecting the Menu Screen Position	49
System Lock Function	49
Keylock Function	50
Auto Restart Function	50
Helpful Functions Set during Installation (“Options2” menu)	51
Setting a Password	51
If You Forget Your Password	51
Speaker Setting	52
Audio Output Type Setting	52
Reversing/Inverting Projected Images	52
Fan Mode Setting	52
Monitor Output	52
LAN/RS232C	52
Selecting the Transmission Speed (RS-232C)	52
DHCP Client Setting	53
TCP/IP Setting	53
Confirming the Network Information for the Projector	54
Returning to the Default Settings	54
Selecting the On-screen Display Language	54

Reference

Appendix

Maintenance	55
Replacing the Air Filter	56
Replacing the Air Filter	56
Maintenance Indicators	58
Regarding the Lamp	60
Lamp	60
Caution Concerning the Lamp	60
Replacing the Lamp	60
Removing and Installing the Lamp Unit	61
Resetting the Lamp Timer	62
Computer Compatibility Chart	63
Troubleshooting	64
For SHARP Assistance	66
Specifications	67
Index	68

SETUP MANUAL

Refer to the “SETUP MANUAL” contained on the supplied CD-ROM for details.

Setting up the Screen	2
Screen Size and Projection Distance	3
Changing the Lens	9
Connecting Pin Assignments	11
RS-232C Specifications and Commands ...	13
Setting up the Projector Network	
Environment	18
Controlling the Projector via LAN	24
Setting up the Projector Using	
RS-232C or Telnet	29
Resetting the Lamp Timer	
of the Projector via LAN	39
Troubleshooting	41
Dimensions	44

How to Access the PDF Operation Manuals

PDF operation manuals in several languages are included in the CD-ROM, so that you can work with the projector. To utilize these manuals, you need to install Adobe® Reader® on your computer (Windows® or Macintosh®).

Please download Adobe® Reader® from the Internet (<http://www.adobe.com>).

Accessing the PDF Manuals

For Windows®:

- ① Insert the CD-ROM in the CD-ROM drive.
 - ② Double click the “My Computer” icon.
 - ③ Double click the “CD-ROM” drive.
 - ④ **When you want to view the operation manual**
 - 1) Double click the “MANUALS” folder.
 - 2) Double click the language (name of the folder) that you want to view.
 - 3) Double click the pdf file to access the projector manuals.
- When you want to view the setup manual**
- 1) Double click the “SETUP” folder.
 - 2) Double click the language (name of the folder) that you want to view.
 - 3) Double click the pdf file to access the setup manual.

For Macintosh®:

- ① Insert the CD-ROM in the CD-ROM drive.
 - ② Double click the “CD-ROM” icon.
 - ③ **When you want to view the operation manual**
 - 1) Double click the “MANUALS” folder.
 - 2) Double click the language (name of the folder) that you want to view.
 - 3) Double click the pdf file to access the projector manuals.
- When you want to view the setup manual**
- 1) Double click the “SETUP” folder.
 - 2) Double click the language (name of the folder) that you want to view.
 - 3) Double click the pdf file to access the setup manual.

Info

- If the desired pdf file cannot be opened by double clicking the mouse, start Adobe® Reader® first, then specify the desired file using the “File”, “Open” menu.

IMPORTANT SAFEGUARDS

CAUTION: Please read all of these instructions before you operate this product and save these instructions for later use.

Electrical energy can perform many useful functions. This product has been engineered and manufactured to assure your personal safety. BUT IMPROPER USE CAN RESULT IN POTENTIAL ELECTRICAL SHOCK OR FIRE HAZARDS. In order not to defeat the safeguards incorporated in this product, observe the following basic rules for its installation, use and servicing.

1. Read Instructions

All the safety and operating instructions should be read before the product is operated.

2. Retain Instructions

The safety and operating instructions should be retained for future reference.

3. Heed Warnings

All warnings on the product and in the operating instructions should be adhered to.

4. Follow Instructions

All operating and use instructions should be followed.

5. Cleaning

Unplug this product from the wall outlet before cleaning. Do not use liquid cleaners or aerosol cleaners. Use a damp cloth for cleaning.

6. Attachments

Do not use attachments not recommended by the product manufacturer as they may cause hazards.

7. Water and Moisture

Do not use this product near water—for example, near a bath tub, wash bowl, kitchen sink, or laundry tub; in a wet basement; or near a swimming pool; and the like.

8. Accessories

Do not place this product on an unstable cart, stand, tripod, bracket, or table. The product may fall, causing serious injury to a child or adult, and serious damage to the product. Use only with a cart, stand, tripod, bracket, or table recommended by the manufacturer, or sold with the product. Any mounting of the product should follow the manufacturer's instructions, and should use a mounting accessory recommended by the manufacturer.

9. Transportation

A product and cart combination should be moved with care. Quick stops, excessive force, and uneven surfaces may cause the product and cart combination to overturn.



10. Ventilation

Slots and openings in the cabinet are provided for ventilation to ensure reliable operation of the product and to protect it from overheating, and these openings must not be blocked or covered. The openings should never be blocked by placing the product on a bed, sofa, rug, or other similar surface. This product should not be placed in a built-in installation such as a bookcase or rack unless proper ventilation is provided or the manufacturer's instructions have been adhered to.

11. Power Sources

This product should be operated only from the type of power source indicated on the marking label. If you are not sure of the type of power supply to your home, consult your product dealer or local power company. For products intended to operate from battery power, or other sources, refer to the operating instructions.

12. Grounding or Polarization

This product is provided with one of the following types of plugs. If the plug should fail to fit into the power outlet, please contact your electrician.

Do not defeat the safety purpose of the plug.

- Two-wire type (mains) plug.
- Three-wire grounding type (mains) plug with a grounding terminal.
This plug will only fit into a grounding type power outlet.

13. Power-Cord Protection

Power-supply cords should be routed so that they are not likely to be walked on or pinched by items placed upon or against them, paying particular attention to cords at plugs, convenience receptacles, and the point where they exit from the product.

14. Lightning

For added protection for this product during a lightning storm, or when it is left unattended and unused for long periods of time, unplug it from the wall outlet and disconnect the cable system. This will prevent damage to the product due to lightning and power-line surges.

15. Overloading

Do not overload wall outlets, extension cords, or integral convenience receptacles as this can result in a risk of fire or electric shock.

16. Object and Liquid Entry

Never push objects of any kind into this product through openings as they may touch dangerous voltage points or short-out parts that could result in a fire or electric shock. Never spill liquid of any kind on the product.

17. Servicing

Do not attempt to service this product yourself as opening or removing covers may expose you to dangerous voltage or other hazards. Refer all servicing to qualified service personnel.

18. Damage Requiring Service

Unplug this product from the wall outlet and refer servicing to qualified service personnel under the following conditions:

- When the power-supply cord or plug is damaged.
- If liquid has been spilled, or objects have fallen into the product.
- If the product has been exposed to rain or water.
- If the product does not operate normally by following the operating instructions. Adjust only those controls that are covered by the operating instructions, as an improper adjustment of other controls may result in damage and will often require extensive work by a qualified technician to restore the product to normal operation.
- If the product has been dropped or damaged in any way.
- When the product exhibits a distinct change in performance, this indicates a need for service.

19. Replacement Parts

When replacement parts are required, ensure that the service technician has used replacement parts specified by the manufacturer or have the same characteristics as the original part. Unauthorized substitutions may result in fire, electric shock, or other hazards.

20. Safety Check

Upon completion of any service or repairs to this product, ask the service technician to perform safety checks to determine that the product is in proper operating condition.

21. Wall or Ceiling Mounting

This product should be mounted to a wall or ceiling only as recommended by the manufacturer.

22. Heat

This product should be situated away from heat sources such as radiators, heat registers, stoves, or other products (including amplifiers) that produce heat.

Ensure that you read the following safeguards when setting up your projector.

Caution concerning the lamp unit

- Potential hazard of glass particles if lamp ruptures. In case of lamp rupture, contact your nearest Sharp Authorized Projector Dealer or Service Center for replacement. See “Replacing the Lamp” on page 60.



Caution concerning the setup of the projector

- For minimal servicing and to maintain high image quality, SHARP recommends that this projector be installed in an area free from humidity, dust and cigarette smoke. When the projector is subjected to these environments, the vents and lens must be cleaned more often. As long as the projector is regularly cleaned, use in these environments will not reduce the overall operation life of the unit. Internal cleaning should only be performed by a Sharp Authorized Projector Dealer or Service Center.

Do not set up the projector in places exposed to direct sunlight or bright light.

- Position the screen so that it is not in direct sunlight or room light. Light falling directly on the screen washes out the colors, making viewing difficult. Close the curtains and dim the lights when setting up the screen in a sunny or bright room.

The projector may be safely tilted to a maximum angle of 9 degrees.

- Placement should be within ± 9 degrees of horizontal.

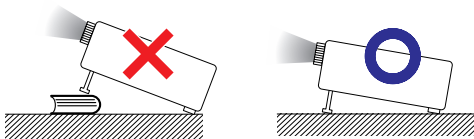

When using the projector in high-altitude areas such as mountains (at altitudes of approximately 1,500 meters (4,900 feet) or more)

- When you use the projector in high-altitude areas with thin air, set “Fan Mode” to “High”. Neglecting this can affect the longevity of the optical system.

Warning about placing the projector in a high position

- When placing the projector in a high position, make certain it is carefully secured to avoid personal injury caused by the projector falling down.

Do not subject the projector to hard impact and/or vibration.

- Take care with the lens so as not to hit or damage the surface of the lens.

Rest your eyes occasionally.

- Continuously watching the screen for long hours will cause eye strain. Take regular breaks to rest your eyes.

Avoid locations with extremes of temperature.

- The operating temperature of the projector is from 41°F to 95°F (+5°C to +35°C).
- The storage temperature of the projector is from -4°F to 140°F (-20°C to +60°C).

Do not block the intake and exhaust vents.

- Allow at least 7 ⁷/₈ inches (20 cm) of space between the exhaust vent and the nearest wall or obstruction.
- Ensure that the intake vent and the exhaust vent are not obstructed.
- If the cooling fan becomes obstructed, a protection circuit will automatically put the projector into standby mode to prevent overheating damage. This does not indicate a malfunction (see pages 58 and 59). Remove the projector power cord from the wall outlet and wait at least 10 minutes. Place the projector where the intake and exhaust vents are not blocked, plug the power cord back in and turn on the projector. This will return the projector to the normal operating condition.

Caution regarding usage of the projector

- When using the projector, take care not to subject it to hard impact and/or vibration, as this can result in damage. Take extra care with the lens. If you are not to use the projector for a long time, make certain you unplug the power cord from the wall outlet, and disconnect any other cables connected to it.
- Do not carry the projector by holding the lens.
- When storing the projector, ensure you attach the lens cap to the projector. (See page 12.)
- Do not expose the storage case or projector to direct sunlight or near heat sources. The storage case or projector may change color or become deformed.

Other connected equipment

- When connecting a computer or other audio-visual equipment to the projector, make the connections AFTER unplugging the power cord of the projector from the AC outlet and turning off the equipment to be connected.
- Please read the operation manuals of the projector and the equipment to be connected for instructions on how to make the connections.

Using the projector in other countries

- The power supply voltage and the shape of the plug may vary depending on the region or country you are using the projector in. When using the projector overseas, make sure you use an appropriate power cord for the country you are in.

Temperature monitor function

- If the projector starts to over-heat due to setup problems or blockage of the air vents, “” and “TEMP.” will illuminate in the lower left corner of the picture. If the temperature continues to rise, the lamp will turn off, the temperature warning indicator on the projector will blink, and after a 90-second cooling-off period the projector will enter the standby mode. Refer to “Maintenance Indicators” on page 58 for details.



Info

- The cooling fan regulates the internal temperature, and its performance is automatically controlled. The sound of the fan may change during projector operation due to changes in the fan speed. This does not indicate malfunction.
- Even if you unplug the power cord after projector operation, the cooling fan continues to run for a while. When you place the projector into the storage case, make sure that the cooling fan has stopped.

Accessories

Supplied accessories



Remote control
<RRMCGA623WJSA>



Two R-6 batteries
("AA" size, UM/SUM-3,
HP-7 or similar)

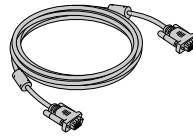

RGB cable
(10' (3.0 m))
<QCNWGA045WJPZ>

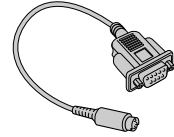

DIN-D-sub RS-232C
adaptor
(5 ⁵⁷/₆₄" (15 cm))
<QCNWGA091WJPZ>

Power cord*
(1)

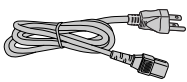

For U.S., Canada, etc.
(6' (1.8 m))
<QACCDAA007WJPZ>

(2)

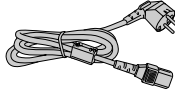

For Europe, except U.K.
(6' (1.8 m))
<QACCVA011WJPZ>

(3)

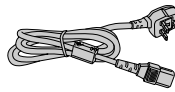

For U.K., Hong Kong
and Singapore
(6' (1.8 m))
<QACCBAA036WJPZ>

(4)

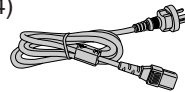

For Australia, New
Zealand and Oceania
(6' (1.8 m))
<QACCLA018WJPZ>

* Use the power cord that corresponds to the wall outlet in your country.

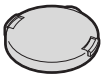

Lens cap (attached)
<PCAPHA026WJSA>



Lens cap strap
<UBNDTA017WJZZ>



Storage case
<GCASNA020WJSA>

• Operation manual (this manual <TINS-D310WJZZ> and CD-ROM <UDSKAA092WJZZ>)

Note

• Codes in "< >" are Replacement parts codes.

Optional accessories

- | | |
|---|--|
| ■ 3 RCA to 15-pin D-sub cable (10' (3.0 m)) | AN-C3CP2 |
| ■ Remote receiver | AN-MR2 |
| ■ Lamp unit | AN-C430LP |
| ■ Ceiling-mount adaptor | AN-60KT |
| | AN-XGCM55 (for U.S.A. only) |
| ■ Universal bracket | AN-JT200 (for U.S.A. only) |
| ■ Ceiling-mount unit | AN-TK201 <for AN-60KT> |
| | AN-TK202 <for AN-60KT> |
| | AN-EP101B <for AN-XGCM55 and AN-JT200> |
| | (for U.S.A. only) |

Note

• Some of the optional accessories may not be available depending on the region. Please check with your nearest Sharp Authorized Projector Dealer or Service Center.

Optional lenses

■ Lens		Projection distance for 100" screen size
Wide-zoom lens (× 1.5 – 1.9)	AN-C12MZ	9'11" – 12'5" (3.0 m – 3.8 m)
Tele-zoom lens (× 2.2 – 2.8)	AN-C18MZ	14'10" – 18'10" (4.5 m – 5.7 m)
Tele-zoom lens (× 3.3 – 5.1)	AN-C27MZ	22' – 33'11" (6.7 m – 10.3 m)
Tele-zoom lens (× 5.2 – 7.2)	AN-C41MZ	34'5" – 48'4" (10.5 m – 14.7 m)

The standard zoom lens is attached to the projector.

The optional lenses from Sharp are also available for specialized application. Please see your nearest Sharp Authorized Projector Dealer for details on all the lenses. (Refer to the **SETUP MANUAL** on the supplied CD-ROM for details.) Also, be sure to have service personnel install the optional lenses.

Throw Distance

The graph below is for 100 inches (254 cm) screen with 4:3 normal mode.

Screen

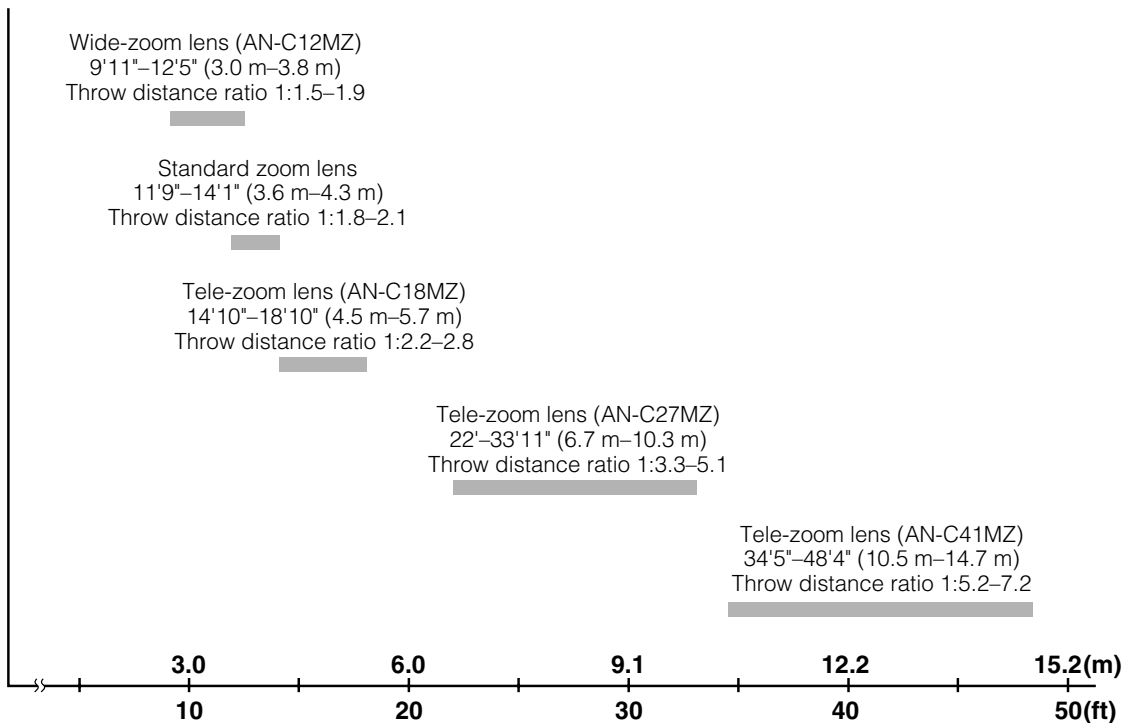

Part Names and Functions

Numbers in refer to the main pages in this operation manual where the topic is explained.

Projector

Top View

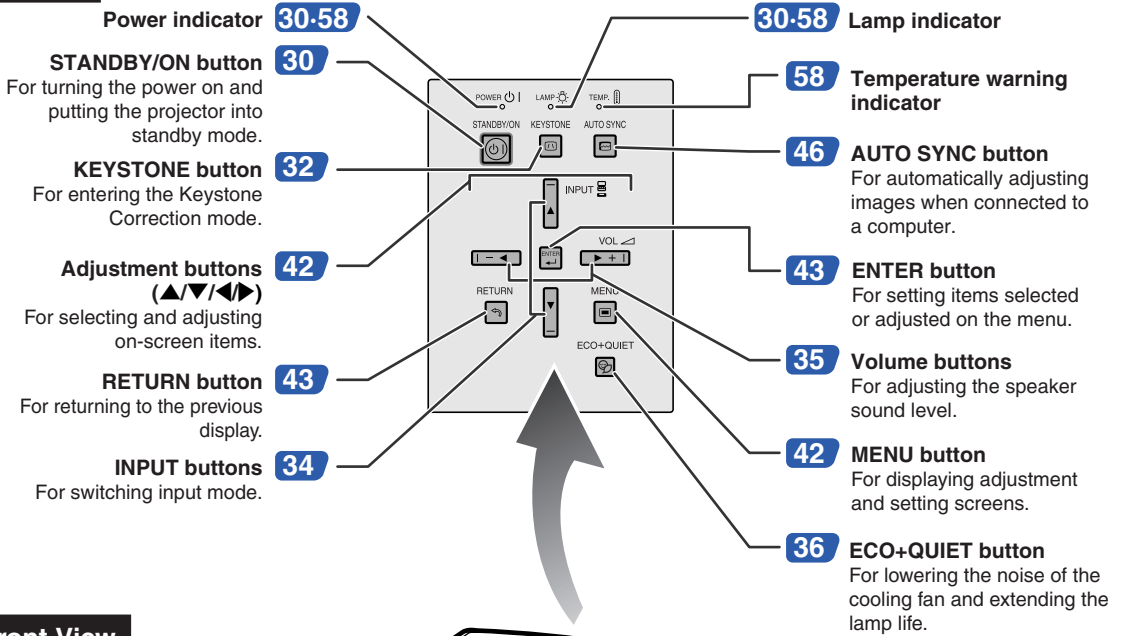

Front View

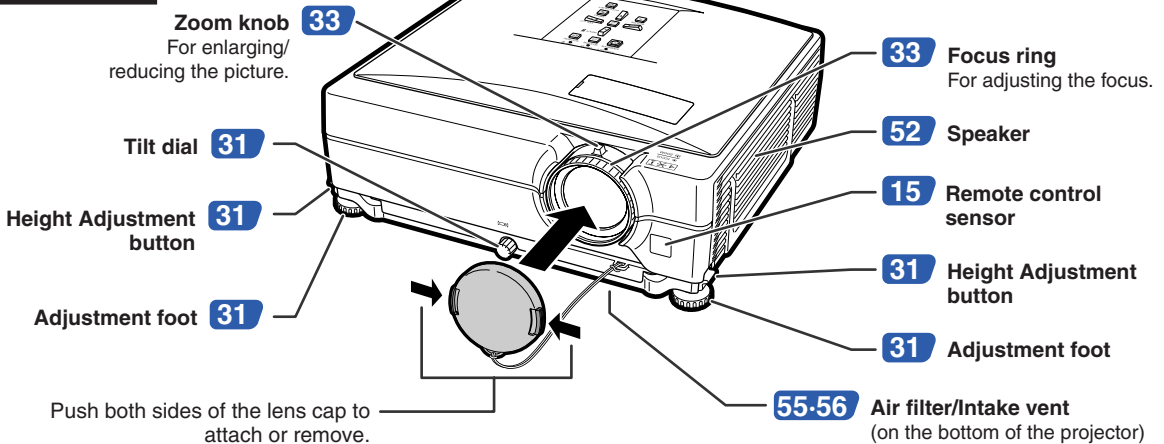

Attaching the lens cap

After putting the lens cap strap on the lens cap, pass the other end of the strap through the hole on the front side of the projector, next to the lens, as shown in the illustration.

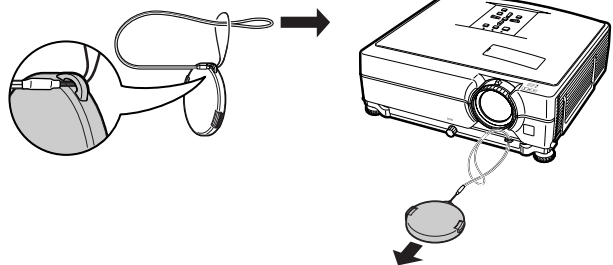

Projector (Rear View)

Terminals

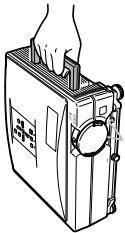
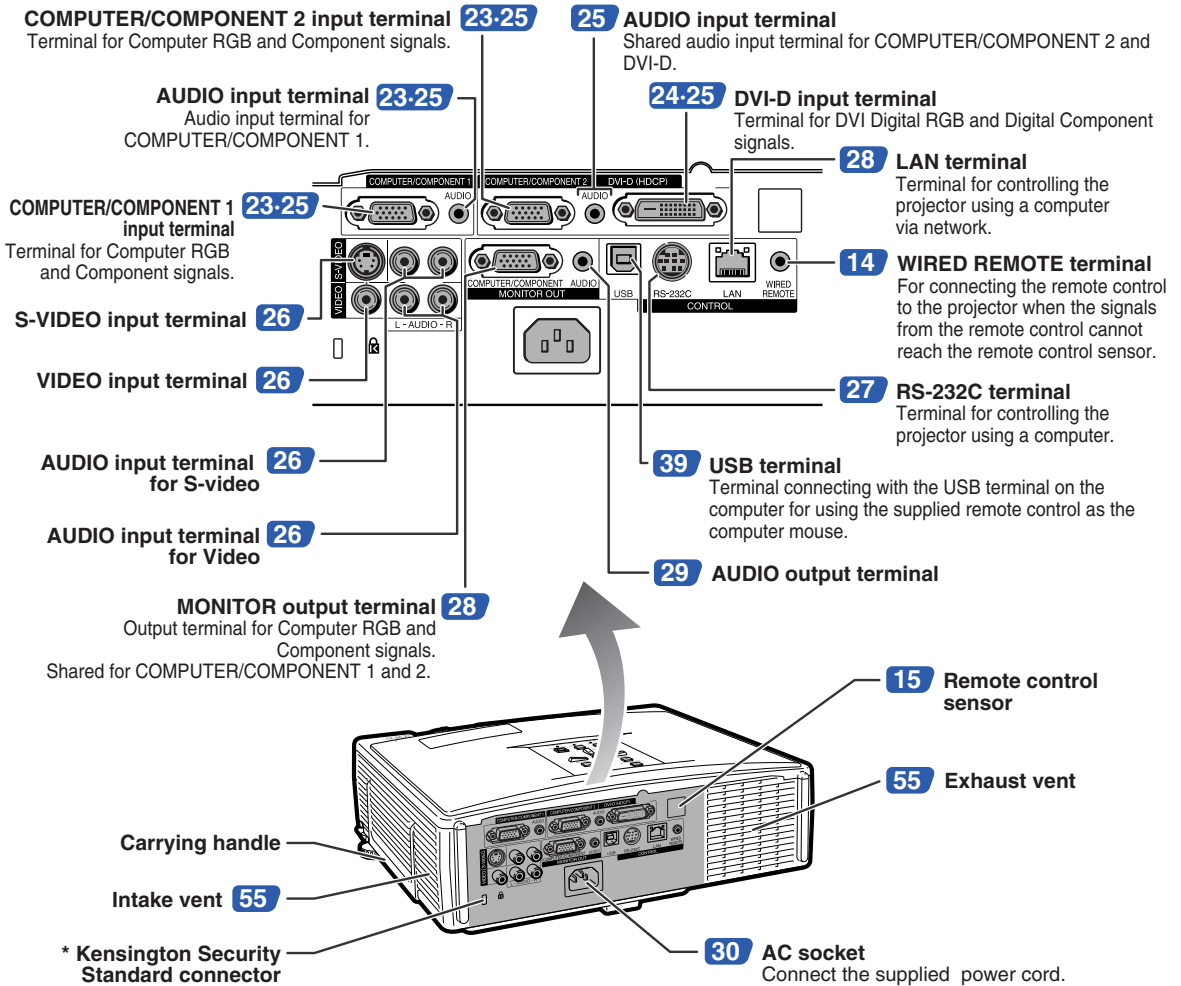

Using the Carrying Handle

When transporting the projector, carry it by the carrying handle on the side.

- Always put on the lens cap to prevent damage to the lens when transporting the projector.
- Do not lift or carry the projector by the lens or the lens cap as this may damage the lens.

* Using the Kensington Lock

- This projector has a Kensington Security Standard connector for use with a Kensington MicroSaver Security System. Refer to the information that came with the system for instructions on how to use it to secure the projector.

Remote Control

STANDBY button 30
For putting the projector into standby mode.

KEYSTONE button 32
For entering the Keystone Correction mode.

ENTER button 43
For setting items selected or adjusted on the menu.

L-CLICK button 39
For the Left click when with the USB connection (using a USB cable or the optional remote receiver).

MAGNIFY (Enlarge/Reduce) buttons 35
For enlarging/reducing part of the image.

PAGE Up/Down buttons 39
Same as the [Page Down] and [Page Up] keys on a computer keyboard, when with the USB connection (using a USB cable or the optional remote receiver).

BREAK TIMER button 36
For displaying the break timer.

AUTO SYNC button 46
For automatically adjusting images when connected to a computer.

PICTURE MODE button 36
For switching the picture mode.

INPUT buttons 34
For switching to the respective input modes.

WIRED R/C JACK
For controlling the projector by connecting the remote control to the projector.

30 ON button
For turning the power on.

42 MENU button
For displaying adjustment and setting screens.

39-42 MOUSE/Adjustment buttons (▲/▼/◀/▶)

- For moving the computer cursor when with the USB connection (using a USB cable or the optional remote receiver).
- For selecting and adjusting on-screen items.

39-43 R-CLICK/RETURN button

- For the Right click when with the USB connection (using a USB cable or the optional remote receiver).
- For returning to the previous display.

35 Volume buttons
For adjusting the speaker sound level.

35 AV MUTE button
For temporarily displaying the black screen and turning off the sound.

35 FREEZE button
For freezing images.

37 RESIZE button
For switching the screen size (NORMAL, BORDER, etc.).

36 ECO+QUIET button
For lowering the noise of the cooling fan and extending the lamp life.

Using the Remote Control with a Signal Cable

When the signals from the remote control cannot be reached due to the positioning of the projector, use a $\varnothing 3.5$ mm minijack cable to connect the remote control to the projector. Now you can control the projector with the remote control.

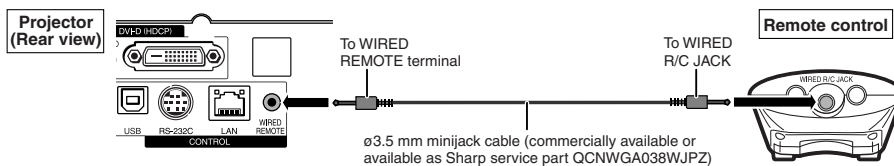

Note

- The wireless remote function is not possible when the $\varnothing 3.5$ mm minijack cable is connected to the projector. Should the wireless remote operation be required, the $\varnothing 3.5$ mm minijack cable should be disconnected from the projector.

Using the Remote Control

Usable Range

The remote control can be used to control the projector within the ranges shown in the illustration.

Note

- The signal from the remote control can be reflected off a screen for easy operation. However, the effective distance of the signal may differ depending on the screen material.

When using the remote control:

- Take care not to drop, expose to moisture or high temperature.
- The remote control may malfunction under a fluorescent lamp. In this case, move the projector away from the fluorescent lamp.

Front View

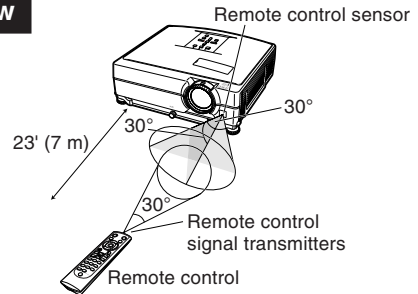

Rear View

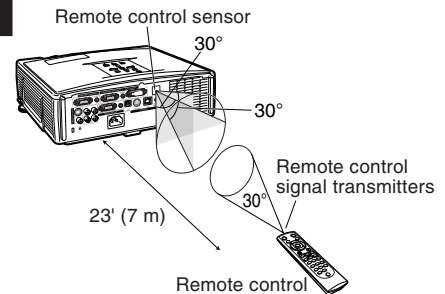

Inserting the Batteries

1 Pull down the tab on the cover and remove the cover towards the direction of the arrow.

2 Insert the included batteries.
• Insert the batteries making sure the polarities correctly match the \oplus and \ominus marks inside the battery compartment.

3 Insert the lower tab of the cover into the opening, and lower the cover until it clicks in place.

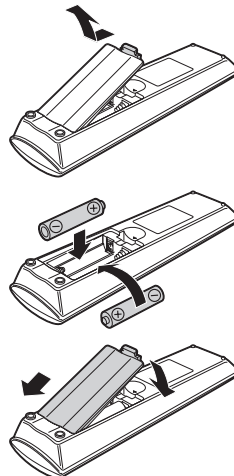

Incorrect use of the batteries may cause them to leak or explode. Please follow the precautions below.

⚠ Caution

- Danger of explosion if battery is incorrectly replaced. Replace only with alkaline or manganese batteries.
- Insert the batteries making sure the polarities correctly match the \oplus and \ominus marks inside the battery compartment.
- Batteries of different types have different properties, therefore do not mix batteries of different types.
- Do not mix new and old batteries.
This may shorten the life of new batteries or may cause old batteries to leak.
- Remove the batteries from the remote control once they have run out, as leaving them in can cause them to leak. Battery fluid from leaked batteries is harmful to skin, therefore ensure you wipe them first and then remove them using a cloth.
- The batteries included with this projector may run down in a short period, depending on how they are kept. Be sure to replace them as soon as possible with new batteries.
- Remove the batteries from the remote control if you will not be using the remote control for a long time.
- Comply with the rules (ordinance) of each local government when disposing of worn-out batteries.

Quick Start

This section shows the basic operation (projector connecting with the computer). For details, see the page described below for each step.

Setup and Projection

In this section, connection of the projector and the computer is explained using one example.

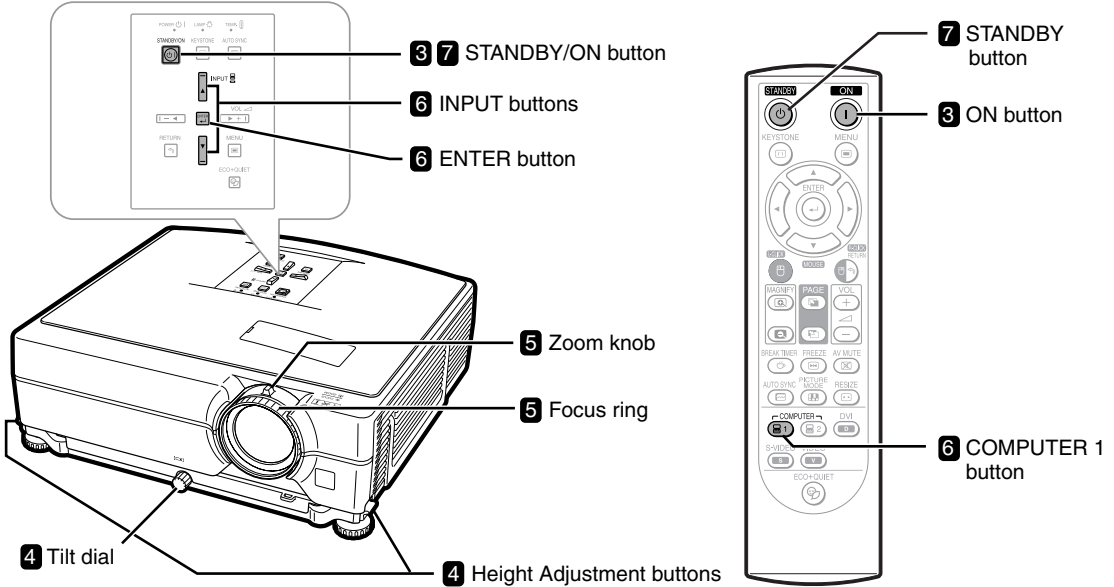

1. Place the projector facing a screen

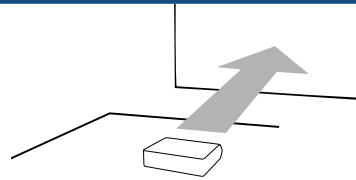

➔ Page 18

2. Connect the projector to the computer and plug the power cord into the AC socket of the projector

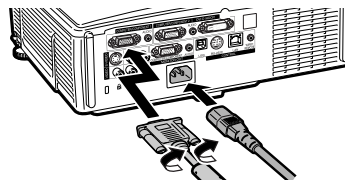

When connecting equipment other than the computer, see pages 25, 28 and 29.

➔ Pages 23, 30

3. Remove the lens cap and turn the projector on

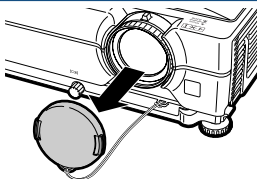

On the projector

STANDBY/ON



On the remote control



➔ Page 30

4. Adjust the angle

Adjust the projector angle

- Adjust the projector angle using the Height Adjustment buttons.
- Rotate the Tilt dial to adjust the horizontal tilt of the projector.

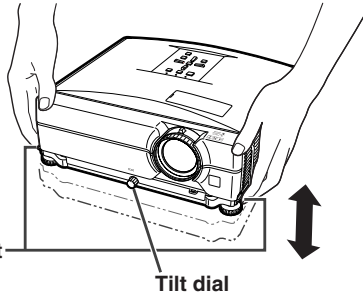

Height Adjustment buttons

Tilt dial

- This projector is equipped with an “Auto Keystone Correction” function that automatically corrects any trapezoidal distortion within the projected image.

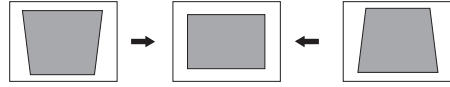

➔ Pages 31, 32

5. Adjust the focus and the zoom

Bring the projected image into focus

- Bring the projected image into focus by rotating the focus ring.

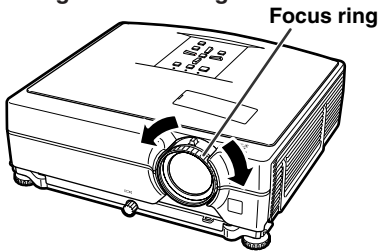

Focus ring

Adjust the projected image size

- Adjust the projected image size by moving the zoom knob.

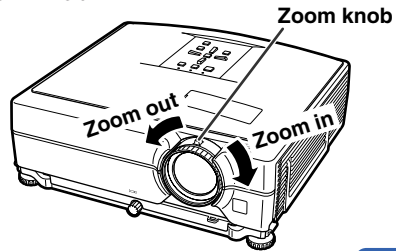

Zoom knob

➔ Page 33

6. Select the INPUT mode

Select the “COMPUTER 1” using the INPUT buttons on the projector or the COMPUTER 1 button on the remote control.

On the projector

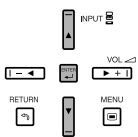

On the remote control



INPUT list

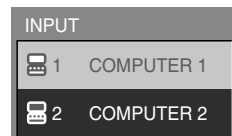

On-screen Display (RGB)



- When you press the INPUT buttons on the projector, the INPUT list appears. Press ▲/▼ to select an item on the list, and press to switch to the selected INPUT mode.
- When using the remote control, press / / / / to switch the INPUT mode.

➔ Page 34

7. Turn the Power off

Press the STANDBY button, then press that button again while the confirmation message is displayed, to put the projector into standby mode.

On the projector



On the remote control



On-screen Display

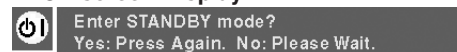

- Even if you unplug the power cord from the AC outlet, the cooling fan continues to run for a while.

➔ Page 30

Setting Up the Projector

Setting Up the Projector

For optimal image quality, position the projector perpendicular to the screen with the projector's feet flat and level. Doing so will eliminate the need for Keystone correction and provide the best image quality. (See page 32.)

Standard Setup (Front Projection)

- Place the projector at the required distance from the screen according to the desired picture size. (For details, refer to the "SETUP MANUAL" contained on the supplied CD-ROM.)

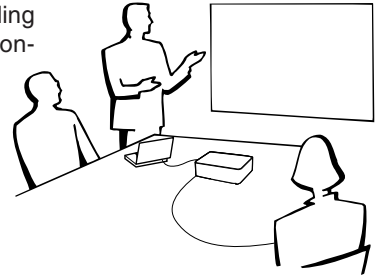

Example of standard setup

Side View

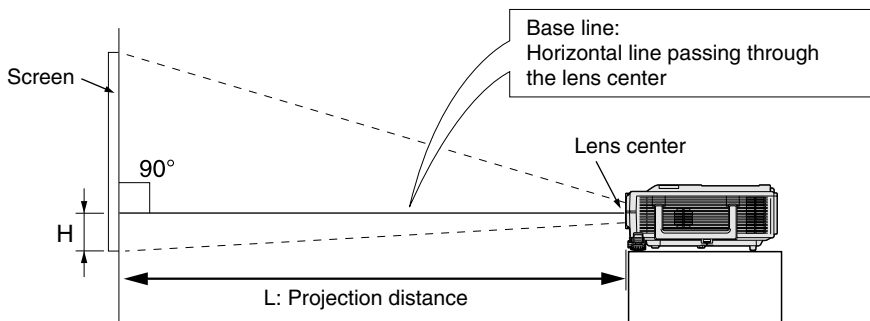

Ceiling-mount Setup

- It is recommended that you use the optional Sharp ceiling-mount adaptor and unit for this installation. Before mounting the projector, contact your nearest Sharp Authorized Projector Dealer or Service Center to obtain the recommended ceiling-mount adaptor and unit (sold separately).

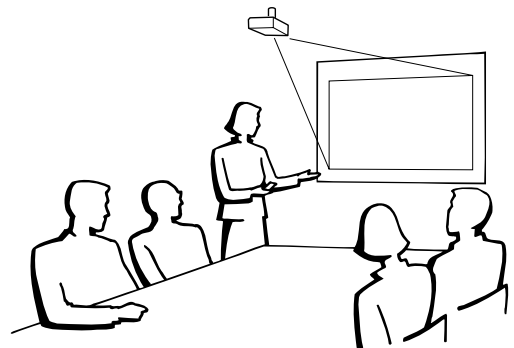

Projection (PRJ) Mode

The projector can use any of the 4 projection modes, shown in the diagram below. Select the mode most appropriate for the projection setting in use. (You can set the PRJ mode in "Options2" menu. See page 52.)

- Table mounted, front projection
[Menu item → "Front"]

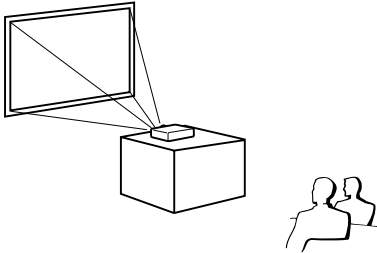

- Ceiling mounted, front projection
[Menu item → "Ceiling + Front"]

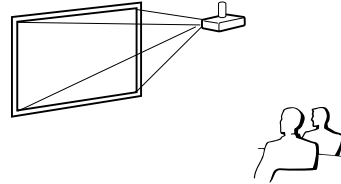

- Table mounted, rear projection
(with a translucent screen)
[Menu item → "Rear"]

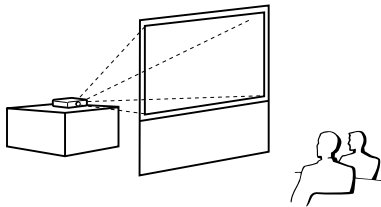

- Ceiling mounted, rear projection
(with a translucent screen)
[Menu item → "Ceiling + Rear"]

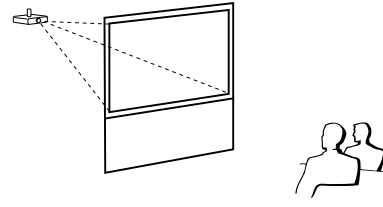

Indication of the Projection Image Size and Projection Distance

For details, refer to the "SETUP MANUAL" contained on the supplied CD-ROM.
Example: NORMAL Mode (4:3) for standard lens

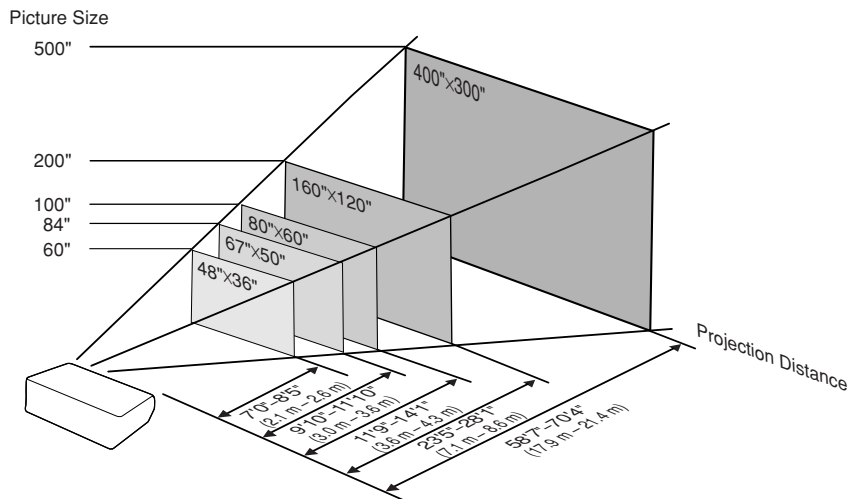

Storing the Projector

How to Use the Storage Case

When storing the projector, attach the lens cap to the lens, and place it in the supplied storage case.

1 Open the cover of the storage case.

2 Place the projector into the storage case.

Info

- Ensure the projector has cooled down sufficiently before placing it in the case.
- Ensure the lens cap is attached to the lens for protection.
- **Place the projector into the storage case with the lens facing the handle.**
- Ensure the projector is held in place by using the fixing band.





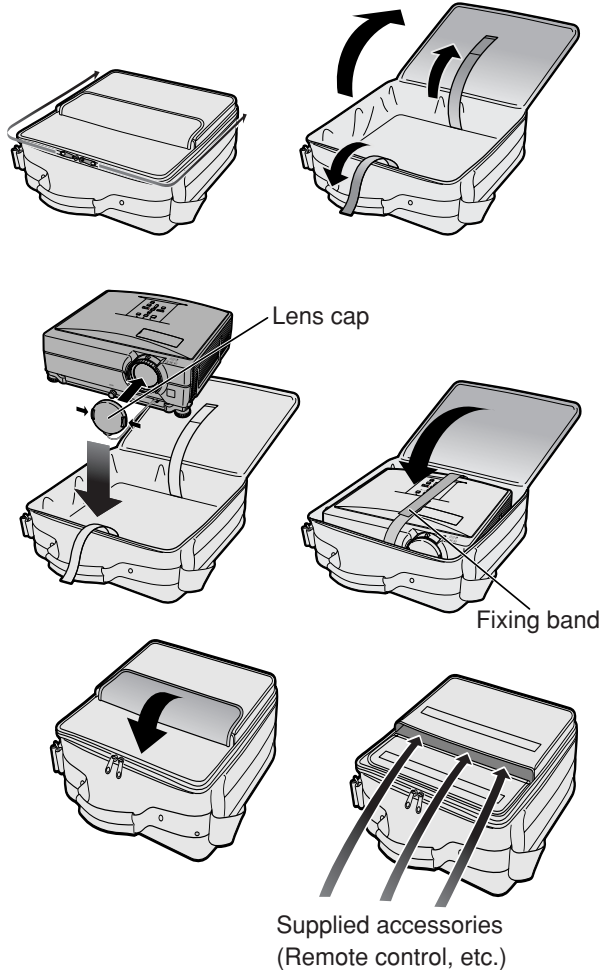





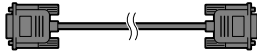
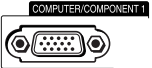
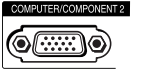
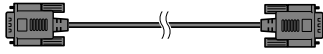
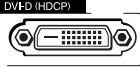
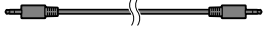

3 Close the cover of the storage case.

4 Place the accessories in the front pocket of the storage case.



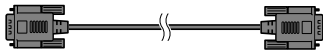
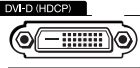
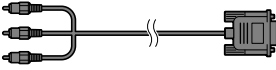
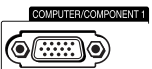
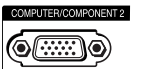
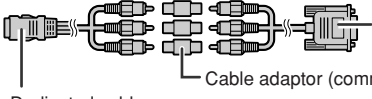
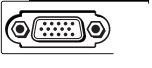
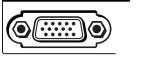
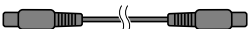

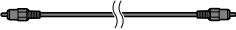



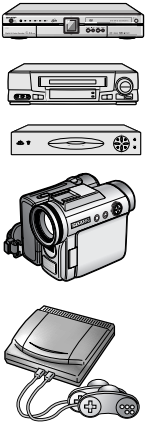
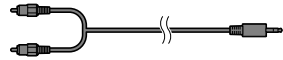
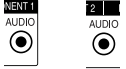
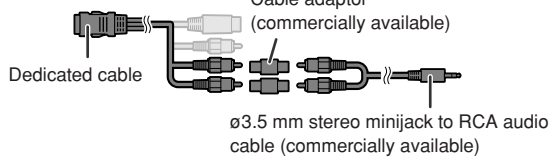
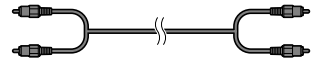

Samples of Cables for Connection

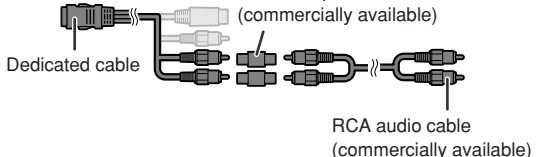
- For more details of connection and cables, refer to the operation manual of the connecting equipment.
- You may need other cables or connectors not listed below.

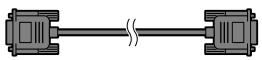
Equipment	Terminal on connected equipment	Cable	Terminal on the projector
	RGB output terminal	RGB cable (supplied) 	COMPUTER/ COMPONENT 1, 2  
	DVI digital video output terminal	DVI Digital cable (commercially available) 	DVI-D 
	Audio output terminal	ø3.5 mm stereo or mono audio cable (commercially available or available as Sharp service part QCNWGA038WJPZ) 	AUDIO (for COMPUTER/ COMPONENT 1, 2, DVI-D)  
Audio-visual equipment     	DVI digital video output terminal	DVI Digital cable (commercially available) 	DVI-D 
	Component video output terminal	3 RCA to 15-pin D-sub cable (optional: AN-C3CP2) 	COMPUTER/ COMPONENT 1, 2  
	Terminal for using the dedicated cable	Connect with the cable adaptor, etc.  3 RCA to 15-pin D-sub cable (optional: AN-C3CP2) Cable adaptor (commercially available) Dedicated cable	COMPUTER/ COMPONENT 1, 2  
	S-video output terminal	S-video cable (commercially available) 	S-VIDEO 
	Video output terminal	Video cable (commercially available) 	VIDEO 

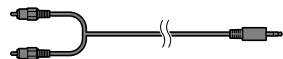
Samples of Cables for Connection

Equipment	Terminal on connected equipment	Cable	Terminal on the projector
Audio-visual equipment 	Audio output terminal	ø3.5 mm stereo minijack to RCA audio cable (commercially available) 	AUDIO (for COMPUTER/ COMPONENT 1, 2, DVI-D) 
	Terminal for using the dedicated cable	Connect with the cable adaptor, etc.  Dedicated cable Cable adaptor (commercially available) ø3.5 mm stereo minijack to RCA audio cable (commercially available)	
	Audio output terminal	RCA audio cable (commercially available) 	AUDIO (for VIDEO, S-VIDEO) 
	Terminal for using the dedicated cable	Connect with the cable adaptor, etc.  Dedicated cable Cable adaptor (commercially available) RCA audio cable (commercially available)	
Monitor 	RGB input terminal	RGB cable (supplied or commercially available) 	MONITOR OUTPUT 
Amplifier 	Audio input terminal	ø3.5 mm stereo minijack to RCA audio cable (commercially available) 	AUDIO (MONITOR OUT) 

Connecting to a Computer

Before connecting, ensure the power cord of the projector from the AC outlet is unplugged, and that the devices to be connected are turned off. After making all connections, turn on the projector and then the other devices. When connecting a computer, ensure that it is the last device to be turned on after all the connections are made.

Ensure the operation manuals of the devices to be connected have been read before making connections.

When connecting with the RGB cable

(Connecting to COMPUTER/COMPONENT 1 or 2: The illustration shown below is for the former.)

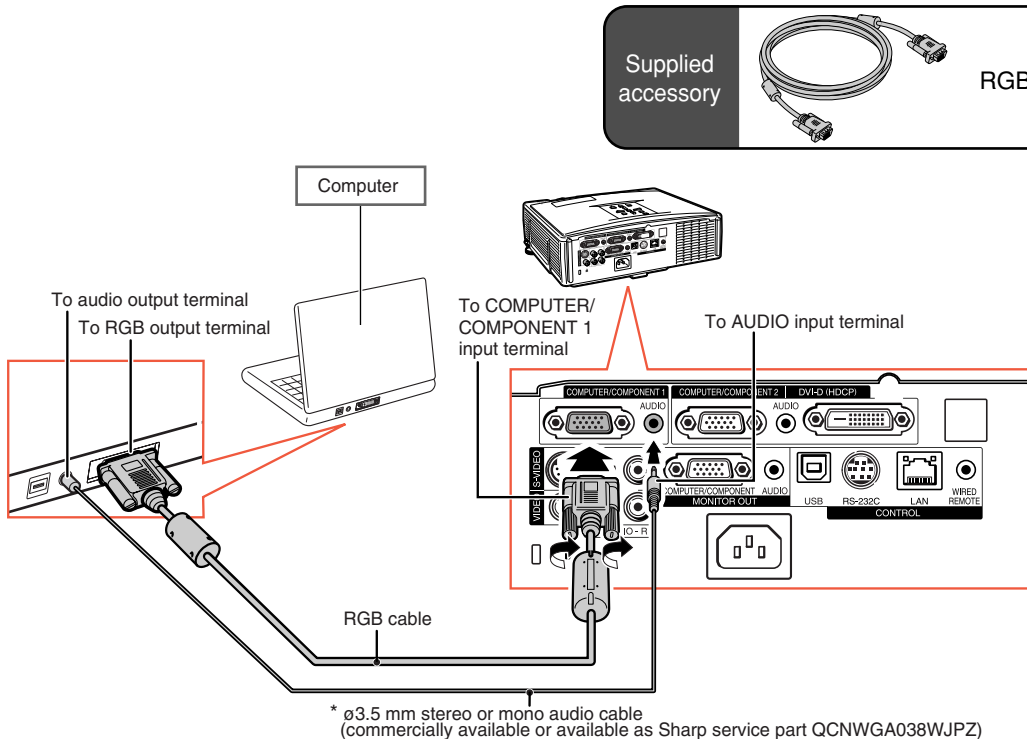

* When using the ø3.5 mm mono audio cable, the volume level will be half of when using the ø3.5 mm stereo audio cable.

Note

- See page 63 "Computer Compatibility Chart" for a list of computer signals compatible with the projector. Use with computer signals other than those listed may cause some of the functions to not work.
- A Macintosh adaptor may be required for use with some Macintosh computers. Contact your nearest Macintosh Dealer.
- Depending on the computer you are using, an image may not be projected unless the computer's external output port is switched on. (e.g. Press "Fn" and "F5" keys simultaneously when using a SHARP notebook computer). Refer to the specific instructions in your computer's operation manual to enable your computer's external output port.

Connecting to a Computer

When connecting with a DVI digital cable

The projector employs the DVI digital input terminal for direct input of Digital Video signals from a computer.

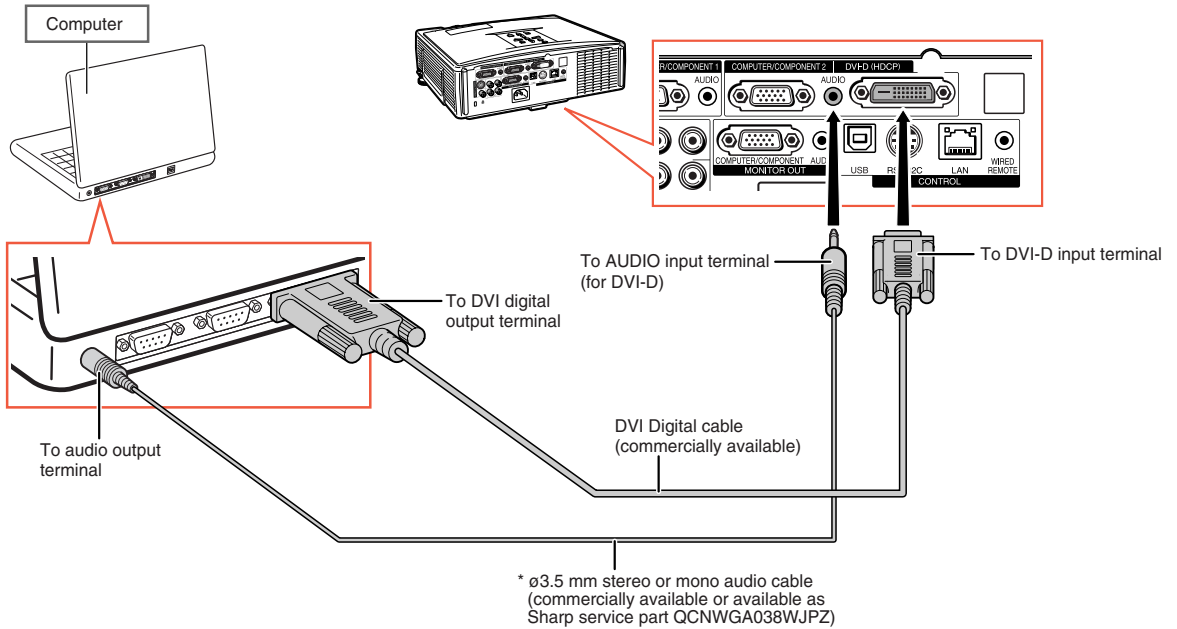

* When using the ø3.5 mm mono audio cable, the volume level will be half of when using the ø3.5 mm stereo audio cable.

Connecting to Video Equipment

The image quality is highest in order of the Component signal, the RGB signal, the S-video signal and the Video signal. If your audio-visual equipment has a component output terminal or RGB output terminal, use the COMPUTER/COMPONENT terminal 1 or 2 on the projector for video connection.

When connecting video equipment with a DVI output terminal

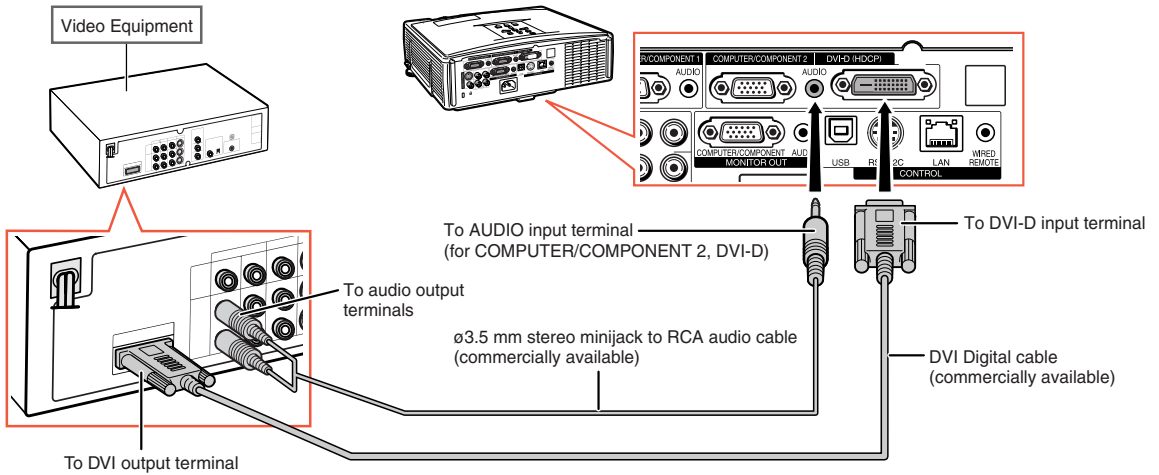

Note

- Select the input signal type of the video equipment. See page 45.

When connecting video equipment with component video output terminal

(Connecting to COMPUTER/COMPONENT 1 or 2: The illustration shown below is for the former.)

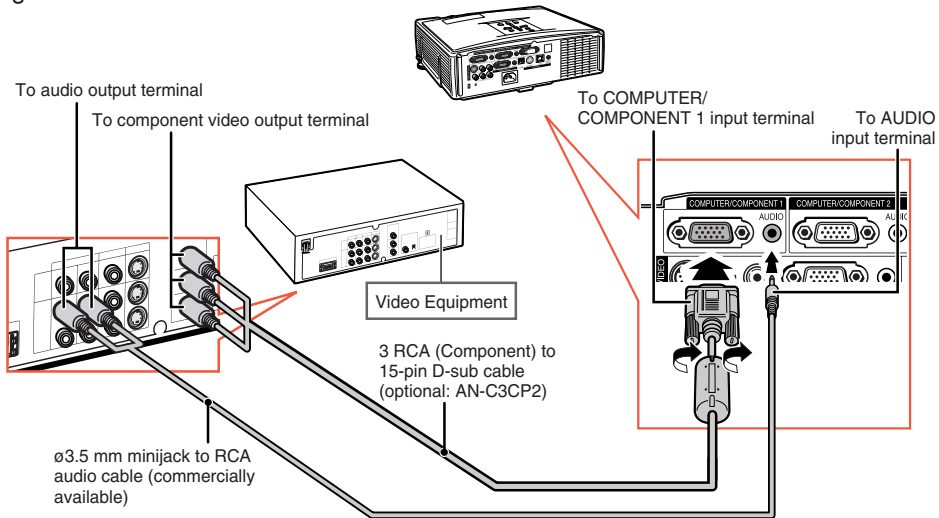

Note

- When you connect video equipment with a 21-pin RGB output (Euro-scart) to the projector, use a commercially available cable that fits in the projector terminal you want to connect.

Connecting to Video Equipment

When connecting video equipment with S-video output terminal

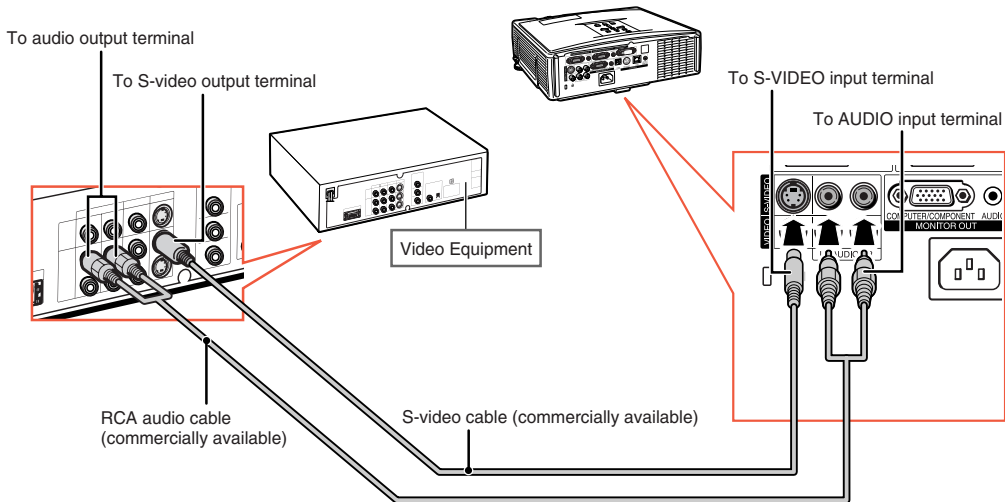

When connecting video equipment with video output terminal

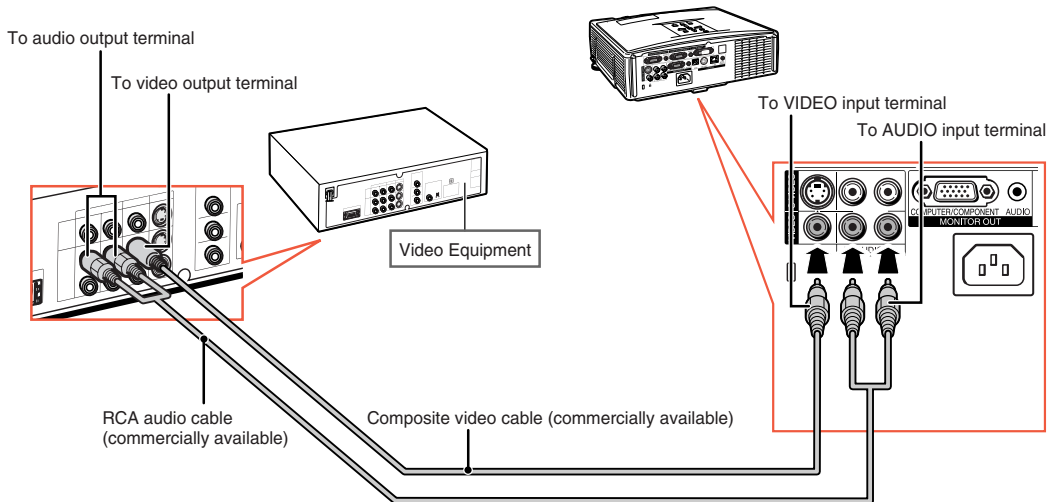

Note

- When you connect video equipment with a 21-pin RGB output (Euro-scart) to the projector, use a commercially available cable that fits in the projector terminal you want to connect.

Controlling the Projector by a Computer

When the RS-232C terminal on the projector is connected to a computer, the computer can be used to control the projector and check the status of the projector. Refer to the "SETUP MANUAL" contained on the supplied CD-ROM for "RS-232C Specifications and Commands".

When connecting to a computer using an RS-232C serial control cable and a DIN-D-sub RS-232C adaptor

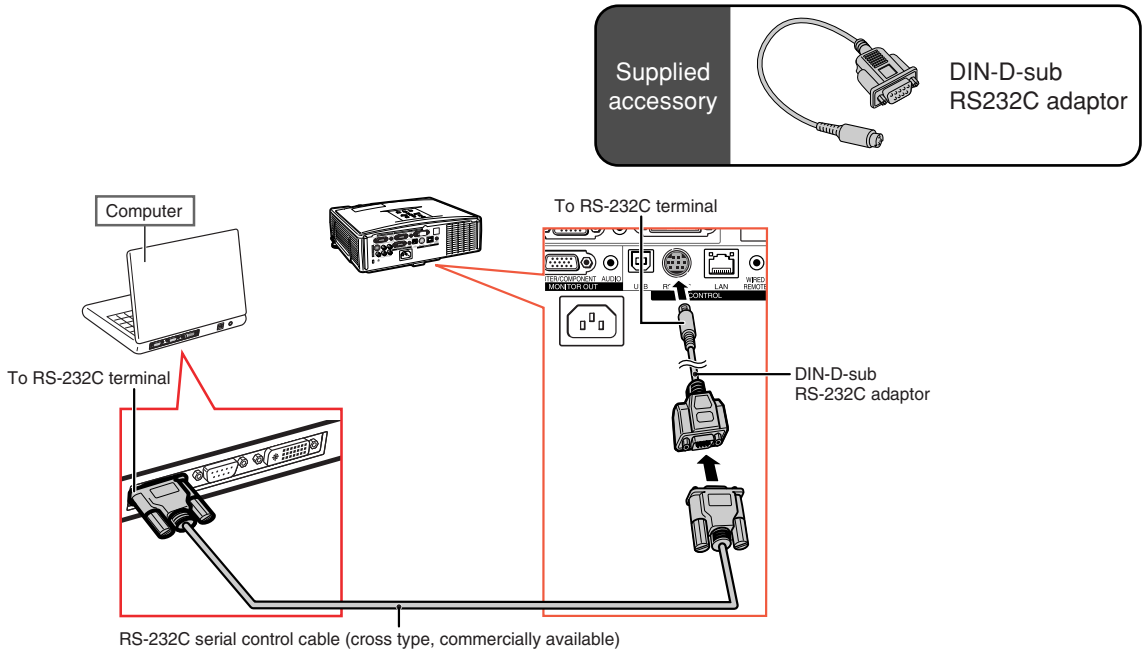

Note

- The RS-232C function may not operate if your computer terminal is not correctly set up. Refer to the operation manual of the computer for details.

Info

- Do not connect the RS-232C cable to a port other than the RS-232C terminal on the computer. This may damage your computer or projector.
- Do not connect or disconnect an RS-232C serial control cable to or from the computer while it is on. This may damage your computer.

Controlling the Projector by a Computer

When connecting to the LAN terminal using a LAN cable

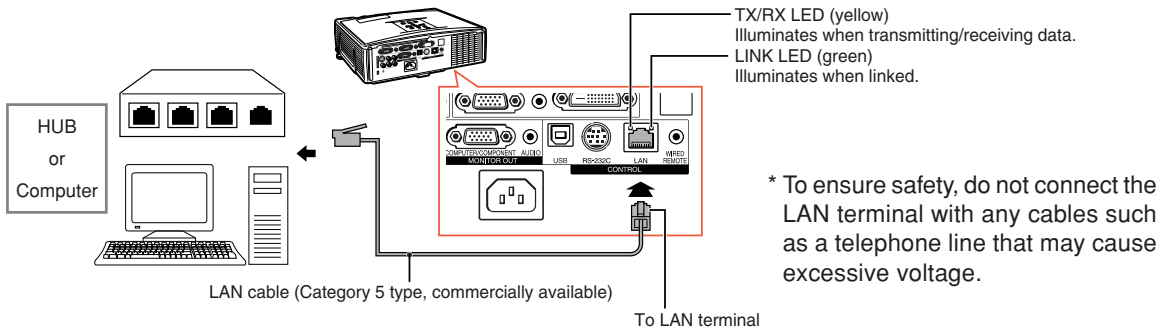

Note

- When connecting to hub, use straight-through Category 5 (CAT.5) type cable (commercially available).
- When connecting to computer, use cross-over Category 5 (CAT.5) type cable (commercially available).

Connecting to a Monitor with RGB Input Terminal

You can display computer images on both the projector and a separate monitor using two sets of RGB cables.

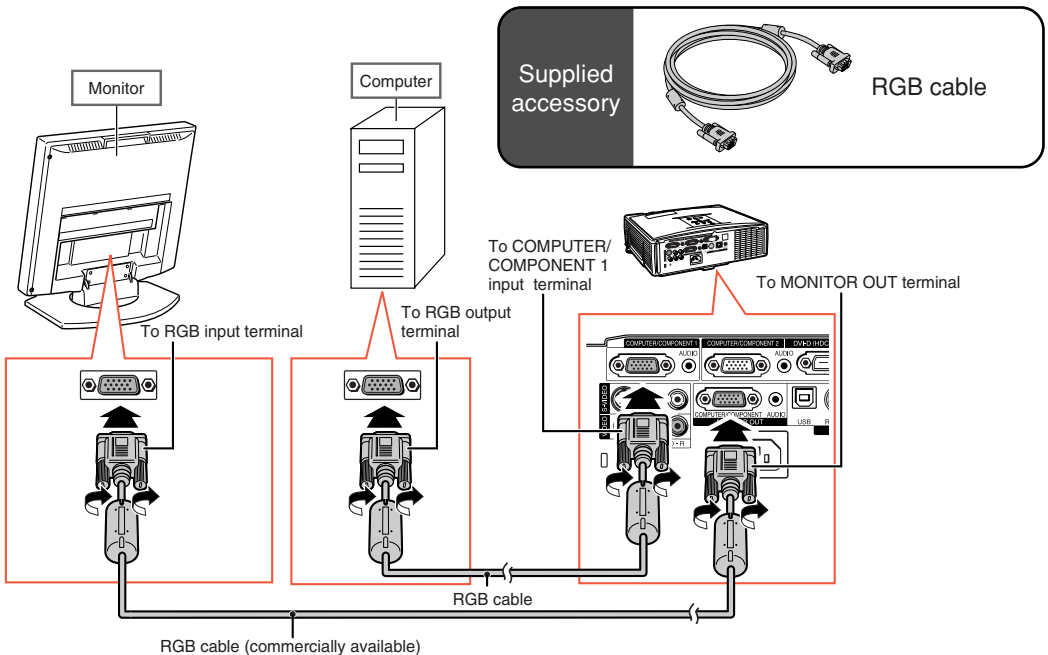

Connecting to an Amplifier or Other Audio Equipment

Audio signals input from equipment connected to each audio input terminal of the projector can be output to audio equipment.

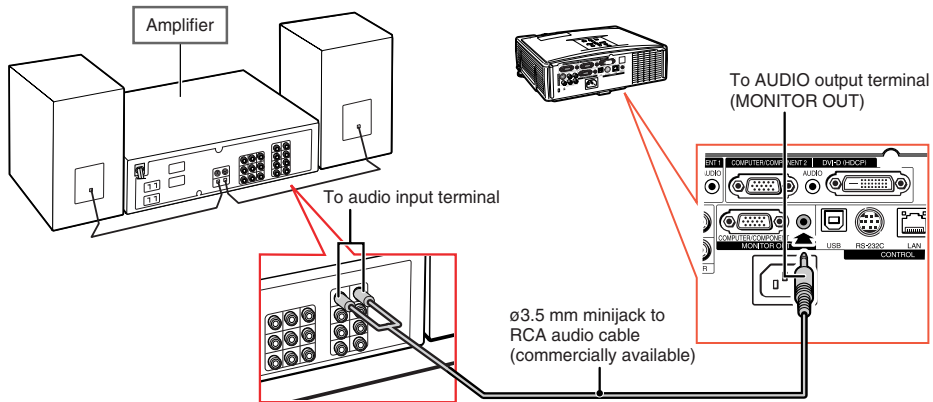

Note

- Turn off the power of both the projector and audio equipment when connecting.
- When turning off the power in the case of connecting an amplifier or other audio equipment, first turn off the power of the amplifier and then turn off the power of the projector.
- By using external audio components, the volume can be amplified for better sound.
- For details on Variable Audio Output (VAO) and Fixed Audio Output (FAO), see page 52.



Turning the Projector On/Off

Connecting the Power Cord

Plug the supplied power cord into the AC socket on the rear of the projector. Then plug into the AC outlet.

Turning the Projector On

Before performing the steps in this section, connect any equipment that you use with the projector. (See pages 23-29.)



Remove the lens cap and press  **STANDBY/ON** on the projector or  **ON** on the remote control.

- The power indicator illuminates green.
- After the lamp indicator illuminates, the projector is ready to start operation.
- When System Lock is set, the keycode input screen appears. Enter the right keycode to start projection. See page 49 for details.

Note

- The lamp indicator illuminates or blinks, indicating the status of the lamp.
 - Green:** The lamp is on.
 - Blinking green:** The lamp is warming up.
 - Red:** The lamp is shut down abnormally or the lamp should be replaced.
- When switching on the projector, a slight flickering of the image may be experienced within the first minute after the lamp has been illuminated. This is normal operation as the lamp's control circuitry is stabilizing the lamp output characteristics. This does not indicate malfunction.
- If the projector is put into standby mode and immediately turned on again, the lamp may take some time to illuminate.

Turning the Power Off (Putting the Projector into Standby Mode)

- 1 Press  **STANDBY/ON** on the projector or  **STANDBY** on the remote control, then press that button again while the confirmation message is displayed, to put the projector into standby mode.

Supplied accessory

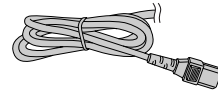

Power cord

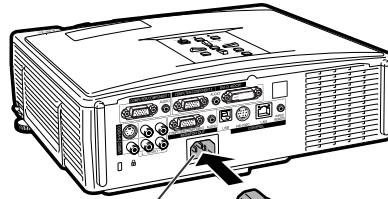

AC socket

To AC outlet

Info

- When “Auto Restart” is set to “On”:
If the power cord is unplugged from the outlet or the breaker switch is turned off when the projector is on, then the projector automatically turns on when the power cord is plugged into the AC outlet or the breaker switch is turned on. (See page 50.)
- English is the factory preset language. If you want to change the on-screen display to another language, change the language according to the procedure on page 54.

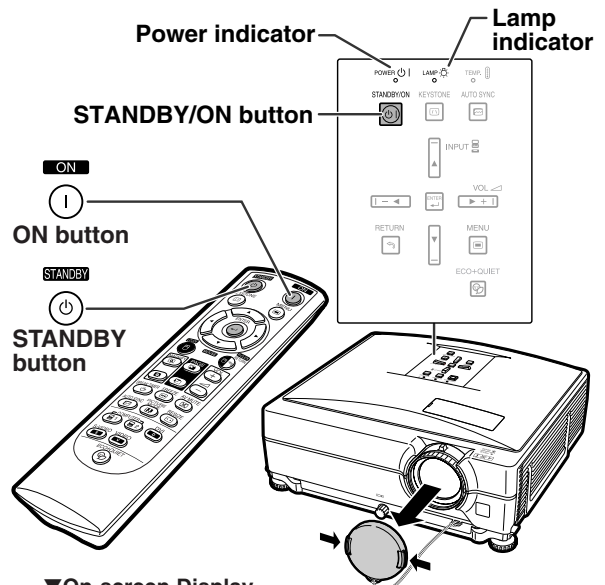

▼On-screen Display



Enter STANDBY mode?

Yes: Press Again. No: Please Wait.

Info

- **Direct Power Off function:**
You can unplug the power cord from the AC outlet even if the cooling fan is still running.
- Even if you unplug the power cord from the projector, the cooling fan continues to run for a while.

Image Projection

Using the Adjustment Feet

The height of the projector can be adjusted using the adjustment feet when the screen is located higher than the projector, the screen is inclined or when the installation site is slightly inclined.

Install the projector so that it is as perpendicular to the screen as possible.

1 Press the Height Adjustment buttons.

- The adjustment feet come out.

2 Lift the projector to adjust its height and remove your hands from the Height Adjustment buttons.

- The projector is adjustable up to approximately 9 degrees.

3 Rotate the Tilt dial to finely adjust the horizontal tilt of the projector.

- The inclination is adjustable within approximately 2 degrees.
- When adjusting the height of the projector, trapezoidal distortion occurs. When "Auto Keystone" of the "Options1" menu is set to "On" (see page 48), keystone correction functions automatically to correct trapezoidal distortion. When you want to adjust the automatically corrected image, use the manual keystone correction. (See page 32.)

Info

- Do not press the Height Adjustment button when the adjustment feet come out without firmly holding the projector.
- Do not hold the lens when lifting or lowering the projector.
- When lowering the projector, be careful not to get your fingers caught in the area between the adjustment foot and the projector.

Side View

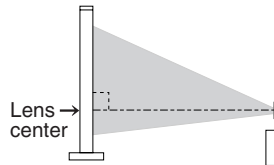

Top View

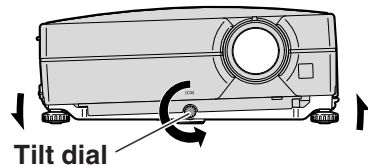
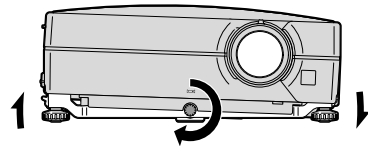
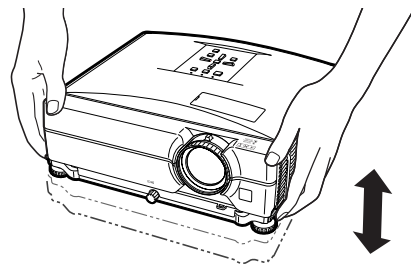
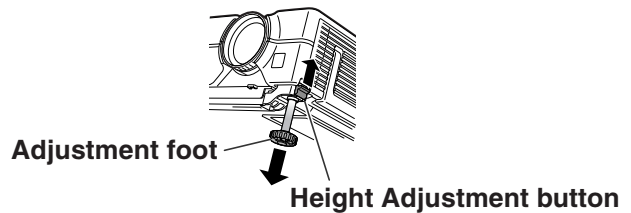
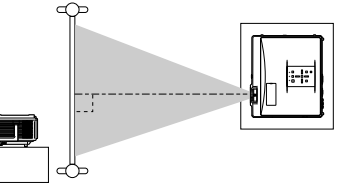

Correcting Trapezoidal Distortion

Auto Keystone Correction

When the image is projected either from the top or from the bottom towards the screen at an angle, the image becomes distorted trapezoidally.

The function for correcting trapezoidal distortion is called **Keystone Correction**.

This projector is equipped with an “Auto Keystone Correction” function that automatically corrects any trapezoidal distortion within the projected image. The correction is made automatically provided the vertical incline or decline is within ± 12 degrees.

Note

- When not using the Auto Keystone Correction function, set “Auto Keystone” on the “Options1” menu to “Off”.

Manual Keystone Correction

When you want to make fine adjustments after the Auto Keystone Correction function has been activated, or when you want to make corrections without using the Auto Keystone Correction function, you can make corrections manually using the following procedure.

1 Press **KEYSTONE** on the remote control to enter the Keystone Correction mode.

- You can also use **KEYSTONE** on the projector.

2 Press **▲**, **▶** or **▼**, **◀** on the remote control to adjust the Keystone Correction.

- You can also adjust the Keystone Correction using the **▲**, **▶** or **▼**, **◀** buttons on the projector.

Note

- Press **RETURN** to return to the default setting.
- Straight lines or the edges of images may appear jagged while adjusting the image.

3 Press **KEYSTONE**.

- The on-screen display of the Keystone Correction mode will disappear.
- You can also use **KEYSTONE** on the projector.

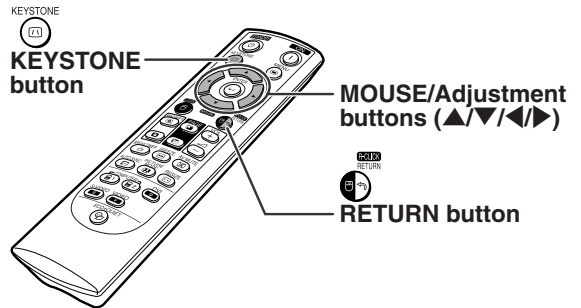

▼ On-screen Display (Keystone Correction mode)



Compresses upper side.

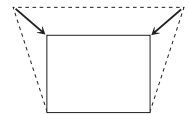
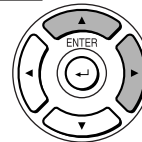

Compresses lower side.

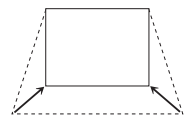
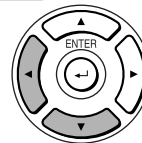

Note

- The Manual Keystone Correction can be adjusted up to an angle of approximately ± 40 degrees and the screen can also be set up to an angle of approximately ± 40 degrees (when the resize mode is set to “Normal” (see page 47)).

Adjusting the Lens

The image is focused and adjusted to the screen size using the focus ring or zoom knob on the projector.

- 1 The focus is adjusted by rotating the focus ring.

- 2 Zooming is adjusted by moving the zoom knob.

Focus ring Zoom knob

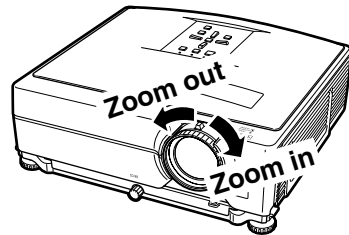
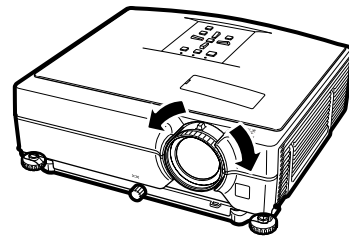
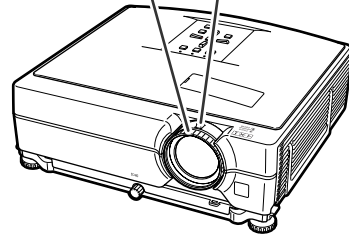

Switching the INPUT Mode

Select the appropriate input mode for the connected equipment.

On the remote control

Press **1**, **2**, **D**, **S** or **V** on the remote control to select the input mode.

On the projector

- ① Press an INPUT (**▲/▼**) button.
 - The INPUT list appears.
- ② Press **▲/▼** to select an item on the list.
- ③ Press **ENTER**.

Note

- When no signal is received, "NO SIGNAL" will be displayed. When a signal that the projector is not preset to receive is received, "NOT REG." will be displayed.

About the INPUT mode

COMPUTER/ COMPONENT 1, 2	Used for projecting images from equipment that sends RGB signals or Component signals connected to the RGB input terminal.
DVI-D	Used for projecting images from equipment that sends DVI Digital RGB and Digital Component signals connected to the DVI-D input terminal.
S-VIDEO	Used for projecting images from equipment connected to the S-VIDEO input terminal.
VIDEO	Used for projecting images from equipment connected to the VIDEO input terminal.

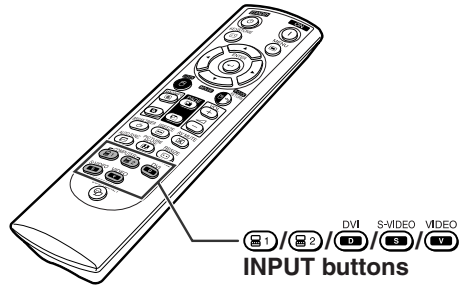

▼On-screen Display of INPUT list

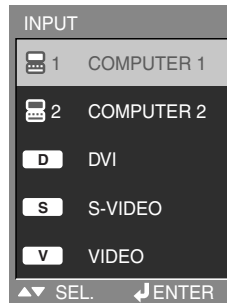

▼On-screen Display of INPUT Mode (Example)

Using RGB

**COMPUTER/
COMPONENT 1, 2
mode**

1 COMPUTER 1
RGB
1024 x 768

Using Component

1 COMPUTER 1
Component
720P/750P

DVI-D mode

D DVI
D. PC RGB
1024 x 768

S-VIDEO mode

S S-VIDEO

VIDEO mode

V VIDEO

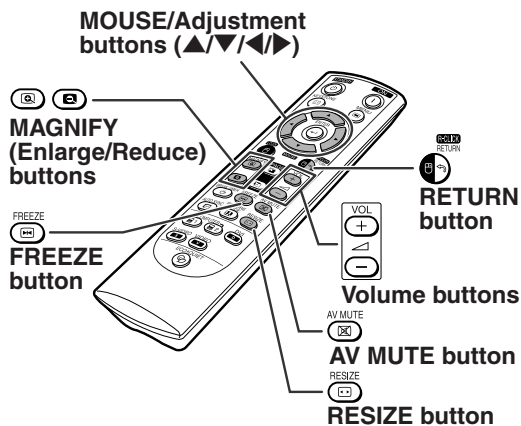

Adjusting the Volume

Press / VOL on the projector or / VOL on the remote control to adjust the volume.

▼ On-screen Display



Note

- Pressing or VOL will lower the volume. Pressing or VOL will raise the volume.

Displaying the Black Screen and Turning Off the Sound Temporarily

Press AV MUTE on the remote control to temporarily display a black screen and turn off the sound.

▼ On-screen Display



Note

- Pressing AV MUTE again will turn the projected image and sound back on.

Displaying an Enlarged Portion of an Image

Graphs, tables and other portions of projected images can be enlarged. This is helpful when providing more detailed explanations.

1 Press MAGNIFY on the remote control.

- Enlarges the image.
- Pressing or MAGNIFY enlarges or reduces the projected image.

Note

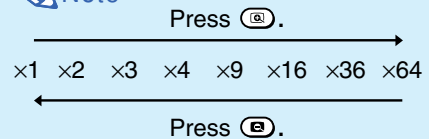

- You can change the location of the enlarged image using , , and .

2 Press RETURN on the remote control to cancel the operation.

- The magnification then returns to $\times 1$.

Note

- In the following cases, the image will return to the normal size ($\times 1$).
- When switching the INPUT mode.
 - When RETURN has been pressed.
 - When the input signal is changed.
 - When the input signal resolution and refresh rate (vertical frequency) change.
 - When RESIZE has been pressed.

Freezing an Image

1 Press FREEZE on the remote control.

- The projected image is frozen.

2 Press FREEZE again to return to the image from the currently connected equipment.

MOUSE/Adjustment buttons (▲/▼/◀/▶)

BREAK TIMER

BREAK TIMER button

RETURN

RETURN button

PICTURE MODE

PICTURE MODE button

ECO+QUIET

ECO+QUIET button

Displaying and Setting the Break Timer

This function allows you to show the remaining time for break during meeting.

- 1 Press  BREAK TIMER. The break timer starts to count down from 5 minutes.

▼On-screen Display





- 2 When “” is displayed, press ▲, ▼, ◀ or ▶ to set the break timer.

- You can set anywhere between 1 and 60 minutes (in 1 minute units).

- 3 Press  BREAK TIMER to cancel the break timer.

Switching the Eco+Quiet Mode

Press  ECO+QUIET on the remote control or  ECO+QUIET on the projector to switch the Eco+Quiet mode between on and off.

- When the Eco+Quiet Mode is set to “On”, the sound of the cooling fan will turn down, the power consumption will decrease, and the lamp life will extend.

Note

- Refer to “Eco+Quiet Mode Setting” on page 48 for details.

Selecting the Picture Mode

You can select the suitable picture mode for the projected image, such as movie or video game.

Press  PICTURE MODE on the remote control.

- When pressing  PICTURE MODE, the picture mode changes in order of:

STANDARD → PRESENTATION → MOVIE → GAME → sRGB

Note

- “sRGB” is displayed only when RGB signal is input.
- Press  RETURN to return to the “STANDARD” mode while “Picture Mode” is displayed on the screen.

Resize Mode

This function allows you to modify or customize the resize mode to enhance the input image. Depending on the input signal, you can choose a desired image.

MOUSE/Adjustment buttons (▲/▼/◀/▶)



COMPUTER

		NORMAL	FULL	DOT BY DOT	BORDER	STRETCH	
4:3 aspect ratio	SVGA (800 × 600)	1024 × 768	1024 × 768	800 × 600	768 × 576	1024 × 576	
	XGA (1024 × 768)			1024 × 768			
	SXGA (1152 × 864)			1152 × 864			
	SXGA+ (1400 × 1050)			1400 × 1050			
Other aspect ratios	SXGA (1280 × 1024)	968 × 768	1024 × 768	1280 × 1024	—	—	
	1280 × 720	1024 × 576		1280 × 720			
	1360 × 768	1024 × 578		1360 × 768			
	1366 × 768	1024 × 576		1366 × 768			
	1280 × 768	1024 × 614		1280 × 768			960 × 576
	1280 × 800	1024 × 640		1280 × 800			922 × 576



Input signal		For 4:3 screen			For 16:9 screen	
Computer	Image type	NORMAL	FULL	DOT BY DOT	BORDER	STRETCH
Resolution lower than XGA	 4:3 aspect ratio		—		 *	 *
XGA				—		
Resolution higher than XGA						
SXGA (1280 × 1024)	 5:4 aspect ratio					
1280 × 720	 16:9 aspect ratio	 *			—	—
1360 × 768 1366 × 768						
1280 × 768	 16:10 aspect ratio	 *			 *	 *
1280 × 800						

■: Cutout area on which images cannot be projected
 □: Area where the signals are off screen

*The Image Shift function can be used for these images.

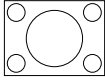
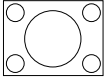
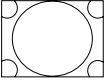
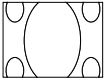
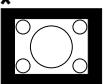
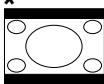
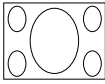
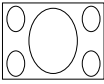
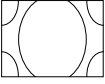
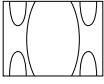
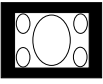
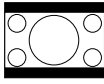
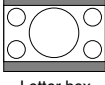
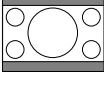
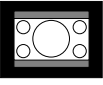
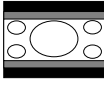
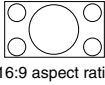
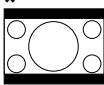
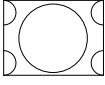
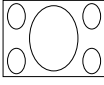
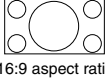
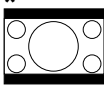
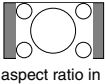
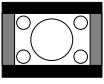
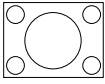
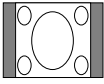
VIDEO/DTV

Input signal		For 4:3 screen			For 16:9 screen	
Video/DTV	Image type	NORMAL	AREA ZOOM	V-STRETCH	BORDER	STRETCH
480I, 480P, 576I, 576P, NTSC, PAL, SECAM	 4:3 aspect ratio					
	 Squeeze					
	 Letter box					
720P, 1035I, 1080I	 16:9 aspect ratio					
540P	 16:9 aspect ratio					
	 (4:3 aspect ratio in 16:9)					

 : Cutout area on which images cannot be projected
 : Area on which the image is not included in the original signals
 *The Image Shift function can be used for these images.

Using the Remote Control as the Wireless Computer Mouse

When connecting the projector and the computer with a USB cable, you can use the remote control as the computer mouse.

If the computer is placed too far away from the projector to be connected via the USB cable, the separately sold remote receiver (AN-MR2) makes it possible to operate the projector with the remote control. For details, see the operation manual of the receiver.

Connecting with a USB cable

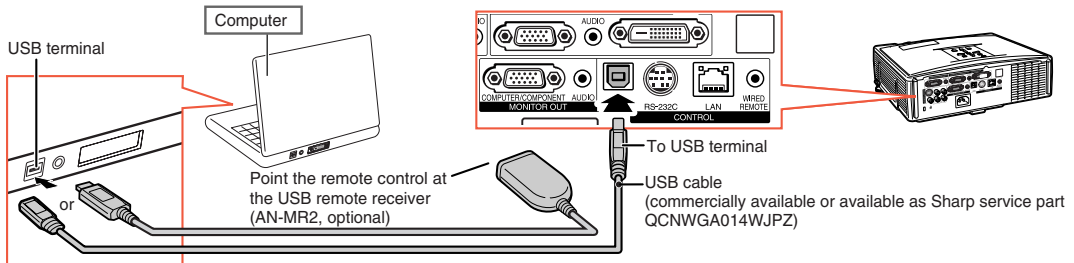

The mouse pointer can be operated in the following way after it is connected.

■ When moving the cursor

Press MOUSE/Adjustment buttons (▲/▼/◀/▶).

■ When left-clicking

Press **L-CLICK**.

■ When right-clicking

Press **R-CLICK**.

■ When your computer supports only a one-click mouse (such as Macintosh)

Press **L-CLICK** or **R-CLICK**.

L-CLICK and **R-CLICK** have common function.

■ When using [Page Up] or [Page Down]

Same as the [Page Up] and [Page Down] keys on a computer keyboard.

Press **PAGE UP** or **PAGE DOWN**.

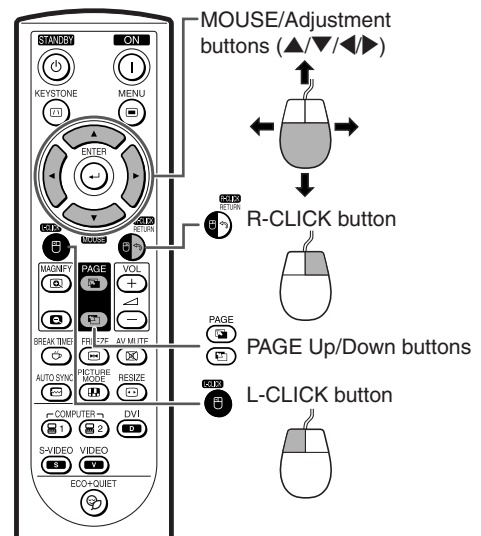

Note

- This function only works with the Microsoft® Windows® OS and Mac OS®. However, this function does not work with the following operation systems that do not support USB.
 - Versions earlier than Windows® 95
 - Versions earlier than Windows® NT4.0
 - Versions earlier than Mac OS® 8.5
- You cannot use this function when displaying the menu screen.
- Confirm that the computer recognizes the USB connection.
- If "Resize" is displayed when signals having a higher resolution than XGA are being input and you have set "Dot By Dot" as the screen size, you cannot operate the mouse function.

Menu Items

The following shows the items that can be set in the projector.

“Picture” menu

COMPUTER/COMPONENT 1 (RGB),
COMPUTER/COMPONENT 2 (RGB), DVI-D

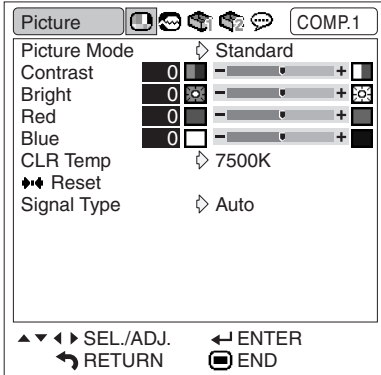

COMPUTER/COMPONENT 1 (Component),
COMPUTER/COMPONENT 2 (Component),
VIDEO, S-VIDEO

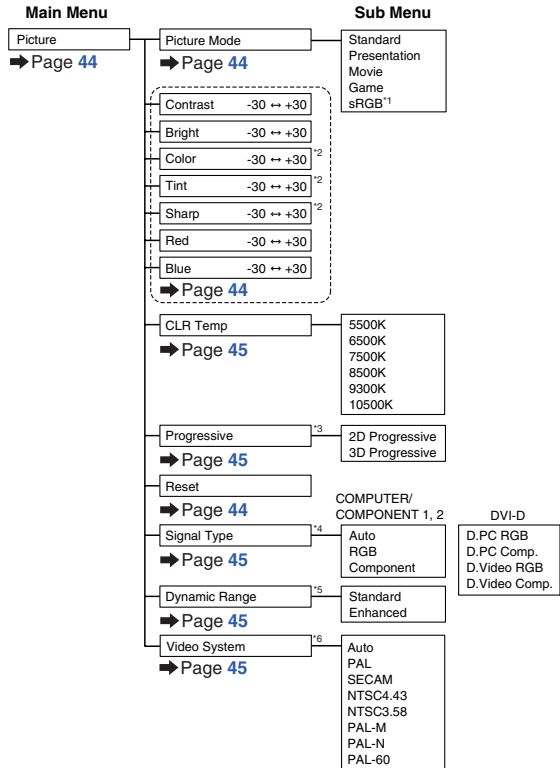
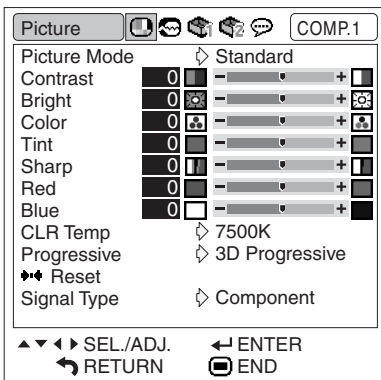

- *1 Item when inputting RGB signal through COMPUTER/COMPONENT 1, 2 or DVI-D
- *2 Items when inputting Component signal through COMPUTER/COMPONENT 1 or 2, or when selecting VIDEO or S-VIDEO
- *3 "Progressive" can be adjusted only when 480i or 576i signal is input.
- *4 Item when selecting COMPUTER/COMPONENT 1, 2 or DVI-D
- *5 Item when selecting DVI-D
- *6 Item when selecting VIDEO or S-VIDEO

“Fine Sync” menu

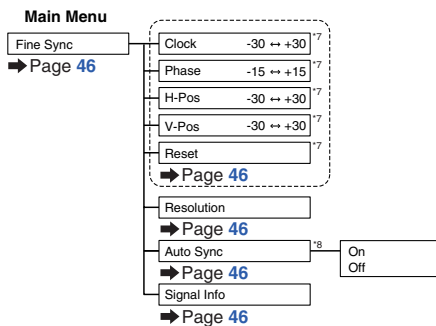
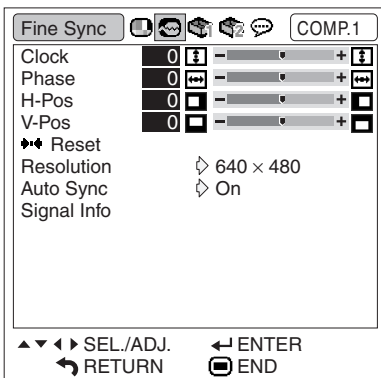

- *7 Item when inputting RGB signal through COMPUTER/COMPONENT 1 or 2
- *8 Item when inputting RGB signal through COMPUTER/COMPONENT 1, 2 or DVI-D



Note

- “Fine Sync” menu is only displayed when the projector input is COMPUTER/COMPONENT 1, 2 or DVI-D.

“Options1” menu

Options1		VIDEO	
Lamp Timer (Life)	0 h (100%)		
Resize	Normal		
Image Shift	0		
Keystone	0		
Auto Keystone	On		
OSD Display	On		
Background	Logo		
Eco+Quiet Mode	On		
Auto Power Off	On		
System Sound	On		
Menu Position	Center		
System Lock	Disable		
Auto Restart	On		
▲▼▶SEL./ADJ.		◀ENTER	
↶RETURN		⏻END	

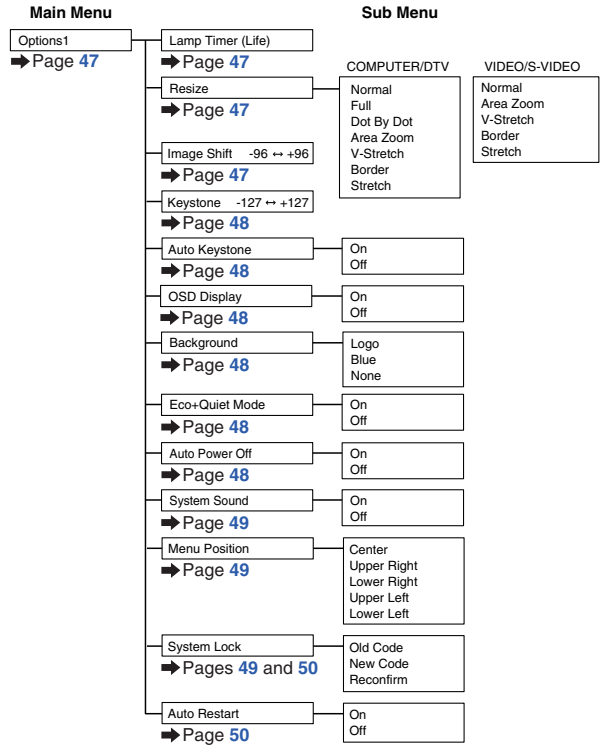

“Options2” menu

Options2		COMP.1	
Password	Disable		
Speaker	On		
Audio Out	FAO		
PRJ Mode	Front		
Fan Mode	Normal		
Monitor Out	Enable		
LAN/RS232C	Enable		
RS-232C	9600 bps		
DHCP Client	On		
TCP/IP			
MAC Address	XX:XX:XX:XX:XX		
Projector	MYPROJECTOR		
◆◆ All Reset			
▲▼▶SEL./ADJ.		◀ENTER	
↶RETURN		⏻END	

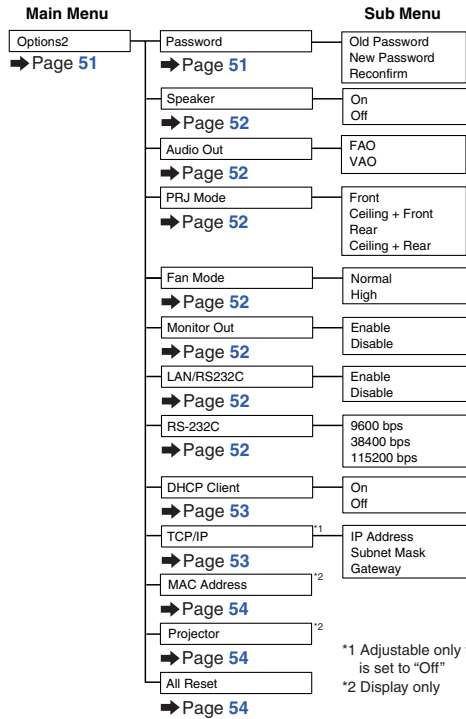

*1 Adjustable only when DHCP Client is set to “Off”
*2 Display only

“Language” menu

Language		COMP.1	
English			
Deutsch			
Español			
Nederlands			
Français			
Italiano			
Svenska			
Português			
汉语			
한국어			
日本語			
▲▼▶SEL./ADJ.		◀ENTER	
↶RETURN		⏻END	



Using the Menu Screen

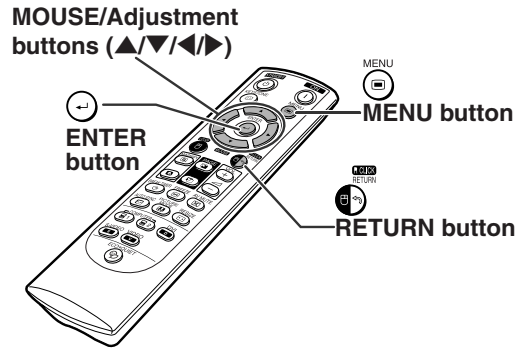
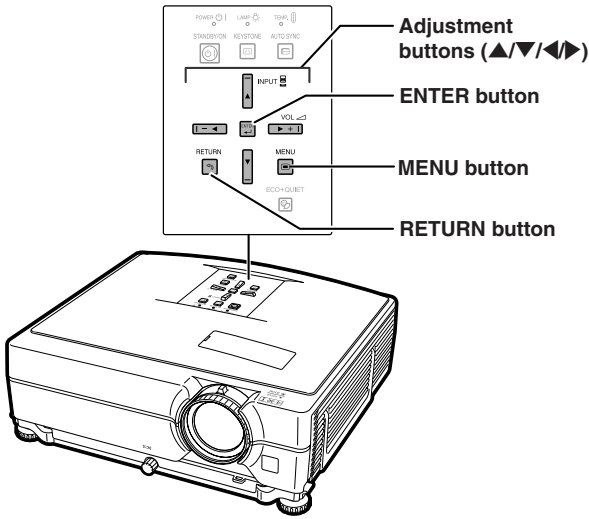

Menu Selections

Example: Adjusting “Bright”

• This operation can also be performed by using the buttons on the projector.

1 Press **MENU**.

• The “Picture” menu screen for the selected input mode is displayed.

2 Press **▶** or **◀** to display the other menu screens.

• The menu icon for the selected menu screen is highlighted.

Menu icon	Menu screen
	Picture
	Fine Sync
	Options1
	Options2
	Language

Note

• The “Fine Sync” menu is not available for selecting VIDEO or S-VIDEO.

Example: “Picture” screen menu for COMPUTER/COMPONENT 1 (RGB) mode

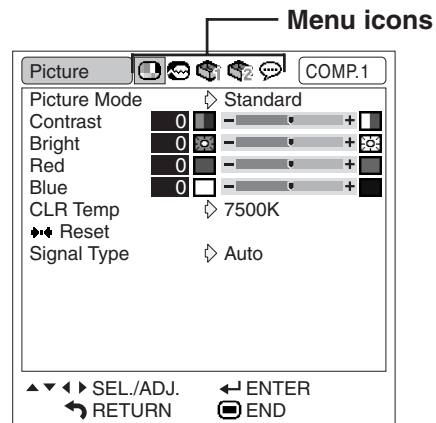

3 Press ▲ or ▼ to select the item you want to adjust.

- The selected item is highlighted.

To adjust the projected image while viewing it

Press ◂ENTER.

- The selected single adjustment item (e.g. “Bright”) appears instead of the menu.
- When pressing ▲ or ▼, the following item (“Red” after “Bright”) will be displayed.

Note

- Press ◂RETURN to return to the previous screen.

4 Press ◀ or ▶ to adjust the item selected.

- The adjustment is stored.
- For some menu items, press ▶ to display its submenu and press ▲ or ▼ to select an adjustment item, and then press ◂ENTER.

5 Press ◂MENU.

- The menu screen will disappear.

Single adjustment items

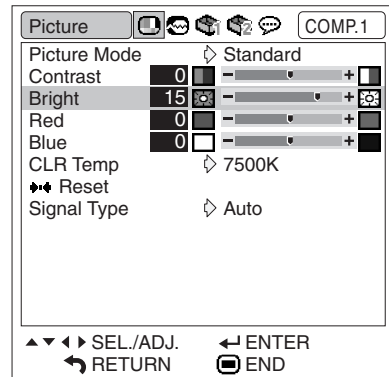
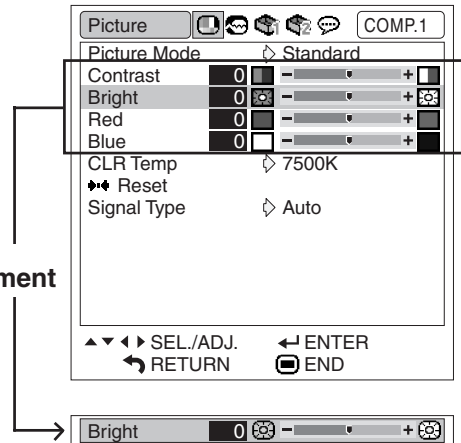

Picture Adjustment (“Picture” menu)

▶ Example: “Picture” screen menu for DVI-D mode

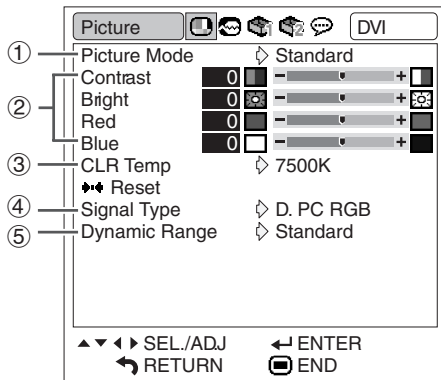

▶ Example: “Picture” screen menu for VIDEO mode

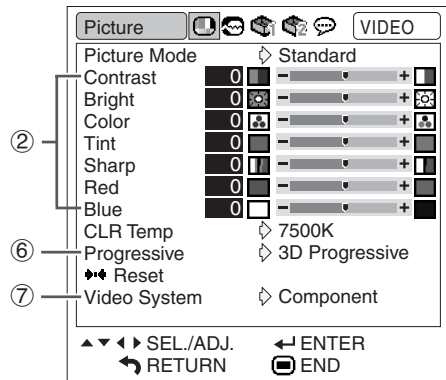

① Selecting the Picture Mode

This function allows you to select the picture mode in accordance with brightness of the room or content of the image to be projected. In all picture modes, items on the “Picture” menu can be adjusted and saved.

Selectable items	Description
Standard	For standard image
Presentation	Brightens portions of image for more enhanced presentations.
Movie	Gives natural tint to the projected image.
Game	Gives sharpness to the projected image.
sRGB	For high fidelity reproduction of images from a computer.

Note

- You can also press **PICTURE MODE** on the remote control to select the picture mode. (See page 36.)
- “sRGB” is displayed only when RGB signal is input.
- sRGB is an international standard of color reproduction regulated by the IEC (International Electrotechnical Commission). As the fixed color area has been decided by the IEC, the images are displayed in a natural tint based on an original image, when “sRGB” is selected. For additional information about the sRGB function, visit “<http://www.srgb.com/>”. You cannot set the items “Red”, “Blue”, “CLR Temp”, when “sRGB” is selected.

Info

- When “sRGB” is selected, the projected image may become dark, but this does not indicate a malfunction.

② Adjusting the Image

Select a picture mode before adjusting the image.

Selectable items	Press ◀	Press ▶
Contrast	For less contrast	For more contrast
Bright	For less brightness	For more brightness
Color ¹	For less color intensity	For more color intensity
Tint ¹	For making skin tones purplish	For making skin tones greenish
Sharp ¹	For less sharpness	For more sharpness
Red ²	For weaker red	For stronger red
Blue ²	For weaker blue	For stronger blue

¹ “Color”, “Tint” and “Sharp” are not displayed when inputting the signal through COMPUTER/COMPONENT 1 (RGB), 2 (RGB) or DVI-D.

² “Red” and “Blue” cannot be adjusted when “sRGB” is selected.

Note

- “Sharp” can be adjusted when 480I, 480P, 540P, 576I, 576P, 720P, 1035I or 1080I signals are detected.
- To reset all adjustment items, select “Reset” and press **ENTER**.

③ Adjusting the Color Temperature

Selectable items	Description
5500K	For lower color temperature for warmer, reddish incandescent-like images.
6500K	
7500K	
8500K	
9300K	For higher color temperature for cooler, bluish, fluorescent-like images.
10500K	

Note

- Values on “CLR Temp” are only for general standard purposes.
- “CLR Temp” cannot be set when “sRGB” is selected.

④ Signal Type Setting

This function allows you to select the input signal type RGB or Component for COMPUTER/COMPONENT 1, 2 or DVI-D.

COMPUTER/COMPONENT 1, 2

Selectable items	Description
Auto	Input signals are automatically recognized as RGB or component.
RGB	Set when RGB signals are received.
Component	Set when Component signals are received.

DVI-D

Selectable items	Description
D. PC RGB	Set when Digital PC RGB signals are received from a computer.
D. PC Comp.	Set when Digital PC Component signals are received from a computer.
D. Video RGB	Set when Digital Video RGB signals are received from video equipment.
D. Video Comp.	Set when Digital Video Component signals are received from video equipment.

⑤ Selecting the Dynamic Range

An optimum picture may not be displayed if a DVI-D-capable device’s output signal type and the projector’s input signal type do not match. If this should occur, switch “Dynamic Range”.

Selectable items	Description
Standard	When the black levels of the image show banding or appear faded, select the item that results in the best picture quality. (In most circumstances, “Standard” should be selected.)
Enhanced	

Note

- The Dynamic Range can be selected only when “DVI-D” input mode is selected.

⑥ Selecting the Progressive Mode

Selectable items	Description
2D Progressive	Useful to display fast-moving images such as sports and action films.
3D Progressive	Useful to display relatively slowmoving images such as drama and documentary more clearly.

Note

- When the image is blurred or noisy, switch to the optimal mode.
- When using progressive inputs, inputs are directly displayed so that “2D Progressive” and “3D Progressive” cannot be selected.

⑦ Setting the Video System

The video input system mode is factory preset to “Auto”; however, a clear picture from the connected audio-visual equipment may not be received, depending on the Video signal difference. In that case, switch the Video signal.

Selectable items
Auto
PAL
SECAM
*NTSC4.43
NTSC3.58
PAL-M
PAL-N
PAL -60

* When reproducing NTSC signals in PAL video equipment.

Note

- The Video signal can only be set in VIDEO or S-VIDEO mode.
- When “Video System” is set to “Auto”, you may not receive a clear picture due to signal differences. Should this occur, switch to the video system of the source signal.

Computer Image Adjustment (“Fine Sync” menu)

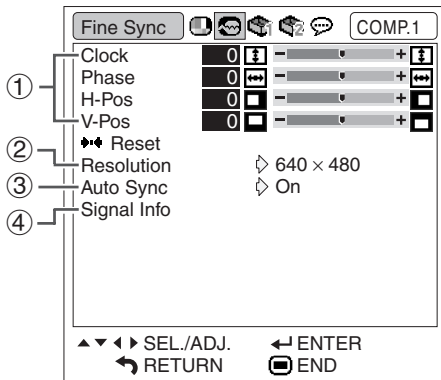

① Adjusting the Computer Image

If the optimum image cannot be obtained with Auto Sync adjustment, use the Fine Sync function.

Selectable items	Description
Clock	Adjusts vertical noise.
Phase	Adjusts horizontal noise (similar to tracking on your VCR).
H-Pos	Centers the on-screen image by moving it to the left or right.
V-Pos	Centers the on-screen image by moving it up or down.

Note

- To reset all adjustment items, select “Reset” and press ENTER.
- The adjustable range of “V-Pos” (V-Position) may vary depending on the screen resolution of the computer.

② Resolution Setting

Ordinarily, the type of input signal is detected and the correct resolution mode is automatically selected. However, for some signals, the optimal resolution mode in “Resolution” on the “Fine Sync” menu may need to be selected to match the computer display mode.

Note

- If your computer displays patterns which repeat every other line (horizontal stripes), flickering may occur which makes the image hard to see.
- See “Checking the Input Signal” on the right column for information on the currently selected input signal.

③ Auto Sync Adjustment

Used to automatically adjust a computer image.

Selectable items	Description
On	Auto Sync adjustment will occur when the projector is turned on or when the input signals are switched, when connected to a computer.
Off	Auto Sync adjustment is not automatically performed.

Note

- Auto Sync adjustment is also performed by pressing AUTO SYNC on the projector or AUTO SYNC on the remote control.
- The Auto Sync adjustment may take some time to complete, depending on the image of the computer connected to the projector.

④ Checking the Input Signal

This function allows you to check the current input signal information.

Using the “Options1” Menu

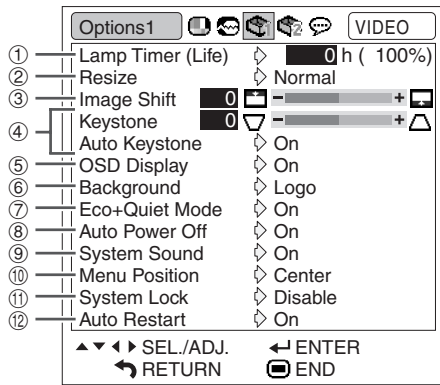

① Checking the Lamp Life Status

You can confirm the cumulative lamp usage time and the remaining lamp life (percentage).

Lamp usage condition	Remaining lamp life	
	100%	5%
Operated exclusively while “Eco+Quiet Mode” is “On”.	Approx. 3,000 hours	Approx. 150 hours
Operated exclusively while “Eco+Quiet Mode” is “Off”.	Approx. 2,000 hours	Approx. 100 hours

Note

- It is recommended that the lamp be changed when the remaining lamp life becomes 5%.
- Remaining lamp life changes within the range of the values shown depending on the frequency at which “Eco+Quiet Mode” is switched to “On” and “Off”. (See page 48.)
- The lamp life may vary depending on the usage condition.

② Setting the Resize Mode

Note

- For details of the Resize mode, see pages 37 and 38.
- You can also press RESIZE on the remote control to set the resize mode. (See page 37.)

③ Adjusting the Image Position

You can move the projected image vertically.

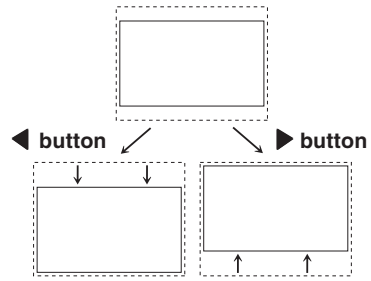

Note

- This function only works in some RESIZE modes. (See pages 37 and 38.)
- To reset this function, select “0”.
- When adjusting the image shift, “Keystone” is set to “0” and “Auto Keystone” is set to “Off”.

④ Keystone Correction

When the image is projected either from the top or from the bottom towards the screen at an angle, the image becomes distorted trapezoidally. The function for correcting trapezoidal distortion is called Keystone Correction.

Auto Keystone Correction

Set “Auto Keystone” on the “Options1” screen menu to “On”.

Manual Keystone Correction

Set “Auto Keystone” on the “Options1” screen menu to “Off”, and select “Keystone”, then adjust with the slide bar.

Manual Correction

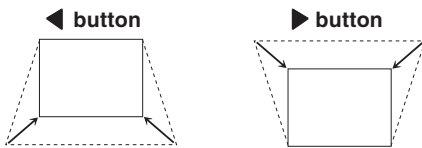

Note

- The Keystone Correction can be adjusted up to an angle of approximately ± 12 degrees with the “Auto Keystone” and up to an angle of approximately ± 40 degrees with the manual “Keystone”. (when “Resize” is set to “Normal”)
- When the screen is slanting or the image is deteriorated, set “Auto Keystone” to “Off”.
- When adjusting the keystone or when “Auto Keystone” is set to “On”, “Image Shift” is automatically set to “0”.

⑤ Setting On-screen Display

This function allows you to turn the on-screen messages on or off.

Selectable items	Description
On	All On-screen Displays are displayed.
Off	<ul style="list-style-type: none"> • INPUT mode/VOLUME/AV MUTE/FREEZE/AUTO SYNC/MAGNIFY/“An invalid button has been pressed.” are not displayed. • “All buttons on Projector are locked.” is displayed when STANDBY/ON is pressed while the Keylock function is active.

⑥ Selecting a Startup and Background Image

Selectable items	Description
Logo	SHARP default image
Blue	Blue screen
None	Black screen

⑦ Eco+Quiet Mode Setting

Selectable items	Brightness	Fan Sound	Lamp life
On	Approx. 80%	Low	Approx. 3,000 hours
Off	100%	Normal	Approx. 2,000 hours

Note

- You can also use ECO+QUIET button on the remote control or on the projector to switch the Eco+Quiet Mode. (See page 36.)

⑧ Auto Power Off Function

Selectable items	Description
On	The projector automatically enters the standby mode when no input signal is detected for 15 minutes or longer.
Off	The Auto Power Off function will be disabled.

Note

- When the Auto Power Off function is set to “On”, 5 minutes before the projector enters the standby mode, the message “Enter STANDBY mode in X min.” will appear on the screen to indicate the remaining minutes.

⑨ Setting the System Sound

Selectable items	Description
On	A confirmation sound is made when the projector turns on/off.
Off	No confirmation sound is made.

⑩ Selecting the Menu Screen Position

Select “Menu Position” on the “Options1” menu and the desired position for the menu screen.

Selectable items	Description
Center	Displayed on the center of the image.
Upper Right	Displayed on the upper right of the image.
Lower Right	Displayed on the lower right of the image.
Upper Left	Displayed on the upper left of the image.
Lower Left	Displayed on the lower left of the image.

⑪ System Lock Function

This function prevents unauthorized use of the projector. Once this function is activated, users must enter the correct keycode each time the projector is turned on. We suggest you record the keycode in a safe place where only authorized users have access.

Info

- If you lose or forget your keycode, contact your nearest Sharp Authorized Projector Dealer or Service Center (see page 66). Even if the product warranty is valid, the keycode reset will incur a charge.

Setting/Changing the keycode

1 Select “System Lock” on the “Options1” menu, then press ►.

- A message is displayed.
- Read this message, and press ◀ENTER.
- The screen for entering the keycode appears.

2 Press the 4 buttons on the remote control or on the projector to enter the preset keycode in “Old Code”.

- When setting the keycode for the first time, press ▼ on the projector for four times.

▼ On-screen Display

System Lock				
Old Code	—	—	—	—
New Code	—	—	—	—
Reconfirm	—	—	—	—
← RETURN			END	

Note

- If you input a wrong keycode, the cursor returns to the first point of the “Old Code”.
- The preset keycode is 4 ▼ buttons on the projector. If this keycode is set, the keycode input screen does not appear when turning the power on.

3 Press the 4 buttons on the remote control or on the projector to enter the new keycode in “New Code”.

Note

- You cannot use the following buttons for keycode:
 - STANDBY/ON button
 - ON button
 - STANDBY button
 - ENTER button
 - L-CLICK button
 - R-CLICK/RETURN button
 - MENU button
 - ECO+QUIET button
 - BREAK TIMER button
- System lock function recognizes each button on the remote control or on the projector as an individual button, even if they share the same button name. If you used the buttons on the projector in setting your keycode, the keycode cannot be canceled with the remote control.

4 Enter the same keycode in “Reconfirm”.

Note

To cancel the keycode that you have already set

- Press ▼ on the projector for four times in steps 3 and 4 above.

When System Lock is set

When System Lock is set, the keycode input screen appears after the power is turned on.

When it appears, enter the right keycode to start projection. Failure to enter the keycode will cause images not to be projected even when signals are entered to the projector.

▼ Input screen for keycode

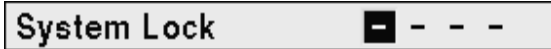

Note

- If no keycode is entered, the image will not be displayed, even if the projector receives the input signal.

12 Auto Restart Function

Selectable items	Description
On	If the power cord is unplugged from the outlet or the breaker switch is turned off when the projector is on, then the projector automatically turns on when the power cord is plugged into the AC outlet or the breaker switch is turned on.
Off	The projector does not turn on automatically when the power cord is plugged into the AC outlet or the breaker switch is turned on.

Locking the Operation Buttons on the Projector (Keylock Function)

Use this function to lock the operation buttons on the projector.

■ Locking the Operation Buttons

Hold down ENTER on the projector for about 5 seconds while the projector is being turned on.

▼ On-screen Display

Keylock function ON

- The keylock function does not affect the operation with the remote control buttons.
- You cannot use the keylock function while the projector is warming up.

■ Taking the Keylock Off

Hold down ENTER on the projector for about 5 seconds.

▼ On-screen Display

Keylock function OFF

- When the projector is in standby mode, you can release the keylock by holding down ENTER and STANDBY/ON on the projector simultaneously for about 5 seconds.



Info

- You can activate the keylock function only when no on-screen display is shown.

Helpful Functions Set during Installation (“Options2” menu)

Menu operation ➡ Page 42

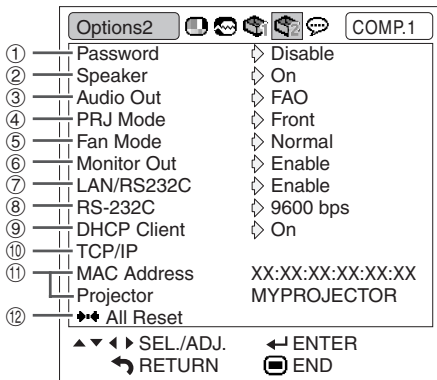

① Setting a Password

If you do not want others to change the setting for the “Options2” menu, set a password.

1 Select “Password”, then press ►.

- The screen for entering the password is displayed.

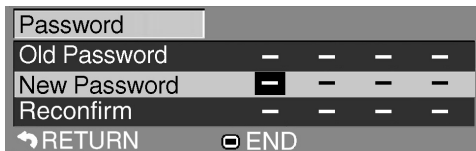

2 Press ▲ or ▼ to set the first digit in “New Password” and then press ►.

3 Enter the remaining 3 digits and press ◀ENTER.

4 Enter the same password in “Reconfirm” and press ◀ENTER.

Note

- Once the password is set, you must enter the password to change the “Options2” menu settings.

Changing the Password

1 Select “Password”, then press ►.

- The screen for entering the password appears.

2 Enter the password in “Old Password” using ▲, ▼, ► and ◀, then press ◀ENTER.

3 Enter the password in “New Password” using ▲, ▼, ► and ◀, then press ◀ENTER.

4 Enter the same password again in “Reconfirm” using ▲, ▼, ► and ◀, then press ◀ENTER.

Note

- If you do not need the password protection for the “Options2” menu settings anymore, press ◀ENTER without entering a new password in steps 3 and 4.
- To cancel the password settings, press ◀RETURN.

If You Forget Your Password

If you forget the password, perform the following procedure to delete it, then set a new password.

On the projector, press:



Note

- If ◀ENTER is held down for more than 5 seconds, the operation buttons on the projector will be locked. (See page 50.)
- You cannot use the buttons on the remote control to delete the password.

② Speaker Setting

This function allows you to set the audio output of the internal speaker to “On” or “Off” such as when the projector is connected to an external amplifier.

Selectable items	Description
On	The audio signal is output from the internal speaker.
Off	The audio signal is not output from the internal speaker.

③ Audio Output Type Setting

This function determines whether the audio level output from the AUDIO output (MONITOR output) terminal is fixed or variable by linking with VOL-UME.

Selectable items	Description
FAO (Fixed Audio Output)	Audio output that does not vary in strength with the volume level of the source projector.
VAO (Variable Audio Output)	Audio output that varies in strength with the volume level of the source projector.

Info

- When “Audio Out” has been set to “VAO”, first make sure to lower the volume of the projector before turning the power on or off and when switching the input.

④ Reversing/Inverting Projected Images

This projector is equipped with a reverse/invert image function that allows you to reverse or invert the projected image for various applications.

Selectable items	Description
Front	Normal image (Projected from the front of the screen)
Ceiling + Front	Inverted image (Projected from the front of the screen with an inverted projector)
Rear	Reversed image (Projected from the rear of the screen or with a mirror)
Ceiling + Rear	Reversed and inverted image (Projected with a mirror)

Note

- This function is used for the reversed image and ceiling-mount setups. (See page 19.)

⑤ Fan Mode Setting

This function changes the fan rotation speed.

Selectable items	Description
Normal	Suitable for normal environments.
High	Select this when using the projector at altitudes of approximately 1,500 meters (4,900 feet) or more.

When “Fan Mode” is set to “High”, the fan rotation speeds up, and the fan noise becomes louder.

⑥ Monitor Output

⑦ LAN/RS232C

When set to “Enable”, the function is activated and power is consumed even in the standby mode. It is recommended that the function be set to “Disable” when it is not connected. This reduces power consumption when the projector is in the standby mode.

Selectable items	Description
Enable	The function is activated even if the projector is in standby mode.
Disable	The function is switched off when the projector is in standby mode.

Note

- When you want to control the projector using the LAN/RS232C function, select “Enable”.

⑧ Selecting the Transmission Speed (RS-232C)

Make sure that both the projector and computer are set for the same baud rate.

Selectable items	Description
9600 bps	Transmission speed is slow. ↕ Transmission speed is rapid.
38400 bps	
115200 bps	

Note

- Refer to the “SETUP MANUAL” contained on the supplied CD-ROM for RS-232C Specifications and Command Settings.
- Refer to the computer’s operation manual for instructions for setting the computer’s baud rate.

⑨ DHCP Client Setting

Connect the LAN cable before turning the projector on. If not, the DHCP Client function does not work.

Selectable items	Description
On	Obtains configuration parameters for TCP/IP network automatically.
Off	Sets the TCP/IP manually.

Select “On” for “DHCP Client”, then press \odot ENTER. “Obtaining IP Address...” appears, then the menu screen appears. Confirm the parameters of IP Address, Subnet Mask and Gateway on the TCP/IP screen.

If the DHCP server is not available, “Could not obtain IP Address.” appears.

In this case, set the TCP/IP manually. (See the item ⑩.)

⑩ TCP/IP Setting

Set the TCP/IP manually.

1 Select “Off” for “DHCP Client”, then press \odot ENTER.

2 Select “TCP/IP”, then press \odot ENTER.

3 Enter “IP Address” using \blacktriangle , \blacktriangledown , \blacktriangleright and \blacktriangleleft , then press \odot ENTER.

TCP/IP	
IP Address	199. 168. 150. 002
Subnet Mask	255. 255. 255. 000
Gateway	000. 000. 000. 000
\blacktriangleleft RETURN	\odot END

4 Enter “Subnet Mask” using \blacktriangle , \blacktriangledown , \blacktriangleright and \blacktriangleleft , then press \odot ENTER.

5 Enter “Gateway” using \blacktriangle , \blacktriangledown , \blacktriangleright and \blacktriangleleft , then press \odot ENTER.

Selectable items	Description
IP Address	Factory default setting: 192.168.150.002 Enter an IP address appropriate for the network.
Subnet Mask	Factory default setting: 255.255.255.000 Set the subnet mask to the same as that of the computer and equipment on the network.
Gateway	Factory default setting: 000.000.000.000 * When not in use, set to: “000.000.000.000”.

Note

- Confirm the existing network’s segment (IP address group) to avoid setting an IP address that duplicates the IP addresses of other network equipment or computers. If “192.168.150.002” is not used in a network with an IP address of “192.168.150.XXX”, you don’t have to change the projector IP address.
- For details about each setting, consult your network administrator.

11 Confirming the Network Information for the Projector

You can confirm the MAC address and projector name.

Displayed items	Description
MAC Address	The MAC address of the projector is displayed.
Projector	The projector name is displayed.

Note

- For information on how to change the projector name, see “SETUP MANUAL” contained in the supplied CD-ROM.

12 Returning to the Default Settings

This function allows you to initialize the settings you have made in the projector.

Note

The following items or menu cannot be initialized.

- “Fine Sync” menu
Resolution
- “Options1” menu
Lamp Timer (Life)
System Lock
- “Language” menu

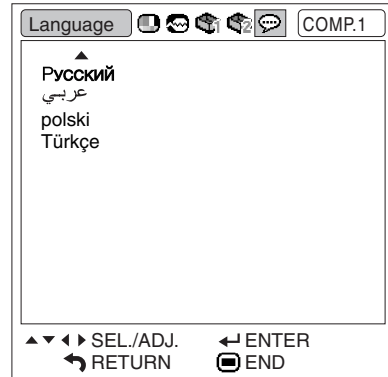

Selecting the On-screen Display Language

The projector can switch the on-screen display language among 15 languages.

Maintenance

Cleaning the projector

- Ensure the power cord is unplugged before cleaning the projector.
- The cabinet as well as the operation panel is made of plastic. Avoid using benzene or thinner, as these can damage the finish on the cabinet.
- Do not use volatile agents such as insecticides on the projector.

Do not attach rubber or plastic items to the projector for long periods.

The effects of some of the agents in the plastic may cause damage to the quality or finish of the projector.

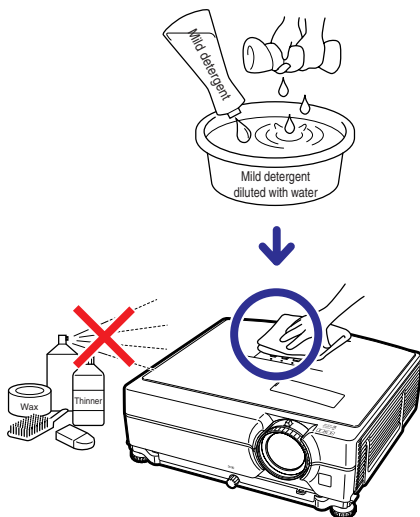

- Wipe off dirt gently with a soft flannel cloth.
- When the dirt is hard to remove, soak a cloth in a mild detergent diluted with water, wring the cloth well and then wipe the projector. Strong cleaning detergents may discolor, warp or damage the coating on the projector. Make sure to test on a small, inconspicuous area on the projector before use.

Cleaning the lens

- Use a commercially available blower or lens cleaning paper (for glasses and camera lenses) for cleaning the lens. Do not use any liquid type cleaning agents, as they may wear off the coating film on the surface of the lens.
- As the surface of the lens can easily get damaged, be careful not to scrape or hit the lens.

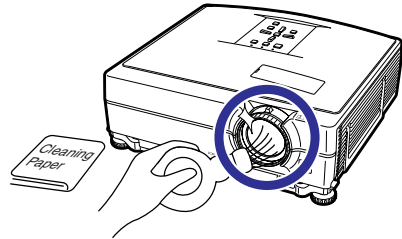

Cleaning the exhaust and intake vents

- Use a vacuum cleaner to clean dust from the exhaust vent and the intake vent.

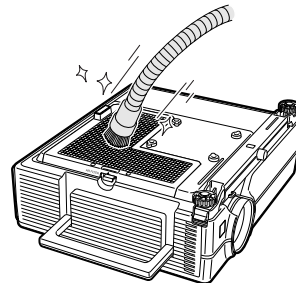
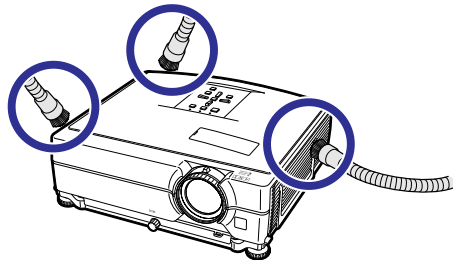

Info

- If you want to clean the air vents during projector operation, ensure you press STANDBY/ON on the projector or STANDBY on the remote control and put the projector into standby mode. After the cooling fan has stopped, unplug the power cord from the AC socket and clean the vents.
- The air filters should be cleaned every 100 hours of use. Clean the filters more often when the projector is used in a dusty or smoky location.

Replacing the Air Filter

- This projector is equipped with air filters to ensure the optimal operating condition of the projector.
- Ask your nearest Sharp Authorized Projector Dealer or Service Center to exchange the filter (PFILDA022WJKZ) when it is no longer possible to clean.

Replacing the Air Filter

- 1 Press  STANDBY/ON on the projector or  STANDBY on the remote control to put the projector into the standby mode.**

- Wait until the cooling fan stops.

- 2 Disconnect the power cord.**

- Unplug the power cord from the AC socket.

- 3 Remove the filter cover.**

- Turn over the projector. Pull down the carrying handle (①), grab the tab (②) and slide open the filter cover (③).

- 4 Remove the air filter.**

- Pick the air filter up with your fingers and lift it out of the filter cover.

STANDBY button

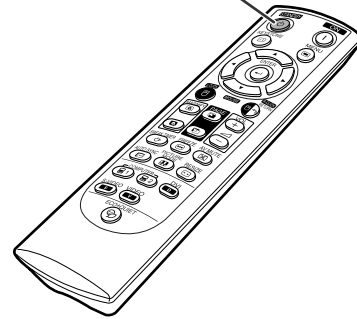

STANDBY/ON button

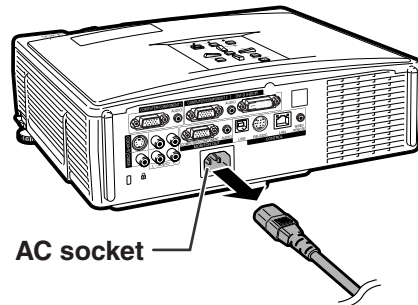
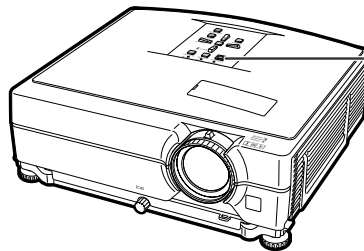

AC socket

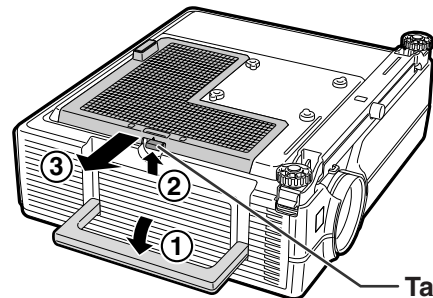

Tab

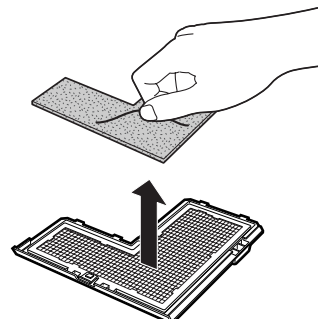

5 Place a replacement air filter.

- Place the new air filter onto the filter cover.

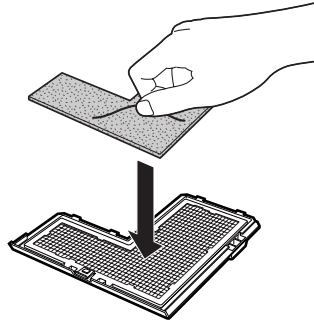

6 Replace the filter cover.

- Slide the filter cover in the direction of the arrow to close it.

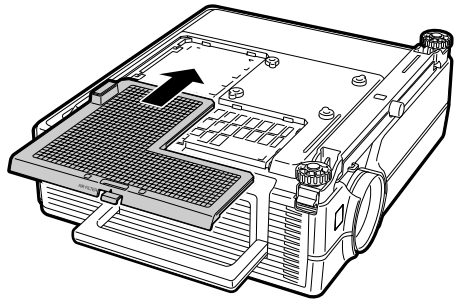

Note

- Ensure the filter cover is securely installed. The power will not turn on unless it is correctly installed.

Maintenance Indicators

- The warning lights on the projector indicate problems inside the projector.
- If a problem occurs, either the temperature indicator or the lamp indicator will illuminate red, and the projector will enter the standby mode. After the projector has entered the standby mode, follow the procedures given below.

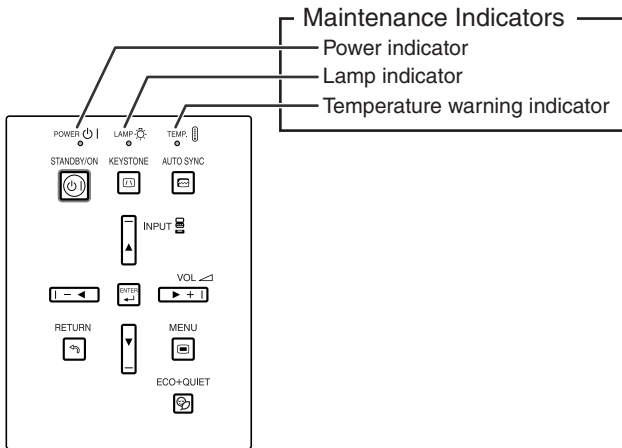

About the temperature warning indicator



If the temperature inside the projector increases, due to blockage of the air vents, or the setting location, "TEMP." will illuminate in the lower left corner of the picture. If the temperature keeps on rising, the lamp will turn off and the temperature warning indicator will blink, the cooling fan will run for a further 90 seconds, and then the projector will enter the standby mode. After "TEMP." appears, ensure you perform the measures described on page 59.

About the lamp indicator



- When the remaining lamp life becomes 5% or less, "Change The Lamp." (yellow) and "Change The Lamp." will be displayed on the screen. When the percentage becomes 0%, it will change to "Change The Lamp." (red), the lamp will automatically turn off and then the projector will automatically enter the standby mode. At this time, the lamp indicator will illuminate in red.
- If you try to turn on the projector a fourth time without replacing the lamp, the projector will not turn on.

	Maintenance indicator		Problem	Cause	Possible solution
	Normal	Abnormal			
Temperature warning indicator	Off	Red on (Standby)	The internal temperature is abnormally high.	<ul style="list-style-type: none"> Blocked air intake Cooling fan break-down Internal circuit failure Clogged air intake 	<ul style="list-style-type: none"> Relocate the projector to an area with proper ventilation (see page 8). Take the projector to your nearest Sharp Authorized Projector Dealer or Service Center (see page 66) for repair. Clean the exhaust and intake vents. (See page 55.)
Lamp indicator	Green on (Green blinks when the lamp is warming up)	Red on	The lamp does not illuminate.	<ul style="list-style-type: none"> The lamp is shut down abnormally. 	<ul style="list-style-type: none"> Disconnect the power cord from the AC outlet, and then connect it again. Carefully replace the lamp. (See page 61.) Take the projector to your nearest Sharp Authorized Projector Dealer or Service Center (see page 66) for repair.
		Red on (Standby)	Time to change the lamp.	<ul style="list-style-type: none"> Remaining lamp life becomes 5% or less. 	
		Red on (Standby)	The lamp does not illuminate.	<ul style="list-style-type: none"> Burnt-out lamp Lamp circuit failure 	<ul style="list-style-type: none"> Please exercise care when replacing the lamp. Securely install the lamp unit cover.
Power indicator	Green on/ Red on Green blinks (Cooling)	Red blinks	The power indicator blinks in red when the projector is on.	<ul style="list-style-type: none"> The filter cover, lamp unit cover or lens housing cover is open. Cooling fan break-down 	<ul style="list-style-type: none"> If the power indicator blinks even when the covers are securely installed, or if the cooling fan does not run normally, then contact your nearest Sharp Authorized Projector Dealer or Service Center (see page 66) for advice.

Info

- If the temperature warning indicator illuminates and the projector enters the standby mode, check whether any of the ventilation holes are blocked (see page 8) and then try turning the power back on. Wait until the projector has cooled down completely before plugging in the power cord and turning the power back on. (At least 10 minutes.)
- If the power is turned off for a brief moment due to power outage or some other cause while using the projector, and the power supply recovers immediately after that, the lamp indicator will illuminate in red and the lamp may not be lit. In this case, unplug the power cord from the AC outlet, replace the power cord in the AC outlet and then turn the power on again.
- The cooling fan keeps the internal temperature of the projector constant and this function is controlled automatically. The sound of the cooling fan may change during operation because the fan speed may change and this is not a malfunction.

Regarding the Lamp

Lamp

- It is recommended that the lamp unit (optional: AN-C430LP) be replaced when the remaining lamp life becomes 5% or less, or when you notice a significant deterioration in the picture and color quality. The lamp life (percentage) can be checked with the on-screen display. See page 47.
- Purchase a replacement lamp unit of type AN-C430LP from your place of purchase, nearest Sharp Authorized Projector Dealer or Service Center.

IMPORTANT NOTE TO U.S. CUSTOMERS:

The lamp included with this projector is backed by a 90-day parts and labor limited warranty. All service of this projector under warranty, including lamp replacement, must be obtained through a Sharp Authorized Projector Dealer or Service Center. For the name of the nearest Sharp Authorized Projector Dealer or Service Center, please call toll-free: 1-888-GO-SHARP (1-888-467-4277).

Hg LAMP CONTAINS MERCURY For State Lamp Disposal Information
www.lamprecycle.org or 1-800-BE-SHARP

U.S.A. ONLY

Caution Concerning the Lamp

- This projector utilizes a pressurized mercury lamp. A loud sound may indicate lamp failure. Lamp failure can be attributed to numerous sources such as: excessive shock, improper cooling, surface scratches or deterioration of the lamp due to a lapse of usage time. The period of time up to failure largely varies depending on the individual lamp and/or the condition and the frequency of use. It is important to note that failure can often result in the bulb cracking.
- When the lamp replacement indicator and on-screen display icon are illuminated, it is recommended that the lamp be replaced with a new one immediately, even if the lamp appears to be operating normally.
- Should the lamp break, the glass particles may spread inside the lamp cage or gas contained in the lamp may be vented into the room from the exhaust vent. Because the gas in this lamp includes mercury, ventilate the room well if the lamp breaks and avoid all exposure to the released gas. In case of exposure to the gas, consult a doctor as soon as possible.
- Should the lamp break, there is also a possibility that glass particles may spread inside of the projector. In such a case, it is recommended you contact your nearest Sharp Authorized Projector Dealer or Service Center to assure safe operation.

Replacing the Lamp

Caution

- Do not remove the lamp unit from the projector right after use. The lamp will be very hot and may cause burn or injury.
 - Wait at least one hour after the power cord is disconnected to allow the surface of the lamp unit to fully cool before removing the lamp unit.
 - **Carefully change the lamp by following the instructions described in this section. *If you wish, you may have the lamp replaced at your nearest Sharp Authorized Projector Dealer or Service Center.**
- * If the new lamp does not illuminate after replacement, take your projector to the nearest Sharp Authorized Projector Dealer or Service Center for repair.

Removing and Installing the Lamp Unit

⚠ Warning!

- Do not remove the lamp unit from the projector right after use. The lamp and parts around the lamp will be very hot and may cause burn or injury.

📖 Info

- Do not touch the glass surface of the lamp unit or the inside of the projector.
- To avoid injury to yourself and damage to the lamp, make sure you carefully follow the steps below.
- Do not loosen other screws except for the lamp unit cover and lamp unit.

- 1 Press  STANDBY/ON on the projector or  STANDBY on the remote control to put the projector into standby mode.**

- Wait until the cooling fan stops.

- 2 Disconnect the power cord.**

- Unplug the power cord from the AC socket.
- Leave the lamp until it has fully cooled down (about 1 hour).

- 3 Remove the lamp unit cover.**

- Loosen the user service screw (①) that secures the lamp unit cover. Slide down (②) and remove the lamp unit cover (③).

- 4 Remove the lamp unit.**

- Loosen the securing screws from the lamp unit. Hold the lamp unit and pull it in the direction of the arrow. At this time, keep the lamp unit horizontal and do not tilt it.

Optional
accessory

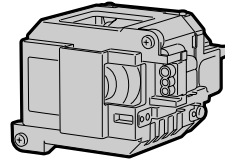

Lamp unit
AN-C430LP

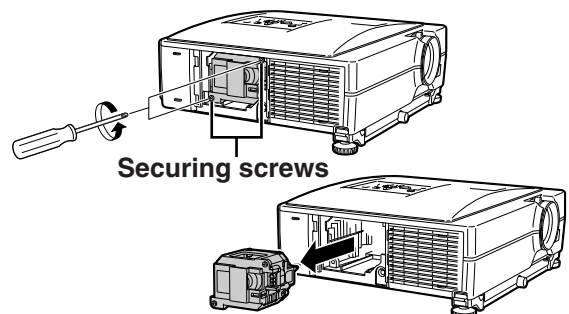
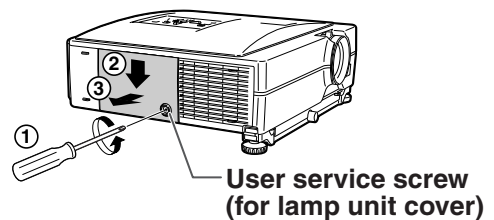
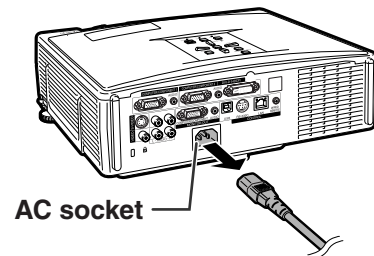
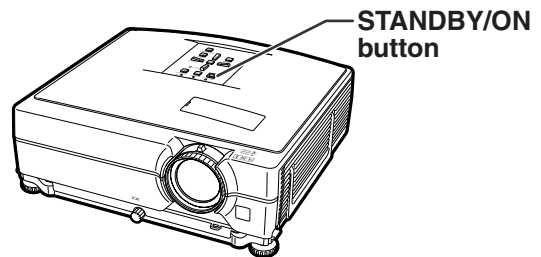

Regarding the Lamp

5 Insert the new lamp unit.

- Press the lamp unit firmly into the lamp unit compartment. Fasten the securing screws.

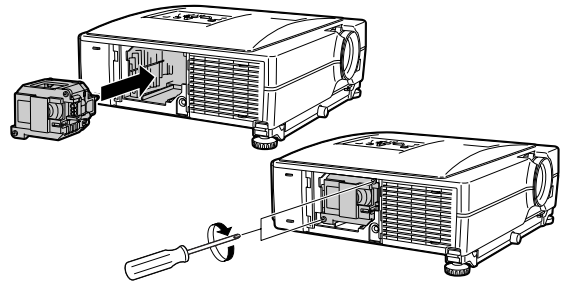

6 Replace the lamp unit cover.

- Align the lamp unit cover and slide it to close. Then tighten the user service screw to secure the lamp unit cover.

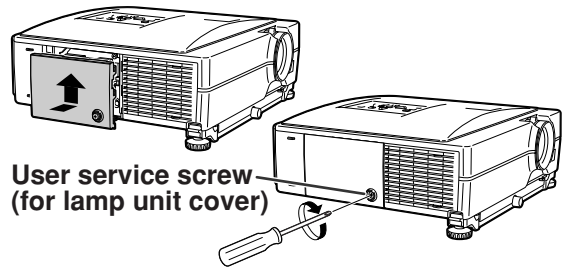

Info

- If the lamp unit and lamp unit cover are not correctly installed, the power will not turn on, even if the power cord is connected to the projector.

Resetting the Lamp Timer

Reset the lamp timer after replacing the lamp.

Info

- Make sure to reset the lamp timer only when replacing the lamp. If you reset the lamp timer and continue to use the same lamp, this may cause the lamp to become damaged or explode.
- You can also reset the lamp timer via the LAN.
(Refer to the SETUP MANUAL on the supplied CD-ROM for details.)

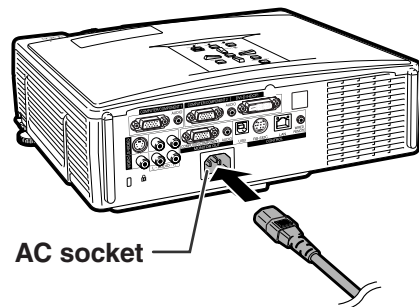

1 Connect the power cord.

- Plug the power cord into the AC socket of the projector.

2 Reset the lamp timer.

- While simultaneously holding down ▼, ENTER and MENU on the projector, press STANDBY/ON on the projector.
- “LAMP 0000H” is displayed, indicating that the lamp timer is reset.

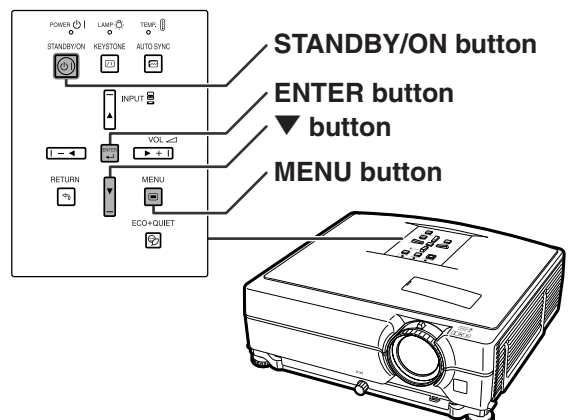

Computer Compatibility Chart

The table below lists signal codes that are compatible with the projector. When the images are distorted or cannot be projected, adjust the output signal of your computer and so forth while referring to the table below.

Computer

- Multiple signal support
- Horizontal Frequency: 15–70 kHz
- Vertical Frequency: 43–85 Hz
- Pixel Clock: 12–108 MHz
- Sync signal: Compatible with TTL level
- Compatible with sync on green signal

The following is a list of modes that conform to VESA. However, this projector supports other signals that are not VESA standards.

PC/MAC	Resolution	Horizontal Frequency (kHz)	Vertical Frequency (Hz)	VESA Standard	DVI Support	Display		
PC	VGA	640 × 400	27.0	60		✓	Upscale	
			31.5	70				
			37.9	85	✓			
		720 × 400	27.0	60				
			31.5	70				
			37.9	85	✓			
	640 × 480	26.2	50					
			31.5	60	✓			
			34.7	70				
		37.9	72	✓				
			37.5	75	✓			
			43.3	85	✓			
	SVGA	800 × 600	31.4	50				
				35.1	56			✓
				37.9	60			✓
			46.6	70				
				48.1	72		✓	
				46.9	75		✓	
	XGA	1,024 × 768	53.7	85	✓			
				35.5	43			
				40.3	50			
			48.4	60	✓			
				56.5	70		✓	
				60.0	75		✓	
	WXGA	1,280 × 720	68.7	85	✓			
				45.0	60			
				47.7	60			
1,280 × 800			62.7	75				
			47.6	60				
			47.8	60				
SXGA	1,152 × 864	55.0	60					
			66.2	70				
			67.5	75	✓			
		1,280 × 1,024	64.0	60	✓			
			64.0	60				
			64.0	60				
MAC 13"	VGA	640 × 480	34.9	67		Upscale		
MAC 16"	SVGA	832 × 624	49.7	75		Upscale		
MAC 19"	XGA	1,024 × 768	60.2	75		True		
MAC 21"	SXGA	1,152 × 870	68.7	75		Intelligent Compression		





Note

- This projector may not be able to display images from notebook computers in simultaneous (CRT/LCD) mode. Should this occur, turn off the LCD display on the notebook computer and output the display data in "CRT only" mode. Details on how to change display modes can be found in your notebook computer's operation manual.
- When this projector receives 640 × 350 VESA format VGA signals, "640 × 400" appears on the screen.
- When projecting the RGB interlace signal using COMPUTER/COMPONENT 1, 2 or DVI-D with "Signal Type" set to "Auto" or "RGB", the image may not be projected as desired. In this case, use either Video or S-Video.

DTV

Signal	Horizontal Frequency (kHz)	Vertical Frequency (Hz)	DVI Support
480I	15.7	60	
480P	31.5	60	✓
540P	33.8	60	✓
576I	15.6	50	
576P	31.3	50	✓
720P	37.5	50	✓
720P	45.0	60	✓
1035I	33.8	60	
1080I	28.1	50	✓
1080I	33.8	60	✓

Troubleshooting

Problem	Check	Page
 <p>No picture and no sound or projector does not start.</p>	<ul style="list-style-type: none"> • Projector power cord is not plugged into the wall outlet. 	30
	<ul style="list-style-type: none"> • Power to the external connected devices is off. 	—
	<ul style="list-style-type: none"> • The selected input mode is wrong. 	34
	<ul style="list-style-type: none"> • The AV MUTE function is working. 	35
	<ul style="list-style-type: none"> • Cables incorrectly connected to the rear panel of the projector. 	23-29
	<ul style="list-style-type: none"> • Remote control batteries have run out. 	15
	<ul style="list-style-type: none"> • External output has not been set when connecting notebook computer. 	23
	<ul style="list-style-type: none"> • The filter cover, lamp unit cover or lamp housing cover is not installed correctly. 	59
 <p>Sound is heard but no picture appears.</p>	<ul style="list-style-type: none"> • Cables incorrectly connected to the rear panel of the projector. 	23-29
	<ul style="list-style-type: none"> • “Bright” is set to minimum position. 	44
 <p>Color is faded or poor.</p>	<ul style="list-style-type: none"> • Image adjustments are incorrectly set. 	44
	(Video, S-Video Input only) <ul style="list-style-type: none"> • Video input system is incorrectly set. 	45
	(COMPUTER/COMPONENT 1, 2, DVI-D only) <ul style="list-style-type: none"> • Input signal type (RGB/Component) is incorrectly set. 	45
 <p>Picture is blurred; noise appears.</p>	<ul style="list-style-type: none"> • Adjust the focus. 	33
	<ul style="list-style-type: none"> • The projection distance exceeds the focus range. 	19
	<ul style="list-style-type: none"> • There is fog on the lens. If the projector is carried from a cold room into a warm room, or if it is suddenly heated, condensation may form on the surface of the lens and the image will become blurred. Please set up the projector at least one hour before it is to be used. If condensation should form, remove the power cord from the wall outlet and wait for it to clear. 	—
	(Computer Input only) <ul style="list-style-type: none"> • Perform “Fine Sync” Adjustments. (“Clock” Adjustment) 	46
	<ul style="list-style-type: none"> • Perform “Fine Sync” Adjustments. (“Phase” Adjustment) • Noise may appear depending on the computer. 	46 —
 <p>Picture appears but no sound is heard.</p>	<ul style="list-style-type: none"> • Cables incorrectly connected to the rear panel of the projector. 	23-29
	<ul style="list-style-type: none"> • Volume is set to minimum. 	35
<p>An unusual sound is occasionally heard from the cabinet.</p>	<ul style="list-style-type: none"> • If the picture is normal, the sound is due to cabinet shrinkage caused by room temperature changes. This will not affect operation or performance. 	—

Problem	Check	Page
Maintenance indicator illuminates or blinks in red.	<ul style="list-style-type: none"> See "Maintenance Indicators". 	58
The projector cannot be turned on or put into the standby mode using the STANDBY/ON button on the projector.	<ul style="list-style-type: none"> The keylock is set. If the keylock is set to ON, all the buttons are locked. 	50
Picture is green with component input signals (COMPUTER/ COMPONENT 1, 2, DVI-D).	<ul style="list-style-type: none"> Change the input signal type setting. 	45
Picture is pink (no green) with RGB input signals (COMPUTER/ COMPONENT 1, 2, DVI-D).		
Picture is too bright and whitish.	<ul style="list-style-type: none"> Image adjustments are incorrectly set. 	44
The black levels of the image show banding or appear faded when DVI-D is selected.	<ul style="list-style-type: none"> Select the Dynamic Range setting ("Standard" or "Enhanced") that results in the best picture quality. 	45
The cooling fan becomes noisy.	<ul style="list-style-type: none"> When temperature inside the projector increases, the cooling fan runs faster. 	—
The lamp does not light up even after the projector turns on.	<ul style="list-style-type: none"> The lamp indicator is illuminating in red. Replace the lamp. 	58
The lamp suddenly turns off during projection.		
The image sometimes flickers.	<ul style="list-style-type: none"> Cables incorrectly connected to the projector or the connected equipment works improperly. If this happens frequently, replace the lamp. 	23-29 60
The lamp takes a long time to turn on.	<ul style="list-style-type: none"> The lamp will eventually need to be changed. The lamp has reached the end of its life. Replace the lamp. 	60
Picture is dark.		
The remote control cannot be used.	<ul style="list-style-type: none"> Operate the remote control while pointing it at the projector's remote control sensor. The remote control may be too far away from the projector. If direct sunlight or a strong fluorescent light is shining on the projector's remote control sensor, place the projector where it will not be affected by strong light. 	15
	<ul style="list-style-type: none"> The batteries may be depleted or inserted incorrectly. Make sure the batteries are inserted correctly or insert new ones. 	15

This projector is equipped with a microprocessor. Its performance could be adversely affected by incorrect operation or interference. If this should happen, unplug the projector and plug it in again after more than 5 minutes.

For SHARP Assistance

If you encounter any problems during setup or operation of this projector, first refer to the “Troubleshooting” section on pages 64 and 65. If this operation manual does not answer your question, please contact the SHARP Service departments listed below.

U.S.A.	Sharp Electronics Corporation 1-888-GO-SHARP (1-888-467-4277) lcdsupport@sharpsec.com http://www.sharppusa.com	Benelux	SHARP Electronics Benelux BV 0900-SHARPCE (0900-7427723) Nederland 9900-0159 Belgium http://www.sharp.nl http://www.sharp.be http://www.sharp.lu
Canada	Sharp Electronics of Canada Ltd. (905) 568-7140 http://www.sharp.ca	Australia	Sharp Corporation of Australia Pty. Ltd. 1300-135-022 http://www.sharp.net.au
Mexico	Sharp Electronics Corporation Mexico Branch (525) 716-9000 http://www.sharp.com.mx	New Zealand	Sharp Corporation of New Zealand (09) 634-2059, (09) 636-6972 http://www.sharp.net.nz
Latin America	Sharp Electronics Corp. Latin American Group (305) 264-2277 www.servicio@sharpsec.com http://www.siemprisharp.com	Singapore	Sharp-Roxy Sales (S) Pte. Ltd. 65-226-6556 ckng@srs.global.sharp.co.jp http://www.sharp.com.sg
Germany	Sharp Electronics (Europe) GMBH 01805-234675 http://www.sharp.de	Hong Kong	Sharp-Roxy (HK) Ltd. (852) 2410-2623 dcmktg@srh.global.sharp.co.jp http://www.sharp.com.hk
U.K.	Sharp Electronics (U.K.) Ltd. 08705 274277 http://www.sharp.co.uk/customersupport	Taiwan	Sharp Corporation (Taiwan) 0800-025111 http://www.sharp-scot.com.tw
Italy	Sharp Electronics (Italy) S.P.A. (39) 02-89595-1 http://www.sharp.it	Malaysia	Sharp-Roxy Sales & Service Co. (60) 3-5125678
France	Sharp Electronics France 01 49 90 35 40 hotlinecd@sef.sharp-eu.com http://www.sharp.fr	U.A.E.	Sharp Middle East Fze 971-4-81-5311 helpdesk@smef.global.sharp.co.jp
Spain	Sharp Electronica Espana, S.A. 93 5819700 sharpplcd@sees.sharp-eu.com http://www.sharp.es	Thailand	Sharp Thebnakorn Co. Ltd. 02-236-0170 svc@stcl.global.sharp.co.jp http://www.sharp-th.com
Switzerland	Sharp Electronics (Schweiz) AG 0041 1 846 63 11 cattaneo@sez.sharp-eu.com http://www.sharp.ch	Korea	Sharp Electronics Incorporated of Korea (82) 2-3660-2002 lcd@sharp-korea.co.kr http://www.sharppkorea.co.kr
Sweden	Sharp Electronics (Nordic) AB (46) 8 6343600 vision.support@sen.sharp-eu.com http://www.sharp.se	India	Sharp Business Systems (India) Limited (91) 11- 6431313 service@sharp-oa.com
Austria	Sharp Electronics (Europe) GMBH Branch Office Austria 0043 1 727 19 123 pogats@sea.sharp-eu.com http://www.sharp.at		

Specifications

Model		XG-C465X/XG-C435X
Display devices		0.8" LCD panel × 3
Resolution		XGA (1024 × 768)
Lens	F number	F 1.7 – 1.9
	Zoom	Manual, ×1.2 (f = 28.0 – 33.6 mm)
	Focus	Manual
Input terminals	DVI-D (Compatible with HDCP)	×1
	Computer/Component (mini D-sub 15 pin)	×2
	S-Video (mini DIN 4 pin)	×1
	Video (RCA)	×1
	Audio (ø3.5 mm stereo minijack)	×2
	Audio (RCA)	×2 (L/R)
Output terminals	Computer/Component (mini D-sub 15 pin)	×1
	Audio (ø3.5 mm stereo minijack)	×1
Control and communication terminals	LAN (RJ-45)	×1
	USB (Type B)	×1
	RS-232C (mini DIN 9 pin)	×1
	Wired Remote (ø3.5 mm stereo minijack)	×1
Speakers		2 W (Mono)
Projection lamp		275 W
Rated voltage		AC 100 – 240 V
Rated frequency		50/60 Hz
Input current		3.6 A
Power consumption (Standby)		360 W (6 W) with AC 100 V 345 W (8 W) with AC 240 V
Operation temperature		41°F to 95°F (+5°C to +35°C)
Cabinet		Plastic
Dimensions (main body only) [W × H × D]		12 ²⁷ / ₃₂ " × 4" × 11 ¹ / ₆₄ " (326 × 101.5 × 279.5 mm)
Weight (approx.)		10.8 lbs. (4.9 kg)

As a part of policy of continuous improvement, SHARP reserves the right to make design and specification changes for product improvement without prior notice. The performance specification figures indicated are nominal values of production units. There may be some deviations from these values in individual units.

Index

2D Progressive	45	MAC Address	54
3D Progressive	45	MAGNIFY buttons	35
AC socket	30	MENU button	42
Adjustment buttons	42	Menu Position	49
All Reset	54	Monitor Output	52
Area Zoom	38	MOUSE/Adjustment buttons	39, 42
Aspect ratio	37, 38	Movie	44
AUDIO input terminal	23-26	Normal	37
Audio Output	52	ON button	30
AUDIO output terminal	29	Optional accessories	10
Auto Keystone	48	Options1	41, 47
Auto Power Off	48	Options2	41, 51
Auto Restart	50	OSD Display	48
Auto Sync (Auto Sync adjustment)	46	Password	51
AUTO SYNC button	46	PDF	6
AV MUTE button	35	Phase	46
Background	48	Picture	40, 44
Blue	44	Picture Mode	44
Border	37	PICTURE MODE button	36
Bright	44	Power cord	30
Clock	46	Power indicator	30
CLR Temp (Color Temperature)	45	Presentation	44
Color	44	PRJ mode	52
COMPUTER/COMPONENT 1 input terminal	23, 25	Progressive	45
COMPUTER/COMPONENT 2 input terminal	23, 25	Projector	54
Contrast	44	R-CLICK/RETURN button	39, 43
DHCP Client	53	Red	44
DIN-D-sub RS-232C adaptor	27	Remote control	14
Dot By Dot	37	Remote control sensor	15
Dynamic Range	45	Remote receiver	39
DVI-D input terminal	24, 25	Replacing the lamp	60
ECO+QUIET button	36	Reset	44
Eco+Quiet Mode	48	Resize	47
ENTER button	43	RESIZE button	37
Exhaust vent	13, 55	Resolution	46
Fan Mode	52	RGB cable	23
Fine Sync	40, 46	RS-232C	52
FREEZE button	35	RS-232C terminal	27
Full	37	Sharp	44
Game	44	Signal Info	46
Gateway	53	Signal Type	45
Height Adjustment button	31	Speaker	52
H-Pos	46	sRGB	44
Image Shift	47	Standard	44
INPUT buttons	34	STANDBY button	30
Intake vent	13, 55	Storage case	20
IP Address	53	Stretch	37
Kensington Security Standard connector	13	Subnet Mask	53
Keypad	49	Supplied accessories	10
Keylock	50	S-VIDEO input terminal	26
KEYSTONE button	32	System Lock	49
Keystone Correction	32, 48	System Sound	49
Lamp	60	TCP/IP	53
Lamp indicator	58	Temperature warning indicator	58
Lamp Timer (Life)	47	Tilt dial	31
LAN terminal	28	Tint	44
Language (on-screen display language)	41, 54	USB terminal	39
LAN/RS232C	52	VIDEO input terminal	26
L-CLICK button	39	Video System	45
Lens cap	12	Volume buttons	35
Lens cap strap	10	V-Pos	46
		V-Stretch	38
		WIRED REMOTE terminal	14

SHARP[®]

SHARP CORPORATION