

# SHARP®

# XV-Z20000/ DT-5000

PROJECTOR  
PROJECTEUR  
PROYECTOR  
PROJETOR

OPERATION MANUAL  
MODE D'EMPLOI  
MANUAL DE MANEJO  
MANUAL DE OPERAÇÃO

ENGLISH

FRANÇAIS

ESPAÑOL

PORTUGUÊS

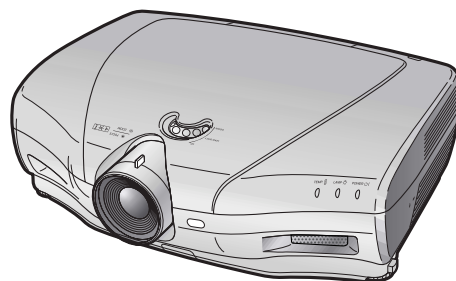
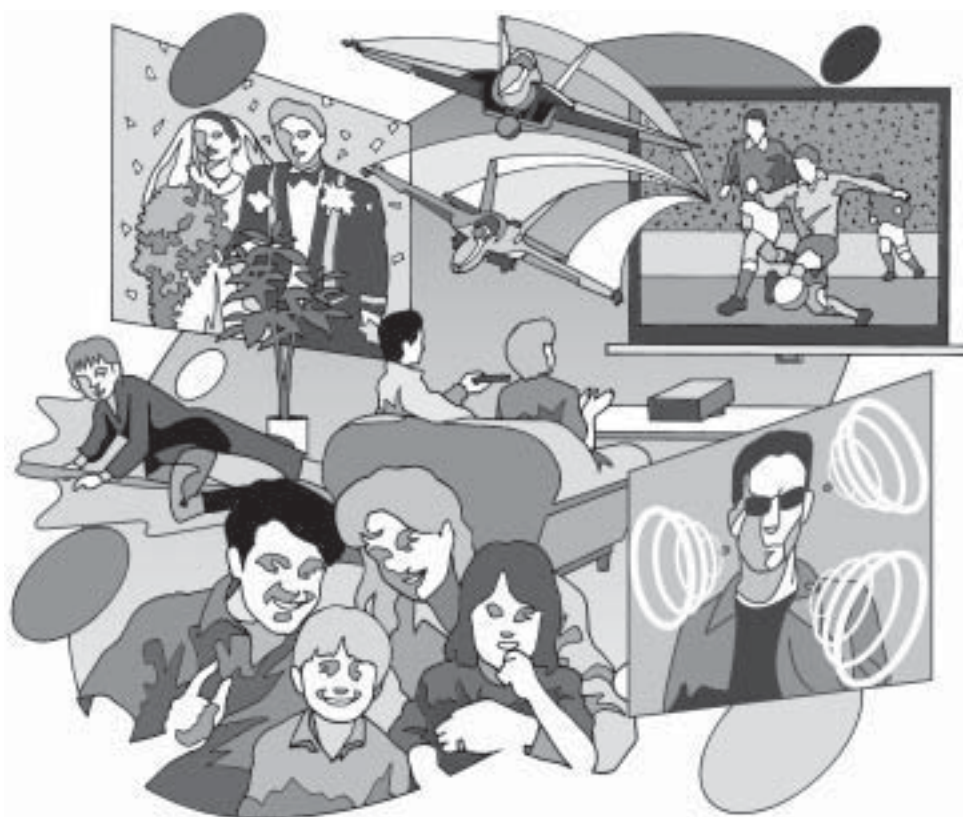

Before using the projector, please read this operation manual carefully.

# Introduction

## IMPORTANT

- For your assistance in reporting the loss or theft of your Projector, please record the Serial Number located on the bottom of the projector and retain this information.
- Before recycling the packaging, please ensure that you have checked the contents of the carton thoroughly against the list of “Supplied accessories” on page 4.

**Model No.:** XV-Z20000/DT-5000

**Serial No.:**

**WARNING:** High brightness light source. Do not stare into the beam of light, or view directly. Be especially careful that children do not stare directly into the beam of light.



**WARNING:** To reduce the risk of fire or electric shock, do not expose this product to rain or moisture.

See bottom of projector.

	<b>CAUTION</b> RISK OF ELECTRIC SHOCK. DO NOT REMOVE SCREWS EXCEPT SPECIFIED USER SERVICE SCREW.	
<b>CAUTION: TO REDUCE THE RISK OF ELECTRIC SHOCK, DO NOT REMOVE COVER. NO USER-SERVICEABLE PARTS EXCEPT LAMP UNIT. REFER SERVICING TO QUALIFIED SERVICE PERSONNEL.</b>		



The lightning flash with arrowhead symbol, within an equilateral triangle, is intended to alert the user to the presence of uninsulated “dangerous voltage” within the product’s enclosure that may be of sufficient magnitude to constitute a risk or electric shock to persons.



The exclamation point within a triangle is intended to alert the user to the presence of important operating and maintenance (servicing) instructions in the literature accompanying the product.

**WARNING:** FCC Regulations state that any unauthorized changes or modifications to this equipment not expressly approved by the manufacturer could void the user’s authority to operate this equipment.

U.S.A. ONLY

## WARNING:

The cooling fan in this projector continues to run for about 90 seconds after the projector enters standby mode. During normal operation, when putting the projector into standby mode always use the STANDBY button on the projector or the STANDBY button on the remote control. Ensure the cooling fan has stopped before disconnecting the power cord.

**DURING NORMAL OPERATION, NEVER TURN THE PROJECTOR OFF BY DISCONNECTING THE POWER CORD. FAILURE TO OBSERVE THIS WILL RESULT IN PREMATURE LAMP FAILURE.**

## INFORMATION

This equipment has been tested and found to comply with the limits for a Class B digital device, pursuant to Part 15 of the FCC Rules. These limits are designed to provide reasonable protection against harmful interference in a residential installation. This equipment generates, uses, and can radiate radio frequency energy and, if not installed and used in accordance with the operation manual, may cause harmful interference to radio communications. However, there is no guarantee that interference will not occur in a particular installation. If this equipment does cause harmful interference to radio or television reception, which can be determined by turning the equipment off and on, the user is encouraged to try to correct the interference by one or more of the following measures:

- Reorient or relocate the receiving antenna.
- Increase the separation between the equipment and the receiver.
- Connect the equipment into an outlet on a circuit different from that to which the receiver is connected.
- Consult the dealer or an experienced radio/TV technician for help.

U.S.A. ONLY

## Declaration of conformity

SHARP PROJECTOR, MODEL XV-Z20000/DT-5000

This device complies with Part 15 of the FCC rules. Operation is subject to the following conditions: (1) This device may not cause harmful interference, and (2) this device must accept any interference received, including interference that may cause undesired operation.

Responsible Party:

SHARP ELECTRONICS CORPORATION  
Sharp Plaza, Mahwah, New Jersey 07430-2135  
TEL: 1-800-BE-SHARP (1-800-237-4277)

U.S.A. ONLY

## PRODUCT DISPOSAL

This projector utilizes tin-lead solder, and a pressurized lamp containing a small amount of mercury. Disposal of these materials may be regulated due to environmental considerations. For disposal or recycling information, please contact your local authorities or, if you are located in the United States of America, the Electronic Industries Alliance: [www.eiae.org](http://www.eiae.org).

## Caution Concerning Lamp Replacement

See "Regarding the Lamp" on page 48.

This SHARP projector uses a DLP® chip. This very sophisticated panel contains 2,073,600 pixels (micromirrors). As with any high technology electronic equipment such as large screen TVs, video systems and video cameras, there are certain acceptable tolerances that the equipment must conform to.

This unit has some inactive pixels within acceptable tolerances which may result in inactive dots on the picture screen. This will not affect the picture quality or the life expectancy of the unit.

- The DLP® logo, the DLP® medallion and BrilliantColor™ are trademarks of Texas Instruments.
- Microsoft® and Windows® are registered trademarks of Microsoft Corporation in the United States and/or other countries.
- PC/AT is a registered trademark of International Business Machines Corporation in the United States.
- Macintosh® is a registered trademark of Apple Computer, Inc. in the United States and/or other countries.
- HDMI, the HDMI logo and High-Definition Multimedia Interface are trademarks or registered trademarks of HDMI Licensing LLC.
- All other company or product names are trademarks or registered trademarks of their respective companies.
- Some IC chips in this product include confidential and/or trade secret property belonging to Texas Instruments. Therefore you may not copy, modify, adapt, translate, distribute, reverse engineer, reverse assemble or discompile the contents thereof.

# Contents

## Preparing

<b>Introduction</b>	
<b>Contents</b> .....	<b>3</b>
<b>Accessories</b> .....	<b>4</b>
<b>IMPORTANT SAFEGUARDS</b> .....	<b>5</b>
<b>Part Names and Functions</b> .....	<b>8</b>
<b>Using the Remote Control</b> .....	<b>11</b>
Inserting the Batteries.....	11
Usable Range .....	11
<b>Quick Start</b>	
<b>Quick Start</b> .....	<b>12</b>

## Setup

<b>Setting Up the Projector</b> .....	<b>14</b>
Setting Up the Projector .....	14
Standard Setup (Front Projection).....	14
Projection (PRJ) Mode.....	15
Ceiling-mount Setup .....	15
Picture (Screen) Size and Projection Distance.....	16

## Connections

<b>Samples of Cables for Connection</b> .....	<b>17</b>
<b>Connecting to Video Equipment</b> .....	<b>18</b>
<b>Connecting to a Computer</b> .....	<b>23</b>
<b>Controlling the Projector by a Computer</b> .....	<b>24</b>

## Using

### Basic Operation

<b>Turning the Projector On/Off</b> .....	<b>25</b>
Connecting the Power Cord .....	25
Turning the Projector On .....	25
Turning the Power Off (Putting the Projector into Standby Mode).....	26
<b>Image Projection</b> .....	<b>27</b>
Switching the Input Mode.....	27
Adjusting the Projected Image.....	27
<b>Operating with the Remote Control</b> .....	<b>29</b>
Switching the Iris Setting .....	29
Adjusting the Contrast.....	29
Adjusting the Quantity of Light.....	29
Freezing a Moving Image.....	29
Selecting the Picture Mode .....	29
<b>Selecting the Screen Size</b> .....	<b>30</b>
Resize Mode .....	30

### Useful Features

<b>Menu Bar Items</b> .....	<b>32</b>
<b>Using the Menu Screen</b> .....	<b>34</b>
Menu Selections (Adjustments) .....	34
<b>Picture Adjustment (“Picture” Menu)</b> .....	<b>36</b>
Selecting the Picture Mode .....	36
Adjusting the Image .....	36
Selecting the Gamma Position .....	37
Switching the Iris Setting .....	37
Lamp Setting .....	37
Using the Advanced .....	37
Adjusting the Colors .....	37
Adjusting the BrilliantColor™ .....	38
Selecting the Progressive Mode .....	38

Selecting the Film Mode.....	38
Reducing Image Noise (DNR) .....	38
Mosquito Noise Reduction (MNR) .....	38
Adjusting the Unveil Control .....	39
Adjusting the Automatic Contrast .....	39
Resetting All Adjustment Items .....	39
<b>Gamma Adjustment (“Gamma” Menu)</b> .....	<b>40</b>
Selecting the Gamma Position .....	40
Adjusting the Gamma.....	40
<b>Computer Image Adjustment (“Fine Sync” Menu)</b> .....	<b>41</b>
Adjusting the Computer Image .....	41
Special Modes Setting .....	41
Checking the Input Signal.....	41
Auto Sync (Auto Sync Adjustment) .....	41
<b>Using the “Options” Menu</b> .....	<b>42</b>
Adjusting the Image Position .....	42
Adjusting the Vertical Size of the Display (Subtitle Setting).....	42
Adjusting the Overscan .....	42
Adjusting the White Level/Black Level .....	43
Turning LED Off.....	43
Checking the Lamp Life Status.....	43
Setting On-screen Display .....	43
Setting the Video System .....	43
Signal Type Setting.....	44
Adjusting the Color Space.....	44
Adjusting the Dynamic Range .....	44
Selecting the Background Image.....	44
Adjusting the Economy Mode .....	44
Selecting the Transmission Speed (RS-232C).....	45
Fan Mode Setting.....	45
Reversing/Inverting Projected Images.....	45
Returning to the Default Settings .....	45
<b>Other Function</b> .....	<b>45</b>
Selecting the On-screen Display Language .....	45

## Reference

### Appendix



<b>Maintenance Indicators/Maintenance</b> .....	<b>46</b>
<b>Regarding the Lamp</b> .....	<b>48</b>
Lamp .....	48
Caution Concerning the Lamp.....	48
Replacing the Lamp .....	48
Removing and Installing the Lamp Unit.....	49
Resetting the Lamp Timer .....	50
<b>Connecting Pin Assignments</b> .....	<b>51</b>
<b>RS-232C Specifications and Command Settings</b> .....	<b>52</b>

### Wired Remote Control Terminal

<b>Specifications</b> .....	<b>59</b>
<b>Computer Compatibility Chart</b> .....	<b>60</b>
<b>Troubleshooting</b> .....	<b>61</b>
<b>Service Information (for the U.S.)</b> .....	<b>62</b>
<b>Specifications</b> .....	<b>63</b>
<b>Dimensions</b> .....	<b>64</b>
<b>Index</b> .....	<b>65</b>
<b>CONSUMER LIMITED WARRANTY (VALID IN USA ONLY)</b> .....	<b>66</b>
<b>LIMITED WARRANTY (VALID IN CANADA ONLY)</b> .....	<b>67</b>

# Accessories

## Supplied accessories

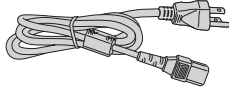
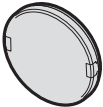
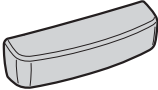
	<p>Remote control</p> <ul style="list-style-type: none"> <li>• RRMCGA500WJSA for XV-Z20000</li> <li>• RRMCGA500WJSB for DT-5000</li> </ul>		<p>Two AA size batteries</p>		<p>Power cord (6' (1.8 m)) QACCGA007WJPZ</p>
	<p>Lens cap (attached) PCAPH1056CESA</p>		<p>Terminal cover</p> <ul style="list-style-type: none"> <li>• GCOVAB677WJKA for XV-Z20000</li> <li>• GCOVAB677WJKB for DT-5000</li> </ul>	<p>Operation manual</p>	

## Optional accessories

<ul style="list-style-type: none"> <li>■ Lamp unit</li> </ul>	<p>AN-K20LP</p>
<ul style="list-style-type: none"> <li>■ 3 RCA to 15-pin D-sub cable (9'10" (3.0 m))</li> </ul>	<p>AN-C3CP2</p>
<ul style="list-style-type: none"> <li>■ DVI to 15-pin D-sub adaptor (7.9" (20 cm))</li> </ul>	<p>AN-A1DV</p>
<ul style="list-style-type: none"> <li>■ DVI cable (9'10" (3.0 m))</li> </ul>	<p>AN-C3DV</p>

### Note

- Some of the optional accessories may not be available depending on the region. Please check with your nearest Sharp Authorized Service Center or Dealer.

## Marks Used in This Operation Manual

 **Info** ..... Indicates safeguards when using the projector.

 **Note** ..... Indicates additional information for setting up and operating the projector.

- In this operation manual, the illustration and the screen display are simplified for explanation, and may differ slightly from actual display.

## For Future Reference

Maintenance

➔ P. 46 and 47

Troubleshooting

➔ P. 61 and 62

Index

➔ P. 65

# IMPORTANT SAFEGUARDS

**CAUTION:** Please read all of these instructions before you operate this product and save these instructions for later use.

Electrical energy can perform many useful functions. This product has been engineered and manufactured to assure your personal safety. BUT IMPROPER USE CAN RESULT IN POTENTIAL ELECTRICAL SHOCK OR FIRE HAZARDS. In order not to defeat the safeguards incorporated in this product, observe the following basic rules for its installation, use and servicing.

## 1. Read Instructions

All the safety and operating instructions should be read before the product is operated.

## 2. Retain Instructions

The safety and operating instructions should be retained for future reference.

## 3. Heed Warnings

All warnings on the product and in the operating instructions should be adhered to.

## 4. Follow Instructions

All operating and use instructions should be followed.

## 5. Cleaning

Unplug this product from the wall outlet before cleaning. Do not use liquid cleaners or aerosol cleaners. Use a damp cloth for cleaning.

## 6. Attachments

Do not use attachments not recommended by the product manufacturer as they may cause hazards.

## 7. Water and Moisture

Do not use this product near water—for example, near a bath tub, wash bowl, kitchen sink, or laundry tub; in a wet basement; or near a swimming pool; and the like.

## 8. Accessories

Do not place this product on an unstable cart, stand, tripod, bracket, or table. The product may fall, causing serious injury to a child or adult, and serious damage to the product. Use only with a cart, stand, tripod, bracket, or table recommended by the manufacturer, or sold with the product. Any mounting of the product should follow the manufacturer's instructions, and should use a mounting accessory recommended by the manufacturer.

## 9. Transportation

A product and cart combination should be moved with care. Quick stops, excessive force, and uneven surfaces may cause the product and cart combination to overturn.



## 10. Ventilation

Slots and openings in the cabinet are provided for ventilation to ensure reliable operation of the product and to protect it from overheating, and these openings must not be blocked or covered. The openings should never be blocked by placing the product on a bed, sofa, rug, or other similar surface. This product should not be placed in a built-in installation such as a bookcase or rack unless proper ventilation is provided or the manufacturer's instructions have been adhered to.

## 11. Power Sources

This product should be operated only from the type of power source indicated on the marking label. If you are not sure of the type of power supply to your home, consult your product dealer or local power company. For products intended to operate from battery power, or other sources, refer to the operating instructions.

## 12. Grounding or Polarization

This product is provided with one of the following types of plugs. If the plug should fail to fit into the power outlet, please contact your electrician.

Do not defeat the safety purpose of the plug.

- Two-wire type (mains) plug.
- Three-wire grounding type (mains) plug with a grounding terminal.  
This plug will only fit into a grounding type power outlet.

## 13. Power-Cord Protection

Power-supply cords should be routed so that they are not likely to be walked on or pinched by items placed upon or against them, paying particular attention to cords at plugs, convenience receptacles, and the point where they exit from the product.

## 14. Lightning

For added protection for this product during a lightning storm, or when it is left unattended and unused for long periods of time, unplug it from the wall outlet and disconnect the cable system. This will prevent damage to the product due to lightning and power-line surges.

## 15. Overloading

Do not overload wall outlets, extension cords, or integral convenience receptacles as this can result in a risk of fire or electric shock.

## 16. Object and Liquid Entry

Never push objects of any kind into this product through openings as they may touch dangerous voltage points or short-out parts that could result in a fire or electric shock. Never spill liquid of any kind on the product.

## 17. Servicing

Do not attempt to service this product yourself as opening or removing covers may expose you to dangerous voltage or other hazards. Refer all servicing to qualified service personnel.

## 18. Damage Requiring Service

Unplug this product from the wall outlet and refer servicing to qualified service personnel under the following conditions:

- When the power-supply cord or plug is damaged.
- If liquid has been spilled, or objects have fallen into the product.
- If the product has been exposed to rain or water.
- If the product does not operate normally by following the operating instructions. Adjust only those controls that are covered by the operating instructions, as an improper adjustment of other controls may result in damage and will often require extensive work by a qualified technician to restore the product to normal operation.
- If the product has been dropped or damaged in any way.
- When the product exhibits a distinct change in performance, this indicates a need for service.

## 19. Replacement Parts

When replacement parts are required, ensure the service technician has used replacement parts specified by the manufacturer or have the same characteristics as the original part. Unauthorized substitutions may result in fire, electric shock, or other hazards.

## 20. Safety Check

Upon completion of any service or repairs to this product, ask the service technician to perform safety checks to determine that the product is in proper operating condition.

## 21. Wall or Ceiling Mounting

This product should be mounted to a wall or ceiling only as recommended by the manufacturer.

## 22. Heat

This product should be situated away from heat sources such as radiators, heat registers, stoves, or other products (including amplifiers) that produce heat.

## Observe the following safeguards when setting up your projector.

### Caution concerning the lamp unit

- Potential hazard of glass particles if lamp ruptures. In case of lamp rupture, contact your nearest Sharp Authorized Service Center or Dealer for replacement. See “Regarding the Lamp” on page 48.

### Caution concerning the setup of the projector

- For minimal servicing and to maintain high image quality, SHARP recommends that this projector be installed in an area free from humidity, dust and cigarette smoke. When the projector is subjected to these environments, the vents and lens must be cleaned more often. As long as the projector is regularly cleaned, use in these environments will not reduce the overall operation life of the unit. Internal cleaning should only be performed by a Sharp Authorized Service Center or Dealer.

### Do not set up the projector in places exposed to direct sunlight or bright light.

- Position the screen so that it is not in direct sunlight or room light. Light falling directly on the screen washes out the colors, making viewing difficult. Close the curtains and dim the lights when setting up the screen in a sunny or bright room.

### Caution regarding placing of the projector

- Place the projector on a level site within the adjustment range ( $\pm 5$  degrees) of the adjustment foot.

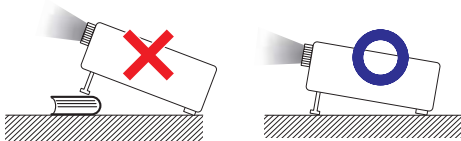

- After the projector is purchased, a faint smell from the vent may appear when the power is first turned on. This is normal and is not a malfunction. It will disappear after the projector is used for a while.

### When using the projector in high-altitude areas such as mountains (at altitudes of approximately 4,900 feet (1,500 meters) or more)

- When you use the projector in high-altitude areas with thin air, set “Fan Mode” to “High”. Neglecting this can affect the longevity of the optical system.

### Warning about placing the projector in a high position

- When placing the projector in a high position, ensure that it is secured carefully to avoid personal injury caused by the projector falling down.

### Do not subject the projector to hard impact and/or vibration.

- Protect the lens so as not to hit or damage the surface of the lens.

### Rest your eyes occasionally.

- Continuously watching the screen for long hours will cause eye strain. Be sure to occasionally rest your eyes.

### Avoid locations with extremes of temperature.

- The operating temperature of the projector is from 41°F to 95°F (+5°C to +35°C).
- The storage temperature of the projector is from -4°F to 140°F (-20°C to +60°C).

### Do not block the exhaust and intake vents.

- Allow at least  $1\frac{13}{16}$  inches (30 cm) of space between the exhaust vent and the nearest wall or obstruction.
- Be sure that the intake vent and the exhaust vent are not obstructed.
- If the cooling fan becomes obstructed, a protection circuit will automatically put the projector into standby mode to prevent overheating damage. This does not indicate a malfunction. (See page 46.) Remove the projector power cord from the wall outlet and wait at least 10 minutes. Place the projector where the intake and exhaust vents are not blocked, plug the power cord back in and turn on the projector. This will return the projector to the normal operating condition.
- When turning off the projector, the cooling fan runs to decrease the internal temperature for a while. Unplug the power cord after the cooling fan stops. The period the cooling fan runs will vary, depending on the circumstances and the internal temperature.

### Caution regarding usage of the projector

- When using the projector, be sure not to subject it to hard impact and/or vibration, as this can result in damage. Take extra care with the lens. Before moving the projector, be sure to unplug the power cord from the wall outlet, and disconnect any other cables connected to it.
- Do not carry the projector by holding the lens.
- When storing the projector, re-attach the lens cap. (See page 8.)
- Do not expose the projector to direct sunlight or place next to heat sources. Doing so may affect the cabinet color or cause deformation of the plastic cover.

### Other connected equipment

- When connecting a computer or other audio-visual equipment to the projector, make the connections AFTER unplugging the power cord of the projector from the AC outlet and turning off the equipment.
- Please read the operation manuals of the projector and the equipment to be connected for instructions on how to make the connections.

### Using the projector in other countries

- The power supply voltage and the shape of the plug may vary depending on the region or country you are using the projector in. When using the projector overseas, be sure to use an appropriate power cord for the country you are in.

### Temperature monitor function



- If the projector starts to overheat due to setup problems or blockage of the air vents, “X” and “TEMP.” will illuminate in the lower left corner of the picture. If the temperature continues to rise, the lamp will turn off, the temperature warning indicator on the projector will blink, and after a 90-second cooling-off period the projector will enter standby mode. Refer to “Maintenance Indicators/Maintenance” on page 46 for details.

#### Info

- The cooling fan regulates the internal temperature, and its performance is automatically controlled. The sound of the fan may change during projector operation due to changes in the fan speed. This does not indicate malfunction.
- Do not unplug the power cord during projection or cooling fan operation. This can cause damage due to rise in internal temperature, as the cooling fan also stops.



# Part Names and Functions

Numbers in  refer to the main pages in this operation manual where the topic is explained.

## Projector

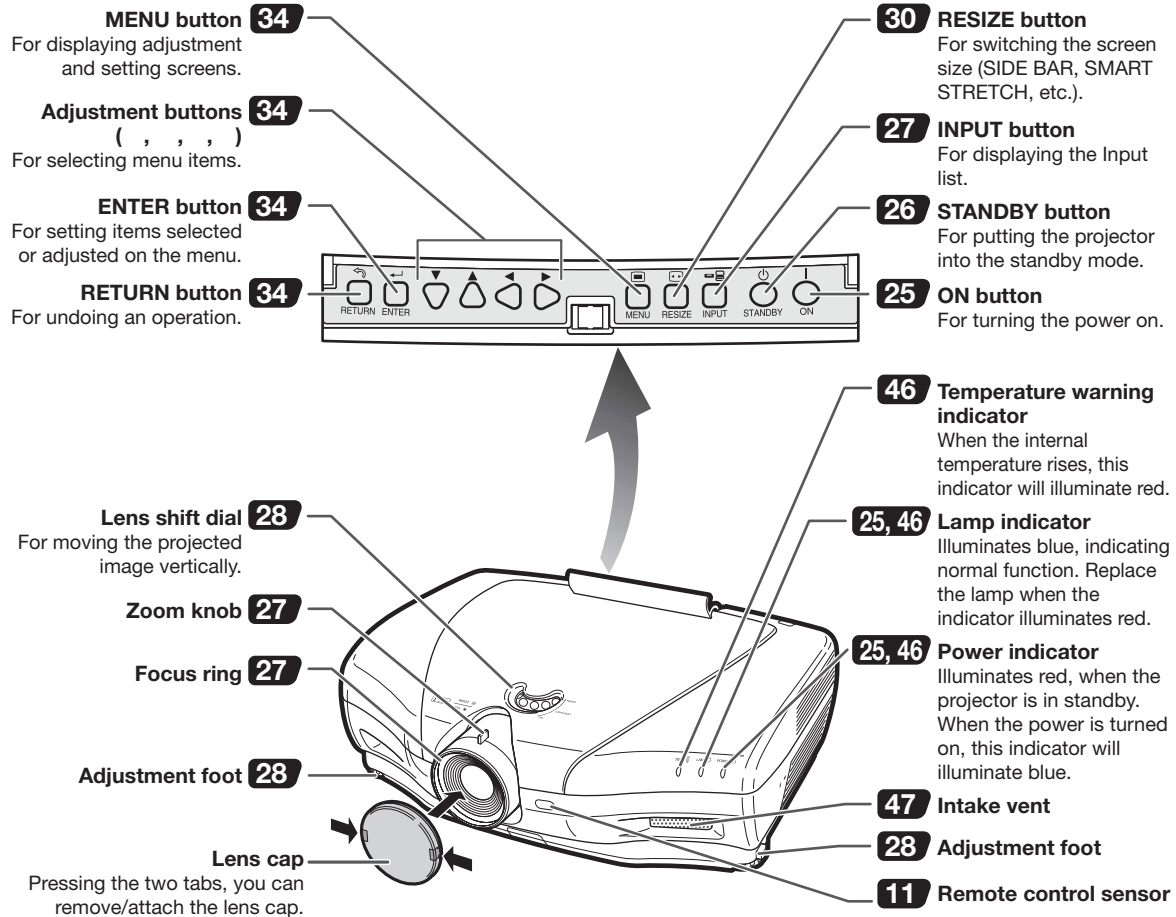

### Using the Terminal Cover

When the projector is used on a desktop, high mounted or ceiling mounted, attach the terminal cover (supplied) to hide the connecting cables.

#### Attaching the Terminal Cover

Align the hook on the terminal cover with the insert hole in the hook at the back of the projector.

Press the hook in the direction indicated with the arrow to fasten the terminal cover to the projector.

Insert the terminal cover into the mounting groove on the projector while pushing the tabs inside the terminal cover to the outside with your fingers.

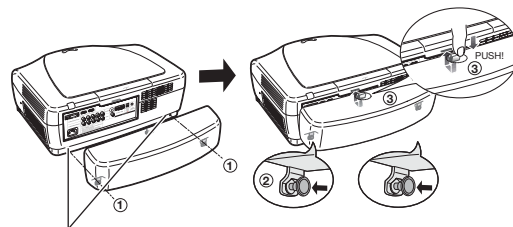

Remove the rubber cap attached on the projector and attach the hooks.

## Projector (Rear View)

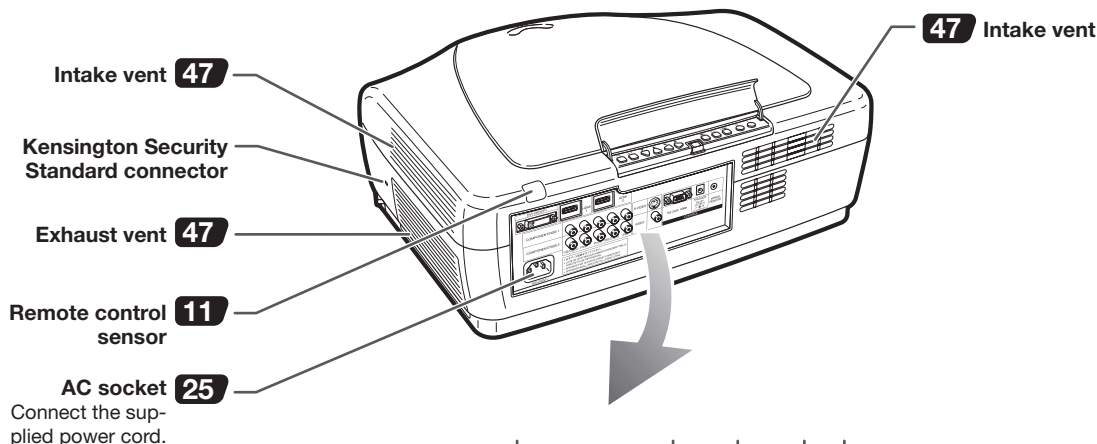

### Terminals

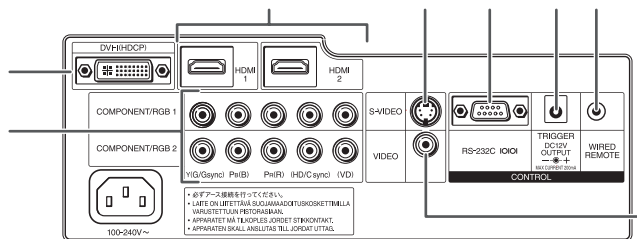

Terminal	Description	Page
<b>COMPONENT/RGB1, 2 terminals</b>	Connecting video equipment with component output terminal (DVD player, etc.) or a computer with analog RGB output terminal.	<b>20, 21</b>
<b>S-VIDEO terminal</b>	Connecting video equipment with S-video output terminal (DVD player, VCR, etc.).	<b>22</b>
<b>VIDEO terminal</b>	Connecting video equipment without S-video output terminal.	<b>22</b>
<b>DVI terminal</b>	Connecting video equipment with DVI output terminal (DVD player, DTV decoder, computer, etc.).	<b>18-20, 23</b>
<b>HDMI1, 2 terminals</b>	Connecting video equipment with HDMI output terminal.	<b>18</b>
<b>RS-232C terminal</b>	Connecting a computer to control the projector.	<b>24</b>
<b>TRIGGER terminal</b>	When the projector is turned on, a control signal (DC 12V) outputs from this terminal. If an electric screen or other compatible device is connected, it can be turned on when the projector is turned on.	—
<b>WIRED REMOTE control input terminal</b>	Connecting the remote control via a cable when the projector is placed out of the reach of remote control signals.	<b>10</b>

**Using the Kensington Lock**

- This projector has a Kensington Security Standard connector for use with a Kensington MicroSaver Security System. Refer to the information that came with the system for instructions on how to use it to secure the projector.



# Part Names and Functions (Continued)

Numbers in **[ ]** refer to the main pages in this operation manual where the topic is explained.

## Remote Control

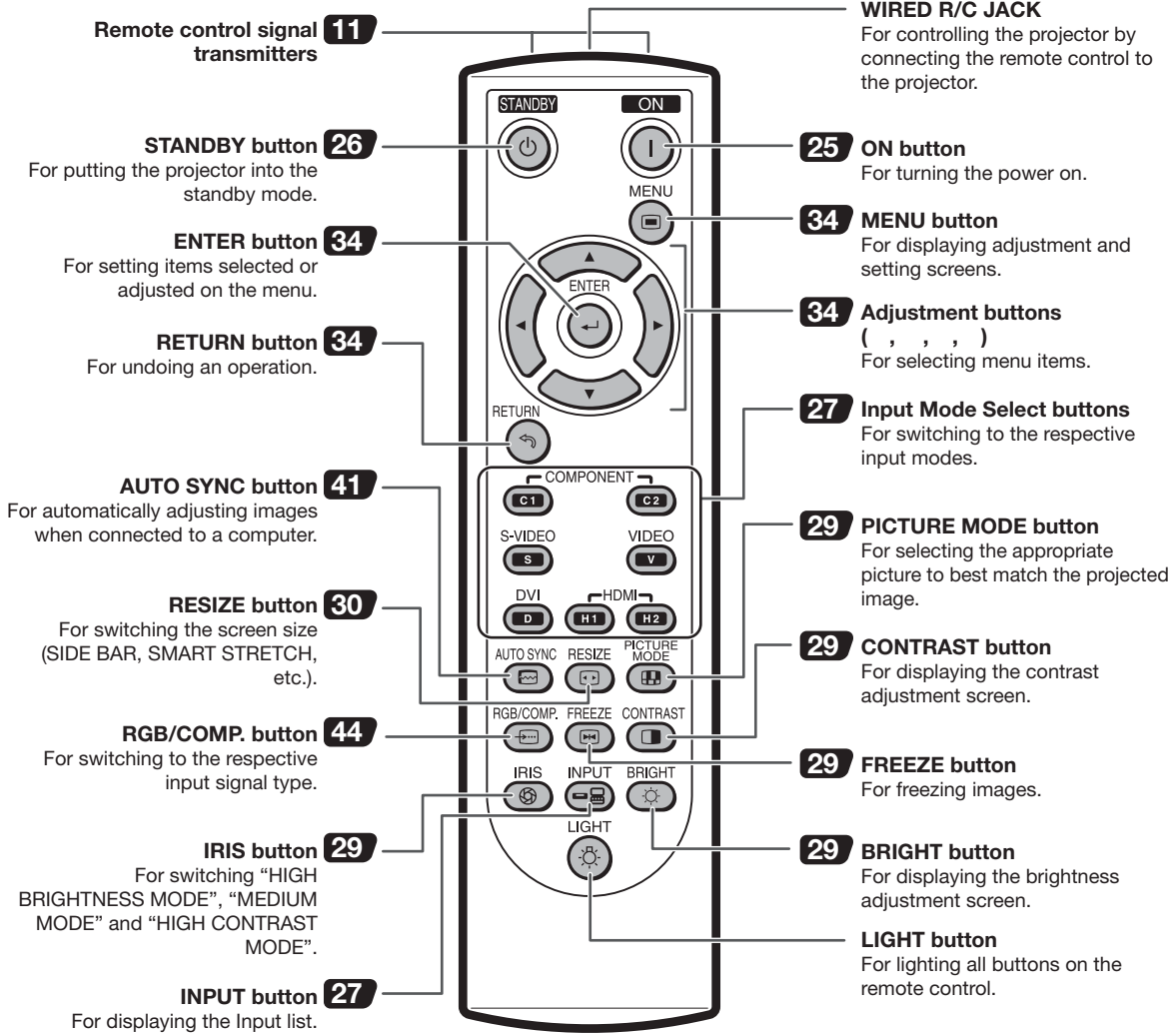

### Connecting the Remote Control to the Projector

When the remote control cannot be used due to the range or positioning of the projector, connect a  $\varnothing 3.5$  mm minijack cable (commercially available) from the WIRED R/C JACK on the top of the remote control to the WIRED REMOTE control input terminal on the rear of the projector.

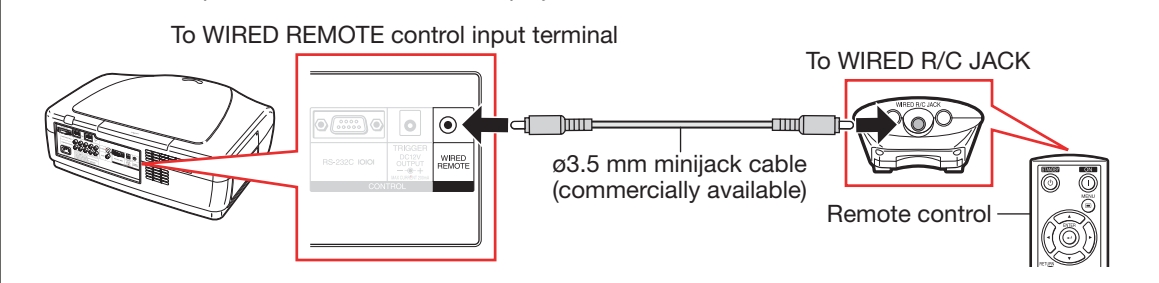

# Using the Remote Control

## Inserting the Batteries

**1** Pull down the tab on the cover and remove the cover towards the direction of the arrow.

**2** Insert the supplied batteries and put back the cover.

- Make sure the polarities correctly match the  $\oplus$  and  $\ominus$  marks inside the battery compartment.
- When putting back the cover, be sure that the cover clicks in place and settles.

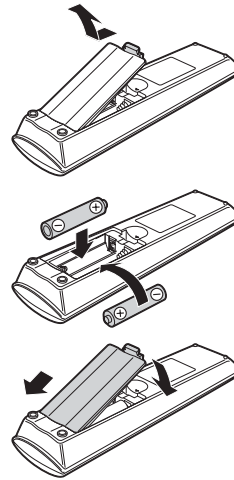

## Usable Range

The remote control can be used to control the projector within the ranges shown in the illustration.

### Note

- The signal from the remote control can be reflected off a screen for easy operation. However, the effective distance of the signal may differ depending on the screen material.

### When using the remote control:

- Be sure not to drop, expose to moisture or high temperature.
- The remote control may malfunction under a fluorescent lamp. In this case, move the projector away from the fluorescent lamp.

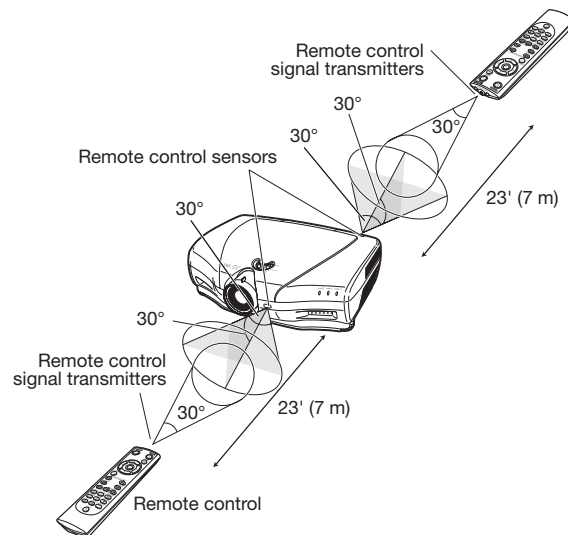

**Incorrect use of the batteries may cause them to leak or explode. Please follow the precautions below.**

### ⚠ Caution

- Danger of explosion if battery is incorrectly replaced.  
Replace only with the same or equivalent type.
- Insert the batteries making sure the polarities correctly match the  $\oplus$  and  $\ominus$  marks inside the battery compartment.
- Batteries of different types have different properties, therefore do not mix batteries of different types.
- Do not mix new and old batteries.  
This may shorten the life of new batteries or may cause old batteries to leak.
- Remove the batteries from the remote control once they have run out, as leaving them in can cause them to leak.  
Battery fluid from leaked batteries is harmful to skin, therefore be sure to first wipe them and then remove them using a cloth.
- The batteries included with this projector may run down in a short period, depending on how they are kept.  
Be sure to replace them as soon as possible with new batteries.
- Remove the batteries from the remote control if you are not to use the remote control for a long time.
- Comply with the rules (ordinance) of each local government when disposing of worn-out batteries.

# Quick Start

This section provides an example showing how to connect the projector to video equipment with a brief explanation of the steps from connection through to image projection. For details, see the pages suggested in each step.

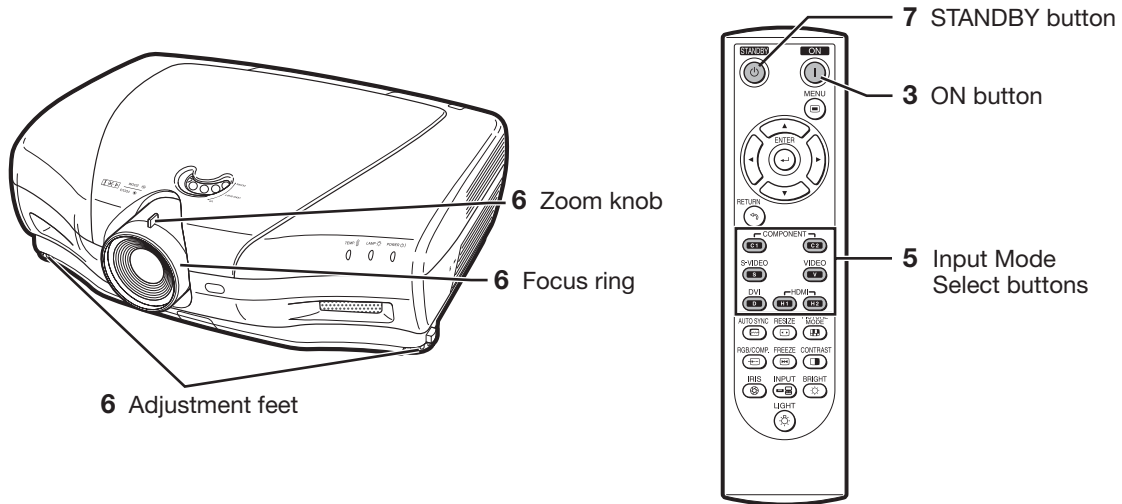

## 1. Place the projector facing a screen → Page 14

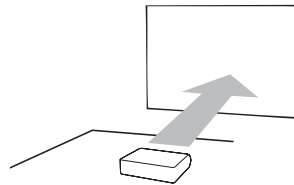

## 2. Connect the projector to the video equipment and plug the power cord into the AC socket of the projector → Pages 18-25

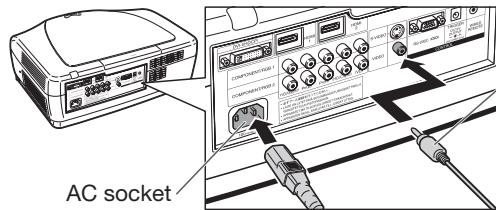

Connect the audio output terminal of the video equipment to the audio input terminal of the audio equipment using an audio cable.

## 3. Remove the lens cap and turn the projector on → Page 25

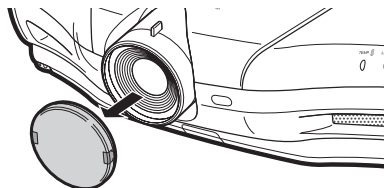

Pointing the remote control towards the projector, press the ① ON button.



## 4. Turn the video equipment on and start playback

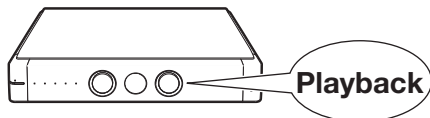

## 5. Select the input mode

→ Page 27

Press the **VIDEO** button on the remote control to select "VIDEO" for the Input mode.



• Press **CH1/CH2/S/VIDEO/CH1/CH2** on the remote control to switch the Input mode.

## 6. Adjust the projector angle, focus and zoom

→ Pages 27, 28

1. The focus is adjusted by rotating the focus ring.

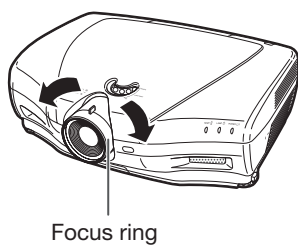

2. Zooming is adjusted by moving the zoom knob.

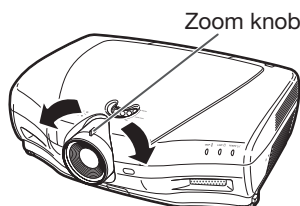

3. The projector angle is adjusted by using the adjustment feet. As for adjustment of the vertical position of the projected image, use the lens shift dial.

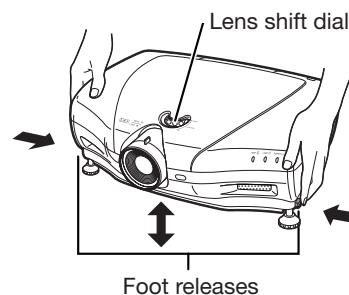

## 7. Turn the power off

→ Page 26

Press **STANDBY** on the remote control, then press that button again while the confirmation message is displayed, to put the projector into standby mode.

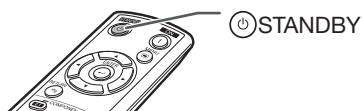

### On-screen display

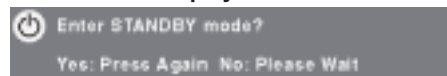

• Unplug the power cord from the AC outlet after the cooling fan stops.

# Setting Up the Projector

## Setting Up the Projector

For optimal image quality, position the projector perpendicular to the screen with the projector's feet flat and level.

### Note

- The projector lens should be centered in the middle of the screen. If the horizontal line passing through the lens center is not perpendicular to the screen, the image will be distorted, making viewing difficult.
- For optimal image, position the screen so that it is not in direct sunlight or room light. Light falling directly on the screen washes out the colors, making viewing difficult. Close the curtains and dim the lights when setting up the screen in a sunny or bright room.
- A polarizing screen cannot be used with this projector.

## Standard Setup (Front Projection)

- Place the projector at the required distance from the screen according to the desired picture size.

### Example of standard setup

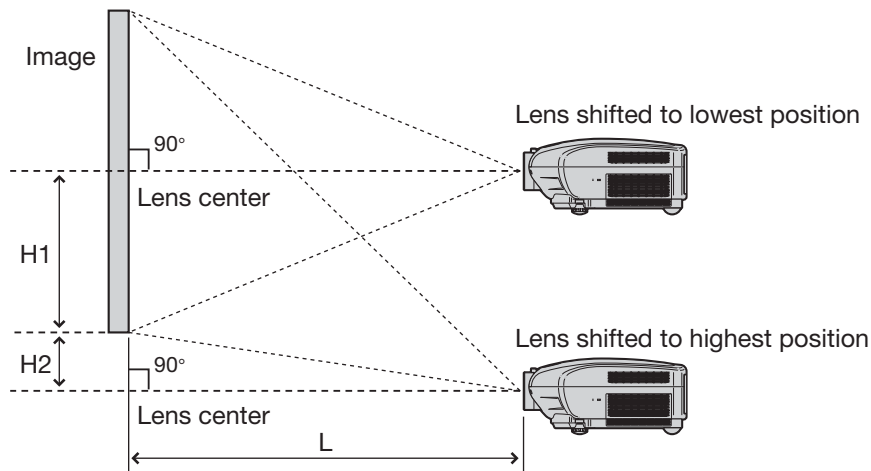

- L : Projection distance
- H1: Distance from the lens center to the bottom of the image (when the lens is shifted to the lowest position)
- H2: Distance from the lens center to the bottom of the image (when the lens is shifted to the highest position)

### Note

- For details, refer to "Picture (Screen) Size and Projection Distance" on page 16.

## Projection (PRJ) Mode

The projector can use any of the 4 projection modes, shown in the diagram below. Select the mode most appropriate for the projection setting in use. (You can set the PRJ Mode in "Options" menu. See page 45.)

- Table mounted, front projection

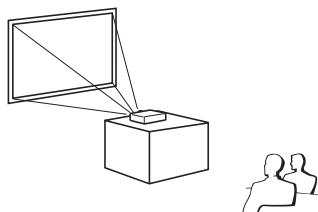

Menu item → "Front"

- Ceiling mounted, front projection

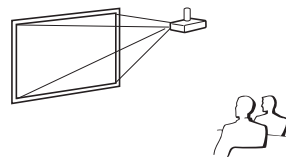

Menu item → "Ceiling + Front"

- Table mounted, rear projection (with a translucent screen)

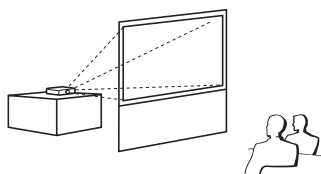

Menu item → "Rear"

- Ceiling mounted, rear projection (with a translucent screen)

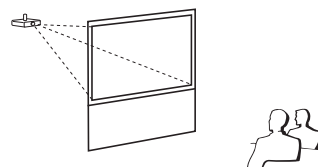

Menu item → "Ceiling + Rear"

## Ceiling-mount Setup

- It is recommended that you use the optional Sharp ceiling-mount bracket for this installation. Before mounting the projector, contact your nearest Sharp Authorized Service Center or Dealer to obtain the recommended ceiling-mount bracket (sold separately).
  - AN-CM250 ceiling-mount bracket (for U.S.A.).
  - AN-NV6T ceiling-mount bracket, its AN-TK201 and AN-TK202 extension tubes (for countries other than the U.S.A.).
- Invert the image by setting "Ceiling + Front" in "PRJ Mode". See page 45 for use of this function.

### Indication of the Projection Image Size and Projection Distance

For details, refer to "Picture (Screen) Size and Projection Distance" on page 16.

Example : When using a wide screen (16:9)

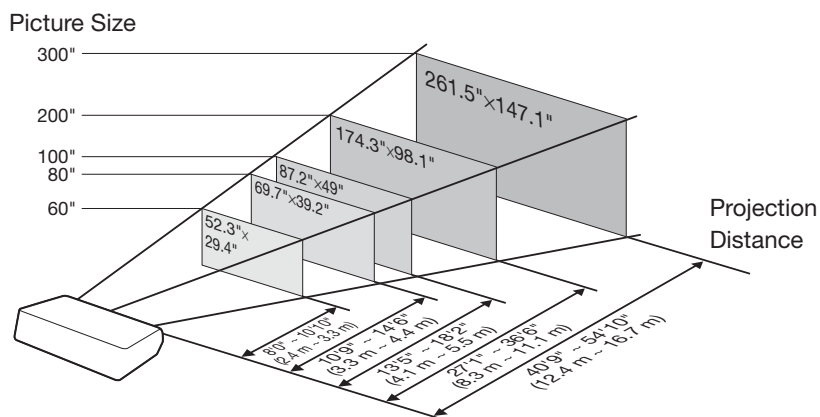



## Setting Up the Projector (Continued)

### Picture (Screen) Size and Projection Distance

The projection screen size varies according to the distance from the lens of the projector to the screen. Install the projector so that projected images are projected onto the screen at the optimum size by referring to the table below. Use the values in the table as a reference when installing the projector.

**When using a wide screen (16:9):** In case of displaying the 16:9 picture on the whole of the 16:9 screen.

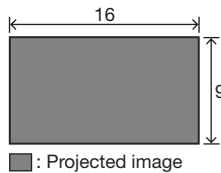

Picture (Screen) size			Projection distance [L]		Distance from the lens center to the bottom of the image [H]	
Diag. (x)	Width	Height	Maximum [L1]	Minimum [L2]	Lower [H1]	Upper [H2]
300"	261.5" (6.6 m)	147.1" (3.7 m)	54'10" (16.7 m)	40'9" (12.4 m)	-147" (-374 cm)	0" (0 cm)
250"	217.9" (5.5 m)	122.6" (3.1 m)	45'8" (13.9 m)	33'11" (10.3 m)	-122" (-311 cm)	0" (0 cm)
200"	174.3" (4.4 m)	98.1" (2.5 m)	36'6" (11.1 m)	27'1" (8.3 m)	-98" (-249 cm)	0" (0 cm)
150"	130.7" (3.3 m)	73.5" (1.9 m)	27'4" (8.3 m)	20'3" (6.2 m)	-73" (-187 cm)	0" (0 cm)
120"	104.6" (2.7 m)	58.8" (1.5 m)	21'10" (6.7 m)	16'2" (4.9 m)	-58" (-149 cm)	0" (0 cm)
110"	95.9" (2.4 m)	53.9" (1.4 m)	20'0" (6.1 m)	14'10" (4.5 m)	-53" (-137 cm)	0" (0 cm)
100"	87.2" (2.2 m)	49" (1.2 m)	18'2" (5.5 m)	13'5" (4.1 m)	-49" (-125 cm)	0" (0 cm)
80"	69.7" (1.8 m)	39.2" (1.0 m)	14'6" (4.4 m)	10'9" (3.3 m)	-39" (-100 cm)	0" (0 cm)
60"	52.3" (1.3 m)	29.4" (0.7 m)	10'10" (3.3 m)	8'0" (2.4 m)	-29" (-75 cm)	0" (0 cm)
40"	34.9" (0.9 m)	19.6" (0.5 m)	7'2" (2.2 m)	5'3" (1.6 m)	-19" (-50 cm)	0" (0 cm)

x : Picture size (diag.) (inches)

L1 : Maximum Projection distance (ft/m)

L2 : Minimum Projection distance (ft/m)

The formula for picture size and projection distance

$$L1 = (0.05593x - 0.05550)/0.3048 \text{ (ft)} \quad H1 = -1.2453x/2.54 \text{ (in)}$$

$$L2 = (0.04158x - 0.05665)/0.3048 \text{ (ft)} \quad H2 = 0$$

**When using a normal screen (4:3) and projecting 4:3 image (SIDE BAR Mode)**

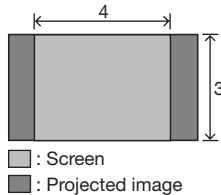

Picture (Screen) size			Projection distance [L]		Distance from the lens center to the bottom of the image [H]	
Diag. (x)	Width	Height	Maximum [L1]	Minimum [L2]	Lower [H1]	Upper [H2]
250"	200" (5.1 m)	150" (3.8 m)	56'0" (17.1 m)	41'7" (12.7 m)	-150" (-381 cm)	0" (0 cm)
200"	160" (4.1 m)	120" (3.0 m)	44'9" (13.6 m)	33'2" (10.1 m)	-120" (-305 cm)	0" (0 cm)
150"	120" (3.0 m)	90" (2.3 m)	33'6" (10.2 m)	24'10" (7.6 m)	-90" (-229 cm)	0" (0 cm)
120"	96" (2.4 m)	72" (1.8 m)	26'9" (8.2 m)	19'10" (6.1 m)	-72" (-183 cm)	0" (0 cm)
110"	88" (2.2 m)	66" (1.7 m)	24'6" (7.5 m)	18'2" (5.5 m)	-66" (-168 cm)	0" (0 cm)
100"	80" (2.0 m)	60" (1.5 m)	22'3" (6.8 m)	16'6" (5.0 m)	-60" (-152 cm)	0" (0 cm)
80"	64" (1.6 m)	48" (1.2 m)	17'9" (5.4 m)	13'2" (4.0 m)	-48" (-122 cm)	0" (0 cm)
60"	48" (1.2 m)	36" (0.9 m)	13'4" (4.1 m)	9'10" (3.0 m)	-36" (-91 cm)	0" (0 cm)

x : Picture size (diag.) (inches)

L1 : Maximum Projection distance (ft/m)

L2 : Minimum Projection distance (ft/m)

The formula for picture size and projection distance

$$L1 = (0.06845x - 0.05550)/0.3048 \text{ (ft)} \quad H1 = -1.524x/2.54 \text{ (in)}$$

$$L2 = (0.05089x - 0.05665)/0.3048 \text{ (ft)} \quad H2 = 0$$

**When using a normal screen (4:3):** In case of setting the 16:9 picture to the full horizontal width of the 4:3 screen.

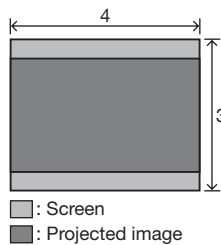

Picture (Screen) size			Projection distance [L]		Distance from the lens center to the bottom of the image [H]	
Diag. (x)	Width	Height	Maximum [L1]	Minimum [L2]	Lower [H1]	Upper [H2]
250"	200" (5.1 m)	150" (3.8 m)	41'11" (12.8 m)	31'1" (9.5 m)	-112" (-286 cm)	0" (0 cm)
200"	160" (4.1 m)	120" (3.0 m)	33'6" (10.2 m)	24'10" (7.6 m)	-90" (-229 cm)	0" (0 cm)
150"	120" (3.0 m)	90" (2.3 m)	25'1" (7.6 m)	18'7" (5.7 m)	-67" (-171 cm)	0" (0 cm)
120"	96" (2.4 m)	72" (1.8 m)	20'0" (6.1 m)	14'10" (4.5 m)	-54" (-137 cm)	0" (0 cm)
110"	88" (2.2 m)	66" (1.7 m)	18'4" (5.6 m)	13'7" (4.1 m)	-49" (-126 cm)	0" (0 cm)
100"	80" (2.0 m)	60" (1.5 m)	16'8" (5.1 m)	12'4" (3.8 m)	-45" (-114 cm)	0" (0 cm)
80"	64" (1.6 m)	48" (1.2 m)	13'3" (4.1 m)	9'10" (3.0 m)	-36" (-91 cm)	0" (0 cm)
60"	48" (1.2 m)	36" (0.9 m)	9'11" (3.0 m)	7'4" (2.2 m)	-27" (-69 cm)	0" (0 cm)

x : Picture size (diag.) (inches)

L1 : Maximum Projection distance (ft/m)

L2 : Minimum Projection distance (ft/m)

The formula for picture size and projection distance

$$L1 = (0.05133x - 0.05550)/0.3048 \text{ (ft)} \quad H1 = -1.143x/2.54 \text{ (in)}$$











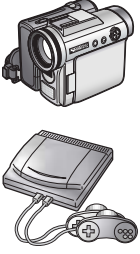
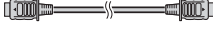

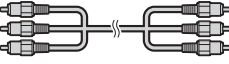

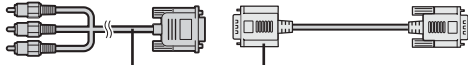
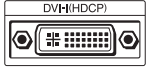
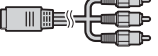
$$L2 = (0.03817x - 0.05665)/0.3048 \text{ (ft)} \quad H2 = 0$$

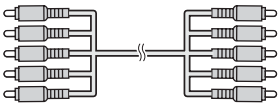
#### Note

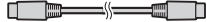
- Allow a margin of error in the diag. value in the diagrams above.
- When the distance from the lens center to the bottom of the image (H) is a negative number, this indicates that the bottom of the image is below the lens center.

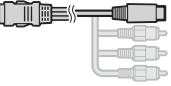
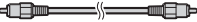
# Samples of Cables for Connection

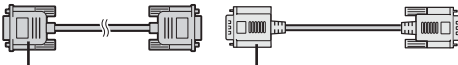
- For more details of connection and cables, refer to the operation manual of the connecting equipment.
- You may need other cables or connectors not listed below.

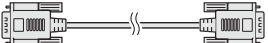
Equipment	Input signal	Cable	Terminal on the projector
<b>Audio-visual equipment</b>  <b>Camera/video game</b> 	<b>HDMI video</b>	<b>HDMI cable (commercially available)</b> 	<b>HDMI1, 2</b> 
	<b>Component video</b>	<b>Component cable (commercially available)</b> 	<b>COMPONENT/RGB1, 2</b> 
		<b>3 RCA to 15-pin D-sub cable (sold separately: AN-C3CP2)</b> <b>DVI to 15-pin D-sub adaptor (sold separately: AN-A1DV)</b>  3 RCA to 15-pin D-sub cable    DVI to 15-pin D-sub adaptor	<b>DVI</b> 
	<b>Terminal for using the dedicated cable</b>	<b>Dedicated cable attached to the connected equipment</b> 	<b>COMPONENT/RGB1, 2</b> 
	<b>RGB video</b>	<b>5 RCA RGB cable (commercially available)</b> 	<b>COMPONENT/RGB1, 2</b> 
	<b>S-video</b>	<b>S-video cable (commercially available)</b> 	<b>S-VIDEO</b> 
	<b>Terminal for using the dedicated cable</b>	<b>Dedicated cable attached to the connected equipment</b> 	
	<b>Video</b>	<b>Video cable (commercially available)</b> 	<b>VIDEO</b> 
		<b>Terminal for using the dedicated cable</b>	
<b>Computer</b> 	<b>RGB video</b>	<b>RGB cable (commercially available)</b> <b>DVI to 15-pin D-sub adaptor (sold separately: AN-A1DV)</b>  RGB cable                      DVI to 15-pin D-sub adaptor	<b>DVI</b> 
		<b>DVI cable (sold separately: AN-C3DV)</b> 	

# Connecting to Video Equipment

Before connecting, be sure to unplug the power cord of the projector from the AC outlet and turn off the devices to be connected. After making all connections, turn on the projector and then the other devices.

## Connecting Equipment with HDMI Output Terminal to the HDMI Terminal on the Projector

HDMI is a new specialized interface capable of delivering a video and audio signal to the terminal using just one cable. Since this projector does not support an audio signal by itself, use an amplifier or other audio device. For video connection, use a cable that conforms to HDMI standards. Using cables that do not conform to HDMI standards may result in a malfunction.

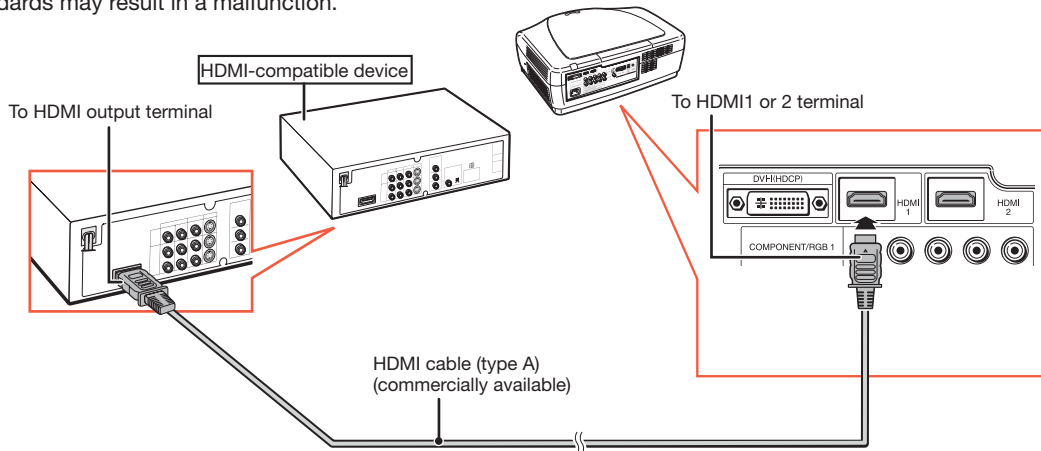

### Note

- HDMI (High-Definition Multimedia Interface) is a digital AV interface that can deliver a high-definition video signal, multi-channel audio signal, and bi-directional control signal all in just one cable.
- Because it is compatible with the HDCP (High-bandwidth Digital Content Protection) system, the digital video signal does not degrade when transmitted, and a high-quality image with a simple connection can be enjoyed.

## Connecting Equipment with the HDMI Output Terminal to the DVI Terminal on the Projector

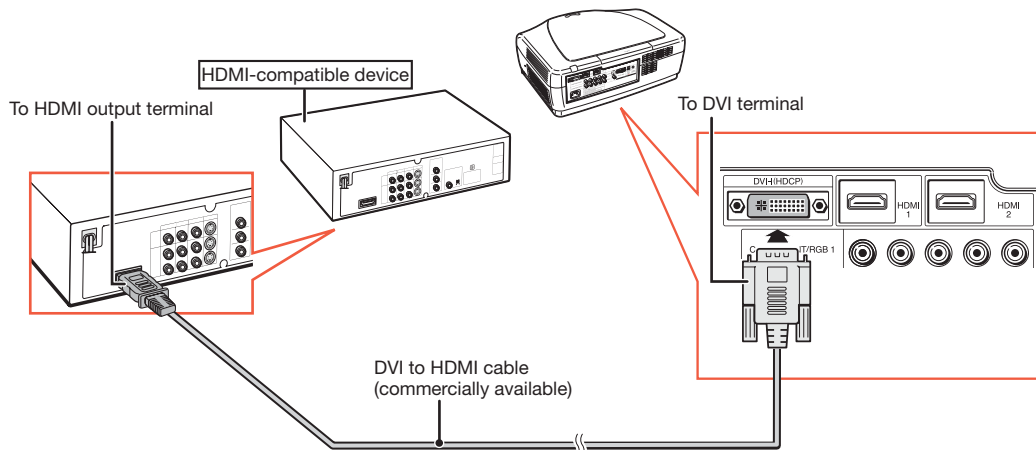

### Note

- When connecting the projector to the video equipment in this way, select "Signal Type" in the "Options" menu. See page 44.
- When a DVI to HDMI conversion cable is connected to the HDMI terminal, a proper picture may not be displayable.

### Connecting Video Equipment with the DVI Output Terminal to the DVI Terminal on the Projector

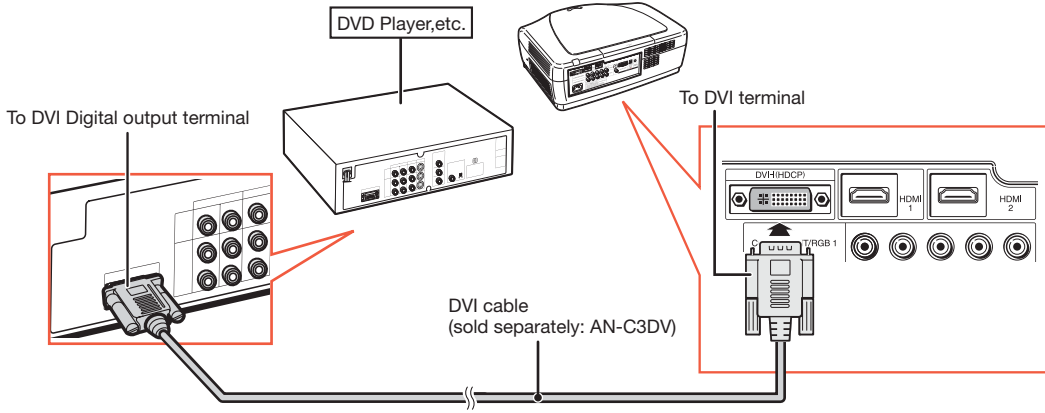

**Note**

- When connecting the projector to the video equipment in this way, select "Signal Type" in the "Options" menu. See page 44.

### Connecting Component Video Equipment to the DVI Terminal on the Projector

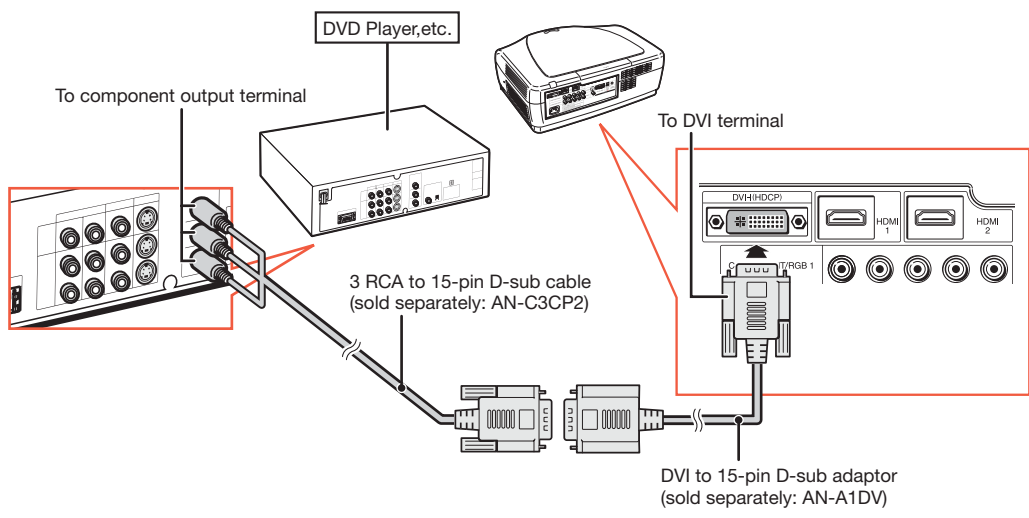

**Note**

- When connecting the projector to the video equipment in this way, select "Signal Type" in the "Options" menu. See page 44.

## Connecting to Video Equipment (Continued)

### Connecting RGB Equipment to the DVI Terminal on the Projector

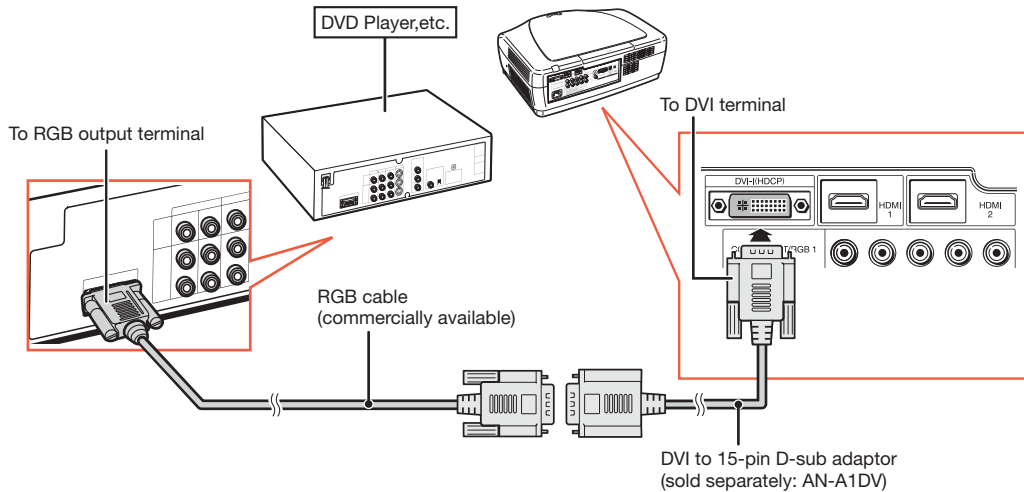

#### Note

- When connecting the projector to the video equipment in this way, select “A. RGB” for “Signal Type” in the “Options” menu. See page 44.

### Connecting RGB Equipment to the COMPONENT/RGB Terminals on the Projector

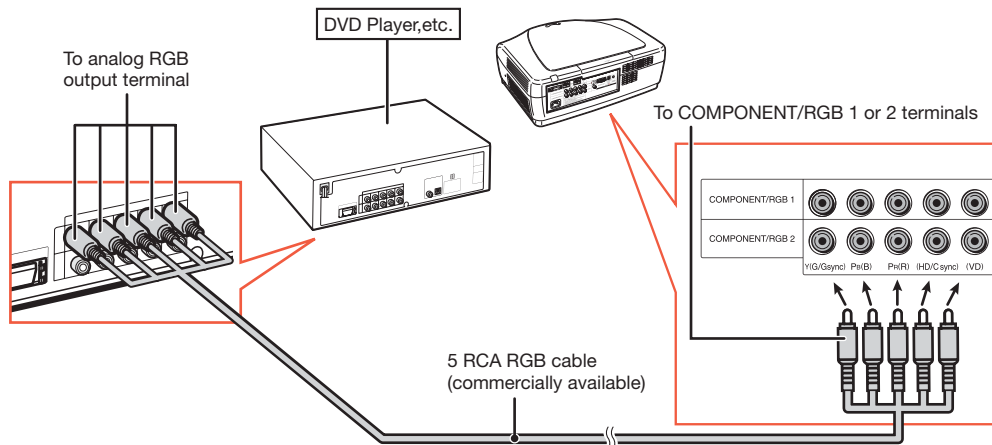

#### Note

- The (HD/C sync) and (VD) terminals may be used depending on the specifications of the RGB equipment connected to this projector. Please refer to the operation manual of the RGB equipment for details.

# Connecting Component Video Equipment to the COMPONENT/RGB Terminals on the Projector

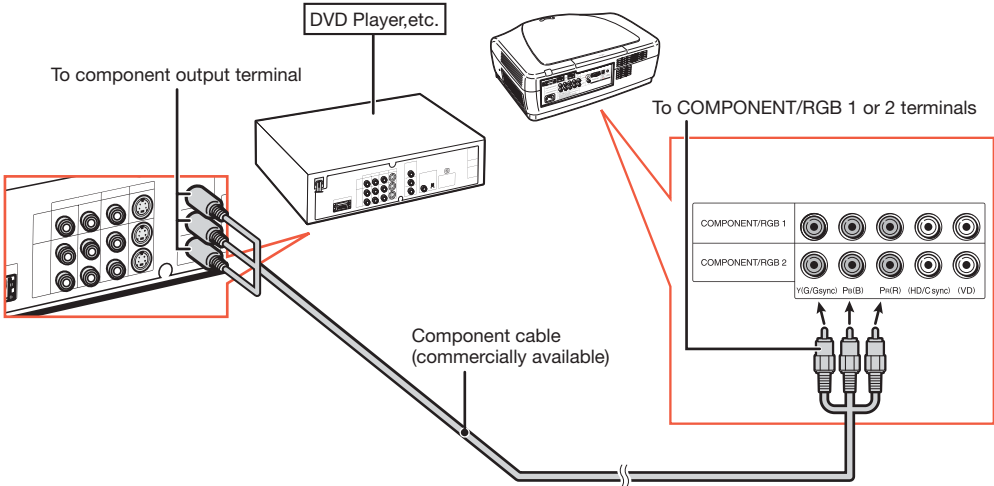



# Connecting to Video Equipment (Continued)

## Connecting to Equipment with S-video Output Terminal

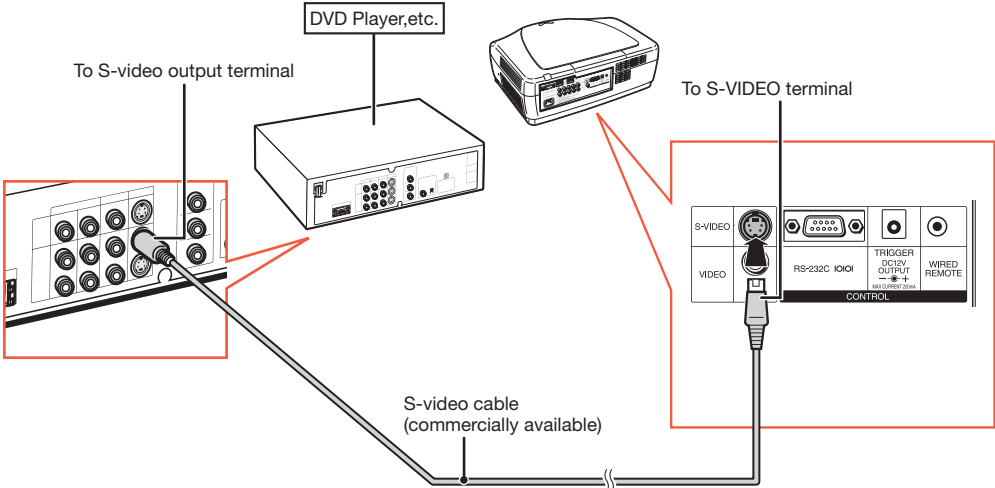

## Connecting to Equipment with Video Output Terminal

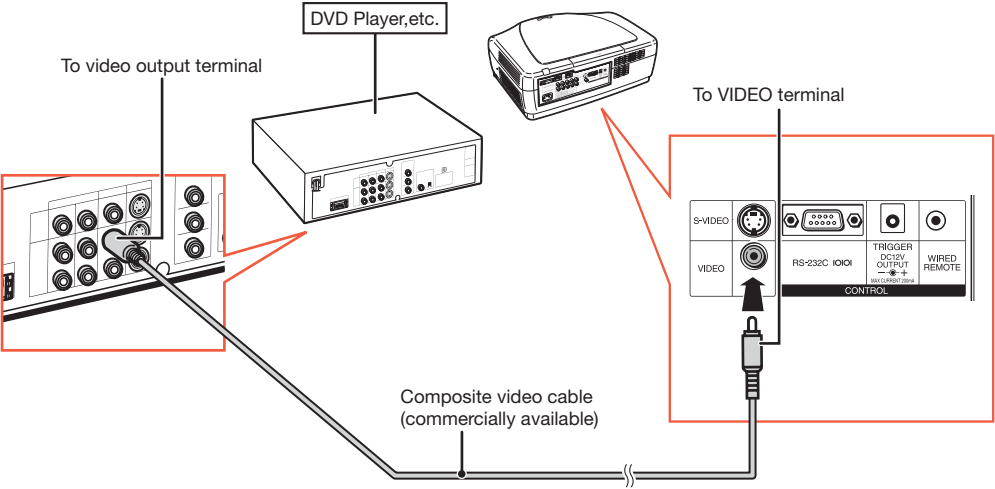

# Connecting to a Computer

Ensure that the computer is the last device to be turned on after all the connections are made.

## Connecting to a Computer Using a DVI Cable

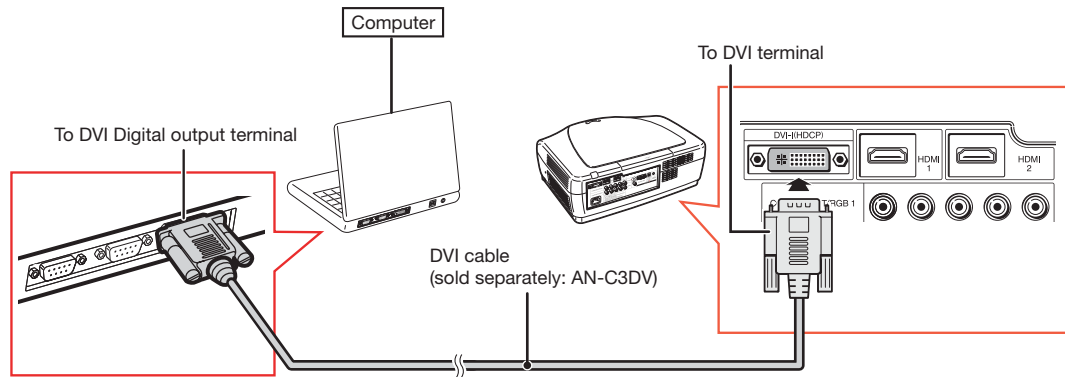

### Note

- When connecting the projector to the video equipment in this way, select “Signal Type” in the “Options” menu. See page 44.

## Connecting to a Computer Using the DVI to 15-pin D-sub Adaptor and the RGB Cable

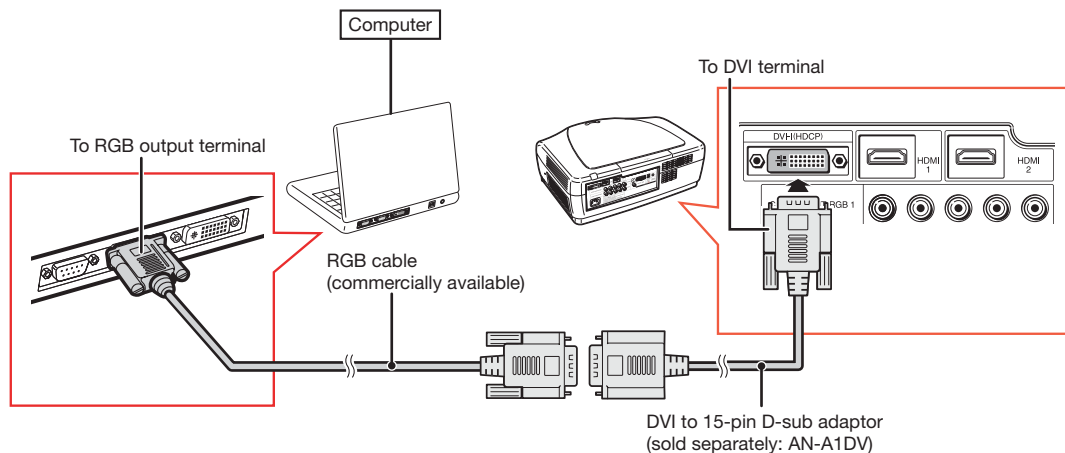

### Note

- When connecting the projector to the video equipment in this way, select “Signal Type” in the “Options” menu. See page 44.
- Refer to “Computer Compatibility Chart” on page 60 for a list of computer signals compatible with the projector. Use with computer signals other than those listed may cause some of the functions not to work.
- A Macintosh adaptor may be required for use with some Macintosh computers. Contact your nearest Sharp Authorized Service Center or Dealer.
- Depending on the computer you are using, an image may not be projected unless the computer’s external output port is switched on. (e.g. Press “Fn” and “F5” keys simultaneously when using a SHARP notebook computer). Refer to the specific instructions in your computer’s operation manual to enable your computer’s external output port.



# Controlling the Projector by a Computer

When the RS-232C terminal on the projector is connected to a computer, the computer can be used to control the projector and check the status of the projector.

When connecting to a computer using an RS-232C serial control cable

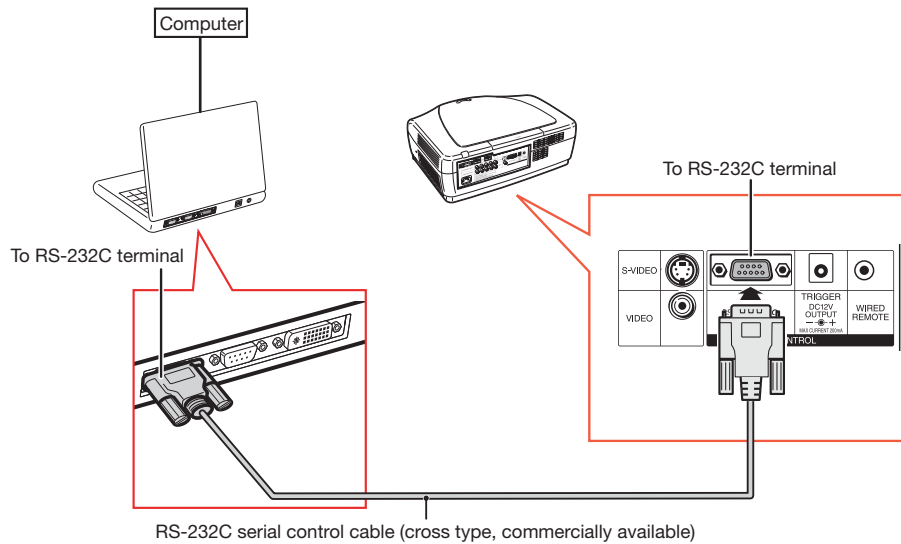

## Note

- The RS-232C function may not operate if your computer terminal is not correctly set up. Refer to the operation manual of the computer for details.
- **For details on RS-232C specifications and commands, see page 52.**

## Info

- Do not connect the RS-232C cable to a port other than the RS-232C terminal on the computer. This may damage your computer or projector.
- Do not connect or disconnect an RS-232C serial control cable to or from the computer while it is on. This may damage your computer.

# Turning the Projector On/Off

## Connecting the Power Cord

Plug the supplied power cord into the AC socket on the rear of the projector.

- The power indicator illuminates red, and the projector enters standby mode.

Supplied accessory

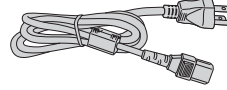

Power cord

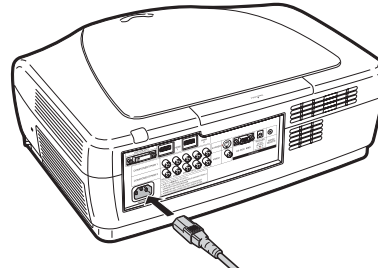

## Turning the Projector On

Before performing the steps in this section, connect any equipment that you use with the projector. (See pages 18-25.)

Remove the lens cap and press **ON** on the projector or **ON** on the remote control.

- The power indicator illuminates blue.

### Info

- English is the factory preset language. If you want to change the on-screen display to another language, change the language according to the procedure on page 45.

### Note

#### • About the Lamp Indicator

The lamp indicator illuminates to indicate the status of the lamp.

**Blue:** The lamp is ready.

**Blinking in blue:** The lamp is warming up.

**Red:** The lamp is shut down abnormally or the lamp should be replaced.

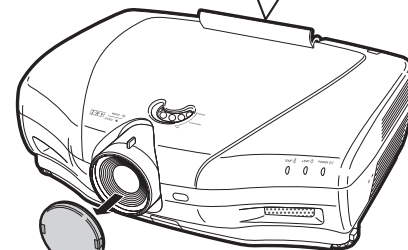
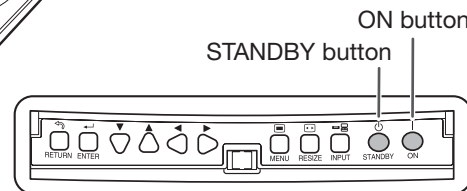
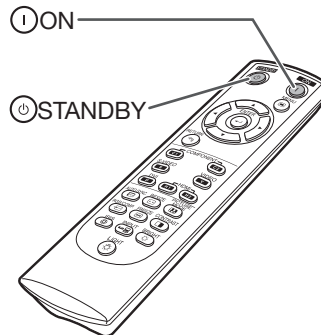
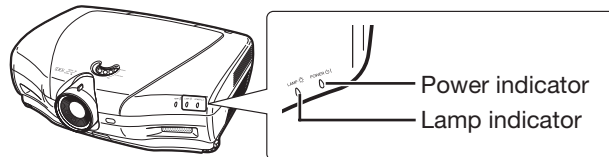

- When switching on the projector, a slight flickering of the image may be experienced within the first minute after the lamp has been illuminated. This is normal operation as the lamp's control circuitry is stabilizing the lamp output characteristics. This does not indicate malfunction.
- If the projector is put into standby mode and immediately turned on again, the lamp may take some time to illuminate.



Lens cap

### Turning the Power Off

#### (Putting the Projector into Standby Mode)

**1** Press  STANDBY on the projector or  STANDBY on the remote control, then press that button again while the confirmation message is displayed, to put the projector into standby mode.

**2** Unplug the power cord from the AC outlet after the cooling fan stops.

- The power indicator on the projector blinks in blue while cooling.
- The power indicator changes to red when the projector finishes cooling.

#### On-screen display

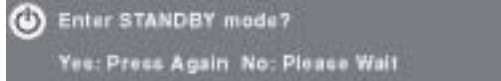

#### Info



- Do not unplug the power cord during projection or cooling fan operation. This can cause damage due to the rise in internal temperature, as the cooling fan also stops.
- When connected to equipment such as an amplifier, be sure to turn off the power to the equipment connected first and then to the projector.



# Image Projection

## Switching the Input Mode

Select the appropriate input mode for the connected equipment.

Press Input Mode Select buttons or  INPUT on the remote control to select the input mode.

- When  INPUT on the remote control or  INPUT on the projector is pressed, the Input list appears. While the Input list is displayed, follow the procedure below to switch the Input mode.

Press  INPUT or  to select the desired input mode.

Press  ENTER.

- If  ENTER is not pressed, the projector switches to the selected input mode in a few seconds.

### Note

- When no signal is received, “NO SIGNAL” will be displayed. When a signal that the projector is not preset to receive is received, “NOT REG.” will be displayed.

## Adjusting the Projected Image

### 1. Adjusting the Focus

You can adjust the focus with the focus ring on the projector.

Rotate the focus ring to adjust the focus while watching the projected image.

### 2. Adjusting the Image Size

You can adjust the image size using the zoom knob on the projector.

Move the zoom knob to enlarge or shrink the image size.

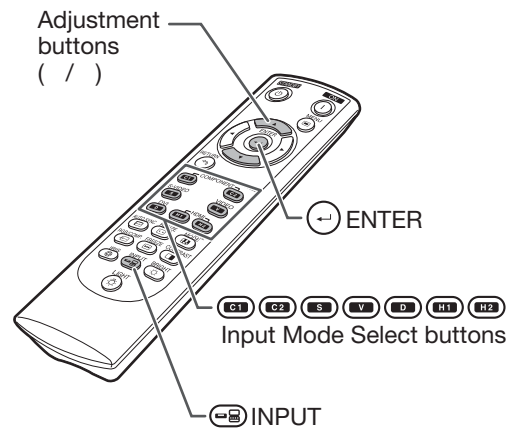

Input mode menu

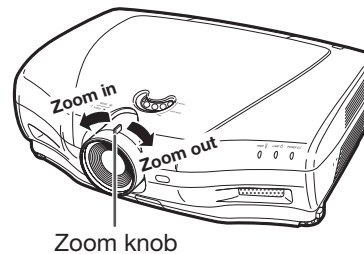
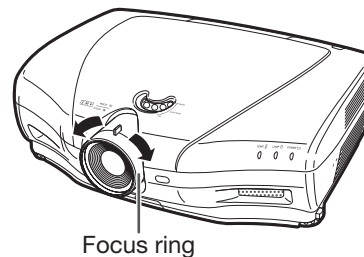
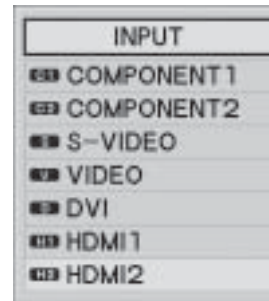

## Image Projection (Continued)

### 3. Adjusting the Projector Angle Using the Adjustment Feet

The inclination of the projector can be adjusted using the adjustment feet when the projector is placed on an uneven surface or when the screen is slanted.

**1 Lift the projector to adjust its height while pressing the foot releases.**

**2 Remove your hands from the foot releases after the height has been adjusted.**

- The angle of projection is adjustable up to 5 degrees from the surface on which the projector is placed.

**3 Rotate the adjustment feet to make fine adjustment.**

- Rotate the adjustment feet to gradually raise or lower the projector. Ensure that the projector is stable and does not wobble.

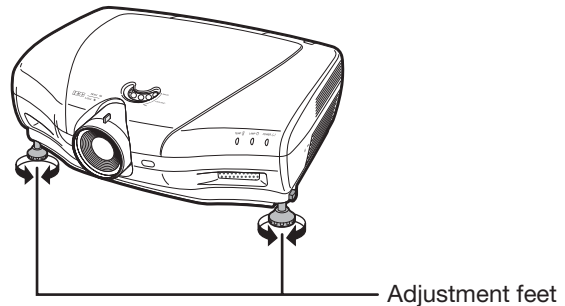
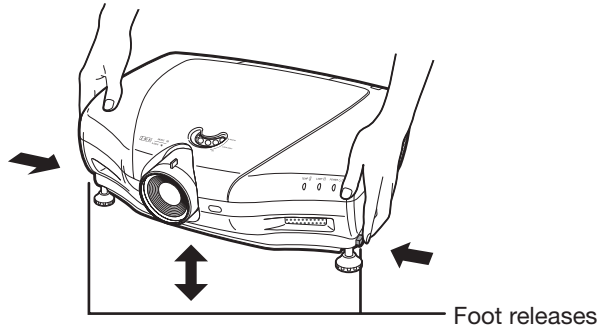

#### Note

- When the height of the projector is adjusted, the image may become distorted, depending on the relative positions of the projector and the screen.

#### Info

- Do not apply too much pressure on the projector when the adjustment feet are stuck out.
- When lowering the projector, be careful not to get your fingers caught in the area between the adjustment foot and the projector.
- Hold the projector firmly while lifting or carrying.
- Do not hold by the lens area.

### 4. Adjusting the Vertical Position of the Image

You can move the projected image vertically by turning the lens shift dial.

#### Info

- Do not turn the lens shift dial beyond the upper limit and lower limit positions. This may cause the projector to malfunction.

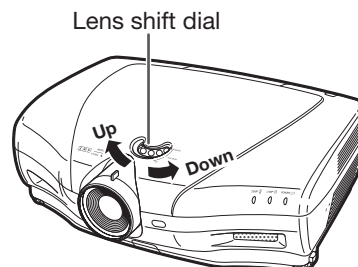

# Operating with the Remote Control

## Switching the Iris Setting

This function controls the quantity of the projected light and the contrast of the image.

Press **IRIS**.

- Each time the button is pressed while the display is on, the mode changes in the following order:

HIGH BRIGHTNESS MODE → MEDIUM MODE  
↑ HIGH CONTRAST MODE ↓

### Note

- For details, see page 37.

## Adjusting the Contrast

**1** Press **CONTRAST**.

**2** Press **←** or **→** to adjust the contrast.

**3** Press **ENTER**.

### Note

- For details, see page 36.

## Adjusting the Quantity of Light

**1** Press **BRIGHT**.

**2** Press **←** or **→** to adjust the quantity of light.

**3** Press **ENTER**.

### Note

- For details, see page 36.

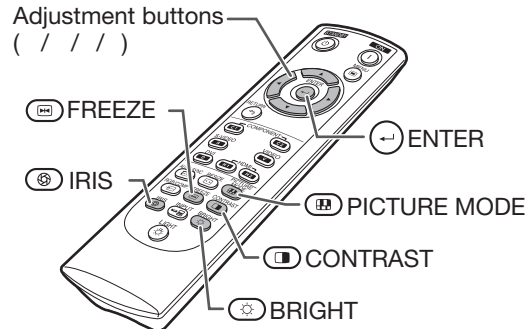

## Freezing a Moving Image

**1** Press **FREEZE**.

- The projected image is frozen.

**2** Press **FREEZE** again to return to the moving image from the currently connected device.

## Selecting the Picture Mode

You can select the appropriate picture mode to best match the projected image you are watching.

Press **PICTURE MODE**.

- Each time the button is pressed while the display is on, the mode changes in the following order:

STANDARD → NATURAL → DYNAMIC  
↑ MEMORY ← MOVIE2 ← MOVIE1 ↓

### Note

- For details, see page 36.

# Selecting the Screen Size

## Resize Mode

This function allows you to modify or customize the resize mode to enhance the input image.



Press  **RESIZE** on the projector or  **RESIZE** on the remote control.

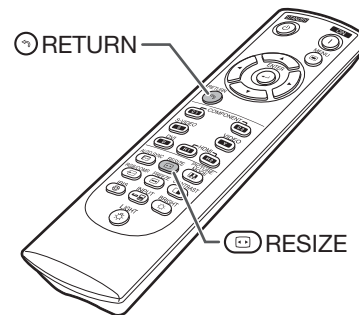
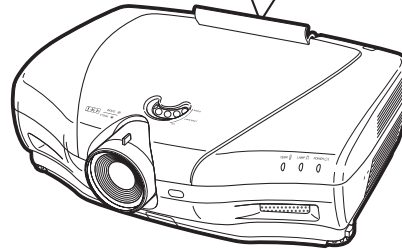
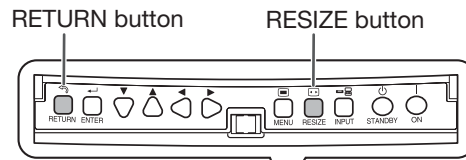

### Note

- The **RESIZE** function that can be selected varies depending on the input signal (resolution and vertical frequency).
- To return to the standard image, press  **RETURN** while “RESIZE” is displayed.

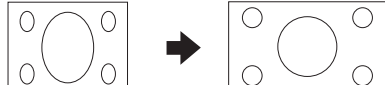

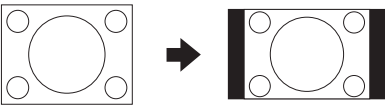
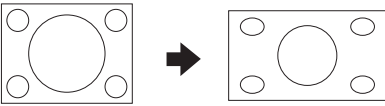
## Resize Mode

RESIZE	Output screen image
STRETCH	An image compressed from a 16:9 aspect ratio to a 4:3 aspect ratio is restored to a 16:9 aspect ratio and displayed at full-screen. 
NORMAL (Computer)	The image is displayed with the original aspect ratio. 
SIDE BAR (Video)	An image with a 4:3 aspect ratio is displayed without any changes. 
SMART STRETCH	An image with a 4:3 aspect ratio is widened to fit the entire screen. 

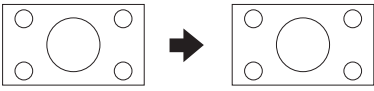
RESIZE	Output screen image
CINEMA ZOOM	<p>A CinemaScope image or an image with a 16:9 aspect ratio is displayed at full-screen</p> 
ZOOM 14:9	<p>An image with a 14:9 aspect ratio and letterboxing is enlarged while maintaining the original aspect ratio.</p> 
SMART ZOOM	<p>An image with a 4:3 aspect ratio is slightly enlarged.</p> 
DOT BY DOT	<p>The image is displayed according to the original input signal.</p> 

## About Copyrights

- When using the RESIZE function to select an image size with a different aspect ratio to a TV program or video image, the image will look different from its original appearance. Keep this in mind while choosing an image size.
- The use of the RESIZE, Subtitle, or Overscan function to compress or stretch the image for commercial purposes/public displays in a café, hotel, etc. may be an infringement of copyright protected by law for copyright holders. Please use caution.
- While watching non-widescreen images (4:3), if you use the RESIZE function to fill the screen or use the Overscan function to change the aspect ratio of a fixed-ratio input signal, parts of the outer edge of the image will be cut off or distorted. To watch original images as the producers intended, set "RESIZE" to "SIDE BAR" and Overscan to its default setting.





# Menu Bar Items

The following shows the items that can be set in the projector. The selectable items vary depending on the selected input, input signals, or adjustment values. Items that cannot be selected will be grayed out.

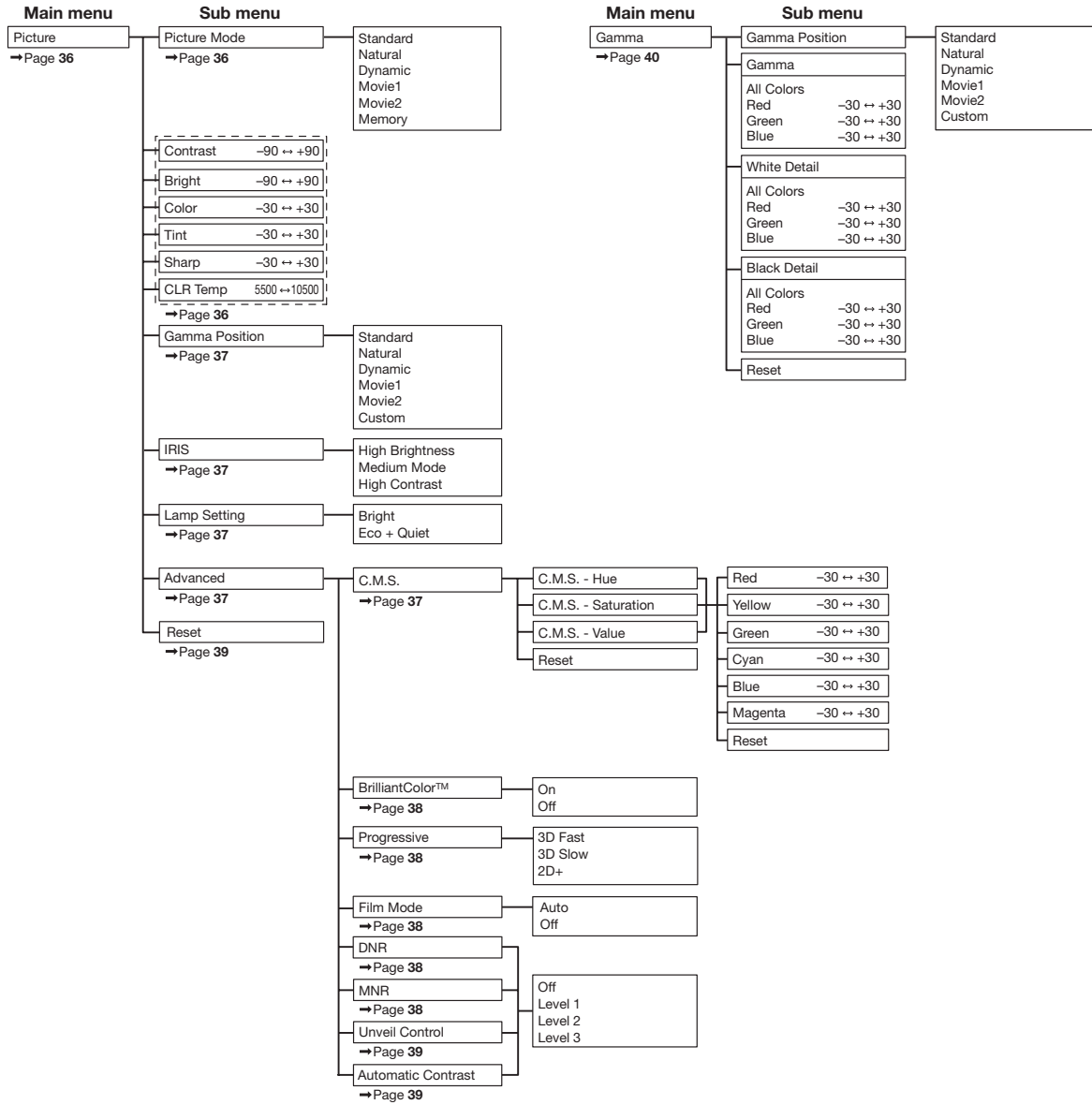

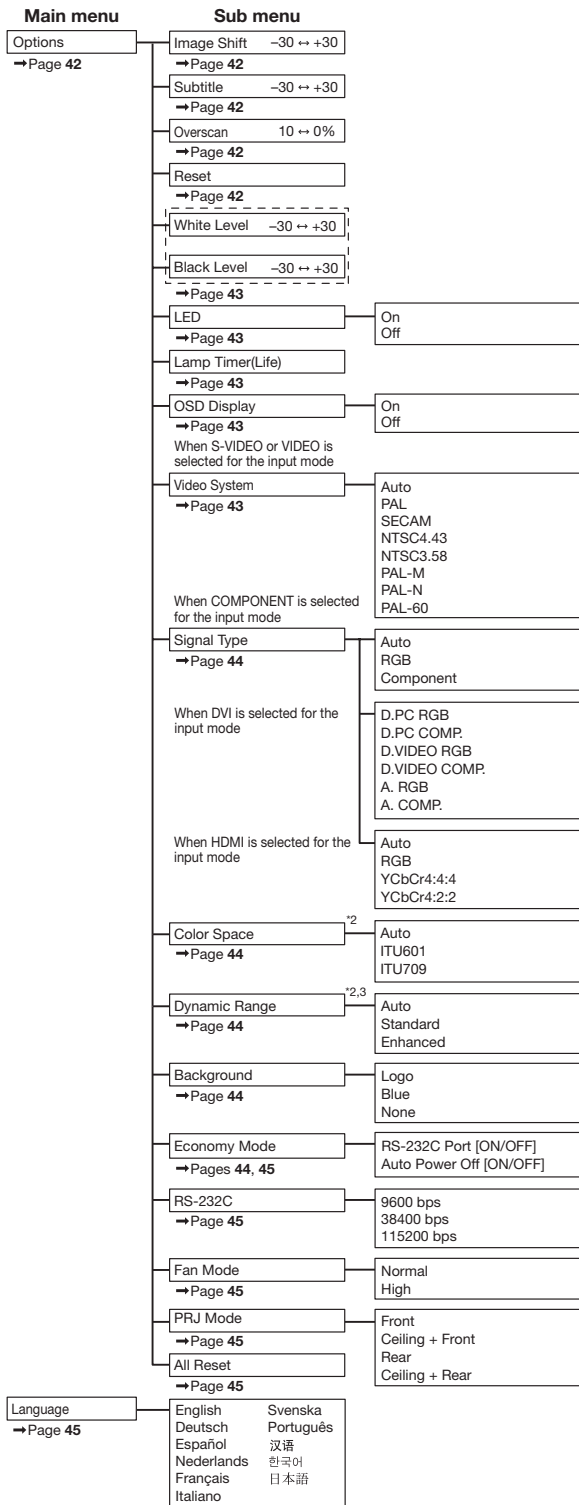
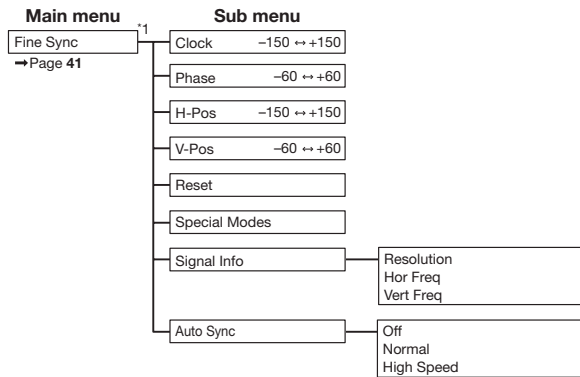

\*1: The “Fine Sync” menu is not available for S-VIDEO or VIDEO Input.

\*2: Can be set for HDMI Input.

\*3: Can be set for DVI Input.

# Using the Menu Screen

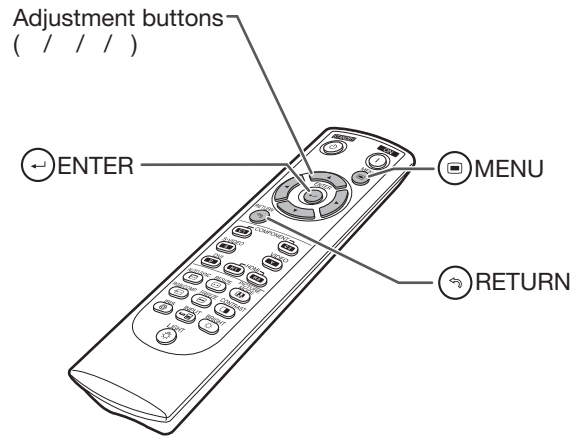
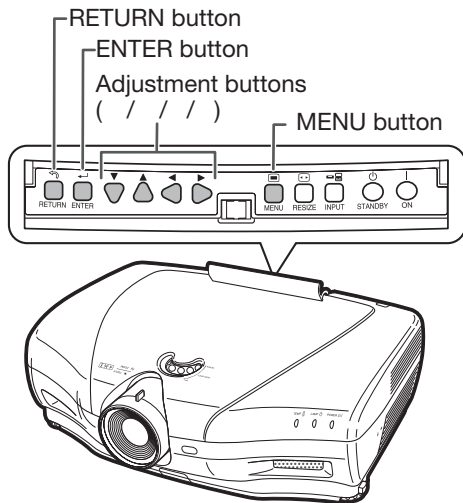

## Menu Selections (Adjustments)

- This operation can also be performed by using the buttons on the projector. (Example: Adjusting “Bright”)

### 1 Press MENU.

- The “Picture” menu screen for the selected input mode is displayed.

### 2 Press or to select the menu screen to adjust on the menu bar.

#### Note

- The “Fine Sync” menu is not available for selecting S-VIDEO or VIDEO.

Example: “Picture” menu screen when COMPONENT is selected for input mode

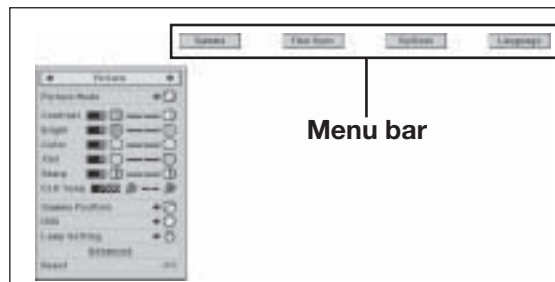

- 3** Press **←** or **→** to select the item you want to adjust.  
(Example: Selecting “Bright”)

### To adjust the projected image while viewing it

Press **↵** ENTER.

- The selected adjustment item (e.g. “Bright”) will be displayed at the bottom of the screen.
- When **←** or **→** is pressed, the next item will be displayed. (e.g. “Bright” is replaced with “Color” by pressing **→**.)

 **Note**

- Press **↶** RETURN to return to the previous screen.

- 4** Press **←** or **→** to adjust the item selected.

- The adjustment is stored.
- For some menu items, press **→** to display its submenu and press **←** or **→** to select an adjustment item, and then press **↵** ENTER.

- 5** Press **⏏** MENU.

- The menu screen will disappear.

Single-adjustment items

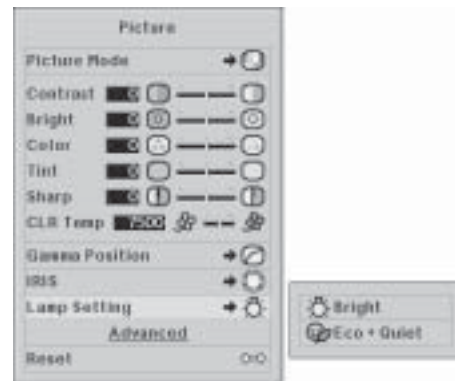
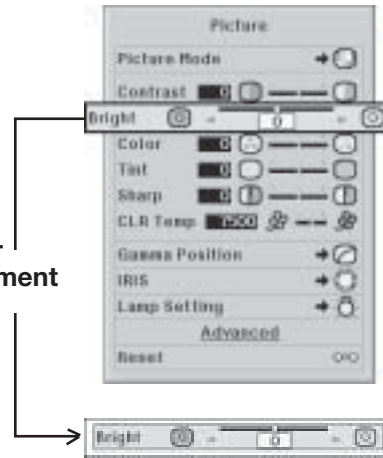

# Picture Adjustment (“Picture” Menu)

Menu operation ⇒ Page 34

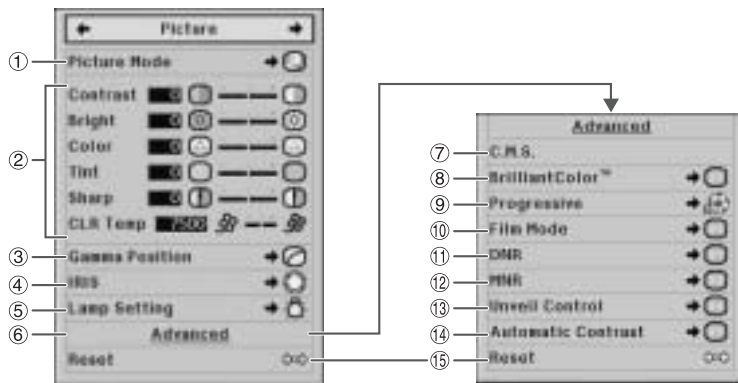

## Selecting the Picture Mode

This function allows you to select the picture mode that best suits the room brightness and the type of image being projected.

Selectable items	Description	The main default settings of each item when selecting Picture Mode			
		CLR Temp	BrilliantColor™	IRIS	Lamp Setting
Standard	For standard image	7500	Off	High Brightness	Bright
Natural	A balanced color image is obtained.	7500	Off	High Brightness	Bright
Dynamic	A vivid image is obtained.	7500	On	High Brightness	Bright
Movie1	For viewing images with the brightness slightly toned down in a darkened room	6500	Off	Medium Mode	Eco + Quiet
Movie2	For viewing images with the brightness slightly boosted in a darkened room	6500	Off	High Contrast	Eco + Quiet
Memory	Allows you to store your picture adjustment settings. The settings stored effect each input mode.	7500	Off	High Brightness	Bright

- You can set or adjust each item in the “Picture” menu to your preference. Any changes you make are retained in memory.

### Note

- You can also press **PICTURE MODE** on the remote control to select the picture mode. (See page 29.)
- The default settings are subject to change without notice.

## Adjusting the Image

Adjustment items	button	button
Contrast	For less contrast.	For more contrast.
Bright	For less brightness.	For more brightness.
Color	For less color intensity.	For more color intensity.
Tint	For making skin tones purplish.	For making skin tones greenish.
Sharp	For less sharpness.	For more sharpness.
CLR Temp	For making images slightly more reddish (slightly warmer colors).	For making images slightly more bluish (slightly cooler colors).

### Note

- To reset all adjustment items, select “Yes” in “Reset” and press **ENTER**. The Picture Mode settings of the selected input return to the default settings.
- As for “Contrast” and “Bright”, you can make adjustments directly by using **CONTRAST** and **BRIGHT**, respectively, on the remote control. (See page 29.)

## Selecting the Gamma Position

This function allows you to select the desired gamma position.

See page 40 for details.

### Note

- Gamma can be adjusted in greater detail with “Gamma” on the menu screen.

## Switching the Iris Setting

This function controls the quantity of the projected light and the contrast of the image.

Selectable items	Description
High Brightness	High brightness is given priority over high contrast.
Medium Mode	Intermediate mode between high contrast and high brightness.
High Contrast	High contrast is given priority over high brightness.

### Note

- You can also use  IRIS on the remote control to change the Iris. (See page 29.)

## Lamp Setting

Selectable items	Brightness	Fan sound	Power consumption (When using AC 100V)	Lamp Life
Bright	100%	Normal	320W	Approx. 2,000 hours
Eco + Quiet	Approx. 80%	Low	265W	Approx. 3,000 hours

### Note

- When “Lamp Setting” is set to “Eco+Quiet”, the power consumption will decrease and the lamp life will extend. (Projection brightness decreases approximately 20%.)

## Using the Advanced

“Advanced” allows you to make even finer adjustments to the image so that it appears just the way you want it to.

To display the Advanced menu, select “Advanced” and press  ENTER.

### Note

- When the “Advanced” settings are displayed, select “Advanced” again and press  ENTER to return to the “Picture” menu.



## Adjusting the Colors





Select “C.M.S.” (Color Management System) in the “Advanced” menu and then press  ENTER.

This function adjusts each of the six main colors that comprise the color wheel, altering their “Hue”, “Saturation”, or “Value”.

Selectable items	Description
C.M.S.-Hue	Sets the hue of the main colors.
C.M.S.-Saturation	Sets the Saturation of the main colors
C.M.S.-Value	Sets the Value of the main colors.
Reset	The adjustments of “Hue”, “Saturation” and “Value” of all colors are reset to the default setting.



Adjusting “Hue”, “Saturation”, or “Value”.





Press  or  to select either “Hue”, “Saturation”, or “Value” and then press  ENTER.

Select the color to be adjusted with  or  and adjust it with  or .

- When you press  ENTER, the adjustment bar for the selected system color will be displayed at the bottom of the screen. Use this bar to make adjustments while viewing the effects on-screen.

Example of adjusting the “Hue”

Main colors	 button	 button
Red	Closer to magenta	Closer to yellow
Yellow	Closer to red	Closer to green
Green	Closer to yellow	Closer to cyan
Cyan	Closer to green	Closer to blue
Blue	Closer to cyan	Closer to magenta
Magenta	Closer to blue	Closer to red

- When “Saturation” is selected, the selected color becomes lighter (  ) or thicker (  ).
- When “Value” is selected, the selected color becomes darker (  ) or brighter (  ).
- To reset the adjustment values of each color to the default settings, select “Yes” in “Reset” and press  ENTER.

## Adjusting the BrilliantColor™

BrilliantColor™ uses Texas Instruments’ BrilliantColor™ technology. The image becomes brighter while the color reproduction is kept at a high level.

Selectable items	Description
On	The BrilliantColor™ function is activated.
Off	The BrilliantColor™ function is not activated.

## Selecting the Progressive Mode

For selecting the progressive display of a video signal.

Selectable items	Description
3D Fast	Useful to display fast-moving images such as sports and action films.
3D Slow	Useful to display relatively slow-moving images such as drama and documentary more clearly.
2D+	This mode is ideal for games, etc.

### Note

- When using progressive inputs, “Progressive” cannot be selected.

## Selecting the Film Mode

This function provides high-quality playback of images originally projected at 24 fps, such as movies on DVDs.

Selectable items	Description
Auto	Films are detected automatically.
Off	Films are not detected.

### Note

- When using progressive inputs, “Film Mode” cannot be selected.

## Reducing Image Noise (DNR)

Video digital noise reduction (DNR) provides high quality images with minimal dot crawl and cross color noise.

Selectable items	Description
Off	The DNR function is not activated.
Level 1	Sets the DNR level for viewing a clearer picture.
Level 2	
Level 3	

### Note

**Set “DNR” to “Off” in the following cases:**

- When the image is blurry.
- When the contours and colors of moving images drag.
- When TV broadcasts with weak signals are projected.

## Mosquito Noise Reduction (MNR)

The so-called Mosquito Noise (flickering) can be reduced.

Selectable items	Description
Off	MNR does not function.
Level 1	Sets the MNR level for viewing a clearer picture.
Level 2	
Level 3	

### Adjusting the Unveil Control

This function uses edge enhancement to give the impression of added depth to images.

Selectable items	Description
Off	The Unveil Control function is not activated.
Level 1	Sets the Unveil Control level for viewing an image with the impression of added depth.
Level 2	
Level 3	

### Adjusting the Automatic Contrast

This function automatically adjusts the image contrast to suit the scene.

Selectable items	Description
Off	The Automatic Contrast function is not activated.
Level 1	Sets the Automatic Contrast level.
Level 2	
Level 3	

### Resetting All Adjustment Items

This function allows you to reset all adjustment items to the default setting.

Selectable items	Description
No	Does not do resetting.
Yes	Resets all adjustment items.



# Gamma Adjustment (“Gamma” Menu)

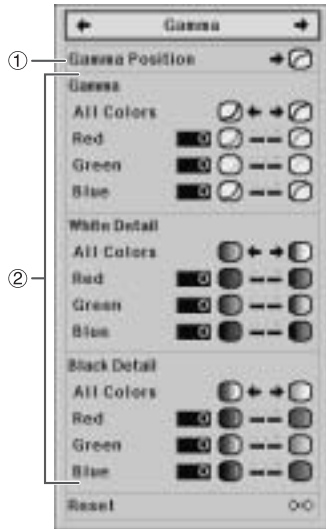

## Selecting the Gamma Position

You can select the desired gamma position according to the image being projected.

Selectable item	Description
Standard	Sharp default setting
Natural	Gives a solid and understated image quality
Dynamic	For viewing images in relatively bright surroundings
Movie1	For viewing images with the brightness slightly toned down in a darkened room
Movie2	For viewing images with the brightness slightly boosted in a darkened room
Custom	Uses special software that allows the gamma curve to be adjusted. For more information on the special software, visit the Sharp website at: <a href="http://sharp-world.com/projector/">http://sharp-world.com/projector/</a> .

### Note

- The gamma position you set in this menu can be selected in the “Gamma Position” in the “Picture” menu.

## Adjusting the Gamma

Adjust the gamma curve to suit your preferences.

### Gamma

Selectable item	button	button
All Colors	You can make sync adjustment for the Red, Green and Blue mentioned below. For giving greater depth to brighter portion of image	For giving greater depth to darker portion of image
Red	For giving greater depth to brighter portion of image in red color.	For giving greater depth to darker portion of image in red color.
Green	For giving greater depth to brighter portion of image in green color.	For giving greater depth to darker portion of image in green color.
Blue	For giving greater depth to brighter portion of image in blue color.	For giving greater depth to darker portion of image in blue color.

### White Detail

Selectable item	button	button
All Colors	You can make sync adjustment for the Red, Green and Blue mentioned below. For less contrast	For more contrast
Red	For less contrast in red color	For more contrast in red color
Green	For less contrast in green color	For more contrast in green color
Blue	For less contrast in blue color	For more contrast in blue color

### Black Detail

Selectable item	button	button
All Colors	You can make sync adjustment for the Red, Green and Blue mentioned below. For less brightness	For more brightness
Red	For less brightness in red color	For more brightness in red color
Green	For less brightness in green color	For more brightness in green color
Blue	For less brightness in blue color	For more brightness in blue color

- When you select an adjustment item and press **ENTER**, the adjustment bar for the selected adjustment item will be displayed at the bottom of the screen. Use this bar to make adjustments while viewing the effects on-screen.

### Note

- To reset all adjustment items, select “Reset” and press **ENTER**.

# Computer Image Adjustment (“Fine Sync” Menu)

The illustration shown here is for explanation and may be different from the actual on-screen display.

Menu operation ⇒ Page 34

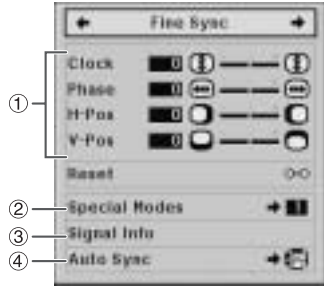

## Adjusting the Computer Image

Use the Fine Sync function in case of irregularities such as vertical stripes or flickering in portions of the screen.

Selectable item	Description
Clock	Adjusts vertical noise.
Phase	Adjusts horizontal noise (similar to tracking on your VCR).
H-Pos	Centers the on-screen image by moving it to the left or right.
V-Pos	Centers the on-screen image by moving it up or down.

### Note

- You can automatically adjust the computer image by setting “Auto Sync” in the “Fine Sync” menu to “Normal” or “High speed”, or pressing AUTO SYNC on the remote control.
- Depending on the type of input signal, the adjustment range for each setting may vary or the adjustment may not be available at all.
- To reset all adjustment items, select “Yes” in “Reset” and press ENTER.

## Special Modes Setting

Ordinarily, the type of input signal is detected and the correct resolution mode is automatically selected. However, for some signals, the optimal resolution mode in “Special Modes” in the “Fine Sync” menu may need to be selected to match the computer display mode.

### Note

- Avoid displaying computer patterns which repeat every other line (horizontal stripes). (Flickering may occur, making the image hard to see.)
- Information on the currently selected input signal can be confirmed in item .

## Checking the Input Signal

This function allows you to check the current input signal information.

## Auto Sync (Auto Sync Adjustment)

Selectable item	Description
Off	Auto Sync adjustment is not automatically performed.
Normal	Auto Sync adjustment will occur when the projector is turned on or when the input signals are switched, when connected to a computer.
High Speed	The “Normal” setting adjusts the image synchronization more accurately than the “High Speed” setting. For this reason, it takes slightly longer to make the adjustment.

### Note

- Auto Sync adjustment is also performed by pressing AUTO SYNC on the remote control.
- When setting “Auto Sync” to “Off” or “High Speed”, and if AUTO SYNC is pressed, Auto Sync will be executed in “High Speed” mode. If the button is pressed again within one minute, Auto Sync will be executed in “Normal” mode.
- The Auto Sync adjustment may take some time to complete, depending on the image of the computer connected to the projector.
- When the optimum image cannot be achieved with Auto Sync adjustment, use manual adjustments.

# Using the “Options” Menu

When HDMI is selected for the input mode.  
The illustration shown here is for explanation and may be different from the actual on-screen display.

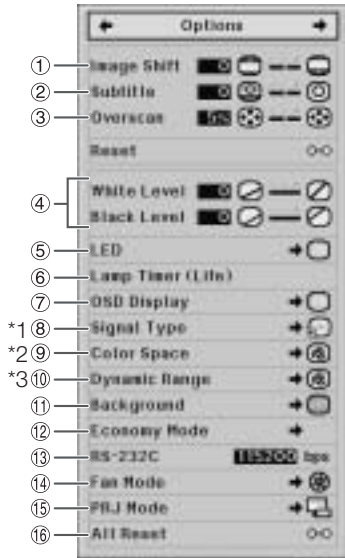

- \*1 If the input mode is S-VIDEO or VIDEO input, the display changes to the “Video System” screen.
- \*2 Displayed when the input mode is HDMI input.
- \*3 Displayed when the input mode is HDMI input or DVI input with digital signals.

## Adjusting the Image Position

You can move the projected image vertically.

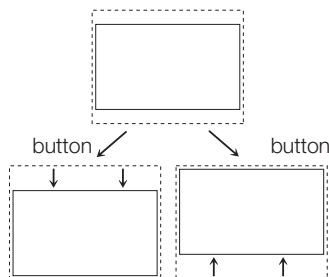

### Note

- The Image Shift function only works when “RESIZE” is set to “SMART STRETCH”, “CINEMA ZOOM”, “ZOOM 14:9” or “SMART ZOOM”.
- You can initialize the “Image Shift”, “Subtitle” and “Overscan” settings to their respective default setting by selecting “Yes” in “Reset” and pressing ENTER.

## Adjusting the Vertical Size of the Display (Subtitle Setting)

With this function, you can adjust the vertical size of the display to allow for subtitles.

button	The image is compressed by adjusting the vertical size of the display.
button	The image is enlarged by adjusting the vertical size of the display.

### Note

- When changing the screen with the Subtitle setting, not only the bottom of the screen rises, but also the upper part is changed to a certain point.
- The Subtitle setting can be adjusted more effectively with the “Overscan” and “Image Shift” functions.
- The Subtitle setting only works when “RESIZE” is set to “SMART STRETCH”, “CINEMA ZOOM”, “ZOOM 14:9” or “SMART ZOOM”.
- The adjustment area changes according to the input signal.
- You can initialize the “Image Shift”, “Subtitle” and “Overscan” settings to their respective default setting by selecting “Yes” in “Reset” and pressing ENTER.

## Adjusting the Overscan

This function allows you to adjust the Overscan area (display area).

button	Enlarges the image. (The display area becomes smaller.)
button	Reduces the image. (The display area becomes larger.)

### Note

- You can adjust the Overscan area for the following input signals and the RESIZE function.
  - Input signal: VIDEO, 480I/480P, 540P, 576I/576P, 720P, 1035I or 1080I/1080P
  - RESIZE function: “SIDE BAR”, “CINEMA ZOOM”, “STRETCH” or “ZOOM 14:9”
- If the display area ratio is set too large, noise may appear at the screen edges. If this happens, set the display area ratio to a smaller value.
- Also read “About Copyrights” on page 31.
- You can initialize the “Image Shift”, “Subtitle” and “Overscan” settings to their respective default setting by selecting “Yes” in “Reset” and pressing ENTER.

## Adjusting the White Level/Black Level

“White Level” adjusts the white level for variations in the input signals.

“Black Level” adjusts the black level for variations in the input signals.

Selectable items	button	button
White Level	Gives better color reproduction.	Gives brighter and sharper images.
Black Level	Darkens the image.	Brightens the image.



- You cannot adjust the white and black levels when inputting a digital signal.

## Turning LED Off

LEDs (indicators) on the projector can be turned off when they are disturbing the projection.

Selectable items	Description
On	LEDs are turned on.
Off	LEDs are turned off while the projector is in operation. (LEDs turn on while the projector is in the standby mode, warming up or indicating problems.)



- When Auto Power Off function is set to “OFF”, “LED” is set to “On” automatically. Be sure to set Auto Power Off function to “ON” to use LED Off function. (See page 45.)

## Checking the Lamp Life Status

You can confirm the cumulative lamp usage time and the remaining lamp life (percentage).

Lamp usage condition	Remaining lamp life		
	“Life”	100%	5%
Operated exclusively with Lamp Setting set to “Eco + Quiet”	Approx. 3,000 hours	Approx. 150 hours	Approx. 150 hours
Operated exclusively with Lamp Setting set to “Bright”	Approx. 2,000 hours	Approx. 100 hours	Approx. 100 hours



- It is recommended that the lamp be changed when the remaining lamp life becomes 5%.
- The lamp life may vary depending on the usage condition.

## Setting On-screen Display

Selectable items	Description
On	All on-screen displays are displayed.
Off	Only the menus, input mode menu, the adjustment bars for contrast and brightness and the warning messages (power off, temperature, lamp replacement, etc.) are displayed.

## Setting the Video System

When the input mode is S-VIDEO or VIDEO input, adjustment items for the “Video System” mode can be set. The video input system mode is factory preset to “Auto”; however, a clear picture from the connected audio-visual equipment may not be received, depending on the video signal difference. In that case, switch the video signal.

Selectable items	Description
PAL	When connected to PAL video equipment.
SECAM	When connected to SECAM video equipment.
NTSC4.43	When reproducing NTSC signals in PAL video equipment.
NTSC3.58	When connected to NTSC video equipment.

## Signal Type Setting

When using an input mode other than S-VIDEO or VIDEO input, set the signal type setting to the corresponding input signal type (RGB or Component).

### ■ When COMPONENT is selected for the input mode

Selectable items	Description
Auto	Automatically selects the appropriate input signal between RGB and Component.
RGB	Set when RGB signals are received.
Component	Set when component signals are received.

### ■ When DVI is selected for the input mode

Selectable items	Description
D. PC RGB	Set when digital PC RGB signals are received from the computer.
D. PC COMP.	Set when digital PC component signals are received from the computer.
D. VIDEO RGB	Set when digital video RGB signals are received from video equipment.
D. VIDEO COMP.	Set when digital video component signals are received from video equipment.
A. RGB	Set when analog RGB signals are received.
A. COMP.	Set when analog component signals are received.

### ■ When HDMI is selected for the input mode

This function sets the type of picture signal input from HDMI-compatible equipment.

Selectable items	Description
Auto	Ordinarily, the Auto setting should be used.
RGB	Displays images in RGB (Red/Green/Blue) mode.
YCbCr4:4:4	These modes display images using a luminance signal (Y) to indicate contrast and color difference signals (CbCr) to show the colors. (Select whichever mode gives the best image.)
YCbCr4:2:2	

#### Note

- You can also select “Signal Type” using  RGB/COMP. on the remote control.

## Adjusting the Color Space

This function sets the color space for signals input from an HDMI-compatible device.

Selectable items	Description
Auto	In most circumstances, “Auto” should be selected.
ITU601	Select the item that results in the best picture quality.
ITU709	

## Adjusting the Dynamic Range

An optimum picture may not be displayed if an HDMI-capable device’s output signal type and the projector’s input signal type do not match. If this should occur, switch “Dynamic Range”.





Selectable items	Description
Auto	In most circumstances, “Auto” should be selected.
Standard	When the black levels of the image show banding or appear faded, select the item that results in the best picture quality.
Enhanced	

## Selecting the Background Image

Selectable items	Description
Logo	SHARP logo screen
Blue	Blue screen
None	— (Black screen)

## Adjusting the Economy Mode

Setting the Economy mode:

- Select “Economy Mode” and press .
- Press  /  to select the desired item and press .

### ■ RS-232C Port

When the RS-232C port is set to “ON”, the RS-232C function operates and consumes power even when the projector is in Standby mode. Accordingly, the RS-232C port should be set to “OFF” when it is not being used so as to minimize the amount of power consumed when the projector is in Standby mode.

Selectable items	Description
ON	The RS-232C is operating at all times (to accept communications).
OFF	RS-232C does not operate when the power supply is in standby.

#### Note

- When you control the projector by means of RS-232C, select “ON”.

### ■ Auto Power Off

This function automatically switches the projector to Standby mode if no signals are received for a set period.

Selectable items	Description
ON	When no input signal is detected for more than 15 minutes, the projector will automatically enter standby mode.
OFF	The Auto Power Off function will be disabled.

#### Note

- When the Auto Power Off function is set to “ON”, 5 minutes before the projector enters standby mode, the message “Enter STANDBY mode in X min.” will appear on the screen to indicate the remaining minutes.
- When the Auto Power Off function is set to “OFF”, “LED” is set to “On” automatically. Be sure to set the Auto Power Off function to “ON” to use the LED Off function. (See page 43.)

### Selecting the Transmission Speed (RS-232C)

Make sure that both the projector and computer are set for the same baud rate.

Selectable items	Description
9600bps	Transmission speed is slow. ↑↓ Transmission speed is rapid.
38400bps	
115200bps	

### Fan Mode Setting

This function changes the fan rotation speed.

Selectable items	Description
Normal	Suitable for normal environments.
High	Select this when using the projector at altitudes of approximately 4,900 feet (1,500 meters) or more.

- When “Fan Mode” is set to “High”, the fan rotation speeds up, and the fan noise becomes louder.

### Reversing/Inverting Projected Images

This function allows the projector to be used in a wider range of projection styles by allowing the image to be inverted to suit the projection environment (location).

Selectable items	Description
Front	Normal image (Projected from the front of the screen)
Ceiling + Front	Inverted image (Projected from the front of the screen with an inverted projector)
Rear	Reversed image (Projected from the rear of the screen or with a mirror)
Ceiling + Rear	Reversed and inverted image (Projected with a mirror)

- See page 15 for details of Projection (PRJ) Mode.

### Returning to the Default Settings

Use “All Reset” to initialize all the adjustments you have made to the default settings.

#### Note

The following items cannot be initialized.

- “Fine Sync” menu
  - Special Modes
- “Options” menu
  - Lamp Timer (Life)
  - Language

### Other Function

#### Selecting the On-screen Display Language

The projector can switch the on-screen display language among 11 languages.

English	Français	汉语
Deutsch	Italiano	한국어
Español	Svenska	日本語
Nederlands	Português	



# Maintenance Indicators/Maintenance

■ The maintenance indicators (power, lamp and temperature warning indicators) on the projector will let you be aware of problems inside the projector. If any of the indicators illuminates, follow the relevant procedures given below.

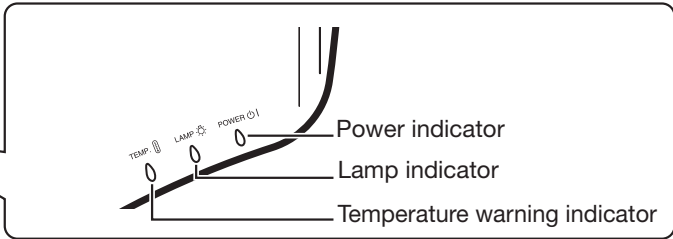
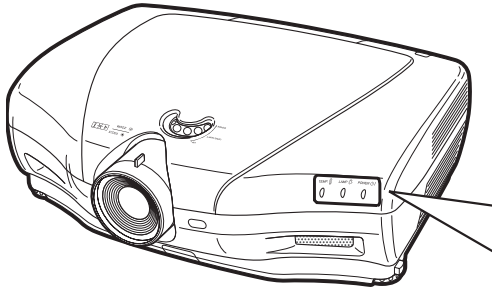



**About the temperature warning indicator**

If the temperature inside the projector increases, due to blockage of the exhaust or intake vent, or the setting location, “TEMP” will blink in the lower left corner of the picture. If the temperature keeps on rising, the lamp will turn off and the temperature warning indicator will blink, the cooling fan will run, then the projector will enter the standby mode. After “TEMP” appears, be sure to perform the measures described on the table below.



**About the lamp indicator**

■ When the remaining lamp life becomes 5% or less,  (yellow) and “Change The Lamp” will be displayed on the screen. When the percentage becomes 0%, it will change to , the lamp will automatically turn off and then the projector will automatically enter standby mode. At this time, the lamp indicator will illuminate in red.

■ **If you try to turn on the projector a fourth time without replacing the lamp, the projector will not turn on.**



Maintenance indicator		Condition	Problem	Possible Solution
Temperature warning indicator	Normal	Abnormal	<ul style="list-style-type: none"> <li>Blocked exhaust or intake vent</li> <li>Cooling fan breakdown</li> <li>Internal circuit failure</li> <li>Clogged exhaust or intake vent</li> </ul>	<ul style="list-style-type: none"> <li>Relocate the projector to an area with proper ventilation.</li> <li>Take the projector to your nearest Sharp Authorized Service Center or Dealer for repair.</li> <li>Clean the exhaust and intake vents according to the procedure on page 47.</li> </ul>
	Off	Red on (Standby)		
Lamp indicator	Blue on* (Blue blinks when the lamp is active.)	Red on (Standby)	<ul style="list-style-type: none"> <li>Burnt-out lamp</li> <li>Lamp circuit failure</li> </ul>	<ul style="list-style-type: none"> <li>Replace the lamp. (See page 48.) Take the projector to your nearest Sharp Authorized Service Center or Dealer for repair.</li> <li>Please exercise care when replacing the lamp.</li> <li>Securely install the lamp unit cover.</li> </ul>
		Red blinks	Lamp replacement time.	
Power indicator	Blue on*/Red on	Red blinks	<ul style="list-style-type: none"> <li>The power indicator blinks in red when the projector is on.</li> <li>The lamp unit cover is open.</li> </ul>	<ul style="list-style-type: none"> <li>Securely install the lamp unit cover.</li> <li>If the power indicator blinks even when the lamp unit cover is securely installed, contact your nearest Sharp Authorized Service Center or Dealer for advice.</li> </ul>

\* Blue is off when “LED” is set to “Off”. (See page 43.)

### Info

- If the temperature warning indicator illuminates and the projector enters the standby mode, ensure the exhaust and intake vents are not blocked (page 6) and then try turning the power back on. Wait until the projector has cooled down completely (at least 10 minutes) before plugging in the power cord and turning the power back on.
- If the power is turned off for a brief moment due to power outage or some other cause while using the projector, and the power supply recovers immediately after that, the lamp indicator will illuminate in red and the lamp may not be lit. In this case, unplug the power cord from the AC outlet, replace the power cord in the AC outlet and then turn the power on again.
- The speed and pitch of the cooling fan may change during operation in response to internal temperature changes. This is normal operation and does not indicate a malfunction.
- Do not unplug the power cord immediately after the projector has entered the standby mode or while the cooling fan is running. The cooling fan runs for about 90 seconds.

### Cleaning the projector

- Be sure to unplug the power cord before cleaning the projector.
- The cabinet as well as the operation panel is made of plastic. Avoid using benzene or thinner, as these can damage the finish on the cabinet.
- Do not use volatile agents such as insecticides on the projector.  
Do not attach rubber or plastic items to the projector for long periods.  
The effects of some of the agents in the plastic may cause damage to the quality or finish of the projector.
- Wipe off dirt gently with a soft flannel cloth.
- When the dirt is hard to remove, soak a cloth in a mild detergent diluted with water, wring the cloth well and then wipe the projector.  
Strong cleaning detergents may discolor, warp or damage the coating on the projector. Make sure to test on a small, inconspicuous area on the projector before use.

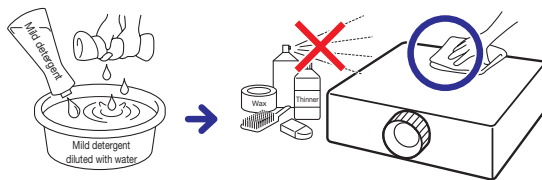

### Cleaning the lens

- Use a commercially available blower or lens cleaning paper (for glasses and camera lenses) for cleaning the lens. Do not use any liquid type cleaning agents, as they may wear off the coating film on the surface of the lens.
- As the surface of the lens can easily get damaged, be sure not to scrape or hit the lens.

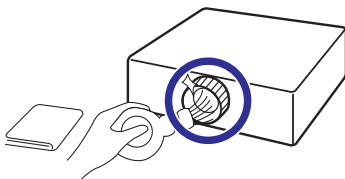

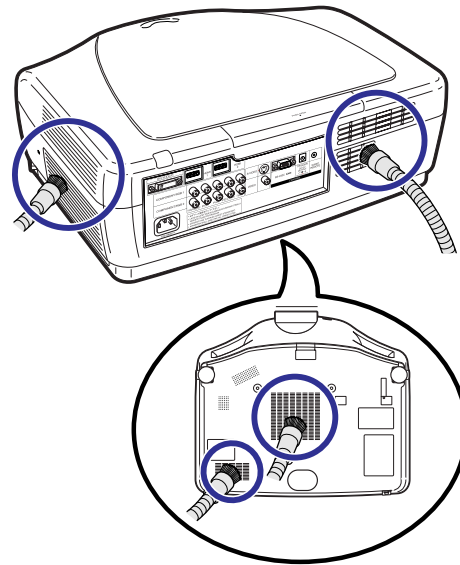

### Cleaning the exhaust and intake vents

- Use a vacuum cleaner to clean dust from the exhaust vent and the intake vent.
- The exhaust and intake vents should be cleaned every 100 hours of use. Clean the vents more often when the projector is used in a dirty or smoky location.



### Info

- If you want to clean the exhaust and intake vents during projector operation, be sure to press  STANDBY on the projector or  STANDBY on the remote control and put the projector into standby mode. After the cooling fan has stopped, clean the vents.



# Regarding the Lamp

## Lamp

- It is recommended that the lamp be replaced with a new one (sold separately) when the remaining lamp life becomes 5% or less, or when you notice a significant deterioration in the picture and color quality. The lamp life (percentage) can be checked with the on-screen display. (See page 43.)
- Purchase a replacement lamp of type AN-K20LP from your place of purchase, nearest Sharp Authorized Service Center or Dealer.

### IMPORTANT NOTE TO U.S. CUSTOMERS:

The lamp included with this projector is backed by a 90-day parts and labor limited warranty. All service of this projector under warranty, including lamp replacement, must be obtained through a Sharp Authorized Service Center or Dealer. For the name of the nearest Sharp Authorized Service Center or Dealer, please call toll-free: 1-888-GO-SHARP (1-888-467-4277).

Hg LAMP CONTAINS MERCURY For State Lamp Disposal Information  
[www.lamprecycle.org](http://www.lamprecycle.org) or 1-800-BE-SHARP

U.S.A. ONLY

## Caution Concerning the Lamp

- This projector utilizes a pressurized mercury lamp. A loud sound may indicate lamp failure. Lamp failure can be attributed to numerous sources such as: excessive shock, improper cooling, surface scratches or deterioration of the lamp due to a lapse of usage time.  
The period of time up to failure largely varies depending on the individual lamp and/or the condition and the frequency of use. It is important to note that failure can often result in the bulb cracking.
- When the lamp replacement indicator and on-screen display icon are illuminated, it is recommended that the lamp be replaced with a new one immediately, even if the lamp appears to be operating normally.
- Should the lamp break, the glass particles may spread inside the lamp cage or gas contained in the lamp may be vented into the room from the exhaust vent. Because the gas in this lamp includes mercury, ventilate the room well if the lamp breaks and avoid all exposure to the released gas. In case of exposure to the gas, consult a doctor as soon as possible.
- Should the lamp break, there is also a possibility that glass particles may spread inside of the projector. In such a case, it is recommended you contact your nearest Sharp Authorized Service Center or Dealer to assure safe operation.

## Replacing the Lamp

### Caution

- Do not remove the lamp unit from the projector right after use. The lamp will be very hot and may cause burn or injury.
- Wait at least **one hour** after the power cord is disconnected to allow the surface of the lamp unit to fully cool before removing the lamp unit.
- **Carefully change the lamp by following the instructions described in this section. \*If you wish, you may have the lamp replaced at your nearest Sharp Authorized Service Center or Dealer.**

\* If the new lamp does not light after replacement, take your projector to the nearest Sharp Authorized Service Center or Dealer for repair.

## Removing and Installing the Lamp Unit



- Warning!** • The lamp unit becomes very hot while the projector is operating. Do not remove the lamp unit from the projector right after use. The lamp and parts around the lamp will be very hot and may cause burns or injury.

### Info

- Be sure to remove the lamp unit by the handle. Be sure not to touch the glass surface of the lamp unit or the inside of the projector.
- To avoid injury to yourself and damage to the lamp, be sure to carefully follow the steps below.
- Do not loosen other screws than for the lamp unit cover and lamp unit.  
(As for the lamp unit, only the silver screws are loosened.)

**1** Press **STANDBY** on the projector or **STANDBY** on the remote control to put the projector into the standby mode.

- Wait until the cooling fan stops.

**2** **Disconnect the power cord.**

- Unplug the power cord from the AC socket.
- Leave the lamp until it has fully cooled down (about 1 hour).

**3** **Remove the lamp unit cover.**

- Loosen the user service screws that secure the lamp unit cover. Then open the cover in the direction of the arrow.

**4** **Remove the lamp unit.**

- Loosen the securing screws from the lamp unit. Hold the lamp unit by the handle and pull it in the direction of the arrow.

Optional accessory

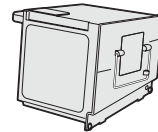

Lamp unit  
(Type: AN-K20LP)

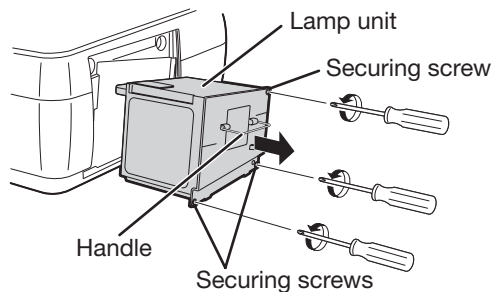
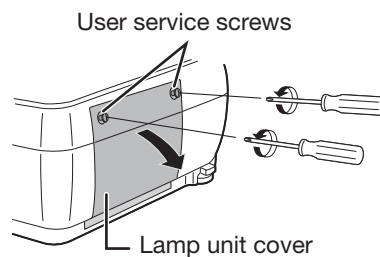
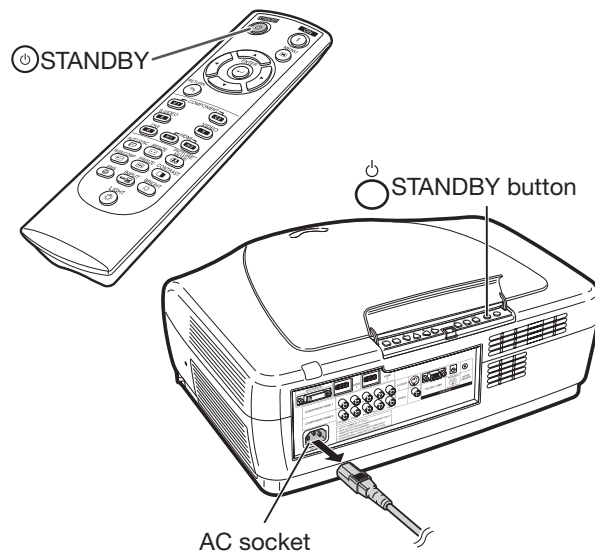

## Regarding the Lamp (Continued)

### 5 Insert the new lamp unit.

- Press the lamp unit firmly into the lamp unit compartment. Fasten the securing screws.

### 6 Attach the lamp unit cover.

- Close the lamp unit cover in the direction of the arrow. Then tighten the user service screws.

#### Info

- If the lamp unit and lamp unit cover are not correctly installed, the power will not turn on, even if the power cord is connected to the projector.

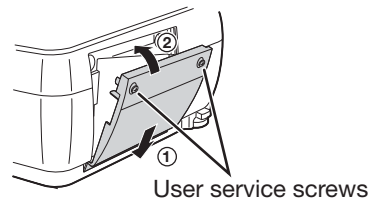
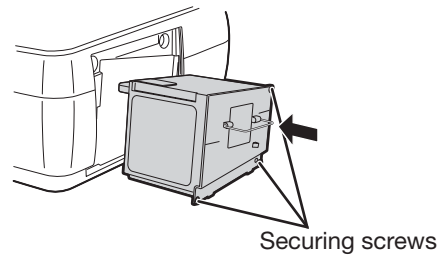

## Resetting the Lamp Timer

Reset the lamp timer after replacing the lamp.



#### Info

- Make sure to reset the lamp timer only when replacing the lamp. If you reset the lamp timer and continue to use the same lamp, this may cause the lamp to become damaged or explode.

### 1 Connect the power cord.

- Plug the power cord into the AC socket of the projector.

### 2 Reset the lamp timer.

- While holding down  ENTER, and  on the projector, press  ON on the projector.
- “LAMP 0000H” is displayed, indicating that the lamp timer is reset.

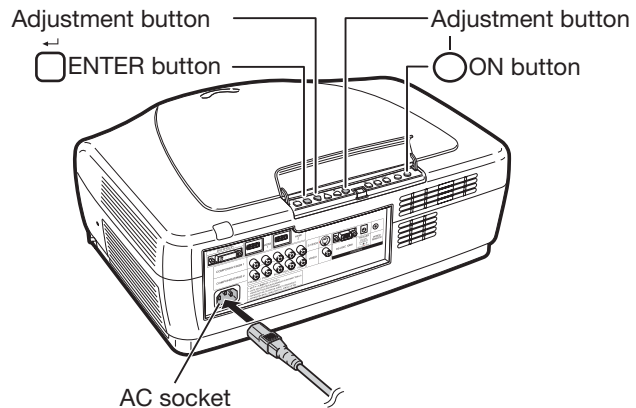

# Connecting Pin Assignments

## DVI-I Terminal: 29-pin connector

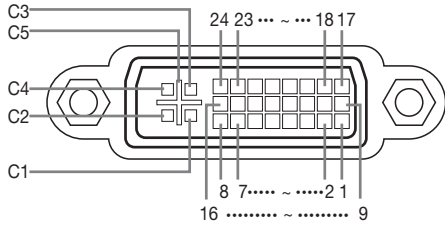

### • DVI Digital Input

Pin No.	Signal	Pin No.	Signal
1	T.M.D.S data 2-	16	Hot plug detection
2	T.M.D.S data 2+	17	T.M.D.S data 0-
3	T.M.D.S data 2 shield	18	T.M.D.S data 0+
4	Not connected	19	T.M.D.S data 0 shield
5	Not connected	20	Not connected
6	DDC clock	21	Not connected
7	DDC data	22	T.M.D.S clock shield
8	Not connected	23	T.M.D.S clock+
9	T.M.D.S data 1-	24	T.M.D.S clock-
10	T.M.D.S data 1+	C1	Not connected
11	T.M.D.S data 1 shield	C2	Not connected
12	Not connected	C3	Not connected
13	Not connected	C4	Not connected
14	+5V power	C5	Ground
15	Ground		

### • DVI Analog RGB Input

Pin No.	Signal	Pin No.	Signal
1	Not connected	16	Hot plug detection
2	Not connected	17	Not connected
3	Not connected	18	Not connected
4	Not connected	19	Not connected
5	Not connected	20	Not connected
6	DDC clock	21	Not connected
7	DDC data	22	Not connected
8	Vertical sync	23	Not connected
9	Not connected	24	Not connected
10	Not connected	C1	Analog input Red
11	Not connected	C2	Analog input Green
12	Not connected	C3	Analog input Blue
13	Not connected	C4	Horizontal sync
14	+5V power	C5	Ground
15	Ground		

### • DVI Analog Component Input

Pin No.	Signal	Pin No.	Signal
1	Not connected	16	Not connected
2	Not connected	17	Not connected
3	Not connected	18	Not connected
4	Not connected	19	Not connected
5	Not connected	20	Not connected
6	Not connected	21	Not connected
7	Not connected	22	Not connected
8	Not connected	23	Not connected
9	Not connected	24	Not connected
10	Not connected	C1	Analog input P <sub>R</sub> /C <sub>R</sub>
11	Not connected	C2	Analog input Y
12	Not connected	C3	Analog input P <sub>B</sub> /C <sub>B</sub>
13	Not connected	C4	Not connected
14	Not connected	C5	Ground
15	Ground		

## RS-232C Terminal: 9-pin D-sub male connector

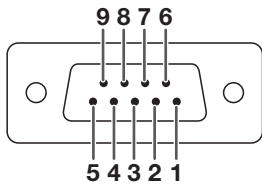

Pin No.	Signal	Name	I/O	Reference
1				Not connected
2	RD	Receive Data	Input	Connected to internal circuit
3	SD	Send Data	Output	Connected to internal circuit
4		Reserved		Connected to internal circuit
5	SG	Signal Ground		Connected to internal circuit
6		Reserved		Connected to internal circuit
7		Reserved		Connected to internal circuit
8		Reserved		Connected to internal circuit
9				Not connected

## HDMI Terminal

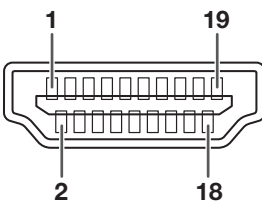

Pin No.	Name	Pin No.	Name	Pin No.	Name
1	T.M.D.S data 2+	8	T.M.D.S data 0 shield	14	Reserved
2	T.M.D.S data 2 shield	9	T.M.D.S data 0-	15	SCL
3	T.M.D.S data 2-	10	T.M.D.S clock+	16	SDA
4	T.M.D.S data 1+	11	T.M.D.S clock shield	17	DDC/CEC ground
5	T.M.D.S data 1 shield	12	T.M.D.S clock-	18	+5V power
6	T.M.D.S data 1-	13	CEC	19	Hot plug detection
7	T.M.D.S data 0+				



# RS-232C Specifications and Command Settings

## PC control

A computer can be used to control the projector by connecting an RS-232C cable (null modem, cross type, commercially available) to the projector. (See page 24 for connection.)

## Communication conditions

Set the serial port settings of the computer as follows.

Signal format: Conforms to RS-232C standard.

Baud rate\*: 9,600 bps / 38,400bps / 115,200bps

Data length: 8 bits

\*Use the same settings for the projector and computer.

Parity bit: None

Stop bit: 1 bit

Flow control: None

## Basic format

Send commands from the computer in the following order: command, parameter, and return code. After processing the command from the computer, the projector sends a response code to the computer.

Command format

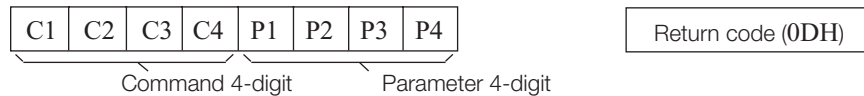

Response code format

Normal response

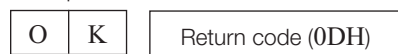

Problem response (communication error or incorrect command)



### Info

- If you are controlling the projector from a computer using RS-232C commands, wait at least 30 seconds after turning the projector on before sending any commands.
- When more than one code is being sent, send each command only after the response code for the previous command from the projector is verified.
- When using the computer control function of the projector, the projector's operating status cannot be read by the computer. Therefore, confirm the status by transmitting the display commands for each adjustment menu and checking the status with the on-screen display. If the projector receives a command other than a menu display command, it will execute the command without displaying the on-screen display.

## Commands

Example: To turn on the projector

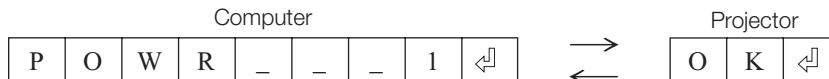

CONTROL CONTENTS	COMMAND								RETURN	
									Power ON	Standby mode (or 30-second startup time)
Power On	P	O	W	R	_	_	_	1	OK or ERR	OK
Power Off	P	O	W	R	_	_	_	0	OK or ERR	OK or ERR
Lamp Status	T	L	P	S	_	_	_	1	0:OFF, 1:ON, 2:Re-try 3:Waiting, 4:Lamp Error	0:OFF, 4:Lamp Error
Projector Condition	T	A	B	N	_	_	_	1	0:Normal, 1:Temp High, 8:Lamp Life 5% or less, 16:Lamp Burnt-out, 32:Lamp Ignition Failure	0:Normal, 1:Temp High, 2:Fan Error, 4:Lamp Cover Open, 8:Lamp Life 5% or less, 16:Lamp Burnt-out, 32:Lamp Ignition Failure, 64:Temp Abnormally High
Lamp Power Status	T	P	O	W	_	_	_	1	1:On, 2:Cooling 3:Shutting Down	0:Standby
Model Name Check	M	N	R	D	_	_	_	1	XV-Z20000/DT-5000	
C1 (COMPONENT1)	I	R	G	B	_	_	_	1	OK or ERR	ERR
C2 (COMPONENT2)	I	R	G	B	_	_	_	2	OK or ERR	ERR
S-VIDEO	I	V	E	D	_	_	_	1	OK or ERR	ERR
VIDEO	I	V	E	D	_	_	_	2	OK or ERR	ERR
DVI	I	R	G	B	_	_	_	3	OK or ERR	ERR
H1 (HDMI1)	I	R	G	B	_	_	_	4	OK or ERR	ERR
H2 (HDMI2)	I	R	G	B	_	_	_	5	OK or ERR	ERR

CONTROL CONTENTS		COMMAND				PARAMETER				RETURN		
										Power ON	Standby mode (or 30-second startup time)	
INPUT Check		I	C	H	K	?	?	?	?	1:COMPONENT1 2:COMPONENT2 3:S-VIDEO 4:VIDEO 5:DVI 6:HDMI1 7:HDMI2	ERR	
Freeze	Off	F	R	E	Z	--	--	--	0	OK or ERR	ERR	
	On	F	R	E	Z	--	--	--	1	OK or ERR	ERR	
Auto Sync Start		A	D	J	S	--	--	--	1	OK or ERR	ERR	
C1 INPUT RESIZE	NORMAL	R	A	S	R	--	--	--	1	OK or ERR	ERR	
	STRETCH	R	A	S	R	--	--	--	2	OK or ERR	ERR	
	SIDE BAR/DOTBYDOT	R	A	S	R	--	--	--	3	OK or ERR	ERR	
	SMART STRETCH	R	A	S	R	--	--	--	4	OK or ERR	ERR	
	CINEMA ZOOM	R	A	S	R	--	--	--	5	OK or ERR	ERR	
	ZOOM 14:9	R	A	S	R	--	--	--	7	OK or ERR	ERR	
	SMART ZOOM	R	A	S	R	--	--	--	6	OK or ERR	ERR	
C2 INPUT RESIZE	NORMAL	R	B	S	R	--	--	--	1	OK or ERR	ERR	
	STRETCH	R	B	S	R	--	--	--	2	OK or ERR	ERR	
	SIDE BAR/DOTBYDOT	R	B	S	R	--	--	--	3	OK or ERR	ERR	
	SMART STRETCH	R	B	S	R	--	--	--	4	OK or ERR	ERR	
	CINEMA ZOOM	R	B	S	R	--	--	--	5	OK or ERR	ERR	
	ZOOM 14:9	R	B	S	R	--	--	--	7	OK or ERR	ERR	
	SMART ZOOM	R	B	S	R	--	--	--	6	OK or ERR	ERR	
S-VIDEO INPUT RESIZE	STRETCH	R	A	S	V	--	--	--	2	OK or ERR	ERR	
	SIDE BAR	R	A	S	V	--	--	--	3	OK or ERR	ERR	
	SMART STRETCH	R	A	S	V	--	--	--	4	OK or ERR	ERR	
	CINEMA ZOOM	R	A	S	V	--	--	--	5	OK or ERR	ERR	
	ZOOM 14:9	R	A	S	V	--	--	--	7	OK or ERR	ERR	
	SMART ZOOM	R	A	S	V	--	--	--	6	OK or ERR	ERR	
	STRETCH	R	B	S	V	--	--	--	2	OK or ERR	ERR	
VIDEO INPUT RESIZE	SIDE BAR	R	B	S	V	--	--	--	3	OK or ERR	ERR	
	SMART STRETCH	R	B	S	V	--	--	--	4	OK or ERR	ERR	
	CINEMA ZOOM	R	B	S	V	--	--	--	5	OK or ERR	ERR	
	ZOOM 14:9	R	B	S	V	--	--	--	7	OK or ERR	ERR	
	SMART ZOOM	R	B	S	V	--	--	--	6	OK or ERR	ERR	
	STRETCH	R	C	S	R	--	--	--	1	OK or ERR	ERR	
	DVI INPUT RESIZE	STRETCH	R	C	S	R	--	--	--	2	OK or ERR	ERR
SIDE BAR/DOTBYDOT		R	C	S	R	--	--	--	3	OK or ERR	ERR	
SMART STRETCH		R	C	S	R	--	--	--	4	OK or ERR	ERR	
CINEMA ZOOM		R	C	S	R	--	--	--	5	OK or ERR	ERR	
ZOOM 14:9		R	C	S	R	--	--	--	7	OK or ERR	ERR	
SMART ZOOM		R	C	S	R	--	--	--	6	OK or ERR	ERR	
STRETCH		R	D	S	R	--	--	--	1	OK or ERR	ERR	
H1 INPUT RESIZE	STRETCH	R	D	S	R	--	--	--	2	OK or ERR	ERR	
	SIDE BAR/DOTBYDOT	R	D	S	R	--	--	--	3	OK or ERR	ERR	
	SMART STRETCH	R	D	S	R	--	--	--	4	OK or ERR	ERR	
	CINEMA ZOOM	R	D	S	R	--	--	--	5	OK or ERR	ERR	
	ZOOM 14:9	R	D	S	R	--	--	--	7	OK or ERR	ERR	
	SMART ZOOM	R	D	S	R	--	--	--	6	OK or ERR	ERR	
	STRETCH	R	E	S	R	--	--	--	1	OK or ERR	ERR	
H2 INPUT RESIZE	STRETCH	R	E	S	R	--	--	--	2	OK or ERR	ERR	
	SIDE BAR/DOTBYDOT	R	E	S	R	--	--	--	3	OK or ERR	ERR	
	SMART STRETCH	R	E	S	R	--	--	--	4	OK or ERR	ERR	
	CINEMA ZOOM	R	E	S	R	--	--	--	5	OK or ERR	ERR	
	ZOOM 14:9	R	E	S	R	--	--	--	7	OK or ERR	ERR	
	SMART ZOOM	R	E	S	R	--	--	--	6	OK or ERR	ERR	
	High Brightness	I	R	I	S	--	--	--	1	OK or ERR	ERR	
IRIS	Medium Mode	I	R	I	S	--	--	--	2	OK or ERR	ERR	
	High Contrast	I	R	I	S	--	--	--	3	OK or ERR	ERR	
	Eco + Quiet	T	H	M	D	--	--	--	0	OK or ERR	ERR	
Lamp Setting	Bright	T	H	M	D	--	--	--	1	OK or ERR	ERR	
	Picture Mode	R	A	P	S	--	--	--	1	OK or ERR	ERR	
C1 INPUT	Standard	Natural	R	A	P	S	--	--	--	2	OK or ERR	ERR
		Dynamic	R	A	P	S	--	--	--	3	OK or ERR	ERR
		Movie1	R	A	P	S	--	--	--	4	OK or ERR	ERR
		Movie2	R	A	P	S	--	--	--	5	OK or ERR	ERR
		Memory	R	A	P	S	--	--	--	0	OK or ERR	ERR
		Contrast (-90 --- +90)	R	A	P	I	--	*	*	*	OK or ERR	ERR
	Bright (-90 --- +90)	R	A	B	R	--	*	*	*	OK or ERR	ERR	
	Color (-30 --- +30)	R	A	C	O	--	*	*	*	OK or ERR	ERR	
	Tint (-30 --- +30)	R	A	T	I	--	*	*	*	OK or ERR	ERR	
	Sharp (-30 --- +30)	R	A	S	H	--	*	*	*	OK or ERR	ERR	
	CLR Temp *1	R	A	C	T	--	*	*	*	OK or ERR	ERR	
	BrilliantColor™	Off	R	A	W	E	--	--	--	0	OK or ERR	ERR
		On	R	A	W	E	--	--	--	1	OK or ERR	ERR
	Gamma Position	Standard	G	M	R	A	--	--	--	0	OK or ERR	ERR
		Natural	G	M	R	A	--	--	--	1	OK or ERR	ERR
		Dynamic	G	M	R	A	--	--	--	2	OK or ERR	ERR
		Movie1	G	M	R	A	--	--	--	3	OK or ERR	ERR
		Movie2	G	M	R	A	--	--	--	4	OK or ERR	ERR
		Custom	G	M	R	A	--	--	--	5	OK or ERR	ERR
	Progressive	3D Fast	R	A	I	P	--	--	1	0	OK or ERR	ERR
		3D Slow	R	A	I	P	--	--	1	1	OK or ERR	ERR
		2D+	R	A	I	P	--	--	1	2	OK or ERR	ERR
	Film Mode	Auto	R	A	F	M	--	--	--	0	OK or ERR	ERR
		Off	R	A	F	M	--	--	--	1	OK or ERR	ERR
	DNR	Off	R	A	N	R	--	--	--	0	OK or ERR	ERR
		Level1	R	A	N	R	--	--	--	1	OK or ERR	ERR
		Level2	R	A	N	R	--	--	--	2	OK or ERR	ERR
Level3		R	A	N	R	--	--	--	3	OK or ERR	ERR	
MNR	Off	R	A	M	R	--	--	--	0	OK or ERR	ERR	
	Level1	R	A	M	R	--	--	--	1	OK or ERR	ERR	
	Level2	R	A	M	R	--	--	--	2	OK or ERR	ERR	
	Level3	R	A	M	R	--	--	--	3	OK or ERR	ERR	

CONTROL CONTENTS		COMMAND		PARAMETER				RETURN				
								Power ON	Standby mode (or 30-second startup time)			
C1 INPUT	Unveill Control	Off	R	A	U	C	--	--	0	OK or ERR	ERR	
		Level1	R	A	U	C	--	--	1	OK or ERR	ERR	
		Level2	R	A	U	C	--	--	2	OK or ERR	ERR	
	Automatic Contrast	Level3	R	A	U	C	--	--	3	OK or ERR	ERR	
		Off	R	A	A	C	--	--	0	OK or ERR	ERR	
		Level1	R	A	A	C	--	--	1	OK or ERR	ERR	
	Picture Reset	Level2	R	A	A	C	--	--	2	OK or ERR	ERR	
		Level3	R	A	A	C	--	--	3	OK or ERR	ERR	
		Picture Reset	R	A	R	E	--	--	1	OK or ERR	ERR	
	C2 INPUT	Picture Mode	Standard	G	M	R	A	--	--	0	OK or ERR	ERR
			Natural	R	B	P	S	--	--	2	OK or ERR	ERR
			Dynamic	R	B	P	S	--	--	3	OK or ERR	ERR
Movie1			R	B	P	S	--	--	4	OK or ERR	ERR	
Movie2			R	B	P	S	--	--	5	OK or ERR	ERR	
Memory			R	B	P	S	--	--	0	OK or ERR	ERR	
Contrast (-90 — +90)		R	B	P	I	--	*	*	*	OK or ERR	ERR	
Bright (-90 — +90)		R	B	B	R	--	*	*	*	OK or ERR	ERR	
Color (-30 — +30)		R	B	C	O	--	*	*	*	OK or ERR	ERR	
Tint (-30 — +30)		R	B	T	I	--	*	*	*	OK or ERR	ERR	
Sharp (-30 — +30)		R	B	S	H	--	*	*	*	OK or ERR	ERR	
CLR Temp *1		R	B	C	T	--	*	*	*	OK or ERR	ERR	
BrilliantColor™		Off	R	B	W	E	--	--	0	OK or ERR	ERR	
		On	R	B	W	E	--	--	1	OK or ERR	ERR	
Gamma Position		Standard	G	M	R	B	--	--	0	OK or ERR	ERR	
		Natural	G	M	R	B	--	--	1	OK or ERR	ERR	
		Dynamic	G	M	R	B	--	--	2	OK or ERR	ERR	
		Movie1	G	M	R	B	--	--	3	OK or ERR	ERR	
		Movie2	G	M	R	B	--	--	4	OK or ERR	ERR	
		Custom	G	M	R	B	--	--	5	OK or ERR	ERR	
Progressive		3D Fast	R	B	I	P	--	--	1	0	OK or ERR	ERR
		3D Slow	R	B	I	P	--	--	1	1	OK or ERR	ERR
		2D+	R	B	I	P	--	--	1	2	OK or ERR	ERR
Film Mode		Auto	R	B	F	M	--	--	0	OK or ERR	ERR	
		Off	R	B	F	M	--	--	1	OK or ERR	ERR	
DNR		Off	R	B	N	R	--	--	0	OK or ERR	ERR	
		Level1	R	B	N	R	--	--	1	OK or ERR	ERR	
		Level2	R	B	N	R	--	--	2	OK or ERR	ERR	
		Level3	R	B	N	R	--	--	3	OK or ERR	ERR	
MNR		Off	R	B	M	R	--	--	0	OK or ERR	ERR	
		Level1	R	B	M	R	--	--	1	OK or ERR	ERR	
		Level2	R	B	M	R	--	--	2	OK or ERR	ERR	
Unveill Control		Level3	R	B	M	R	--	--	3	OK or ERR	ERR	
		Off	R	B	U	C	--	--	0	OK or ERR	ERR	
		Level1	R	B	U	C	--	--	1	OK or ERR	ERR	
Automatic Contrast		Level2	R	B	U	C	--	--	2	OK or ERR	ERR	
		Level3	R	B	U	C	--	--	3	OK or ERR	ERR	
		Off	R	B	A	C	--	--	0	OK or ERR	ERR	
Picture Reset		Level1	R	B	A	C	--	--	1	OK or ERR	ERR	
		Level2	R	B	A	C	--	--	2	OK or ERR	ERR	
		Level3	R	B	A	C	--	--	3	OK or ERR	ERR	
S-VIDEO INPUT		Picture Mode	Standard	V	A	P	S	--	--	1	OK or ERR	ERR
			Natural	V	A	P	S	--	--	2	OK or ERR	ERR
			Dynamic	V	A	P	S	--	--	3	OK or ERR	ERR
			Movie1	V	A	P	S	--	--	4	OK or ERR	ERR
			Movie2	V	A	P	S	--	--	5	OK or ERR	ERR
			Memory	V	A	P	S	--	--	0	OK or ERR	ERR
		Contrast (-90 — +90)	V	A	P	I	--	*	*	*	OK or ERR	ERR
	Bright (-90 — +90)	V	A	B	R	--	*	*	*	OK or ERR	ERR	
	Color (-30 — +30)	V	A	C	O	--	*	*	*	OK or ERR	ERR	
	Tint (-30 — +30)	V	A	T	I	--	*	*	*	OK or ERR	ERR	
	Sharp (-30 — +30)	V	A	S	H	--	*	*	*	OK or ERR	ERR	
	CLR Temp *1	V	A	C	T	--	*	*	*	OK or ERR	ERR	
	BrilliantColor™	Off	V	A	W	E	--	--	0	OK or ERR	ERR	
		On	V	A	W	E	--	--	1	OK or ERR	ERR	
	Gamma Position	Standard	G	M	V	A	--	--	0	OK or ERR	ERR	
		Natural	G	M	V	A	--	--	1	OK or ERR	ERR	
		Dynamic	G	M	V	A	--	--	2	OK or ERR	ERR	
		Movie1	G	M	V	A	--	--	3	OK or ERR	ERR	
		Movie2	G	M	V	A	--	--	4	OK or ERR	ERR	
		Custom	G	M	V	A	--	--	5	OK or ERR	ERR	
	Progressive	3D Fast	V	A	I	P	--	--	1	0	OK or ERR	ERR
		3D Slow	V	A	I	P	--	--	1	1	OK or ERR	ERR
		2D+	V	A	I	P	--	--	1	2	OK or ERR	ERR
	Film Mode	Auto	V	A	F	M	--	--	0	OK or ERR	ERR	
		Off	V	A	F	M	--	--	1	OK or ERR	ERR	
	DNR	Off	V	A	N	R	--	--	0	OK or ERR	ERR	
		Level1	V	A	N	R	--	--	1	OK or ERR	ERR	
		Level2	V	A	N	R	--	--	2	OK or ERR	ERR	
		Level3	V	A	N	R	--	--	3	OK or ERR	ERR	
	MNR	Off	V	A	M	R	--	--	0	OK or ERR	ERR	
		Level1	V	A	M	R	--	--	1	OK or ERR	ERR	
		Level2	V	A	M	R	--	--	2	OK or ERR	ERR	
	Unveill Control	Level3	V	A	M	R	--	--	3	OK or ERR	ERR	
		Off	V	A	U	C	--	--	0	OK or ERR	ERR	
		Level1	V	A	U	C	--	--	1	OK or ERR	ERR	
	Automatic Contrast	Level2	V	A	U	C	--	--	2	OK or ERR	ERR	
		Level3	V	A	U	C	--	--	3	OK or ERR	ERR	
		Off	V	A	A	C	--	--	0	OK or ERR	ERR	
	Picture Reset	Level1	V	A	A	C	--	--	1	OK or ERR	ERR	
		Level2	V	A	A	C	--	--	2	OK or ERR	ERR	
		Level3	V	A	A	C	--	--	3	OK or ERR	ERR	
	Picture Reset	V	A	R	E	--	--	1	OK or ERR	ERR		

CONTROL CONTENTS			COMMAND				PARAMETER				RETURN		
											Power ON	Standby mode (or 30-second startup time)	
VIDEO INPUT	Picture Mode	Standard	V	B	P	S	--	--	--	1	OK or ERR	ERR	
		Natural	V	B	P	S	--	--	--	2	OK or ERR	ERR	
		Dynamic	V	B	P	S	--	--	--	3	OK or ERR	ERR	
		Movie1	V	B	P	S	--	--	--	4	OK or ERR	ERR	
		Movie2	V	B	P	S	--	--	--	5	OK or ERR	ERR	
		Memory	V	B	P	S	--	--	--	0	OK or ERR	ERR	
	Contrast (-90 — +90)		V	B	P	I	--	*	*	*	OK or ERR	ERR	
	Bright (-90 — +90)		V	B	B	R	--	*	*	*	OK or ERR	ERR	
	Color (-30 — +30)		V	B	C	O	--	*	*	*	OK or ERR	ERR	
	Tint (-30 — +30)		V	B	T	I	--	*	*	*	OK or ERR	ERR	
	Sharp (-30 — +30)		V	B	S	H	--	*	*	*	OK or ERR	ERR	
	CLR Temp *1		V	B	C	T	*	*	*	*	OK or ERR	ERR	
	BrilliantColor™	Off	V	B	W	E	--	--	--	0	OK or ERR	ERR	
		On	V	B	W	E	--	--	--	1	OK or ERR	ERR	
	Gamma Position	Standard	G	M	V	B	--	--	--	0	OK or ERR	ERR	
		Natural	G	M	V	B	--	--	--	1	OK or ERR	ERR	
		Dynamic	G	M	V	B	--	--	--	2	OK or ERR	ERR	
		Movie1	G	M	V	B	--	--	--	3	OK or ERR	ERR	
		Movie2	G	M	V	B	--	--	--	4	OK or ERR	ERR	
		Custom	G	M	V	B	--	--	--	5	OK or ERR	ERR	
	Progressive	3D Fast	V	B	I	P	--	--	1	0	OK or ERR	ERR	
		3D Slow	V	B	I	P	--	--	1	1	OK or ERR	ERR	
		2D+	V	B	I	P	--	--	1	2	OK or ERR	ERR	
	Film Mode	Auto	V	B	F	M	--	--	--	0	OK or ERR	ERR	
		Off	V	B	F	M	--	--	--	1	OK or ERR	ERR	
	DNR	Off	V	B	N	R	--	--	--	0	OK or ERR	ERR	
		Level1	V	B	N	R	--	--	--	1	OK or ERR	ERR	
		Level2	V	B	N	R	--	--	--	2	OK or ERR	ERR	
		Level3	V	B	N	R	--	--	--	3	OK or ERR	ERR	
	MNR	Off	V	B	M	R	--	--	--	0	OK or ERR	ERR	
		Level1	V	B	M	R	--	--	--	1	OK or ERR	ERR	
		Level2	V	B	M	R	--	--	--	2	OK or ERR	ERR	
		Level3	V	B	M	R	--	--	--	3	OK or ERR	ERR	
	Unveil Control	Off	V	B	U	C	--	--	--	0	OK or ERR	ERR	
		Level1	V	B	U	C	--	--	--	1	OK or ERR	ERR	
		Level2	V	B	U	C	--	--	--	2	OK or ERR	ERR	
		Level3	V	B	U	C	--	--	--	3	OK or ERR	ERR	
	Automatic Contrast	Off	V	B	A	C	--	--	--	0	OK or ERR	ERR	
		Level1	V	B	A	C	--	--	--	1	OK or ERR	ERR	
		Level2	V	B	A	C	--	--	--	2	OK or ERR	ERR	
		Level3	V	B	A	C	--	--	--	3	OK or ERR	ERR	
	Picture Reset		V	B	R	E	--	--	--	1	OK or ERR	ERR	
	DVI INPUT	Picture Mode	Standard	R	C	P	S	--	--	--	1	OK or ERR	ERR
			Natural	R	C	P	S	--	--	--	2	OK or ERR	ERR
			Dynamic	R	C	P	S	--	--	--	3	OK or ERR	ERR
Movie1			R	C	P	S	--	--	--	4	OK or ERR	ERR	
Movie2			R	C	P	S	--	--	--	5	OK or ERR	ERR	
Memory			R	C	P	S	--	--	--	0	OK or ERR	ERR	
Contrast (-90 — +90)			R	C	P	I	--	*	*	*	OK or ERR	ERR	
Bright (-90 — +90)			R	C	B	R	--	*	*	*	OK or ERR	ERR	
Color (-30 — +30)			R	C	C	O	--	*	*	*	OK or ERR	ERR	
Tint (-30 — +30)			R	C	T	I	--	*	*	*	OK or ERR	ERR	
Sharp (-30 — +30)			R	C	S	H	--	*	*	*	OK or ERR	ERR	
CLR Temp *1			R	C	C	T	*	*	*	*	OK or ERR	ERR	
BrilliantColor™		Off	R	C	W	E	--	--	--	0	OK or ERR	ERR	
		On	R	C	W	E	--	--	--	1	OK or ERR	ERR	
Gamma Position		Standard	G	M	R	C	--	--	--	0	OK or ERR	ERR	
		Natural	G	M	R	C	--	--	--	1	OK or ERR	ERR	
		Dynamic	G	M	R	C	--	--	--	2	OK or ERR	ERR	
		Movie1	G	M	R	C	--	--	--	3	OK or ERR	ERR	
		Movie2	G	M	R	C	--	--	--	4	OK or ERR	ERR	
		Custom	G	M	R	C	--	--	--	5	OK or ERR	ERR	
Progressive		3D Fast	R	C	I	P	--	--	1	0	OK or ERR	ERR	
		3D Slow	R	C	I	P	--	--	1	1	OK or ERR	ERR	
		2D+	R	C	I	P	--	--	1	2	OK or ERR	ERR	
Film Mode		Auto	R	C	F	M	--	--	--	0	OK or ERR	ERR	
		Off	R	C	F	M	--	--	--	1	OK or ERR	ERR	
DNR		Off	R	C	N	R	--	--	--	0	OK or ERR	ERR	
		Level1	R	C	N	R	--	--	--	1	OK or ERR	ERR	
		Level2	R	C	N	R	--	--	--	2	OK or ERR	ERR	
		Level3	R	C	N	R	--	--	--	3	OK or ERR	ERR	
MNR		Off	R	C	M	R	--	--	--	0	OK or ERR	ERR	
		Level1	R	C	M	R	--	--	--	1	OK or ERR	ERR	
		Level2	R	C	M	R	--	--	--	2	OK or ERR	ERR	
		Level3	R	C	M	R	--	--	--	3	OK or ERR	ERR	
Unveil Control		Off	R	C	U	C	--	--	--	0	OK or ERR	ERR	
		Level1	R	C	U	C	--	--	--	1	OK or ERR	ERR	
		Level2	R	C	U	C	--	--	--	2	OK or ERR	ERR	
		Level3	R	C	U	C	--	--	--	3	OK or ERR	ERR	
Automatic Contrast		Off	R	C	A	C	--	--	--	0	OK or ERR	ERR	
		Level1	R	C	A	C	--	--	--	1	OK or ERR	ERR	
		Level2	R	C	A	C	--	--	--	2	OK or ERR	ERR	
		Level3	R	C	A	C	--	--	--	3	OK or ERR	ERR	
Picture Reset			R	C	R	E	--	--	--	1	OK or ERR	ERR	
H1 INPUT		Picture Mode	Standard	R	D	P	S	--	--	--	1	OK or ERR	ERR
			Natural	R	D	P	S	--	--	--	2	OK or ERR	ERR
			Dynamic	R	D	P	S	--	--	--	3	OK or ERR	ERR
	Movie1		R	D	P	S	--	--	--	4	OK or ERR	ERR	
	Movie2		R	D	P	S	--	--	--	5	OK or ERR	ERR	
	Memory		R	D	P	S	--	--	--	0	OK or ERR	ERR	
	Contrast (-90 — +90)		R	D	P	I	--	*	*	*	OK or ERR	ERR	
	Bright (-90 — +90)		R	D	B	R	--	*	*	*	OK or ERR	ERR	
	Color (-30 — +30)		R	D	C	O	--	*	*	*	OK or ERR	ERR	



CONTROL CONTENTS	COMMAND	PARAMETER	RETURN				
			Power ON	Standby mode (or 30-second startup time)			
H1 INPUT	Tint (-30 — +30)	R D T I	— * * *	OK or ERR	ERR		
	Sharp (-30 — +30)	R D S H	— * * *	OK or ERR	ERR		
	CLR Temp *1	R D C T	* * * *	OK or ERR	ERR		
	BrilliantColor™	Off	R D W E	— — — 0	OK or ERR	ERR	
		On	R D W E	— — — 1	OK or ERR	ERR	
	Gamma Position	Standard	G M R D	— — — 0	OK or ERR	ERR	
		Natural	G M R D	— — — 1	OK or ERR	ERR	
		Dynamic	G M R D	— — — 2	OK or ERR	ERR	
		Movie1	G M R D	— — — 3	OK or ERR	ERR	
		Movie2	G M R D	— — — 4	OK or ERR	ERR	
	Progressive	Custom	G M R D	— — — 5	OK or ERR	ERR	
		3D Fast	R D I P	— — — 1 0	OK or ERR	ERR	
		3D Slow	R D I P	— — — 1 1	OK or ERR	ERR	
		2D+	R D I P	— — — 1 2	OK or ERR	ERR	
	Film Mode	Auto	R D F M	— — — 0	OK or ERR	ERR	
		Off	R D F M	— — — 1	OK or ERR	ERR	
	DNR	Off	R D N R	— — — 0	OK or ERR	ERR	
		Level1	R D N R	— — — 1	OK or ERR	ERR	
		Level2	R D N R	— — — 2	OK or ERR	ERR	
		Level3	R D N R	— — — 3	OK or ERR	ERR	
	MNR	Off	R D M R	— — — 0	OK or ERR	ERR	
		Level1	R D M R	— — — 1	OK or ERR	ERR	
		Level2	R D M R	— — — 2	OK or ERR	ERR	
		Level3	R D M R	— — — 3	OK or ERR	ERR	
	Unveil Control	Off	R D U C	— — — 0	OK or ERR	ERR	
		Level1	R D U C	— — — 1	OK or ERR	ERR	
		Level2	R D U C	— — — 2	OK or ERR	ERR	
		Level3	R D U C	— — — 3	OK or ERR	ERR	
	Automatic Contrast	Off	R D A C	— — — 0	OK or ERR	ERR	
		Level1	R D A C	— — — 1	OK or ERR	ERR	
		Level2	R D A C	— — — 2	OK or ERR	ERR	
		Level3	R D A C	— — — 3	OK or ERR	ERR	
	Picture Reset	R D R E	— — — 1	OK or ERR	ERR		
	H2 INPUT	Picture Mode	Standard	R E P S	— — — 1	OK or ERR	ERR
			Natural	R E P S	— — — 2	OK or ERR	ERR
			Dynamic	R E P S	— — — 3	OK or ERR	ERR
			Movie1	R E P S	— — — 4	OK or ERR	ERR
			Movie2	R E P S	— — — 5	OK or ERR	ERR
Memory			R E P S	— — — 0	OK or ERR	ERR	
Contrast (-90 — +90)		R E P I	— * * *	OK or ERR	ERR		
Bright (-90 — +90)		R E B R	— * * *	OK or ERR	ERR		
Color (-30 — +30)		R E C O	— * * *	OK or ERR	ERR		
Tint (-30 — +30)		R E T I	— * * *	OK or ERR	ERR		
Sharp (-30 — +30)		R E S H	— * * *	OK or ERR	ERR		
CLR Temp *1		R E C T	* * * *	OK or ERR	ERR		
BrilliantColor™		Off	R E W E	— — — 0	OK or ERR	ERR	
		On	R E W E	— — — 1	OK or ERR	ERR	
Gamma Position		Standard	G M R Z	— — — 0	OK or ERR	ERR	
		Natural	G M R Z	— — — 1	OK or ERR	ERR	
		Dynamic	G M R Z	— — — 2	OK or ERR	ERR	
		Movie1	G M R Z	— — — 3	OK or ERR	ERR	
		Movie2	G M R Z	— — — 4	OK or ERR	ERR	
		Custom	G M R Z	— — — 5	OK or ERR	ERR	
Progressive		3D Fast	R E I P	— — — 1 0	OK or ERR	ERR	
		3D Slow	R E I P	— — — 1 1	OK or ERR	ERR	
		2D+	R E I P	— — — 1 2	OK or ERR	ERR	
Film Mode		Auto	R E F M	— — — 0	OK or ERR	ERR	
		Off	R E F M	— — — 1	OK or ERR	ERR	
DNR		Off	R E N R	— — — 0	OK or ERR	ERR	
		Level1	R E N R	— — — 1	OK or ERR	ERR	
		Level2	R E N R	— — — 2	OK or ERR	ERR	
		Level3	R E N R	— — — 3	OK or ERR	ERR	
MNR		Off	R E M R	— — — 0	OK or ERR	ERR	
		Level1	R E M R	— — — 1	OK or ERR	ERR	
		Level2	R E M R	— — — 2	OK or ERR	ERR	
		Level3	R E M R	— — — 3	OK or ERR	ERR	
Unveil Control		Off	R E U C	— — — 0	OK or ERR	ERR	
		Level1	R E U C	— — — 1	OK or ERR	ERR	
		Level2	R E U C	— — — 2	OK or ERR	ERR	
		Level3	R E U C	— — — 3	OK or ERR	ERR	
Automatic Contrast		Off	R E A C	— — — 0	OK or ERR	ERR	
	Level1	R E A C	— — — 1	OK or ERR	ERR		
	Level2	R E A C	— — — 2	OK or ERR	ERR		
	Level3	R E A C	— — — 3	OK or ERR	ERR		
Picture Reset	R E R E	— — — 1	OK or ERR	ERR			
All Colors-Gamma (-10 — +10)	G M E W	— * * *	OK or ERR	ERR			
Red-Gamma (-30 — +30)	G M E R	— * * *	OK or ERR	ERR			
Green-Gamma (-30 — +30)	G M E G	— * * *	OK or ERR	ERR			
Blue-Gamma (-30 — +30)	G M E B	— * * *	OK or ERR	ERR			
All Colors-White Detail (-10 — +10)	G M G W	— * * *	OK or ERR	ERR			
Red-White Detail (-30 — +30)	G M G R	— * * *	OK or ERR	ERR			
Green-White Detail (-30 — +30)	G M G G	— * * *	OK or ERR	ERR			
Blue-White Detail (-30 — +30)	G M G B	— * * *	OK or ERR	ERR			
All Colors-Black Detail (-10 — +10)	G M O W	— * * *	OK or ERR	ERR			
Red-Black Detail (-30 — +30)	G M O R	— * * *	OK or ERR	ERR			
Green-Black Detail (-30 — +30)	G M O G	— * * *	OK or ERR	ERR			
Blue-Black Detail (-30 — +30)	G M O B	— * * *	OK or ERR	ERR			
Gamma Reset	G M R E	— — — 1	OK or ERR	ERR			
C.M.S. R-Hue (-30 — +30)	C M H R	— * * *	OK or ERR	ERR			
C.M.S. Y-Hue (-30 — +30)	C M H Y	— * * *	OK or ERR	ERR			
C.M.S. G-Hue (-30 — +30)	C M H G	— * * *	OK or ERR	ERR			
C.M.S. C-Hue (-30 — +30)	C M H C	— * * *	OK or ERR	ERR			
C.M.S. B-Hue (-30 — +30)	C M H B	— * * *	OK or ERR	ERR			

CONTROL CONTENTS	COMMAND				PARAMETER				RETURN	
									Power ON	Standby mode (or 30-second startup time)
C.M.S. M-Hue (-30 ~ +30)	C	M	H	M	--	*	*	*	OK or ERR	ERR
C.M.S. Hue Reset	C	M	R	E	--	--	--	2	OK or ERR	ERR
C.M.S. R-Saturation (-30 ~ +30)	C	M	S	R	--	*	*	*	OK or ERR	ERR
C.M.S. Y-Saturation (-30 ~ +30)	C	M	S	Y	--	*	*	*	OK or ERR	ERR
C.M.S. G-Saturation (-30 ~ +30)	C	M	S	G	--	*	*	*	OK or ERR	ERR
C.M.S. C-Saturation (-30 ~ +30)	C	M	S	C	--	*	*	*	OK or ERR	ERR
C.M.S. B-Saturation (-30 ~ +30)	C	M	S	B	--	*	*	*	OK or ERR	ERR
C.M.S. M-Saturation (-30 ~ +30)	C	M	S	M	--	*	*	*	OK or ERR	ERR
C.M.S. Saturation Reset	C	M	R	E	--	--	--	3	OK or ERR	ERR
C.M.S. R-Value (-30 ~ +30)	C	M	V	R	--	*	*	*	OK or ERR	ERR
C.M.S. Y-Value (-30 ~ +30)	C	M	V	Y	--	*	*	*	OK or ERR	ERR
C.M.S. G-Value (-30 ~ +30)	C	M	V	G	--	*	*	*	OK or ERR	ERR
C.M.S. C-Value (-30 ~ +30)	C	M	V	C	--	*	*	*	OK or ERR	ERR
C.M.S. B-Value (-30 ~ +30)	C	M	V	B	--	*	*	*	OK or ERR	ERR
C.M.S. M-Value (-30 ~ +30)	C	M	V	M	--	*	*	*	OK or ERR	ERR
C.M.S. Value Reset	C	M	R	E	--	--	--	4	OK or ERR	ERR
C.M.S. All Reset	C	M	R	E	--	--	--	1	OK or ERR	ERR
Clock (-150 ~ +150)	I	N	C	L	*	*	*	*	OK or ERR	ERR
Phase (-60 ~ +60)	I	N	P	H	--	*	*	*	OK or ERR	ERR
H-Pos (-150 ~ +150)	I	A	H	P	*	*	*	*	OK or ERR	ERR
V-Pos (-60 ~ +60)	I	A	V	P	--	*	*	*	OK or ERR	ERR
Fine Reset	I	A	R	E	--	--	--	1	OK or ERR	ERR
RGB Horizontal Frequency Check	T	F	R	Q	--	--	--	1	OK or ERR	ERR
RGB Vertical Frequency Check	T	F	R	Q	--	--	--	2	OK or ERR	ERR
Auto Sync	Off	A	A	D	J	--	--	0	OK or ERR	ERR
Normal	A	A	D	J	--	--	--	1	OK or ERR	ERR
High Speed	A	A	D	J	--	--	--	2	OK or ERR	ERR
Image Shift (-30 ~ +30)	S	T	S	H	--	*	*	*	OK or ERR	ERR
Subtitle (-30 ~ +30)	S	T	S	Z	--	*	*	*	OK or ERR	ERR
Overscan (10% ~ 0%) *2	O	V	S	N	--	*	*	*	OK or ERR	ERR
Options Reset	O	P	R	E	--	--	--	1	OK or ERR	ERR
C1 White Level (-30 ~ +30)	R	A	I	G	--	*	*	*	OK or ERR	ERR
C2 White Level (-30 ~ +30)	R	B	I	G	--	*	*	*	OK or ERR	ERR
S-Video White Level (-30 ~ +30)	V	A	I	G	--	*	*	*	OK or ERR	ERR
Video White Level (-30 ~ +30)	V	B	I	G	--	*	*	*	OK or ERR	ERR
DVI White Level (-30 ~ +30)	R	C	I	G	--	*	*	*	OK or ERR	ERR
C1 Black Level (-30 ~ +30)	R	A	I	O	--	*	*	*	OK or ERR	ERR
C2 Black Level (-30 ~ +30)	R	B	I	O	--	*	*	*	OK or ERR	ERR
S-Video Black Level (-30 ~ +30)	V	A	I	O	--	*	*	*	OK or ERR	ERR
Video Black Level (-30 ~ +30)	V	B	I	O	--	*	*	*	OK or ERR	ERR
DVI Black Level (-30 ~ +30)	R	C	I	O	--	*	*	*	OK or ERR	ERR
LED	Off	L	E	D	S	--	--	0	OK or ERR	ERR
On	L	E	D	S	--	--	--	1	OK or ERR	ERR
Lamp Usage Time (Hour)	T	L	T	T	--	--	--	1	0 ~ 9999(Integer)	
Lamp Life (Percentage)	T	L	T	L	--	--	--	1	0% ~ 100%(Integer)	
OSD Display	Off	I	M	D	I	--	--	0	OK or ERR	ERR
On	I	M	D	I	--	--	--	1	OK or ERR	ERR
C1 INPUT	Auto	I	A	S	I	--	--	0	OK or ERR	ERR
Signal Type	RGB	I	A	S	I	--	--	1	OK or ERR	ERR
Component	I	A	S	I	--	--	--	2	OK or ERR	ERR
C2 INPUT	Auto	I	B	S	I	--	--	0	OK or ERR	ERR
Signal Type	RGB	I	B	S	I	--	--	1	OK or ERR	ERR
Component	I	B	S	I	--	--	--	2	OK or ERR	ERR
DVI INPUT	D. PC RGB	I	C	S	I	--	--	3	OK or ERR	ERR
Signal Type	D. PC COMP.	I	C	S	I	--	--	4	OK or ERR	ERR
D. VIDEO RGB	I	C	S	I	--	--	--	5	OK or ERR	ERR
D. VIDEO COMP.	I	C	S	I	--	--	--	6	OK or ERR	ERR
A. RGB	I	C	S	I	--	--	--	1	OK or ERR	ERR
A. COMP.	I	C	S	I	--	--	--	2	OK or ERR	ERR
H1 INPUT	Auto	I	D	S	I	--	--	0	OK or ERR	ERR
Signal Type	RGB	I	D	S	I	--	--	1	OK or ERR	ERR
YCbCr4:4:4	I	D	S	I	--	--	--	7	OK or ERR	ERR
YCbCr4:4:2	I	D	S	I	--	--	--	8	OK or ERR	ERR
H2 INPUT	Auto	I	E	S	I	--	--	0	OK or ERR	ERR
Signal Type	RGB	I	E	S	I	--	--	1	OK or ERR	ERR
YCbCr4:4:4	I	E	S	I	--	--	--	7	OK or ERR	ERR
YCbCr4:4:2	I	E	S	I	--	--	--	8	OK or ERR	ERR
H1 INPUT	Auto	H	M	D	C	--	--	0	OK or ERR	ERR
Color Space	ITU601	H	M	D	C	--	--	1	OK or ERR	ERR
ITU709	H	M	D	C	--	--	--	2	OK or ERR	ERR
H2 INPUT	Auto	H	M	E	C	--	--	0	OK or ERR	ERR
Color Space	ITU601	H	M	E	C	--	--	1	OK or ERR	ERR
ITU709	H	M	E	C	--	--	--	2	OK or ERR	ERR
DVI INPUT	Auto	H	M	C	D	--	--	0	OK or ERR	ERR
Dynamic Range	Standard	H	M	C	D	--	--	1	OK or ERR	ERR
Enhanced	H	M	C	D	--	--	--	2	OK or ERR	ERR
H1 INPUT	Auto	H	M	D	D	--	--	0	OK or ERR	ERR
Dynamic Range	Standard	H	M	D	D	--	--	1	OK or ERR	ERR
Enhanced	H	M	D	D	--	--	--	2	OK or ERR	ERR
H2 INPUT	Auto	H	M	E	D	--	--	0	OK or ERR	ERR
Dynamic Range	Standard	H	M	E	D	--	--	1	OK or ERR	ERR
Enhanced	H	M	E	D	--	--	--	2	OK or ERR	ERR
Video System	Auto	M	E	S	Y	--	--	1	OK or ERR	ERR
PAL	M	E	S	Y	--	--	--	2	OK or ERR	ERR
SECAM	M	E	S	Y	--	--	--	3	OK or ERR	ERR
NTSC4.43	M	E	S	Y	--	--	--	4	OK or ERR	ERR
NTSC3.58	M	E	S	Y	--	--	--	5	OK or ERR	ERR
PAL-M	M	E	S	Y	--	--	--	6	OK or ERR	ERR
PAL-N	M	E	S	Y	--	--	--	7	OK or ERR	ERR
PAL-60	M	E	S	Y	--	--	--	8	OK or ERR	ERR
Background	Logo	I	M	B	G	--	--	1	OK or ERR	ERR
Blue	I	M	B	G	--	--	--	3	OK or ERR	ERR
None	I	M	B	G	--	--	--	4	OK or ERR	ERR

CONTROL CONTENTS	COMMAND	PARAMETER	RETURN		
			Power ON	Standby mode (or 30-second startup time)	
RS232C Port	Off	L N R S	-- -- -- 0	OK or ERR	ERR
	On	L N R S	-- -- -- 1	OK or ERR	ERR
Auto Power Off	Off	A P O W	-- -- -- 0	OK or ERR	ERR
	On	A P O W	-- -- -- 1	OK or ERR	ERR
Fan Mode	Normal	H L M D	-- -- -- 0	OK or ERR	ERR
	High	H L M D	-- -- -- 1	OK or ERR	ERR
PJ1 Mode	Front	I M R E	-- -- -- 0	OK or ERR	ERR
	Ceiling + Front	I M R E	-- -- -- 1	OK or ERR	ERR
	Rear	I M I N	-- -- -- 0	OK or ERR	ERR
	Rear + Front	I M I N	-- -- -- 1	OK or ERR	ERR
All reset	A L R E	-- -- -- 1	OK or ERR	ERR	
Language	English	M E L A	-- -- -- 1	OK or ERR	ERR
	Deutsch	M E L A	-- -- -- 2	OK or ERR	ERR
	Español	M E L A	-- -- -- 3	OK or ERR	ERR
	Nederlands	M E L A	-- -- -- 4	OK or ERR	ERR
	Français	M E L A	-- -- -- 5	OK or ERR	ERR
	Italiano	M E L A	-- -- -- 6	OK or ERR	ERR
	Svenska	M E L A	-- -- -- 7	OK or ERR	ERR
	日本語	M E L A	-- -- -- 8	OK or ERR	ERR
	Português	M E L A	-- -- -- 9	OK or ERR	ERR
	汉语	M E L A	-- -- 1 0	OK or ERR	ERR
	한국어	M E L A	-- -- 1 1	OK or ERR	ERR
Lamp Quantity	T L P N	-- -- -- 1	"1"		
Model Name Check	T N A M	-- -- -- 1	XV-Z20000/DT-5000		
Projector Name Setting	P J N 0	-- -- -- 1			
Projector Name Setting 1 (First four characters) *3	P J N 1	* * * *	OK or ERR	ERR	
Projector Name Setting 2 (Middle four characters) *3	P J N 2	* * * *	OK or ERR	ERR	
Projector Name Setting 3 (Last four characters) *3	P J N 3	* * * *	OK or ERR	ERR	
Lamp Timer Reset *4	L P R E	-- -- -- 1	ERR	OK or ERR	

 **Note**

- If an underbar ( ) appears in the parameter column, enter a space. If an asterisk (\*) appears, enter a value in the range indicated in brackets under CONTROL CONTENTS.
- Fine Sync can only be set in the displayed RGB mode.
- The return value of "TLTT\_ \_ \_ 1" becomes "0" when the projector is in the standby mode.

\*1 The command parameters for the CLR temperature setting are as follows.

	Parameter
5500	_055
6500	_065
7500	_075
8500	_085
9500	_095
10500	_105

\*2 The command parameters for the Overscan setting are as follows.

	Parameter
10%	_ _ _ 10
9%	_ _ _ 9
8%	_ _ _ 8
7%	_ _ _ 7
6%	_ _ _ 6
5%	_ _ _ 5
4%	_ _ _ 4
3%	_ _ _ 3
2%	_ _ _ 2
1%	_ _ _ 1
0%	_ _ _ 0

\*3 For setting the projector name, send the commands in order of PJN1, PJN2 and PJN3.

\*4 The Lamp Timer Reset command can only be sent in standby mode.



# Wired Remote Control Terminal Specifications

## Specifications of wired remote control input

- ø3.5 mm minijack
- External: GND
- Internal: +3.3V

## Function and transmission codes

CONTROL ITEM	SYSTEM CODE					DATA CODE								JUDGEMENT CODE	
	C1	C2	C3	C4	C5	C6	C7	C8	C9	C10	C11	C12	C13	C14	C15
ON	1	0	1	1	0	0	1	1	0	1	0	1	0	1	0
STANDBY	1	0	1	1	0	0	1	1	0	1	0	0	1	1	0
MENU	1	0	1	1	0	0	0	1	0	0	0	1	1	1	0
	1	0	1	1	0	0	0	1	1	1	0	0	1	1	0
	1	0	1	1	0	1	0	1	1	1	0	0	1	1	0
	1	0	1	1	0	0	0	0	0	1	0	1	0	1	0
	1	0	1	1	0	1	1	1	1	0	0	1	0	1	0
ENTER	1	0	1	1	0	1	1	1	0	1	0	1	0	1	0
RETURN	1	0	1	1	0	1	0	0	1	1	0	1	0	1	0
RGB/COMP.	1	0	1	1	0	1	0	0	0	1	1	1	1	1	0
CONTRAST	1	0	1	1	1	0	1	0	0	0	1	0	0	1	0
BRIGHT	1	0	1	1	1	1	0	0	1	0	1	0	0	1	0

CONTROL ITEM	SYSTEM CODE					DATA CODE								JUDGEMENT CODE	
	C1	C2	C3	C4	C5	C6	C7	C8	C9	C10	C11	C12	C13	C14	C15
RESIZE	1	0	1	1	0	0	1	1	1	1	0	1	0	1	0
PICTURE MODE	1	0	1	1	0	1	0	0	1	1	1	0	0	1	0
IRIS	1	0	1	1	0	0	1	0	1	0	1	0	1	1	0
AUTO SYNC	1	0	1	1	0	0	1	0	1	1	1	1	1	1	0
FREEZE	1	0	1	1	0	1	0	1	1	0	0	0	1	1	0
COMPONENT1	1	0	1	1	0	0	1	0	1	1	0	0	0	1	0
COMPONENT2	1	0	1	1	0	0	1	0	1	1	1	0	0	1	0
S-VIDEO	1	0	1	1	0	1	1	1	0	1	1	0	0	1	0
VIDEO	1	0	1	1	0	0	1	0	0	1	1	0	0	1	0
DVI	1	0	1	1	0	1	0	1	0	1	1	0	0	1	0
HDMI1	1	0	1	1	0	0	1	1	0	1	1	0	0	1	0
HDMI2	1	0	1	1	0	1	0	1	0	1	1	0	1	1	0
INPUT	1	0	1	1	0	1	1	0	0	1	0	0	0	1	0

Wired remote control function code

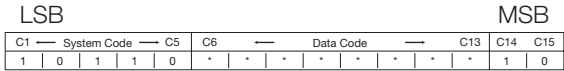

- System codes C1 to C5 are fixed at “10110”.
- Codes C14 and C15 are reverse confirmation bits, with “10” indicating “Front” and “01” indicating “Rear”.

## Sharp remote control signal format

Transmission format: 15-bit format

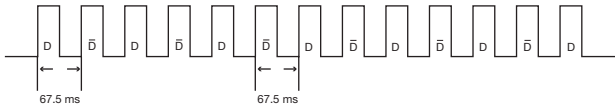

Wave form of output signal: Output using pulse position modulation

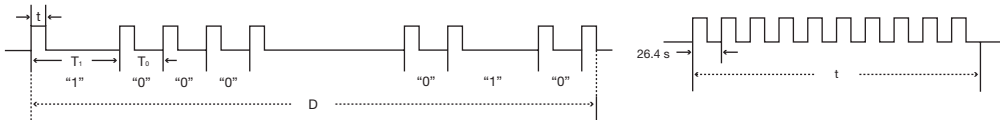

- $t = 264 \mu s$
- $T_0 = 1.05 ms$
- $T_1 = 2.10 ms$
- Pulse carrier frequency = 37.917 kHz
- Duty ratio = 1:1

Transmission control code

15 bit

C1	C2	C3	C4	C5	C6	C7	C8	C9	C10	C11	C12	C13	C14	C15
System Address					Function Key Data Bit					Data Expansion	Mask	Data Determination		
D to $\bar{D}$ Common Data Bit					Reverse in $\bar{D}$									

Example of Reverse D to  $\bar{D}$

D	C1	C2	C3	C4	C5	C6	C7	C8	C9	C10	C11	C12	C13	C14	C15
1	0	1	1	0	1	0	0	0	0	0	0	0	0	1	0
$\bar{D}$	C1	C2	C3	C4	C5	C6	C7	C8	C9	C10	C11	C12	C13	C14	C15
1	0	1	1	0	0	1	1	1	1	1	1	1	1	0	1

# Computer Compatibility Chart

## Computer

- Multiple signal support  
Horizontal Frequency: 15–81 kHz, Vertical Frequency: 43–100 Hz, Pixel Clock: 12–150 MHz
- Compatible with sync on green and composite sync signals (TTL level)
- AICS (Advanced Intelligent Compression and Expansion System) resizing technology

The following is a list of modes that conform to VESA. However, this projector supports other signals that are not VESA standards.

PC/MAC	Resolution	Horizontal Frequency (kHz)	Vertical Frequency (Hz)	VESA Standard	DVI Support
VGA	640 × 350	27.0	60		
		31.5	70		
		37.9	85	✓	
	720 × 350	27.0	60		
		31.5	70		
	640 × 400	27.0	60		✓
		31.5	70		✓
		37.9	85	✓	✓
	720 × 400	27.0	60		✓
		31.5	70		✓
		37.9	85	✓	✓
		26.2	50		✓
		31.5	60		✓
		34.7	70		✓
	640 × 480	37.9	72	✓	✓
		37.5	75	✓	✓
		43.3	85	✓	✓
		47.9	90		✓
53.0		100		✓	
31.4		50		✓	
SVGA	800 × 600	35.1	56	✓	✓
		37.9	60	✓	✓
		44.5	70		✓
		48.1	72	✓	✓
		46.9	75	✓	✓
		53.7	85	✓	✓
		56.8	90		✓
		64.0	100		✓
XGA	1024 × 768	35.5	43		✓
		40.3	50		✓
		48.4	60	✓	✓
		56.5	70	✓	✓
		60.0	75	✓	✓
		68.7	85	✓	✓
		73.5	90		✓
		77.2	96		✓
		80.6	100		✓

PC/MAC	Resolution	Horizontal Frequency (kHz)	Vertical Frequency (Hz)	VESA Standard	DVI Support
SXGA	1152 × 864	55.0	60		✓
		66.2	70		✓
		64.1	72		✓
		67.5	75	✓	✓
		76.6	80		✓
	1152 × 882	54.8	60		✓
		65.9	72		✓
		67.4	74		✓
		64.0	60	✓	✓
		1280 × 1024	64.0	60	✓
SXGA+	1400 × 1050	64.0	60		✓
—	1280 × 720	45.0	60		✓
WXGA	1280 × 768	47.8	60		✓
	1360 × 768	47.6	60		✓
WSXGA	1600 × 900	55.9	60		✓
	1920 × 1080*	66.8	60		✓
MAC 13"	640 × 480	34.9	67		
MAC 16"	832 × 624	46.8	75		
		49.6	75		
MAC 19"	1024 × 768	48.4	60		
		60.0	75		
MAC 21"	1152 × 870	68.5	75		

\* When a 1920 × 1080 signal is input, the image is compressed before it is displayed on the screen.

## Note



- This projector may not be able to display images from notebook computers in simultaneous (CRT/LCD) mode. Should this occur, turn off the LCD display on the notebook computer and output the display data in “CRT only” mode. Details on how to change display modes can be found in your notebook computer’s operation manual.
- When this projector receives 640 × 350 VESA format VGA signals, “640 × 400” appears on the screen.
- When projecting moving image of interlace signals using RGB input, the intended image may not be projected depending on the signal types. In such cases, use the component, S-video or video input.

## DTV

Signal	Horizontal Frequency (kHz)	Vertical Frequency (Hz)	HDMI Support
480I	15.8	60	✓
480P	31.5	60	✓
576I	15.6	50	✓
576P	31.3	50	✓
720P	45.0	60	✓
720P	37.5	50	✓
1080I	33.8	60	✓
1080I	28.1	50	✓
1080P*	62.5	50	✓
1080P*	67.4	60	✓

\* True display when “RESIZE” is set to “DOT BY DOT”

# Troubleshooting

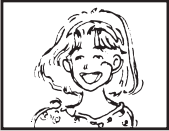
Problem	Check	Page
 No picture and no sound or projector does not start	<ul style="list-style-type: none"> <li>• Projector power cord is not plugged into the wall outlet.</li> </ul>	25
	<ul style="list-style-type: none"> <li>• Power to the external connected devices is off.</li> </ul>	–
	<ul style="list-style-type: none"> <li>• The selected input mode is wrong.</li> </ul>	27
	<ul style="list-style-type: none"> <li>• Cables incorrectly connected to rear panel of the projector.</li> </ul>	18-25
	<ul style="list-style-type: none"> <li>• Remote control batteries have run out.</li> </ul>	11
	<ul style="list-style-type: none"> <li>• External output has not been set when connecting notebook computer.</li> </ul>	–
	<ul style="list-style-type: none"> <li>• The cover of the lamp unit is not installed correctly.</li> </ul>	49,50
	<ul style="list-style-type: none"> <li>• The selected “Signal Type” is wrong.</li> </ul>	44
	<ul style="list-style-type: none"> <li>• The video signal format of the video equipment is not set correctly.</li> </ul>	43
	<ul style="list-style-type: none"> <li>• “Bright” is set to minimum position.</li> </ul>	29,36
 Color is faded or poor.	<ul style="list-style-type: none"> <li>• Picture adjustments are incorrectly set.</li> </ul>	36
	(S-VIDEO or VIDEO input) <ul style="list-style-type: none"> <li>• Video input system is incorrectly set.</li> </ul>	43
	(COMPONENT, DVI or HDMI input) <ul style="list-style-type: none"> <li>• Input signal type is incorrectly set.</li> </ul>	44
 Picture is blurred; noise appears.	<ul style="list-style-type: none"> <li>• Adjust the focus.</li> </ul>	27
	<ul style="list-style-type: none"> <li>• The projection distance exceeds the focus range.</li> </ul>	16
	(Computer input) <ul style="list-style-type: none"> <li>• Perform “Fine Sync” Adjustments (“Clock” Adjustment)</li> </ul>	41
	<ul style="list-style-type: none"> <li>• Perform “Fine Sync” Adjustments (“Phase” Adjustment)</li> </ul>	41
	<ul style="list-style-type: none"> <li>• Noise will appear depending on the computer.</li> </ul>	–
	<ul style="list-style-type: none"> <li>• The “DNR” (Digital Noise Reduction) setting is not correct.</li> </ul>	38
<ul style="list-style-type: none"> <li>• There is fog on the lens. If the projector is carried from a cold room into a warm room, or if it is suddenly heated, condensation may form on the surface of the lens and the image will become blurred. Please set up the projector at least one hour before it is to be used. If condensation should form, remove the power cord from the wall outlet and wait for it to clear.</li> </ul>	–	
An unusual sound is occasionally heard from the cabinet.	<ul style="list-style-type: none"> <li>• If the picture is normal, the sound is due to cabinet shrinkage caused by a room temperature changes. This will not affect operation or performance.</li> </ul>	–
Maintenance indicator on the projector illuminates.	<ul style="list-style-type: none"> <li>• See “Maintenance Indicators/Maintenance”.</li> </ul>	46
Power indicator and lamp indicator do not come on while projecting.	<ul style="list-style-type: none"> <li>• “LED” is set to “Off”.</li> </ul>	43
Picture is green when receiving component signals and the signal type setting is set to COMPONENT/RGB 1 or 2.	<ul style="list-style-type: none"> <li>• Change the input signal type setting.</li> </ul>	44
Picture is pink when receiving RGB signals and the signal type setting is set to COMPONENT/RGB 1 or 2.		

## Troubleshooting (Continued)

Problem	Check	Page
The black levels of the image show banding or appear faded when HDMI1 or 2 is selected.	<ul style="list-style-type: none"> <li>• Make adjustments that result in the best picture quality in the “Dynamic Range” setting.</li> </ul>	44
Picture is too bright and whitish.	<ul style="list-style-type: none"> <li>• Picture adjustments are incorrectly set.</li> </ul>	36
The cooling fan becomes noisy.	<ul style="list-style-type: none"> <li>• When temperature inside the projector increases, the cooling fan runs faster.</li> </ul>	–
The lamp does not light up even after the projector turns on.	<ul style="list-style-type: none"> <li>• The lamp indicator is illuminating in red. Replace the lamp.</li> </ul>	46,49
The lamp suddenly turns off during projection.		
The image sometimes flickers.	<ul style="list-style-type: none"> <li>• Cables incorrectly connected to the projector or the connected equipment works improperly.</li> <li>• If this happens frequently, replace the lamp.</li> </ul>	18-24
		49
The lamp needs much time to turn on.	<ul style="list-style-type: none"> <li>• The lamp will eventually need to be changed. While the remaining lamp life draws to a close, replace the lamp.</li> </ul>	49
Picture is dark.		
A response code cannot be received when the projector was attempted to be controlled using RS-232C commands from a computer during standby.	<ul style="list-style-type: none"> <li>• In the case of transmitting RS-232C commands from a computer during standby, it takes a maximum of 30 seconds for the computer to receive the response code. Set the response code waiting time of the computer to 30 seconds or more.</li> </ul>	52
The remote control cannot be used.	<ul style="list-style-type: none"> <li>• Operate the remote control while pointing it at the projector’s remote control sensor.</li> <li>• The remote control may be too far away from the projector.</li> <li>• If direct sunlight or a strong fluorescent light is shining on the projector’s remote control sensor, place the projector where it will not be affected by strong light.</li> </ul>	11
		11
		11
	<ul style="list-style-type: none"> <li>• The batteries may be depleted or inserted incorrectly. Make sure the batteries are inserted correctly or insert new ones.</li> </ul>	11

This unit is equipped with a microprocessor. Its performance could be adversely affected by incorrect operation or interference. If this should happen, unplug the Unit and plug it in again after more than 5 minutes.

## Service Information (for the U.S.)

For the location of the nearest Sharp Authorized Service Center or Dealer, or to obtain product literature, accessories, supplies or customer assistance, please call 1-800-BE-SHARP (1-800-237-4277) or visit SHARP’s website (<http://www.sharppusa.com>).

# Specifications

Product type	Projector
Model	XV-Z20000/DT-5000
Video system	NTSC 3.58/NTSC 4.43/PAL/PAL-M/PAL-N/PAL 60/SECAM DTV480I/DTV480P/DTV720P/DTV1080I/DTV1080P
Display method	DLP® chip
DLP® panel	Panel size: 0.95" No. of dots: 2,073,600 dots (1,920 [H] × 1,080 [V])
Lens	1–1.35 × zoom lens, F2.5–8, f = 38.9–52.4 mm
Projection lamp	220 W SHP lamp
Video input signal	RCA Connector: VIDEO (VIDEO), composite video, 1.0 Vp-p, sync negative, 75 Ω terminated
S-video input signal	4-pin Mini DIN connector (S-VIDEO) Y (luminance signal): 1.0 Vp-p, sync negative, 75 Ω terminated C (chrominance signal): Burst 0.286 Vp-p, 75 Ω terminated
Component input signal	RCA Connector (COMPONENT/RGB1, 2) Y: 1.0 Vp-p, sync negative, 75 Ω terminated PB: 0.7 Vp-p, 75 Ω terminated PR: 0.7 Vp-p, 75 Ω terminated
Analog RGB/Digital input signal	29-pin DVI-I terminal (DVI) <Digital> Input impedance 50 Ω Input level 250-1000 mV <Analog> Input Impedance 75 Ω Input level 0.7 Vp-p <Synchronization signal> • Separate sync / Composite sync Input level TTL level Input impedance 1 KΩ • Green on sync Input level (Synchronizing input) 0.286 Vp-p Input Impedance 75 Ω
HDMI input signal	HDMI terminal (Video signal only)
TRIGGER terminal	Power jack: DC 12 V output
Computer control signal	9-pin D-sub connector (RS-232C Terminal)
Horizontal resolution	520 TV lines (NTSC 3.58 input), 750 TV lines (DTV 720P input)
Pixel clock	12–150 MHz
Vertical frequency	43–100 Hz
Horizontal frequency	15–81 kHz
Rated voltage	AC 100–240 V
Input current	3.3 A (When using AC 100 V)
Rated frequency	50/60 Hz
Power consumption	320 W (Lamp Setting “Bright”)/ 265 W (Lamp Setting “Eco + Quiet”) with AC 100 V 310 W (Lamp Setting “Bright”)/ 260 W (Lamp Setting “Eco + Quiet”) with AC 240 V
Power consumption (standby)	0.1 W (AC 100 V, RS-232C OFF) - 0.18 W (AC 240 V, RS-232C OFF)
Heat dissipation	1,200 BTU/hour
Operating temperature	41°F to 95°F (+5°C to +35°C)
Storage temperature	–4°F to 140°F (–20°C to +60°C)
Cabinet	Plastic
I/R carrier frequency	38 kHz
Dimensions (approx.)	18 11/16" × 6 51/64" × 16 5/32" (475 (W) × 172.5 (H) × 410.2 (D) mm) (main body only)
Weight (approx.)	20.7 lbs. (9.4 kg)
Replacement parts	Remote control, Power cord, Lens cap, Terminal cover, Projector operation manual

*As a part of policy of continuous improvement, SHARP reserves the right to make design and specification changes for product improvement without prior notice. The performance specification figures indicated are nominal values of production units. There may be some deviations from these values in individual units.*



# Dimensions

Units: inch (mm)

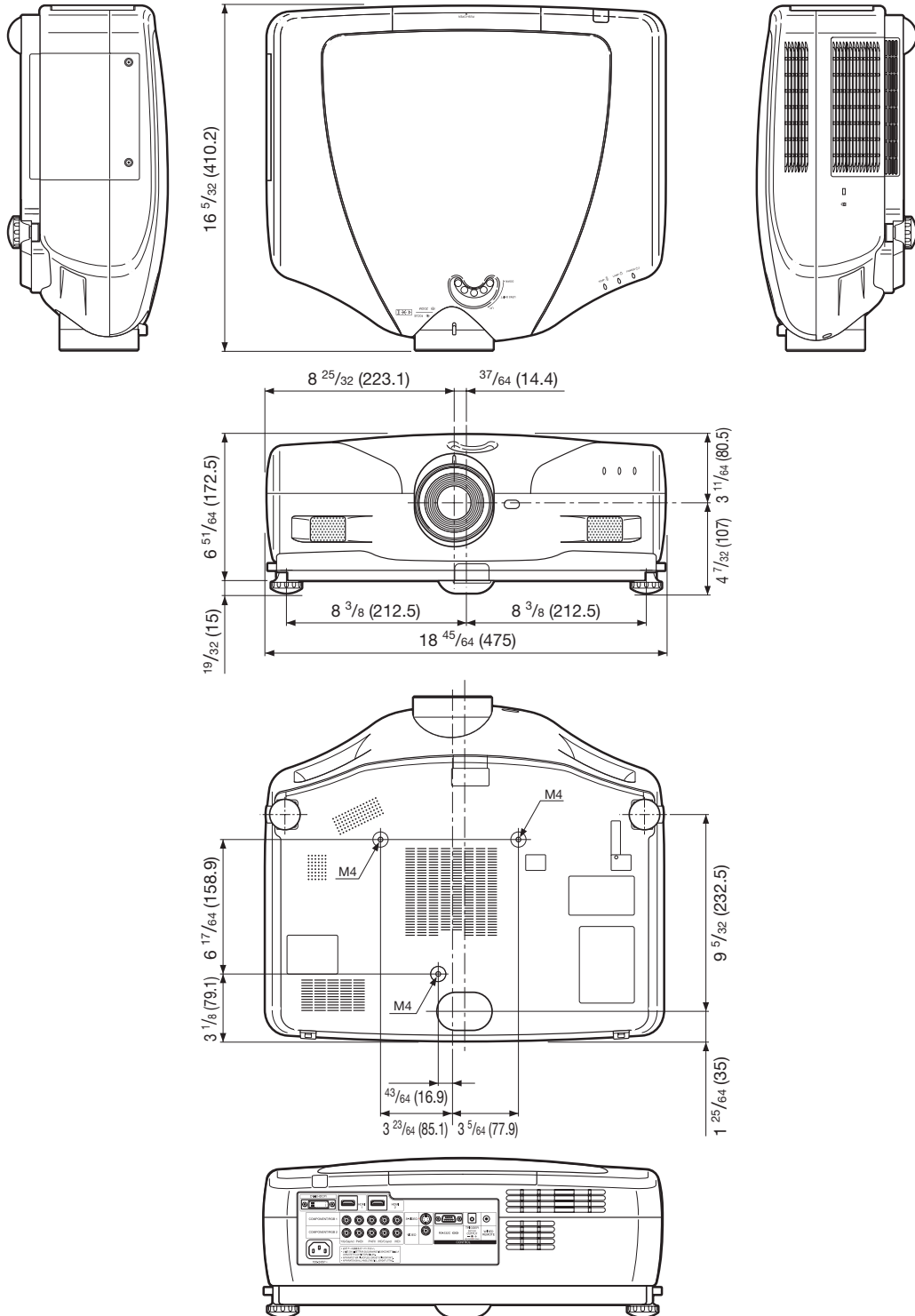

# Index

Accessories .....	4	LED .....	43
AC socket .....	25	Lens cap .....	8
Adjustment buttons .....	34	Lens shift dial .....	28
Adjustment feet .....	28	LIGHT button .....	10
Advanced .....	37	MENU button .....	34
All Reset .....	45	MNR .....	38
Automatic Contrast .....	39	ON button .....	25
Auto Power Off .....	45	Options .....	42
Auto Sync .....	41	Optional accessories .....	4
AUTO SYNC button .....	41	On-screen Display .....	43
Background .....	44	Overscan .....	42
Batteries .....	11	Phase .....	41
Black Level .....	43	Picture .....	36
Bright .....	36	Picture Mode .....	36
BRIGHT button .....	29	PICTURE MODE button .....	29
BrilliantColor™ .....	38	Power cord .....	25
Ceiling-mount setup .....	15	Power indicator .....	25,46
CINEMA ZOOM .....	31	PRJ mode .....	15,45
Clock .....	41	Progressive .....	38
CLR Temp (Color Temperature) .....	36	Remote control .....	10
C.M.S. .....	37	Remote control sensor .....	11
Color .....	36	Replacing the lamp .....	48
Color Space .....	44	RESIZE button .....	30
COMPONENT/RGB 1 terminal .....	20, 21	RETURN button .....	34
COMPONENT/RGB 2 terminal .....	20, 21	RGB/COMP. button .....	44
Contrast .....	36	RS-232C .....	45
CONTRAST button .....	29	RS-232C Port .....	44
DNR .....	38	RS-232C terminal .....	24
DOT BY DOT .....	31	Saturation .....	37
DVI terminal .....	18-20, 23	Sharp .....	36
Dynamic Range .....	44	SIDE BAR .....	30
Economy Mode .....	44	Signal Info .....	41
ENTER button .....	34	Signal Type .....	44
Fan Mode .....	45	SMART STRETCH .....	30
Film Mode .....	38	SMART ZOOM .....	31
Fine Sync .....	41	Special Modes .....	41
Focus ring .....	27	STANDBY button .....	26
FREEZE button .....	29	STRETCH .....	30
Gamma .....	40	Subtitle .....	42
Gamma Position .....	37, 40	S-VIDEO terminal .....	22
HDMI1 terminal .....	18	Temperature warning indicator .....	46
HDMI2 terminal .....	18	Tint .....	36
H-Pos .....	41	TRIGGER terminal .....	9
Hue .....	37	Unveil Control .....	39
Image Shift .....	42	Value .....	37
INPUT button .....	27	Video System .....	43
Input Mode Select buttons .....	27	VIDEO terminal .....	22
IRIS .....	37	V-Pos .....	41
IRIS button .....	29	White Level .....	43
Kensington Security Standard connector .....	9	WIRED R/C JACK .....	10
Lamp indicator .....	46	WIRED REMOTE control input terminal .....	10
Lamp Setting .....	37	ZOOM 14:9 .....	31
Lamp Timer (Life) .....	43	Zoom knob .....	27
Language (on-screen display language) .....	45		

# VALID IN USA ONLY

## CONSUMER LIMITED WARRANTY

SHARP ELECTRONICS CORPORATION warrants to the first consumer purchaser that this Sharp brand product (the "Product"), when shipped in its original container, will be free from defective workmanship and materials, and agrees that it will, at its option, either repair the defect or replace the defective Product or part thereof with a new or remanufactured equivalent at no charge to the purchaser for parts or labor for the period(s) set forth below.

This warranty does not apply to any appearance items of the Product nor to the additional excluded item(s) set forth below nor to any Product the exterior of which has been damaged or defaced, which has been subjected to improper voltage or other misuse, abnormal service or handling, or which has been altered or modified in design or construction.

In order to enforce the rights under this limited warranty, the purchaser should follow the steps set forth below and provide proof of purchase to the servicer.

The limited warranty described herein is in addition to whatever implied warranties may be granted to purchasers by law. ALL IMPLIED WARRANTIES INCLUDING THE WARRANTIES OF MERCHANTABILITY AND FITNESS FOR USE ARE LIMITED TO THE PERIOD(S) FROM THE DATE OF PURCHASE SET FORTH BELOW. Some states do not allow limitations on how long an implied warranty lasts, so the above limitation may not apply to you.

Neither the sales personnel of the seller nor any other person is authorized to make any warranties other than those described herein, or to extend the duration of any warranties beyond the time period described herein on behalf of Sharp.

The warranties described herein shall be the sole and exclusive warranties granted by Sharp and shall be the sole and exclusive remedy available to the purchaser. Correction of defects, in the manner and for the period of time described herein, shall constitute complete fulfillment of all liabilities and responsibilities of Sharp to the purchaser with respect to the Product, and shall constitute full satisfaction of all claims, whether based on contract, negligence, strict liability or otherwise. In no event shall Sharp be liable, or in any way responsible, for any damages or defects in the Product which were caused by repairs or attempted repairs performed by anyone other than an authorized servicer. Nor shall Sharp be liable or in any way responsible for any incidental or consequential economic or property damage. Some states do not allow the exclusion of incidental or consequential damages, so the above exclusion may not apply to you.

THIS WARRANTY GIVES YOU SPECIFIC LEGAL RIGHTS. YOU MAY ALSO HAVE OTHER RIGHTS WHICH VARY FROM STATE TO STATE.

---

**Model Specific Section (In-Home Service)**

XV-Z20000 Projector

**Your Product Model Number & Description:**

(Be sure to have this information available when you need service for your Product.)

**Warranty Period for this Product:**

One (1) year parts and labor from date of purchase except for the Projector Lamp for which the warranty period is ninety (90) days from date of purchase. After the ninety (90) day warranty period on the Projector Lamp, parts and labor for a lamp replacement are the responsibility of the consumer.

**Additional Item(s) Excluded from Warranty Coverage (if any):**

Cleaning of Optical System and/or replacement of any filter.  
Labor & materials required to remove and reinstall a suspended projector in installations not accessible with a standard (8' step) ladder or ceilings exceeding 12' in height.

**Where to Obtain Service:**

Labor & materials required to remove and reinstall a projector in complex systems including, but not limited to, projectors installed in custom enclosures, projectors connected to third party control and automation systems, and realignment of projectors installed in "mirrored" rear projection enclosures.

**What to do to Obtain Service:**

From a Sharp Authorized Servicer located in the United States. To find the location of the nearest Sharp Authorized Servicer, call Sharp toll free at 1-800-BE-SHARP. Contact your Sharp Authorized Servicer to obtain in-home service for this Product. The Servicer will come to your home and if necessary to remove the Product for repair at the Servicer's facility, the Servicer will reinstall it upon completion of repair. Be sure to have **Proof of Purchase** available.

TO OBTAIN PRODUCT INFORMATION, CALL 1-800-BE-SHARP (1-800-237-4277) OR VISIT [www.sharppusa.com](http://www.sharppusa.com).

VALID IN CANADA ONLY

# SHARP<sup>®</sup>

## LIMITED WARRANTY

### *Consumer Electronics Products*

### **Congratulations on your purchase!**

Sharp Electronics of Canada Ltd. (hereinafter called "Sharp") gives the following express warranty to the first consumer purchaser for this Sharp brand product, when shipped in its original container and sold or distributed in Canada by Sharp or by an Authorized Sharp Dealer:

Sharp warrants that this product is free, under normal use and maintenance, from any defects in material and workmanship. If any such defects should be found in this product within the applicable warranty period, Sharp shall, at its option, repair or replace the product as specified herein.

This warranty shall not apply to:

- (a) Any defects caused or repairs required as a result of abusive operation, negligence, accident, improper installation or inappropriate use as outlined in the owner's manual.
- (b) Any Sharp product tampered with, modified, adjusted or repaired by any party other than Sharp, Sharp's Authorized Service Centres or Sharp's Authorized Servicing Dealers.
- (c) Damage caused or repairs required as a result of the use with items not specified or approved by Sharp, including but not limited to head cleaning tapes and chemical cleaning agents.
- (d) Any replacement of accessories, glassware, consumable or peripheral items required through normal use of the product including but not limited to earphones, remote controls, AC adapters, batteries, temperature probe, stylus, trays, filters, belts, ribbons, cables and paper.
- (e) Any cosmetic damage to the surface or exterior that has been defaced or caused by normal wear and tear.
- (f) Any damage caused by external or environmental conditions, including but not limited to transmission line/power line voltage or liquid spillage.
- (g) Any product received without appropriate model, serial number and CSA/cUL markings.
- (h) Any products used for rental or commercial purposes.
- (i) Any installation, setup and/or programming charges.

Should this Sharp product fail to operate during the warranty period, warranty service may be obtained upon delivery of the Sharp product together with proof of purchase and a copy of this LIMITED WARRANTY statement to an Authorized Sharp Service Centre or an Authorized Sharp Servicing Dealer. In home warranty service may be provided at Sharp's discretion on any Sharp television with the screen size of 27" or larger and on any Sharp Over The Range Microwave Oven.

This warranty constitutes the entire express warranty granted by Sharp and no other dealer, service centre or their agent or employee is authorized to extend, enlarge or transfer this warranty on behalf of Sharp. To the extent the law permits, Sharp disclaims any and all liability for direct or indirect damages or losses or for any incidental, special or consequential damages or loss of profits resulting from a defect in material or workmanship relating to the product, including damages for the loss of time or use of this Sharp product or the loss of information. The purchaser will be responsible for any removal, reinstallation, transportation and insurance costs incurred. Correction of defects, in the manner and period of time described herein, constitute complete fulfillment of all obligations and responsibilities of Sharp to the purchaser with respect to the product and shall constitute full satisfaction of all claims, whether based on contract, negligence, strict liability or otherwise.

#### WARRANTY PERIODS

XV-Z20000 Projector

1 year (bulb 90 days)

To obtain the name and address of the nearest Authorized Sharp Service Centre or Dealer, please contact:  
SHARP ELECTRONICS OF CANADA LTD.

SHARP ELECTRONICS OF CANADA LTD.  
335 Britannia Road East  
Mississauga, Ontario  
L4Z 1W9  
(905) 568-7140  
Web site: [www.sharp.ca](http://www.sharp.ca)



**SHARP®**

SHARP CORPORATION

Printed in China  
Imprimé en Chine  
Impreso en China  
Impresso na China  
TINS-C541WJZZ  
06P07-CH-NM