

SHARP®

DT-200

PROJECTOR
PROJECTEUR
PROYECTOR
PROJETOR

OPERATION MANUAL
MODE D'EMPLOI
MANUAL DE OPERACION
MANUAL DE OPERAÇÃO

ENGLISH

FRANÇAIS

ESPAÑOL

PORTUGUÊS

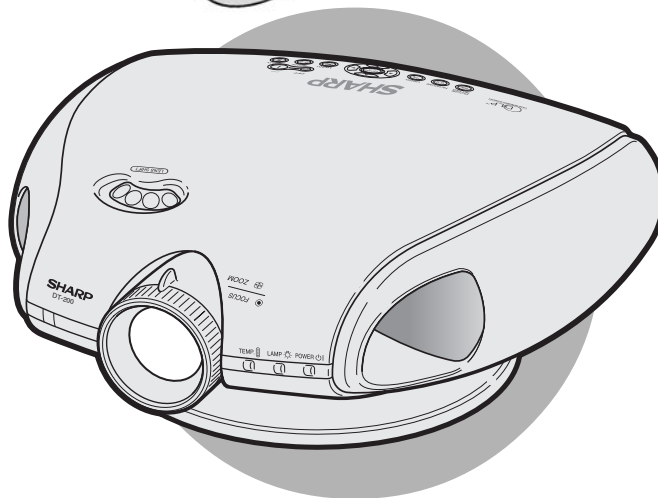
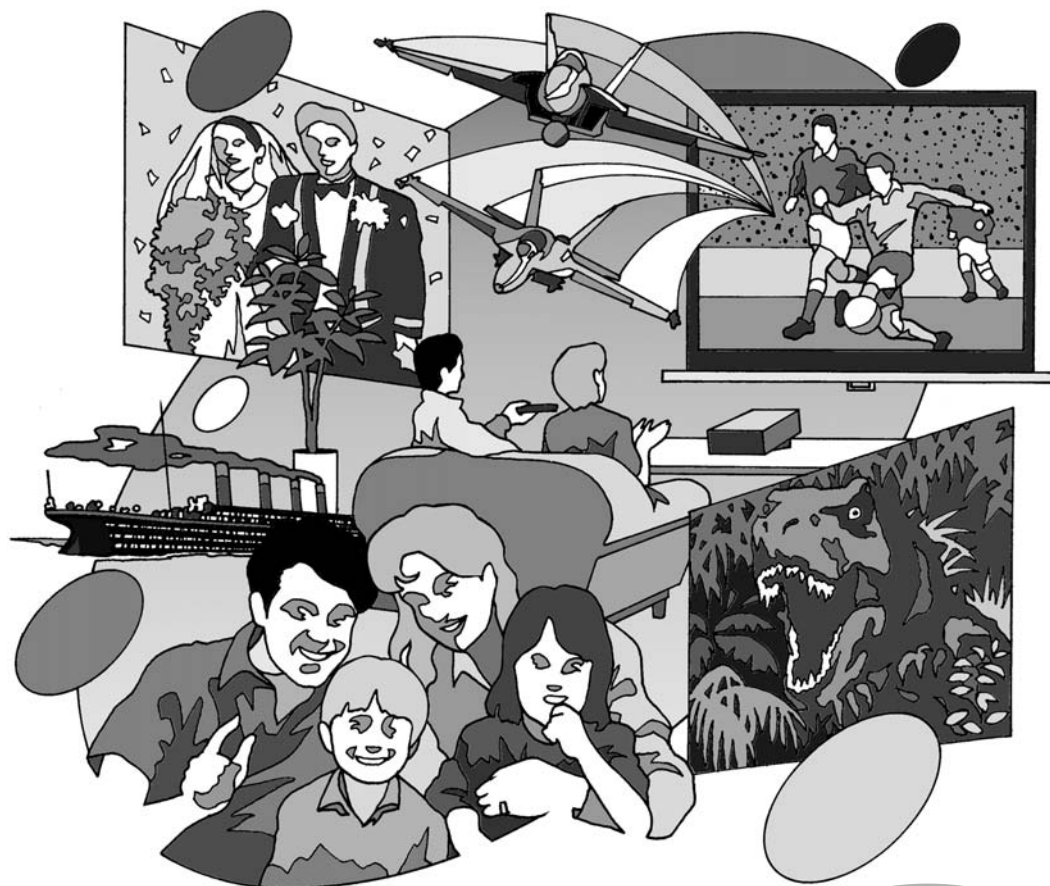

Before using the projector, please read this operation manual carefully.

OPERATION MANUAL

ENGLISH

IMPORTANT

For your assistance in reporting the loss or theft of your Projector, please record the Serial Number located on the bottom of the projector and retain this information. Before recycling the packaging, please be sure that you have checked the contents of the carton thoroughly against the list of "Supplied Accessories" on page 11.

Model No.: DT-200

Serial No.:

There are two important reasons for prompt warranty registration of your new SHARP Projector, using the REGISTRATION CARD packed with the projector.

1. WARRANTY

This is to assure that you immediately receive the full benefit of the parts, service and labor warranty applicable to your purchase.





2. CONSUMER PRODUCT SAFETY ACT

To ensure that you will promptly receive any safety notification of inspection, modification, or recall that SHARP may be required to give under the 1972 Consumer Product Safety Act, PLEASE READ CAREFULLY THE IMPORTANT "LIMITED WARRANTY" CLAUSE.

U.S.A. ONLY

WARNING: High brightness light source. Do not stare into the beam of light, or view directly. Be especially careful that children do not stare directly into the beam of light.

WARNING: To reduce the risk of fire or electric shock, do not expose this product to rain or moisture.

 <div style="text-align: center;"> <p>CAUTION</p> <p>RISK OF ELECTRIC SHOCK. DO NOT REMOVE SCREWS EXCEPT SPECIFIED USER SERVICE SCREWS.</p> </div> 	 <p>The lightning flash with arrowhead symbol, within an equilateral triangle, is intended to alert the user to the presence of uninsulated "dangerous voltage" within the product's enclosure that may be of sufficient magnitude to constitute a risk or electric shock to persons.</p>
<p>CAUTION: TO REDUCE THE RISK OF ELECTRIC SHOCK, DO NOT REMOVE COVER. NO USER-SERVICEABLE PARTS EXCEPT LAMP UNIT. REFER SERVICING TO QUALIFIED SERVICE PERSONNEL.</p>	 <p>The exclamation point within a triangle is intended to alert the user to the presence of important operating and maintenance (servicing) instructions in the literature accompanying the product.</p>

WARNING: FCC Regulations state that any unauthorized changes or modifications to this equipment not expressly approved by the manufacturer could void the user's authority to operate this equipment.

U.S.A. ONLY

PRODUCT DISPOSAL

This product utilizes tin-lead solder, and high intensity discharge lamp (HID lamp) containing a small amount of mercury. Disposal of these materials may be regulated due to environmental considerations. For disposal or recycling information, please contact your local authorities or the Electronic Industries Alliance: www.eiae.org.

INFORMATION

This equipment has been tested and found to comply with the limits for a Class B digital device, pursuant to Part 15 of the FCC Rules. These limits are designed to provide reasonable protection against harmful interference in a residential installation. This equipment generates, uses, and can radiate radio frequency energy and, if not installed and used in accordance with the operation manual, may cause harmful interference to radio communications. However, there is no guarantee that interference will not occur in a particular installation. If this equipment does cause harmful interference to radio or television reception, which can be determined by turning the equipment off and on, the user is encouraged to try to correct the interference by one or more of the following measures:

- Reorient or relocate the receiving antenna.
- Increase the separation between the equipment and the receiver.
- Connect the equipment into an outlet on a circuit different from that to which the receiver is connected.
- Consult the dealer or an experienced radio/TV technician for help.

U.S.A. ONLY

Declaration of Conformity

SHARP PROJECTOR, MODEL DT-200

This device complies with Part 15 of the FCC rules. Operation is subject to the following conditions: (1) This device may not cause harmful interference, and (2) this device must accept any interference received, including interference that may cause undesired operation.

Responsible Party:

SHARP ELECTRONICS CORPORATION
 Sharp Plaza, Mahwah, New Jersey 07430
 TEL: 1-800-BE-SHARP (1-800-237-4277)

U.S.A. ONLY

WARNING:

The cooling fan in this projector continues to run for about 90 seconds after the projector is turned off. During normal operation, when turning the power off always use the **OFF** button on the projector or on the remote control. Ensure the cooling fan has stopped before disconnecting the power cord.
DURING NORMAL OPERATION, NEVER TURN THE PROJECTOR OFF BY DISCONNECTING THE POWER CORD. FAILURE TO OBSERVE THIS WILL RESULT IN PREMATURE LAMP FAILURE.

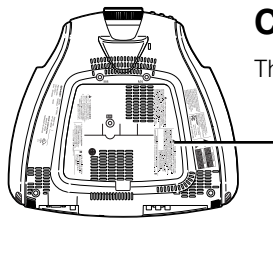

Caution Concerning the Lamp Replacement

There is potential glass particles hazard if the lamp ruptures.

LAMP REPLACEMENT CAUTION

BEFORE REMOVING THE SCREW, DISCONNECT POWER CORD. HOT SURFACE INSIDE. ALLOW 1 HOUR TO COOL BEFORE REPLACING THE LAMP. REPLACE WITH SAME SHARP LAMP UNIT TYPE BQC-XVZ90+++1 ONLY. UV RADIATION : CAN CAUSE EYE DAMAGE. TURN OFF LAMP BEFORE SERVICING. MEDIUM PRESSURE LAMP : RISK OF EXPLOSION. POTENTIAL HAZARD OF GLASS PARTICLES IF LAMP HAS RUPTURED. HANDLE WITH CARE. SEE OPERATION MANUAL.

PRECAUTIONS A OBSERVER LORS DU REMPLACEMENT DE LA LAMPE.

DEBRANCHER LE CORDON D'ALIMENTATION AVANT DE RETIRER LES VIS. L'INTERIEUR DU BOITIER ETANT EXTREMEMENT CHAUD. ATTENDRE 1 HEURE AVANT DE PROCEDER AU REMPLACEMENT DE LA LAMPE. NE REMPLACER QUE PAR UNE LAMPE SHARP DE TYPE BQC-XVZ90+++1. RAYONS ULTRAVIOLETS : PEUVENT ENDOMMAGER LES YEUX. ETEINDRE LA LAMPE AVANT DE PROCEDER A L'ENTRETIEN. LAMPE A MOYENNE PRESSION : RISQUE D'EXPLOSION. DANGER POTENTIEL DE PARTICULES DE VERRE EN CAS D'ECLATEMENT DE LA LAMPE. A MANIPULER AVEC PRECAUTION, SE REPORTER AU MODE D'EMPLOI.

WARNING:

Some IC chips in this product include confidential and/or trade secret property belonging to Texas Instruments. Therefore you may not copy, modify, adapt, translate, distribute, reverse engineer, reverse assemble or discompile the contents thereof.



IMPORTANT SAFEGUARDS

Electrical energy can perform many useful functions. This product has been engineered and manufactured to ensure your personal safety. However IMPROPER USE CAN RESULT IN POTENTIAL ELECTRICAL SHOCK OR FIRE HAZARD. In order not to defeat the safeguards incorporated into this Projector, observe the following basic rules for its installation, use and servicing. For your own protection and reliable usage of your Projector, please be sure to read these "IMPORTANT SAFEGUARDS" carefully before use.

1. Read Instructions

All the safety and operating instructions should be read before the product is operated.

2. Retain Instructions

The safety and operating instructions should be retained for future reference.

3. Heed Warnings

All warnings on the product and in the operating instructions should be adhered to.

4. Follow Instructions

All operating and use instructions should be followed.

5. Cleaning

Unplug this product from the wall outlet before cleaning. Do not use liquid cleaners or aerosol cleaners. Use a damp cloth for cleaning.

6. Attachments

Do not use attachments not recommended by the product manufacturer as they may cause hazards.

7. Water and Moisture

Do not use this product near water – for example, near a bathtub, wash bowl, kitchen sink, or laundry tub; in a wet basement; or near a swimming pool; and the like.

8. Accessories

Do not place this product on an unstable cart, stand, tripod, bracket, or table. The product may fall, causing serious injury to a child or adult, and serious damage to the product. Use only with a cart, stand, tripod, bracket, or table recommended by the manufacturer, or sold with the product. Any mounting of the product should follow the manufacturer's instructions, and should use a mounting accessory recommended by the manufacturer.

9. Transportation

A product and cart combination should be moved with care. Quick stops, excessive force, and uneven surfaces may cause the product and cart combination to overturn.



10. Ventilation

Slots and openings in the cabinet are provided for ventilation to ensure reliable operation of the product and to protect it from overheating. The openings should never be covered or blocked by placing the product on a bed, sofa, rug, or other similar surface. This product should not be placed in a built-in installation such as a bookcase or rack unless proper ventilation is provided or the manufacturer's instructions have been adhered to.

11. Power Sources

This product should be operated only from the type of power source indicated on the marking label. If you are not sure of the type of power supply to your home, consult your product dealer or local power company. For products intended to operate from battery power, or other sources, refer to the operating instructions.

12. Grounding or Polarization

This product is equipped with a three-wire grounding-type plug, a plug having a third (grounding) pin. This plug will only fit into a grounding-type power outlet. This is a safety feature. If you are unable to insert the plug into the outlet, contact your electrician to replace your obsolete outlet. Do not defeat the safety purpose of the grounding-type plug.

13. Power-Cord Protection

Power-supply cords should be routed so that they are not likely to be walked on or pinched by items placed upon or against them, paying particular attention to cords at plugs, convenience receptacles, and the point where they exit from the product.

14. Lightning

For added protection for this product during a lightning storm, or when it is left unattended and unused for long periods of time, unplug it from the wall outlet and disconnect the power cord. This will prevent damage to the product due to lightning and power-line surges.

15. Overloading

Do not overload wall outlets, extension cords, or integral convenience receptacles as this can result in a risk of fire or electric shock.

16. Object and Liquid Entry

Never push objects of any kind into this product through openings as they may touch dangerous voltage points or short-out parts that could result in a fire or electric shock. Never spill liquid of any kind on the product.

17. Servicing

Do not attempt to service this product yourself as opening or removing covers may expose you to dangerous voltage or other hazards. Refer all servicing to qualified service personnel.

18. Damage Requiring Service

Unplug this product from the wall outlet and refer servicing to qualified service personnel under the following conditions:

- If the power-supply cord or plug is damaged.
- If liquid has been spilled, or objects have fallen into the product.
- If the product has been exposed to rain or water.
- If the product does not operate normally by following the operating instructions. Adjust only those controls that are covered by the operating instructions, as an improper adjustment of other controls may result in damage and will often require extensive work by a qualified technician to restore the product to normal operation.
- If the product has been dropped or damaged in any way.
- If the product exhibits a distinct change in performance.

19. Replacement Parts

When replacement parts are required, be sure the service technician has used replacement parts specified by the manufacturer or with the same characteristics as the original part. Unauthorized substitutions may result in fire, electric shock, or other hazards.

20. Safety Check

Upon completion of any service or repairs to this product, ask the service technician to perform safety checks to determine that the product is in proper operating condition.

21. Wall or Ceiling Mounting

This product should be mounted to a wall or ceiling only as recommended by the manufacturer.

22. Heat

This product should be situated away from heat sources such as radiators, heat registers, stoves, or other products (including amplifiers) that produce heat.



IMPORTANT SAFEGUARDS

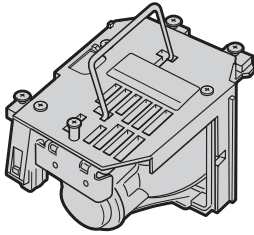

Caution Concerning the Lamp Unit

There is a potential hazard of glass particles if the lamp ruptures. In case of lamp rupture, contact your nearest Sharp Authorized Service Center or Dealer for a replacement.
See "Replacing the Lamp" on page 45.



This caution is found at the bottom of the projector. See "Caution Concerning the Lamp Replacement" on page 2 for its location.

<p>⚠ LAMP REPLACEMENT CAUTION</p> <p>BEFORE REMOVING THE SCREW, DISCONNECT POWER CORD. HOT SURFACE INSIDE. ALLOW 1 HOUR TO COOL BEFORE REPLACING THE LAMP. REPLACE WITH SAME SHARP LAMP UNIT TYPE BQC-XVZ90+++1 ONLY. UV RADIATION : CAN CAUSE EYE DAMAGE. TURN OFF LAMP BEFORE SERVICING. MEDIUM PRESSURE LAMP : RISK OF EXPLOSION. POTENTIAL HAZARD OF GLASS PARTICLES IF LAMP HAS RUPTURED. HANDLE WITH CARE. SEE OPERATION MANUAL.</p>	<p>⚠ PRECAUTIONS A OBSERVER LORS DU REMPLACEMENT DE LA LAMPE.</p> <p>DEBRANCHER LE CORDON D'ALIMENTATION AVANT DE RETIRER LES VIS. L'INTERIEUR DU BOITIER ETANT EXTREMEMENT CHAUD, ATTENDRE 1 HEURE AVANT DE PROCEDER AU REMPLACEMENT DE LA LAMPE. NE REMPLACER QUE PAR UNE LAMPE SHARP DE TYPE BQC-XVZ90+++1. RAYONS ULTRAVIOLETS : PEUVENT ENDOMMAGER LES YEUX. ETEINDRE LA LAMPE AVANT DE PROCEDER A L'ENTRETIEN. LAMPE A MOYENNE PRESSION : RISQUE D'EXPLOSION. DANGER POTENTIEL DE PARTICULES DE VERRE EN CAS D'ECLATEMENT DE LA LAMPE. A MANIPULER AVEC PRECAUTION, SE REPORTER AU MODE D'EMPLOI.</p>
---	--

Cautions Concerning the Setup of the Projector

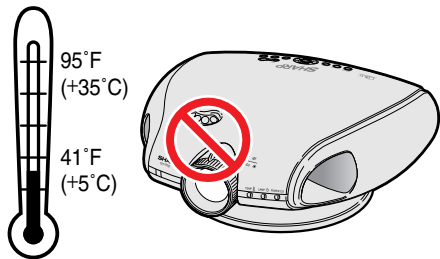

For minimal servicing and to maintain high image quality, SHARP recommends that this projector be installed in an area free from humidity, dust and cigarette smoke. When the projector is subjected to these environments, the lens and part of filter must be cleaned more often than usual. As long as the projector is properly maintained in this manner, use in these environments will not reduce the overall operation life. Please note that all internal cleaning must be performed by a Sharp Authorized Service Center or Dealer.

- Do not expose the projector to extreme heat or cold.
Operating temperature: 41°F to 95°F (+5°C to 35°C)
Storage temperature: -4°F to 140°F (-20°C to +60°C)

Notes on Operation

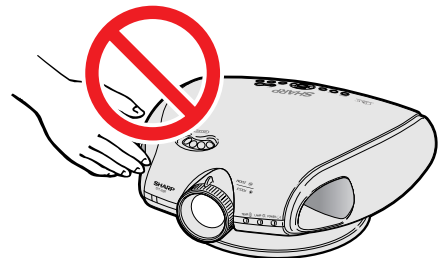

- The exhaust ventilative hole, the lamp cage cover and adjacent areas may get extremely hot during projector operation. To prevent injury, do not touch these areas until they have sufficiently cooled down.
- Allow at least 1 foot (30 cm) of space between the exhaust ventilative hole and the nearest wall or obstruction.
- If the cooling fan becomes obstructed, a protection device will automatically turn off the projector lamp. This does not indicate a malfunction. Remove the projector power cord from the wall outlet and wait at least 10 minutes. Then turn on the power by plugging the power cord back in. This will return the projector to the normal operating condition.

WARNING: High brightness light source. Do not stare into the beam of light, or view directly. Be especially careful that children do not stare directly into the beam of light.



IMPORTANT SAFEGUARDS

Temperature Monitor Function

If the projector starts to overheat due to setup problems “TEMP” and “” will blink in the lower-left corner of the picture. If the temperature continues to rise, the lamp will turn off, the TEMPERATURE WARNING indicator on the projector will blink, and after a 90-second cooling-off period the power will shut off. Refer to “Lamp/Maintenance Indicators” on page 43 for details.

NOTE

- The cooling fan regulates the internal temperature, and its performance is automatically controlled. The sound of the fan may change during projector operation due to changes in the fan speed.

Lamp Monitor Function

When the projector is turned on after the lamp has been used for 2,400 hours, “LAMP” and “” will blink in the lower-left corner of the picture to advise you to replace the lamp. See page 45 for lamp replacement. If the lamp has been used for 2,500 hours, the projector power will automatically turn off and the projector will enter standby mode. Refer to “Lamp/Maintenance Indicators” on page 43 for details.



TEMP



LAMP



Contents



Important Information

IMPORTANT SAFEGUARDS	3
Contents	6
Outstanding Features	7
Part Names	8
Supplied Accessories	11



Setup & Connections

Connections	12
Power Supply	12
Connecting to Video Equipment	12
Connecting to a DVD Player and DTV Decoder	13
Connecting to a Computer	14
Operating the Remote Control	15
Power ON/OFF	16
Zooming and Focusing	16
Setting Up the Screen	17
Using the Swivel Stand	17
Using the Lens Shift	18
Keystone Correction	19
Placement of the Projected Image Using the Keystone Correction	20
Adjusting the Projection Distance	21
Image Projection	23
Rear Projection	23
Projection Using a Mirror	23
Ceiling-mount Projection	23



Operation Buttons

Using the Operation Buttons	24
Selecting the Input Signal Source	24
Adjusting the Picture Aspect Ratio	24
Freeze Function	25



Basic Operation

Using the Menu Screen	26
Basic Operations	26
Menu Bars	27
Adjusting the Picture	29

Adjusting the Computer and DVD/DTV Images	33
Turning On/Off the On-screen Display	36
Selecting the Signal Type	36
Setting the Video Signal (VIDEO menu only)	37
Selecting a Background Image	37
Adjustments for the Screen Position and Size	38
Selecting the Menu Screen Position	40
Selecting the Menu Color	40
Automatic Power Shut-off Function	41
Reversing/Inverting Projected Images	42
Selecting the On-screen Display Language	42



Maintenance & Troubleshooting

Lamp/Maintenance Indicators	43
Lamp Maintenance	44
Confirming the Lamp Usage Time	44
Replacing the Lamp	45
Cleaning the Ventilative Holes	48
Using the Kensington Lock	49
Troubleshooting	49
Service Information (For the U.S.)	49



Appendix

Connecting Pin Assignments	50
Computer Compatibility Chart	51
Dimensions	52
Specifications	53
Glossary	54
Index	55
CONSUMER LIMITED WARRANTY (VALID IN USA ONLY)	56
LIMITED WARRANTY (VALID IN CANADA ONLY)	57





Outstanding Features

1. **DMD™* (Digital Micromirror Device) Chip**

The DMD Chip allows for a higher contrast image. It enables smoother expression of details of an image, and high picture quality for an exciting theater experience.

* Digital Light Processing, DLP, Digital Micromirror Device and DMD are trademarks of Texas Instruments.

2. **Five Speed Primary Color Wheel**

The color wheel consists of only the three primary colors of the light and creates a higher contrast image with high color purity.

3. **Advanced Video Circuitry**

The video circuit setup is designed for obtaining optimal images from audiovisual equipment. The circuit optimizes high optical performance that originates in the DMD chip and the five speed primary color wheel, to realize outstanding video images.

4. **Low Noise Design**

A new optical engine has been developed for this product to minimize fan noise for undisturbed viewing.

5. **Lens Shift Function**

The digital shift function optically adjusts the vertical position of images. The function allows for simple adjustment when setting up the projector for the first time.

6. **2D Keystone Correction**

The 2D keystone correction function electrically corrects the size of projected images. The function enables diagonal projection and the wider range settings.

7. **HDCP (High-bandwidth Digital Content Protection) System**

Digital entertainment content is protected from copying with the HDCP system.

8. **For Use with DTV**

Allows projection of DTV images and 16:9 wide-screen images when connected to a DTV decoder or similar video system.

9. **Easy-to-use Graphical User Interface (GUI)**

A multi-color menu system, which allows for simple image adjustments.

10. **Color Temperature Adjustment**

The function can be used to adjust the color temperature to suit the type of image input to the projector.

11. **Gamma Correction Function**

The gamma value setting can be adjusted according to the input source for optimal image contrast.

12. **Picture Setting Function**

The values in various adjustment settings can be stored. The function can be used to select the values to suit the type of image input to the projector by pressing the **PICTURE SETTING** button on the projector or on the remote control.

13. **Component Video Input**

Utilizes a component video input signal (Y, P_B, P_R). The video signal is input as separate components to provide superior color and image quality.

14. **Direct Computer Compatibility**

A multi-scan RGB input accepts signals from VGA (640 dots × 480 lines) and Macintosh (from 13" compatible computers) without the need for any additional hardware.



Part Names



Numbers next to the part names refer to the main pages in this manual where the topic is explained.

Projector

Front and Top View

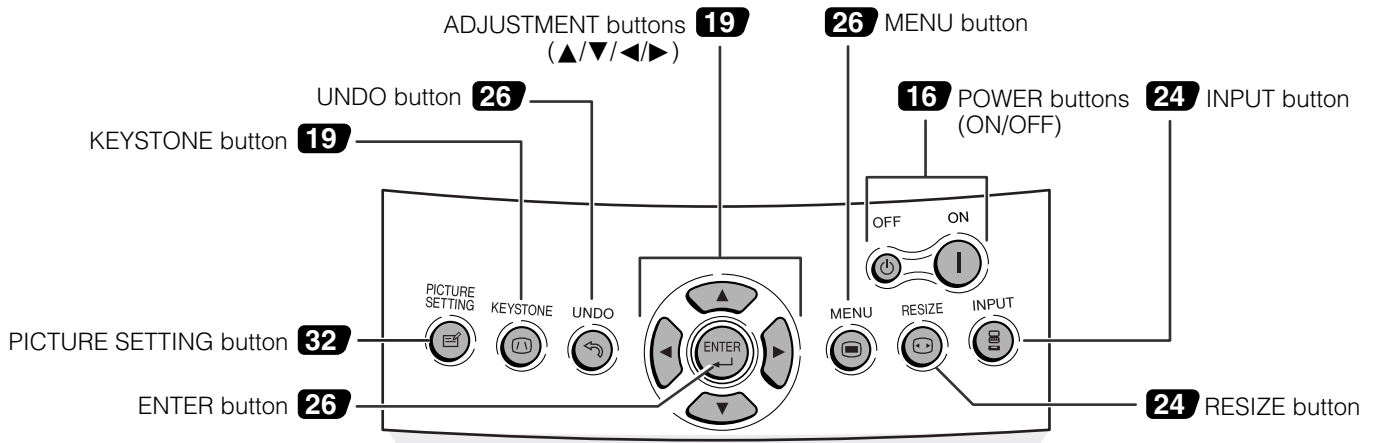
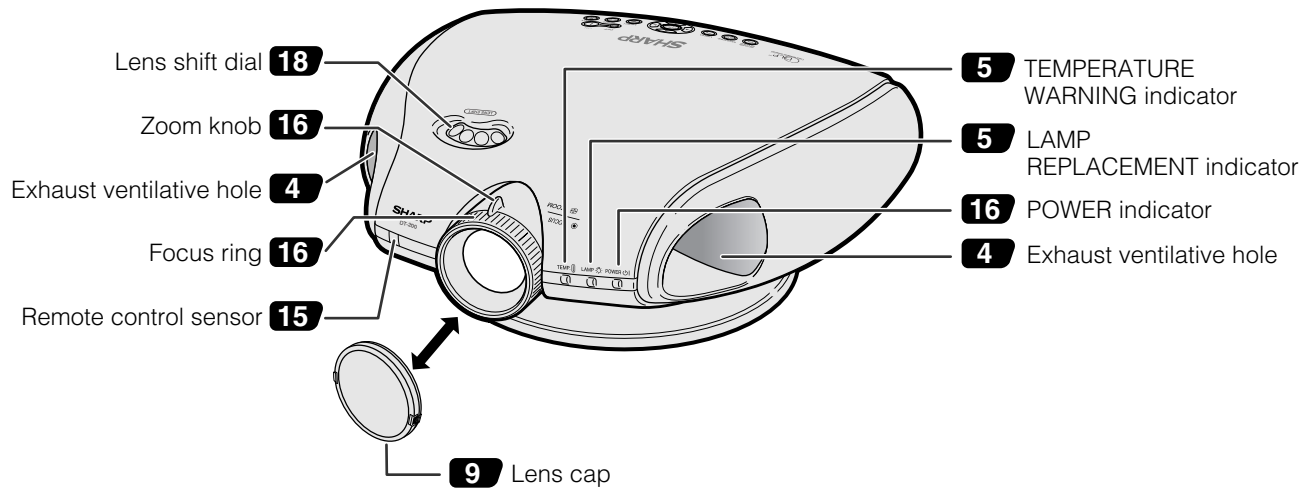

Side and Rear View

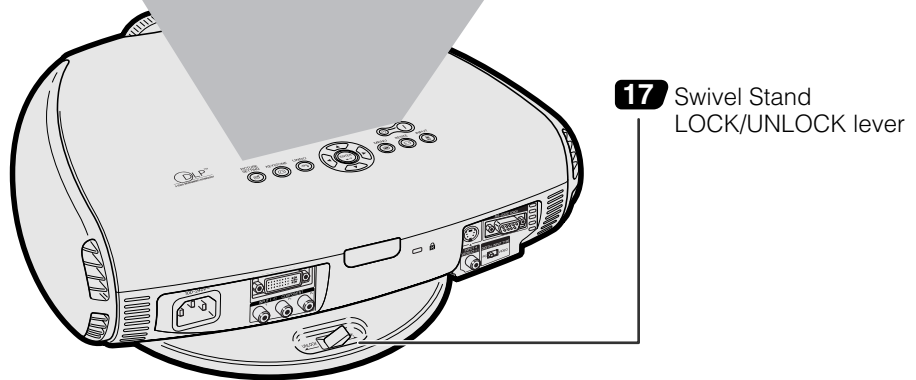



Part Names

Numbers next to the part names refer to the main pages in this manual where the topic is explained.

Projector

Side and Rear View

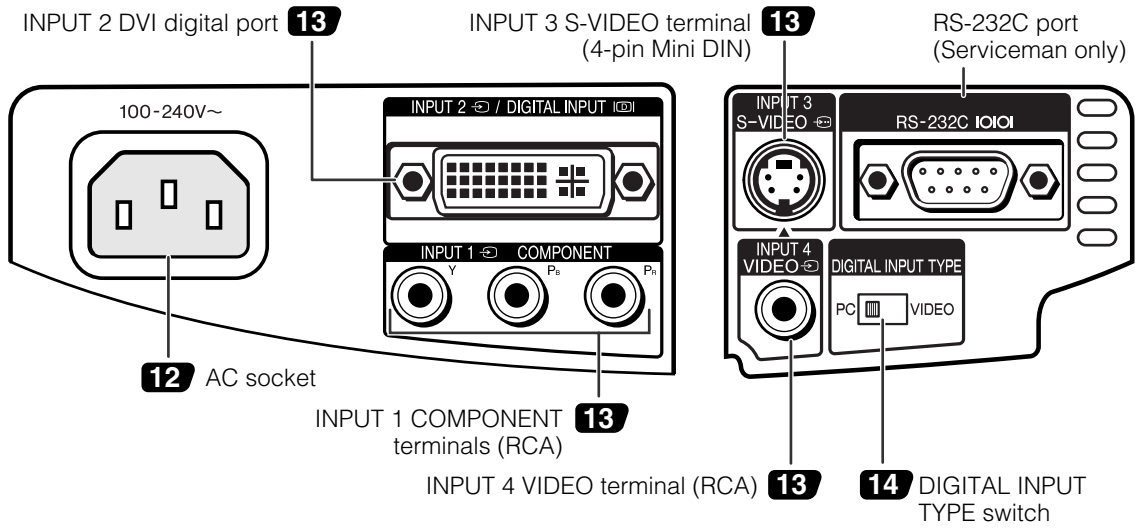
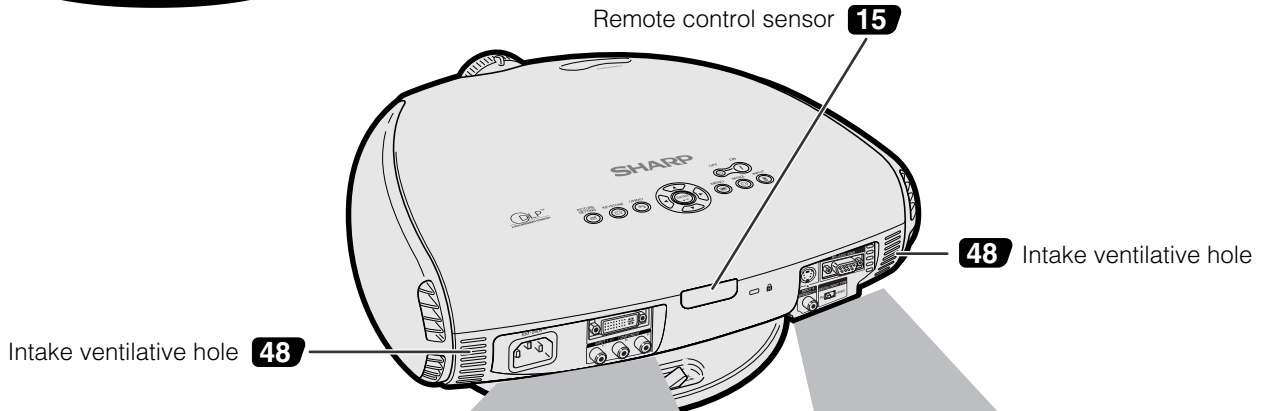

Attaching the Lens Cap

After putting the lens cap strap on the lens cap, pass the other end of the strap through the hole under the projector, next to the lens.

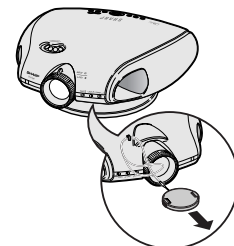



Part Names



Remote Control

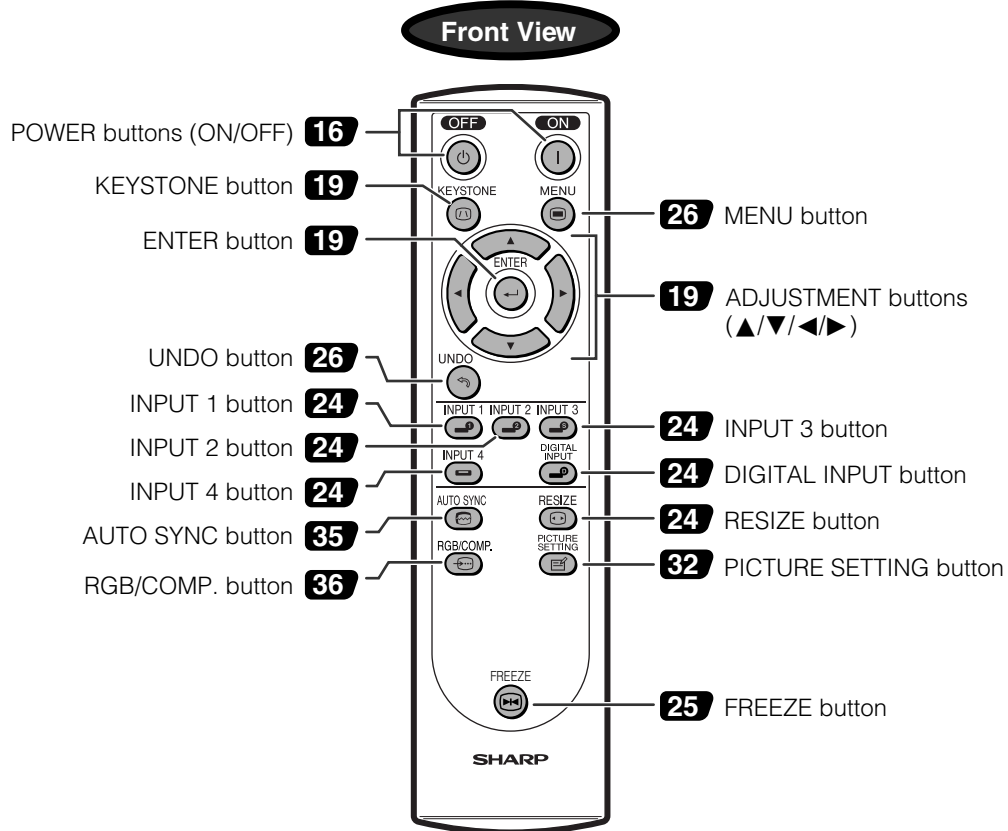

Top View

Remote control signal transmitters

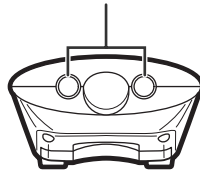

Inserting the batteries

<p>1 Pull down the tab on the battery cover and remove the cover towards the direction of the arrow.</p>	<p>2 Insert two AA size batteries, making sure the polarities match the + and - marks inside the battery compartment.</p>	<p>3 Insert the lower tab of the battery cover into the opening, and press the cover until it clicks in place.</p>
<p>Battery cover</p>	<p>Battery compartment</p>	<p>Battery cover</p>



Supplied Accessories

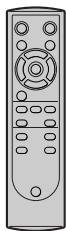

Remote control
RRMCGA088WJSA



Two AA size batteries

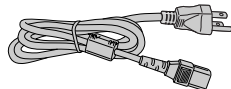

Power cord
QACCD A007WJPZ

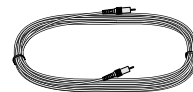

Video cable
QCNWGA001WJZZ



Lens cap
CCAPHA004WJ01



Lens cap strap
UBNDT0013CEZZ

Operation manual
TINS-A287WJZZ (A)

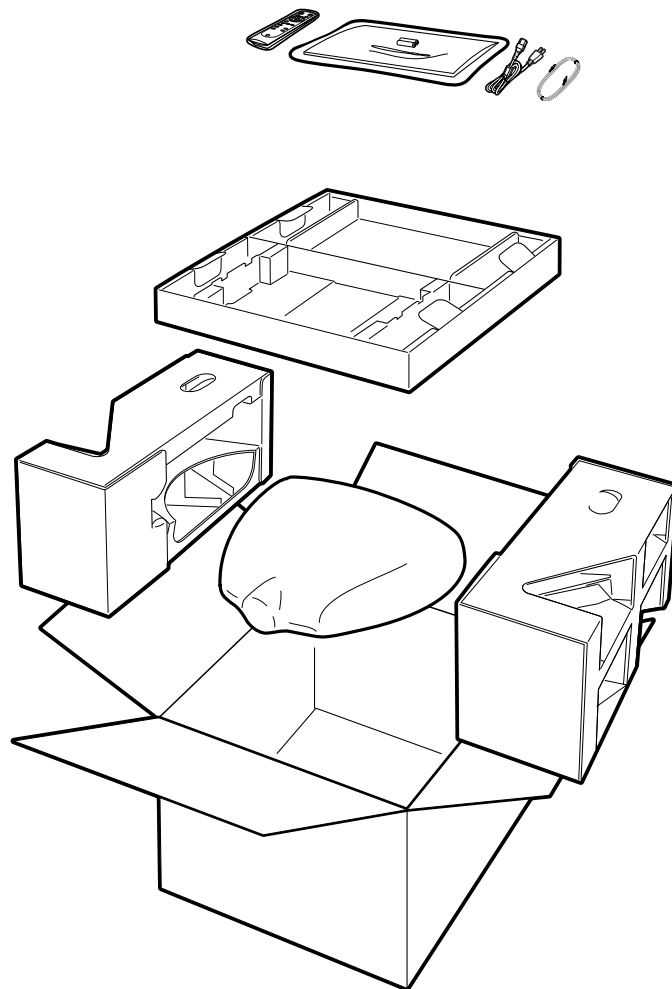



Connections



Power Supply

Connecting the Power Cord

Plug the supplied power cord into the AC socket on the back of the projector.

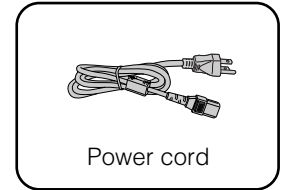
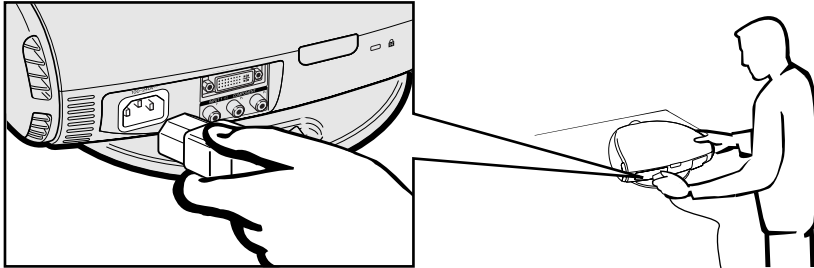

CAUTION

- Make sure the power cord is firmly connected into the AC socket.

NOTE

- The projector will enter the standby mode as you re-plug it into the AC socket, when unplugging the power cord after turning the power off by pressing the **POWER** button. However, if the projector was turned off by disconnecting the power cord or by a power failure, the projector will automatically turn on when plugging the power cord again.



Connecting to Video Equipment

You can connect your projector to a VCR, laser disc player, DVD player, DTV* decoder and other video equipment.

* DTV is the umbrella term used to describe the new digital television system in the United States.

CAUTION

- Make sure to turn both the projector and the video equipment off, before connecting.

NOTE

- As this projector is not equipped with audio input terminals, commercially available audio equipment or your own equipment (such as speakers or amplifiers) should be used.

Connecting a video source (VCR, laser disc player, DVD player or DTV decoder) using the INPUT 3 S-VIDEO and INPUT 4 VIDEO terminals

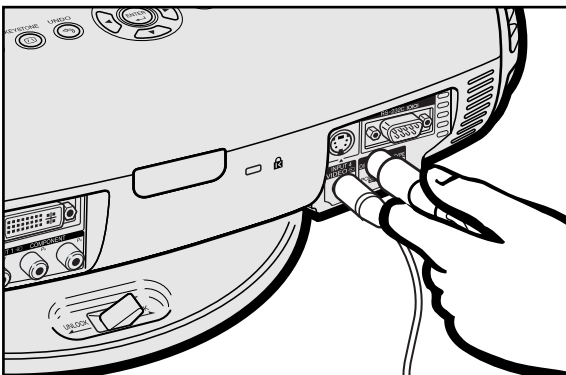

- ① Connect one end of the S-video cable (commercially available) to the **INPUT 3 S-VIDEO** terminal, or one end of the video cable to the **INPUT 4 VIDEO** terminal on the projector.
- ② Connect the other end of the S-video cable or the video cable to the S-video output or Video output terminal of the video source.

The S-video input terminal uses a video signal system where the picture is separated into a color and luminance signal to realize a higher-quality image.

NOTE

- For higher quality video, you may use the S-video input terminal on the projector. An S-video cable is commercially available.
- If your video equipment does not have an S-video output terminal, use the composite video output terminal.





Connecting to Video Equipment

Projector

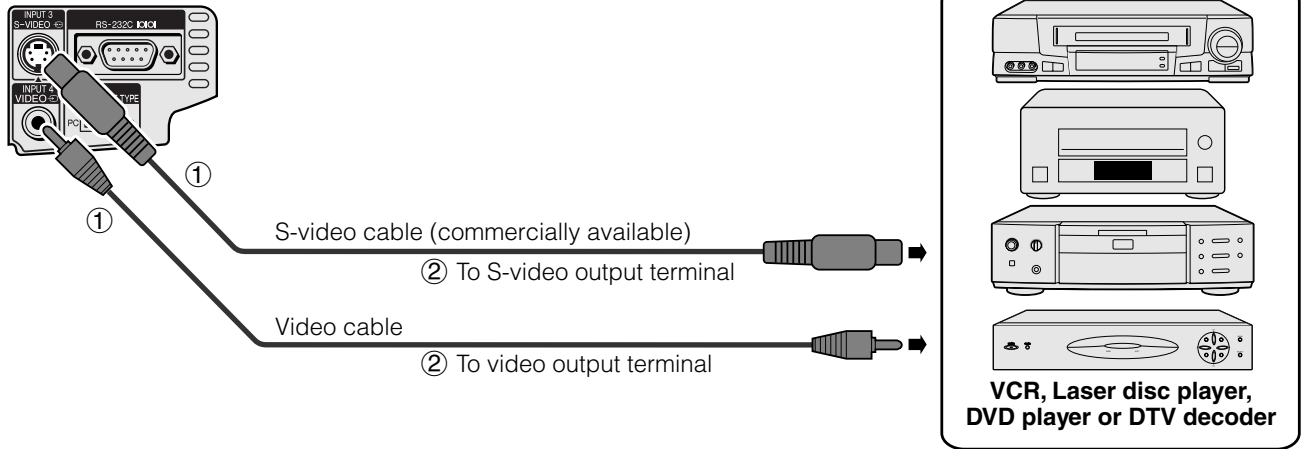

Connecting to a DVD Player and DTV Decoder

Connecting to a DVD player and DTV decoder with Component output (for INPUT 1)

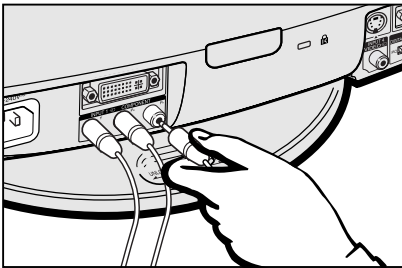

- ① Connect each RCA connector of a component cable to the corresponding RCA INPUT 1 terminals on the projector.
- ② Connect the other end of the cable to the corresponding terminals on a DVD player or DTV decoder.

CAUTION

- Make sure to turn both the projector and the video equipment off, before switching the "DIGITAL INPUT TYPE" switch and connecting.

Projector

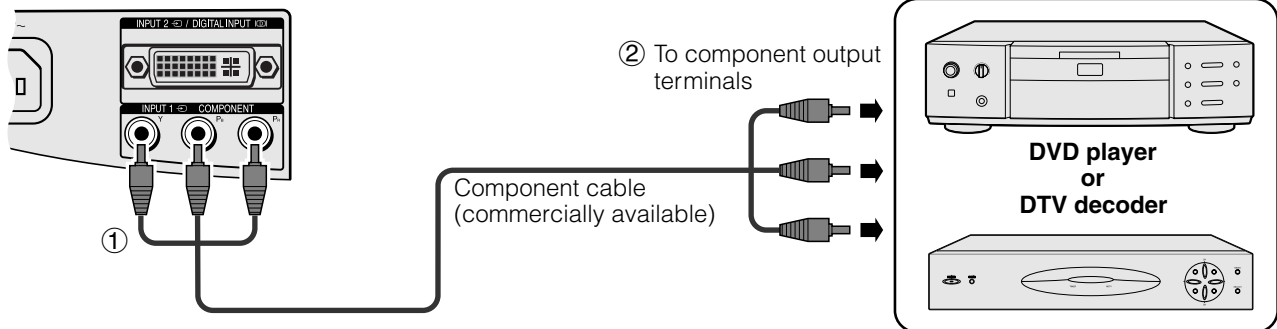

Connecting to a DVD player and DTV decoder with component output (for INPUT 2)

- ① Connect the 3 RCA to 15-pin D-Sub cable using the DVI to 15-pin D-Sub adaptor.
- ② Use the above cables to connect the projector and the DTV decoder.

When connecting this projector to analog RGB output of the DTV decoder, select "Component" for "Signal Type" on the OSD menu or press **RGB/COMP.** on the remote control. (See page 36.)

CAUTION

- Make sure to turn both the projector and the video equipment off, before switching the "DIGITAL INPUT TYPE" switch and connecting.

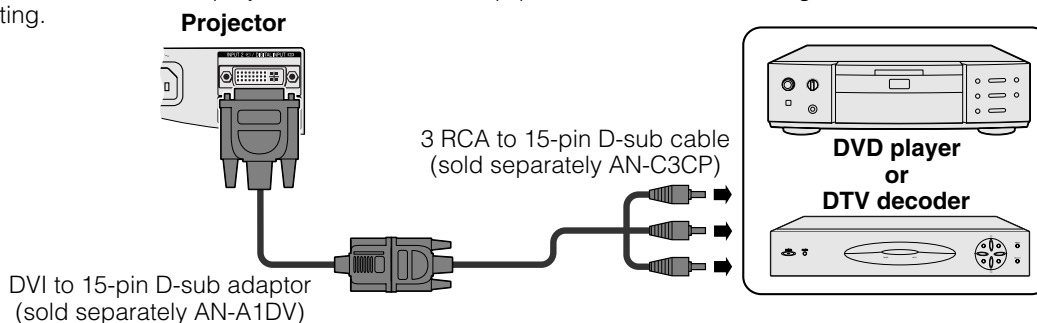



Connecting to a DVD Player and DTV Decoder

Connecting to a DTV decoder with DVI output

- ① Slide the “DIGITAL INPUT TYPE” switch on the back terminal board to “VIDEO”.
- ② Connect the DVI cable to the DIGITAL INPUT terminal.
- ③ Connect the other end to the Corresponding terminal on a DVD player and DTV decoder.

When connecting this projector to analog RGB output of the DTV decoder, select “Component” for “Signal Type” on the OSD menu or press **RGB/COMP.** on the remote control. (See page 36.)

CAUTION

- Make sure to turn both the projector and the video equipment off, before switching the “DIGITAL INPUT TYPE” switch and connecting.

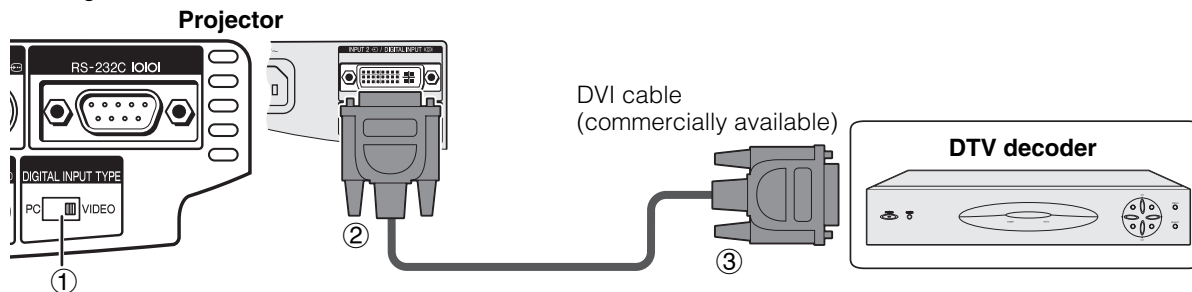

Connecting to a DTV decoder with analog RGB output

- ① Connect the DVI to 15-pin D-Sub adaptor.
- ② Use the above cables to connect the projector and the DTV decoder.

When connecting this projector to analog RGB output of the DTV decoder, select “Component” for “Signal Type” on the OSD menu or press **RGB/COMP.** on the remote control. (See page 36.)

CAUTION

- Make sure to turn both the projector and the video equipment off, before switching the “DIGITAL INPUT TYPE” switch and connecting.

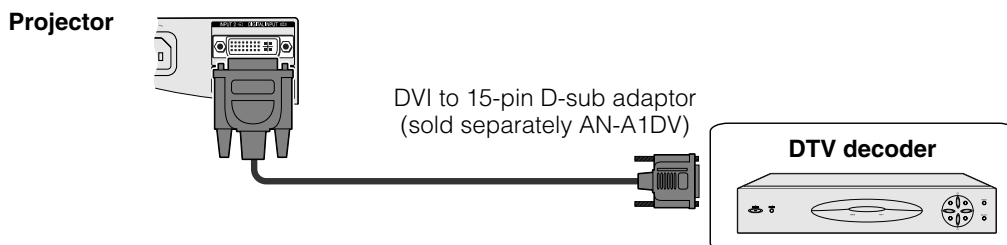

Connecting to a Computer

Connecting a computer with analog RGB output

- ① Connect the DVI end of the DVI to 15-pin D-sub adaptor to the INPUT 2 port on the projector.
- ② Connect the D-sub end of the DVI to 15-pin D-sub adaptor to the computer.

When connecting this projector to a DVD player or DTV decoder, select “RGB” for “Signal Type” on the OSD menu or press **RGB/COMP.** on the remote control. (See page 36.)

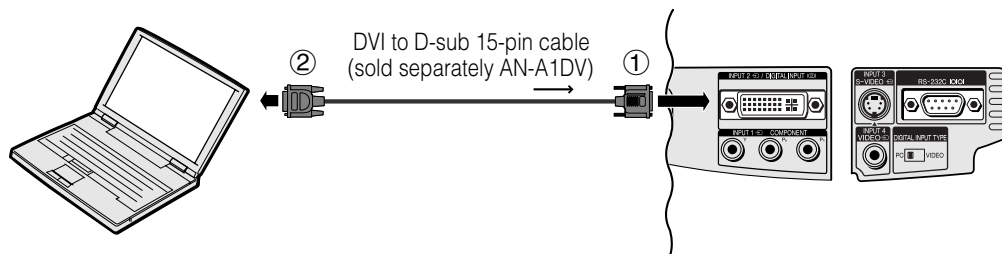



Connecting to a Computer

Connecting a computer with DIGITAL RGB output

- ① Slide the “DIGITAL INPUT TYPE” switch on the back terminal board to “PC”.
 - ② Connect one of the DVI cable (commercially available) to the DIGITAL INPUT port on the projector.
 - ③ Connect the other end to the Corresponding terminal on a computer.
- Make sure to turn both the projector and the video equipment off, before switching the “DIGITAL INPUT TYPE” switch and connecting.

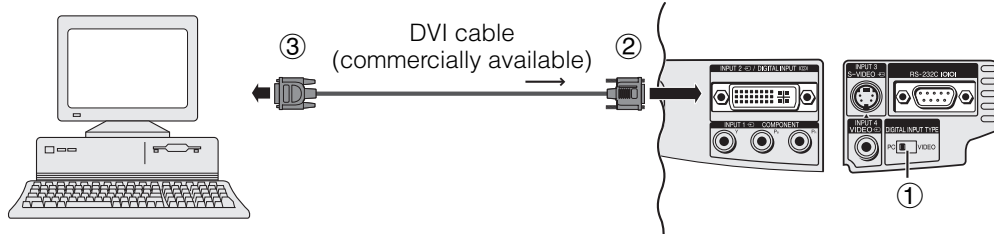

NOTE

- Refer to “Computer Compatibility Chart” on page 51 for a list of computer signals compatible with the projector. Use with computer signals other than those listed may cause some of the functions not to work.
- The arrows (→, ↔) in the configuration above indicate the direction of the signals.
- A Macintosh adaptor may be required for use with some Macintosh computers. Contact your nearest Sharp Authorized Service Center or Dealer.



Operating the Remote Control

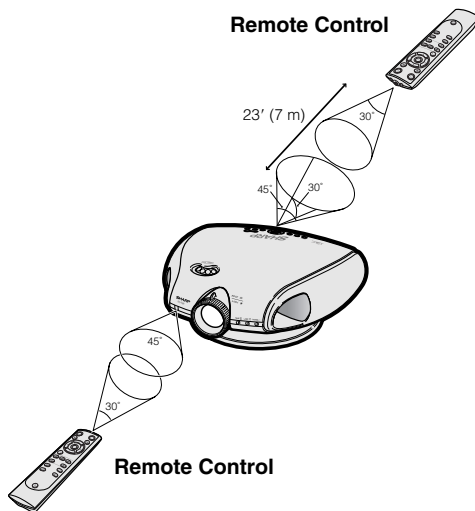

The remote control can be used to control the projector within the range shown on the left.

NOTE

- The signal from the remote control can be reflected off a screen for easy operation. However, the effective distance of the signal may differ due to the screen material.



Power ON/OFF

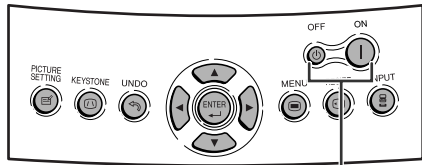

POWER buttons

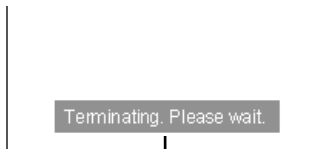
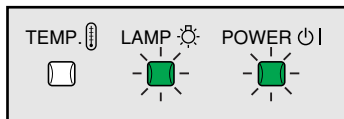
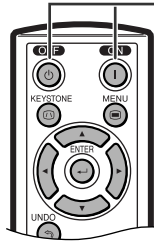

A dimly lit screen is displayed for a short time (about 20 seconds) to reduce lamp damage.

Press **POWER ON**.

- The blinking green LAMP REPLACEMENT indicator shows that the lamp is warming up. Wait until the indicator stops blinking before operating the projector.
- If the power is turned off and then immediately turned on again, it may take a short while before the lamp turns on.

NOTE

- After the projector is unpacked and turned on for the first time, a slight odor may be emitted from the exhaust ventilative hole. This odor will soon disappear with use.

When the power is on, the LAMP REPLACEMENT indicator illuminates, indicating the status of the lamp.

Green: Lamp is ready.

Green blinking: Warming up. / Cooling down.

Red: Change the lamp.

Press **POWER OFF**.

- Press **POWER OFF** again while the confirmation message is displayed. Then, message "Terminating. Please wait." will appear.

NOTE

- If you accidentally pressed **POWER OFF** and do not want to turn off the power, wait until the confirmation message disappears.
- When **POWER OFF** is pressed twice, the POWER indicator will illuminate in red and the cooling fan will run for about 90 seconds. The projector will then enter standby mode.
- Wait until the cooling fan stops running before disconnecting the power cord.
- The power can be turned on again by pressing **POWER ON**. When the power is turned on, the POWER indicator and the LAMP REPLACEMENT indicators illuminate in green.



Zooming and Focusing

The picture can be zoomed in or out, and focused by the Zoom knob and the Focus ring.

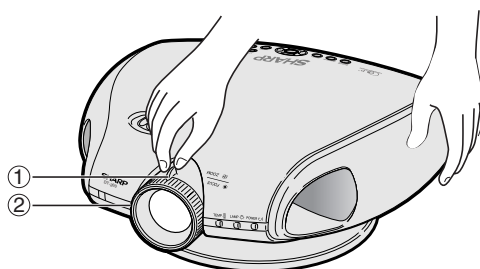

- ① Slide the Zoom knob. The image can be adjusted to the desired size within the zoom range.
- ② Rotate the Focus ring until the image on the screen becomes clear.



Setting Up the Screen



Using the Swivel Stand

①

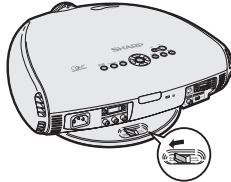

You can adjust the angle and direction of the projected image by using the Swivel Stand.

① Unlock the lever on the Swivel Stand.

②

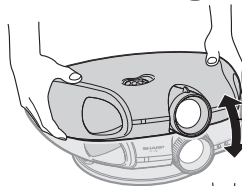

② Adjust the angle and direction of the projected image as you want by lifting up the projector and rotating the projector on the Swivel Stand.

③ Lock the lever on the Swivel Stand.

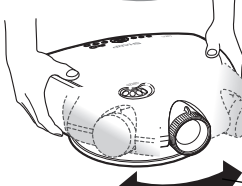

Adjustable up to $\pm 10^\circ$ from the standard position.

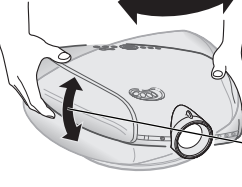

Adjustable up to $\pm 25^\circ$ from the standard position.

③

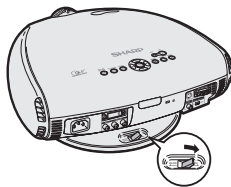

Adjustable up to $\pm 3^\circ$ from the standard position.

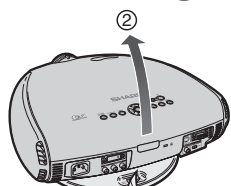

Removing the Swivel Stand

Lift the projector (②) with pressing the removing-stand button on the back of the projector (①).

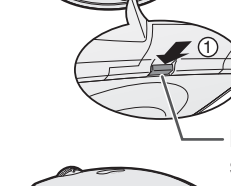

Attaching the Swivel Stand

Align the tabs on the front bottom of the projector (①). While holding down the button (②), place the projector onto the Swivel Stand (③) to attach.

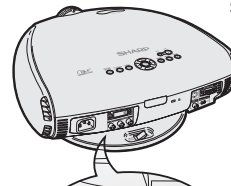

Removing-stand button

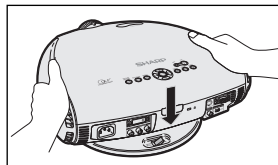

Press the projector down firmly to attach it to the Swivel Stand to make sure it is securely attached to the Swivel Stand.

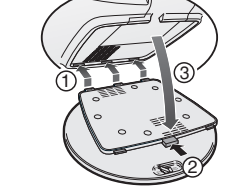

CAUTION

- Do not hold the lens when lifting, lowering or rotating the projector.
- When lowering the projector, be careful not to get your fingers caught in the area between the Swivel Stand and the projector.

NOTE

- When the height or direction of the projector is adjusted, the image may become distorted (keystoned), depending on the relative positions of the projector and the screen. See page 19 for details on the keystone correction.



Using the Lens Shift

The picture can be adjusted within the shift range of the lens by rotating the lens shift dial on the top of the projector using your finger.

Projector

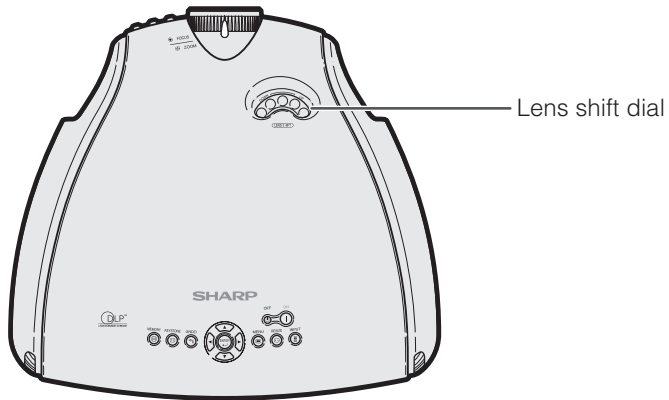

Projected Image

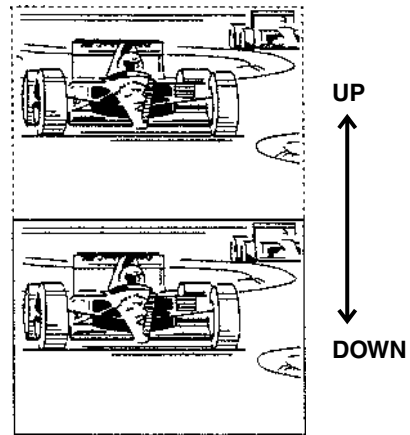



Keystone Correction

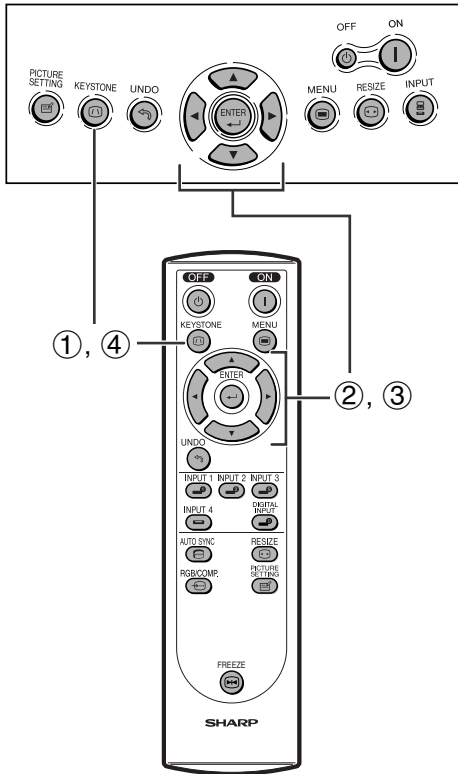

This function can be used to adjust the Keystone settings.

NOTE

- For details about using the menu screen, see page 26.

Description of 2D Keystone Correction

Selected item	Description
H Keystone	Horizontally adjusts the keystone settings.
V Keystone	Vertically adjusts the keystone settings.
Reset	V and H Keystone adjustments are returned to the factory preset settings.

Horizontal Keystone Correction

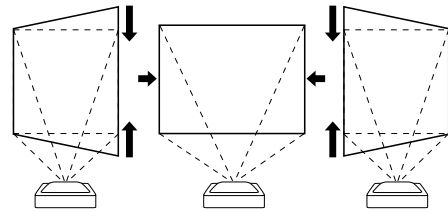

Vertical Keystone Correction

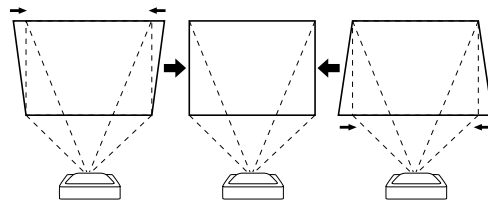

- ① Press **KEYSTONE** on the projector or on the remote control.
- ② Press **▲/▼** to select “H Keystone” or “V Keystone”.
- ③ Press **◀/▶** to move the **■** mark on the selected adjustment item to the desired setting.
- ④ To return to the normal screen, press **KEYSTONE** again.

NOTE

- Straight lines and the edges of the displayed image may appear jagged, when adjusting the Keystone setting.
- When adjusting “H Keystone” and “V Keystone” at the same time, the values of adjustable angles for each setting become smaller.
- The “Digital Shift” and “Subtitle” cannot be adjusted when Keystone correction is applied.



Placement of the Projected Image Using the Keystone Correction



■ : Screen area

Place the projector at a distance from the screen that allows images to be projected onto the screen by referring to “Adjusting the Projection Distance” on pages 21 and 22.

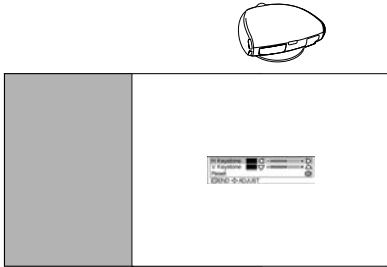

- ① Project the test pattern of the Keystone correction function onto the screen. Rotate the Focus ring until the image on the screen becomes clear. (See page 16.)

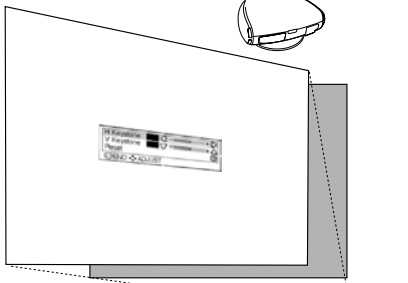

- ② Change the projection angle using the Swivel Stand to properly project images onto the screen. (See page 17.)

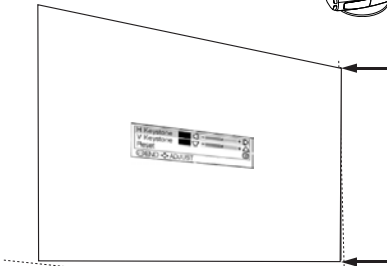

- ③ Align the edge of the screen closest to the projector with the test pattern by adjusting the zoom and the Swivel Stand. (See pages 16 and 17.)

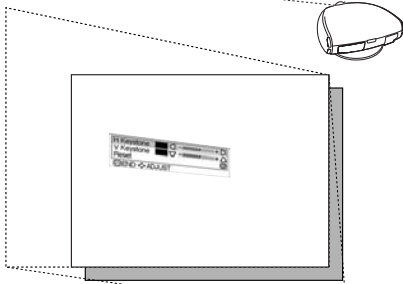

- ④ Adjust the Keystone function so that the size of the projected image matches the screen size. (See page 19.)

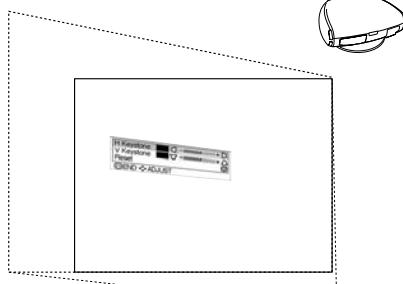

- ⑤ Align the image on the screen by adjusting the zoom function and the Swivel Stand.

- ⑥ Adjust the focus so that the projected image is in focus at the center of the screen. (See page 16.)

NOTE

- The aspect ratio of the projected image shifts slightly when the lens shift is at a position other than the top position.
- The aspect ratio of the projected image also shifts slightly when the “H Keystone” and “V Keystone” functions are adjusted simultaneously.



Adjusting the Projection Distance

- Refer to pages 19 and 20 about the function of Keystone correction and placement of projector using the correction.
- Decide the placement of the projector referring to the figures on the table and the diagram below according to the size of your screen and Input Signal.

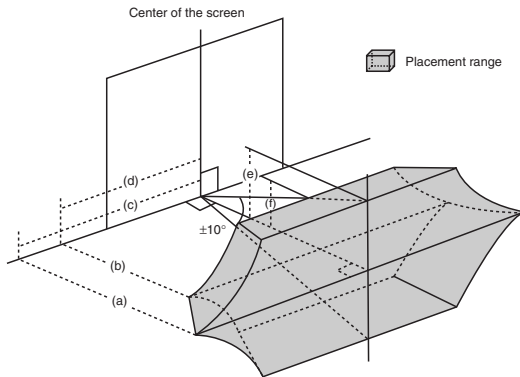

- (a) Maximum projection distance
- (b) Minimum projection distance
- (c) Horizontal placement range when projection distance is maximum.
- (d) Horizontal placement range when projection distance is minimum.
- (e) Vertical placement range when projection distance is maximum.
- (f) Vertical placement range when projection distance is minimum.

NOTE

- The aspect ratio of the projected image shifts slightly when the lens shift is at a position other than the top position.
- The aspect ratio of the projected image also shifts slightly when the "H Keystone" and "V Keystone" functions are adjusted simultaneously.
- Keystone correction cannot be applied to On Screen Display.
- When Keystone correction is applied, the resolution of image can be deteriorated to some extent.
- There are errors of $\pm 3\%$ in the formulas below.

When using a normal screen (4:3)

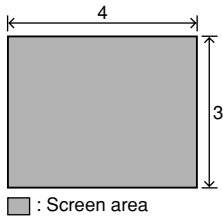

Screen size		Projection distance and Keystone correction									
(4:3)(x)		Maximum projection distance					Minimum projection distance				
Diag.	Projection distance (a)	Horizontal Placement range (c)			Vertical placement range (e)	Projection distance (b)	Horizontal Placement range (d)			Vertical placement range (f)	
		Composite, S-video 480i/P, 1080i	720P	RGB			Composite, S-video 480i/P, 1080i	720P	RGB		
200"	-	-	-	-	-	20' 4" (6.2 m)	4'11" (1.5 m)	3' 7" (1.1 m)	2' 7" (0.8 m)	4' 7" (1.4 m)	
150"	18' 5" (5.6 m)	5' 7" (1.7 m)	3'11" (1.2 m)	2'11" (0.9 m)	3'11" (1.2 m)	15' 3" (4.6 m)	3' 7" (1.1 m)	2' 7" (0.8 m)	1'12" (0.6 m)	3' 3" (1.0 m)	
100"	12' 3" (3.7 m)	3' 7" (1.1 m)	2' 7" (0.8 m)	1'12" (0.6 m)	2' 7" (0.8 m)	10' 2" (3.1 m)	2' 4" (0.7 m)	1' 8" (0.5 m)	1' 4" (0.4 m)	2' 4" (0.7 m)	
84"	10' 2" (3.1 m)	2'11" (0.9 m)	1'12" (0.6 m)	1' 8" (0.5 m)	2' 4" (0.7 m)	8' 6" (2.6 m)	1'12" (0.6 m)	1' 4" (0.4 m)	12" (0.3 m)	1' 8" (0.5 m)	
72"	8' 9" (2.7 m)	2' 7" (0.8 m)	1' 8" (0.5 m)	1' 4" (0.4 m)	1'12" (0.6 m)	7' 3" (2.2 m)	1' 8" (0.5 m)	12" (0.3 m)	12" (0.3 m)	1' 8" (0.5 m)	
60"	7' 3" (2.2 m)	1'12" (0.6 m)	1' 4" (0.4 m)	12" (0.3 m)	1' 8" (0.5 m)	6" (1.8 m)	1' 4" (0.4 m)	12" (0.3 m)	8" (0.2 m)	1' 4" (0.4 m)	
40"	4'11" (1.5 m)	1' 4" (0.4 m)	12" (0.3 m)	8" (0.2 m)	12" (0.3 m)	3'11" (1.2 m)	12" (0.3 m)	8" (0.2 m)	4" (0.1 m)	8" (0.2 m)	

$$(a) = (0.03765x - 0.03286)/0.3048$$

x : Screen size (diag.) (inches)

$$(b) = (0.031182x - 0.033542)/0.3048$$

When using a wide screen (16:9)

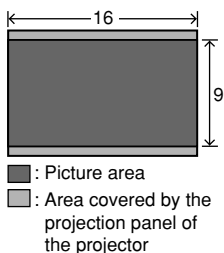

Screen size		Projection distance and Keystone correction									
(16:9)(x)		Maximum projection distance					Minimum projection distance				
Diag.	Projection distance (a)	Horizontal Placement range (c)			Vertical placement range (e)	Projection distance (b)	Horizontal Placement range (d)			Vertical placement range (f)	
		Composite, S-video 480i/P, 1080i	720P	RGB			Composite, S-video 480i/P, 1080i	720P	RGB		
200"	26'11" (8.2 m)	8' 2" (2.5 m)	5'11" (1.8 m)	4' 7" (1.4 m)	5'11" (1.8 m)	22' 2" (6.8 m)	5' 3" (1.6 m)	3'11" (1.2 m)	2'11" (0.9 m)	4'11" (1.5 m)	
150"	20' 1" (6.1 m)	5'11" (1.8 m)	4' 3" (1.3 m)	3' 3" (1.0 m)	4' 7" (1.4 m)	16' 7" (5.1 m)	3'11" (1.2 m)	2'11" (0.9 m)	2' 4" (0.7 m)	3' 7" (1.1 m)	
133"	17'10" (5.4 m)	5' 3" (1.6 m)	3' 7" (1.1 m)	2'11" (0.9 m)	3'11" (1.2 m)	14' 9" (4.5 m)	3' 7" (1.1 m)	2' 7" (0.8 m)	1'12" (0.6 m)	3' 3" (1.0 m)	
106"	14' 2" (4.3 m)	4' 3" (1.3 m)	2'11" (0.9 m)	2' 4" (0.7 m)	2'11" (0.9 m)	11' 8" (3.6 m)	2' 7" (0.8 m)	1'12" (0.6 m)	1' 8" (0.5 m)	2' 7" (0.8 m)	
100"	13' 4" (4.1 m)	3'11" (1.2 m)	2'11" (0.9 m)	2' 4" (0.7 m)	2'11" (0.9 m)	11' (3.4 m)	2' 7" (0.8 m)	1'12" (0.6 m)	1' 4" (0.4 m)	2' 4" (0.7 m)	
92"	12' 3" (3.7 m)	3' 7" (1.1 m)	2' 7" (0.8 m)	1'12" (0.6 m)	2' 7" (0.8 m)	10' 2" (3.1 m)	2' 4" (0.7 m)	1' 8" (0.5 m)	1' 4" (0.4 m)	2' 4" (0.7 m)	
84"	11' 2" (3.4 m)	3' 3" (1.0 m)	2' 4" (0.7 m)	1' 8" (0.5 m)	2' 4" (0.7 m)	9' 3" (2.8 m)	1'12" (0.6 m)	1' 8" (0.5 m)	1' 4" (0.4 m)	1'12" (0.6 m)	
72"	9' 7" (2.9 m)	2' 7" (0.8 m)	1'12" (0.6 m)	1' 4" (0.4 m)	1'12" (0.6 m)	7'11" (2.4 m)	1' 8" (0.5 m)	1' 4" (0.4 m)	12" (0.3 m)	1' 8" (0.5 m)	
60"	7'11" (2.4 m)	2' 4" (0.7 m)	1' 8" (0.5 m)	1' 4" (0.4 m)	1' 8" (0.5 m)	6' 7" (2.0 m)	1' 4" (0.4 m)	12" (0.3 m)	8" (0.2 m)	1' 4" (0.4 m)	
40"	5' 3" (1.6 m)	1' 4" (0.4 m)	12" (0.3 m)	8" (0.2 m)	12" (0.3 m)	4' 3" (1.3 m)	12" (0.3 m)	8" (0.2 m)	4" (0.1 m)	8" (0.2 m)	

$$(a) = (0.041019x - 0.033286)/0.3048$$

x : Screen size (diag.) (inches)

$$(b) = (0.033972x - 0.033542)/0.3048$$



Adjusting the Projection Distance

Upper and Lower Lens Shift Position

- This projector is equipped with a lens shift function that lets you adjust the projection height.
- Adjust it to match the setup configuration.
- The screen can be moved maximum the length of one screen vertically using the lens shift.

NOTE

- Optimal image quality is produced with the projector positioned perpendicular to the screen with all feet flat and level. Tilting or angling the projector will reduce the effectiveness of the lens shift function.

Screen size: 100 inches (254 cm)

Aspect ratio: 4:3

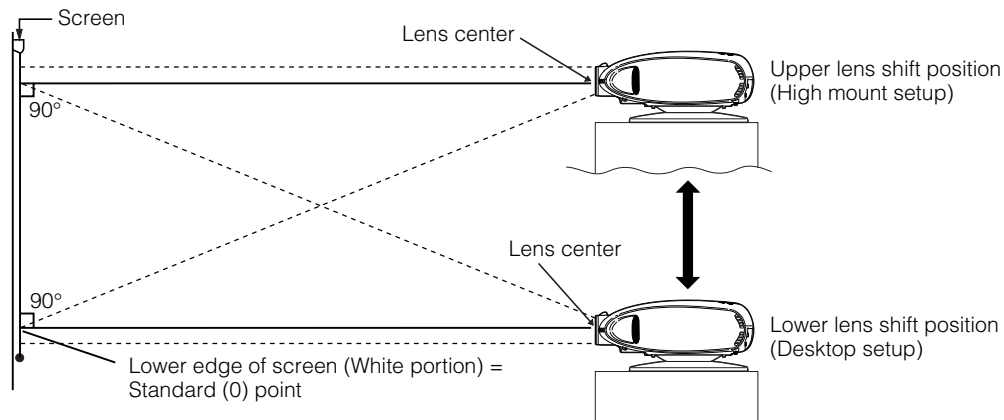

Upper and Lower Lens Shift Position (Ceiling Mount)

When the projector is in the inverted position, use the upper edge of the screen as the base line, and exchange the lower and upper lens shift values.

Screen size: 100 inches (254 cm)

Aspect ratio: 4:3

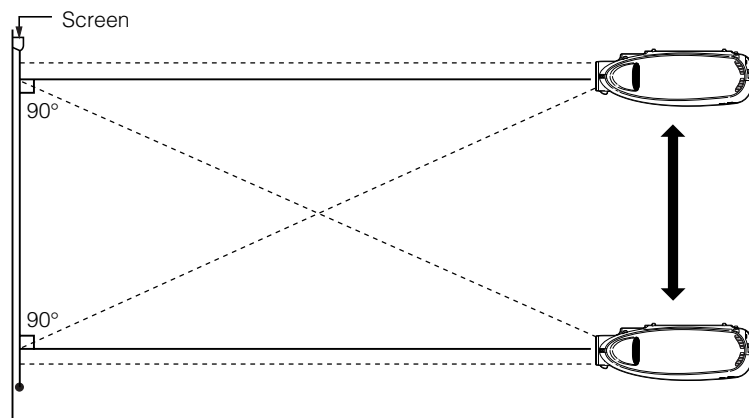
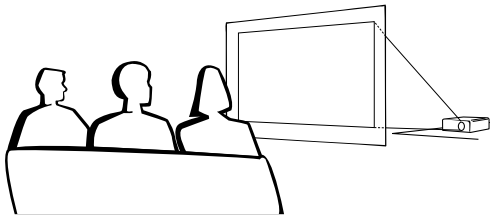



Image Projection



Rear Projection



- Place a translucent screen between the projector and the audience.
- Use the projector's menu screen to reverse the projected image. (See page 42 for use of this function.)

NOTE

- Optimal image quality can be achieved when the projector is positioned perpendicular to the screen with all feet flat and leveled.



Projection Using a Mirror

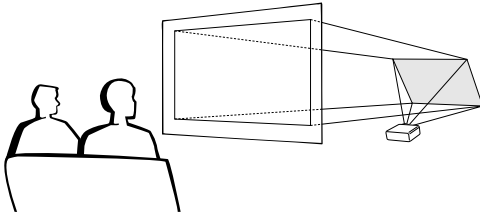

- When the distance between the projector and a screen is not sufficient for normal rear projection, you can use a mirror to reflect the image onto the screen.
- Place a mirror (normal flat type) in front of the lens.
- Project the normal image onto the mirror.
- The image reflected from the mirror is projected onto the translucent screen.

CAUTION

- When using a mirror, be sure to carefully position both the projector and the mirror so the light does not shine into the eyes of the audience.



Ceiling-mount Projection

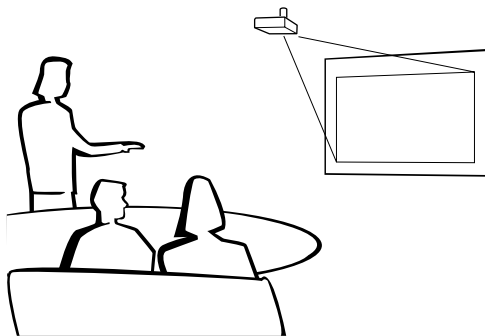

- It is recommended that you use the optional Sharp ceiling-mount bracket for this installation.
- Before mounting the projector, remove the Swivel Stand. (See page 17 for removing and attaching the Swivel Stand.)
- Before mounting the projector, contact your nearest Sharp Authorized Service Center or Dealer to obtain the recommended ceiling-mount bracket (commercially available). (AN-CM260 ceiling-mount bracket, AN-EP101B extension tube for AN-CM260.)
- When the projector is in the inverted position, use the upper edge of the screen as the base line.
- Use the projector's menu screen to select the appropriate projection mode. (See page 42 for use of this function.)





Using the Operation Buttons



Selecting the Input Signal Source

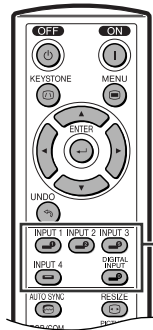
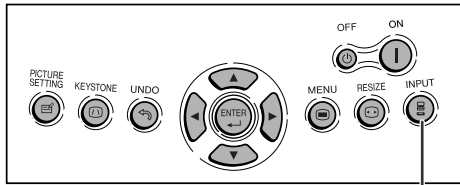

INPUT button

Press **INPUT** on the projector, **INPUT 1**, **INPUT 2**, **INPUT 3**, **INPUT 4** or **DIGITAL INPUT** on the remote control to select the desired input mode.

NOTE

- When no signal is received, "NO SIGNAL" will be displayed.
- When a signal that the projector is not preset to receive is received, "NOT REG." will be displayed.

On-screen Display

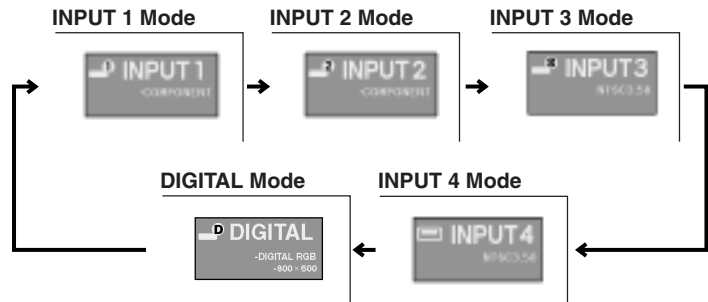

Adjusting the Picture Aspect Ratio

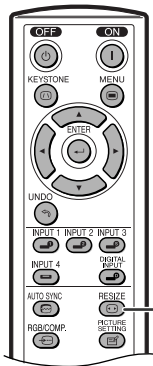
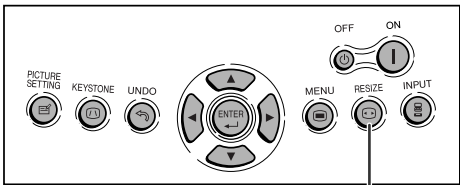



1

This function allows you to modify or customize the picture display mode to enhance the input image. Depending on the input signal, you can choose NORMAL, BORDER or STRETCH image.

- 1 Press **RESIZE**. Each time **RESIZE** is pressed, the picture mode changes as shown on the next page.

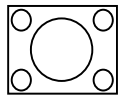
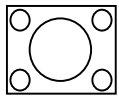
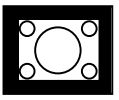
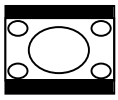
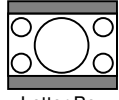
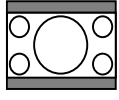
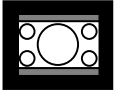
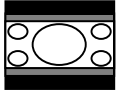
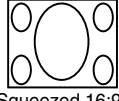
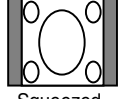
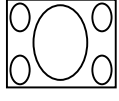
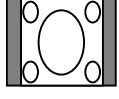

Adjusting the Picture Aspect Ratio

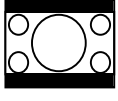
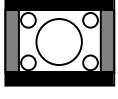
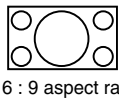
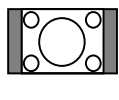
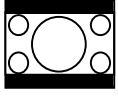
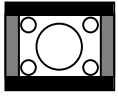
Input Signal		Output screen image			
DVD / VIDEO	COMPUTER	Image Type	NORMAL Projects the image fully on a screen while maintaining the aspect ratio.	BORDER Projects the image on the screen whose surrounding areas are cut out to make a 4:3 screen while maintaining the aspect ratio.	STRETCH Projects the image on the screen whose upper and lower areas are cut out to make a 16:9 screen while the image is horizontally enlarged.
480i 480P 540P NTSC PAL SECAM	VGA (640x480) SVGA (800x600) XGA (1024x768)	 4:3 aspect ratio	* 	* 	
		 Letter Box	*  —	* 	
		 Squeezed 16:9  Squeezed 4:3 image	 	 	*  * 
720P 1080i	—	 16 : 9 aspect ratio 			*  * 

* Mode for projecting an image with the original aspect ratio without cutting any portions.

 : Cutout area on which images cannot be projected.

 : Area on which the image is not included in the original signals.



Freeze Function

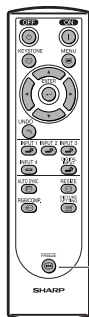

FREEZE button



This function allows you to instantly freeze a moving image. This is useful when you want to display a still image from a computer or video, giving you more time to explain the image to the audience. You can also use this function to display a still image from a computer while you make preparations for the next computer images to be presented.

- ① Press **FREEZE** to freeze the image.
- ② Press **FREEZE** again to return to the moving image.

NOTE

- The still image is cancelled should any of the following occur while the picture is frozen.
 - Pressing the **INPUT** button
 - Interruption of the video signal
 - Pressing the **FREEZE** button



Using the Menu Screen



Basic Operations

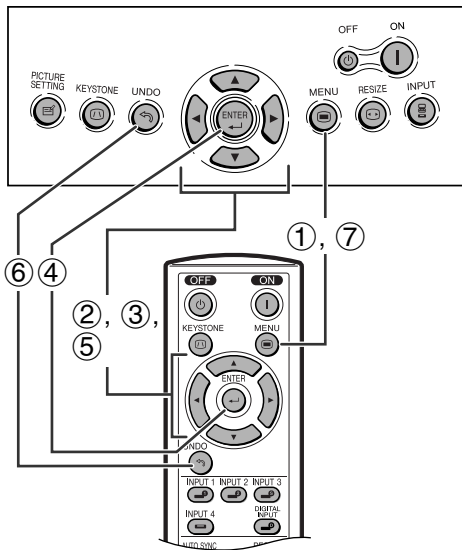

This projector has two sets of menu screens that allow you to adjust the image and various projector settings. These menu screens can be operated from the projector or the remote control with the following procedure.

On-screen Display

INPUT 1 (COMPONENT), 2 (COMPONENT or analog RGB) or DIGITAL INPUT (digital RGB) mode

INPUT 3 or 4 (VIDEO) mode

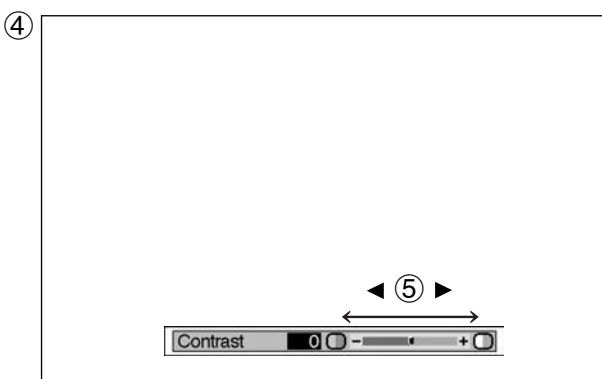
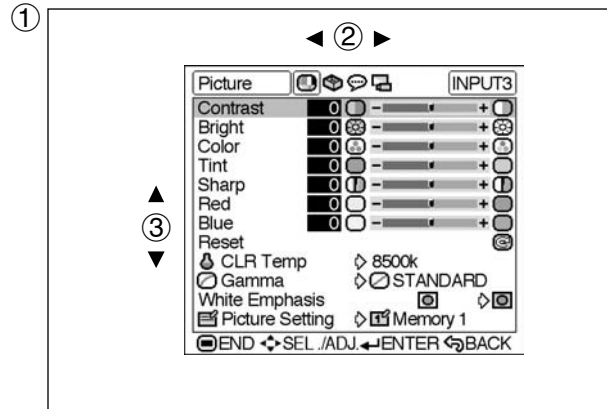
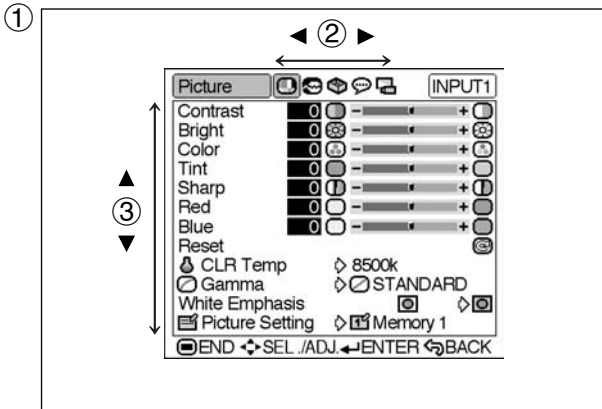

- ① Press **MENU**. The "Picture" menu screen for the selected INPUT mode appears.
- ② Press **◀/▶** to display the other menu screen, if you want. The icon for the selected menu screen will be highlighted.
- ③ Press **▲/▼** to select a specific adjustment item.
- ④ Press **ENTER** after selecting the item if you want to display a single adjustment item. Only the selected adjustment item will appear.
- ⑤ Press **◀/▶** to adjust the item.
- ⑥ Press **UNDO** to return to the previous screen.
- ⑦ To exit the menu screen, press **MENU**.

NOTE

- For details on items on the menu screen, see the tree charts on pages 27 and 28.





Menu Bars

Items on the INPUT 1 or 2 Mode Menu Bar

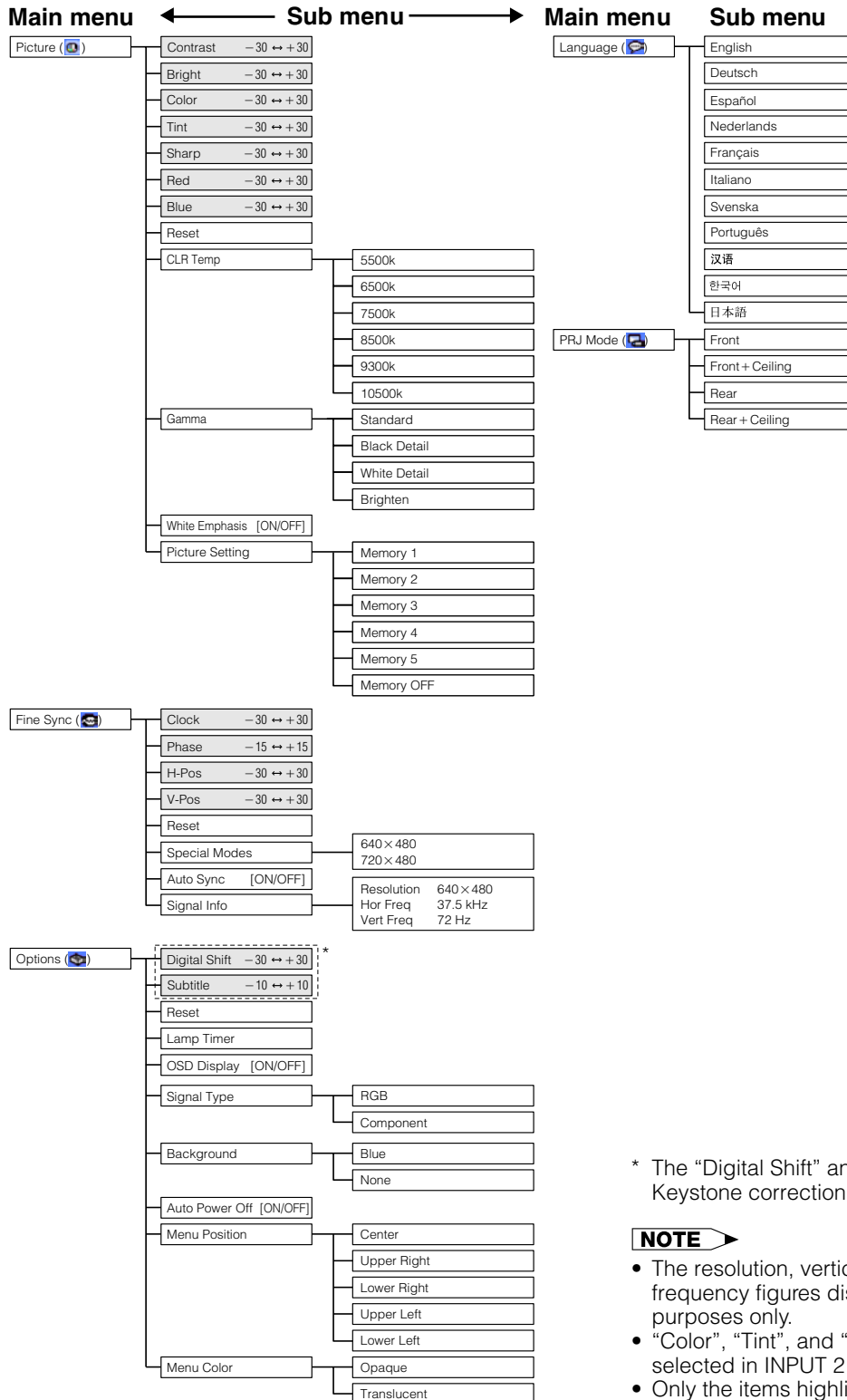

* The "Digital Shift" and "Subtitle" cannot be adjusted when Keystone correction is applied.

NOTE

- The resolution, vertical frequency and horizontal frequency figures displayed above are for example purposes only.
- "Color", "Tint", and "Sharp" do not appear when "RGB" is selected in INPUT 2 mode.
- Only the items highlighted in the tree charts above can be adjusted.
- To adjust the items under the sub menu, press ► after selecting the sub menu.
- "Signal Type" is not displayed when using INPUT 1.
- "Contrast", "Bright", "Color", "Tint" and "Sharp", "Clock", "Phase", "H-Pos" and "V-Pos", and "CLR-Temp", "Gamma", "Special Modes" and "Auto Sync" cannot be used in the DIGITAL INPUT mode.
- "Clock", "Phase", "H-Pos" and "V-Pos" cannot be used in the Component mode.





Menu Bars

Items on the INPUT 3 or 4 Mode Menu Bar

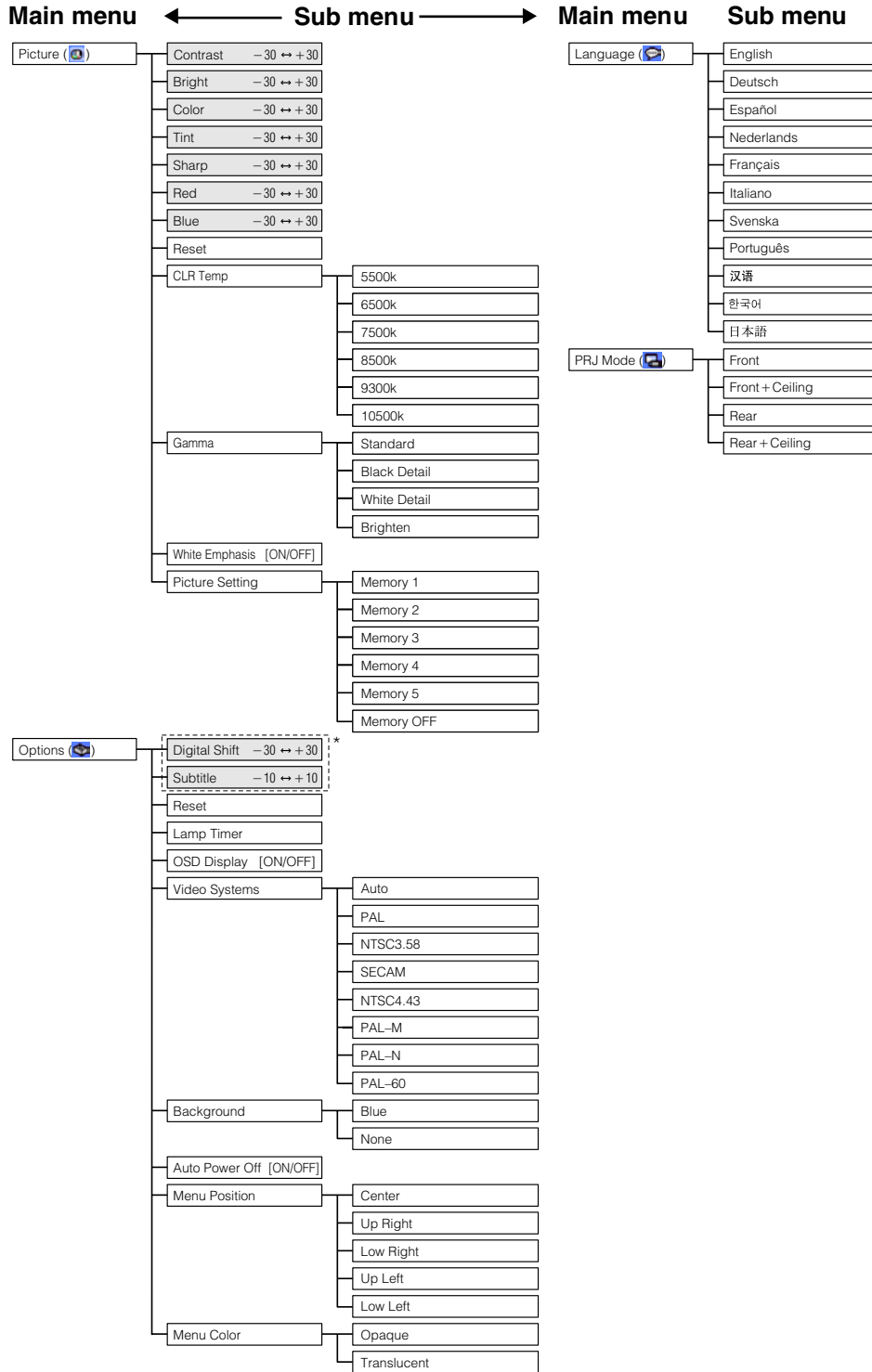

* The “Digital Shift” and “Subtitle” cannot be adjusted when Keystone correction is applied.

NOTE

- Only the items highlighted in the tree charts above can be adjusted.
- To adjust the items under the sub menu, press ► after selecting the sub menu.
- “Tint” cannot be used with PAL, SECAM, PAL-M, PAL-N or PAL-60.





Adjusting the Picture

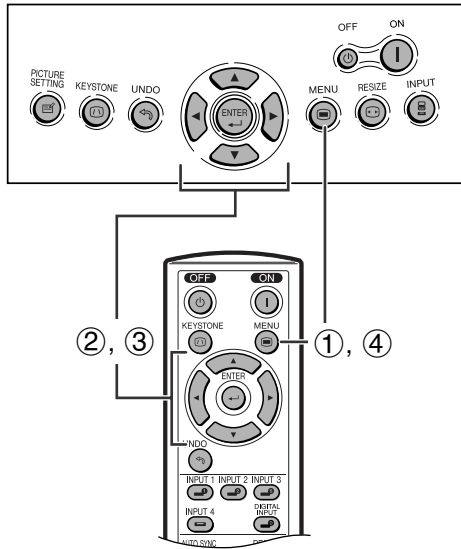

On-screen Display
e. g. (VIDEO input in INPUT 3 or 4 mode)

①

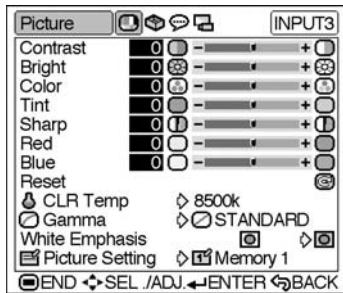

②

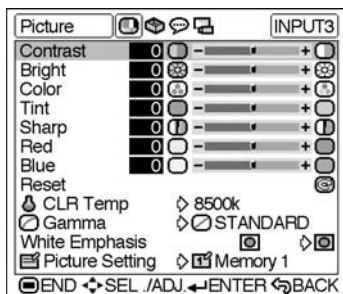

You can adjust the projector's picture to your preferences with the following picture settings. To save the settings, select a memory from 1 to 5 and OFF (see page 32) and then adjust the settings.

Description of Adjustment Items

Selected item	◀ button	▶ button
Contrast	For less contrast	For more contrast
Brightness	For less brightness	For more brightness
Color	For less color intensity	For more color intensity
Tint	Skin tones become purplish	Skin tones become greenish
Sharp	For less sharpness	For more sharpness
Red	For weaker red	For stronger red
Blue	For weaker blue	For stronger blue
CLR Temp	For selecting a desired item from six color temperature settings	
Gamma	For selecting a desired item from four gamma positions	
White Emphasis	For switching "on" or "off" the function that emphasizes bright portions of the image	
Picture Setting	For storing all items set in "Picture"	
Reset	All image adjustment items are returned to the factory preset settings.	

NOTE

- "Color", "Tint" and "Sharp" do not appear for RGB input in INPUT 2 mode.
- For details on "Gamma", see "Gamma Correction Function" on page 31.
- For details on "CLR Temp", see "Adjusting the Color Temperature" on page 30.
- For details on "White Emphasis", see "Description of White Emphasis" on page 30.
- For details on "Picture Setting", see "Picture Setting Function" on page 32.

- ① Press **MENU**. The "Picture" menu screen appears.
- ② Press ▲/▼ to select a specific adjustment item.
- ③ Press ◀/▶ to move the ▀ mark of the selected adjustment item to the desired setting.
- ④ To exit the menu screen, press **MENU**.

NOTE

- To reset all adjustment items, select "Reset" on the "Picture" menu screen and press **ENTER**.
- "Tint" cannot be used with PAL, SECAM, PAL-M, PAL-N or PAL-60.
- "Contrast", "Bright", "Color", "Tint" and "Sharp" cannot be used in the DIGITAL INPUT mode.





Adjusting the Picture

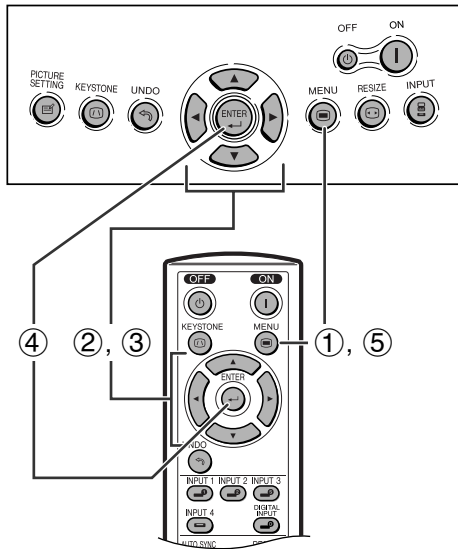

On-screen Display

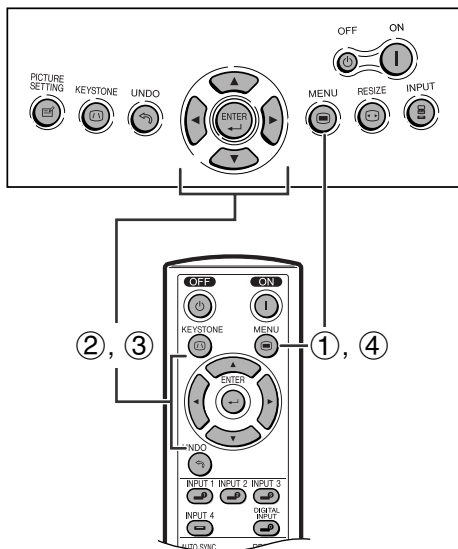
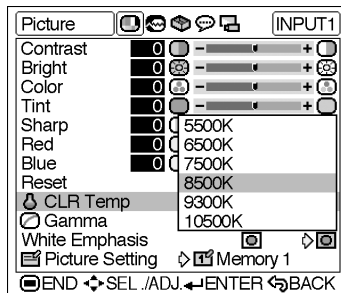

On-screen Display

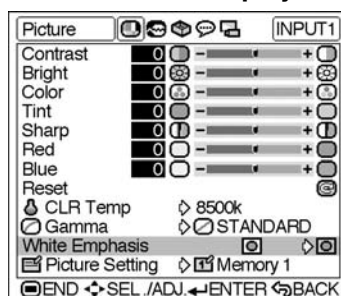

Adjusting the Color Temperature

This function allows for selecting the desired color temperature from six settings. With the lower value selected, the projected image becomes warmer, reddish and incandescent-like while with the higher value, the image becomes cooler, bluish and fluorescent-like.

Description of Color Temperature

- 1 Press **MENU**. The "Picture" menu screen appears.
- 2 Press **▲/▼** to select "CLR Temp", and then press **▶**.
- 3 Press **▲/▼** to select the desired color temperature setting.
- 4 Press **ENTER** to save the setting.
- 5 To exit the menu screen, press **MENU**.

NOTE

- Values on "CLR Temp" are only for general standard purposes. The less the value is set to, the warmer, reddish, incandescent-like the image becomes. The more the value is set to, the cooler, bluish, fluorescent-like the image becomes.
- "CLR-Temp" cannot be used in the DIGITAL INPUT mode.

Emphasizing the Contrast

This function emphasizes the bright portions of images to obtain a higher contrast image.

Description of White Emphasis

Selected item	Description
ON	For emphasizing the bright portions of images
OFF	For disabling "White Emphasis"

- 1 Press **MENU**. The "Picture" menu screen appears.
- 2 Press **▲/▼** to select "White Emphasis".
- 3 Press **◀/▶** to select the desired white emphasis setting.
- 4 To exit the menu screen, press **MENU**.





Adjusting the Picture

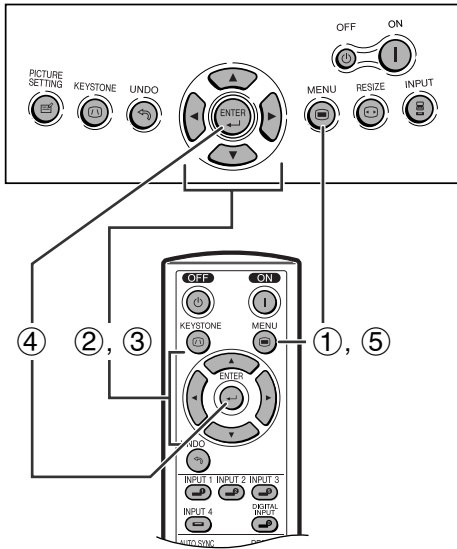

On-screen Display

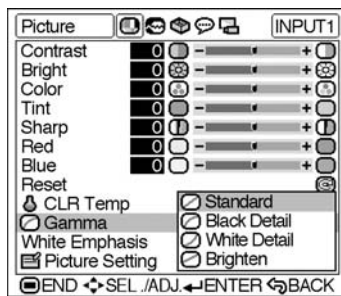

Gamma Correction Function

Gamma is an image quality enhancement function. Four gamma settings are available to allow for differences in the brightness of the room.

Description of Gamma Modes

Selected Mode	Description
Standard	Standard picture without gamma correction
Black Detail	Gives greater depth to darker portions of images for a more exciting theater experience.
White Detail	Emphasizes the gradation of the intermediate to high brightness portions of the image for more detailed expression.
Brighten	Brighten the darker portions of images for easier viewing in a dimly lit room.

- ① Press **MENU**. The "Picture" menu screen appears.
- ② Press ▲/▼ to select "Gamma", and then press ►.
- ③ Press ▲/▼ to select the desired gamma mode.
- ④ Press **ENTER** to save the setting.
- ⑤ To exit the menu screen, press **MENU**.

NOTE

- Gamma cannot be used in the DIGITAL INPUT mode.

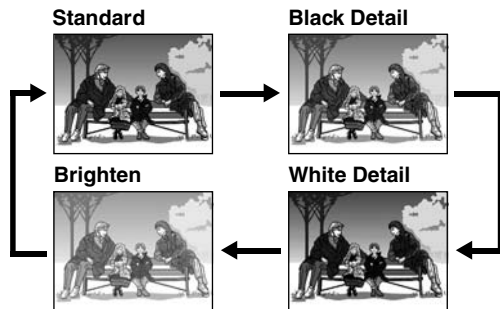



Adjusting the Picture

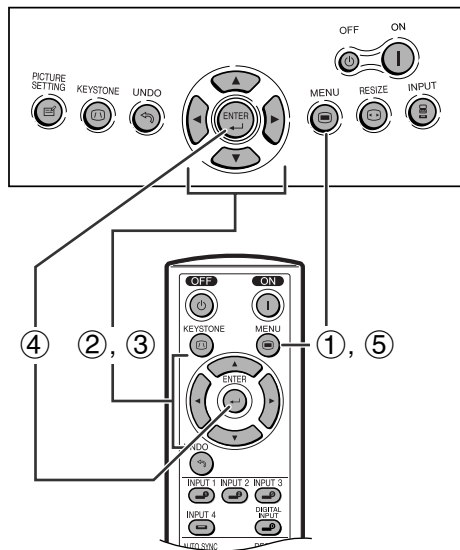
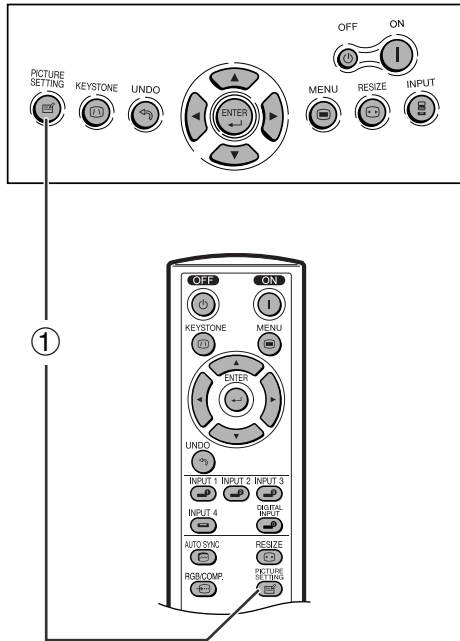

On-screen Display

Picture		INPUT2	
Contrast	0	-	+
Bright	0	-	+
Color	0	-	+
Tint	0	-	+
Sharp	0	-	+
Red	0	-	+
Blue	0	-	+
Reset		Memory 1	
CLR Temp		Memory 2	
Gamma		Memory 3	
White Emphasis		Memory 4	
Picture Setting		Memory 5	
		Memory OFF	

END SEL./ADJ. ENTER BACK

Picture Setting Function

This function stores all items set in "Picture". Five settings can be stored separately in "Memory 1" to "Memory 5". Each stored setting is reassigned to each input mode (INPUT 1 to INPUT 4 and DIGITAL). Even when the input mode or signal is changed, you can easily select optimal settings from the stored settings.

NOTE

- This function can be operated using the **PICTURE SETTING** button on the projector or on the remote control, as well as the OSD menu screen.

Description of Picture Setting

Selected item	Description
Memory 1-5	Settings of all items in "Picture" can be stored for the respective input modes. The stored settings can be selected in any input modes.
Memory OFF	Besides "Memory 1" to "Memory 5", other settings can be stored for each input mode. "Memory OFF" can be selected for each input mode.

Selecting "Memory 1-5" or "Memory OFF" Using the PICTURE SETTING Button

- Press **PICTURE SETTING**. Each time **PICTURE SETTING** is pressed, the memory number changes as shown below.

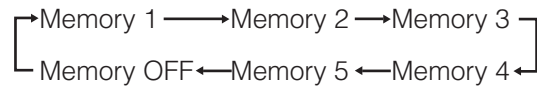

Storing the Adjustment Values for each Memory Number

- Press **MENU**. The "Picture" menu screen appears.
- Press **▲/▼** to select "Picture Setting", and then press **▶**.
- Press **▲/▼** to select the desired memory number for the picture settings.
- Press **ENTER** to save the settings. Adjust the settings described on pages 29 to 31. The values that are adjusted are stored.
- To exit the menu screen, press **MENU**.





Adjusting the Computer and DVD/DTV Images

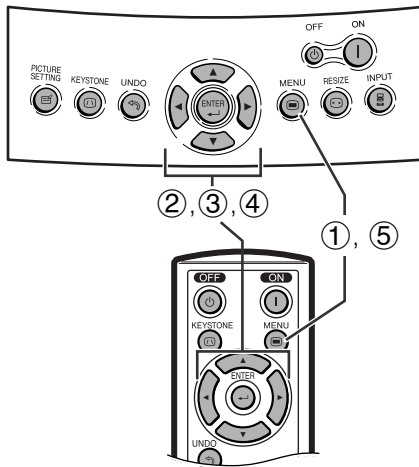

When displaying computer patterns which are very detailed (tiling, vertical stripes, etc.), interference may occur between the DMD pixels, causing flickering, vertical stripes, or contrast irregularities in portions of the screen. Should this occur, adjust "Clock", "Phase", "H-Pos" and "V-Pos" for the optimum computer image.

Description of Adjustment Items

Selected item	Description
Clock	Adjusts vertical noise.
Phase	Adjusts horizontal noise (similar to tracking on your VCR).
H-Pos	Centers the on-screen image by moving it to the left or right.
V-Pos	Centers the on-screen image by moving it up or down.
Reset	All computer image adjustment items are returned to the factory preset settings.

NOTE

- "Clock", "Phase", "H-Pos" and "V-Pos" cannot be used in the DIGITAL INPUT mode and the Component mode.
- Computer image adjustments can be made easily by pressing **AUTO SYNC** (📡) on the remote control. See page 35 for details.

On-screen Display

②

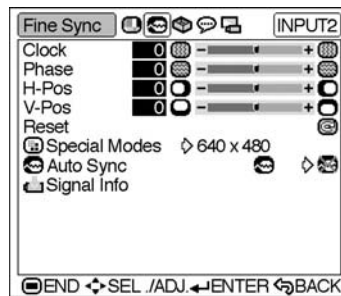

① Press **MENU**. The "Picture" menu screen appears.

② Press **◀/▶** to display the "Fine Sync" menu screen.

③ Press **▲/▼** to select a specific adjustment item.

④ Press **◀/▶** to move the **█** mark of the selected adjustment item to the desired setting.

⑤ To exit the menu screen, press **MENU**.

③

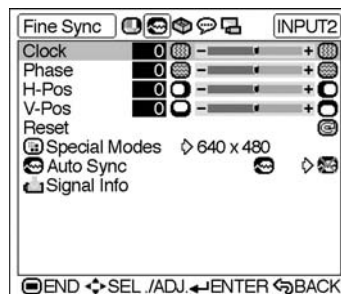

NOTE

- To reset all adjustment items, select "Reset" on the "Fine Sync" menu screen and press **ENTER**.
- The adjustable area of each item may be changed according to the input signal.

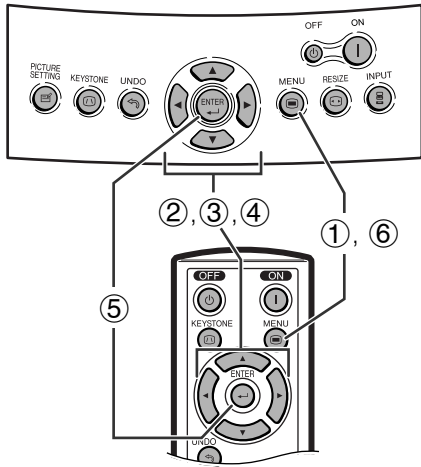

On-screen Display

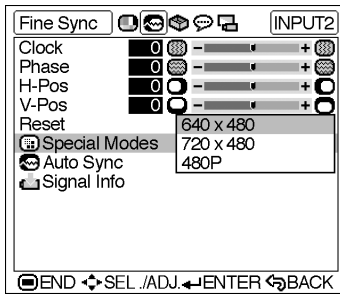

Special Modes Adjustment

Ordinarily, the type of input signal is detected and the correct resolution mode is automatically selected. However, for some signals, the optimal resolution mode in "Special Modes" on the "Fine Sync" menu screen may need to be selected to match the computer display mode.

- ① Press **MENU**. The "Picture" menu screen appears.
- ② Press ◀/▶ to display the "Fine Sync" menu screen.
- ③ Press ▲/▼ to select "Special Modes", and then press ▶.
- ④ Press ▲/▼ to select the optimal resolution.
- ⑤ Press **ENTER** to save the setting.
- ⑥ To exit the menu screen, press **MENU**.

NOTE

- Avoid displaying computer patterns which repeat every other line (horizontal stripes). (Flickering may occur, making the image hard to see.)
- When inputting DTV 1080i signal, select the corresponding type of signal in step 4 above.
- When inputting 720P RGB signal, select the corresponding type of signal in step 4 above.
- "Special modes" cannot be used in the DIGITAL INPUT mode.

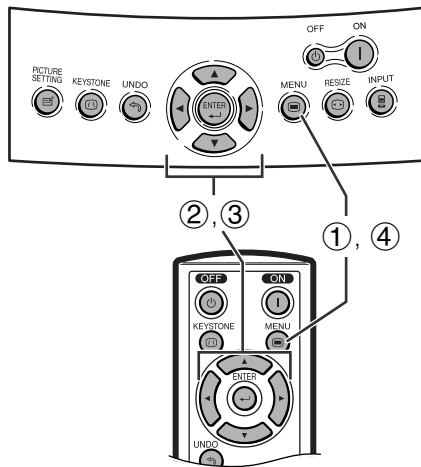

On-screen Display

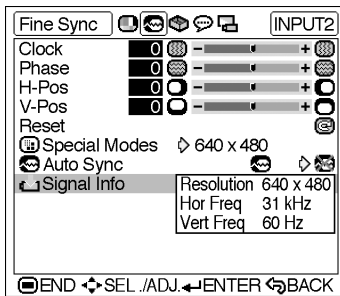

Checking the Input Signal

This function allows you to check the current input signal information.

- ① Press **MENU**. The "Picture" menu screen appears.
- ② Press ◀/▶ to display the "Fine Sync" menu screen.
- ③ Press ▲/▼ to select "Signal Info" to display the current input signal.
- ④ To exit the menu screen, press **MENU**.





Adjusting the Computer and DVD/DTV Images

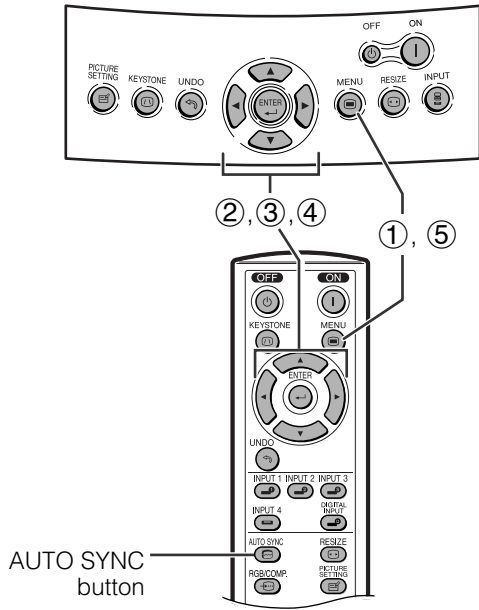

On-screen Display

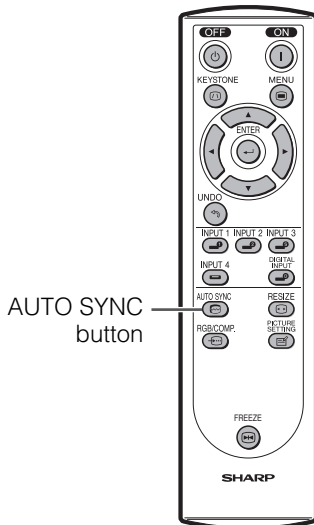
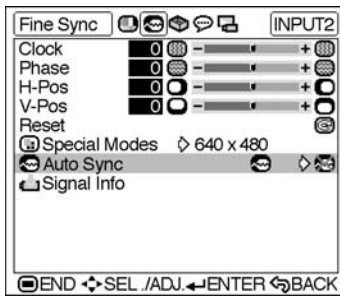

Auto Sync Adjustment

- Used to automatically adjust a computer image.
- Select whether the image is to be synchronized automatically when switching the signal with “ON” or “OFF”.

OFF (OFF icon)

- Synchronized adjustment is not automatically performed.
- Press **AUTO SYNC** to perform manual adjustment.

ON (ON icon)

- Synchronized adjustment is automatically performed.

- ① Press **MENU**. The “Picture” menu screen appears.
- ② Press **◀/▶** to display the “Fine Sync” menu screen.
- ③ Press **▲/▼** to select “Auto Sync”.
- ④ Press **◀/▶** to select “ON” or “OFF”.
- ⑤ To exit the menu screen, press **MENU**.

NOTE

- When the optimum image cannot be achieved with Auto Sync adjustment, use manual adjustments. (See page 33.)
- The Auto Sync adjustment may take some time to complete, depending on the image of the computer connected to the projector.
- “Auto Sync” cannot be used in the DIGITAL INPUT mode.

Auto Sync Adjustment Using the Remote Control

- ① Press **AUTO SYNC** button on the Remote Control. Synchronized adjustment starts.



Turning On/Off the On-screen Display

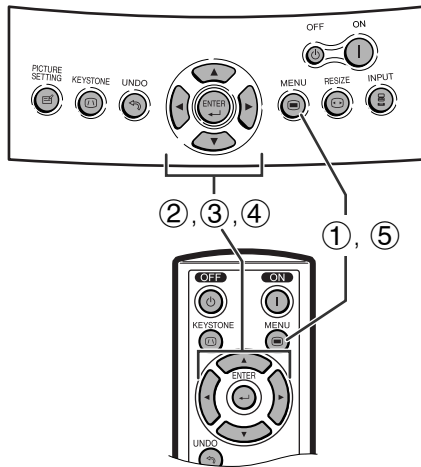

On-screen Display

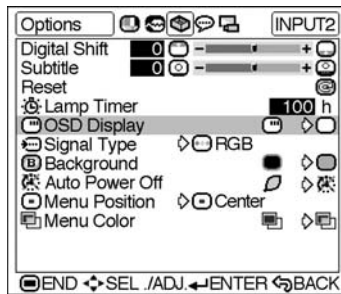

This function allows you to turn on or off the on-screen messages that appear during input select.

Description of OSD Display

Selected item	Description
ON (☑)	All On-screen Display are displayed.
OFF (☐)	INPUT is not displayed.

- ① Press **MENU**. The "Picture" menu screen appears.
- ② Press ◀/▶ to display the "Options" menu screen.
- ③ Press ▲/▼ to select "OSD Display".
- ④ Press ◀/▶ to select "ON" (☑) or "OFF" (☐).
- ⑤ To exit the menu screen, press **MENU**.



Selecting the Signal Type

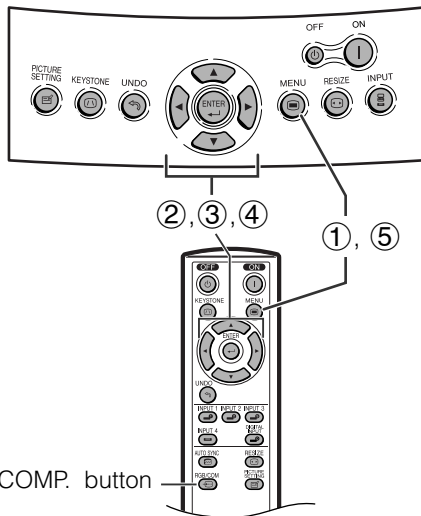

RGB/COMP. button

On-screen Display

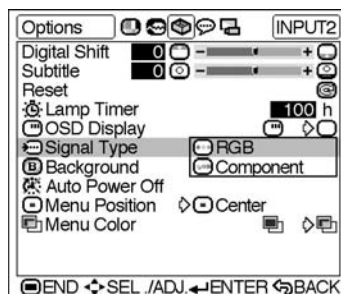

This function allows you to select the input signal type Component or RGB for INPUT 2.

- ① Press **MENU**. The "Picture" menu screen appears.
- ② Press ◀/▶ to display the "Options" menu screen.
- ③ Press ▲/▼ to select "Signal Type", and then press ▶.
- ④ Press ▲/▼ to select "RGB" or "Component".
- ⑤ To exit the menu screen, press **MENU**.

"RGB" or "Component" can be selected with the **RGB/COMP.** button on the remote control only in INPUT 2.





Setting the Video Signal (VIDEO menu only)

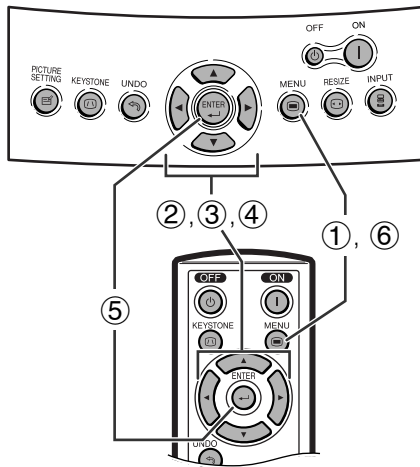

On-screen Display

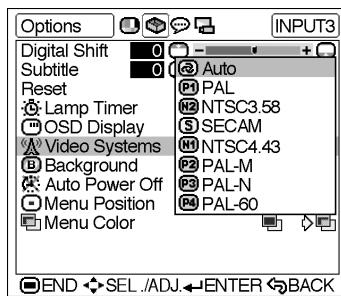

The video input system mode is preset to “Auto”; however, it can be changed to a specific system mode if the selected system mode is not compatible with the connected audiovisual equipment.

- ① Press **MENU**. The “Picture” menu screen appears.
- ② Press ◀/▶ to display the “Options” menu screen.
- ③ Press ▲/▼ to select “Video Systems”, and then press ▶.
- ④ Press ▲/▼ to select the desired video system mode.
- ⑤ Press **ENTER** to save the setting.
- ⑥ To exit the menu screen, press **MENU**.

NOTE

- When the system mode is set to “Auto”, you may not receive a clear picture due to signal differences. Should this occur, switch to the video system of the source signal.
- “Auto” cannot be set for PAL-M and PAL-N input signals. Select “PAL-M” or “PAL-N” in “Video Systems” menu for PAL-M and PAL-N input signals.



Selecting a Background Image

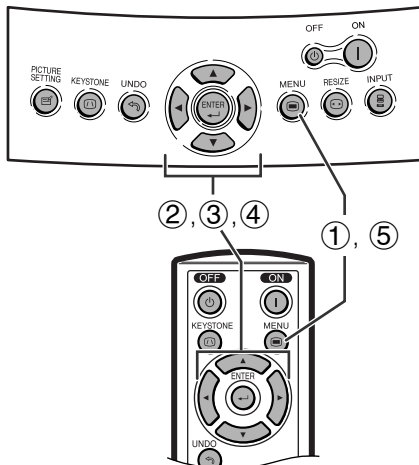

On-screen Display

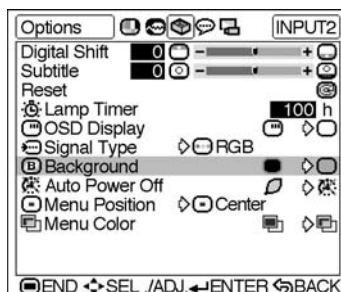

This function allows you to select the image displayed when no signal is being sent to the projector.

Description of Background Images

Selected item	Description
Blue (□)	Blue screen
None (■)	Black screen

- ① Press **MENU**. The “Picture” menu screen appears.
- ② Press ◀/▶ to display the “Options” menu screen.
- ③ Press ▲/▼ to select “Background”.
- ④ Press ◀/▶ to select the background image you want to display on the screen.
- ⑤ To exit the menu screen, press **MENU**.



Adjustments for the Screen Position and Size

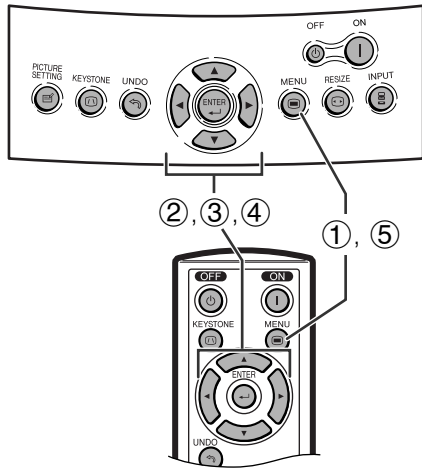

On-screen Display

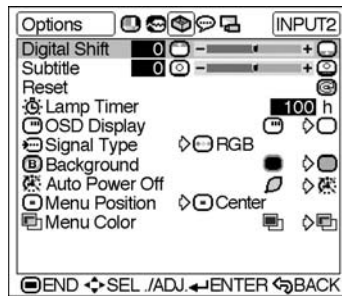

You can adjust settings according to the position and size of the screen.

Description of Adjustment Items

Selected item	Description
Digital Shift	Adjusts the vertical position of the image.
Subtitle	Adjusts the vertical size of the image.
Reset	Digital Shift and Subtitle adjustments are returned to the factory preset settings.

Digital Shift Setting

This function allows you to adjust the vertical position of the image.

Description of Digital Shift

- [Slider] +	
◀ button	▶ button
The image moves down.	The image moves up.

- ① Press **MENU**. The "Picture" menu screen appears.
- ② Press ◀/▶ to display the "Options" menu screen.
- ③ Press ▲/▼ to select "Digital Shift".
- ④ Press ◀/▶ to move the ▣ mark of the Digital Shift setting.
- ⑤ To exit the menu screen, press **MENU**.

NOTE

- The "Digital Shift" cannot be adjusted when Keystone correction is applied.





Adjustments for the Screen Position and Size

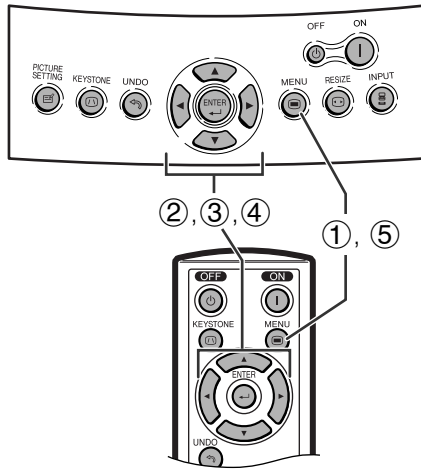

On-screen Display

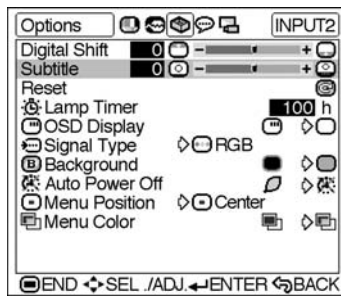

Subtitle Setting

With this function, you can adjust the vertical size of the display to allow for subtitles.

Description of Subtitle Setting

<p>The image is compressed by adjusting the vertical size of the display.</p>	<p>The image is enlarged by adjusting the vertical size of the display.</p>

- ① Press **MENU**. The "Picture" menu screen appears.
- ② Press ◀/▶ to display the "Options" menu screen.
- ③ Press ▲/▼ to select "Subtitle".
- ④ Press ◀/▶ to move the ▾ mark of the Subtitle setting.
- ⑤ To exit the menu screen, press **MENU**.

NOTE

- When changing the screen with the Subtitle setting, not only the bottom of the screen rises, but also the upper part is changed to a certain point.
- The subtitle setting can be adjusted more effectively with the Digital Shift function.
- The "Subtitle" cannot be adjusted when Keystone correction is applied.





Selecting the Menu Screen Position

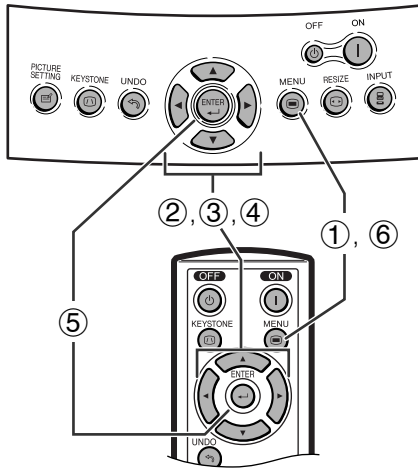

On-screen Display

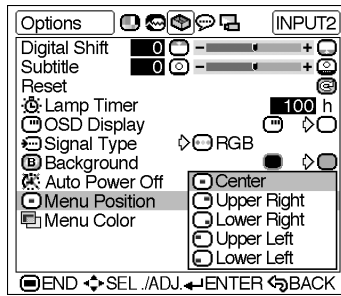

This function allows you to select the desired position of the menu screen.

Description of Menu Position

Selected item	Description
Center	The menu is displayed on the center of the image.
Upper Right	The menu is displayed on the upper right of the image.
Lower Right	The menu is displayed on the lower right of the image.
Upper Left	The menu is displayed on the upper left of the image.
Lower Left	The menu is displayed on the lower left of the image.

- ① Press **MENU**. The "Picture" menu screen appears.
- ② Press ◀/▶ to display the "Options" menu screen.
- ③ Press ▲/▼ to select "Menu Position", and then press ▶.
- ④ Press ▲/▼ to select the desired menu position.
- ⑤ Press **ENTER** to save the setting.
- ⑥ To exit the menu screen, press **MENU**.



Selecting the Menu Color

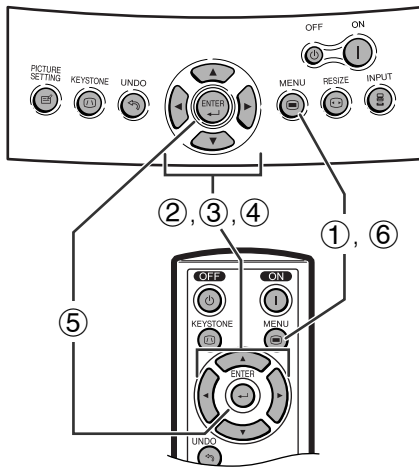

On-screen Display

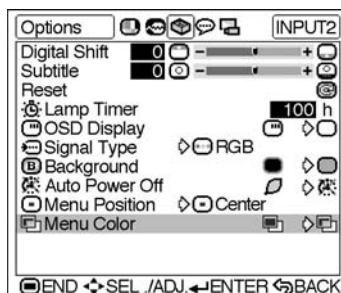

This function allows you to select the color of the menu screen.

Description of Menu color

Selected item	Description
Opaque	The menu is displayed opaquely.
Translucent	The menu is displayed translucently. The part of the menu on the image becomes transparent.

- ① Press **MENU**. The "Picture" menu screen appears.
- ② Press ◀/▶ to display the "Options" menu screen.
- ③ Press ▲/▼ to select "Menu Color".
- ④ Press ◀/▶ to select "Opaque" or "Translucent" .
- ⑤ To exit the menu screen, press **MENU**.





Automatic Power Shut-off Function

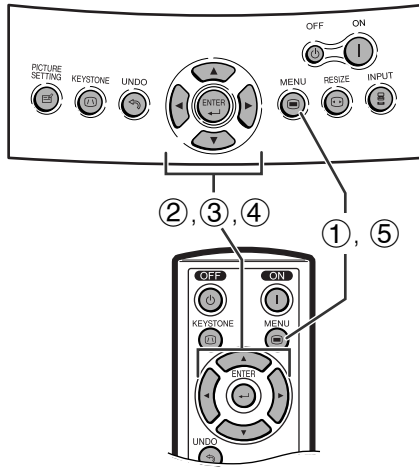

When no input signal is detected for more than 15 minutes, the projector will automatically shut off. The on-screen message on the left will appear five minutes before the power is automatically turned off.

Description of Automatic Power Shut-off

Selected item	Description
	Power automatically shuts off after 15 minutes without an input signal.
	Automatic Power Shut-off disabled.

- ① Press **MENU**. The “Picture” menu screen appears.
- ② Press ◀/▶ to display the “Options” menu screen.
- ③ Press ▲/▼ to select “Auto Power Off”.
- ④ Press ◀/▶ to select “” or “”.
- ⑤ To exit the menu screen, press **MENU**.



NOTE

- “Auto Power Off” is factory preset to “”.
- When the Auto Power Off function is set to “ (On)”, 5 minutes before the power turns off, the message “Power OFF in X min.” will appear on the screen to indicate the remaining minutes.

On-screen Display

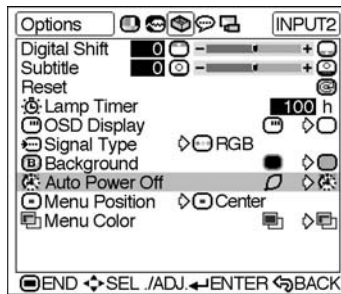



Reversing/Inverting Projected Images

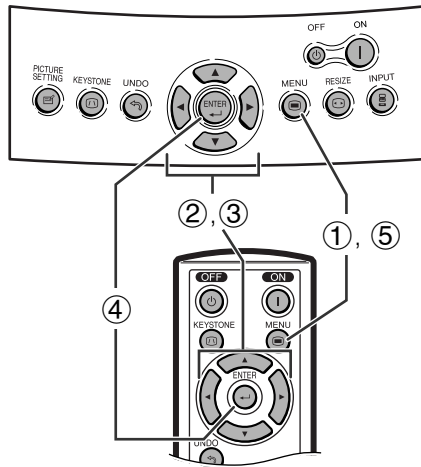

On-screen Display

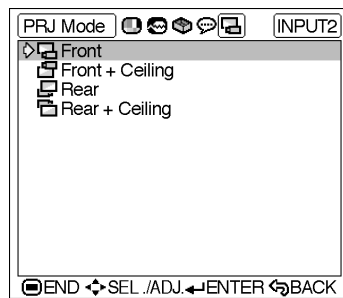

This projector is equipped with a reverse/invert image function which allows you to reverse or invert the projected image for various applications.

Description of Projected Images

Selected item	Description
Front	Normal image
Front + Ceiling	Inverted image
Rear	Reversed image
Rear + Ceiling	Reversed and inverted image

- ① Press **MENU**. The “Picture” menu screen appears.
- ② Press ◀/▶ to display the “PRJ Mode” menu screen.
- ③ Press ▲/▼ to select the desired projection mode.
- ④ Press **ENTER** to save the setting.
- ⑤ To exit the menu screen, press **MENU**.

NOTE

- This function is used for the reversed image and ceiling-mount setups. See page 23 for these setups.



Selecting the On-screen Display Language

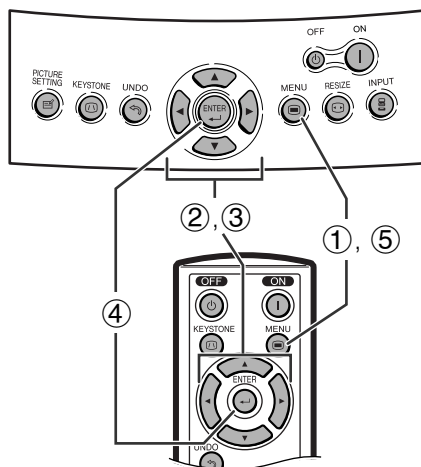

On-screen Display



English is the preset language for the On-screen Display; however, this can be changed to German, Spanish, Dutch, French, Italian, Swedish, Portuguese, Chinese, Korean or Japanese.

- ① Press **MENU**. The “Picture” menu screen appears.
- ② Press ◀/▶ to display the “Language” menu screen.
- ③ Press ▲/▼ to select the desired language.
- ④ Press **ENTER** to save the setting. The On-screen Display is now programmed to display in the language selected.
- ⑤ To exit the menu screen, press **MENU**.





Lamp/Maintenance Indicators

Maintenance Indicators

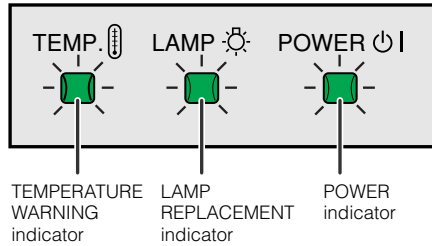

- The warning lights on the projector indicate problems inside the projector.
- There are two types of warning lights: a TEMPERATURE WARNING indicator that warns you when the projector is too hot, and a LAMP REPLACEMENT indicator that warns you when to change the lamp.
- If a problem occurs, either the TEMPERATURE WARNING indicator or the LAMP REPLACEMENT indicator will illuminate in red. After turning off the power, follow the procedures given below.

Maintenance Indicator	Condition	Problem	Possible Solution
TEMPERATURE WARNING indicator	The internal temperature is abnormally high.	• Blocked air intake.	• Relocate the projector to an area with proper ventilation.
		• Clogged ventilative hole.	• Clean the ventilative holes. (See page 48.)
		• Cooling fan breakdown. • Internal circuit failure.	• Take the projector to your nearest Sharp Authorized Service Center or Dealer for repair.
LAMP REPLACEMENT indicator	The lamp does not light up.	• Burnt-out lamp. • Lamp circuit failure.	• Carefully replace the lamp. (See page 45.) • Take the projector to your nearest Sharp Authorized Service Center or Dealer for repair.
	The lamp requires replacement.	• Lamp has been used for over 2,400 hours.	

NOTE

- If the TEMPERATURE WARNING indicator lights up, follow the above possible solutions and then wait until the projector has cooled down completely before turning the power back on. (At least 5 minutes.)
- If the power is turned off and then turned on again, for example during a brief rest, the LAMP REPLACEMENT indicator may be triggered, preventing the power from going on. Should this occur, unplug the power cord from the wall outlet and plug it back in again.





Lamp Maintenance



Confirming the Lamp Usage Time

The lamp in this projector operates for approximately 2,500 cumulative hours, depending on the usage environment. (As the usage environment can vary significantly, the projector lamp may not operate for 2,500 hours.) It is recommended that the lamp be replaced after approximately 2,400 cumulative hours of use or when you notice a significant deterioration of the picture and color quality. The lamp usage time can be checked with the On-screen Display.

CAUTION

- Intense light hazard. Do not attempt to look into the aperture and lens while the projector is operating.

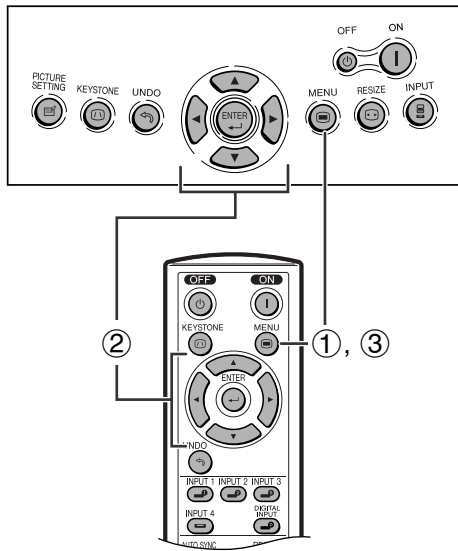

This function allows you to check the accumulated lamp usage time.

- ① Press **MENU**. The "Picture" menu screen appears.
- ② Press **◀/▶** to display the "Options" menu screen. The lamp usage time will be displayed in "Lamp Timer".
- ③ To exit the menu screen, press **MENU**.

NOTE

- It is recommended that the lamp be replaced after approximately 2,400 cumulative hours of use. See page 45 for lamp replacement.

On-screen Display

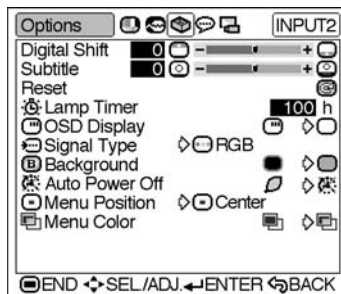

Condition	Problem	Possible Solution
The LAMP REPLACEMENT indicator illuminates in red, and "LAMP" and "■" will blink in yellow in the lower-left corner of the image.	<ul style="list-style-type: none"> • Lamp has been used for over 2,400 hours. 	<ul style="list-style-type: none"> • Purchase a replacement lamp unit (lamp/cage module) of the current type BQC-XVZ90+++1 from your nearest Sharp Authorized Service Center or Dealer. • Replace the lamp. (See page 45.) If you wish, you may have the lamp replaced at your nearest Sharp Authorized Service Center or Dealer.
A significant deterioration of the picture and color quality occurs.		
The power will automatically turn off and the projector will enter standby mode.	<ul style="list-style-type: none"> • Lamp has been used for over 2,500 hours. 	
"LAMP" and "■" will blink in red in the lower-left corner of the image, and the power will turn off.		





Replacing the Lamp

CAUTION

- **There is potential glass particles hazard if the lamp ruptures. In case of lamp rupture, contact your nearest Sharp Authorized Service Center or Dealer for replacement.**
- **Do not remove the lamp cage directly after operation of the projector. The lamp may be extremely hot. Wait at least one hour after the power cord is disconnected to allow the surface of the lamp cage to fully cool down before removing the lamp cage.**

It is recommended that the lamp be replaced after approximately 2,400 cumulative hours of use or when you notice a significant deterioration of the picture and color quality. Carefully change the lamp by following the steps on the next page.

If the new lamp does not light after replacement, take your projector to the nearest Sharp Authorized Service Center or Dealer for repair. Purchase a replacement lamp unit (lamp/cage module) of the current type BQC-XVZ90+++1 from your nearest Sharp Authorized Service Center or Dealer. Then carefully change the lamp by following the instructions on the next page. If you wish, you may have the lamp replaced at your nearest Sharp Authorized Service Center.

IMPORTANT NOTE TO U.S. CUSTOMERS:

The lamp included with this projector is backed by a 90-day parts and labor limited warranty. All service of this projector under warranty, including lamp replacement, must be obtained through a Sharp Authorized Service Center or Dealer. For the name of the nearest Sharp Authorized Service Center or Dealer, please call toll-free: 1-800-BE-SHARP (1-800-237-4277).

U.S.A. ONLY





Replacing the Lamp

Removing and installing the lamp unit

CAUTION

- Be sure to remove the lamp cage by the handle. Do not touch the glass surface of the lamp cage or the inside of the projector.
- To avoid injury to yourself and damage to the lamp, carefully follow the steps below.
- Replace the lamp after turning off the power and unplugging the power cord.

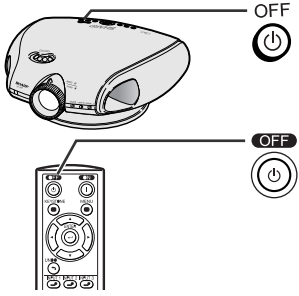
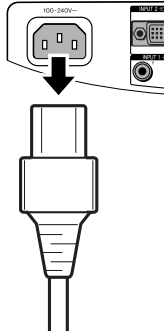
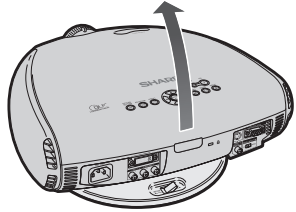
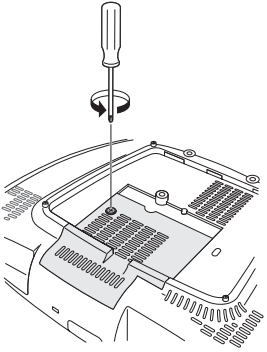
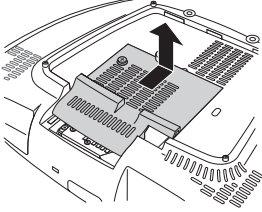
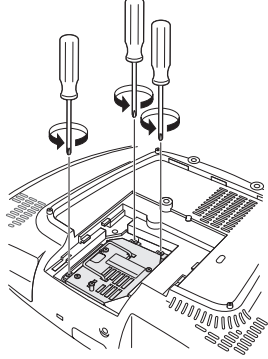
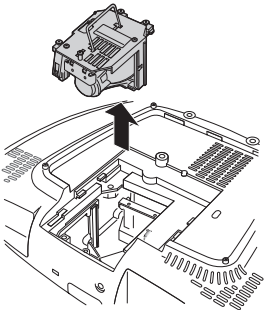
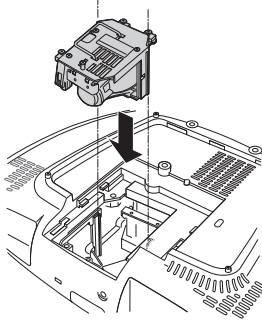
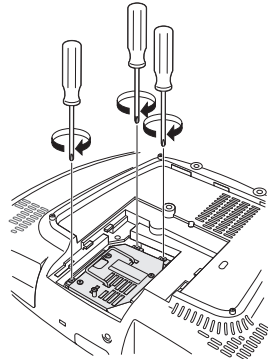
<p>1 Turn off the power.</p> <p>Press POWER OFF. Wait until the cooling fan stops running.</p> 	<p>2 Unplug the power cord.</p> 	<p>3 Remove the Swivel Stand. (See page 17.)</p> 
<p>4 Loosen the user service screw that secures the lamp cage cover.</p> 	<p>5 Slide the lamp cage cover in the direction of the arrow.</p> 	<p>6 Loosen and remove the three-securing screws from the lamp cage.</p>  <p style="text-align: right;">User service screws</p>
<p>7 Remove the lamp cage.</p> 	<p>8 Insert the new lamp cage firmly into the lamp cage compartment.</p> 	<p>9 Tighten the three-securing screws to fasten the lamp cage.</p> 





Replacing the Lamp

10 Attach the lamp unit cover.

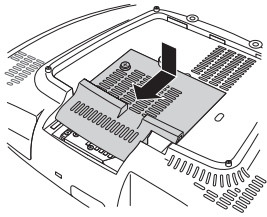

11 Tighten the user service screw to fasten the lamp cage cover.

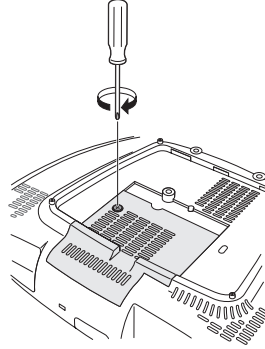

12 Plug the power cord.

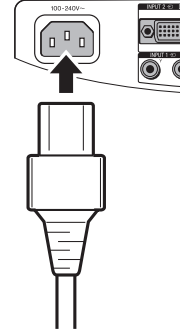

13 Press POWER ON on the projector to reset the lamp timer.

Press **ON**, **INPUT**, **UNDO**, **ENTER** and **ENTER** in order. Then press **ON**.

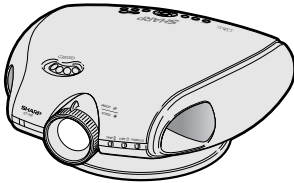

"LAMP 0000H" is displayed on the screen.

NOTE

- You need to reset the lamp timer every time you replace the lamp and confirm it is reset on the "Lamp Timer" menu.





Cleaning the Ventilative Holes

- This projector is equipped with ventilative holes to ensure the optimal operating condition of the projector.
- Periodically clean the ventilative hole by vacuuming it off with a vacuum cleaner.
- The ventilative holes should be cleaned every 100 hours of use. Clean the ventilative holes more often when the projector is used in a dirty or smoky location.

Side and Rear view

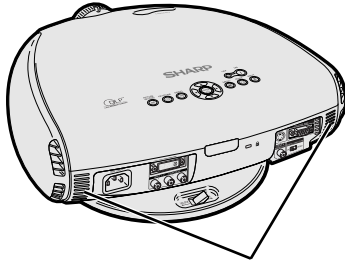

Intake ventilative holes

Bottom view

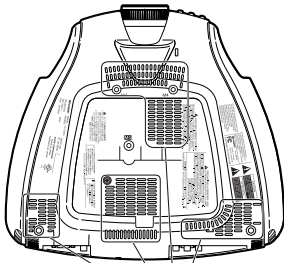

Intake ventilative holes

Swivel stand

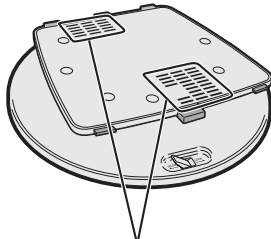

Intake ventilative holes

How to clean the ventilative holes

1 Unplug the power cord.

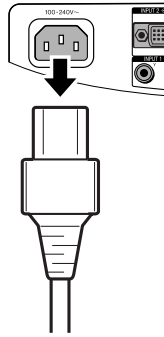

2 Cleaning.

Clean the dust off by putting the cleaner hose on the intake ventilative holes.

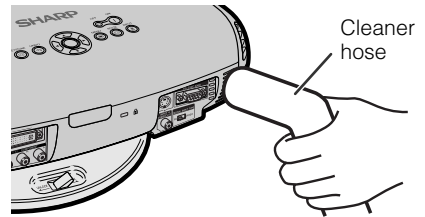



Using the Kensington Lock

Rear View

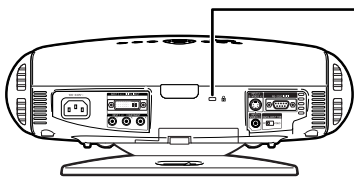

Kensington Security Standard connector

This projector has a Kensington Security Standard connector for use with a Kensington MicroSaver Security System. Refer to the information that came with the system for instructions on how to use it to secure the projector.



Troubleshooting

Problem	Check
No picture appears.	<ul style="list-style-type: none"> • Projector power cord is not plugged into the wall outlet. • Selected input is wrong. (See page 24.) • Cables incorrectly connected to back panel of the projector. (See pages 12–15.) • “Contrast” and “Bright” adjustments are set to minimum position.
Color is faded or poor.	<ul style="list-style-type: none"> • Picture adjustments are not correct.
Picture is blurred.	<ul style="list-style-type: none"> • Adjust the focus. (See page 16.) • Projection distance is too long or too short to allow for proper focus. (See pages 21 and 22.)
No OSD appears.	<ul style="list-style-type: none"> • OSD Display is set to “OFF”, preventing to display some or all On-screen Displays. (See page 36.)
An unusual sound is occasionally heard from the cabinet.	<ul style="list-style-type: none"> • If the picture is normal, the sound is due to cabinet shrinkage caused by temperature changes. This will not affect operation or performance of the projector.
Maintenance indicator illuminates.	<ul style="list-style-type: none"> • Refer to “Lamp/Maintenance Indicators” on page 43.
Picture noise appears.	<ul style="list-style-type: none"> • Adjust the “Phase” setting. (See page 33.)
Image is green on INPUT 2 Component. Image is pink (no green) on INPUT 2 RGB.	<ul style="list-style-type: none"> • Change the input signal type. (See page 36.)



Service Information (For the U.S.)

For the location of the nearest Sharp Authorized Service Center, or to obtain product literature, accessories, supplies or customer assistance, please call 1-800-BE-SHARP (1-800-237-4277) or visit SHARP's website (<http://www.sharpusa.com>).





Connecting Pin Assignments

DVI-I (INPUT 2 / DIGITAL INPUT) port : 29 pin connector

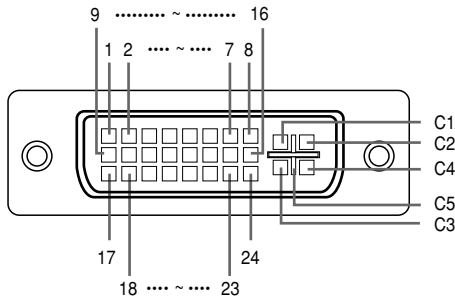

• DVI Digital INPUT

Pin No.	Signal	Pin No.	Signal
1	T.M.D.S data 2-	16	Hot plug detection
2	T.M.D.S data 2+	17	T.M.D.S data 0-
3	T.M.D.S data 2 shield	18	T.M.D.S data 0+
4	Not connected	19	T.M.D.S data 0 shield
5	Not connected	20	Not connected
6	DDC clock	21	Not connected
7	DDC data	22	T.M.D.S clock shield
8	Not connected	23	T.M.D.S clock+
9	T.M.D.S data 1-	24	T.M.D.S clock-
10	T.M.D.S data 1+	C1	Not connected
11	T.M.D.S data 1 shield	C2	Not connected
12	Not connected	C3	Not connected
13	Not connected	C4	Not connected
14	+5V power	C5	Ground
15	Ground		

• DVI Analog RGB Input

Pin No.	Signal	Pin No.	Signal
1	Not connected	16	Hot plug detection
2	Not connected	17	Not connected
3	Not connected	18	Not connected
4	Not connected	19	Not connected
5	Not connected	20	Not connected
6	DDC clock	21	Not connected
7	DDC data	22	Not connected
8	Vertical sync	23	Not connected
9	Not connected	24	Not connected
10	Not connected	C1	Analog input Red
11	Not connected	C2	Analog input Green
12	Not connected	C3	Analog input Blue
13	Not connected	C4	Horizontal sync
14	+5V power	C5	Ground
15	Ground		

• DVI Analog Component Input

Pin No.	Signal	Pin No.	Signal
1	Not connected	16	Not connected
2	Not connected	17	Not connected
3	Not connected	18	Not connected
4	Not connected	19	Not connected
5	Not connected	20	Not connected
6	Not connected	21	Not connected
7	Not connected	22	Not connected
8	Not connected	23	Not connected
9	Not connected	24	Not connected
10	Not connected	C1	Analog input Pr/Cr
11	Not connected	C2	Analog input Y
12	Not connected	C3	Analog input Pb/Cb
13	Not connected	C4	Not connected
14	Not connected	C5	Ground
15	Ground		





Computer Compatibility Chart

Horizontal Frequency: 15–70 kHz
 Vertical Frequency: 43–75 Hz
 Pixel Clock: 12–110 MHz
 Compatible with sync on green
 XGA compatible in intelligent compression

PC/ MAC/ WS	Resolution	Horizontal Frequency (kHz)	Vertical Frequency (Hz)	VESA Standard	DVI Support	Display
PC	640 × 350	27.0	60			Upscale
		31.5	70			
	720 × 350	27.0	60			
		31.5	70			
	640 × 400	27.0	60			
		31.5	70			
	720 × 400	27.0	60			
		31.5	70			
	640 × 480	26.2	50			
		31.5	60	✓	✓	
		34.7	70			
		37.9	72	✓	✓	
	800 × 600	37.5	75	✓	✓	
		31.4	50			True
		35.1	56	✓	✓	
		37.9	60	✓	✓	
		44.5	70			
	48.1	72	✓	✓		
1,024 × 768	46.9	75	✓	✓		
	35.5	43	✓		Intelligent Compression	
	40.3	50				
	56.5	70	✓			
58.1	72					
—	1,280 × 720	45.0	60			
PC/ MAC 13"	VGA	640 × 480	34.9	67		Upscale
MAC 16"	SVGA	832 × 624	46.8	75		Intelligent Compression
			49.6	75		
PC/ MAC 19"	XGA	1,024 × 768	48.4	60	✓	Intelligent Compression
			60.0	75	✓	

NOTE

- This projector may not be able to display images from notebook computers in simultaneous (CRT/LCD) mode. Should this occur, turn off the LCD display on the notebook computer and output the display data in "CRT only" mode. Details on how to change display modes can be found in your notebook computer's operation manual.





Dimensions

Rear View

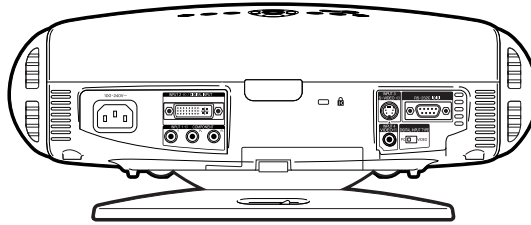

Side View

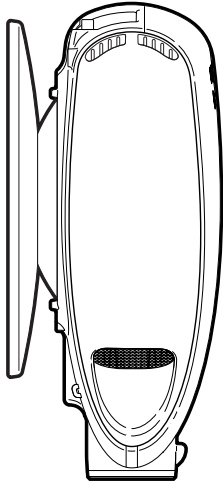

Top View

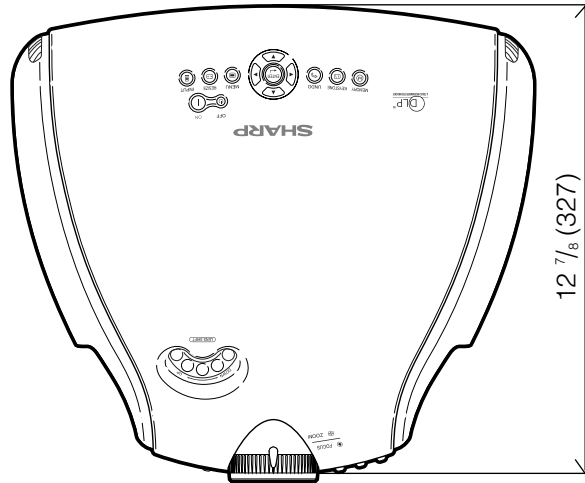

Side View

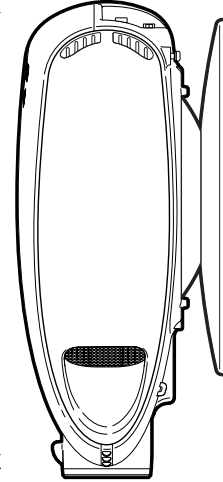

Front View

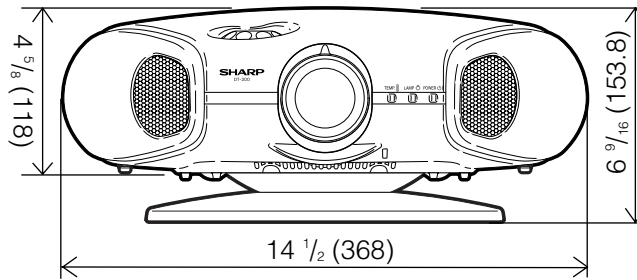

Bottom View

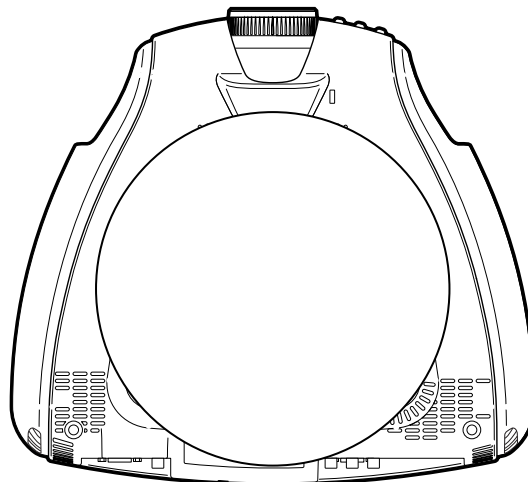

Units: inches (mm)





Specifications

Product type	Projector
Model	DT-200
Video system	PAL/PAL 60/PAL-M/PAL-N/SECAM/NTSC 3.58/NTSC 4.43 DTV 480i/480P/720P/1080i
Display method	DLP chip, RGB optical shutter method
DLP panel	Panel size: 0.55" Display method: Single Panel Digital Micromirror Device (DMD™) by Texas Instruments Drive method: Digital Light Processing (DLP™) No. of dots: 480,000 dots (800 [H] × 600 [V])
Lens	1–1.2 × zoom lens, F3.0, f=32.5–44.0 mm
Projection lamp	150 W SHP lamp
Video input signal	RCA Connector: VIDEO (INPUT 4), composite video, 1.0 Vp-p, sync negative, 75 Ω terminated
S-video input signal	4-pin Mini DIN connector (INPUT 3) Y (luminance signal): 1.0 Vp-p, sync negative, 75 Ω terminated C (chrominance signal): Burst 0.286 Vp-p, 75 Ω terminated
Component input signal (INPUT 1)	RCA Connector Y: 1.0 Vp-p, sync negative, 75 Ω terminated PB: 0.7 Vp-p, 75 Ω terminated PR: 0.7 Vp-p, 75 Ω terminated
Component input signal (INPUT 2)	29-pin connector DVI input signal: Digital 250–1,000 mV 50 Ω Analog 0.7 Vp-p 75 Ω Y: 1.0 Vp-p, sync negative, 75 Ω terminated PB: 0.7 Vp-p, 75 Ω terminated PR: 0.7 Vp-p, 75 Ω terminated
Component RGB input signal (INPUT 2)	29-pin connector RGB separate/sync on green type analog input: 0–0.7 Vp-p, positive, 75 Ω terminated HORIZONTAL SYNC. SIGNAL: TTL level (positive/negative) VERTICAL SYNC. SIGNAL: Same as above
Horizontal resolution	520 TV lines (NTSC 3.58 input)
RGB input signal	15-PIN MINI D-SUB CONNECTOR (INPUT 2): RGB separate/composite sync/sync on green type analog input: 0–0.7 Vp-p, positive, 75 Ω terminated HORIZONTAL SYNC. SIGNAL: TTL level (positive/negative) or composite sync (Apple only) VERTICAL SYNC. SIGNAL: Same as above
Pixel clock	12–110 MHz
Vertical frequency	43–75 Hz
Horizontal frequency	15–70 kHz
Rated voltage	AC 100–240 V
Input current	2.1 A
Rated frequency	50/60 Hz
Power consumption	200 W
Heat dissipation	750 BTU/hour
Operating temperature	41°F to 95°F (+5°C to +35°C)
Storage temperature	–4°F to 140°F (–20°C to +60°C)
Cabinet	Plastic
I/R carrier frequency	38 kHz
Dimensions (approx.)	14½" (W) × 6¾" (H) × 12⅞" (D) (368 × 153.8 × 327 mm) (including swivel stand) 14½" (W) × 4⅝" (H) × 12⅞" (D) (368 × 118 × 327 mm) (main body only)
Weight (approx.)	9.5 lbs. (4.3 kg) (including swivel stand) 8.4 lbs. (3.8kg) (main body only)
Supplied accessories	Remote control, Two AA size batteries, Power cord, Video cable, Lens cap (attached on the body), Lens cap strap, Operation manual
Replacement parts	Lamp unit (Lamp/cage module) (BQC-XVZ90+++1), Remote control (RRMCGA088WJSA), AA size batteries, Power cord (QACCGA007WJPZ), Video cable (QCNWGA001WJZZ), Lens cap (CCAPHA004WJ01), Lens cap strap (UBNDT0013CEZZ), Operation manual (TINS-A287WJZZⒶ)

This SHARP projector uses a DMD chip. This very sophisticated chip contains 480,000 pixels. As with any high technology electronic equipment such as large screen TVs, video systems and video cameras, there are certain acceptable tolerances that the equipment must conform to.

This unit has some inactive pixels within acceptable tolerances which may result in inactive dots on the picture screen. This will not affect the picture quality or the life expectancy of the unit. If you have any questions about this matter, please call toll free 1-800-BE-SHARP (1-800-237-4277). U.S.A. ONLY

Specifications are subject to change without notice.





Glossary

Aspect ratio

Width and height ratio of an image. The normal aspect ratio of a computer and video image is 4 : 3. There are also wide images with an aspect ratio of 16 : 9 and 21 : 9.

Auto Sync

Optimizes projected computer images by automatically adjusting certain characteristics.

Background

Initial setting image projected when no signal is being input.

Clock

Clock adjustment is used to adjust vertical noise when clock level is incorrect.

CLR Temp (Color temperature)

Function that can be used to adjust the color temperature to suit the type of image input to the projector. Decrease the color temperature to create warmer, reddish images for natural flesh tones, or increase to create cooler, bluish images for a brighter picture.

Composite sync

Signal combining horizontal and vertical sync pulses.

Digital keystone correction

Function to digitally correct a distorted image when the projector is set up at an angle, smoothes out jaggies on keystone images and compresses the image not only horizontally but vertically keeping the 4 : 3 aspect ratio.

Digital shift

Shifts image up or down easily by ▲/▼ buttons when RESIZE mode of input image is NORMAL, BORDER, or STRETCH of COMPUTER, VIDEO and DTV inputs.

DVI (Digital Visual Interface)

Display digital interface that also supports Analog interfaces.

GAMMA

Image quality enhancement function that offers a richer image by brightening the darker portions of the image without altering the brightness of the brighter portions. You can select from four different modes: Standard, Black Detail, White Detail and Brighten.

HDCP

Digital entertainment content is protected from copying with the HDCP system.

Intelligent compression and expansion

High quality resizing of lower and higher resolution images to fit the projector's native resolution.

Phase

Phase shift is a timing shift between isomorphic signals with the same resolution. When phase level is incorrect, the projected image typically displays horizontal flicker.

RESIZE

Allows you to modify or customize the picture display mode to enhance the input image. You can select from four different modes: NORMAL, FULL, BORDER and STRETCH.

Stretch

Mode that stretches the 4:3 image horizontally to display it on the wide screen.

Sync on green

Video signal mode of a computer which overlaps horizontal and vertical sync signal to green color signal pin.





Index

A	
AC socket	12
ADJUSTMENT buttons	26
Adjusting the Picture	29
Aspect ratio	24
Automatic power shut-off function	41
Auto sync adjustment	35
AUTO SYNC button	35
B	
Background	37
C	
Ceiling-mount	22
Clock	33
COMPONENT terminals	13
D	
Digital shift	38
DVI	14
E	
ENTER button	26
Exhaust ventilative hole	4
F	
Focus ring	16
FREEZE button	25
H	
HDCP	7
I	
INPUT buttons	24
K	
Kensington Lock	49
KEystone button	19
L	
LAMP REPLACEMENT indicator	43
Lens shift	18
M	
MENU button	26
O	
On-screen display	36
On-screen display Language	42
P	
Phase	33
POWER buttons	16
Power cord	12
POWER indicator	43
R	
Rear+Ceiling	42
Rear projection	23
Remote control	10
Remote control sensor	15
Remote control signal transmitter	10
RESIZE button	24
INPUT 2 DVI digital port	13
S	
STRETCH	24
Subtitle	39
S-VIDEO INPUT terminal	12
Sync	35
Sync on green	51
T	
TEMPERATURE WARNING indicator	43
U	
UNDO button	26
V	
VIDEO INPUT terminal	12
Video Systems	37
Z	
Zoom knob	16



CONSUMER LIMITED WARRANTY

SHARP ELECTRONICS CORPORATION warrants to the first consumer purchaser that this Sharp brand product (the "Product"), when shipped in its original container, will be free from defective workmanship and materials, and agrees that it will, at its option, either repair the defect or replace the defective Product or part thereof with a new or remanufactured equivalent at no charge to the purchaser for parts or labor for the period(s) set forth below.

This warranty does not apply to any appearance items of the Product nor to the additional excluded item(s) set forth below nor to any Product the exterior of which has been damaged or defaced, which has been subjected to improper voltage or other misuse, abnormal service or handling, or which has been altered or modified in design or construction.

In order to enforce the rights under this limited warranty, the purchaser should follow the steps set forth below and provide proof of purchase to the servicer.

The limited warranty described herein is in addition to whatever implied warranties may be granted to purchasers by law. ALL IMPLIED WARRANTIES INCLUDING THE WARRANTIES OF MERCHANTABILITY AND FITNESS FOR USE ARE LIMITED TO THE PERIOD(S) FROM THE DATE OF PURCHASE SET FORTH BELOW. Some states do not allow limitations on how long an implied warranty lasts, so the above limitation may not apply to you.

Neither the sales personnel of the seller nor any other person is authorized to make any warranties other than those described herein, or to extend the duration of any warranties beyond the time period described herein on behalf of Sharp.

The warranties described herein shall be the sole and exclusive warranties granted by Sharp and shall be the sole and exclusive remedy available to the purchaser. Correction of defects, in the manner and for the period of time described herein, shall constitute complete fulfillment of all liabilities and responsibilities of Sharp to the purchaser with respect to the Product, and shall constitute full satisfaction of all claims, whether based on contract, negligence, strict liability or otherwise. In no event shall Sharp be liable, or in any way responsible, for any damages or defects in the Product which were caused by repairs or attempted repairs performed by anyone other than an authorized servicer. Nor shall Sharp be liable or in any way responsible for any incidental or consequential economic or property damage. Some states do not allow the exclusion of incidental or consequential damages, so the above exclusion may not apply to you.

THIS WARRANTY GIVES YOU SPECIFIC LEGAL RIGHTS. YOU MAY ALSO HAVE OTHER RIGHTS WHICH VARY FROM STATE TO STATE.

Model Specific Section (In-Home Service)

Your Product Model Number & Description:

DT-200 Projector

(Be sure to have this information available when you need service for your Product.)

Warranty Period for this Product:

One (1) year parts and labor from date of purchase except for the Projector Lamp for which the warranty period is ninety (90) days from date of purchase. After the ninety (90) day warranty period on the Projector Lamp, parts and labor for a lamp replacement are the responsibility of the consumer.

Additional Item(s) Excluded from Warranty Coverage (if any):

Cleaning of Optical System and/or replacement of any filter.
Labor & materials required to remove and reinstall a suspended projector in installations not accessible with a standard (8' step) ladder or ceilings exceeding 12' in height.

Where to Obtain Service:

Labor & materials required to remove and reinstall a projector in complex systems including, but not limited to, projectors installed in custom enclosures, projectors connected to third party control and automation systems, and realignment of projectors installed in "mirrored" rear projection enclosures.

What to do to Obtain Service:

From a Sharp Authorized Servicer located in the United States. To find the location of the nearest Sharp Authorized Servicer, call Sharp toll free at 1-800-BE-SHARP.

Contact your Sharp Authorized Servicer to obtain in-home service for this Product. The Servicer will come to your home and if necessary to remove the Product for repair at the Servicer's facility, the Servicer will reinstall it upon completion of repair. Be sure to have **Proof of Purchase** available.



SHARP®

LIMITED WARRANTY

Consumer Electronics Products

Congratulations on your purchase!

Sharp Electronics of Canada Ltd. (hereinafter called "Sharp") gives the following express warranty to the first consumer purchaser for this Sharp brand product, when shipped in its original container and sold or distributed in Canada by Sharp or by an Authorized Sharp Dealer:

Sharp warrants that this product is free, under normal use and maintenance, from any defects in material and workmanship. If any such defects should be found in this product within the applicable warranty period, Sharp shall, at its option, repair or replace the product as specified herein.

This warranty shall not apply to:

- (a) Any defects caused or repairs required as a result of abusive operation, negligence, accident, improper installation or inappropriate use as outlined in the owner's manual.
- (b) Any Sharp product tampered with, modified, adjusted or repaired by any party other than Sharp, Sharp's Authorized Service Centres or Sharp's Authorized Servicing Dealers.
- (c) Damage caused or repairs required as a result of the use with items not specified or approved by Sharp, including but not limited to head cleaning tapes and chemical cleaning agents.
- (d) Any replacement of accessories, glassware, consumable or peripheral items required through normal use of the product including but not limited to earphones, remote controls, AC adapters, batteries, temperature probe, stylus, trays, filters, belts, ribbons, cables and paper.
- (e) Any cosmetic damage to the surface or exterior that has been defaced or caused by normal wear and tear.
- (f) Any damage caused by external or environmental conditions, including but not limited to transmission line/power line voltage or liquid spillage.
- (g) Any product received without appropriate model, serial number and CSA/cUL markings.
- (h) Any products used for rental or commercial purposes.
- (i) Any installation, setup and/or programming charges.

Should this Sharp product fail to operate during the warranty period, warranty service may be obtained upon delivery of the Sharp product together with proof of purchase and a copy of this LIMITED WARRANTY statement to an Authorized Sharp Service Centre or an Authorized Sharp Servicing Dealer. In home warranty service may be provided at Sharp's discretion on any Sharp television with the screen size of 27" or larger and on any Sharp Over The Range Microwave Oven.

This warranty constitutes the entire express warranty granted by Sharp and no other dealer, service centre or their agent or employee is authorized to extend, enlarge or transfer this warranty on behalf of Sharp. To the extent the law permits, Sharp disclaims any and all liability for direct or indirect damages or losses or for any incidental, special or consequential damages or loss of profits resulting from a defect in material or workmanship relating to the product, including damages for the loss of time or use of this Sharp product or the loss of information. The purchaser will be responsible for any removal, reinstallation, transportation and insurance costs incurred. Correction of defects, in the manner and period of time described herein, constitute complete fulfillment of all obligations and responsibilities of Sharp to the purchaser with respect to the product and shall constitute full satisfaction of all claims, whether based on contract, negligence, strict liability or otherwise.

WARRANTY PERIODS

Projector	1 years (bulb 90 days)
-----------	------------------------

To obtain the name and address of the nearest Authorized Sharp Service Centre or Dealer, please contact:
SHARP ELECTRONICS OF CANADA LTD.

SHARP ELECTRONICS OF CANADA LTD
335 Britannia Road East
Mississauga, Ontario
L4Z 1W9
(905) 568-7140
Web site: www.sharp.ca

