

myprojectorlamps.com

**The most trusted, dependable name
in projector lamp sales.**



<http://www.myprojectorlamps.com>



<http://www.myprojectorlamps.ca>



<http://www.myprojectorlamps.eu>

The following projector manual has not been modified or altered in any way.



LCD Projection Monitor MODEL PLV-55WM1

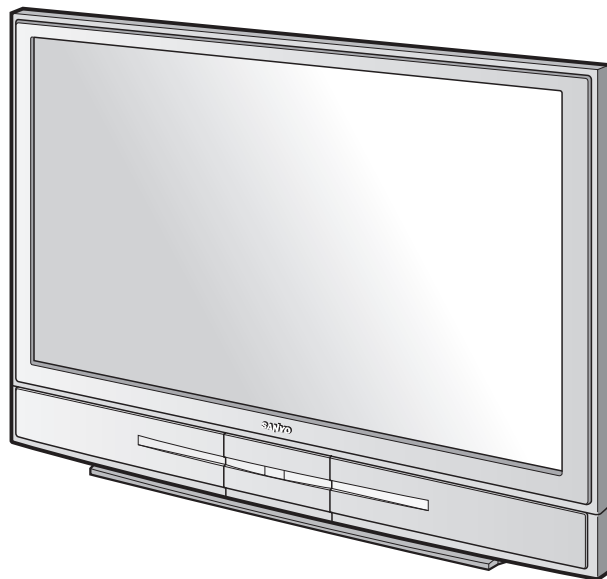

Owner's Manual

Table of Contents

Table of Contents	2	Computer Input	33
To the Owner	3	Input Source Selection (INPUT 1 / PC digital, AV HDCP)	33
Safety Instructions	4	Input Source Selection (INPUT 2 / PC analog)	34
Compliance	5	Computer System Selection	35
Features and Design	6	Computer Adjustment (Auto)	36
Installation	7	Computer Adjustment (Manual)	37
Installing the LCD Projection Monitor	7	Image Level Selection	39
Part Names and Functions	8	Image Level Adjustment	40
Front	8	Screen Size Adjustment	41
Back	9	Setting	42
Front Jacks	10	Setting	42
Rear Terminals	11	Maintenance and Cleaning	45
Remote Control	12	Warning Indicator	45
Remote Control Operating Range	13	Cleaning the Air Filter	46
Remote Control Batteries Installation	13	Cleaning the LCD Projection Monitor	46
Remote Control Code	14	Lamp Replacement	47
Preparation	15	Lamp Replace Counter	48
Connecting the AC Power Cord	15	Appendix	50
Connecting to a Computer and Video Equipment (Video, S-Video)	16	Troubleshooting	50
Connecting to Video Equipment (Component, DVI compatible with HDCP)	17	Indicators and Condition of the LCD Projection Monitor	51
Basic Operation	18	Menu Tree	52
Turning On the LCD Projection Monitor	18	Compatible Computer Specifications	55
Turning Off the LCD Projection Monitor	18	Technical Specifications	56
Sound Adjustment	19	Dimensions	57
Audio Selection	19	Optional Parts	57
Lamp Control Function	20	Configurations of Terminal	58
Picture Freeze Function	20		
On-Screen Menu	21		
Menus	22		
Audio Adjustment	24		
Video Input	25		
Input Source Selection (INPUT 3 / RGB, Video (Video conference), Component)	25		
Input Source Selection (INPUT 4 / Video (Video conference), S-video, Component)	26		
Input Source Selection (INPUT 5 / Video (Video conference))	27		
Video System Selection	28		
Image Level Selection	29		
Image Level Adjustment	30		
Screen Size Adjustment	32		

TRADEMARKS

- Apple, Macintosh, and PowerBook are trademarks or registered trademarks of Apple Computer, Inc.
- IBM, VGA, XGA, and PS/2 are trademarks or registered trademarks of International Business Machines, Inc.
- Each name of corporations or products in the owner's manual is a trademark or a registered trademark of its respective corporation.





To the Owner

Before operating this LCD Projection Monitor, read this manual thoroughly and operate the LCD Projection Monitor properly.

This LCD Projection Monitor provides many convenient features and functions. Operating the LCD Projection Monitor properly enables you to manage those features and maintains it in better condition for a considerable time.

Improper operation may result in not only shortening the product-life, but also malfunctions, fire hazard, or other accidents.

If your LCD Projection Monitor seems to operate improperly, read this manual again, check operations and cable connections and try the solutions in the "Troubleshooting" section in the end of this booklet. If the problem still persists, contact the dealer where you purchased the LCD Projection Monitor or the service center.

	CAUTION RISK OF ELECTRIC SHOCK DO NOT OPEN	
CAUTION : TO REDUCE THE RISK OF ELECTRIC SHOCK, DO NOT REMOVE COVER (OR BACK). NO USER-SERVICEABLE PARTS INSIDE EXCEPT LAMP REPLACEMENT. REFER SERVICING TO QUALIFIED SERVICE PERSONNEL.		
	THIS SYMBOL INDICATES THAT DANGEROUS VOLTAGE CONSTITUTING A RISK OF ELECTRIC SHOCK IS PRESENT WITHIN THIS UNIT.	
	THIS SYMBOL INDICATES THAT THERE ARE IMPORTANT OPERATING AND MAINTENANCE INSTRUCTIONS IN THE OWNER'S MANUAL WITH THIS UNIT.	

Installing the LCD Projection Monitor Safely

When installing the LCD Projection Monitor, secure the Projection Monitor on the wall with safety parts (included) with hook and a chain or wire. If not, the LCD Projection Monitor may fall down and accident can result.

Chain or Wire Hook

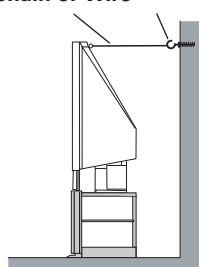

 Chain, wire and hook must sustain load of 33 lb (15kg). Chain and wire should be stretched tight.

Attaching the safety parts

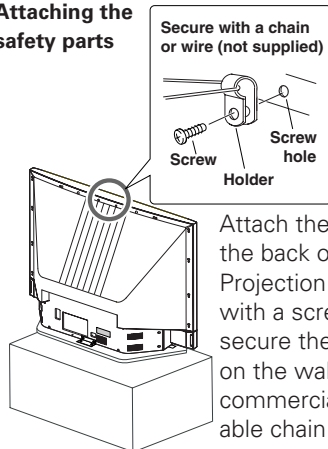

Attach the holder on the back of the LCD Projection Monitor with a screw. Then secure the holder on the wall with a commercially available chain or wire and a hook.



Safety Precaution

WARNING : TO REDUCE THE RISK OF FIRE OR ELECTRIC SHOCK, DO NOT EXPOSE THIS APPLIANCE TO RAIN OR MOISTURE.

- Install the LCD Projection Monitor in a proper position. If not, it may result in a fire hazard.
- Provide appropriate space on the top, sides and rear of the LCD Projection Monitor cabinet for allowing air circulation and cooling the LCD Projection Monitor. Minimum clearance must be maintained. If the LCD Projection Monitor is to be built into a compartment or similarly enclosed, the minimum distances must be maintained. Do not cover the ventilation slot on the LCD Projection Monitor. Heat build-up can reduce the service life of your LCD Projection Monitor, and can also be dangerous.
- Do not put any flammable object or spray can near the LCD Projection Monitor, hot air is exhausted from the ventilation holes.
- If the LCD Projection Monitor is not to be used for an extended time, unplug the LCD Projection Monitor from the power outlet.

READ AND KEEP THIS OWNER'S MANUAL FOR LATER USE.

Care for Using the LCD Projection Monitor

When using the LCD Projection Monitor, the following precautions should be taken. Otherwise, the screen can be damaged:

- Do not push or hit the screen surface.
- Do not write, paint or affix anything on the screen.
- Do not put anything on the LCD Projection Monitor.

For cleaning the LCD Projection Monitor, refer to "Cleaning the LCD Projection Monitor" on p46 and maintain it properly.

NOTE:

- Black dots or bright points of light (red, green, or blue) may appear on the screen. This is a characteristic of the LCD panels, not a malfunction of the LCD Projection Monitor.

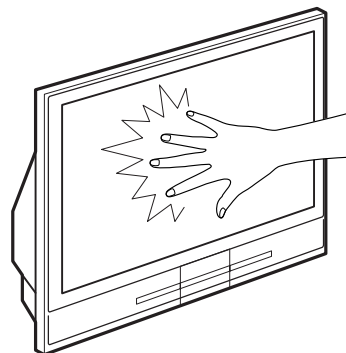

Do not push or hit the screen.

Safety Instructions

All the safety and operating instructions should be read before the product is operated.

Read all of the instructions given here and retain them for later use. Unplug this LCD Projection Monitor from AC power supply before cleaning. Do not use liquid or aerosol cleaners. Use a damp cloth for cleaning.

Follow all warnings and instructions marked on the LCD Projection Monitor.

For added protection to the LCD Projection Monitor during a lightning storm, or when it is left unattended and unused for long periods of time, unplug it from the wall outlet. This will prevent damage due to lightning and power line surges.

Do not expose this unit to rain or use near water... for example, in a wet basement, near a swimming pool, etc...

Do not use attachments not recommended by the manufacturer as they may cause hazards.

Do not place this LCD Projection Monitor on an unstable cart, stand, or table. The LCD Projection Monitor may fall, causing serious injury to a child or adult, and serious damage to the LCD Projection Monitor. Use only with a cart or stand recommended by the manufacturer, or sold with the LCD Projection Monitor. Wall or shelf mounting should follow the manufacturer's instructions, and should use a mounting kit approved by the manufacturers.



An appliance and cart combination should be moved with care. Quick stops, excessive force, and uneven surfaces may cause the appliance and cart combination to overturn.

Slots and openings on the back and bottom of the cabinet are provided for ventilation, to insure reliable operation of the equipment and to protect it from overheating.

The openings should never be covered with cloth or other materials, and the bottom opening should not be blocked by placing the LCD Projection Monitor on a rug, or other similar surface. This LCD Projection Monitor should never be placed near or over a radiator or heat register.

This LCD Projection Monitor should not be placed in a built-in installation such as a book case unless proper ventilation is provided.

Never push objects of any kind into this LCD Projection Monitor through cabinet slots as they may touch dangerous voltage points or short out parts that could result in a fire or electric shock. Never spill liquid of any kind on the LCD Projection Monitor.

Do not place items such as vases containing liquid on top of the LCD Projection Monitor.

Do not install the LCD Projection Monitor near the ventilation duct of air-conditioning equipment.

This LCD Projection Monitor should be operated only from the type of power source indicated on the marking label. If you are not sure of the type of power supplied, consult your authorized dealer or local power company.

Do not overload wall outlets and extension cords as this can result in fire or electric shock. Do not allow anything to rest on the power cord. Do not locate this LCD Projection Monitor where the cord may be damaged by persons walking on it.

Do not attempt to service this LCD Projection Monitor yourself as opening or removing covers may expose you to dangerous voltage or other hazards. Refer all servicing to qualified service personnel.

Unplug this LCD Projection Monitor from wall outlet and refer servicing to qualified service personnel under the following conditions:

- When the power cord or plug is damaged or frayed.
- If liquid has been spilled into the LCD Projection Monitor.
- If the LCD Projection Monitor has been exposed to rain or water.
- If the LCD Projection Monitor does not operate normally by following the operating instructions. Adjust only those controls that are covered by the operating instructions as improper adjustment of other controls may result in damage and will often require extensive work by a qualified technician to restore the LCD Projection Monitor to normal operation.
- If the LCD Projection Monitor has been dropped or the cabinet has been damaged.
- When the LCD Projection Monitor exhibits a distinct change in performance-this indicates a need for service.

When replacement parts are required, be sure the service technician has used replacement parts specified by the manufacturer that have the same characteristics as the original part. Unauthorized substitutions may result in fire, electric shock, or injury to persons.

Upon completion of any service or repairs to this LCD Projection Monitor, ask the service technician to perform routine safety checks to determine that the LCD Projection Monitor is in safe operating condition.

Voor de klanten in Nederland



Bij dit produkt zijn batterijen geleverd. Wanneer deze leeg zijn, moet u ze niet weggooien maar inleveren als KCA.

Compliance

Federal Communication Commission Notice

This equipment has been tested and found to comply with the limits for a Class A digital device, pursuant to Part 15 of FCC Rules. These limits are designed to provide reasonable protection against harmful interference when the equipment is operated in a commercial environment. This equipment generates, uses, and can radiate radio frequency energy and, if not installed and used in accordance with the instruction manual, may cause harmful interference to radio communications. Operation of this equipment in a residential area is likely to cause harmful interference in which case the user will be required to correct the interference at his own expense.

Do not make any changes or modifications to the equipment unless otherwise specified in the instructions. If such changes or modifications should be made, you could be required to stop operation of the equipment.

CAUTION

This is a Class A equipment. This equipment can cause interference in residential areas; in this case, the operator can be asked to take adequate countermeasures.

AC POWER CORD REQUIREMENT

The AC Power Cord supplied with this monitor meets the requirement for use in the country you purchased it.

AC Power Cord for the United States and Canada :

AC Power Cord used in the United States and Canada is listed by the Underwriters Laboratories (UL) and certified by the Canadian Standard Association (CSA).

AC Power Cord has a grounding-type AC line plug. This is a safety feature to be sure that the plug will fit into the power outlet. Do not try to defeat this safety feature. Should you be unable to insert the plug into the outlet, contact your electrician.

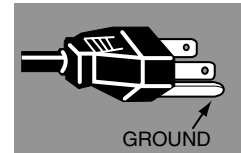

AC Power Cord for the United Kingdom :

This cord is already fitted with a moulded plug incorporating a fuse, the value of which is indicated on the pin face of the plug. Should the fuse need to be replaced, an ASTA approved BS 1362 fuse must be used of the same rating, marked thus \diamond . If the fuse cover is detachable, never use the plug with the cover omitted. If a replacement fuse cover is required, ensure it is of the same colour as that visible on the pin face of the plug (i.e. red or orange). Fuse covers are available from the Parts Department indicated in your User Instructions.

If the plug supplied is not suitable for your socket outlet, it should be cut off and destroyed.

The end of the flexible cord should be suitably prepared and the correct plug fitted. (See Over)

WARNING : A PLUG WITH BARED FLEXIBLE CORD IS HAZARDOUS IF ENGAGED IN A LIVE SOCKET OUTLET.

The Wires in this mains lead are coloured in accordance with the following code:

Green-and-yellow Earth
Blue Neutral
Brown Live

As the colours of the wires in the mains lead of this apparatus may not correspond with the coloured markings identifying the terminals in your plug proceed as follows:

The wire which is coloured green-and-yellow must be connected to the terminal in the plug which is marked by the letter E or by the safety earth symbol \perp or coloured green or green-and-yellow.

The wire which is coloured blue must be connected to the terminal which is marked with the letter N or coloured black.

The wire which is coloured brown must be connected to the terminal which is marked with the letter L or coloured red.

WARNING : THIS APPARATUS MUST BE EARTHED.

THE SOCKET-OUTLET SHOULD BE INSTALLED NEAR THE EQUIPMENT AND EASILY ACCESSIBLE.

Features and Design

This LCD Projection Monitor is designed with the most advanced technology for various use. This LCD Projection Monitor has a large screen and utilizes built-in multimedia features, a palette of 16.77 million colors, and matrix liquid crystal display (LCD) technology.

◆ 16 : 9 Wide Screen

The LCD Projection Monitor employs 55" large-sized screen and LCD panels (1280 x 720 resolution) of 16 : 9 ratio so that you can enjoy high quality image from the computer in the full large screen.

◆ Compatibility

The LCD Projection Monitor widely accepts various video and computer input signals including;

- **Computers**
IBM-compatible or Macintosh computer up to 1280 x 1024 resolution.
- **4 Color Systems**
NTSC, PAL, SECAM, NTSC4.43 color system can be connected.
- **Component Video**
Component video signal, such as a DVD player output high definition TV signals including 480i, 480p, 575i, 575p, 720p, or 1080i, can be connected.
- **S-video**
S-video signal, such as a S-VHS VCR output signal, can be connected.

◆ Simple Computer System Setting

The LCD Projection Monitor has the Multi-scan system to conform to almost all computer output signals quickly. (p35.)

◆ No Operation Shut Off Timer

The LCD Projection Monitor can automatically be turned off when no one operates the LCD Projection Monitor over 3 hours. This function serves to maintain the lamp life, save power and keep safety while you left the place for a long time. (p42)

◆ Power Management

The Power management function reduces power consumption and maintains the lamp life. (p43.)

◆ Lamp Control

Brightness of the projection lamp can be changed by the setting. The LCD Projection Monitor has the function to adjust the brightness according to the input signal for the best suited image. (p20, 44.)

◆ Multi-language Menu Display

Operation menu is available in English, German, French, Italian, Spanish, Portuguese, Dutch and Swedish. (p42.)

◆ Digital Visual Interface

The LCD Projection Monitor is equipped with the DVI 24-pin terminal for connecting DVI output from a computer or video equipment. You can also enjoy digital entertainment content protected by HDCP technology. (See page 33 for HDCP.)

◆ High Quality Audio System

This LCD Projection Monitor has an audio system to produce high quality sound. There are Bass, Treble and Balance functions on the menu of the LCD Projection Monitor so that you can enjoy powerful sound with the large screen. (p24)

◆ Active 3D Surround

This LCD Projection Monitor provides 3 dimensional surround sound. (p19)

Installation

Installing the LCD Projection Monitor

Placing and Settling the LCD Projection Monitor



CAUTION

When placing the LCD Projection Monitor, the spaces for ventilation must be maintained.

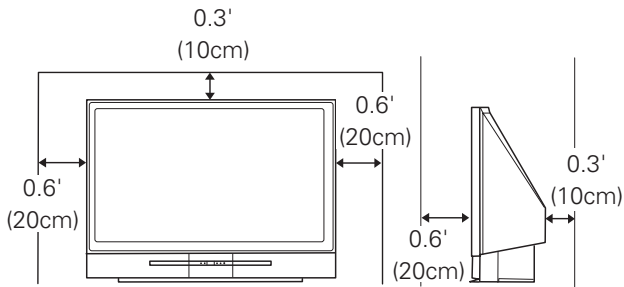

Place the LCD Projection Monitor on flat places or with an exclusive LCD Projection Monitor stand. Placing on unflat places may cause picture tilt or distortion.

Do not place the LCD Projection Monitor under the direct sunlight. This may have a damaging effect on the picture quality and the screen surface of the LCD Projection Monitor.



CAUTION

Never touch the Projection Screen directly with a hand. It may effect the projection image quality.

BE SURE TO USE OR PLACE THE LCD PROJECTION MONITOR IN THE TEMPERATURE INDICATED BELOW:

Operating Temperature	41 °F ~ 95 °F (5 °C ~ 35 °C)
Storage Temperature	14 °F ~ 140 °F (-10 °C ~ 60 °C)

Air Circulation

Openings on the cabinet are provided for ventilation, to ensure reliable operation of the product and to protect it from overheating. Therefore, these openings must not be blocked or covered.



CAUTION

Hot air is exhausted from the exhaust vent. When using or installing the LCD Projection Monitor, the following precautions should be taken.

- Do not put any flammable objects near the vent.
- Keep the exhaust vent at least 0.3'(10cm) away from any objects.
- Do not touch the peripheral part of the exhaust vent, especially screws and metallic parts. These areas will become hot while the LCD Projection Monitor is being used.

Cooling fans are provided to cool down the LCD Projection Monitor. This LCD Projection Monitor monitors internal temperature and control the running speed of the cooling fans.

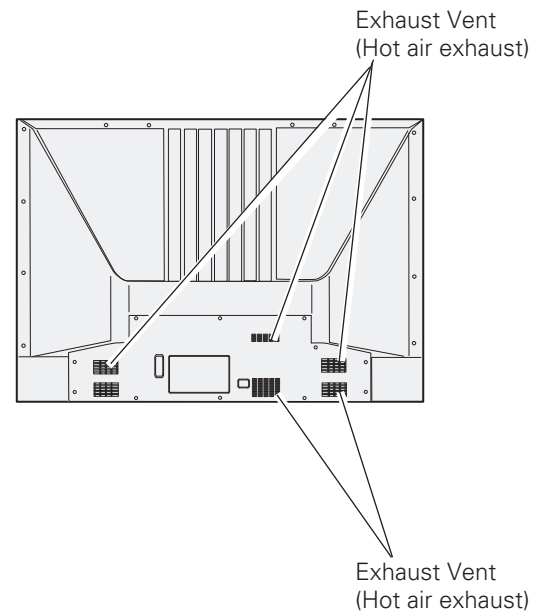

Part Names and Functions

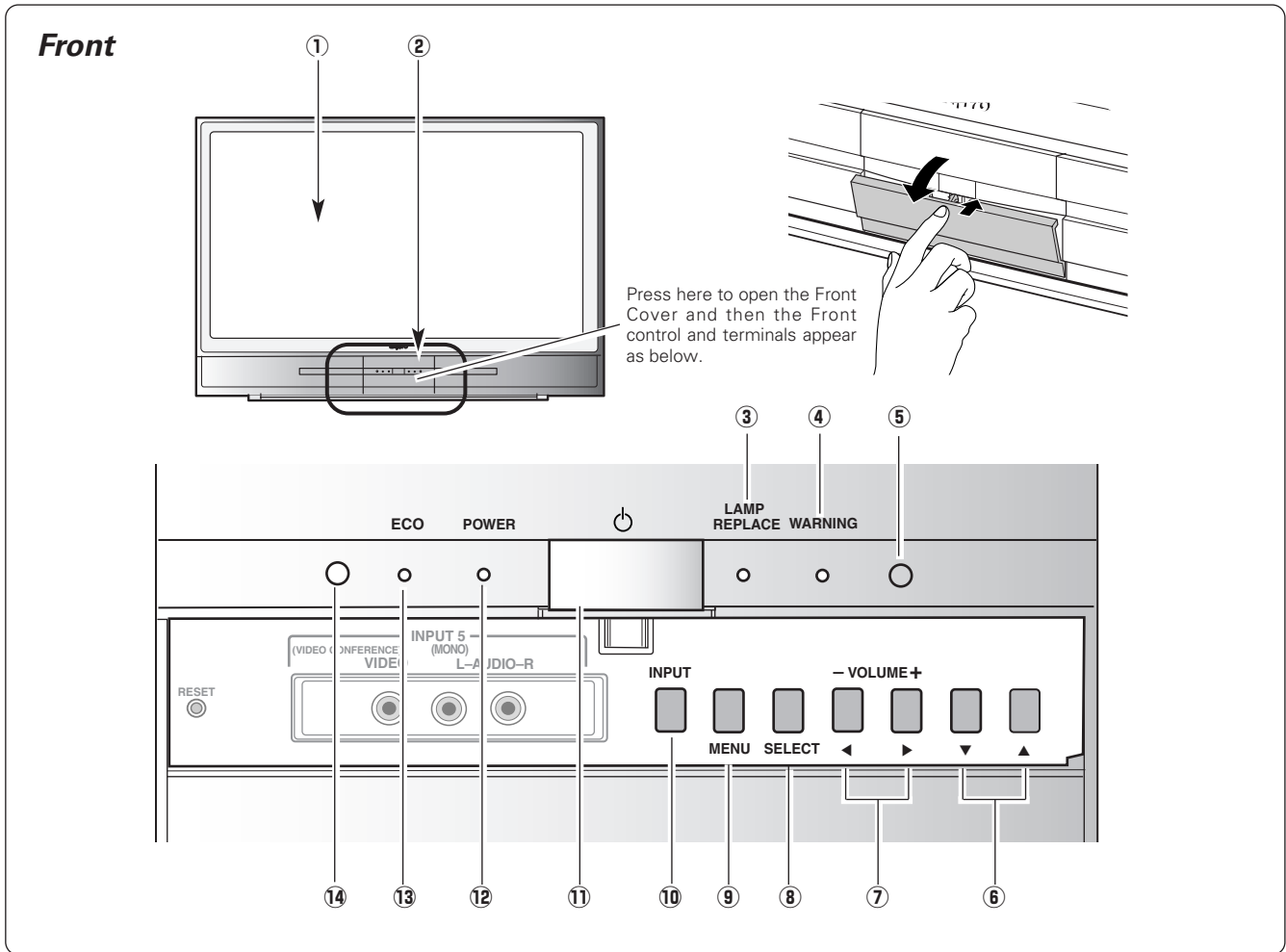

① **Projection Screen**

② **Front Panel and Indicators**

③ **LAMP REPLACE indicator**

Turn orange when the life of the projection lamp draws to an end. (p47, 51)

④ **WARNING indicator**

Emit red light when the LCD Projection Monitor detects abnormal condition. This also blinks red when the internal temperature of the LCD Projection Monitor exceeds the operating range. (p45, 51)

⑤ **Infrared Remote Receiver**

⑥ **Point (Up▲/Down▼) buttons**

Used to select menus on the On-Screen Menu. (p21)

⑦ **VOLUME +/- / Point (Left ◀/Right ▶) buttons**

Used to adjust the volume or set and adjust the menu data on On-Screen Menu. (p19, 21)

⑧ **SELECT button**

Used to execute the item selected and expand the image in the Digital zoom mode. (p41)

⑨ **MENU button**

Used to select the On-Screen Menu operation. (p21)

⑩ **INPUT button**

Used to select the input source. (p25, 26, 27, 33, 34)

⑪ **POWER ON-OFF button**

Used to turn the LCD Projection Monitor on or off. (p18)

⑫ **POWER indicator**

It lights red when the LCD Projection Monitor is in the stand-by mode. It remains green while the LCD Projection Monitor is under operation. (p51)

⑬ **ECO indicator**

Emit yellow light when the Eco1 or Eco2 mode is chosen in the Lamp control function. (p20, 44)

⑭ **Light Sensor**

Detect the ambient light to adjust the display brightness. (p20, 44)

Back

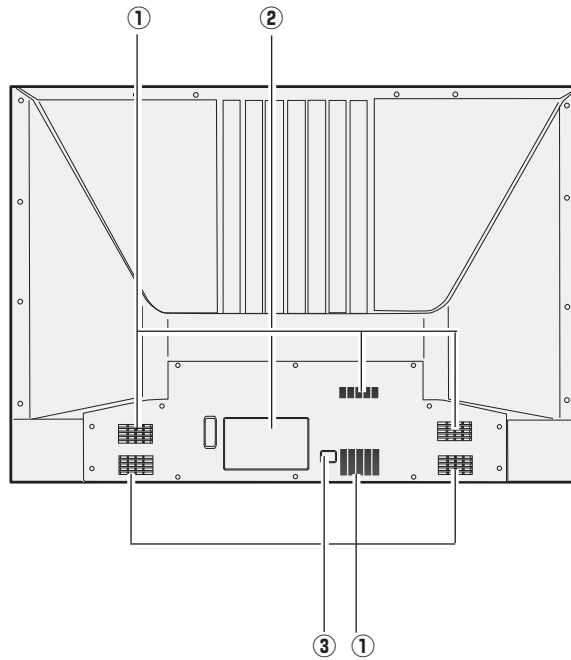

- ① Exhaust Vent
- ② Terminals and Connectors (p11)
- ③ Power Cord Connector

NOTE:
 ● This LCD Projection Monitor detects internal temperature and automatically controls the running speed of the cooling fans.

Front Jacks

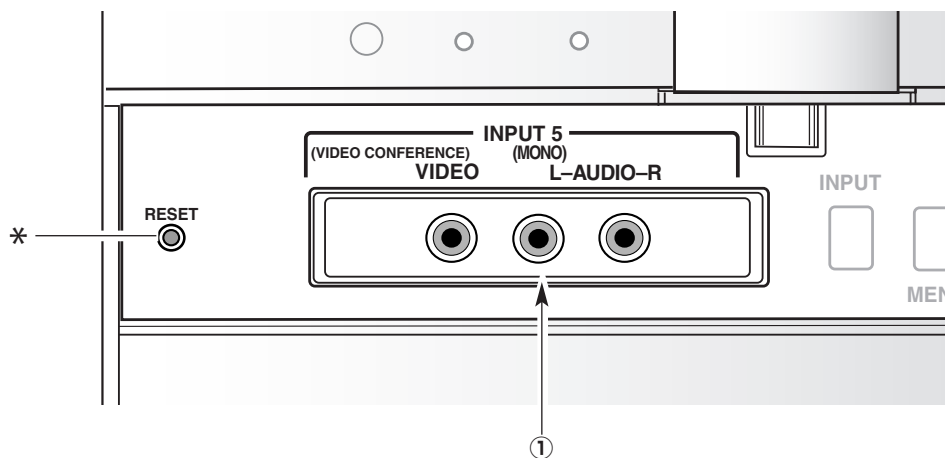

① Input 5

Connect video and audio output from video equipment to these jacks. (p17)

- VIDEO (VIDEO CONFERENCE) (RCA-type)
- AUDIO L (MONO) and R (RCA-type)

* RESET

A built-in micro processor which controls this unit may occasionally malfunction and need to be reset. This can be done by pressing the RESET button with a pen, which will shut down and restart the unit. Do not use the RESET function excessively.

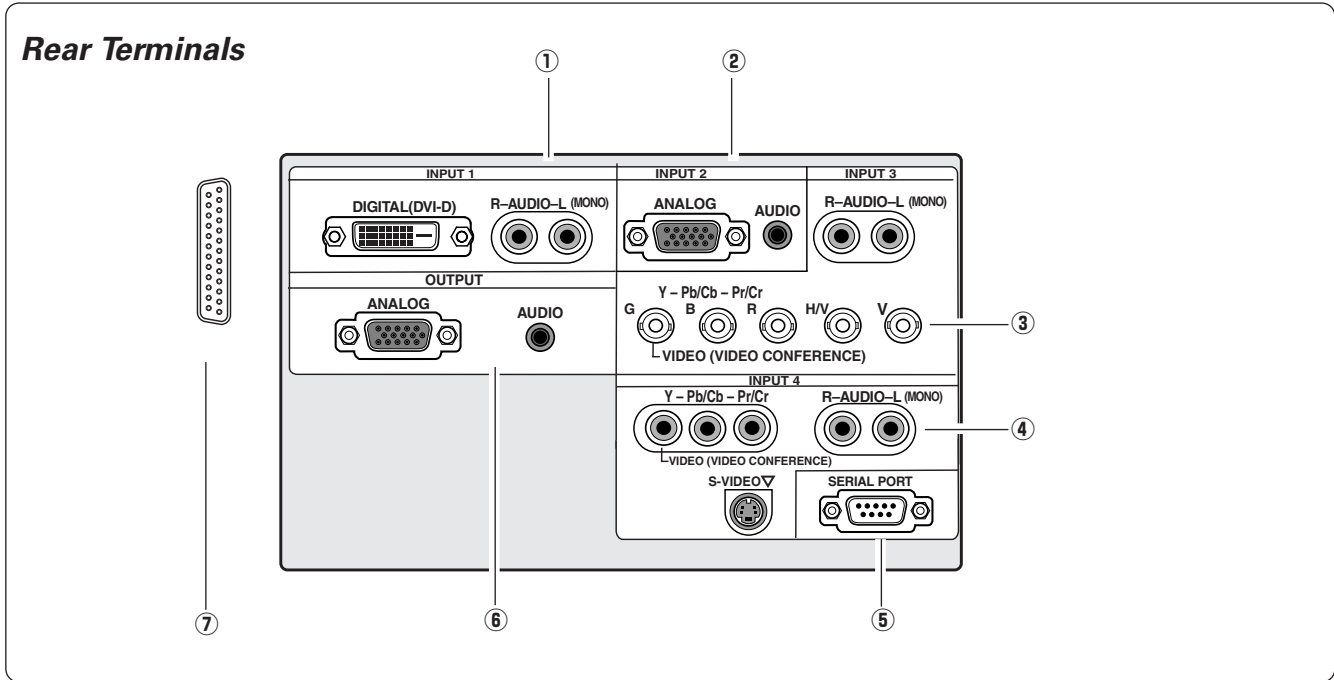

- ① INPUT 1**
 Connect computer (Digital DVI-D type) and audio outputs to these terminals. (p16, 17)

 - RGB (PC DIGITAL / AV HDCP) (DVI-D)
 - AUDIO R and L (MONO) (RCA-type)
- ② INPUT 2**
 Connect computer and audio outputs from computer to these terminals. (p16)

 - RGB ANALOG (D-SUB)
 - AUDIO (Stereo) (Mini-type)
- ③ INPUT 3**
 Connect RGB / component / video and audio outputs from video equipment to these jacks. (p16, 17)

 - RGB/ VIDEO (VIDEO CONFERENCE) / COMPONENT (BNC-type)
 - AUDIO R and L (MONO) (RCA-type)
- ④ INPUT 4**
 Connect component / video, s-video, and audio outputs from video equipment to these jacks. (p16, 17)

 - VIDEO (VIDEO CONFERENCE) / COMPONENT (RCA-type)
 - S-VIDEO (Mini DIN 4-type)
 - AUDIO R and L(MONO) (RCA-type)
- ⑤ SERIAL PORT**
 This jack is used to service this LCD Projection Monitor.
- ⑥ OUTPUT**
 Connect another monitor or external audio amplifier to these jacks. (p16, 17)

 - RGB ANALOG (D-SUB)
 OUTPUT (ANALOG) terminal outputs the signals only coming from INPUT 2 (ANALOG) and INPUT 3 (ANALOG RGB).
 - AUDIO (Stereo)
 Output Audio input of INPUT 1-5.
- ⑦ PJ Net Organizer Connector**
 This terminal is used for optional part, PJ Net Organizer. For details, contact the dealer.

Part Names and Functions

Remote Control

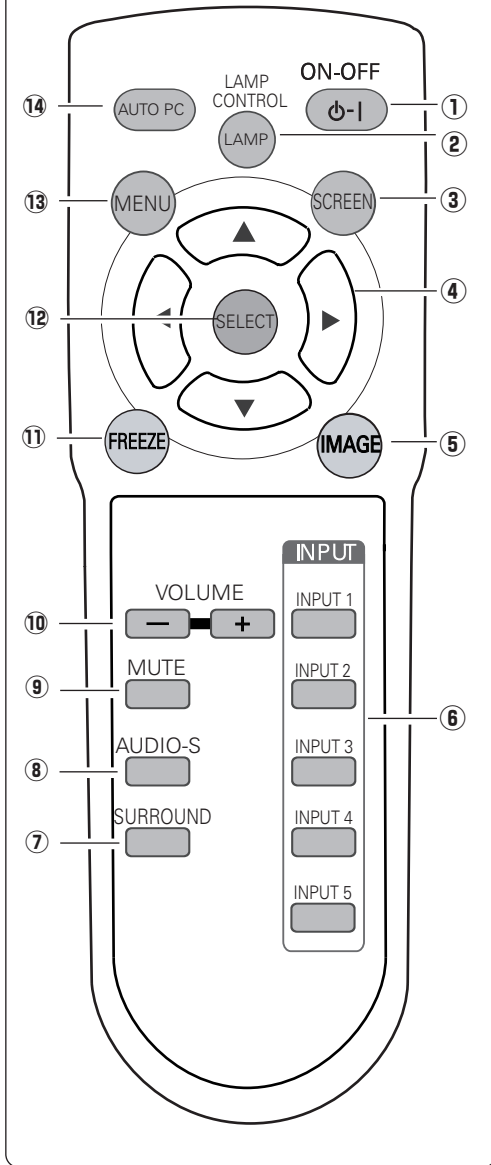

- ① **POWER ON-OFF button**
Turn the LCD Projection Monitor on or off. (p18)
- ② **LAMP CONTROL button**
Select the lamp mode. (p20, 44)
- ③ **SCREEN button**
Select the screen size. (p32, 41)
- ④ **Point (Up▲/ Down▼/ Left◀/ Right▶) buttons**
Select the item or adjust the value in the On-Screen Menu. These are also used to pan the image in the Digital zoom mode. (p41)
- ⑤ **IMAGE button**
Selects the Image Level. (p29, 39)
- ⑥ **INPUT buttons**
Select the input source. (p25, 26, 27, 33, 34)
- ⑦ **SURROUND button**
Turn the 3D Surround function on or off. (p19)
- ⑧ **AUDIO SELECT button**
Select the sound qualities suitable for the projected program. (p19)
- ⑨ **MUTE button**
Mute the sound. (p19)
- ⑩ **VOLUME +/- buttons**
Adjust the volume +/- (p19)
- ⑪ **FREEZE button**
Freeze the projected image. (p20)
- ⑫ **SELECT button**
Execute the item selected, and expand the image in the Digital zoom mode. (p41)
- ⑬ **MENU button**
Open or close the On-Screen Menu. (p21)
- ⑭ **AUTO PC button**
Operate the Auto PC adjustment function. (p36)

Remote Control Operating Range

Point the remote control toward the LCD Projection Monitor (Infrared Remote Receiver) whenever pressing any button. Maximum operating range for the remote control is about 16.4' (5m) and 60° in front of the LCD Projection Monitor.

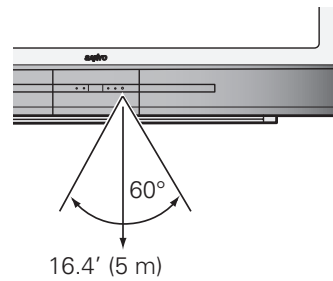

Remote Control Batteries Installation

- 1** Remove the battery compartment lid.

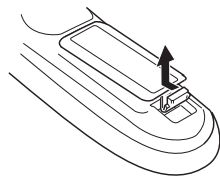

Pull up the lid and remove it.

- 2** Slide the batteries into compartment.

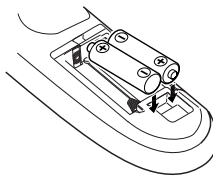

Two AA size batteries
For correct polarity (+ and -), be sure battery terminals are in contact with pins in compartment.

- 3** Replace the compartment lid.

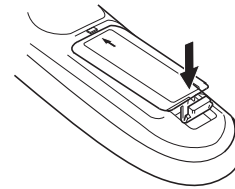

To insure safe operation, please observe the following precautions :

- Use two AA, UM3 or LR06 type alkaline manganese batteries.
- Replace two batteries at the same time.
- Do not use a new battery with a used battery.
- Avoid contact with water or liquid.
- Do not expose the remote control to moisture or heat.
- Do not drop the remote control.
- If a battery has leaked on the remote control, carefully wipe case clean and install new batteries.
- Risk of explosion if the battery is replaced by an incorrect type.
- Dispose of used batteries according to the instructions.

Remote Control Code

This LCD Projection Monitor has 8 different remote control codes (Code 1 - Code 8). Switching remote control codes prevents remote control interference when operating several equipment at the same time. Change the remote control code of the LCD Projection Monitor first before changing that of the remote control. See "Remote control" in the Setting on page 43.

With holding down the MENU button, press the IMAGE button. The code switches sequentially each time pressing the IMAGE button. (See the list below.)

Remote Control Code	Number of Times of Pressing IMAGE Button
Code 1	1
Code 2	2
Code 3	3
Code 4	4
Code 5	5
Code 6	6
Code 7	7
Code 8	8

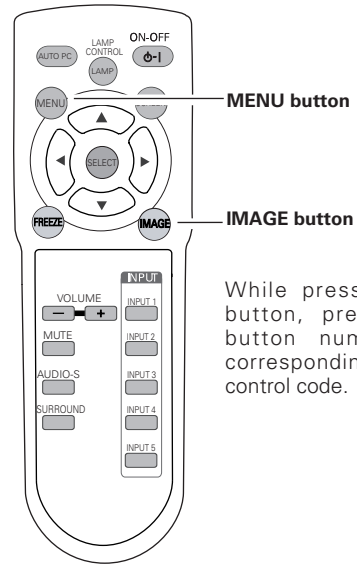

While pressing the MENU button, press the IMAGE button number of times corresponding to the remote control code.

Preparation

Connecting the AC Power Cord

This LCD Projection Monitor uses nominal input voltages of 100-120 V or 200-240 V AC. This LCD Projection Monitor automatically selects the correct input voltage. It is designed to work with single-phase power systems having a grounded neutral conductor. To reduce the risk of an electrical shock, do not plug into any other type of the power system.

Consult your authorized dealer or service station if you are not sure of the type of power being supplied.

Connect the LCD Projection Monitor with all peripheral equipment before turning the LCD Projection Monitor on. (See p16,17 for connection.)

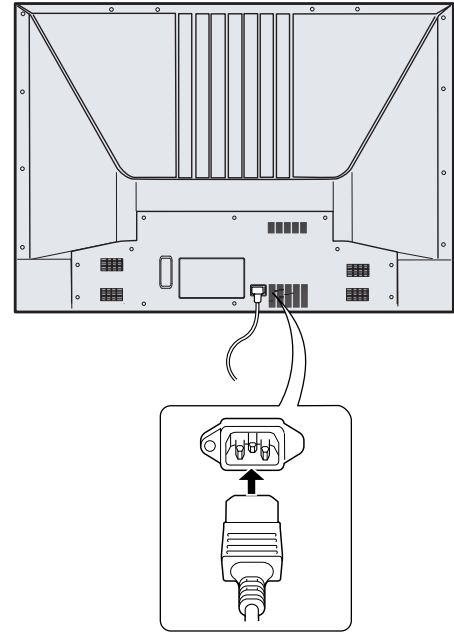

Connect the AC Power Cord (supplied) to the LCD Projection Monitor. The AC outlet must be near this equipment and must be easily accessible.



CAUTION

For safety, unplug the AC power cord when the LCD Projection Monitor is not in use.
When this LCD Projection Monitor is connected to the outlet with the AC power cord, it is in stand-by mode and consumes a little electric power.

THE SOCKET-OUTLET SHOULD BE INSTALLED NEAR THE EQUIPMENT AND EASILY ACCESSIBLE.

NOTE ON THE POWER CORD

AC power cord must meet requirement of the country where you use a LCD Projection Monitor.
Confirm an AC plug type with the chart below and proper AC power cord must be used.
If supplied AC power cord does not match your AC outlet, contact your sales dealer.

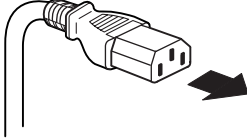
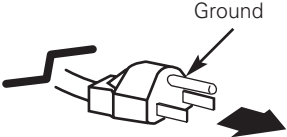
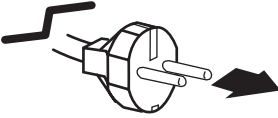
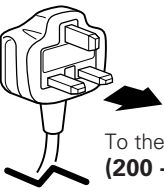
LCD Projection Monitor side	AC outlet side		
 <p data-bbox="203 1465 446 1537">To power cord connector on your LCD Projection Monitor.</p>	<p data-bbox="495 1312 795 1339">For the U.S.A. and Canada</p>  <p data-bbox="625 1491 787 1543">To the AC outlet. (120 V AC)</p>	<p data-bbox="828 1312 1128 1339">For Continental Europe</p>  <p data-bbox="950 1501 1128 1554">To the AC outlet. (200 - 240 V AC)</p>	<p data-bbox="1226 1312 1388 1339">For the U.K.</p>  <p data-bbox="1274 1480 1461 1533">To the AC outlet. (200 - 240 V AC)</p>

Connecting to a Computer and Video Equipment (Video, S-Video)

Computer (Digital/Analog)

Use a DVI cable (commercially available) for digital.
 Use a VGA cable (Option) for analog.
 Use a VGA-BNC cable (commercially available) for RGB.

Video, S-Video

Use a Video cable or a S-Video cable (commercially available).

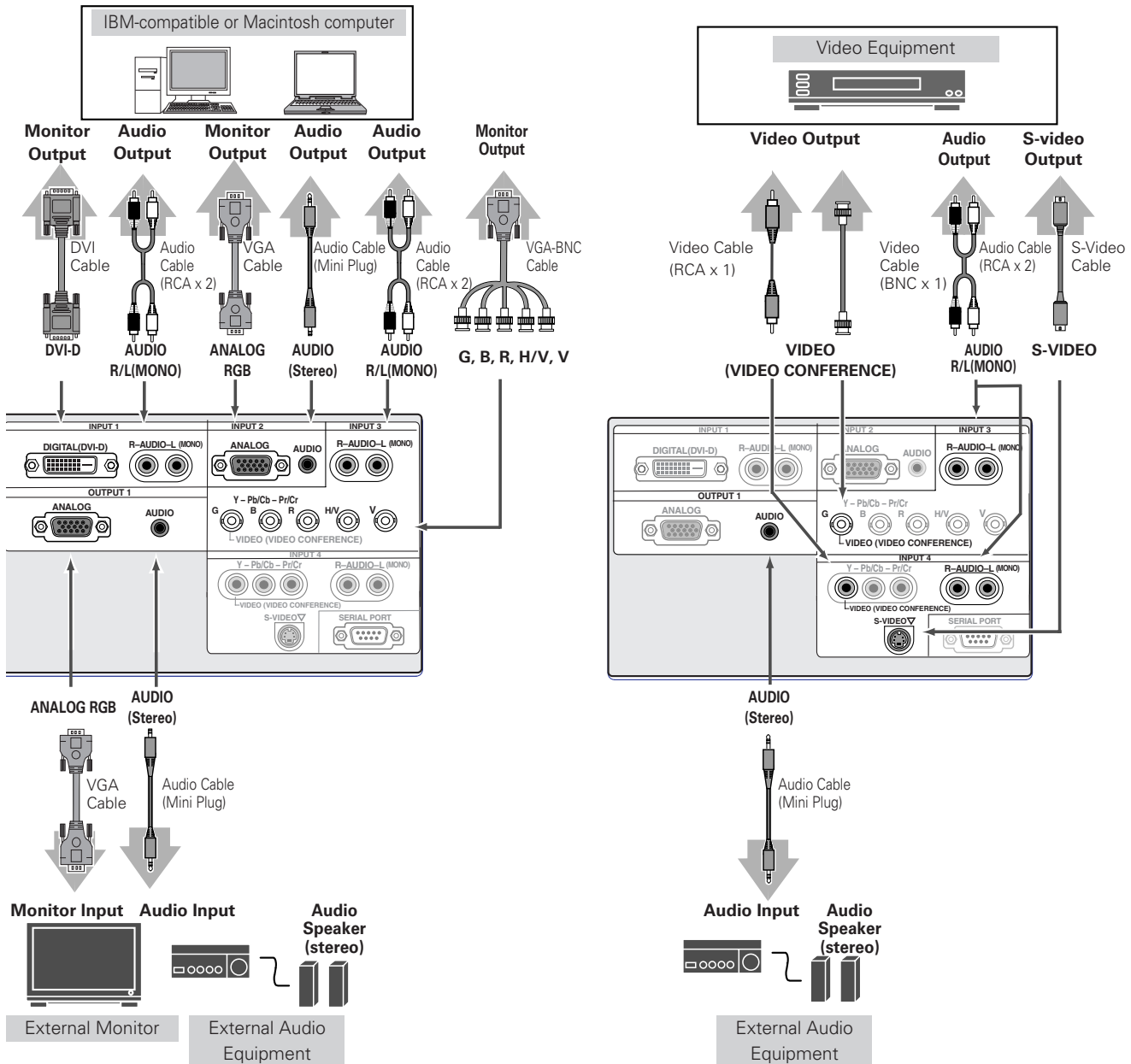

NOTE:

- OUTPUT (ANALOG) terminal outputs the signals only coming from INPUT 2 (ANALOG) and INPUT 3 (ANALOG RGB).
- See p57 for ordering optional cables.



When connecting the cable, the power cords of both the LCD Projection Monitor and the external equipment should be disconnected from AC outlet.

Connecting to Video Equipment (Component, DVI compatible with HDCP)

Component, DVI compatible with HDCP, Video

Use a DVI cable (commercially available) for DVI compatible with HDCP.

Use a Component cable or VGA-BNC cable (commercially available) for component.

Use a Video cable (commercially available) for component.

Rear Terminals

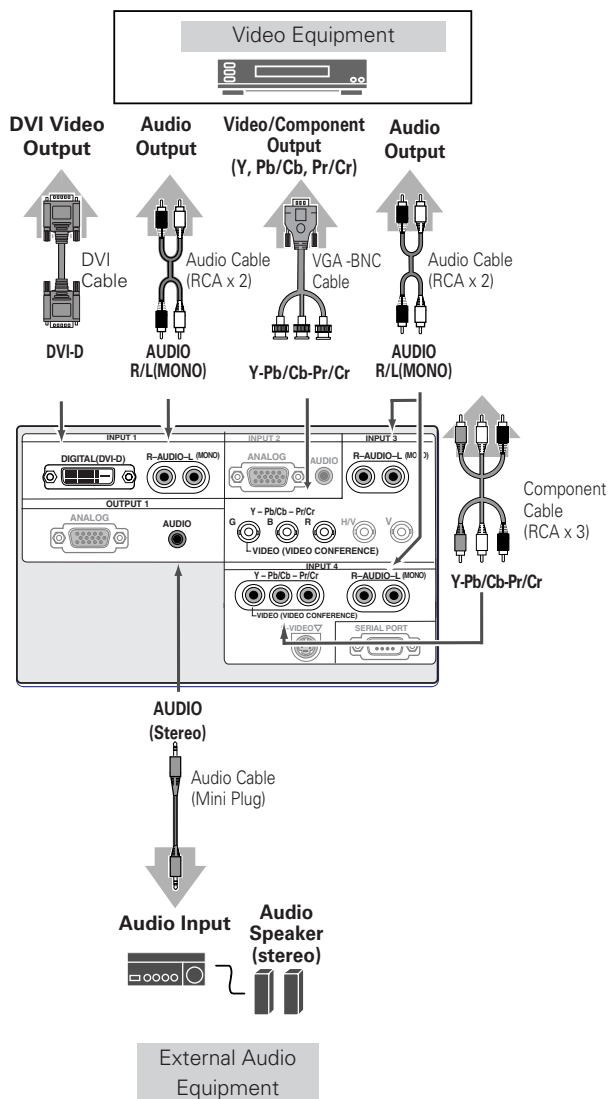

Video

Use a Video cable (commercially available) for video.

Front Terminals

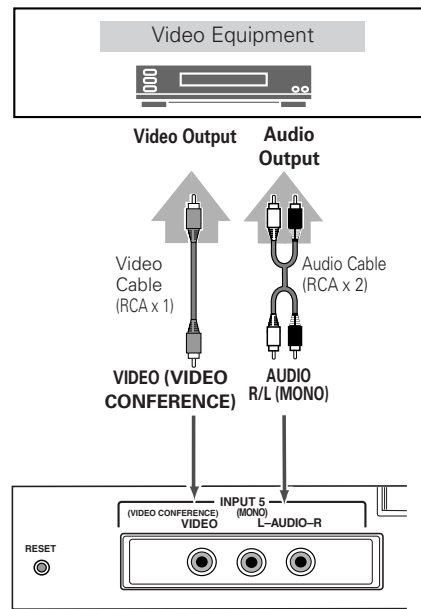

NOTE:

- Digital RGB, Digital HDCP, Component and Video signal can not be output from the OUTPUT terminal.



When connecting the cable, the power cords of both the LCD Projection Monitor and the external equipment should be disconnected from AC outlet.

Basic Operation

Turning On the LCD Projection Monitor

- 1 Connect the LCD Projection Monitor's AC power cord into an AC outlet and the POWER indicator turns into red.
- 2 Press the POWER ON-OFF button on the front panel of the LCD Projection Monitor or the remote control. The cooling fans start to operate. The POWER indicator blinks green rapidly for 15 seconds.
- 3 The POWER indicator emits green light then the input source and the lamp mode that were selected last will be displayed on the screen.

Front Panel

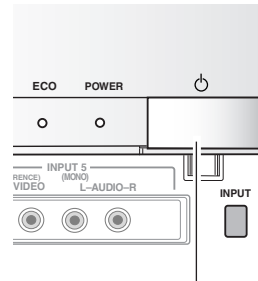

POWER ON-OFF button

Remote Control

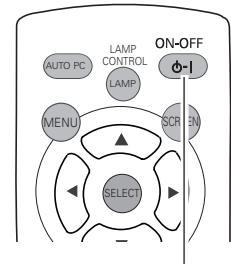

POWER ON-OFF button

Selected Input Source and Lamp Mode



NOTE:

- While the POWER indicator blinks green rapidly, no operation of the remote control and the front panel can be accepted.

Turning Off the LCD Projection Monitor

Press the POWER ON-OFF button on the front panel or on the remote control.

The POWER indicator turns into orange, and it continues while the cooling fans are operating (for about 4 minutes). The LCD Projection Monitor can be turned on again during this period or after the indicator turns into red.

When the LCD Projection Monitor has cooled down enough, the POWER indicator emits red light. Then you can disconnect the AC power cord.



TO MAINTAIN THE LIFE OF THE LAMP, ONCE YOU TURN YOUR LCD PROJECTION MONITOR ON, WAIT AT LEAST 5 MINUTES BEFORE TURNING IT OFF. DO NOT DISCONNECT AC POWER CORD WHILE COOLING FANS ARE RUNNING OR BEFORE POWER INDICATOR EMITS RED LIGHT. OTHERWISE IT WILL RESULT IN SHORTENING LAMP LIFE.

NOTE:

- Do not use the LCD Projection Monitor for more than 24 hours continuously. Turn off the LCD Projection Monitor at least once in 24 hours and give it a rest. Continuous use may result in shortening the lamp life.
- This LCD Projection Monitor monitors internal temperature and automatically controls the running speed of the cooling fans.
- If the WARNING indicator blinks or emits red light, see "Warning Indicator" on page 45, 51.

Sound Adjustment

Direct Operation

Volume

Press the VOLUME +/- button on the front panel or on the remote control to adjust the volume. The volume dialog box appears on the screen for a few seconds.

Press + button to turn up the volume and - button to turn it down.

Mute

Press the MUTE button on the remote control to minimize the sound. To restore the sound to its previous level, press the MUTE button again or press the VOLUME +/- button.

Surround

Press the SURROUND button on the remote control to provide the 3D surround (3 dimensional) sound.

Remote Control

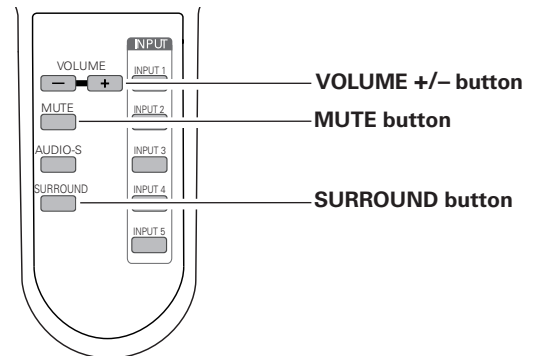

Front Panel

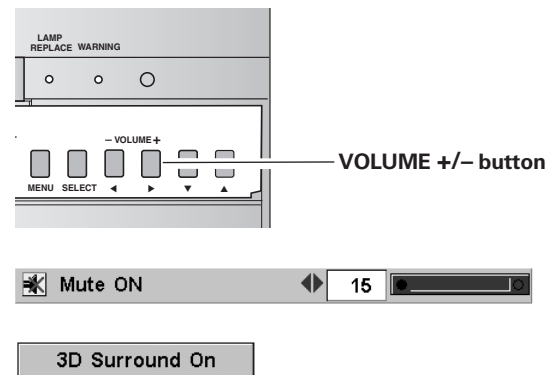

Audio Selection

Select the audio mode the most suitable for the projected program or the input source among Music, Talk, Normal and Personal by pressing the AUDIO-S button on the remote control.

Music

Bass sound fitting music programs.

Talk

Treble sound fitting drama and news programs.

Normal

Normal sound fitting any input source.

Personal

User preset sound. (p24)

Remote Control

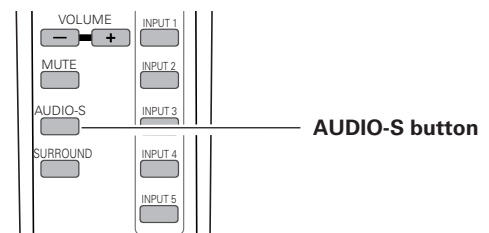



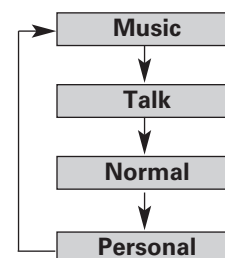

AUDIO-S button



Lamp Control Function

Lamp mode can be selected from the following modes depending on the program scenes and environments of using the LCD Projection Monitor. The lamp mode can be selected in the Setting menu as well. (p44)

Display Icons:

-  Normal... Normal brightness
-  Auto... The controlled brightness according to the input signal
-  Eco1... The controlled brightness according to the ambient light
-  Eco2... 80% lower brightness than normal brightness and reduce the lamp power consumption.

The ECO indicator emits yellow light when Eco1 or Eco2 is selected.

Picture Freeze Function

Press the FREEZE button on the remote control to freeze the picture on the screen. To cancel the Freeze function, press the FREEZE button again or press any other button.

Remote Control

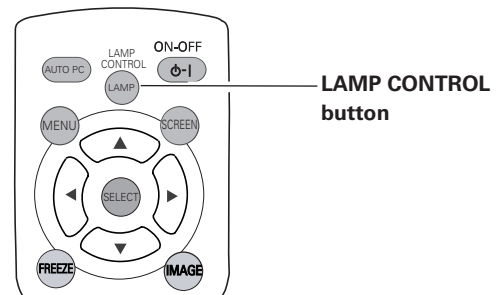

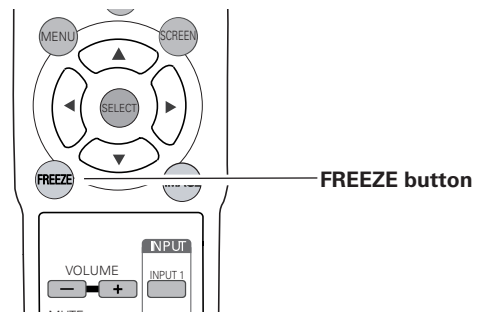

Remote Control



On-Screen Menu

You can control and adjust this LCD Projection Monitor through the On-Screen Menu. Refer to the following pages to operate each adjustment on the On-Screen Menu.

- 1 Press the MENU button to display the On-Screen Menu (Main menu).
- 2 Select a menu from the main menu by pressing the Point Up / Down button, and press the Point Right button to enter the sub-menu. (The selected icon turns yellow.)
- 3 Select an item by pressing the Point Up / Down button, and activate the item that you have selected with the  (SELECT),  (Point Left), or  (Point Right) button.
- 4 Press the MENU button to close the On-Screen Menu when you are in the main menu. When you are in the sub-menu, press the MENU button once to return to the main menu or hold the MENU button for more than 2 seconds to close the On-Screen Menu.

Remote Control

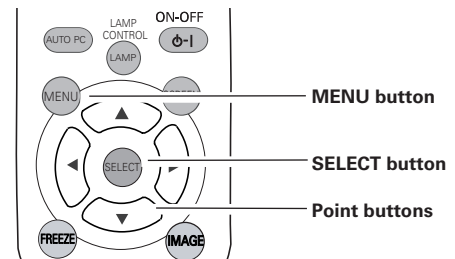

Front Panel

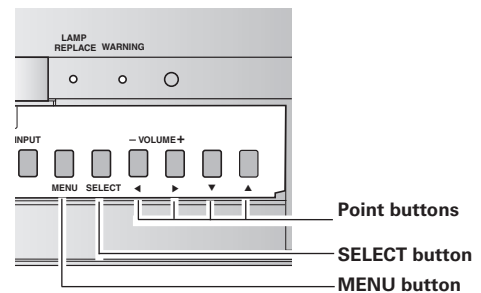

On-Screen Menu (Main Menu)

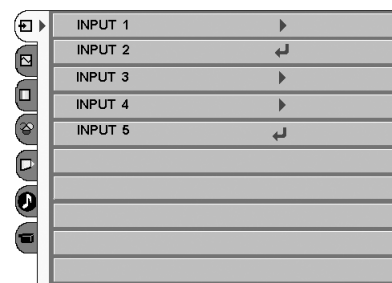

On-Screen Menu (Sub-Menu)

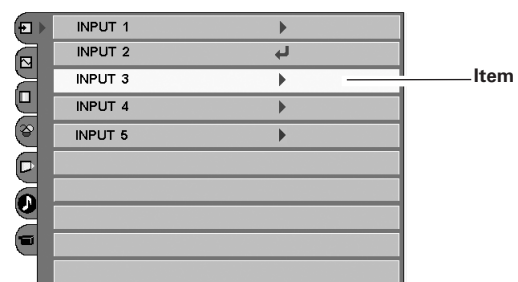







NOTE:









- If you are selecting a sub-menu or an item displayed in a line, pressing the MENU button takes you back to the previous On-Screen Menu.
- The On-Screen Menu disappears by holding down the MENU button for a while whatever you are selecting.

Menus

VIDEO MENUS

	Input Menu: select video input source. (p25-27)
	AV System Menu: select video system from Auto, PAL, SECAM, NTSC4.43, NTSC, 1080i, 720p, 575p, 480p, 575i and 480i. (p28)
	Image Select Menu: select image level from Standard, Cinema1, Cinema2, Game, Dynamic and Image. (p29)
	Image Adjust Menu: adjust Contrast, Brightness, Color, Tint, Color temp., White balance (R/G/B), Sharpness, Gamma or Auto grayscale and use Reset or Store. (p30, 31)
	Screen Menu: set the screen size from Full, Zoom, Caption in, Normal and Natural wide. (p32)
	Audio Adjust Menu: adjust Treble, Bass or Balance and use Reset or Store. (p24)
	Setting Menu: change various settings: Language, Blue back, Display, Background color, Menu position, No operation shut off timer, Remote control, On start, Power management, Lamp control, Lamp counter reset and Factory default. (p42-44)

COMPUTER MENUS

	Input Menu: select computer input source. (p33-34)
	PC System Menu: select computer system. (p35)
	PC Adjust Menu: select Auto PC adj., Fine sync, Total dots, Horizontal, Vertical, Current mode, Clamp, Display area, Display area H, Display area V, and use Reset, Mode free and Store. (p36-38)
	Image Select Menu: select image level from Standard, Real, Dynamic and Image. (p39)
	Image Adjust Menu: adjust Contrast, Brightness, Color temp., White balance (R/G/B), Sharpness or Gamma and use Reset or Store. (p40)
	Screen Menu: set the screen size from Normal, Full, True and Digital zoom. (p41)
	Audio Adjust Menu: adjust Treble, Bass or Balance and use Reset or Store. (p24)
	Setting Menu: change various settings: Language, Blue back, Display, Background color, Menu position, No operation shut off timer, Remote control, On start, Power management, Lamp control, Lamp counter reset and Factory default. (p42-44)

Audio Adjustment

Menu Operation

- 1 Select the Audio Adjustment menu with the Point Up / Down button, and then press the Point Right button to enter the sub-menu.
- 2 Select an item with the Point Up / Down button and press the Point Left / Right button to adjust the item.

Treble

Press the Point Left button to decrease high frequency sound, and the Point Right button to increase high frequency sound. (From -30 to +30)

Bass

Press the Point Left to decrease low frequency sound, and the Point Right button to increase low frequency sound. (From -30 to +30)

Balance

Press the Point Left / Right button to adjust the balance of the left and right speakers. (From L30 to R30)

Reset

To reset the adjusted data, select Reset and press the Point Right button. A confirmation box will appear and then select [Yes]. All adjustments return to their previous figures.

Store

To store the adjusted data, select Store and press the Point Right button. A confirmation box will appear and then select [Yes]. Stored data can be called up by selecting "Personal" in the Audio Selection on page 19.

Audio Adjust Menu

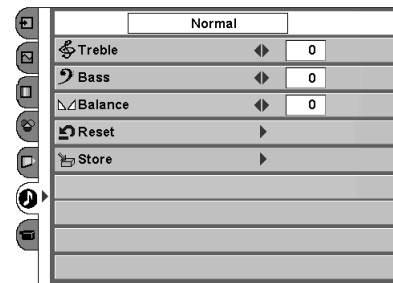

The audio mode being selected

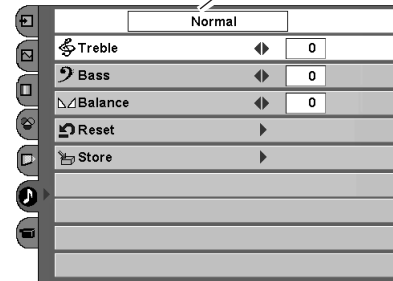

Press the SELECT button or the Point Up / Down button to adjust the next item. Press the MENU button to return to the previous On-Screen Menu and store the adjusted value.

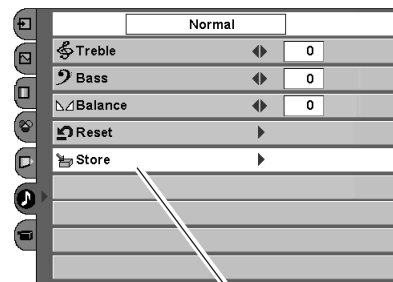

Press the Point Right button at this icon to store the value.

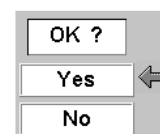

A confirmation box will appear and select [Yes] and press the SELECT button.

Video Input

Input Source Selection (INPUT 3 / RGB, Video (Video conference), Component)

Direct Operation

Select INPUT 3 by pressing the INPUT 3 button on the remote control or pressing the INPUT button on the front panel arbitrary number of times.

Before using these buttons, correct input source should be selected through menu operation as described below.

See p16-17 for the connection diagrams.

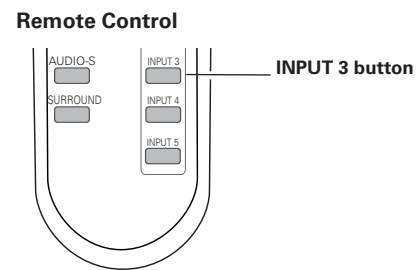
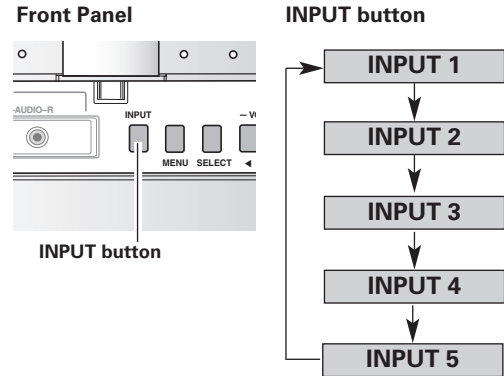

Menu Operation

- 1 Select the Input Menu with the Point Up / Down button, and then press the Point Right button to enter the sub-menu.
- 2 Select INPUT 3 with the Point Up / Down button and then press the SELECT button or the Point Right button. The Source Selection Menu will appear.
- 3 Move the pointer to the source that you want to select and then press the SELECT button.

NOTE:

- Select RGB when the input source is analog coming from a computer through the R, G, B, H/V, V jacks.

Input Menu

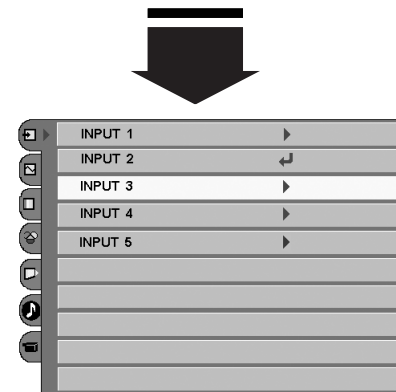
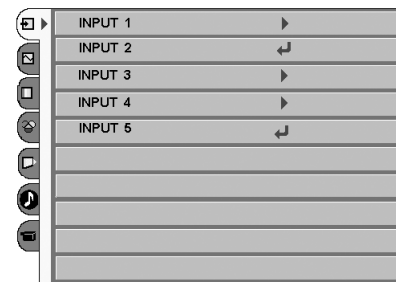

Source Selection Menu

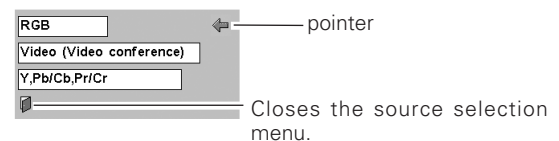

Input Source Selection (INPUT 4 / Video (Video conference), S-video, Component)

Direct Operation

Select INPUT 4 by pressing the INPUT 4 button on the remote control or pressing the INPUT button on the front panel arbitrary number of times.

Before using these buttons, correct input source should be selected through menu operation as described below.

See p16-17 for the connection diagrams.

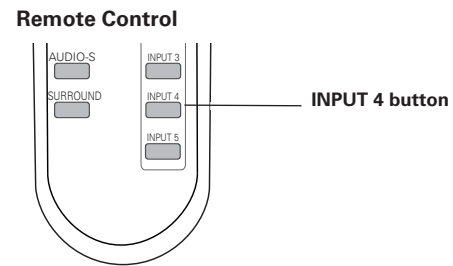
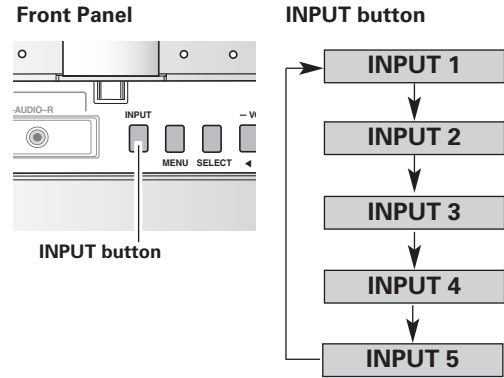

Menu Operation

- 1 Select the Input Menu with the Point Up / Down button, and then press the Point Right button to enter the sub-menu.
- 2 Select INPUT 4 with the Point Up / Down button and then press the SELECT button or the Point Right button. The Source Selection Menu will appear.
- 3 Move the pointer to the source that you want to select and then press the SELECT button.

When selecting AUTO, the LCD Projection Monitor automatically selects the connected input source.

NOTE:

- LCD Projection Monitor selects the input source in the following priority.
 1. Y, Pb/Cb, Pr/Cr
 2. S-video
 3. Video (Video conference)

Input Menu

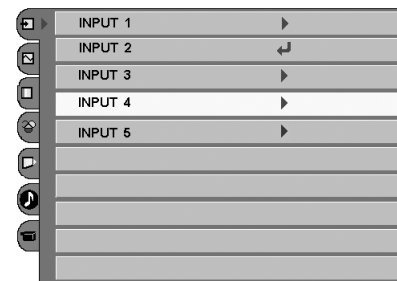
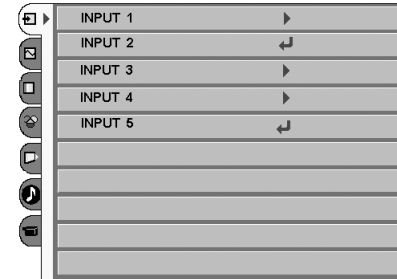

Source Selection Menu

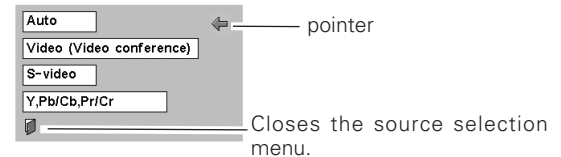

Input Source Selection (INPUT 5 / Video (Video conference))

Direct Operation

Select INPUT 5 by pressing the INPUT 5 button on the remote control or pressing the INPUT button on the front panel arbitrary number of times.

See p17 for the connection diagrams.

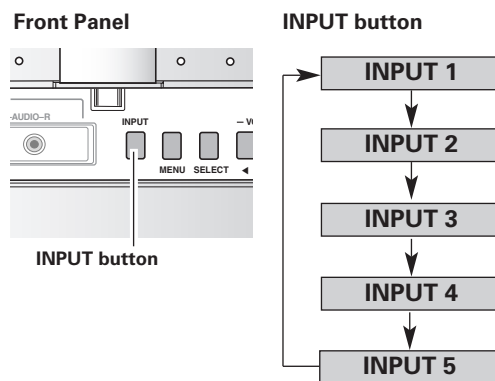

Remote Control

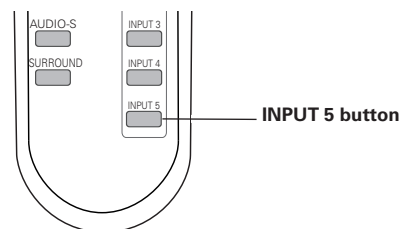

Menu Operation

- 1 Select the Input Menu with the Point Up / Down button, and then press the Point Right button to enter the sub-menu.
- 2 Select INPUT 5 with the Point Up / Down button and then press the SELECT button.

Input Menu

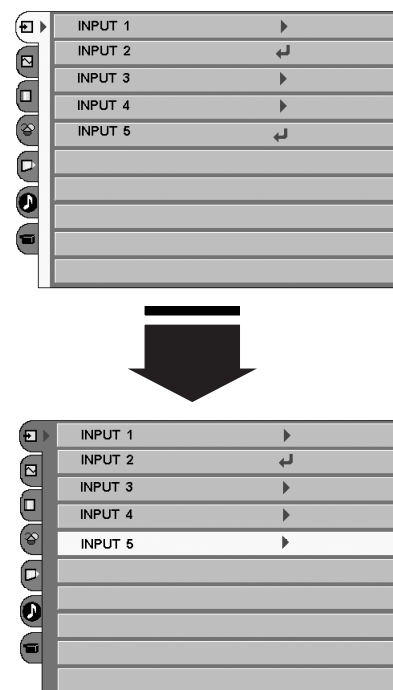

Video System Selection

Menu Operation

- 1 Select the AV System Menu with the Point Up / Down button, and then press the Point Right button to enter the sub-menu.
- 2 Choose the system that you want to select with the Point Up / Down button and then press the SELECT button.

AV System Menu (Video or S-Video)

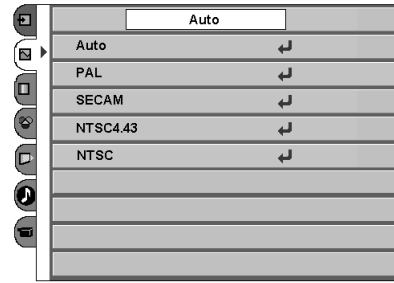

Video or S-Video Input

Auto

The LCD Projection Monitor automatically detects incoming video system, and adjusts itself to optimize its performance.

PAL / SECAM / NTSC4.43 / NTSC

If the LCD Projection Monitor cannot reproduce proper video image, it is necessary to select a specific video signal format among PAL, SECAM, NTSC4.43 and NTSC.

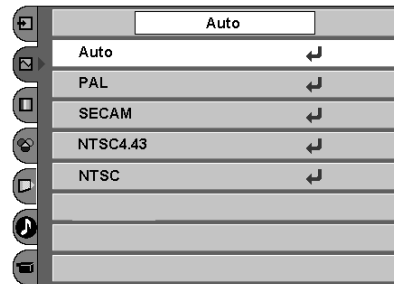

Component Input

Auto

The LCD Projection Monitor automatically detects incoming component video signal, and adjusts itself to optimize its performance.

Component Video Signal Format

If the LCD Projection Monitor cannot reproduce proper video image, it is necessary to select a specific component video signal format among 480i, 575i, 480p, 575p, 720p, and 1080i.

AV System Menu (Component)

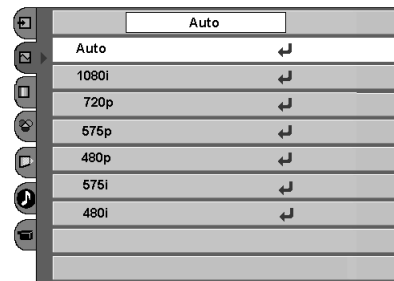

Image Level Selection

Direct Operation

Select an image level among Standard, Cinema1, Cinema2, Game, Dynamic, and Image by pressing the IMAGE button on the remote control.

Standard

Normal picture level preset on this LCD Projection Monitor.

Cinema1

Picture level adjusted for the bright picture with fine tone.

Cinema2

Picture level adjusted for the dark picture with fine tone.

Game

Picture level suitable for playing a game.

Dynamic

Picture level suitable for projecting the picture in a bright room.

Image

User preset image in the Image Level Adjustment. (p30, 31)

Remote Control

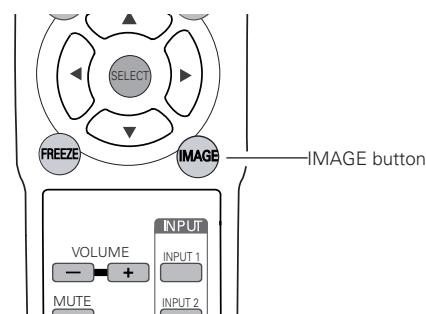

Menu Operation

- 1 Select the Image Select Menu with the Point Up / Down button, and then press the Point Right button to enter the sub-menu.
- 2 Choose the level that you want to select with the Point Up / Down button and then press the SELECT button.

Standard

Normal picture level preset on this LCD Projection Monitor.

Cinema1

Picture level adjusted for the bright picture with fine tone.

Cinema2

Picture level adjusted for the dark picture with fine tone.

Game

Picture level suitable for playing a game.

Dynamic

Picture level suitable for projecting the picture in a bright room.

Image

User preset image in the Image Level Adjustment. (p30, 31)

Image Select Menu

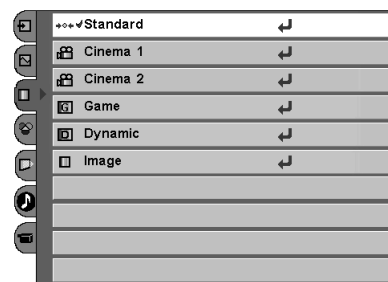
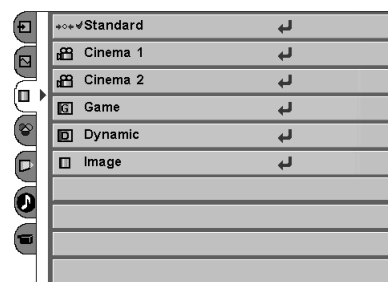

Image Level Adjustment

- 1 Select the Image Adjust Menu with the Point Up / Down button, and then press the Point Right button to enter the sub-menu.
- 2 Select an item with the Point Up / Down button and press the Point Left / Right button to adjust the item.



Contrast

Press the Point Left button to decrease contrast and the Point Right button to increase contrast. (From -31 to +31)



Brightness

Press the Point Left button to adjust image darker and the Point Right button to adjust image brighter. (From -31 to +31)



Color

Press the Point Left button to lighten color and the Point Right button to deepen color. (From -31 to +31)



Tint

Press the Point Left / Right button to obtain proper color. (From -31 to +31)



Color temp.

Press the Point Left / Right button for Color temperature level that you want to select. (Low3, Low2, Low1 Mid, High)



White balance (Red)

Press the Point Left button to lighten red tone and the Point Right button to deepen red tone. (From -31 to +31)



White balance (Green)

Press the Point Left button to lighten green tone and the Point Right button to deepen green tone. (From -31 to +31)



White balance (Blue)

Press the Point Left button to lighten blue tone and the Point Right button to deepen blue tone. (From -31 to +31)

Image Adjust Menu



The Image level being selected (p29)

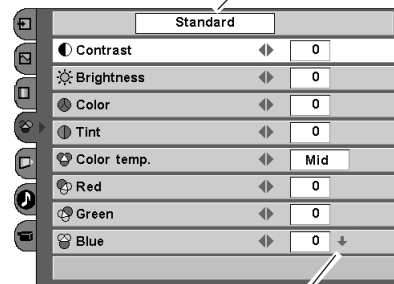

This arrow indicates that there are other items. Select this item and press the Point Down button to go to the next item.



Press the SELECT button or the Point Up / Down button to adjust the next item. Press the MENU button to return to the previous On-Screen Menu and store the adjusted value.

Go on to the next page...

NOTE:

- Tint cannot be selected when the video system is PAL or SECAM except for 575i.

Sharpness

Press the Point Left button to soften the image and the Point Right button to sharpen the image. (From -7 to +7)

Gamma

Press the Point Left / Right button to obtain better balance of contrast. (From -7 to +7)

Auto grayscale

Press the Point Left / Right button to switch On / Off. When this function is "On", it automatically enhances contrast of bright and dark part of image.

Reset

To reset the adjusted data, select Reset and press the Point Right button. A confirmation box will appear and then select [Yes]. All adjustments return to their previous figures.

Store

To store the adjusted data, select Store and press the Point Right button. A confirmation box will appear and then select [Yes]. Stored data can be called up by selecting "Image" in the Image Level Selection on page 29.

NOTE:

- The adjusted parameters will be stored in "Image" on the Image Level Selection. (p29)

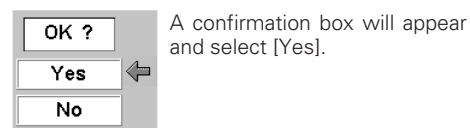
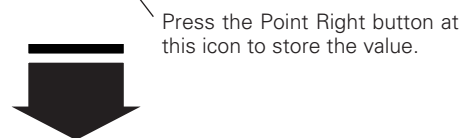
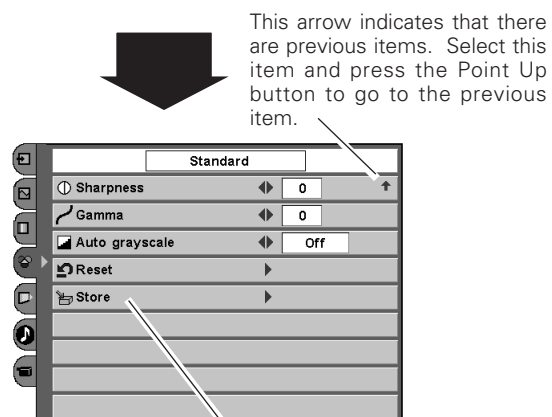

Screen Size Adjustment

Direct Operation

You can resize a projected screen with the SCREEN button on the remote control.

Menu Operation

This LCD Projection Monitor has a useful function to resize a projected screen.

- 1 Select the Screen Menu with the Point Up / Down button then press the Point Right button to enter the sub-menu.
- 2 Select an item with the Point Up / Down button and press the SELECT button to set the screen size.

Full

Provide an image to fit the width of the screen by expanding the width of the image uniformly. This function can be used to project a squeezed video signal at a wide video aspect ratio of 16 : 9. When your video equipment (such as DVD) has 16 : 9 output mode, select 16 : 9 and select Full in this Screen Menu to provide better quality.

Zoom

Provide an image to fit the screen size (16 : 9 aspect ratio) by expanding the width and height of the image uniformly. This function can be used to project a letter box mode picture (4 : 3 aspect picture with black bar on the top and bottom edges) at a wide video aspect ratio of 16 : 9.

Caption in

Provide an image including a caption to fit the screen size (16 : 9 aspect ratio) by expanding the width and height of the image uniformly.

Normal

Provide an image at a normal video aspect ratio of 4 : 3.

Natural wide

Modify an image of 4 : 3 aspect ratio to fit the screen size (16 : 9 aspect ratio). It expands the width and height of the image and makes it look natural.

NOTE:

- Screen Menu cannot be selected when 720p or 1080i is selected in the Video System Selection (p28).

Remote Control

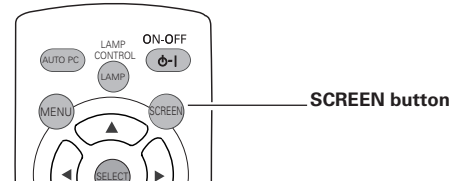

Screen Menu

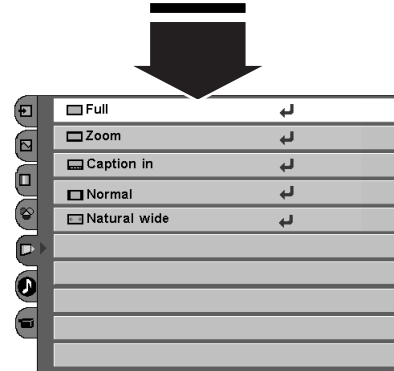
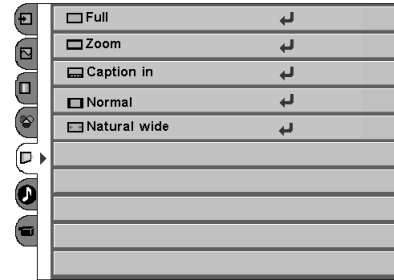

Full

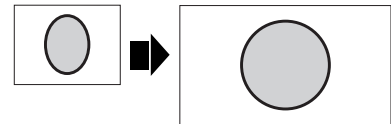

Zoom

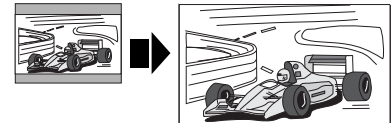

Caption in

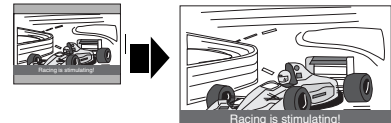

Normal

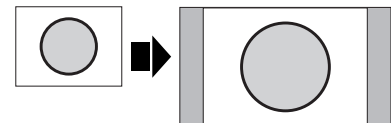

Natural wide

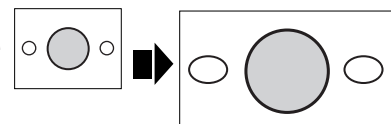

Computer Input

Input Source Selection (INPUT 1 / PC digital, AV HDCP)

Direct Operation

Select INPUT 1 by pressing the INPUT 1 button on the remote control or pressing the INPUT button on the front panel arbitrary number of times.

Before using these buttons, correct input source should be selected through menu operation as described below.

See p16-17 for the connection diagrams.

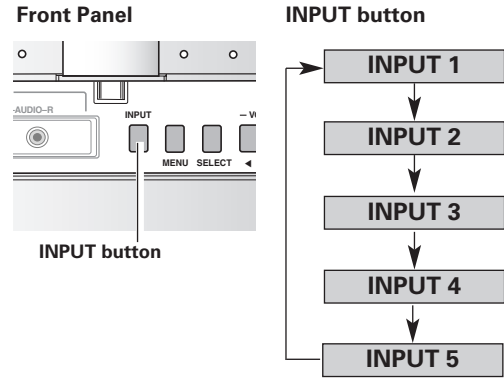

Remote Control

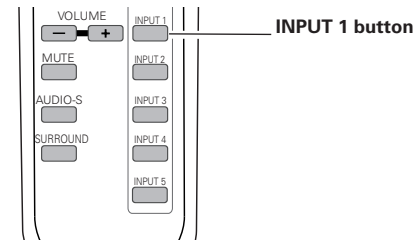

Menu Operation

- 1 Select the Input Menu with the Point Up / Down button, and then press the Point Right button to enter the sub-menu.
- 2 Select INPUT 1 with the Point Up / Down button and then press the SELECT button or the Point Right button. The Source Selection Menu will appear.
- 3 Move the pointer to the source that you want to select and then press the SELECT button.

Input Menu

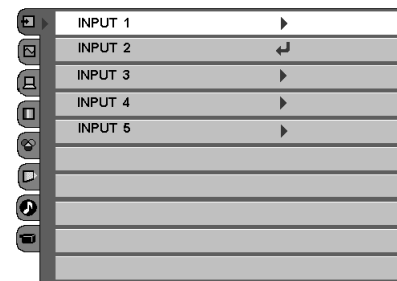
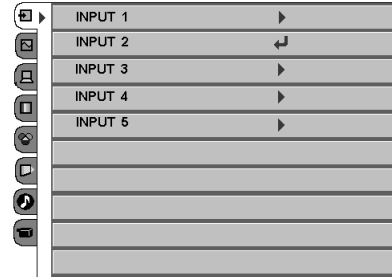

Source Selection Menu

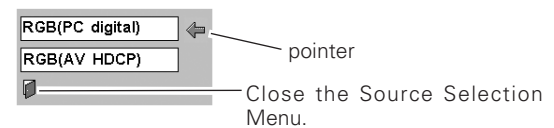

NOTE:

- HDCP (High-bandwidth Digital Content Protection) is a system for protecting digital entertainment content delivered by DVI (Digital Visual Interface) from being copied. The specification of HDCP is decided and controlled by Digital Content Protection, LLC. Should the specification be changed, this LCD Projection Monitor may not display the digital content protected by HDCP.

Input Source Selection (INPUT 2 / PC analog)

Direct Operation

Select INPUT 2 by pressing the INPUT 2 button on the remote control or pressing the INPUT button on the front panel arbitrary number of times.

See p16 for the connection diagrams.

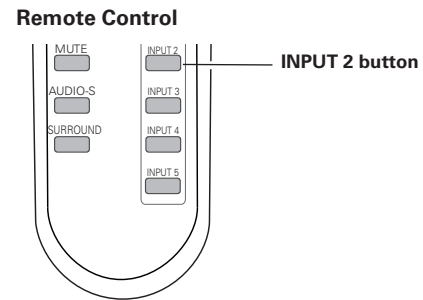
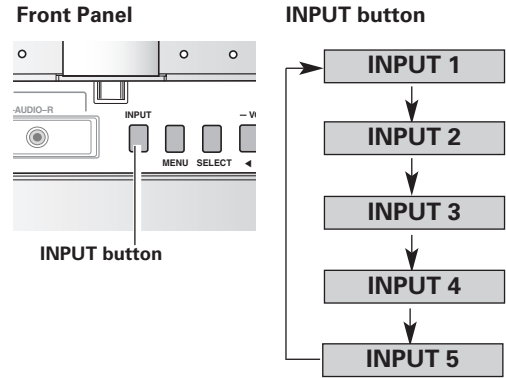

Menu Operation

- 1 Select the Input Menu with the Point Up / Down button, and then press the Point Right button to enter the sub-menu.
- 2 Select INPUT 2 with the Point Up / Down button and then press the SELECT button.

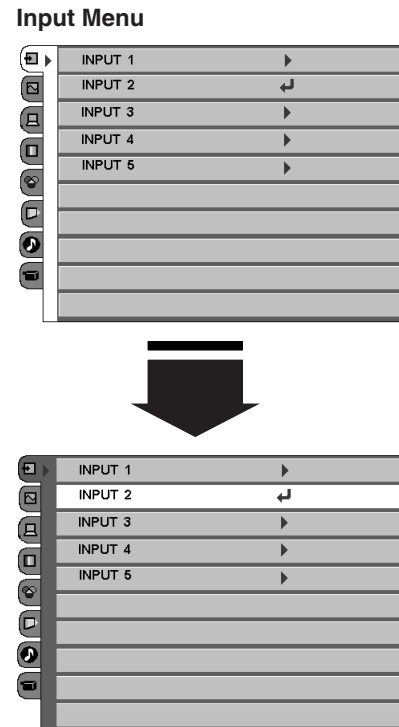

Computer System Selection

This LCD Projection Monitor can detect most of the current computer systems with the Multi-scan system and the Auto PC adjustment function provided in the LCD Projection Monitor. When selecting computer input, the LCD Projection Monitor automatically displays the most proper image for the input signal. One of the following four displays appears on the system menu icon. If the LCD Projection Monitor does not tune the input signal and the projected image is not displayed properly, or when you wish to adjust it manually, perform manual adjustment as described on page 37-38.

Auto When the LCD Projection Monitor cannot recognize the connected signal as PC system provided in this LCD Projection Monitor, the Auto PC Adjustment function operates to adjust the LCD Projection Monitor and the message "Auto" is displayed in the PC System Menu icon. When the image is not provided properly, manual adjustment is required. (p37-38)

---- There is no signal input from the connected computer. Check the connection of the computer and see if the LCD Projection Monitor is set correctly. (See "Troubleshooting" on page 50.)

Mode 1 User preset adjustment in Computer Adjustment. Adjustment data can be stored in Mode 1 - 5. (p37-38)

SVGA 1 Computer systems provided in the LCD Projection Monitor. The LCD Projection Monitor chooses a proper system and displays it.

*Mode 1 and SVGA 1 are examples.

Computer System Menu

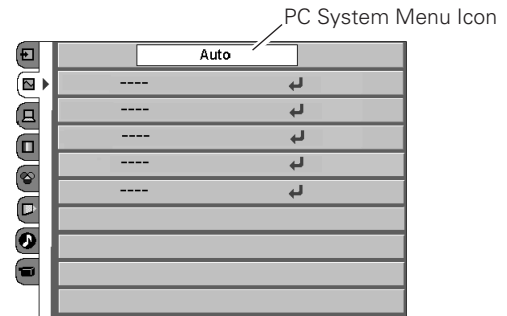

Menu Operation

Computer system can also be selected manually if some Computer systems appear on the On-Screen Menu.

- 1** Select the Computer System Menu with the Point Up / Down button, and then press the Point Right button to enter the sub-menu.
- 2** Choose the system that you want to select with the Point Up / Down button and then press the SELECT button.

Computer System Menu

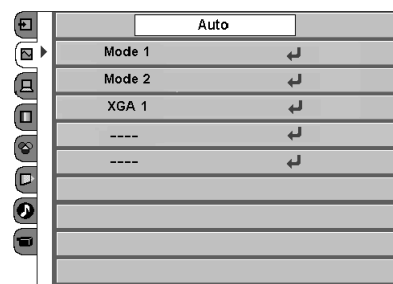

Computer Adjustment (Auto)

The Auto PC adjustment function is provided to automatically adjust Fine sync, Total dots, Horizontal, and Vertical to conform to your computer. This function can be operated as follows.

Direct Operation

The Auto PC adjustment function can be operated directly by pressing the AUTO PC button on the remote control.

Remote Control

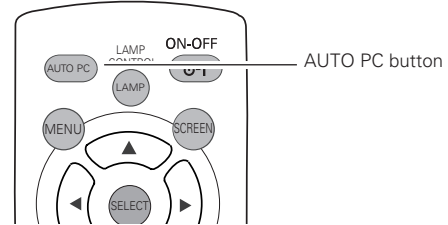

Menu Operation

- 1 Select the PC adjust Menu with the Point Up / Down button, and then press the Point Right button to enter the sub-menu.
- 2 Choose the Auto PC adj. item and then press the SELECT button.

Auto PC Adj.

Automatically adjusts Fine sync, Total dots, Horizontal, and Vertical for the input signal from your computer.

To store adjustment data

Adjustment parameters from Auto PC adjustment can be memorized in this LCD Projection Monitor. Once parameters are memorized, the setting can be done just by selecting Mode in the Computer System Selection. (p35) See "Store" on page 38.

PC Adjust Menu

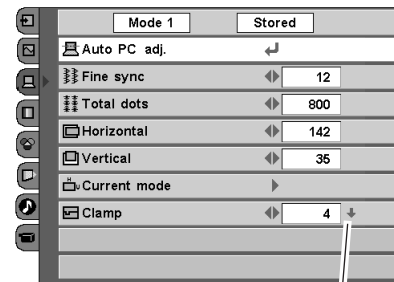
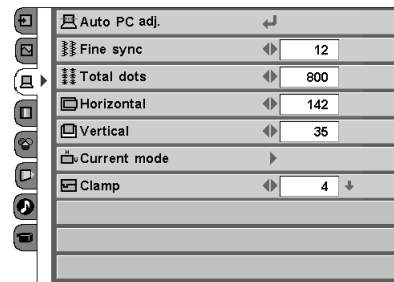

This arrow indicates that there are other items. Select this item and press the Point Down button to go to the next item.

NOTE

- The PC Adjust Menu cannot be operated when the input signal is digital or a signal compatible with HDCP.
- The Auto PC adjust cannot be operated when 480i, 575i, 480p, 575p, 720p, or 1080i is selected in the Computer System Selection. (p35)

Computer Adjustment (Manual)

Some computers employ special signal formats which may not be tuned by Multi-scan system of this LCD Projection Monitor. This LCD Projection Monitor has Manual PC Adjustment to enable you to precisely adjust several parameters to match those signal formats. The LCD Projection Monitor has 5 independent memory areas to memorize those parameters manually adjusted. This enables you to recall the setting for a specific computer whenever using it.

- 1 Select the PC Adjust Menu with the Point Up / Down button, and then press the Point Right button to enter the sub-menu.
- 2 Select an item with the Point Up / Down button and press the Point Left / Right button to adjust each item.

Fine sync

Adjust an image as necessary to eliminate flicker from the display. Press the Point Left / Right button to adjust value. (From 0 to 31)

Total dots

Adjust the number of total dots in one horizontal period. Press the Point Left / Right button and adjust number to match your PC image.

Horizontal

Adjust the horizontal picture position. Press the Point Left / Right button to adjust the position.

Vertical

Adjust the vertical picture position. Press the Point Left / Right button to adjust the position.

Current mode

Press the Point Right button to show the information of the connected computer.

Clamp

Adjust the clamp level. When the image has dark bars, try this adjustment. Press the Point Left / Right button to adjust the clamp level.

PC Adjust Menu

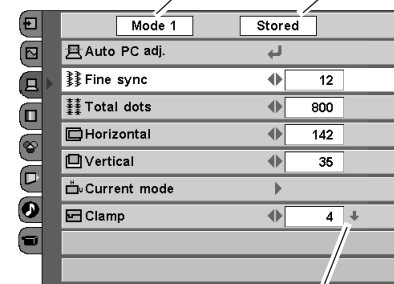
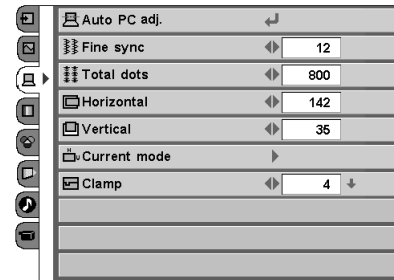

Shows status (Stored / Free) of the selected Mode.



This arrow indicates that there are other items. Select this item and press the Point Down button to go to the next item.



Press the SELECT button or the Point Up / Down button to adjust the next item. Press the MENU button to return to the previous On-Screen Menu and store the adjusted value.

Go on to the next page...

Display area

Press the SELECT button to display the Display area dialog box. Select the resolution at the Display area dialog box.

Display area H

Adjust the horizontal area displayed by this LCD Projection Monitor. Press the Point Left / Right button to decrease / increase value and then press the SELECT button.

Display area V

Adjust the vertical area displayed by this LCD Projection Monitor. Press the Point Left / Right button to decrease / increase value and then press the SELECT button.

Reset

To reset the adjusted data, select Reset and press the Point Right button. A confirmation box will appear and then select [Yes]. All adjustments return to their previous figures.

Mode free

To clear adjusted data previously set, select Mode free and press the Point Right button. The dialog box will appear and choose one of 5 modes and then press the SELECT button.

Store

To store adjusted data, select Store and press the Point Right button. The dialog box will appear and choose one of 5 modes and then press the SELECT button.



When selecting Display area, this dialog box appears.

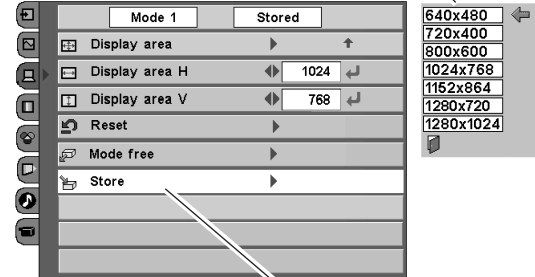

Select Store to store the adjusted data.

To clear adjusted data

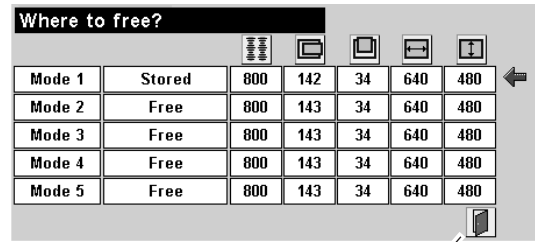

Close this dialog box.

To store adjusted data

This Mode has parameters being stored.

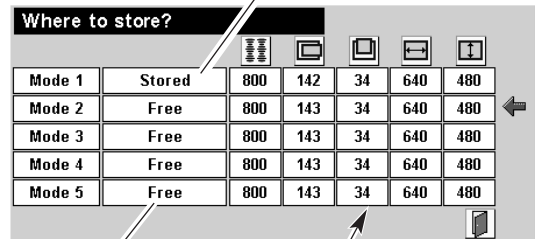

Vacant Mode

Show the values of "Total dots," "Horizontal," "Vertical," "Display area H," and "Display area V."

NOTE:

- Display area and Display area (H/V) cannot be selected when 480i, 575i, 480p, 575p, 720p, or 1080i is selected in the Computer System Selection. (p35)

Image Level Selection

Direct Operation

Select an image level among Standard, Real, Dynamic, and Image by pressing the IMAGE button on the remote control.

Standard

Normal picture level preset on this LCD Projection Monitor.

Real

Picture level with improved halftone for graphics.

Dynamic

Picture level suitable for projecting the picture in a bright room.

Image

User preset image in the Image Level Adjustment. (p40)

Remote Control

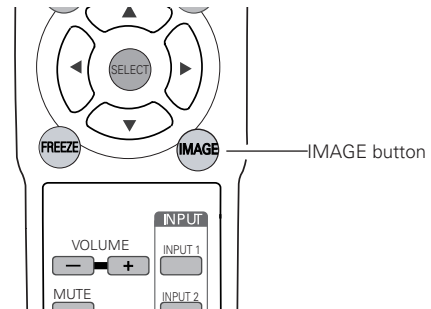

Menu Operation

- 1 Select the Image Select Menu with the Point Up / Down button, and then press the Point Right button to enter the sub-menu.
- 2 Choose the level that you want to select with the Point Up / Down button and then press the SELECT button.

Standard

Normal picture level preset on this LCD Projection Monitor.

Real

Picture level with improved halftone for graphics.

Dynamic

Picture level suitable for projecting the picture in a bright room.

Image

User preset image in the Image Level Adjustment. (p40)

Image Select Menu

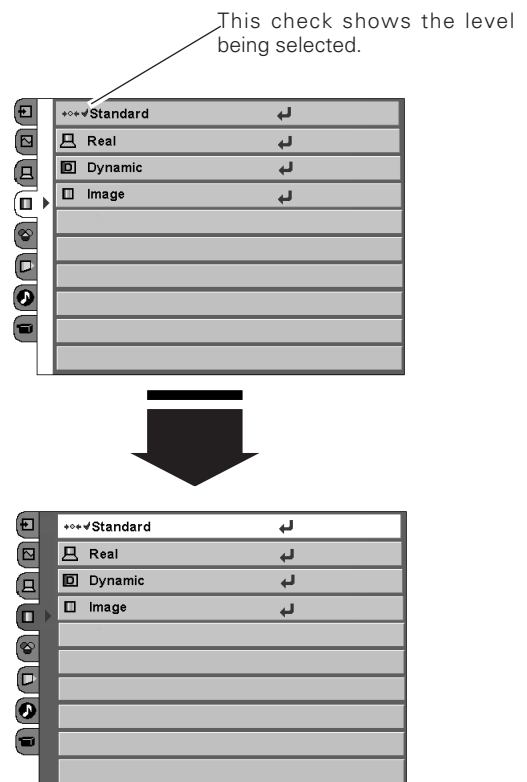

Image Level Adjustment

- 1 Select the Image Adjust Menu with the Point Up / Down button, and then press the Point Right button to enter the sub-menu.
- 2 Select an item with the Point Up / Down button and press the Point Left / Right button to adjust the item.

Contrast

Press the Point Left button to decrease contrast and the Point Right button to increase contrast. (From -31 to +31)

Brightness

Press the Point Left button to adjust image darker and the Point Right button to adjust image brighter. (From -31 to +31)

Color temp.

Press the Point Left / Right button for Color temperature level that you want to select. (Low3, Low2, Low1 Mid, High)

White balance (Red)

Press the Point Left button to lighten red tone and the Point Right button to deepen red tone. (From -31 to +31)

White balance (Green)

Press the Point Left button to lighten green tone and the Point Right button to deepen green tone. (From -31 to +31)

White balance (Blue)

Press the Point Left button to lighten blue tone and the Point Right button to deepen blue tone. (From -31 to +31)

Sharpness

Press the Point Left button to soften the image and the Point Right button to sharpen the image. (From -7 to +7)

Gamma

Press the Point Left / Right button to obtain better balance of contrast. (From -7 to +7)

Reset

To reset the adjusted data, select Reset and press the Point Right button. A confirmation box will appear and then select [Yes]. All adjustments return to their previous figures.

Store

To store the adjusted data, select Store and press the Point Right button. A confirmation box will appear and select [Yes]. Stored data can be called up by selecting "Image" in the Image Level Selection on page 39.

NOTE:

- The adjusted parameters will be stored in "Image" on the Image Level Selection. (p39)

Image Adjust Menu



The Image level being selected (p39)

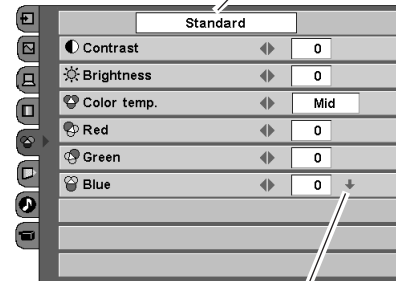

This arrow indicates that there are other item menus.



Press the SELECT button or the Point Up / Down button to adjust the next item. Press the MENU button to return to the previous On-Screen Menu and store the adjusted value.

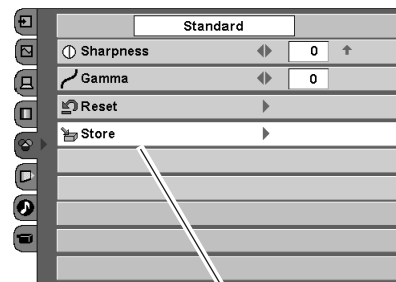

Press the Point Right button at this icon to store the value.

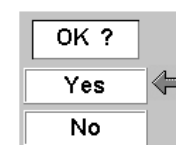

A confirmation box will appear and select [Yes].

Screen Size Adjustment

Direct Operation

You can resize a projected screen with the SCREEN button on the remote control.

Remote Control

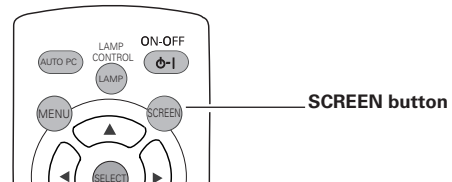

This LCD Projection Monitor has a useful function to resize a projected screen.

- 1 Select the Screen Menu with the Point Up / Down button, and then press the Point Right button to enter the sub-menu.
- 2 Select an item with the Point Up / Down button and press the SELECT button to set the screen size.

Screen Menu

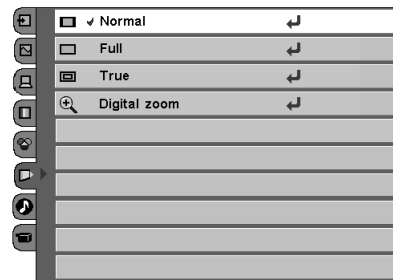
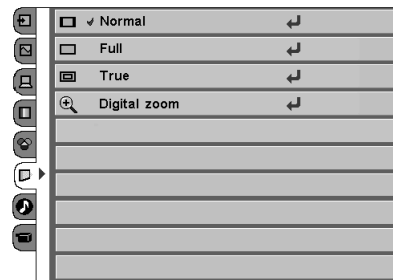

Normal

Provide image to fit screen size.

Full

Provide an image to fit the horizontal size of the screen.

True

Provide image in its original size. When the original image size is larger than the screen size (1280 x 720), this LCD Projection Monitor enters "Digital zoom" mode automatically.

Digital zoom

When Digital zoom is selected, the On-Screen Menu disappears and the message "D.zoom" is displayed. Press the SELECT button to expand the image. And press the Point **▲▼◀▶** buttons to pan the image. The panning function can work only when the original image is larger than screen size (1280 x 720).

To exit the Digital zoom mode, press the SCREEN button.

NOTE:

- This Screen Menu cannot be operated when 720p(HDCP) is selected in the Computer System Selection. (p35)
- The Normal and Digital zoom cannot be selected when 720p(HDTV) is selected in the Computer System Selection. (p35)
- The True and Digital zoom cannot be selected when 480i, 575i, 480p, or 575p is selected in the Computer System Selection. (p35)
- This LCD Projection Monitor cannot display any resolution higher than 1280 X 720. If your computer's screen resolution is higher than 1280 X 720, reset the resolution to the lower before connecting to the LCD Projection Monitor.
- The image data in other than the resolution (1280 x 720) is modified to fit the screen size in initial mode.

Setting

- 1 Select the Setting Menu with the Point Up / Down button, and then press the Point Right button to enter the sub-menu.
- 2 Select an item with the Point Up / Down button to set various settings.

Language

The language used in the On-Screen Menu is available in English, German, French, Italian, Spanish, Portuguese, Dutch and Swedish.

Blue back

When this function is "On," the LCD Projection Monitor projects a blue image on screen while no input signal is detected. Press the Point Left / Right button to switch On / Off.

Display

This function decides whether to display On-Screen Displays. Press the Point Left / Right button to switch On / Off.

- On show all the On-Screen Displays.
- Off do not show On-Screen Displays except;
 - On-Screen Menu
 - "No signal" message
 - "Please wait...!" message

Background color

This function is used to change the image of the On-Screen Menu display

Menu position

This function is used to change the position of the On-Screen Menu. Move it with the Point Up / Down / Left / Right button and press the SELECT button to set it.

No operation shut off timer

This function turns off the LCD Projection Monitor automatically when there is no operation of the remote control or the front panel for 3 hours.

While this function is "On" and no operation continues for 3 hours, the message "Set shut down" will be displayed for about 1 minute, and the LCD Projection Monitor will shut off automatically.(in stand-by mode)

Press the Point Left / Right button to switch On / Off.

Setting Menu (Language)

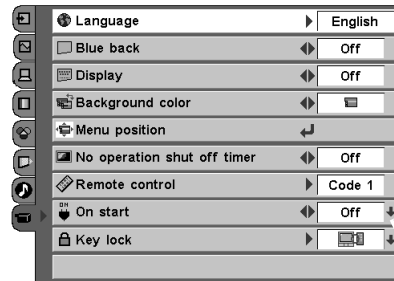
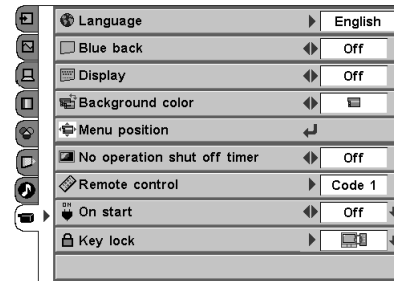



This arrow indicates that there are other items. Select this item and press the Point Down button to go to the next item.

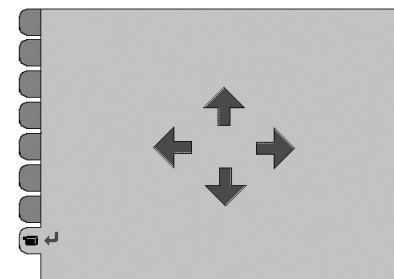

After selecting a language, move the pointer to this icon, and press the SELECT button to activate it.

Menu position



 **Remote control**

This LCD Projection Monitor provides eight different remote control codes (Code 1-Code 8); the factory-set, initial code (Code 1) and the other seven codes (Code 2 to Code 8). This switching function prevents remote control interference when operating several equipment at the same time.

The same code should set on both the LCD Projection Monitor and the remote control. For example, operating the LCD Projection Monitor in "Code 7", the remote control unit also must be switched to "Code 7".

To change the code for the LCD Projection Monitor:

Select a remote control code in this Setting Menu.

To change the code for the remote control:

While holding down the MENU button, press the IMAGE button number of times corresponding to the remote control code for the LCD Projection Monitor. (See page 14 for details.)

Remote control

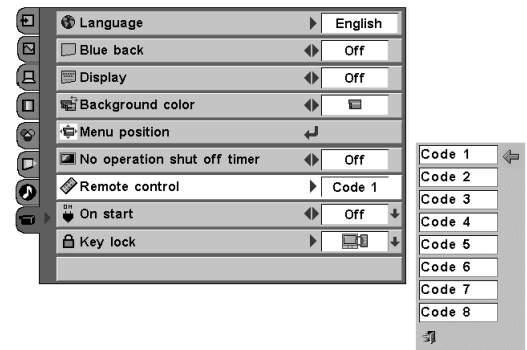

 **On start**





When this function is "On", the LCD Projection Monitor is automatically turned on just by connecting the AC power cord to a wall outlet. Press the Point Left / Right button to switch On / Off.

NOTE:

- When disconnecting the AC power cord without turning the LCD Projection Monitor off and with On start function "On", next time the LCD Projection Monitor will be turned on after completing the cool-down.

 **Key lock**

This function locks operation of the front controls and the remote control. It is useful to prevent operation by a third person.

-  Unlocked.
-  Lock the operation of the front controls.
To unlock, use the remote control.
-  Lock the operation of the remote control.
To unlock, use the front controls.
-  Lock the operation of both the front controls and the remote control.
To unlock, press the SELECT button on the front panel for more than 20 seconds. The ECO indicator blinks for 5 seconds and the lock will be released.

Key lock

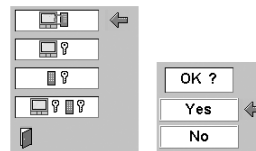
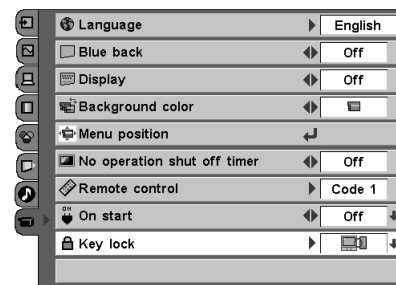

Select Key lock to display this box. Choose one of these with the Point ▲▼ buttons and select [Yes] to activate it.

Power management

For reducing power consumption as well as maintaining the lamp life, the Power management function turns off the projection lamp when the input signal is interrupted and no button is pressed for a certain period.

When the input signal is interrupted and no button is pressed for 30 seconds or more, the timer display with "No signal" message appears on the screen to start the countdown.

The following operation differs according to the selected mode.

Ready When the count-down time has elapsed, the lamp will be turned off and the POWER indicator slowly blinks green. When any signal is connected or any button on the remote control or the front panel is pressed, the projection lamp will be turned on again.

Shut down When the count-down time has elapsed, the lamp will be turned off and the POWER indicator emits orange light. When the lamp has been fully cooled down, the power will be turned off.

Off Power management function is off.

Power management

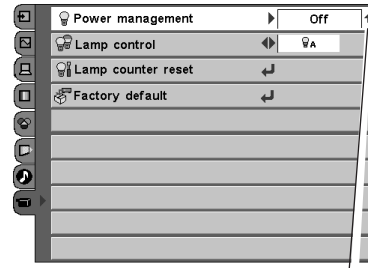

This arrow indicates that there are previous items. Select this item and press the Point Up button to go to the previous item.

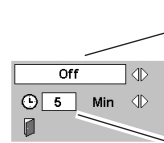

Press Point Left / Right button, to change the dialog Ready - Shutdown - Off.





Timer can be adjusted with Point Left / Right button between 1 to 30 Min.



Time left before lamp will be off

Lamp control

This function allows you to change brightness of the screen.





-  Auto.... the controlled brightness according to the input signal
-  Eco1.... the controlled brightness according to the ambient light
-  Eco2.... 80% lower brightness than normal brightness and reduces the lamp power consumption.
-  Normal.... normal brightness

NOTE:

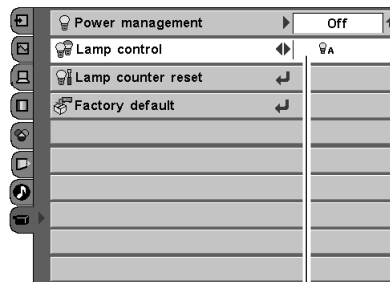
- You can also select a lamp mode with the LAMP CONTROL button on the remote control. (p 20)

Lamp control



Press the Point Left / Right button, to change the dialog  -  -  - 

Lamp counter reset

This function is used to reset the Lamp replace counter. When replacing the projection lamp, reset the Lamp replace counter by using this function. See page 48 for operation.

Factory default

This function returns all setting values except for the lamp counter to the factory default settings.

Factory default

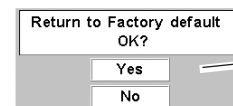
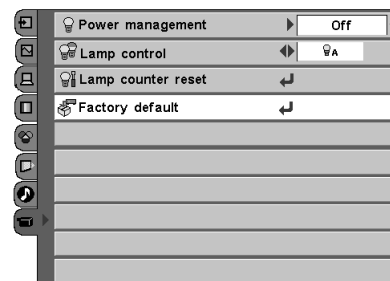

Select Factory default and this box appears. Select [Yes] , and the next box appears.

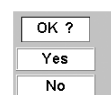

Select [Yes] to activate it.

Maintenance and Cleaning

Warning Indicator

The WARNING indicator shows the state of the function which protects the LCD Projection Monitor. Check the state of the WARNING indicator and the POWER indicator to take proper maintenance.

The LCD Projection Monitor is shut down and the WARNING indicator is blinking red

When the temperature inside the LCD Projection Monitor exceeds the normal temperature, the LCD Projection Monitor is automatically shut down to protect the LCD Projection Monitor. The POWER indicator is blinking red and the LCD Projection Monitor is being cooled down. When the temperature inside the LCD Projection Monitor returns to normal, the POWER indicator emits red light and the LCD Projection Monitor can be turned on.

NOTE:

- Even after the temperature inside the LCD Projection Monitor returns to normal, the WARNING indicator may keep blinking. The WARNING indicator stops blinking when the LCD Projection Monitor is turned on again.

Then check the items below.

- ✓ Did you provide appropriate space for the LCD Projection Monitor to be ventilated? Check the installing condition to see if ventilation slots are not blocked.
- ✓ Is the LCD Projection Monitor not installed near the ventilation duct of air-conditioning equipment which may be hot? Install the LCD Projection Monitor away from the ventilation duct of air-conditioning equipment.
- ✓ Is the air filter clean? Clean the air filter or replace it with a new one.

The LCD Projection Monitor is shut down and the WARNING indicator emits red light

When the LCD Projection Monitor detects an abnormal condition, it is automatically shut down to protect the inside and the WARNING indicator emits red light. In this case, disconnect the AC power cord and reconnect it, and then turn the LCD Projection Monitor on once again for check. If the LCD Projection Monitor is turned off again and the WARNING indicator emits red light, disconnect the AC power cord and contact the service station for check and repair.



CAUTION

DO NOT LEAVE THE LCD PROJECTION MONITOR WITH THE AC POWER CORD CONNECTED UNDER THE ABNORMAL CONDITION. IT MAY RESULT IN FIRE OR ELECTRIC SHOCK.

Front Panel

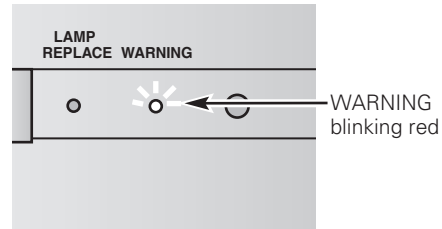

Front Panel

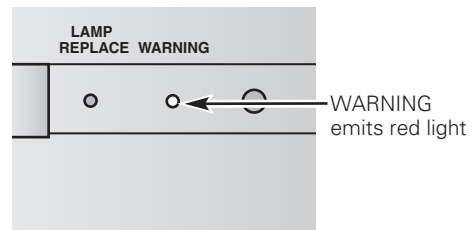

Cleaning the Air Filter

The Air Filter prevents dust from accumulating on the optical elements inside the LCD Projection Monitor. Should the Air Filter become clogged with dust particles, it will reduce the cooling fans' effectiveness and may result in internal heat building up and effect on the life of the LCD Projection Monitor.

To clean the Air Filter, follow the cleaning procedures below:

- 1 Turn off the LCD Projection Monitor and disconnect the AC power cord from the AC outlet.
- 2 Remove the Right front cover of the LCD Projection Monitor.
 - a. Hold right upper side of the cover and slightly pull forward.
 - b. Hold both sides of the cover and remove it.
- 3 Push downward with a forefinger on the Air Filter Holder and pull the Air Filter Holder off the LCD Projection Monitor.
- 4 Remove the Air Filter from the Air Filter Holder, and clean the Air Filter with a brush or a vacuum cleaner.
If the Air Filter is clogged extremely or broken, replace it with a new one.
- 5 Fit the Air Filter back in the Air Filter Holder and then replace it to the LCD Projection Monitor. Make sure that the Air Filter fits the place where it should be.
- 6 Replace the right front cover to the LCD Projection Monitor.

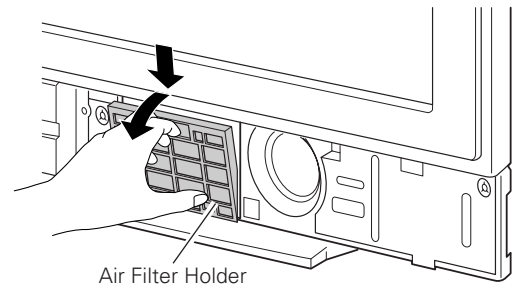
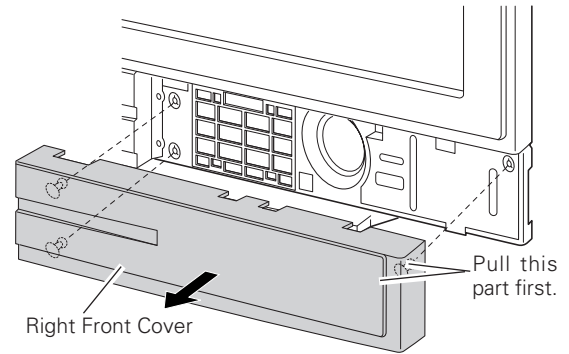

CAUTION

Do not operate the LCD Projection Monitor with the Air Filter removed. The dust is stuck in the LCD Projection Monitor and it may degrade the clear picture reproduction performance.

RECOMMENDATION

We recommend avoiding dusty / smoky environments when operating the LCD Projection Monitor. When using under dusty or smoky conditions, dust may accumulate on the optical elements inside the LCD Projection Monitor and the screen surface. This condition may degrade the quality of a projected image. When the above symptoms are noticed, contact your authorized dealer or service station for proper cleaning.

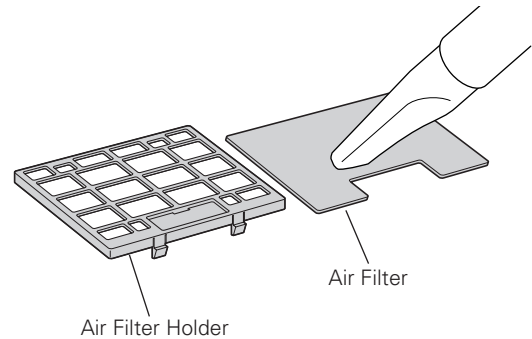

Cleaning the LCD Projection Monitor

Be sure to disconnect the AC Power cord from the AC outlet before cleaning the LCD Projection Monitor.

- Gently wipe the screen and the cabinet with a soft dry clean cloth.
- When it is heavily soiled, wipe the screen and the cabinet with a soft cloth dampened with warm water and finish with a soft, dry clean cloth.



CAUTION

DO NOT USE BENZENE, THINNER, OR ANY VOLATILE SUBSTANCES TO CLEAN THE LCD PROJECTION MONITOR. THESE CHEMICALS MAY CAUSE DAMAGE TO THE PRODUCT.

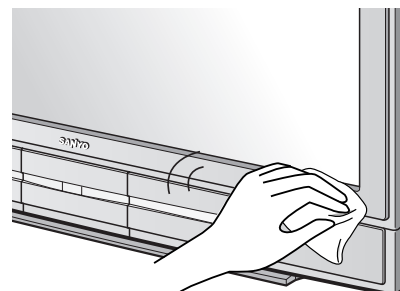

Lamp Replacement

When the life of the projection lamp of this LCD Projection Monitor draws to an end, the LAMP REPLACE indicator emits orange light. If this indicator emits orange light, replace the lamp with a new one promptly.

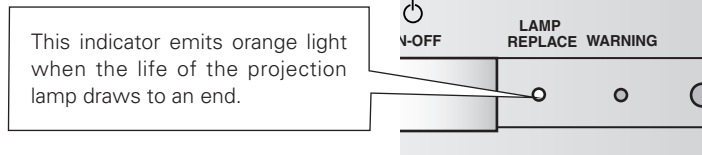

CAUTION

Allow the LCD Projection Monitor to cool, for at least 30 minutes before you open the Lamp cover. The inside of the LCD Projection Monitor can become very hot.



CAUTION

For continued safety, replace with a lamp of the same type. Do not drop the lamp or touch the glass bulb! The glass can shatter and may cause injury.

Follow these steps to replace the lamp assembly.

- 1** Turn off the LCD Projection Monitor and disconnect the AC plug. Allow the LCD Projection Monitor to cool for at least 30 minutes.
- 2** Remove the Left front cover of the LCD Projection Monitor.
 - a. Hold left upper side of the cover and slightly pull forward.
 - b. Hold both sides of the cover and remove it.
- 3** Loosen 4 screws that secure the Lamp Cover with a screwdriver and remove the Lamp Cover.
- 4** Loosen the 2 screws that secure the lamp with a screwdriver and pull out the Lamp by grasping the handle.
- 5** Replace the Lamp with a new one and tighten the 2 screws. Make sure that the Lamp is correctly secured into the Lamp compartment. Refer to p49 for ordering the replacement lamp.
- 6** Put the Lamp Cover back and tighten the 4 screws and then replace the Left front cover.
- 7** Connect the AC Power Cord to the LCD Projection Monitor and turn on the LCD Projection Monitor.
- 8** **Reset the Lamp replace counter.**
See "Lamp Replace Counter" on the next page .

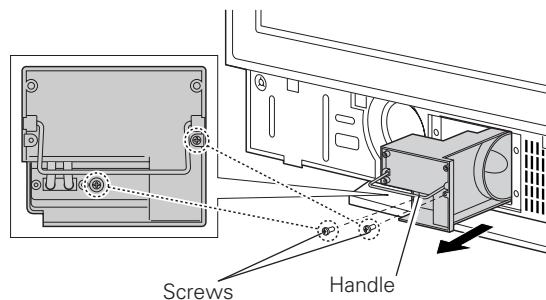
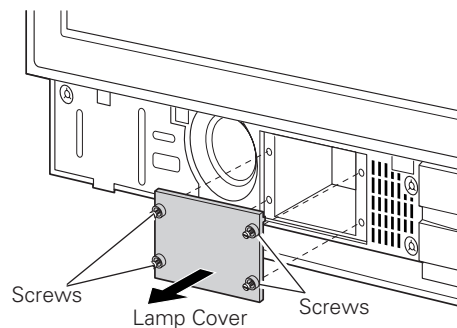
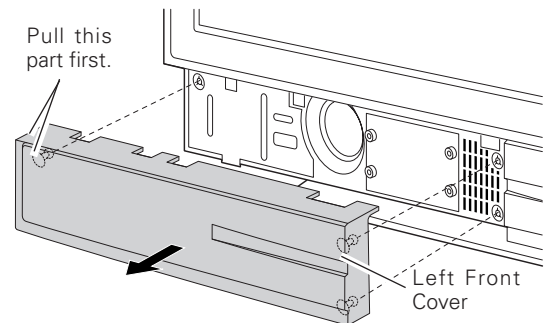

CAUTION

When installing the new Lamp into the Lamp compartment, make sure the Lamp socket is securely plugged into the compartment socket. Improper or loosen socket connection may cause arc discharge resulting fire hazard.

Lamp Replace Counter

Be sure to reset the Lamp replace counter after the lamp is replaced. When the Lamp replace counter is reset, the LAMP REPLACE indicator stops emitting.

- 1 Turn the LCD Projection Monitor on, press the MENU button, and the On-Screen Menu will appear. Select the Setting Menu with the Point Up / Down button and press the Point Right button to enter the sub-menu.
- 2 Select the Lamp counter reset item and then press the SELECT button. The message "Lamp replace counter reset?" is displayed. Choose [Yes] and then press the SELECT button.
- 3 Another confirmation dialog box appears and choose [Yes] to reset the Lamp replace counter.

NOTE:

- Do not reset the Lamp replace counter without implementation of lamp replacement. Be sure to reset the Lamp replace counter only after replacing the lamp.

Lamp counter reset

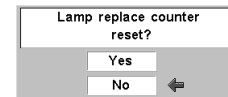
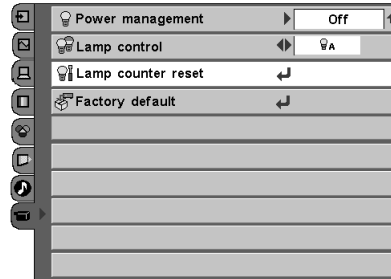



LAMP HANDLING PRECAUTIONS

This LCD Projection Monitor uses a high-pressure lamp which must be handled carefully and properly. Improper handling may result in accidents, injury, or create a fire hazard.

- Lamp lifetime may differ from lamp to lamp and according to the environment of use. There is no guarantee of the same lifetime for each lamp. Some lamps may fail or terminate their lifetime in a shorter period of time than other similar lamps.
- If the LCD Projection Monitor indicates that the lamp should be replaced, i.e., if the LAMP REPLACE indicator lights up, replace the lamp with a new one IMMEDIATELY after the LCD Projection Monitor has cooled down.
(Follow carefully the instructions in the Lamp Replacement section of this manual.) Continuous use of the lamp with the LAMP REPLACE indicator lighted may increase the risk of lamp explosion.
- A Lamp may explode as a result of vibration, shock or degradation as a result of hours of use as its lifetime draws to an end. Risk of explosion may differ according to the environment or conditions in which the LCD Projection Monitor and lamp are being used.

IF A LAMP EXPLODES, THE FOLLOWING SAFETY PRECAUTIONS SHOULD BE TAKEN.

If a lamp explodes, disconnect the LCD Projection Monitor’s AC plug from the AC outlet immediately. Contact an authorized service station for a checkup of the unit and replacement of the lamp. Additionally, check carefully to ensure that there are no broken shards or pieces of glass around the LCD Projection Monitor or coming out from the cooling air circulation holes. Any broken shards found should be cleaned up carefully. No one should check the inside of the LCD Projection Monitor except those who are authorized trained technicians and who are familiar with LCD Projection Monitor service. Inappropriate attempts to service the unit by anyone, especially those who are not appropriately trained to do so, may result in an accident or injury caused by pieces of broken glass.

ORDER REPLACEMENT LAMP

Replacement lamp can be ordered through your dealer. When ordering a projection lamp, give the following information to the dealer.

- **Model No. of your LCD Projection Monitor** : **PLV-55WM1**
- **Replacement Lamp Type No.** : **POA-LMP76A**
(Service Parts No. 610 318 7266)

Troubleshooting

Before calling your dealer or service center for assistance, check the items below once again.

- Make sure you have properly connected the LCD Projection Monitor to peripheral equipment as described in "Connecting to a Computer and Video Equipment" and "Connecting to Video Equipment" on page 16 and 17.
- Make sure all equipment is connected to AC outlet and the power is turned on.
- When you operate the LCD Projection Monitor with a computer and it does not project an image, restart the computer.

Problem:	- Try these solutions.
No power	<ul style="list-style-type: none">- Plug the power cord of the LCD Projection Monitor into the AC outlet.- Check the WARNING indicator. If the WARNING indicator emits red light, the LCD Projection Monitor cannot be turned on. (See "Warning Indicator" on page 45.)- Check if the front controls and/or the remote control is locked with Keylock function. (p43)
No sound	<ul style="list-style-type: none">- Check audio cable connection from audio input source.- Adjust the audio source.- Press the Vol + button.- Press the Mute button.
No image	<ul style="list-style-type: none">- Check the connection between video equipment or your computer and the LCD Projection Monitor.- See if the input signal is correctly output from your computer. Some laptop computers may need changing the setting for monitor output when you are connecting a laptop computer. See your computer's owner's manual for setting.- It takes about 30 seconds to display an image after turning on the LCD Projection Monitor.- See if the selected system is corresponding with video equipment or your computer.- Select correct input source once again through menu operation.- Make sure the temperature is not out of the operating temperature 41°F ~ 95°F (5 °C ~ 35 °C).
Poor or dark image	<ul style="list-style-type: none">- Adjust Brightness in the Image Adjust menu.- Check the lamp mode. In Eco1 or Eco2 mode, the picture may become less brighter than in Normal mode.
Some displays are not seen during the operation.	<ul style="list-style-type: none">- Check the Display item. (See "Setting" on page 42.)
The Remote Control does not work.	<ul style="list-style-type: none">- Check the batteries. (p13)- Make sure no obstruction is between the LCD Projection Monitor and remote control.- Make sure you are not too far from the LCD Projection Monitor when using the remote control. Maximum operating range is 16.4' (5m). (p13)- Make sure the code of the remote control is conformed to that of the LCD projection Monitor. (p14, 43)- Check if the remote control is locked with Keylock function. (p43)

























WARNING :







High voltages are used to operate this LCD Projection Monitor. Do not attempt to open the cabinet.

If problems still persist after following all operating instructions, contact the dealer where you purchased the LCD Projection Monitor or the service center. Give the model number and explain about the problem. We will advise you how to obtain service.

Indicators and Condition of the LCD Projection Monitor

Check the indicators for LCD Projection Monitor condition.

Indicators			LCD Projection Monitor Condition
POWER red/green/ orange	WARNING red	LAMP REPLACE orange	
			The LCD Projection Monitor is OFF. (The AC power cord is unplugged.)
			The LCD Projection Monitor is ready to be turned on with the POWER ON-OFF button. The cooling fans are stopped.
			The LCD Projection Monitor can be turned on with the POWER ON-OFF button. The cooling fans are running.
			The LCD Projection Monitor is operating normally.
			Blink slowly: The LCD Projection Monitor is in the Power management mode. Blink rapidly: The LCD Projection Monitor is turned on from the stand-by mode.
			The temperature inside the LCD Projection Monitor is abnormally high. The LCD Projection Monitor cannot be turned on. When the LCD Projection Monitor has cooled down enough and the temperature returns to normal, the POWER indicator emits red light and the LCD Projection Monitor can be turned on. (The WARNING indicator keeps blinking.) Check and clean the Air Filter.
			The LCD Projection Monitor has been cooled down enough and the temperature returns to normal. When turning on the LCD Projection Monitor, the WARNING indicator stops blinking. Check and clean the Air Filter.
			The LCD Projection Monitor detects an abnormal condition and cannot be turned on. Unplug the AC power cord and plug it again to turn on the LCD Projection Monitor. If the LCD Projection Monitor is turned off again, disconnect the AC power cord and contact the dealer or the service center for service and checkup. Do not leave the LCD Projection Monitor on. It may cause an electric shock or a fire hazard.

 ••• emits green.
  ••• emits red.
  ••• emits orange.
  ••• off
 ••• blinks green.
  ••• blinks red.

*When the life of the projection lamp draws to an end, the LAMP REPLACE indicator emits orange light. When this indicator emits orange light, replace the projection lamp with a new one promptly. Reset the Lamp replace counter after replacement of the lamp. See page 47-48.

Menu Tree

Video / Computer Input

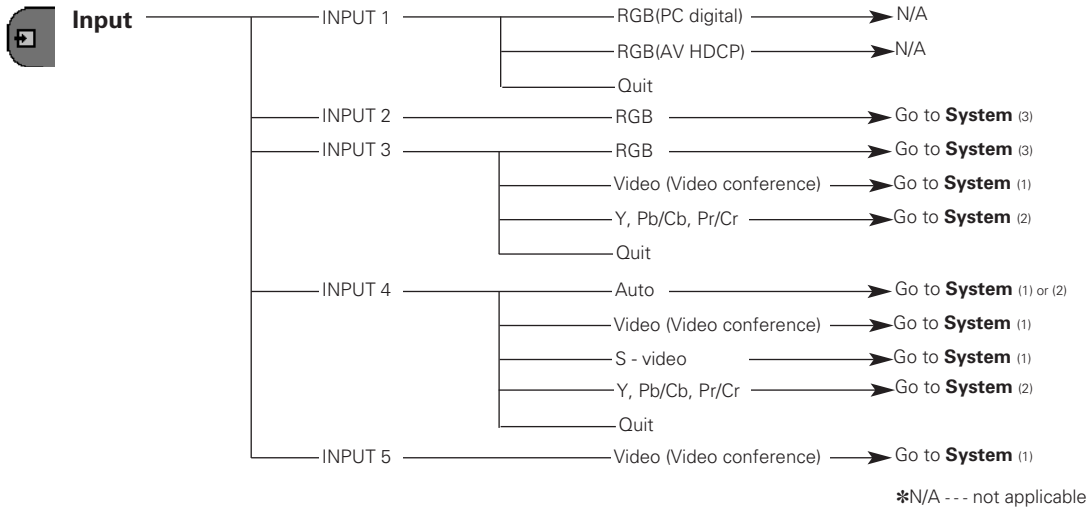

Video Input

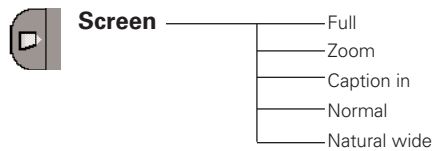
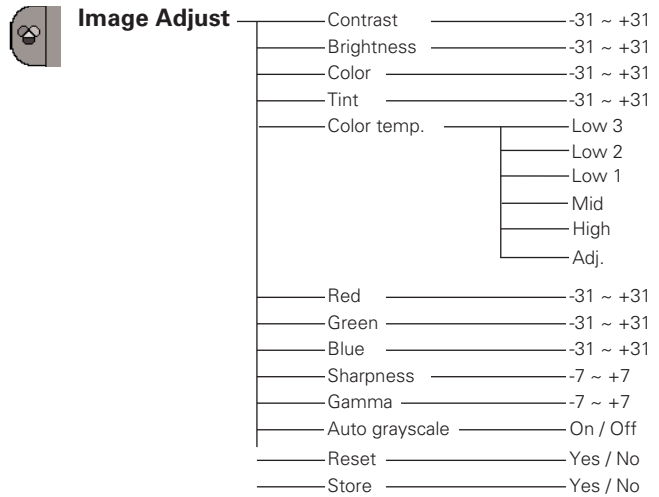
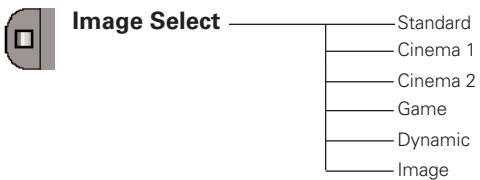
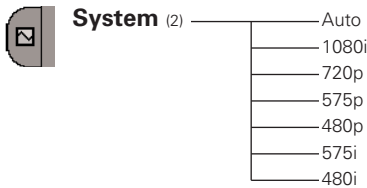
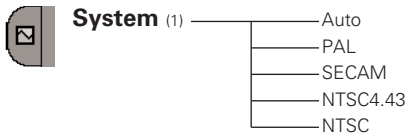

Computer Input

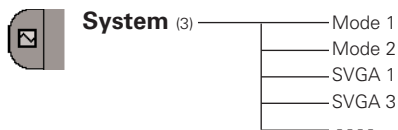

*Systems displayed in the System Menu vary depending on an input signal.

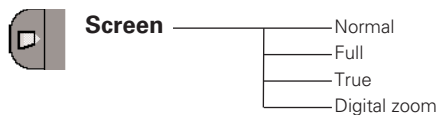
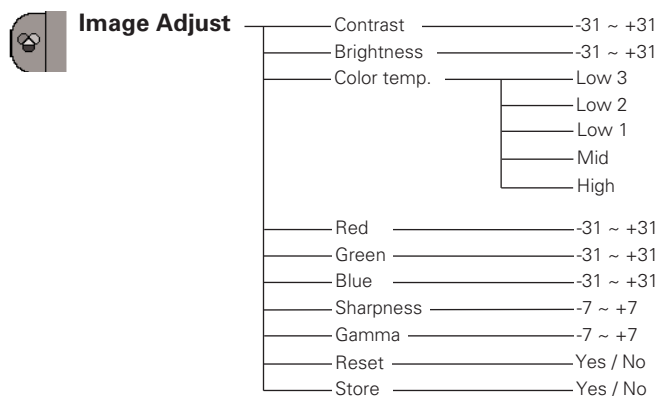
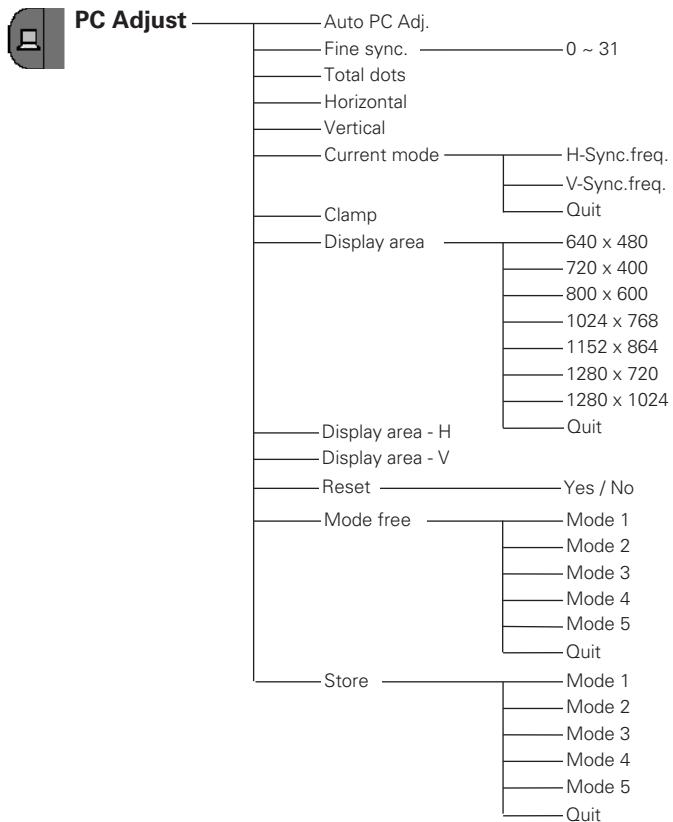

Video / Computer Input

Audio

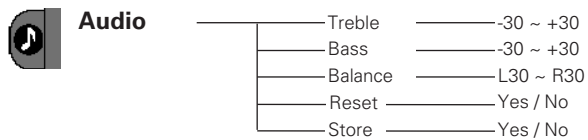

Setting

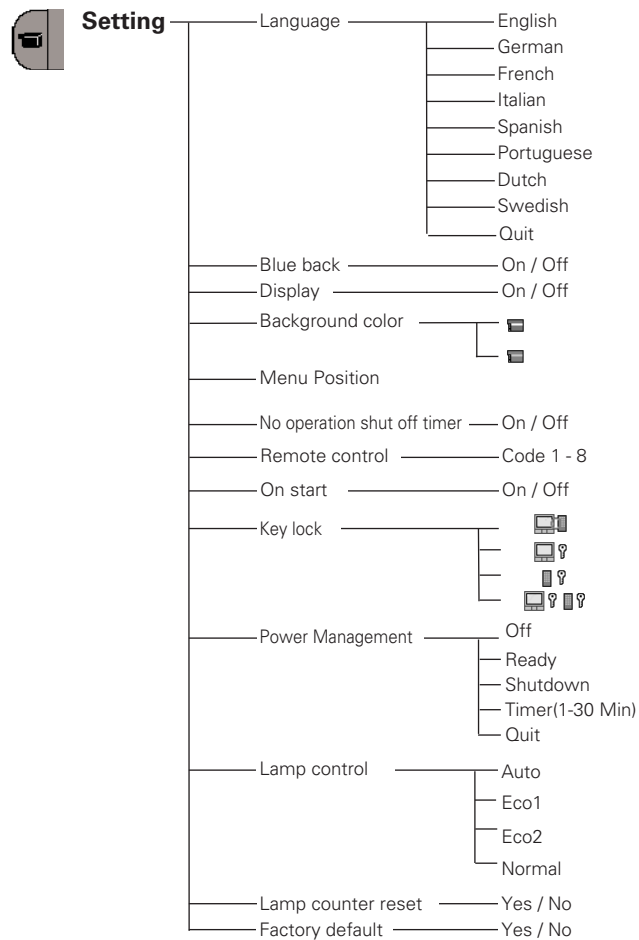

Compatible Computer Specifications

Basically this LCD Projection Monitor can accept the signal from all computers with the V, H-Frequency below mentioned and less than 100 MHz of Dot Clock.

ON-SCREEN DISPLAY	RESOLUTION	H-Freq. (kHz)	V-Freq. (Hz)	ON-SCREEN DISPLAY	RESOLUTION	H-Freq. (kHz)	V-Freq. (Hz)
VGA 1	640 x 480	31.47	59.88	XGA 4	1024 x 768	56.476	70.07
VGA 2	720 x 400	31.47	70.09	XGA 5	1024 x 768	60.31	74.92
VGA 3	640 x 400	31.47	70.09	XGA 6	1024 x 768	48.50	60.02
VGA 4	640 x 480	37.86	74.38	XGA 7	1024 x 768	44.00	54.58
VGA 5	640 x 480	37.86	72.81	XGA 8	1024 x 768	63.48	79.35
VGA 6	640 x 480	37.50	75.00	XGA 9	1024 x 768	36.00	87.17 (Interlace)
VGA 7	640 x 480	43.269	85.00	XGA 10	1024 x 768	62.04	77.07
MAC LC13	640 x 480	34.97	66.60	XGA 11	1024 x 768	61.00	75.70
MAC 13	640 x 480	35.00	66.67	XGA 12	1024 x 768	35.522	86.96 (Interlace)
575i	————	15.625	50.00 (Interlace)	XGA 13	1024 x 768	46.90	58.20
480i	————	15.734	60.00 (Interlace)	XGA 14	1024 x 768	47.00	58.30
SVGA 1	800 x 600	35.156	56.25	XGA 15	1024 x 768	58.03	72.00
SVGA 2	800 x 600	37.88	60.32	MAC 19	1024 x 768	60.24	75.08
SVGA 3	800 x 600	46.875	75.00	MAC 21	1152 x 870	68.68	75.06
SVGA 4	800 x 600	53.674	85.06	SXGA 1	1152 x 864	64.20	70.40
SVGA 5	800 x 600	48.08	72.19	SXGA 11	1152 x 900	61.20	65.20
SVGA 6	800 x 600	37.90	61.03	SXGA 13	1280 x 1024	50.00	86.00 (Interlace)
SVGA 7	800 x 600	34.50	55.38	SXGA 14	1280 x 1024	50.00	94.00 (Interlace)
SVGA 8	800 x 600	38.00	60.51	SXGA 17	1152 x 900	61.85	66.00
SVGA 9	800 x 600	38.60	60.31	SXGA 18	1280 x 1024	46.43	86.70 (Interlace)
SVGA 10	800 x 600	32.70	51.09	480p	————	31.47	59.88
SVGA 11	800 x 600	38.00	60.51	575p	————	31.25	50.00
MAC 16	832 x 624	49.72	74.55	720p	————	45.00	60.00
XGA 1	1024 x 768	48.36	60.00	1080i	————	33.75	60.00 (Interlace)
XGA 2	1024 x 768	68.677	84.997	1080i	————	28.125	50.00 (Interlace)
XGA 3	1024 x 768	60.023	75.03				

When an input signal is digital from DVI terminal, refer to the chart below.

ON-SCREEN DISPLAY	RESOLUTION	H-Freq. (kHz)	V-Freq. (Hz)	ON-SCREEN DISPLAY	RESOLUTION	H-Freq. (kHz)	V-Freq. (Hz)
D-VGA	640 x 480	31.47	59.94	D-SXGA 2	1280 x 1024	60.276	58.069
D-480p	————	31.47	59.88	D-SXGA 3	1280 x 1024	31.65	29.80
D-575p	————	31.25	50.00	D-720p	————	45.00	60.00
D-SVGA	800 x 600	37.879	60.32	D-1080i	————	33.75	60.00 (Interlace)
D-XGA	1024 x 768	43.363	60.00	D-1080i	————	28.125	50.00 (Interlace)

Technical Specifications

Projector Type	LCD Projection Monitor	
Dimensions (W x H x D)	1,352mm (W) x 940mm (H) x 408mm (D)	
Net Weight	40.0 kg	
LCD Panel System	0.7" wide TFT Active Matrix type, 3 panels	
Panel Resolution	1280 x 720 dots	
Number of Pixels	2,764,800 (1280 x 720 x 3 panels)	
Color System	PAL, SECAM, NTSC, and NTSC4.43	
High Definition TV Signal	480i, 480p, 575i, 575p, 720p, and 1080i	
Scanning Frequency	H-sync. 15 ~ 100 KHz, V-sync. 50 ~ 100 Hz	
Screen Size (Diagonal)	55"	
Built-in Speakers / Sound Adjust	ø 100 mm x 2 speakers, 15W +15W (RMS)	
Projection Lamp	150 W	
Computer Input	INPUT 1	DVI-D Terminal (Digital) (HDCP compatible) Audio – RCA Type x 2
	INPUT 2	Analog RGB (Mini D-sub 15 pin) x 1 Audio – Mini Jack(Stereo)
Video Input	INPUT 3	Video – BNC Type x 5 (Video (Video conference) / Y,Pb/Cb,Pr/Cr / R,G,B,H/V,V) Audio – RCA Type x 2
	INPUT 4	Video – RCA Type x 3 (Video (Video conference) / Y,Pb/Cb,Pr/Cr) Mini DIN 4 pin x 1 (S-video) Audio – RCA Type x 2
	INPUT 5	Video – RCA Type (Video (Video conference)) Audio – RCA Type x 2
Output	Analog RGB (Mini D-sub 15 pin) x 1 Audio – Mini Jack(Stereo)	
Other Connector	Serial port (Mini D-sub 9 pin) x 1, PJ-Net organizer Connector (Mini D-sub 25 pin) x 1	
Voltage and Power Consumption	AC100 ~ 120V, 3.0A, 50/60Hz AC200 ~ 240V, 1.5A, 50/60Hz	
Operating Temperature	41°F ~ 95°F (5 °C ~ 35 °C)	
Storage Temperature	14°F ~ 140°F (-10 °C ~ 60 °C)	
Remote Control	Battery : AA, UM3 or LR06 1.5V ALKALINE Type x 2 Operating Range : 16.4' (5m) / ±30° Dimensions : 1.97" x 1.06" x 6.61" (50mm x 27mm x 168mm) Net Weight : 4.4oz (126g) (including batteries)	
Accessories	Owner's Manual AC Power Cord Remote Control and Batteries Tip-Resistant Safety Parts (Holder and Screw(4mm x 12mm))	

- The specifications are subject to change without notice.
- LCD panels are manufactured to the highest possible standards. Even though 99.99% of the pixels are effective, a tiny fraction of the pixels (0.01% or less) may be ineffective by the characteristics of the LCD panels.
- The On-Screen Menu and figures in this manual may differ slightly from the product.

Dimensions

Measurement

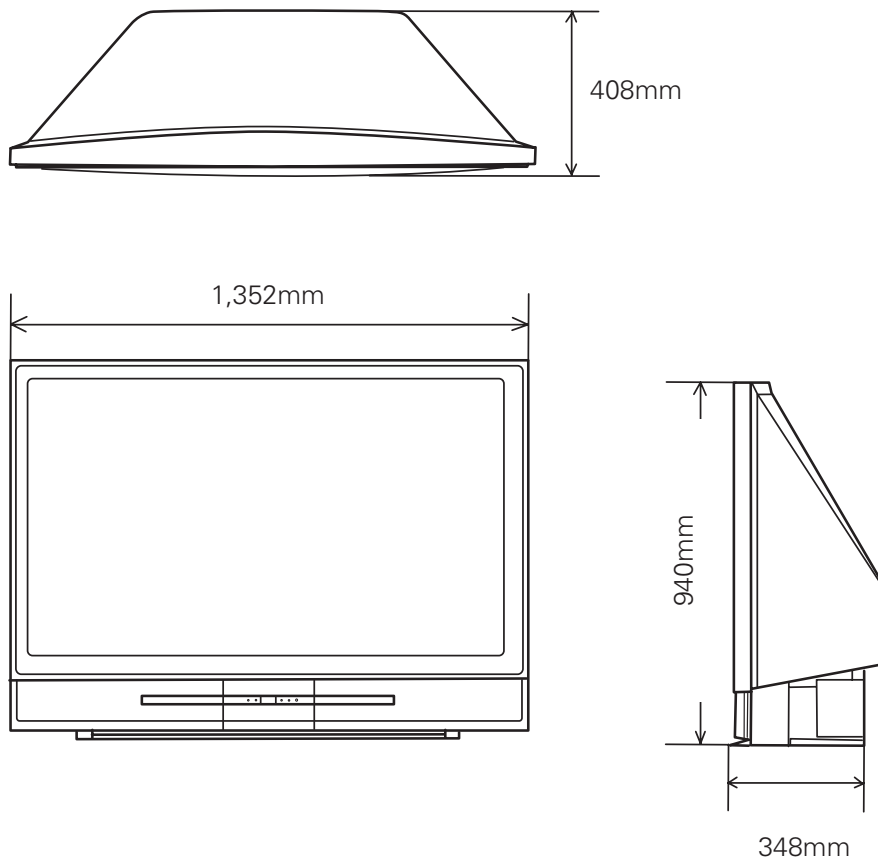

Optional Parts

The parts listed below are optionally supplied. When ordering those parts, give the name and Type No. to the sales dealer.

- | | | |
|--|-------------------|-----------------------|
| ● VGA Cable | Type No. : | POA-CA-VGA |
| ● LCD Projection Monitor Stand | Type No. : | POA-TD-55WM1 |
| ● PJ Net Organizer | Type No. : | POA-PN30 |
| ● Camera Sand for Video Conference System | Type No. : | POA-TD-VCSTAND |



This symbol on the nameplate means the product is Listed by Underwriters Laboratories Inc. It is designed and manufactured to meet rigid U.L. safety standards against risk of fire, casualty and electrical hazards.



The CE Mark is a Directive conformity mark of the European Community (EC).



Configurations of Terminal

PC IN (D-SUB) TERMINAL / OUTPUT TERMINAL

Terminal : Mini D-sub 15-PIN

Pin Configuration

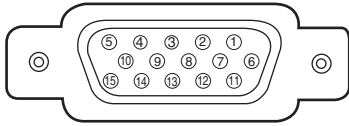

1	Red Input / Output	9	No Connect
2	Green Input / Output	10	Ground (Vert.sync.)
3	Blue Input / Output	11	-
4	-	12	-
5	Ground (Horiz.sync.)	13	Horiz. sync.
6	Ground (Red)	14	Vert. sync.
7	Ground (Green)	15	-
8	Ground (Blue)		

DVI-D TERMINAL (DIGITAL)

Terminal : DVI-D

Pin Configuration

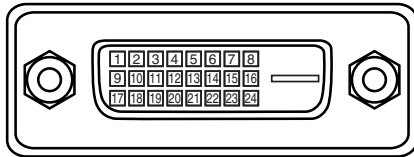

1	T.M.D.S. Data2-	9	T.M.D.S. Data1-	17	T.M.D.S. Data0-
2	T.M.D.S. Data2+	10	T.M.D.S. Data1+	18	T.M.D.S. Data0+
3	T.M.D.S. Data2 Shield	11	T.M.D.S. Data1 Shield	19	T.M.D.S. Data0 Shield
4	No Connect	12	No Connect	20	No Connect
5	No Connect	13	No Connect	21	No Connect
6	DDC Clock	14	+5V Power	22	T.M.D.S. Clock Shield
7	DDC Data	15	Ground (for +5V)	23	T.M.D.S. Clock+
8	Analog Vert. sync	16	Hot Plug Detect	24	T.M.D.S. Clock-

SERIAL PORT CONNECTOR

Terminal : Mini D-sub 9-PIN

Pin Configuration

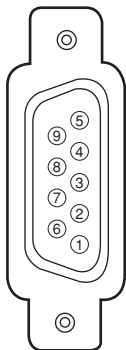

1	No Connect	6	No Connect
2	R x D	7	No Connect
3	T x D	8	No Connect
4	No Connect	9	No Connect
5	Ground		

