

myprojectorlamps.com

**The most trusted, dependable name
in projector lamp sales.**



<http://www.myprojectorlamps.com>



<http://www.myprojectorlamps.ca>



<http://www.myprojectorlamps.eu>

The following projector manual has not been modified or altered in any way.



Multimedia Projector

MODEL PLC-XU300

PLC-XU350

PLC-XU300K

PLC-XU350K

Network Supported

- Wired LAN
100-Base-TX/10-Base-T

Refer to the Owner's Manuals below for details about network function.

- Network Set-up and Operation
- PJ Network Manager

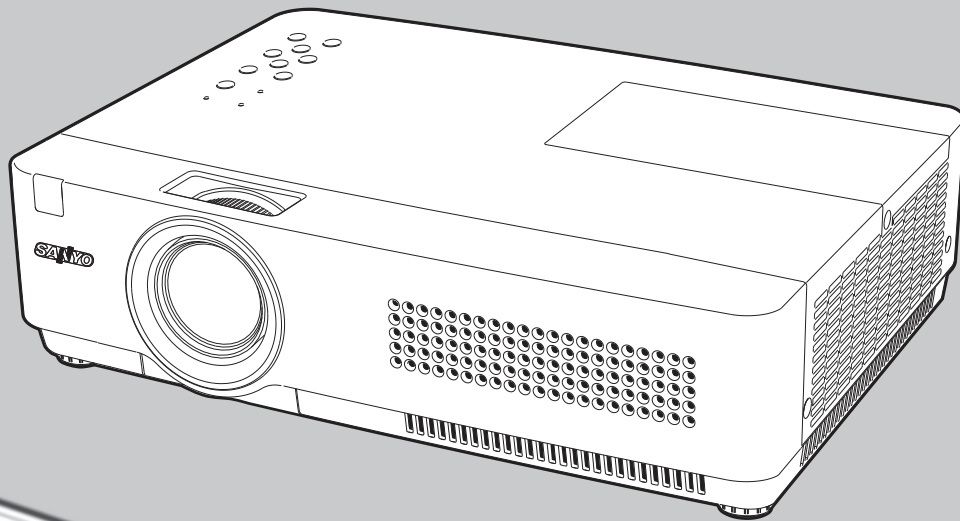

PROJECTOR

Owner's Manual



Features and Design

This Multimedia Projector is designed with the most advanced technology for portability, durability, and ease of use. This projector utilizes built-in multimedia features, a palette of 16.77 million colors, and matrix liquid crystal display (LCD) technology.

◆ Compact Design

This projector is designed compact in size and weight. It is easy to carry and installed anywhere you wish to use.

◆ Simple Computer System Setting

The projector has the Multi-scan system to conform to almost all computer output signals quickly (p.29). Up to UXGA resolution can be accepted.

◆ Useful Functions for Presentations

- The digital zoom function allows you to focus on the crucial information during a presentation (p.36).

- Blackboards* can be used as a projection screen.
*The board color is limited to Green (pp.33, 40).

◆ Lamp Control

Brightness of the projection lamp can be selected (pp.25, 53).

◆ Quick Termination

The AC power cord can be unplugged immediately after turning off the projector without waiting for the termination of the cooling fan rotation (p.20).

◆ Logo Function

The Logo function allows you to customize the screen logo (pp.47-49). You can capture an image for the screen logo and use it for the starting-up display or between presentations.

◆ Multilanguage Menu Display

Operation menu is available in 17 languages; English, German, French, Italian, Spanish, Portuguese, Dutch, Swedish, Finnish, Polish, Hungarian, Romanian, Russian, Chinese, Korean, Japanese and Thai (p.44).

◆ Switchable Interface Terminal

The projector provides a switchable interface terminal. You can use the terminal as computer input or monitor output conveniently. (p.50)

◆ Security Function

The Security function helps you to ensure security of the projector. With the Key lock function, you can lock the operation on the top control or remote control (p.54). PIN code lock function prevents unauthorized use of the projector (pp.19, 54–55).

◆ Helpful Maintenance Functions

Lamp and filter maintenance functions provide for better and proper maintenance of the projector.

◆ LAN Network Function

This projector is loaded with the Wired LAN network function. You can operate and manage the projector via network. For details, refer to the owner's manual "Network Set-up and Operation."

◆ Auto Setup Function

This function enables Input search, Auto Keystone correction and Auto PC adjustment by simple pressing the AUTO SETUP button on the top control (p.45).

◆ Colorboard Function

At the time of simple projection on the colored wall, you can get the close color image to the color image projected on a white screen by selecting the similar color to the wall color from the preset four colors.

◆ Power Management

The Power management function reduces power consumption and maintains the lamp life (p.51).

◆ Closed Caption

This is a printed version of the program sound or other information displayed on the screen. You can turn on the feature and switch the channels. (p.52)

✓ Note:

- The On-Screen Menu and figures in this manual may differ slightly from the product.
- The contents of this manual are subject to change without notice.

Table of Contents

| | | | |
|---|-----------|---|-----------|
| Features and Design | 2 | Auto PC Adjustment | 30 |
| Table of Contents | 3 | Manual PC Adjustment | 31 |
| To the Owner | 4 | Image Mode Selection | 33 |
| Safety Instructions | 5 | Image Adjustment | 34 |
| Air Circulation | 6 | Screen Size Adjustment | 35 |
| Installing the Projector in Proper Directions | 6 | Video Input | 37 |
| Moving the Projector | 6 | Input Source Selection (Video, S-video) | 37 |
| Compliance | 7 | Input Source Selection | |
| Part Names and Functions | 8 | (Component, RGB Scart 21-pin) | 38 |
| Front | 8 | Video System Selection | 39 |
| Back | 8 | Image Mode Selection | 40 |
| Bottom | 8 | Image Adjustment | 41 |
| Rear Terminal | 9 | Screen Size Adjustment | 43 |
| Top Control | 10 | Setting | 44 |
| Remote Control | 11 | Setting | 44 |
| Remote Control Battery Installation | 12 | Information | 58 |
| Remote Control Operating Range | 12 | Input Source Information Display | 58 |
| Remote Control Code | 12 | Maintenance and Cleaning | 59 |
| Installation | 13 | WARNING indicator | 59 |
| Positioning the Projector | 13 | Cleaning the Filters | 60 |
| Adjustable Feet | 13 | Resetting the Filter Counter | 60 |
| Connecting to a Computer | 14 | Attaching the Lens Cap | 61 |
| Connecting to Video Equipment | 15 | Cleaning the Projection Lens | 61 |
| Connecting to Component Video Equipment | 16 | Cleaning the Projector Cabinet | 61 |
| Connecting the AC Power Cord | 17 | Lamp Replacement | 62 |
| Basic Operation | 18 | Appendix | 64 |
| Turning On the Projector | 18 | Troubleshooting | 64 |
| Turning Off the Projector | 20 | Menu Tree | 68 |
| How to Operate the On-Screen Menu | 21 | Indicators and Projector Condition | 70 |
| Menu Bar | 22 | Compatible Computer Specifications | 71 |
| Zoom and Focus Adjustment | 23 | Technical Specifications | 72 |
| Auto Setup Function | 23 | Optional Parts | 73 |
| Keystone Correction | 23 | PJ Link Notice | 74 |
| Sound Adjustment | 24 | Configurations of Terminals | 75 |
| Remote Control Operation | 25 | PIN Code Number Memo | 76 |
| Computer Input | 27 | Dimensions | 77 |
| Input Source Selection | | | |
| (Computer 1: RGB / Component / RGB(Scart)) | 27 | | |
| Input Source Selection | | | |
| (Computer 2: RGB) | 28 | | |
| Computer System Selection | 29 | | |

Trademarks

Each name of corporations or products in this book is either a registered trademark or a trademark of its respective corporation.

To the Owner

Before installing and operating this projector, read this manual thoroughly.

This projector provides many convenient features and functions. Operating the projector properly enables you to manage those features and maintains it in good condition for many years to come.

Improper operation may result in not only shortening the product-life, but also malfunctions, fire hazard, or other accidents.

If your projector seems to operate improperly, read this manual again, check operations and cable connections and try the solutions in the "Troubleshooting" section in the back of this booklet. If the problem still persists, contact the dealer where you purchased the projector or the service center.

| |
|---|
| <div style="display: inline-block; background-color: black; color: white; padding: 5px; text-align: center; font-weight: bold; margin: 0 10px;"> CAUTION RISK OF ELECTRIC SHOCK DO NOT OPEN </div> |
| <p>CAUTION: TO REDUCE THE RISK OF ELECTRIC SHOCK, DO NOT REMOVE COVER (OR BACK). NO USER-SERVICEABLE PARTS INSIDE EXCEPT LAMP REPLACEMENT. REFER SERVICING TO QUALIFIED SERVICE PERSONNEL.</p> |
| <p>THIS SYMBOL INDICATES THAT DANGEROUS VOLTAGE CONSTITUTING A RISK OF ELECTRIC SHOCK IS PRESENT WITHIN THIS UNIT.</p> |
| <p>THIS SYMBOL INDICATES THAT THERE ARE IMPORTANT OPERATING AND MAINTENANCE INSTRUCTIONS IN THE OWNER'S MANUAL WITH THIS UNIT.</p> |

The symbol mark and recycling systems described below apply to EU countries and do not apply to countries in other areas of the world.

Your product is designed and manufactured with high quality materials and components which can be recycled and/or reused.

The symbol mark means that electrical and electronic equipment, batteries and accumulators, at their end-of-life, should be disposed of separately from your household waste.

Note:

If a chemical symbol is printed beneath the symbol mark, this chemical symbol means that the battery or accumulator contains a heavy metal at a certain concentration. This will be indicated as follows: Hg: mercury, Cd: cadmium, Pb: lead

In the European Union there are separate collection systems for used electrical and electronic equipment, batteries and accumulators.

Please, dispose of them correctly at your local community waste collection/recycling centre. Please, help us to conserve the environment we live in!



Safety Precaution

- WARNING:**
- **THIS APPARATUS MUST BE EARTHED.**
 - **TO REDUCE THE RISK OF FIRE OR ELECTRIC SHOCK, DO NOT EXPOSE THIS APPLIANCE TO RAIN OR MOISTURE.**

- This projector produces intense light from the projection lens. Do not stare directly into the lens, otherwise eye damage could result. Be especially careful that children do not stare directly into the beam.
- Install the projector in a proper position. Otherwise it may result in fire hazard.
- Allowing the proper amount of space on the top, sides, and rear of the projector cabinet is critical for proper air circulation and cooling of the unit. The dimension shown here indicate the minimum space required. If the projector is to be built into a compartment or similarly enclosed, these minimum distances must be maintained.
- Do not cover the ventilation slot on the projector. Heat build-up can reduce the service life of your projector, and can also be dangerous.

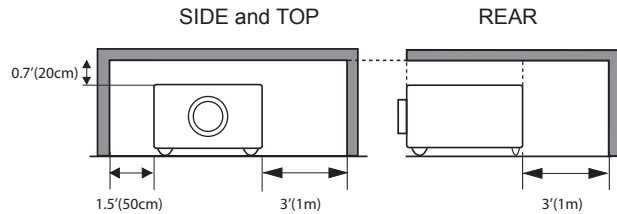

- If the projector is unused for an extended time, unplug the projector from the power outlet.
- Do not project the same image for a long time. The afterimage may remain on the LCD panels by the characteristic of panel.



CAUTION

DO NOT SET THE PROJECTOR IN GREASY, WET, OR SMOKY CONDITIONS SUCH AS IN A KITCHEN TO PREVENT A BREAKDOWN OR A DISASTER. IF THE PROJECTOR COMES IN CONTACT WITH OIL OR CHEMICALS, IT MAY BECOME DETERIORATED.



CAUTION

Not for use in a computer room as defined in the Standard for the Protection of Electronic Computer/Data Processing Equipment, ANSI/NFPA 75.

Ne peut être utilisé dans une salle d'ordinateurs telle que définie dans la norme ANSI/NFPA 75 Standard for Protection of Electronic Computer/Data Processing Equipment.

READ AND KEEP THIS OWNER'S MANUAL FOR LATER USE.

Safety Instructions

All the safety and operating instructions should be read before the product is operated.

Read all of the instructions given here and retain them for later use. Unplug this projector from AC power supply before cleaning. Do not use liquid or aerosol cleaners. Use a damp cloth for cleaning.

Follow all warnings and instructions marked on the projector.

For added protection to the projector during a lightning storm, or when it is left unattended and unused for long periods of time, unplug it from the wall outlet. This will prevent damage due to lightning and power line surges.

Do not expose this unit to rain or use near water... for example, in a wet basement, near a swimming pool, etc...

Do not use attachments not recommended by the manufacturer as they may cause hazards.

Do not place this projector on an unstable cart, stand, or table. The projector may fall, causing serious injury to a child or adult, and serious damage to the projector. Use only with a cart or stand recommended by the manufacturer, or sold with the projector. Wall or shelf mounting should follow the manufacturer's instructions, and should use a mounting kit approved by the manufacturers.

An appliance and cart combination should be moved with care. Quick stops, excessive force, and uneven surfaces may cause the appliance and cart combination to overturn.



Slots and openings in the back and bottom of the cabinet are provided for ventilation, to ensure reliable operation of the equipment and to protect it from overheating.

The openings should never be covered with cloth or other materials, and the bottom opening should not be blocked by placing the projector on a bed, sofa, rug, or other similar surface. This projector should never be placed near or over a radiator or heat register.

This projector should not be placed in a built-in installation such as a book case unless proper ventilation is provided.

Never push objects of any kind into this projector through cabinet slots as they may touch dangerous voltage points or short out parts that could result in a fire or electric shock. Never spill liquid of any kind on the projector.

Do not install the projector near the ventilation duct of air-conditioning equipment.

This projector should be operated only from the type of power source indicated on the marking label. If you are not sure of the type of power supplied, consult your authorized dealer or local power company.

Do not overload wall outlets and extension cords as this can result in fire or electric shock. Do not allow anything to rest on the power cord. Do not locate this projector where the cord may be damaged by persons walking on it.

Do not attempt to service this projector yourself as opening or removing Covers may expose you to dangerous voltage or other hazards. Refer all servicing to qualified service personnel.

Unplug this projector from wall outlet and refer servicing to qualified service personnel under the following conditions:

- a. When the power cord or plug is damaged or frayed.
- b. If liquid has been spilled into the projector.
- c. If the projector has been exposed to rain or water.
- d. If the projector does not operate normally by following the operating instructions. Adjust only those controls that are covered by the operating instructions as improper adjustment of other controls may result in damage and will often require extensive work by a qualified technician to restore the projector to normal operation.
- e. If the projector has been dropped or the cabinet has been damaged.
- f. When the projector exhibits a distinct change in performance-this indicates a need for service.

When replacement parts are required, be sure the service technician has used replacement parts specified by the manufacturer that have the same characteristics as the original part. Unauthorized substitutions may result in fire, electric shock, or injury to persons.

Upon completion of any service or repairs to this projector, ask the service technician to perform routine safety checks to determine that the projector is in safe operating condition.

NOTE FOR CUSTOMERS IN THE US

Ⓜ LAMP(S) INSIDE THIS PRODUCT CONTAIN MERCURY AND MUST BE RECYCLED OR DISPOSED OF ACCORDING TO LOCAL, STATE OR FEDERAL LAWS.

Safety Instructions

Air Circulation

Openings in the cabinet are provided for ventilation. To ensure reliable operation of the product and to protect it from overheating, these openings must not be blocked or covered.

CAUTION

Hot air is exhausted from the exhaust vent. When using or installing the projector, the following precautions should be taken.

- Do not put any flammable object or spray can near the projector, hot air is exhausted from the air vents.
- Keep the exhaust vent at least 3' (1 m) away from any objects.
- Do not touch a peripheral part of the exhaust vent, especially screws and metallic parts. These areas will become hot while the projector is being used.
- Do not put anything on the cabinet. Objects put on the cabinet will not only get damaged but also may cause fire hazard by heat.

Cooling fans are provided to cool down the projector. The fans' running speed is changed according to the temperature inside the projector.

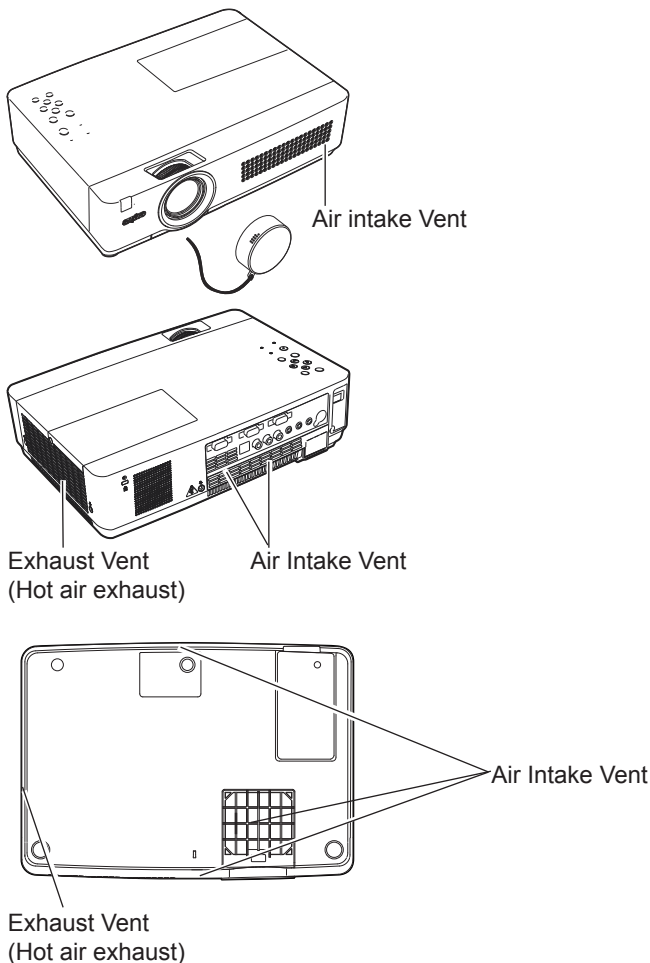

Installing the Projector in Proper Position

Install the projector properly. Improper Installation may reduce the lamp life and cause a fire hazard.

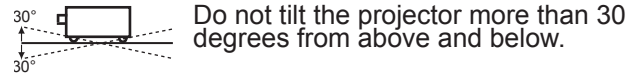
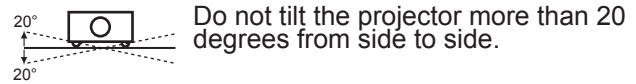

Do not point the projector up to project an image.



Do not point the projector down to project an image.



Do not put the projector on either side to project an image.

Moving the Projector

When moving the projector, replace the lens cap and retract adjustable feet to prevent damage to the lens and cabinet.

When the projector is not in use for an extended period, put it into a suitable case with the lens side up.

CAUTION IN CARRYING OR TRANSPORTING THE PROJECTOR

- Do not drop or bump the projector, otherwise damages or malfunctions may result.
- When carrying the projector, use a suitable carrying case.
- Do not transport the projector by courier or any other transport service in an unsuitable transport case. This may cause damage to the projector. For information about transporting the projector by courier or any other transport service, consult your dealer.
- Do not put the projector in a case before the projector is cooled enough.

Compliance

Federal Communications Commission Notice

Note: This equipment has been tested and found to comply with the limits for a Class B digital device, pursuant to Part 15 of the FCC Rules. These limits are designed to provide reasonable protection against harmful interference in a residential installation. This equipment generates, uses, and can radiate radio frequency energy, and if not installed and used in accordance with the instructions, may cause harmful interference to radio communications. However, there is no guarantee that interference will not occur in a particular installation. If this equipment does cause harmful interference to radio or television reception, which can be determined by turning the equipment off and on, the user is encouraged to try to correct the interference by one or more of the following measures:

- Reorient or relocate the receiving antenna.
- Increase the separation between the equipment and receiver.
- Connect the equipment into an outlet on a circuit different from that to which the receiver is connected.
- Consult the dealer or an experienced radio/TV technician for help.

Use of shielded cable is required to comply with class B limits in Subpart B of Part 15 of FCC Rules.

Do not make any changes or modifications to the equipment unless otherwise specified in the instructions. If such changes or modifications should be made, you could be required to stop operation of the equipment.

Model Number : PLC-XU300, PLC-XU350
Trade Name : Sanyo
Responsible party : SANYO FISHER COMPANY
Address : 21605 Plummer Street, Chatsworth, California 91311
Telephone No. : (818)998-7322

AC Power Cord Requirement

The AC Power Cord supplied with this projector meets the requirement for use in the country you purchased it.

AC Power Cord for the United States and Canada:

AC Power Cord used in the United States and Canada is listed by the Underwriters Laboratories (UL) and certified by the Canadian Standard Association (CSA).

AC Power Cord has a grounding-type AC line plug. This is a safety feature to be sure that the plug will fit into the power outlet. Do not try to defeat this safety feature. Should you be unable to insert the plug into the outlet, contact your electrician.



AC Power Cord for the United Kingdom:

This cord is already fitted with a moulded plug incorporating a fuse, the value of which is indicated on the pin face of the plug. Should the fuse need to be replaced, an ASTA approved BS 1362 fuse must be used of the same rating, marked thus \diamond . If the fuse cover is detachable, never use the plug with the cover omitted. If a replacement fuse cover is required, ensure it is of the same colour as that visible on the pin face of the plug (i.e. red or orange). Fuse covers are available from the Parts Department indicated in your User Instructions. If the plug supplied is not suitable for your socket outlet, it should be cut off and destroyed.

The end of the flexible cord should be suitably prepared and the correct plug fitted.

WARNING : A PLUG WITH BARED FLEXIBLE CORD IS HAZARDOUS IF ENGAGED IN A LIVE SOCKET OUTLET.

The Wires in this mains lead are coloured in accordance with the following code:

- Green-and-yellow Earth
- Blue Neutral
- Brown Live

As the colours of the wires in the mains lead of this apparatus may not correspond with the coloured markings identifying the terminals in your plug proceed as follows:

The wire which is coloured green-and-yellow must be connected to the terminal in the plug which is marked by the letter E or by the safety earth symbol \perp or coloured green or green-and-yellow.

The wire which is coloured blue must be connected to the terminal which is marked with the letter N or coloured black.

The wire which is coloured brown must be connected to the terminal which is marked with the letter L or coloured red.

WARNING: THIS APPARATUS MUST BE EARTHED.

THE SOCKET-OUTLET SHOULD BE INSTALLED NEAR THE EQUIPMENT AND EASILY ACCESSIBLE.

Part Names and Functions

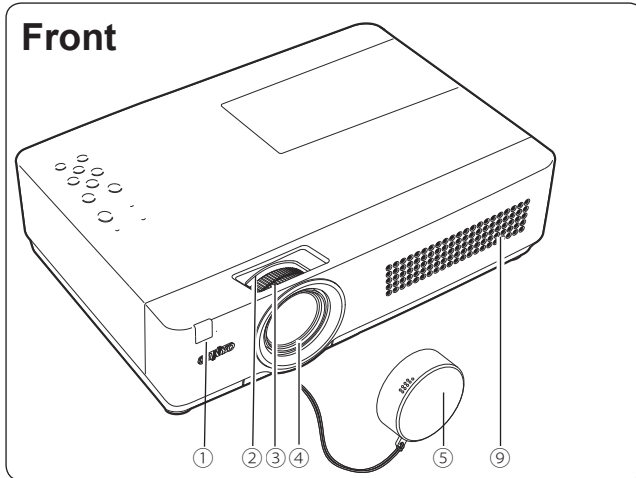

- ① Infrared Remote Receiver
- ② Zoom Ring
- ③ Focus Ring
- ④ Projection Lens
- ⑤ Lens Cap
(See page 61 for attaching.)

⚠ CAUTION

Do not turn on a projector with lens cap attached. High temperature from light beam may damage lens cap and result in fire hazard.

- ⑥ Speaker

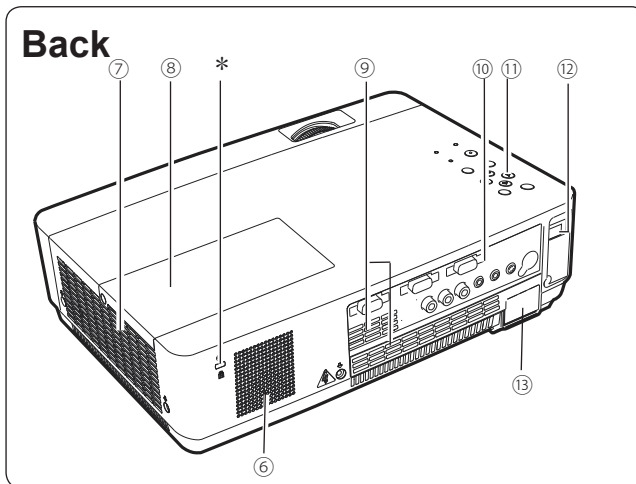

- ⑦ Exhaust Vents

⚠ CAUTION

Hot air is exhausted from the exhaust vent. Do not put heat-sensitive objects near this side.

- ⑧ Lamp Cover
- ⑨ Air Intake Vent
- ⑩ Terminals and Connectors
- ⑪ Top Controls and Indicators
- ⑫ LAN Connection Terminal
- ⑬ Power Cord Connector
- ⑭ Filters
- ⑮ Adjustable Feet

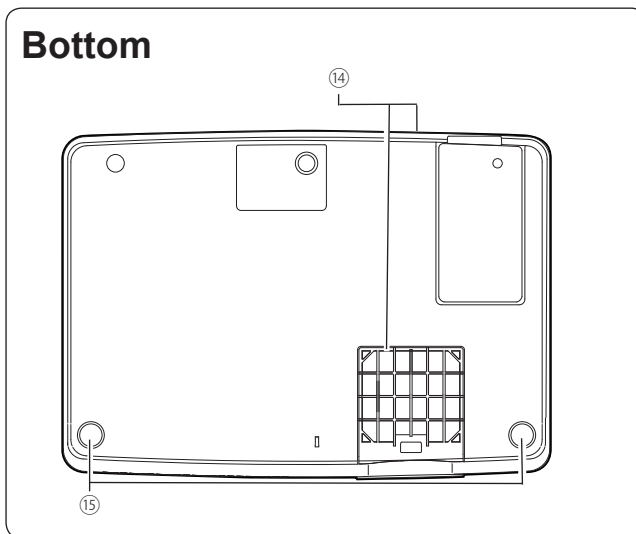

✓Note:

⑫ LAN Connection Terminal is for the Network function. Refer to the owner's manual of "Network Set-up and Operation".

* **Kensington Security Slot**

This slot is for a Kensington lock used to deter theft of the projector.

*Kensington is a registered trademark of ACCO Brands Corporation.

Rear Terminal

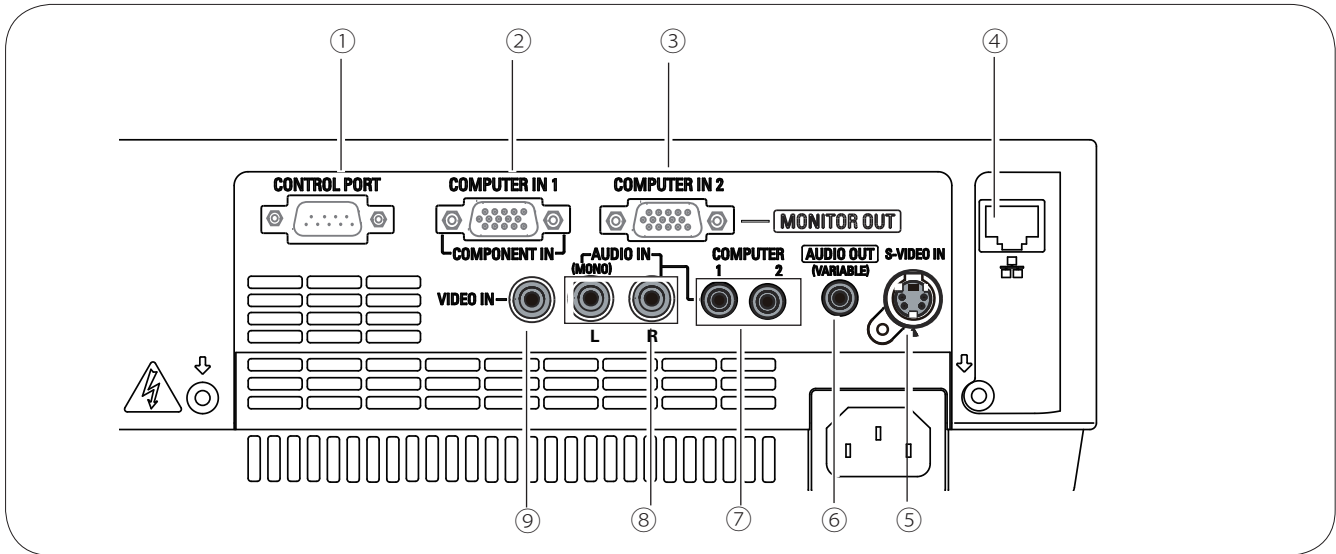

① **CONTROL PORT**

When the projector is controlled by a computer, connect to this jack with serial control cable.

② **COMPUTER IN 1 / COMPONENT IN**

Connect output signal from a computer, RGB scart 21-pin video output or component video output to this terminal(pp.14,16).

③ **COMPUTER IN 2 / MONITOR OUT**

- Connect computer output to this terminal (p.14).
- This terminal can be used to output the incoming analog RGB and Component signal from COMPUTER IN 1/COMPONENT IN terminal to the other monitor (pp.14,16).

④ **LAN Connection Terminal**

Connect the LAN cable (refer to the owner's manual of "Network Set-up and Operation").

⑤ **S-VIDEO IN**

Connect the S-VIDEO output signal from video equipment to this jack (p.15).

⑥ **AUDIO OUT (VARIABLE)**

Connect an external audio amplifier to this jack (pp.14-16).

This terminal outputs sound from AUDIO IN terminal (⑦ or ⑧).

⑦ **COMPUTER 1 / COMPUTER 2 AUDIO IN**

Connect the audio output (stereo) from a computer or video equipment connected to ② or ③ to this jack. (pp14, 16)

⑧ **AUDIO IN**

Connect the audio output signal from video equipment connected to ⑤ or ⑨ to this jack.

For a mono audio signal (a single audio jack), connect it to the L (MONO) jack (p.15).

⑨ **VIDEO IN**

Connect the composite video output signal to this jack (p.15).

Top Control

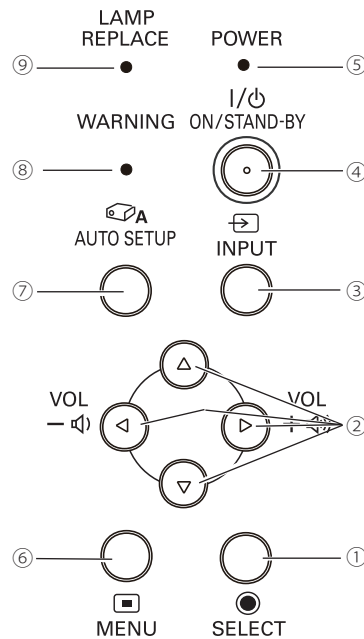

① SELECT button

- Execute the selected item (p.21).
- Expand or compress the image in the Digital zoom mode (p.36).

② POINT ▲▼◀▶ (VOLUME +/-) buttons

- Select an item or adjust the value in the On-Screen Menu (p.21).
- Pan the image in the Digital zoom +/- mode (p.36).
- Adjust the volume level (Point ◀▶ buttons) (p.24).

③ INPUT button

Select an input source (pp.27-28, 37-38).

④ ON/STAND-BY button

Turn the projector on or off (pp.18-20).

⑤ POWER indicator

- Lights red when the projector is in stand-by mode.
- Lights green during operations.
- Blinks green in the Power management mode (p.51).

⑥ MENU button

Open or close the On-Screen Menu (p.21).

⑦ AUTO SETUP button

Correct vertical keystone distortion and adjust computer display parameters such as **Fine sync.**, **Total dots**, and **Picture position** (pp.23, 45).

⑧ WARNING indicator

- Lights red when the projector detects an abnormal condition.
- Blinks red when the internal temperature of the projector exceeds the operating range (pp.59, 70).

⑨ LAMP REPLACE indicator

Lights yellow when the projection lamp reaches its end of life (pp.62, 70).

Remote Control

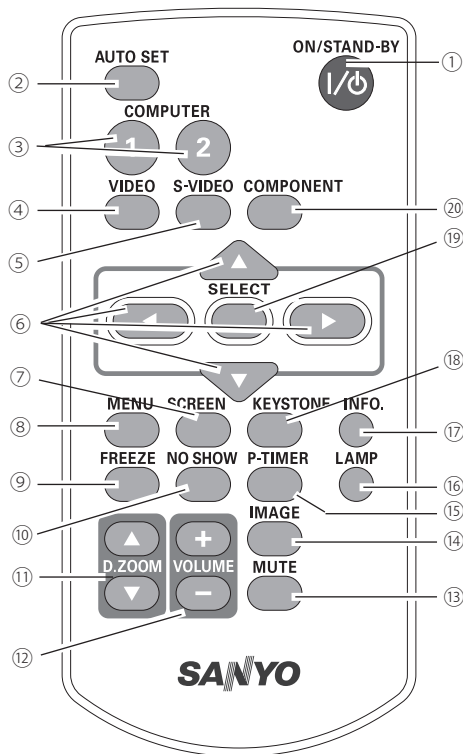

- ① **ON/STAND-BY button**
Turn the projector on or off. (pp.18-20)
- ② **AUTO SET button**
Correct vertical keystone distortion and adjust computer display parameters such as **Fine sync.**, **Total dots**, and **Picture position**.(pp.23, 45)
- ③ **COMPUTER 1/2 buttons**
Select the COMPUTER 1 or COMPUTER 2 input source. (pp.27-28, 38)
- ④ **VIDEO button**
Select the VIDEO input source. (p.37)
- ⑤ **S-VIDEO button**
Select the S-VIDEO input source. (p.37)
- ⑥ **Point ▲▼◀▶ buttons**
– Select an item or adjust the value in the On-Screen Menu. (p.21)
– Pan the image in the Digital zoom +/- mode. (p.36)
- ⑦ **SCREEN button**
Select a screen mode. (pp.26,35,43)
- ⑧ **MENU button**
Open or close the On-Screen Menu. (p.21)
- ⑨ **FREEZE button**
Freeze the picture on the screen. (p.25)
- ⑩ **NO SHOW button**
Temporarily turn off the image on the screen. (p.26)
- ⑪ **D.ZOOM ▲▼ buttons**
Zoom in and out the images. (pp.25, 36)
- ⑫ **VOLUME +/- buttons**
Adjust the volume level. (p.24)
- ⑬ **MUTE button**
Mute the sound. (p.24)
- ⑭ **IMAGE button**
Select the image mode. (pp.26,33,40)
- ⑮ **P-TIMER button**
Operate the P-timer function. (p.26)
- ⑯ **LAMP button**
Select a lamp mode. (pp.25, 53)
- ⑰ **INFO. button**
Operate the information function. (p.58)
- ⑱ **KEYSTONE button**
Correct keystone distortion. (pp.23, 46)
- ⑲ **SELECT button**
– Execute the selected item. (p.21)
– Expand or compress the image in Digital zoom mode. (p.36)
- ⑳ **COMPONENT button**
Select the COMPONENT input source. (p.38)

✓ **Note:**

To ensure safe operation, please observe the following precautions:

- Do not bend, drop, or expose the remote control to moisture or heat.
- For cleaning, use a soft dry cloth. Do not apply benzene, thinner, spray, or any chemical material.

Remote Control Battery Installation

- 1** Open the battery compartment lid.

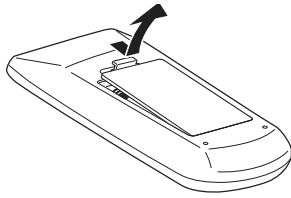

- 2** Install new batteries into the compartment.

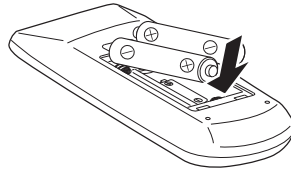

Two AAA size batteries

For correct polarity (+ and -), be sure battery terminals are in contact with pins in compartment.

- 3** Replace the compartment lid.

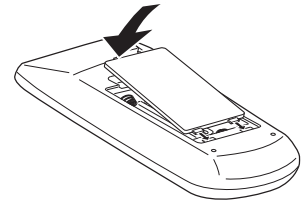

To ensure safe operation, please observe the following precautions :

- Use two (2) AAA or LR03 type alkaline batteries.
- Always replace batteries in sets.
- Do not use a new battery with a used battery.
- Avoid contact with water or liquid.
- Do not expose the remote control to moisture or heat.
- Do not drop the remote control.
- If the battery has leaked on the remote control, carefully wipe the case clean and install new batteries.
- Risk of an explosion if battery is replaced by an incorrect type.
- Dispose of used batteries according to the instructions or your local disposal rule or guidelines.

Remote Control Operating Range

Point the remote control toward the projector (Infrared Remote Receiver) when pressing the buttons. Maximum operating range for the remote control is about 16.4'(5 m) and 60 degrees in front of the projector.

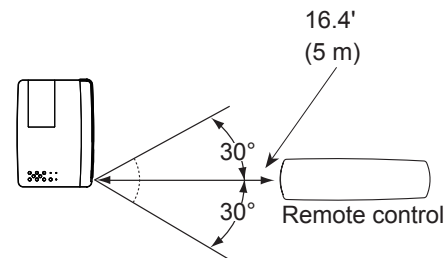

Remote Control Code

The 2 different remote control codes (Code 1–Code 2) are assigned to this projector. Switching the remote control codes prevents interference from other remote controls when several projectors or video equipment next to each other are operated at the same time. Change the remote control code for the projector first before changing that for the remote control. See "Remote control" in the Setting Menu on page 53.

Press and hold the MENU and IMAGE buttons for more than five seconds to switch between the **Code 1** and **Code 2**. The initial code is set to **Code 1**.

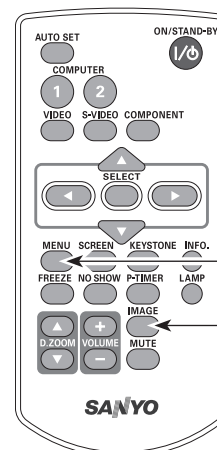

While pressing the MENU button, press the IMAGE button more than five seconds to switch between the codes.

MENU button

IMAGE button

Installation

Positioning the Projector

For projector positioning, see the figures below. The projector should be set perpendicularly to the plane of the screen.

✓ **Note:**

- The brightness in the room has a great influence on picture quality. It is recommended to limit ambient lighting in order to obtain the best image.
- All measurements are approximate and may vary from the actual sizes.

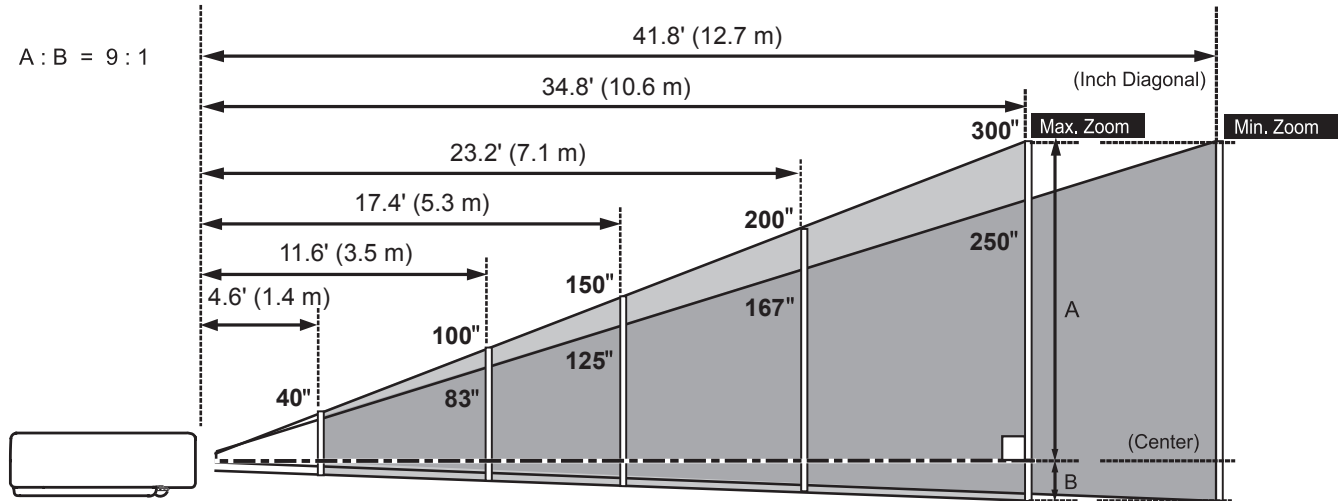

| Screen Size (W x H) mm | 40" | 100" | 150" | 200" | 300" |
|------------------------|--------------|---------------|---------------|---------------|----------------|
| 4 : 3 aspect ratio | 813 x 610 | 2032 x 1524 | 3048 x 2286 | 4064 x 3048 | 6096 x 4572 |
| Zoom (max) | 4.6' (1.4 m) | 11.6' (3.5 m) | 17.4' (5.3 m) | 23.2' (7.1 m) | 34.8' (10.6 m) |
| Zoom (min) | 5.5' (1.7 m) | 13.9' (4.2 m) | 20.9' (6.4 m) | 27.8' (8.5 m) | 41.8' (12.7 m) |

Adjustable Feet

Projection angle can be adjusted up to 12.0 degrees with the adjustable feet.

Lift the front of the projector and press the feet lock latches on both side of the projector.

Release the feet lock latches to lock the adjustable feet and rotate the adjustable feet to a proper height, and tilt.

Keystone distortion can be adjusted automatically with the Auto setup function or manually by using the remote control or the menu operation (see pages 23, 45-46).

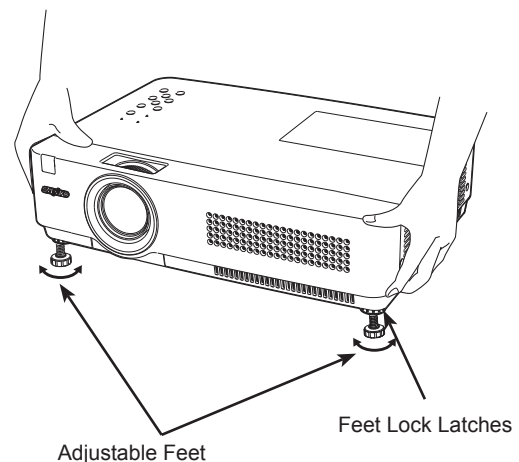

Connecting to a Computer

Cables used for connection

- VGA Cables (Mini D-sub 15 pin) *
- Audio Cables

(*One cable is supplied; other cables are not supplied with the projector.)

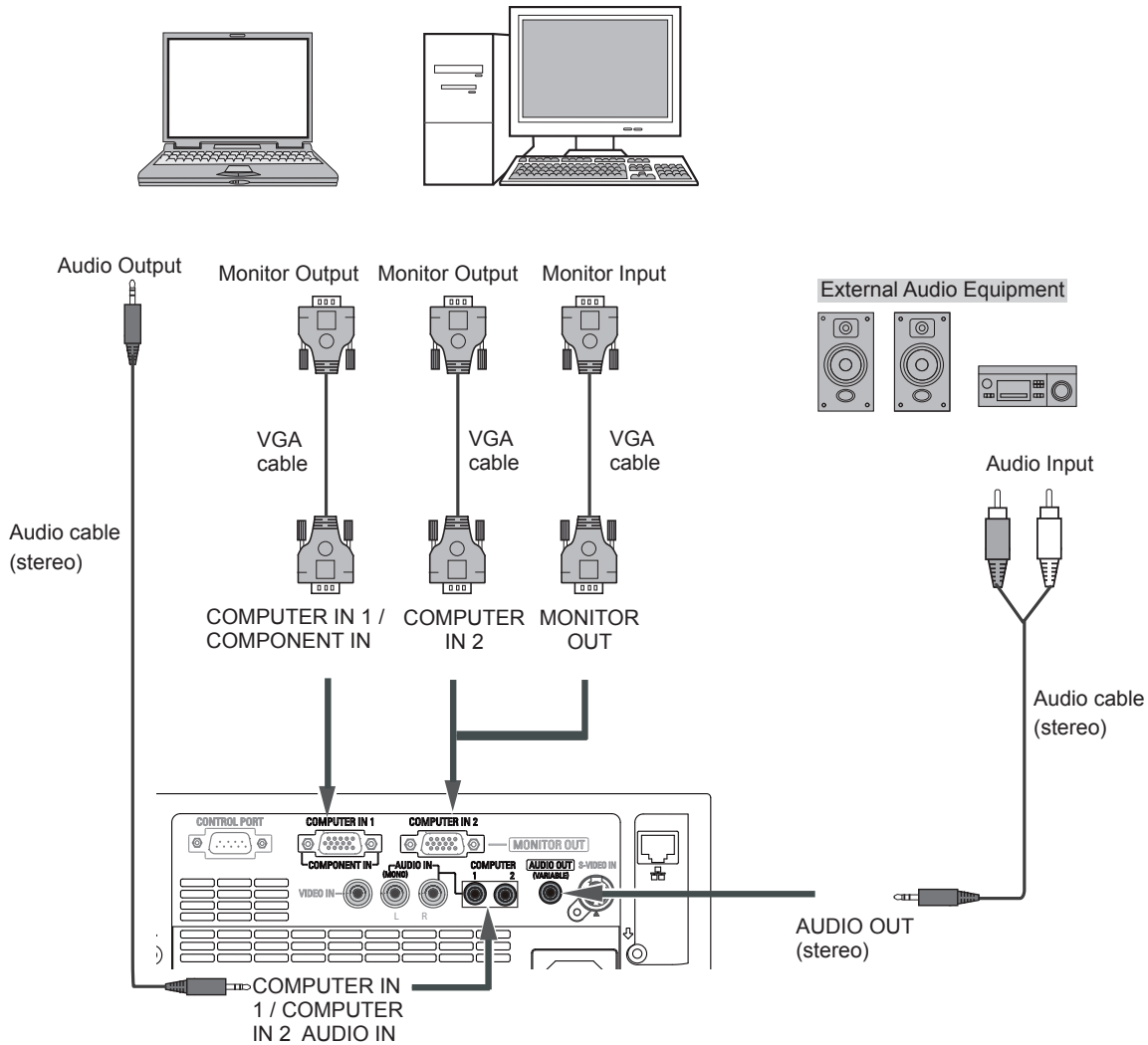

✓Note:

- Input sound to the COMPUTER1 /COMPUTER 2 AUDIO IN terminal when using the COMPUTER IN 2 / MONITOR OUT and the COMPUTER IN 1 / COMPONENT IN terminal as input.
- When the AUDIO OUT is plugged-in, the projector's built-in speaker is not available.
- When the cable is of the longer variety, it is advisable to use the COMPUTER IN 1 / COMPONENT IN and not the COMPUTER IN 2.



Unplug the power cords of both the projector and external equipment from the AC outlet before connecting cables.

Connecting to Video Equipment

Cables used for connection

- Video and Audio Cable (RCA x 3)
 - S-VIDEO Cable
 - Audio Cable
- (Cables are not supplied with the projector.)

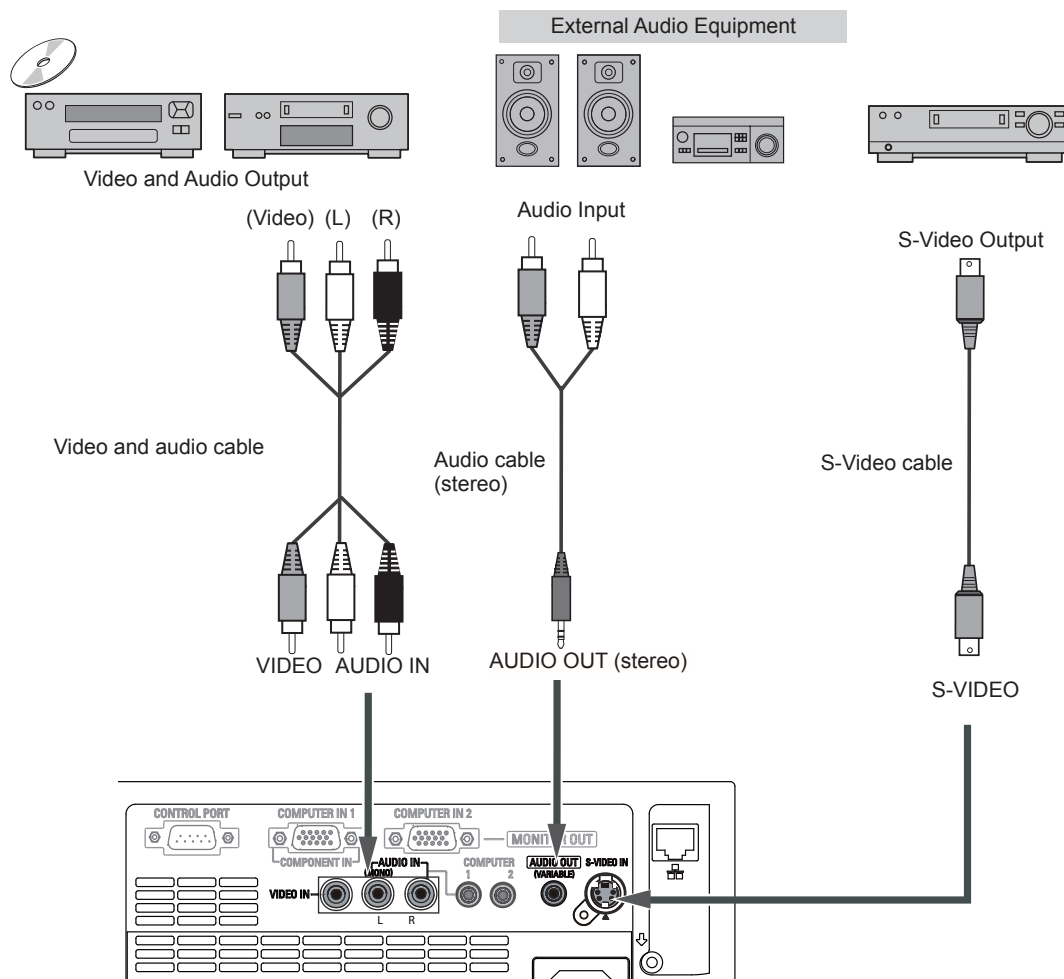

✓ **Note:**

When the AUDIO OUT is plugged-in, the projector's built-in speaker is not available.



Unplug the power cords of both the projector and external equipment from the AC outlet before connecting cables.

Connecting to Component Video Equipment

Cables used for connection

- Audio Cables
- Scart-VGA Cable
- VGA Cable
- Component Cable
- Component-VGA Cable

(Cables are not supplied with this projector.)

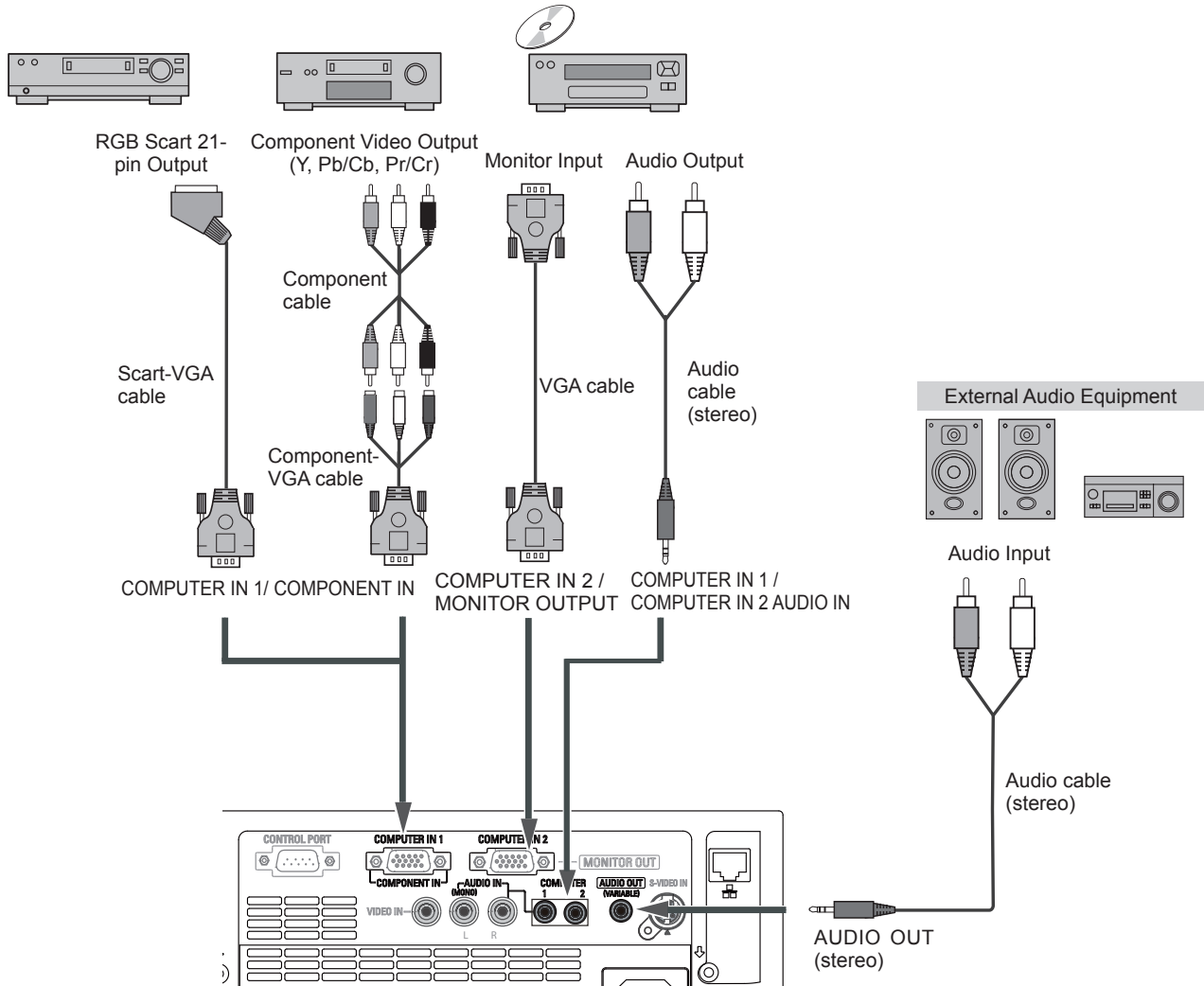

✓Note:

- When the AUDIO OUT is plugged-in, the projector's built-in speaker is not available.
- See page 73 for ordering optional cables.



Unplug the power cords of both the projector and external equipment from the AC outlet before connecting cables.

Connecting the AC Power Cord

This projector uses nominal input voltages of 100-120 V or 200–240 V AC and it automatically selects the correct input voltage. It is designed to work with single-phase power systems having a grounded neutral conductor. To reduce the risk of electrical shock, do not plug into any other type of power system.

If you are not sure of the type of power being supplied, consult your authorized dealer or service station.

Connect the projector with all peripheral equipment before turning the projector on.

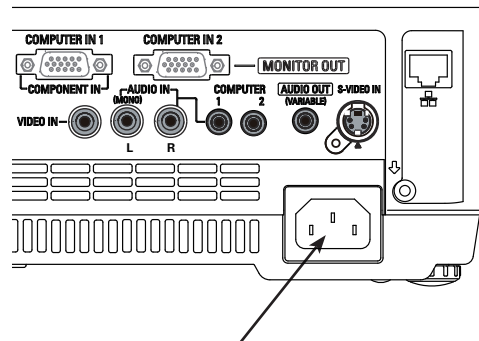

Connect the AC power cord (supplied) to the projector.



CAUTION

The AC outlet must be near this equipment and must be easily accessible.

✓ Note:

Unplug the AC power cord when the projector is not in use. When this projector is connected to an outlet with the AC power cord, it is in Stand-by mode and consumes a little electric power.

NOTE ON THE POWER CORD

AC power cord must meet requirement of the country where you use the projector. Confirm the AC plug type with the chart below and proper AC power cord must be used. If supplied AC power cord does not match your AC outlet, contact your sales dealer.

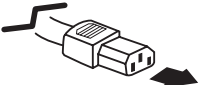
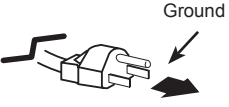
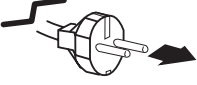
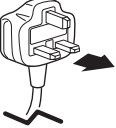
| Projector side | AC outlet side | | |
|---|--|--|---|
|  <p data-bbox="172 1522 365 1606">To power cord connector on your projector.</p> | <p data-bbox="435 1344 738 1375">For the U.S.A. and Canada</p>  <p data-bbox="467 1543 649 1606">To the AC outlet. (120 V AC)</p> | <p data-bbox="782 1344 1047 1375">For Continental Europe</p>  <p data-bbox="815 1543 998 1606">To the AC outlet. (200 - 240 V AC)</p> | <p data-bbox="1209 1344 1347 1375">For the U.K.</p>  <p data-bbox="1221 1543 1404 1606">To the AC outlet. (200 - 240 V AC)</p> |

Basic Operation

Turning On the Projector

- 1 Complete peripheral connections (with a computer, VCR, etc.) before turning on the projector.
- 2 Connect the projector's AC power cord into an AC outlet. The POWER indicator lights red. Open the lens cap (see pages 8, 61).
- 3 Press the ON/SYAND-BY button on the top control or on the remote control. The POWER indicator lights green and the cooling fans start to operate. The preparation display appears on the screen and the countdown starts.
- 4 After the countdown, the input source that was selected the last time and the lamp control status icon (see page 53) appear on the screen.
- 5 If there is no signal input when start on the projector, or the current signal is missed while operating the projector, the Video/PC selection window will be displayed on the screen, please move the pointer to input source desired by pressing the Point ▲▼ buttons and press the SELECT button. And then follow the input signal guidance window to correct the signal and connection.

If the projector is locked with a PIN code, PIN code input dialog box will appear. Enter the PIN code as instructed on the next page.

✓**Note:**

- When the Logo select function is set to **Off**, the logo will not be shown on the screen (p.47).
- When **Countdown off** or **Off** is selected in the Display function, the countdown will not be shown on the screen (p.46).
- During the countdown period, all operations are invalid.
- When the Input Search function is set to **On2**, the input signal will be searched automatically (p.45)
- When **Off** is selected in the Display function, the Video/PC selection window and the input signal guidance window are not shown on the screen. (p.46)



The preparation display will disappear after 30 seconds.

Selected Input Source and Lamp Control



(See page 53 for Lamp control status.)

✓**Note:**

The Filter warning and Lamp replacement icons may appear on the screen depending on the usage state of the projector.

Video / PC selection window

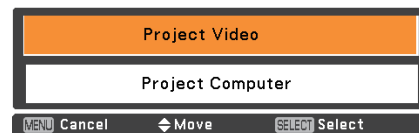

Input signal guidance window

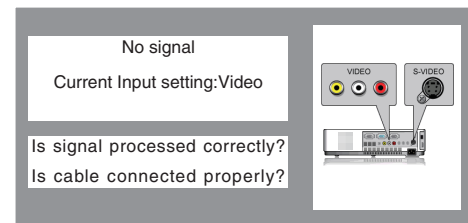

Video / PC selection window



Input signal guidance window

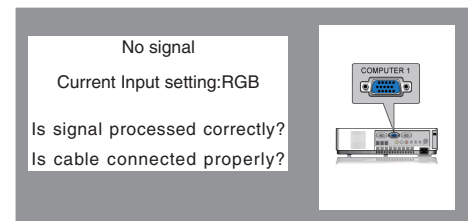

Enter a PIN code

Use the Point ▲▼ buttons to enter a number. Press the Point ► button to fix the number and move the red frame pointer to the next box. The number changes to “*”. If you fixed an incorrect number, use the Point ◀ button to move the pointer to the number you want to correct, and then enter the correct number.

Repeat this step to complete entering a four-digit number.

After entering the four-digit number, move the pointer to **Set**. Press the SELECT button so that you can start to operate the projector.

If you entered an incorrect PIN code, **PIN code** and the number (****) will turn red for a moment. Enter the correct PIN code all over again.

What is PIN code?

PIN (Personal Identification Number) code is a security code that allows the person who knows it to operate the projector. Setting a PIN code prevents unauthorized use of the projector.

A PIN code consists of a four-digit number. Refer to the PIN code lock function in the Setting Menu on pages 54-55 for locking operation of the projector with your PIN code.



CAUTION ON HANDLING PIN CODE

If you forget your PIN code, the projector can no longer be started. Take a special care in setting a new PIN code; write down the number in a column on page 76 of this manual and keep it on hand. Should the PIN code be missing or forgotten, consult your dealer or service center.

✓Note:

- If the PIN code number is not entered within three minutes after the PIN code dialog box appeared, the projector will be turned off automatically.
- The “1234” is set as the initial PIN code at the factory.

PIN Code Input Dialog Box

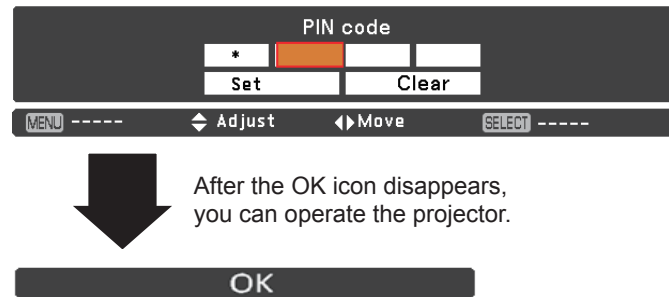

Turning Off the Projector

- 1 Press the ON/STAND-BY button on the top control or on the remote control, and **Power off?** appears on the screen.
- 2 Press the ON/STAND-BY button again to turn off the projector. The POWER indicator starts to blink red, and the cooling fans keep running. (You can select the level of fans' quietness and speed. See "Fan" on page 56.) At this time, you can unplug the AC power cord even if the fans are still running.
- 3 When the projector has cooled down enough, the POWER indicator stops blinking and you can turn on the projector.

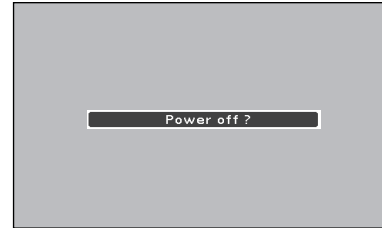

Power off? disappears after 4 seconds.



TO MAINTAIN THE LIFE OF THE LAMP, ONCE YOU TURN THE PROJECTOR ON, WAIT AT LEAST FIVE MINUTES BEFORE TURNING IT OFF.



DO NOT OPERATE THE PROJECTOR CONTINUOUSLY WITHOUT REST. CONTINUOUS USE MAY RESULT IN SHORTENING THE LAMP LIFE. TURN OFF THE PROJECTOR AND LET STAND FOR ABOUT AN HOUR IN EVERY 24 HOURS.

✓Note:

- When the On start function is set to **On**, the projector will be turned on automatically by connecting the AC power cord to an AC outlet (p.52).
- The running speed of cooling fans is changed according to the temperature inside the projector.
- Do not put the projector in a case before the projector is cooled enough.
- If the WARNING indicator blinks or lights red, see "WARNING indicator" on page 59.
- While the POWER indicator is blinking, the lamp is being cooled down and the projector cannot be turned on. Wait until the POWER indicator stops blinking to turn on the projector again.
- The fan rotation will terminate directly if the AC power cord is unplugged immediately after the projector is turned off.
- The projector can be turned on after the POWER indicator turns red. The waiting time to restart will be shortened when the normal power-off processing for fan cooling is completed, compared with the time the AC power cord is immediately unplugged after the power-off.

How to Operate the On-Screen Menu

The projector can be adjusted or set via the On-Screen Menu. The menus have a hierarchical structure, with a main menu that is divided into submenus, which are further divided into other submenus. For each adjustment and setting procedure, refer to respective sections in this manual.

- 1 Press the MENU button on the top control or the remote control to display the On-Screen Menu.
- 2 Use the Point ▲▼ buttons to highlight or select a main menu item. Press the Point ► or the SELECT button to access the submenu items. (The selected item is highlighted in ORANGE.)
- 3 Use the Point ▲▼ buttons to select the desired submenu item and press the SELECT button to set or access the selected item.
- 4 Use the Point ▲▼◀▶ buttons to adjust the setting or switch between each option and press the SELECT button to activate it and return to the submenu.
- 5 Press the Point ◀ button to return to the main menu. Press the MENU button to exit the On-Screen Menu.

Top Control

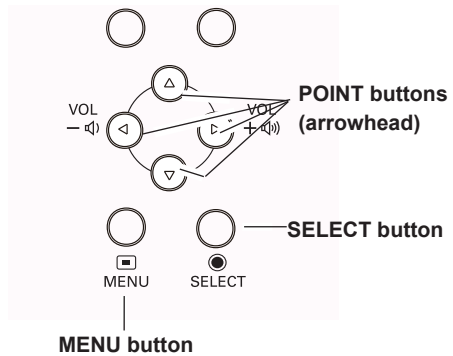

Remote Control

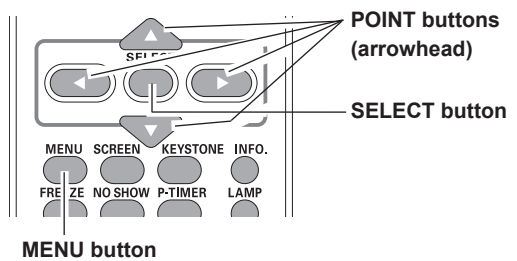

On-Screen Menu

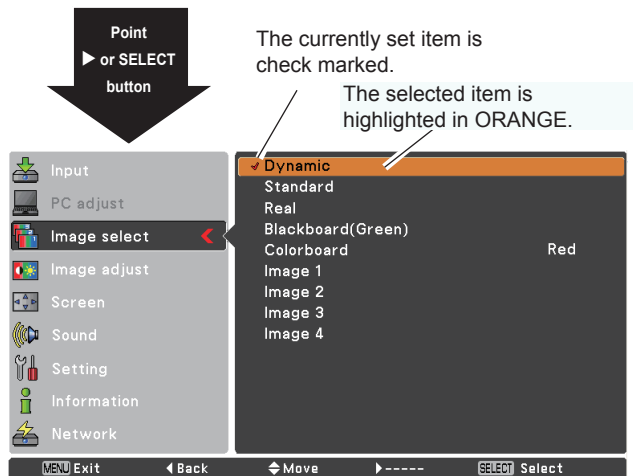
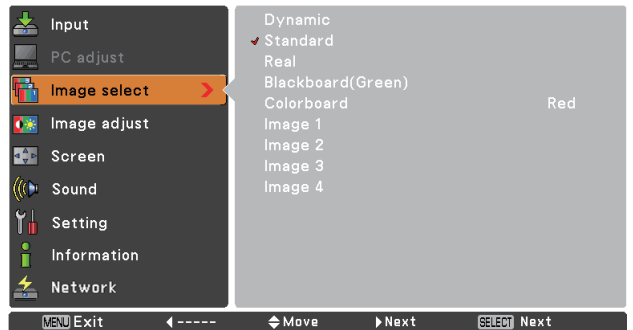

Basic Operation

Menu Bar

For detailed functions of each menu, see “Menu Tree” on pages 68-69.



① Input

Used to select an input source from **Computer 1**, **Computer 2**, **Video** or **S-video** . (pp.27-28,37-38).

② PC adjust

Select **Fine sync.**, **Total dots**, **Horizontal**, **Vertical**, **Clamp**, **Display area H**, **Display area V** and **Auto PC adj.** to adjust the parameters to match with the PC input signal format (p.30-32).

③ Image select

For computer source, used to select an image mode from among **Dynamic**, **Standard**, **Real**, **Blackboard(Green)**, **Colorboard** and **image 1 - 4** (p.33).

For Video source, used to select an image mode among **Dynamic**, **Standard**, **Cinema**, **Blackboard(Green)**, **Colorboard** and **Image 1- 4** (p.40).

④ Image adjust

For computer source, used to adjust computer image [**Contrast**, **Brightness**, **Color temp.**, **White balance (R/G/B)**, **Sharpness** and **Gamma**] (pp.34-35).

For Video source, used to adjust picture image [**Contrast**, **Brightness**, **Color**, **Tint**, **Color temp.**, **White balance (R/G/B)**, **Sharpness**, **Gamma**, **Noise reduction** and **Progressive**] (pp.41-42).

⑤ Screen

For computer source, used to adjust size of the image [**Normal**, **True**, **Wide**, **Full**, **Custom** and **Digital zoom +/-**] (pp.35-36). For Video source, used to set size of image [**Normal**, **Wide**, **Custom**] (p.43).

⑥ Sound

Used to adjust the volume or mute the sound (p.24).

⑦ Setting

Used to set the projector's operating configurations (pp.44-57).

⑧ Information

Display the input source information: **Input** , **H-sync freq.**, **V-sync freq.**, **Screen**, **Language**, **Lamp status**, **Lamp counter** , **Power management**, **Keylock**, **PIN code lock** and **Remote control** (p.58).

⑨ Network

See owner's manual of “Network Set-up and Operation”.

⑩ Guide

The key operation is displayed.

Zoom and Focus Adjustment

Rotate the Zoom Ring to zoom in and out.
 Rotate the Focus Ring to adjust the focus of the image.

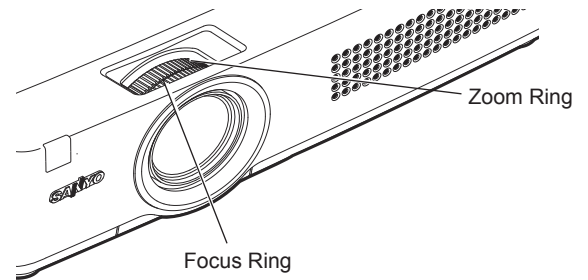

Auto Setup Function

Auto setup function is provided to automatically execute the setting of Auto setup (includes Input search, Auto PC adj. and Auto Keystone functions) in the setting menu by just pressing the AUTO SETUP button on the top control or the AUTO SET button on the remote control. Refer to page 45 for the setting of the Auto setup function.

✓ Notes:

- Auto Keystone corrects vertical distortion only; it does not correct horizontal distortion.
- Auto Keystone cannot work when Ceiling feature is set to **On** in the Setting menu (p.50).
- Perfect correction of the image distortion cannot be ensured with the Auto setup function. If the distortion cannot be corrected properly by pressing the AUTO SETUP or AUTO SET button, adjust manually by pressing the KEYSTONE button on the remote control or selecting Keystone in the Setting menu (p.46).
- **Fine sync.**, **Total dots**, **Horizontal** and **Vertical** position of some computers cannot be fully adjusted with the Auto PC Adjustment function. When the image is not provided properly with this operation, manual adjustments are required (pp.31-32).

Top Control

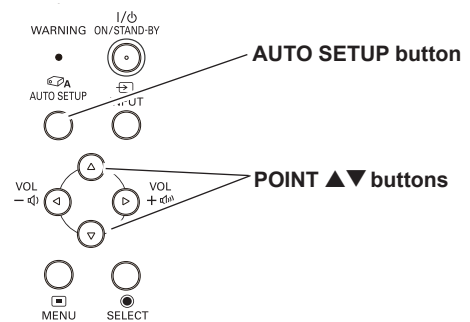

Remote Control

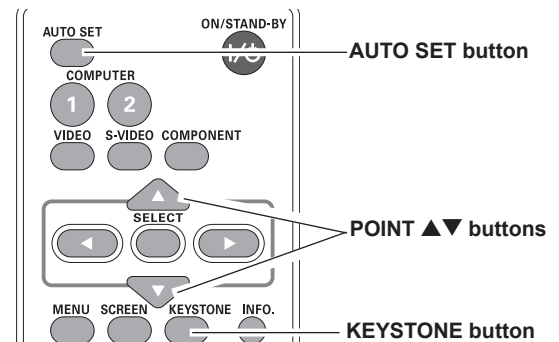

Keystone Correction

If a projected picture still has keystone distortion after pressing the AUTO SETUP button on the top control or the AUTO SET button on the remote control, correct the image manually as follows:

Press the KEYSTONE button on the remote control. The Keystone dialog box appears. Use the Point ▲▼ buttons to correct keystone distortion. The keystone adjustment can be stored (see page 46).

Reduce the upper width with the Point ▲ button.

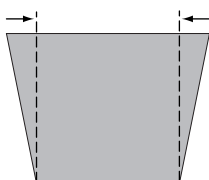

Reduce the lower width with the Point ▼ button.

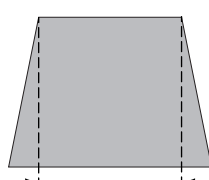

- The white arrows indicate that there is no correction.
- A red arrow indicates the direction of correction.
- An arrow disappears at the maximum correction.
- If you press the KEYSTONE button on the remote control once more while the keystone dialog box is being displayed, the keystone adjustment will be canceled.
- The adjustable range is limited depending on the input signal.

Basic Operation

Sound Adjustment

Direct Operation

Volume

Press the VOLUME+/- buttons on the top control or on the remote control to adjust the volume. The volume dialog box appears on the screen for a few seconds.

Mute

Press the MUTE button on the remote control to select **On** to temporarily turn off the sound. To turn the sound back on, press the MUTE button again to select **Off** or press the VOLUME +/- buttons. The Mute function is also effective for the AUDIO OUT jack.

Menu Operation

- 1 Press the MENU button to display the On-Screen Menu. Use the Point ▲▼ buttons to select **Sound**. Press the SELECT button to access the submenu items.
- 2 Use the Point ▲▼ buttons to select the desired submenu item and press the SELECT button to access the selected item.

Volume

Press the Point ▲ button to turn up the volume; press the Point ▼ button to turn down the volume.

Mute

Press the SELECT button to switch the mute function **On/Off**. When the sound is turned off, **On** is displayed. Press the VOLUME +/- buttons again to turn the sound back on.

Top Control

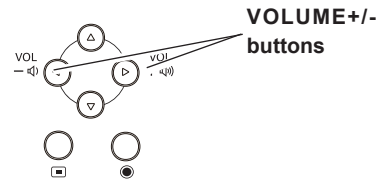

Remote Control

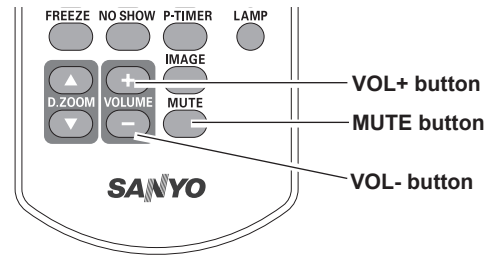

Volume Dialog Box

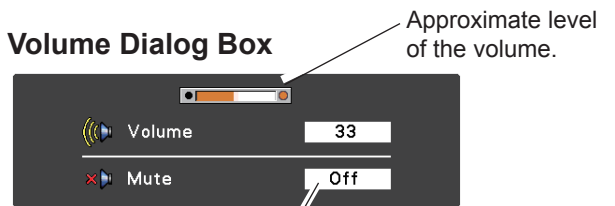

Press the MUTE button to set the Mute function **On** or **Off**. The dialog box disappears after 4 seconds.

Sound Menu

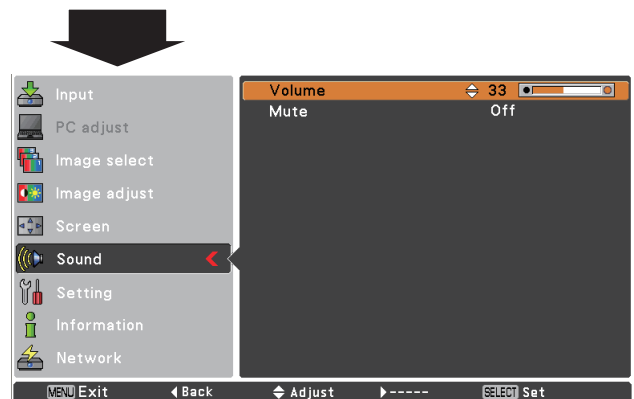
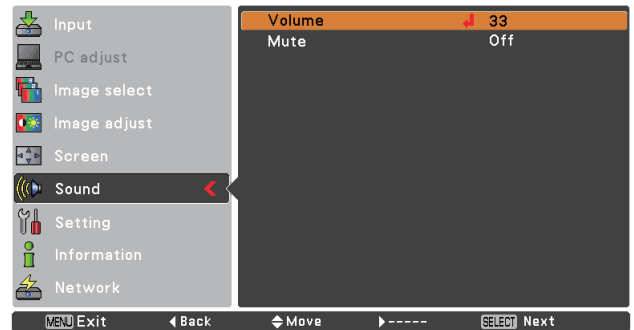

Remote Control Operation

Using the remote control for some frequently used operations is advisable. Just pressing one of the buttons enables you to make the desired operation quickly without calling up the On-Screen Menu.

COMPUTER 1/2, VIDEO, S-video and COMPONENT buttons

Press the COMPUTER 1/2, VIDEO, S-video and COMPONENT buttons on the remote control to select the input source. See pages 27-28,37-38 for details.

FREEZE button

Press the FREEZE button on the remote control to freeze the picture on the screen. To cancel the Freeze function, press the FREEZE button again or press any other button.

INFO. button

Display the input source information: **Input**, **H-sync freq.**, **V-sync freq.**, **Screen**, **Language**, **Lamp status**, **Lamp counter**, **Power management**, **Keylock**, **PIN code lock** and **Remote control** (p.58).

D.ZOOM buttons

Press the D.ZOOM buttons on the remote control to enter to the Digital zoom +/- mode. See page 36 for details.

LAMP button

Press the LAMP button on the remote control to select the lamp mode for changing the brightness on the screen.

- 💡 Normal Normal brightness
- 💡 Eco Lower brightness reduces the lamp power consumption and extends the lamp life.

Remote Control

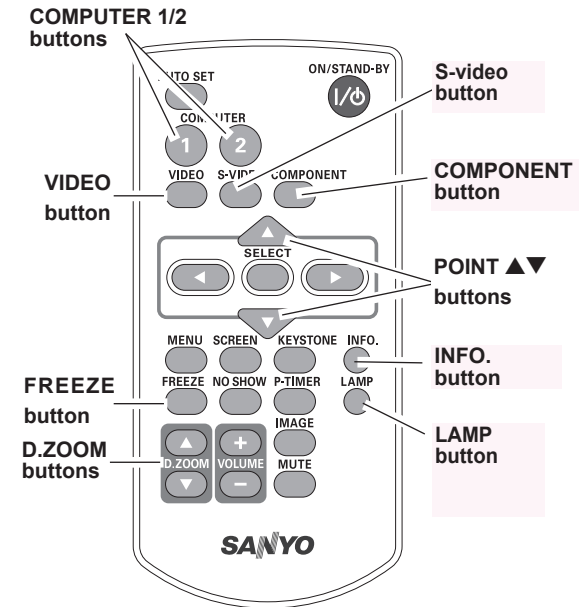

✓ **Note:**

See the next page for the description of other buttons.

Basic Operation

NO SHOW button

Press the NO SHOW button on the remote control to black out the image. To restore to normal, press the NO SHOW button again or press any other button. The screen changes each time you press the NO SHOW button as follows.

black out → normal → black out → normal →.....

P-TIMER button

Press the P-TIMER button on the remote control. The P-Timer display **00:00** appears on the screen and the countdown starts (00:00–59:59).

To stop the countdown, press the P-TIMER button. To cancel the P-Timer function, press the P-TIMER button again.

IMAGE button

Press the IMAGE button on the remote control to select a desired image mode of the screen. See pages 33, 40 for details.

SCREEN button

Select the screen size (See pages 35-36, 43 for details).

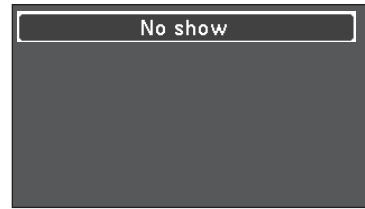

No show disappears after 4 seconds.



P-Timer display

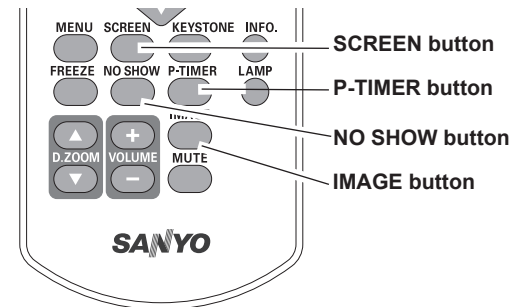

✓ **Note:**

See the previous page for the description of other buttons.

Computer Input

Input Source Selection (Computer 1: RGB / Component / RGB(Scart))

Direct Operation

Choose **Computer 1(RGB)** or **Computer 1(RGB(Scart))** by pressing the INPUT button on the top control or press the COMPUTER 1 button on the remote control.

Before using INPUT button, correct input source should be selected through Menu operation as described below.

Remote Control

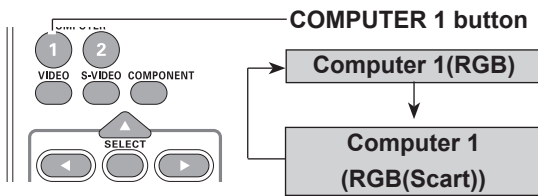

Top Control

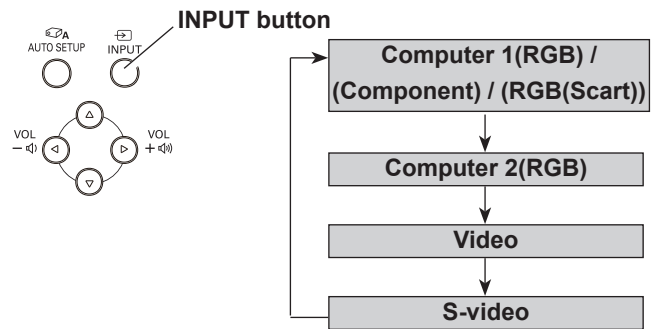

Menu Operation

- 1 Press the MENU button to display the On-Screen Menu. Use the Point ▲▼ buttons to select **Input** and then press the Point ► or the SELECT button.
- 2 Use the Point ▲▼ buttons to select **Computer 1**.
- 3 When **Computer 1** is selected, press the Point ► to access the submenu items. Use the Point ▲▼ buttons to select the RGB input source and then press the SELECT button.

Input Menu

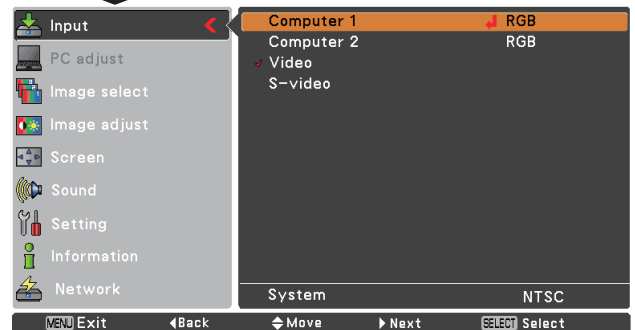
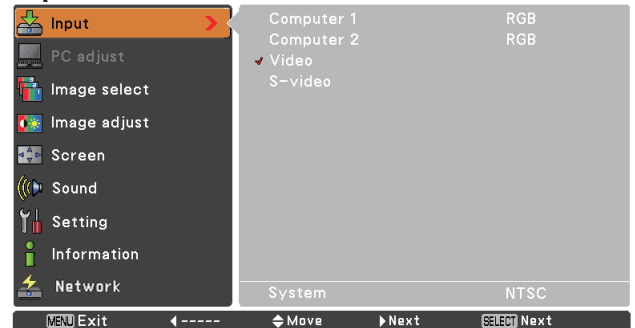

✓ Note:

When the Input Search function is set to **On1** or **On2** in the Auto setup function, the input signal will be searched automatically (p.45).

Computer Input

Input Source Selection (Computer 2: RGB)

Direct Operation

Choose **Computer 2(RGB)** by pressing the INPUT button on the top control or press the COMPUTER 2 button on the remote control.

Remote Control

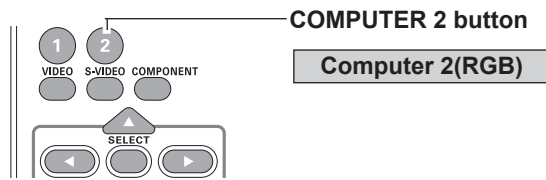

Top Control

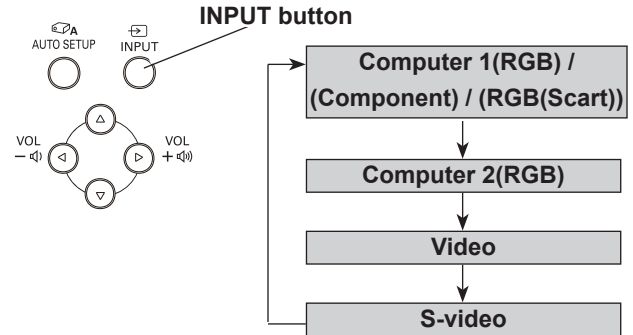

Menu Operation

- 1 Press the MENU button to display the On-Screen Menu. Use the Point ▲▼ buttons to select **Input** and then press the Point ► or the SELECT button.
- 2 Use the Point ▲▼ buttons to select **Computer 2** and then press the SELECT button.
- 3 When **Computer 2** is selected, analog RGB input source will be selected directly.

Input Menu



✓ Note:

When the Input Search function is set to **On1** or **On2**, the input signal will be searched automatically (p.45).

Computer System Selection

This projector automatically tunes to various types of computers based on VGA, SVGA, XGA, SXGA, WXGA, or UXGA with its Multi-scan system and Auto PC Adjustment. If a computer is selected as a signal source, this projector automatically detects the signal format and tunes to project a proper image without any additional settings. (Signal formats provided in this projector are shown on pages 71.)

One of the following messages may appear when:

- Auto** The projector cannot recognize the connected signal conforming to the provided PC Systems. **Auto** is displayed on the System Menu box and the Auto PC Adjustment function works to display proper images. If the image is not projected properly, a manual adjustment is required (pp.31-32).
- There is no signal input from the computer. Check the connection between your computer and the projector. (See “Troubleshooting” on page 64.)
- Mode 1** The preset system is manually adjusted in the PC Adjust Menu. The adjusted data can be stored in **Mode 1–5** (pp.31-32).
- SVGA 1** PC Systems provided in this projector is chosen. The projector chooses a proper system provided in the projector and displays it.

*Mode 1 and SVGA 1 are examples.

Selecting Computer System Manually

PC system can also be selected manually.

- 1** Press the MENU button to display the On-Screen Menu. Use the Point ▲▼ buttons to select **Input** and then press the Point ► or the SELECT button.
- 2** Use the Point ▲▼ buttons to select **System** and then press the Point ► or the SELECT button.
- 3** Use the Point ▲▼ buttons to select the desired system and then press the SELECT button.

PC System Menu

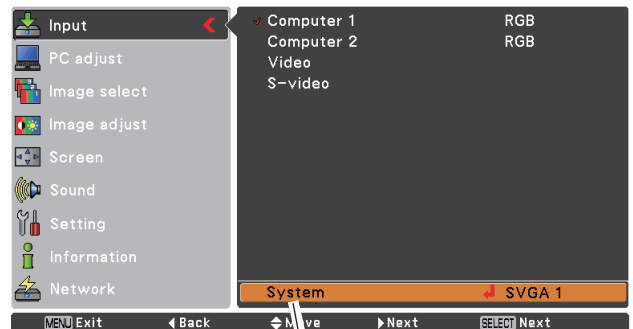

The PC System Menu Selected system is displayed.

PC System Menu

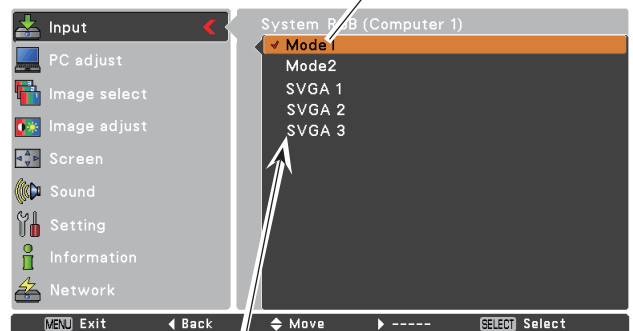

Customized **Mode (1-5)** set in the PC Adjust Menu (pp.31-32).

Systems in this dialog box can be selected.

Auto PC Adjustment

Auto PC Adjustment function is provided to automatically adjust **Fine sync.**, **Total dots**, **Horizontal** , **Vertical** , **Clamp**, **Display area H** and **Display area V** positions to conform to your computer.

Menu Operation

Auto PC Adj.

- 1 Press the MENU button to display the On-Screen Menu. Use the Point ▲▼ buttons to select **PC Adjust** and then press the Point ► button.
- 2 Use the Point ▲▼ buttons to select **Auto PC Adj.** and then press the SELECT button.

To store adjustment parameters

The adjusted parameters from the Auto PC Adjustment can be stored in the projector. Once the parameters are stored, the setting can be done just by selecting a **Mode (1–5)** in the PC System Menu (see page 29). See also “Store” on page 32.

✓ Note:

- **Fine sync.**, **Total dots**, **Horizontal** and **Vertical** position of some computers cannot be fully adjusted with the Auto PC Adjustment function. When the image is not provided properly with this operation, manual adjustments are required (pp.31-32).
- The Auto PC Adjustment cannot be operated when **480i**, **575i**, **480p**, **575p**, **720p**, **1035i**, or **1080i** is selected in the PC System Menu (p.29).

PC Adjust Menu

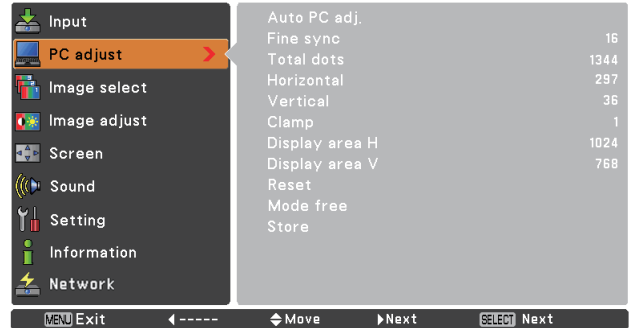

Use Point ▲▼ buttons to select **Auto PC Adj.** and press the SELECT button. **Please wait...** appears while the Auto PC adjustment is in process.

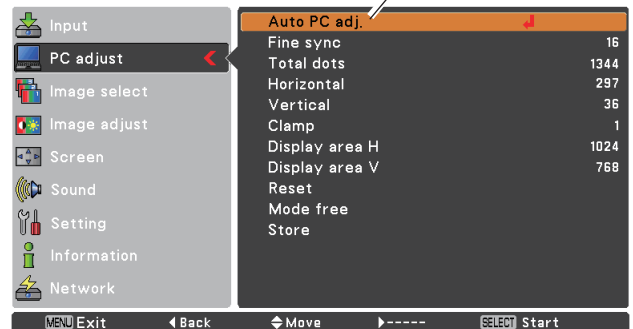

Manual PC Adjustment

Some computers employ special signal formats which may not be tuned by Multi-scan system of this projector. Manual PC Adjustment enables you to precisely adjust several parameters to match those signal formats. The projector has five independent memory areas to store those parameters manually adjusted. It allows you to recall the setting for a specific computer.

- 1 Press the MENU button to display the On-Screen Menu. Use the Point ▲▼ buttons to select **PC Adjust** and then press the Point ► or the SELECT button.
- 2 Use the Point ▲▼ buttons to select the desired item and then press the SELECT button to display the adjustment dialog box. Use the Point ◀▶ buttons to adjust the setting value.

Fine sync.

Use the Point ◀▶ buttons to adjust the value, eliminating a flicker from the image displayed (from 0 to 31).

Total dots

Use the Point ◀▶ buttons to adjust the number of total dots in one horizontal period to match your PC image.

Horizontal

Use the Point ◀▶ buttons to adjust the horizontal picture position.

Vertical

Use the Point ◀▶ buttons to adjust the vertical picture position.

Clamp

Use the Point ◀▶ buttons to adjust the clamp level. When the image has dark bars, try this adjustment.

Display area H

Use the Point ◀▶ buttons to adjust the horizontal area displayed by this projector.

Display area V

Use the Point ◀▶ buttons to adjust the vertical area displayed by this projector.

PC Adjust Menu

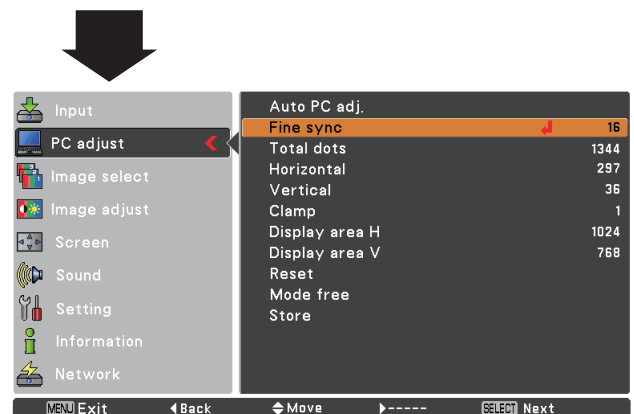
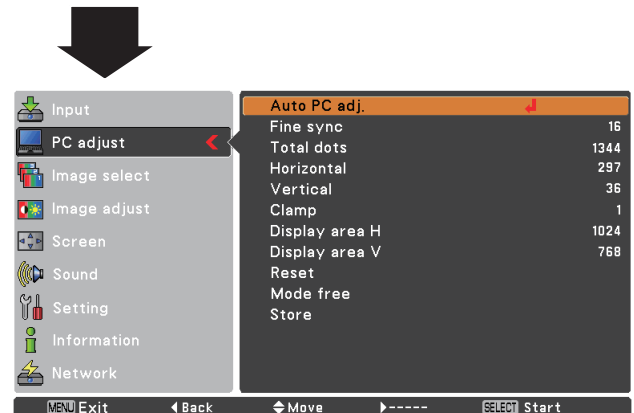
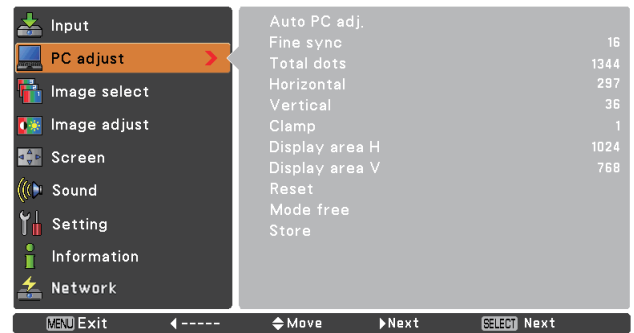

Computer Input

Reset

To reset the adjusted data, select **Reset** and press the SELECT button. A confirmation box appears and then select **Yes**. All adjustments will return to their previous figures.

Mode free

To clear the stored data, select **Mode free** and then press the SELECT button. Move the highlight to the Mode that you want to clear and then press the SELECT button.

Store

To store the adjusted data, select **Store** and then press the SELECT button. Move the red arrow pointer to one of the Modes 1 to 5 in which you want to store, and then press the SELECT button.

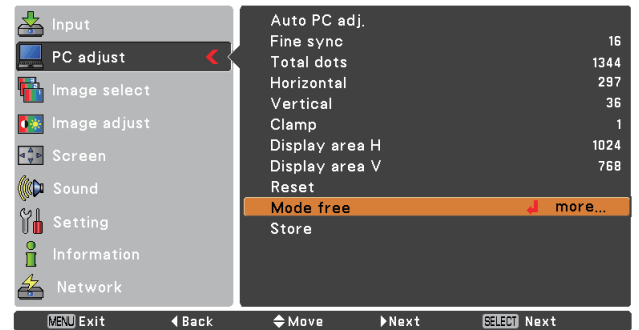

This Mode has stored parameters.

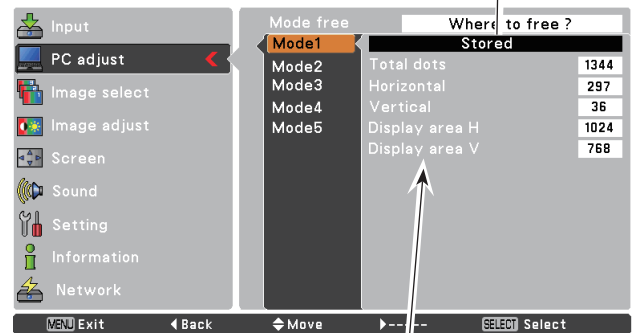

Values of **Total dots**, **Horizontal**, **Vertical**, **Display area H**, and **Display area V**.

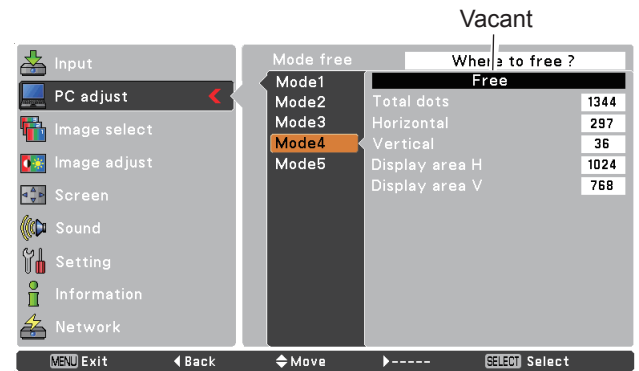

Press MENU button to close this dialog box.

Press SELECT button to store adjusted data

✓ Note:

- **Display area (H/V)** cannot be selected when **480i**, **575i**, **480p**, **575p**, **720p**, **1035i**, or **1080i** is selected in the PC System Menu (p.29).
- When input computer signal to the projector, **PC adjust** will become available.

Image Mode Selection

Direct Operation

Select the desired image mode among **Dynamic**, **Standard**, **Real**, **Blackboard (Green)**, **Colorboard**, **Image 1**, **Image 2**, **Image 3**, and **Image 4** by pressing the IMAGE button on the remote control.

Remote Control

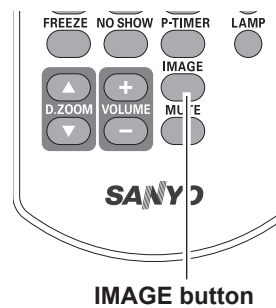
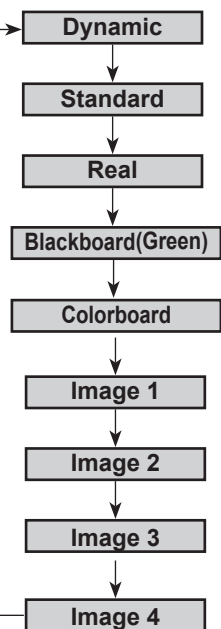

IMAGE button



Menu Operation

- 1 Press the MENU button to display the On-Screen Menu. Use the Point ▲▼ buttons to select **Image Select** and then press the Point ► or the SELECT button.
- 2 Use the Point ▲▼ buttons to select the desired item and then press the SELECT button.

Dynamic

For viewing pictures in a bright room.

Standard

Normal picture mode preset on the projector.

Real

Picture mode with improved halftone for graphics.

Blackboard (Green)

For the image projected on a blackboard.
This mode help enhance the image projected on a blackboard. This is mainly effective on a green colored board, not truly effective on a black colored board.

Colorboard

At the time of simple projection on the colored wall, you can get the close color image to the color image projected on a white screen by selecting the similar color to the wall color from the preset four colors.

Image 1–4

For viewing with the user preset image mode in the Image Adjust Menu (see pages 34-35). This Image memory is provided in each computer, component, S-video and video input source.

Image Select Menu

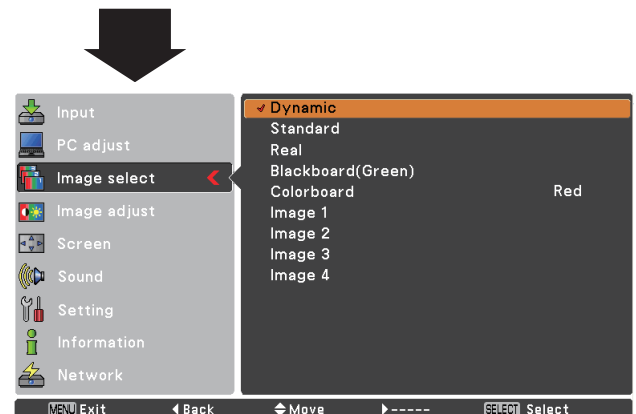
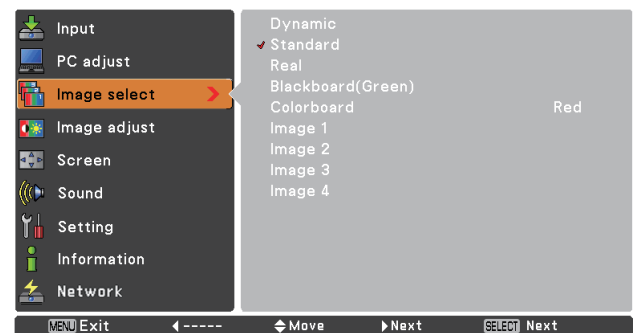

Image Adjustment

- 1 Press the MENU button to display the On-Screen Menu. Use the Point ▲▼ buttons to select **Image Adjust** and then press the Point ► or the SELECT button.
- 2 Use the Point ▲▼ buttons select the desired item and then press the SELECT button to display the adjustment dialog box. Use the Point ◀▶ buttons to adjust the setting value.

Contrast

Press the Point ◀ button to decrease the contrast; press the Point ► button to increase the contrast (from 0 to 63).

Brightness

Press the Point ◀ button to decrease the brightness; press the Point ► button to increase the brightness (from 0 to 63).

Color temp.

Use the Point ◀▶ buttons to select the desired Color temp. level (XLow, Low, Mid, or High).

White balance (Red)

Press the Point ◀ button to lighten red tone; press the Point ► button to deepen red tone (from 0 to 63).

White balance (Green)

Press the Point ◀ button to lighten green tone; press the Point ► button to deepen green tone (from 0 to 63).

White balance (Blue)

Press the Point ◀ button to lighten blue tone; press the Point ► button to deepen blue tone (from 0 to 63).

Sharpness

Press the Point ◀ button to decrease the sharpness of the image; press the Point ► button to increase the sharpness of the image (from 0 to 15).

Gamma

Use the Point ◀▶ buttons to adjust the gamma value to obtain a better balance of contrast (from 0 to 15).

Reset

To reset the adjusted data, select Reset and press the SELECT button. A confirmation box appears and then select **Yes**. All adjustments will return to their previous figures.

Image Adjust Menu

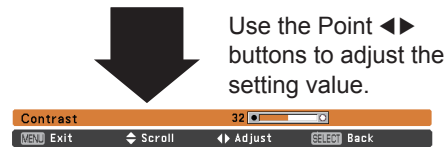
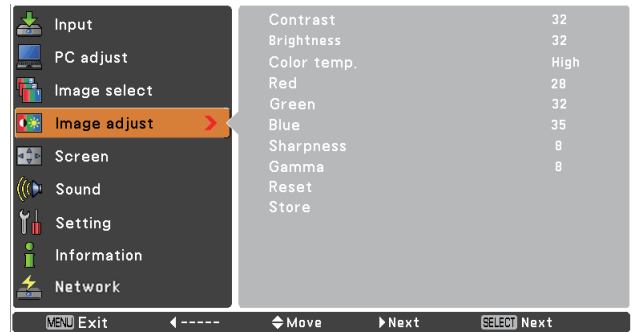

✓ Note:

- When White balance **Red**, **Green** or **Blue** is adjusted, **Color temp.** will change to **User**.
- When **Blackboard(Green)** or **Colorboard** is selected in Image select, **Color temp.** will change to **Blackboard** or **Colorboard**.

Store

To store the adjusted data, select **Store** and press the SELECT button. Use the Point ▲▼ buttons to select one from **Image 1** to **4** and press the SELECT button.

A confirmation box appears and then select **Yes**. Stored data can be called up by selecting an **Image (1–4)** in the Image Mode Selection on page 33.

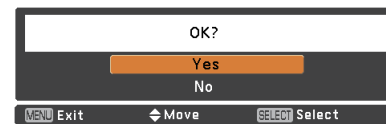

A confirmation box appears and then select **Yes**.

Screen Size Adjustment

This projector has the picture screen resize function, which enables you to customize the image size.

- 1 Press the MENU button to display the On-Screen Menu. Use the Point ▲▼ buttons to select **Screen** and then press the Point ► or the SELECT button.
- 2 Use the Point ▲▼ buttons select the desired item and then press the SELECT button .

Normal

Provide the image to fit the screen size.

True

Provide the image in its original size. When the original image size is larger or smaller than the screen size (1024 x 768), the projector enters to the panning mode automatically. Use the Point ▲▼◀▶ buttons to pan the image if it's larger than the screen size. When adjusted, the arrows will turn red. When reached to the correction limits, the arrows will disappear.

Wide

Provide the image to fit the wide video aspect ratio (16:9) by expanding the image width uniformly. This function can be used for providing a squeezed video signal at 16:9.

Full

Provide the full screen image.

✓ Note:

- The Screen Menu, except for **Normal** and **Custom**, cannot be operated when **720p(HDTV)**, **1035i (HDTV)**, or **1080i (HDTV)** is selected in the PC System Menu (p.29).
- This projector cannot display any resolution higher than 1600 x 1200. If your computer's screen resolution is higher than it, reset the resolution to the lower before connecting to the projector.
- The image data in other than 1024 x 768 is modified to fit the screen size in initial mode.
- **True**, **Full**, and **Digital zoom +/-** cannot be selected when **480i**, **575i**, **480p**, or **575p** is selected in the PC System Menu (p.29).

Screen Menu

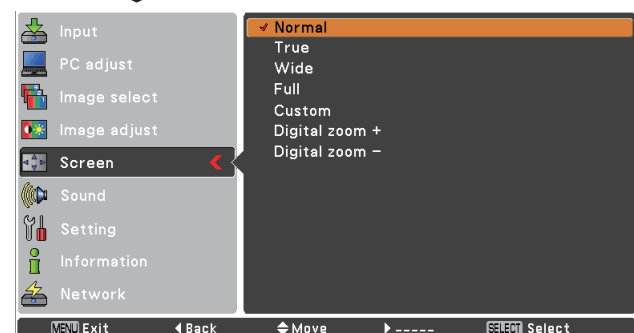
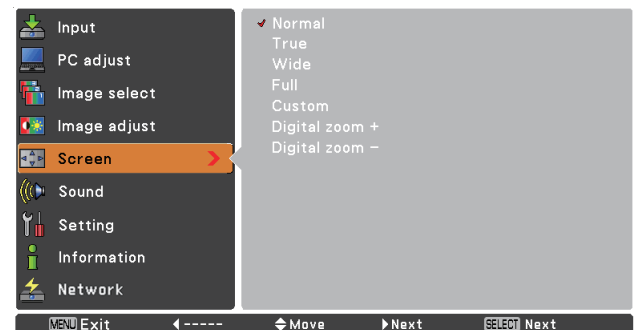

Custom

Adjust the screen scale and position manually with this function.

Press the Point ► button at **Custom** and the **Custom** is displayed on the screen, you can use the Point ▲▼ buttons to choose the item you want to adjust.

- Scale H/V** Adjust the Horizontal/Vertical screen scale.
- H&V** When set to **On**, the aspect ratio is fixed. The **Scale V** appears dimmed and becomes unavailable. Adjust **Scale H**, then the screen scale is automatically modified based on the aspect ratio.
- Position H/V** Adjust the Horizontal/Vertical screen position.
- Common** Save the adjusted scale or position to all the inputs. Press the SELECT button at **Common** to display a confirmation box. To save the scale or position, press the SELECT button at **Yes**. When **Custom** is selected, the saved scale or position is used.
- Reset** Reset the all adjusted values. Press the SELECT button at **Reset** to display a confirmation box. To reset, press the SELECT button at **Yes**.



✓ Note:

- When no signal is detected, **Normal** is set automatically and the Aspect dialog box disappears.
- The adjustable range for **Scale H/V** and **Position H/V** is limited depending on the input signal.

Remote Control

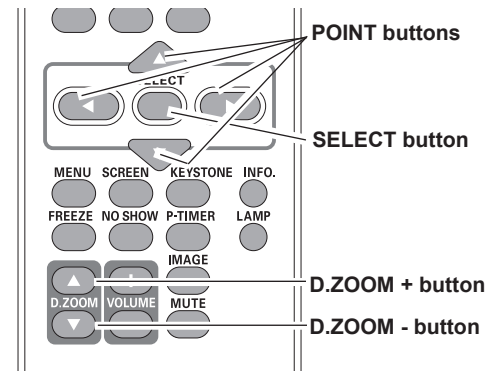

✓ Note:

- The panning function may not operate properly if the stored Mode in the PC Adjust Menu is used (p.32).
- The minimum compression ratio is limited depending on the input signal, when the Keystone function is working or when the custom is selected for the screen size.
- **True**, **Full**, and **Digital zoom +/-** cannot be selected when **480i**, **575i**, **480p**, or **575p** is selected in the PC System Menu (p.29).
- **Digital zoom +/-** cannot be selected when **Full** or **True** is selected.

For zooming in and out the images

Digital zoom +

Select **Digital zoom +**. The On-Screen Menu disappears and **D. zoom +** appears. Press the SELECT button to expand the image size. Use the Point ▲▼◀▶ buttons to pan the image. The Panning function can work only when the image is larger than the screen size.

A projected image can be also expanded by pressing the D.ZOOM ▲ or the SELECT button on the remote control.

Digital zoom -

Select **Digital zoom -**. The On-Screen Menu disappears and **D. zoom -** appears. Press the SELECT button to compress image size.

The projected image can be also compressed by pressing the D.ZOOM ▼ or the SELECT button on the remote control.

To exit the Digital zoom +/- mode, press any button except the D.ZOOM ▲▼ and the SELECT buttons.

To return to the previous screen size, select a screen size from the Screen Size Adjustment Menu or select an input source from the Input Source Selection Menu (see pages 27-28) again, or adjust the screen size with the D.ZOOM ▲▼ buttons.

Video Input

Input Source Selection (Video, S-video)

Direct Operation

Choose **Video** or **S-video** by pressing the INPUT button on the top control, or the VIDEO button or the S-video button on the remote control.

Before using INPUT button, correct input source should be selected through menu operation as described below.

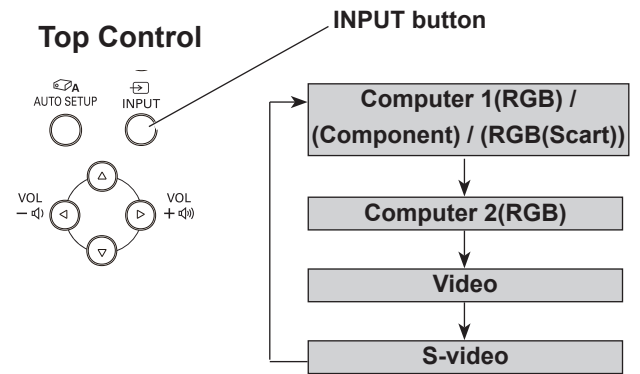

Remote Control

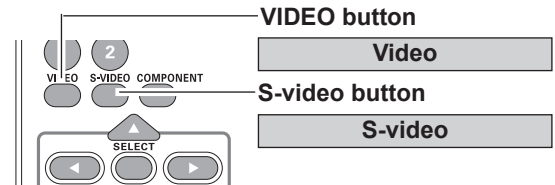

Menu Operation

- 1 Press the MENU button to display the On-Screen Menu. Use the Point ▲▼ buttons to select **Input** and then press the Point ► or the SELECT button.
- 2 Use the Point ▲▼ buttons to select either **Video** or **S-video** and then press the SELECT button.

Video

When video input signal is connected to the VIDEO jack, select Video.

S-video

When video input signal is connected to the S-VIDEO jack, select S-video.

Input Menu

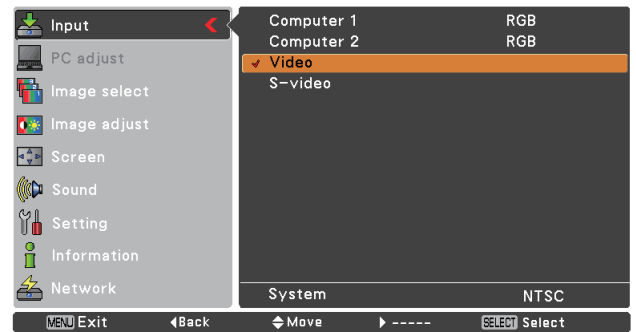

✓ Note:

When the Input Search function is set to **On1** or **On2** in the Auto setup function, the input signal will be searched automatically (p.45).

Input Source Selection (Component, RGB Scart 21-pin)

Direct Operation

Choose **Computer 1(Component)** or **Computer 1(Scart)** by pressing the INPUT button on the top control or press the COMPUTER 1 or the COMPONENT button on the remote control.

Before using INPUT button, correct input source should be selected through Menu operation as described below.

Remote Control

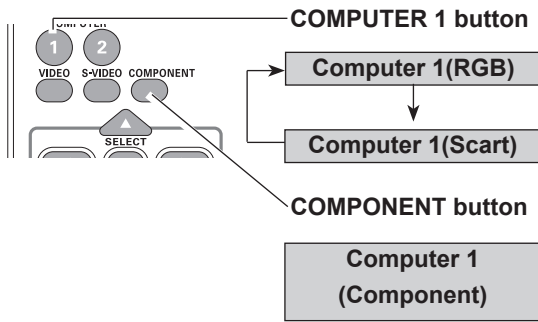

Top Control

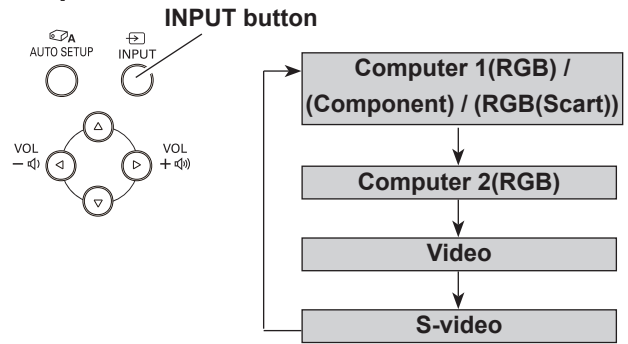

Menu Operation

- 1 Press the MENU button to display the On-Screen Menu. Use the Point ▲▼ buttons to select **Input** and then press the Point ► or the SELECT button.
- 2 Use the Point ▲▼ buttons to select **Computer 1** and then press the Point ► button.
- 3 Use the Point ▲▼ buttons to select **Component** or **RGB(Scart)** and then press the SELECT button.

Input Menu

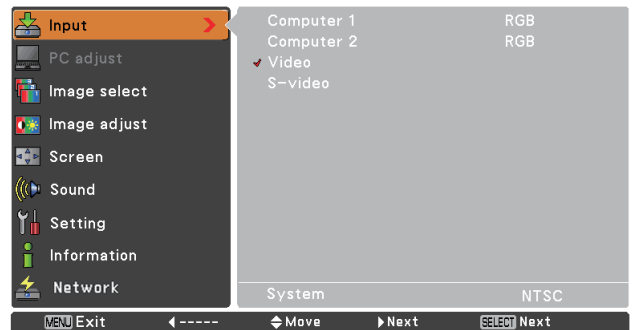

Component When the input source is coming from video equipment connected to the COMPUTER IN 1/COMPONENT IN terminal with a Component-VGA Cable, select **Component**.

RGB (Scart) When the input source is coming from video equipment connected to the COMPUTER IN 1/COMPONENT IN terminal with a Scart-VGA Cable, select **RGB (Scart)**.

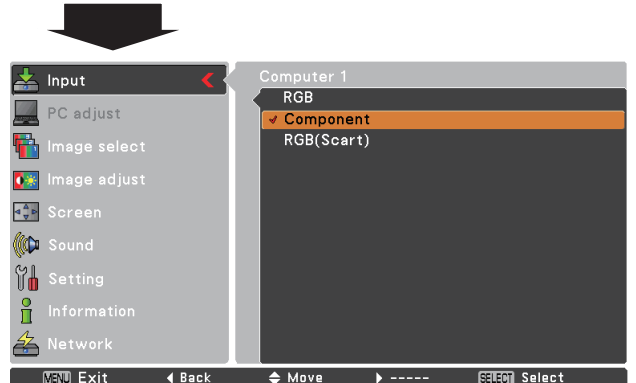
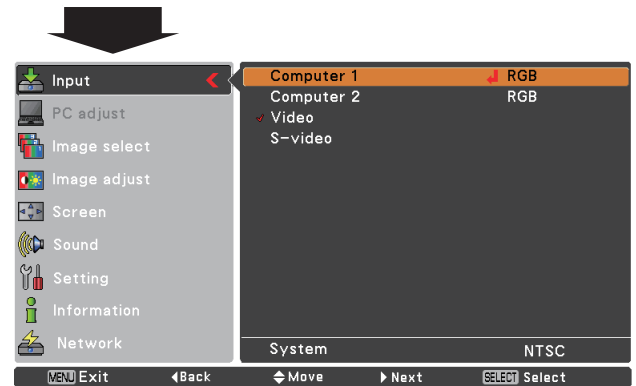

✓ **Note:**

When the Input Search function is set to **On1** or **On2**, the input signal will be searched automatically (p.45).

Video System Selection

- 1 Press the MENU button to display the On-Screen Menu. Use the Point ▲▼ buttons to select **Input** and then press the Point ► or the SELECT button.
- 2 Use the Point ▲▼ buttons to select **Video** or **S-video** or **Computer 1(Component)** and then press the SELECT button.
- 3 Use the Point ▲▼ buttons to select **System** and then press the Point ► or SELECT button. Use the Point ▲▼ buttons to select the desired system and then press the SELECT button.

Video or S-video

Auto

The projector automatically detects an incoming video system, and adjusts itself to optimize its performance. When Video System is **PAL-M** or **PAL-N**, select the system manually.

PAL/SECAM/NTSC/NTSC4.43/PAL-M/PAL-N

If the projector cannot reproduce proper video image, select a specific broadcast signal format from among **PAL**, **SECAM**, **NTSC**, **NTSC 4.43**, **PAL-M**, and **PAL-N**.

Component

Auto

The projector automatically detects an incoming video signal, and adjusts itself to optimize its performance.

COMPONENT VIDEO SIGNAL FORMAT

If the projector cannot reproduce proper video image, select a specific component video signal format from among **480i**, **575i**, **480p**, **575p**, **720p**, **1035i**, and **1080i**.

✓**Note:**

The AV System Menu cannot be selected when selecting **RGB (Scart)**.

AV System Menu (Video or S-video)

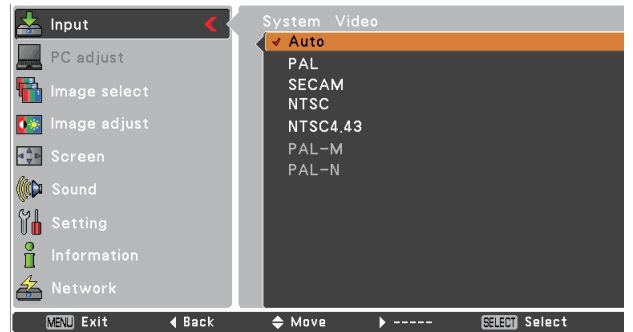
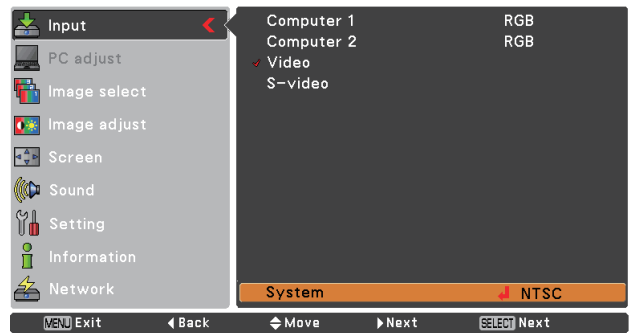

AV System Menu (Component)

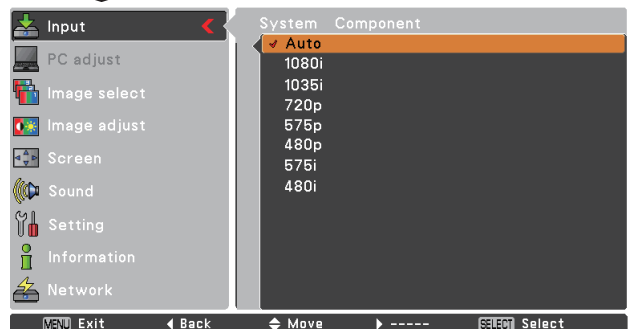
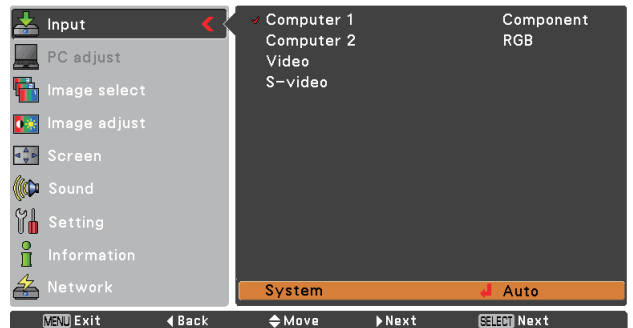

Image Mode Selection

Direct Operation

Select the desired image mode from among **Dynamic**, **Standard**, **Cinema**, **Blackboard (Green)**, **Colorboard**, **Image 1**, **Image 2**, **Image 3**, and **Image 4** by pressing the IMAGE button on the remote control.

Menu Operation

- 1 Press the MENU button to display the On-Screen Menu. Use the Point ▲▼ buttons to select **Image select** and then press the Point ► or the SELECT button.
- 2 Use the Point ▲▼ buttons to select the desired item and then press the SELECT button.

Remote Control

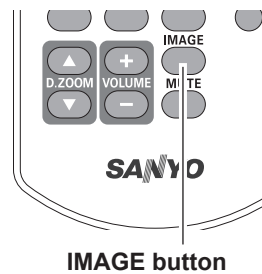
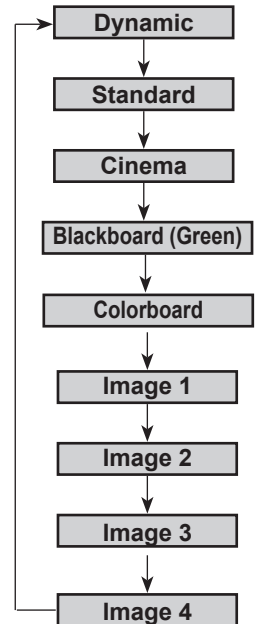

IMAGE button



Dynamic

For viewing pictures in a bright room.

Standard

Normal picture mode preset on the projector.

Cinema

Picture mode adjusted with fine tone.

Blackboard (Green)

For the image projected on a blackboard. This mode help enhance the image projected on a blackboard. This is mainly effective on a green colored board, not truly effective on a black colored board.

Colorboard

At the time of simple projection on the colored wall, you can get the close color image to the color image projected on a white screen by selecting the similar color to the wall color from the preset four colors.

Image 1–4

For viewing with the user preset image mode in the Image Adjust Menu (see pages 41–42). This Image memory is provided in each computer, component, S-video and video input source.

Image Select Menu

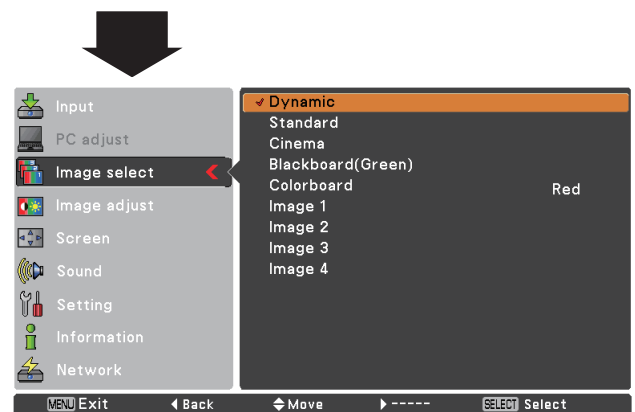
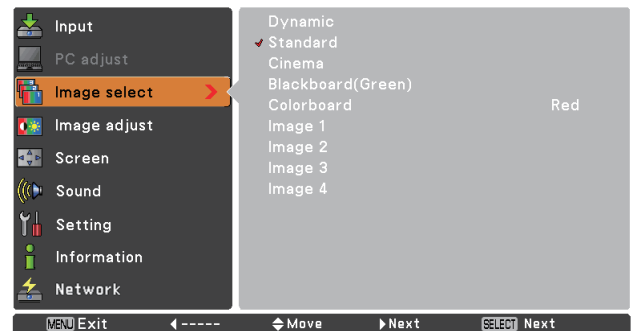

Image Adjustment

- 1 Press the MENU button to display the On-Screen Menu. Use the Point ▲▼ buttons to select the **Image Adjust** and then press the Point ► or the SELECT button.
- 2 Use the Point ▲▼ buttons select the desired item and then press the SELECT button to display the adjustment dialog box. Use the Point ◀▶ buttons to adjust the setting value.

Contrast

Press the Point ◀ button to decrease the contrast; press the Point ▶ button to increase the contrast (from 0 to 63).

Brightness

Press the Point ◀ button to decrease the brightness; press the Point ▶ button to increase the brightness (from 0 to 63).

Color

Press the Point ◀ button decrease the intensity of the color; press the Point ▶ button increase the intensity of the color (from 0 to 63).

Tint

Press the Point ◀▶ buttons to adjust the tint value to get a proper color balance (from 0 to 63).

Color temp.

Use the Point ◀▶ buttons to select the desired Color temp. level (High, Mid, Low, or XLow).

White balance (Red)

Press the Point ◀ button to lighten red tone; press the Point ▶ button to deepen red tone (from 0 to 63).

White balance (Green)

Press the Point ◀ button to lighten green tone; press the Point ▶ button to deepen green tone (from 0 to 63).

White balance (Blue)

Press the Point ◀ button to lighten blue tone; press the Point ▶ button to deepen blue tone (from 0 to 63).

✓ Note:

- When the **White balance Red, Green, or Blue** is adjusted, the Color temp. level will change to **User**.
- Tint cannot be selected when the video system is **PAL, SECAM, PAL-M, or PAL-N** (p.39).
- When Blackboard(Green) or Colorboard is selected in Image select, **Color temp.** will change to **Blackboard** or **Colorboard**.

Image Adjust Menu

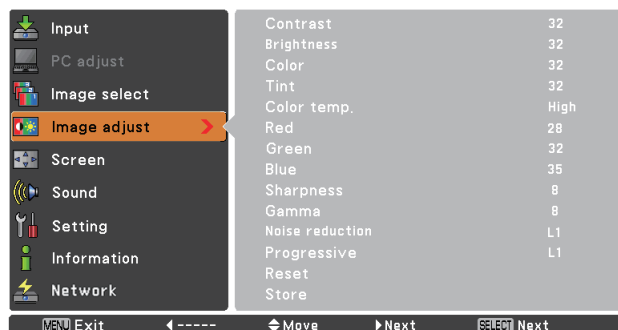

Selected Image mode



Use the Point ◀▶ buttons to adjust the setting value.



Video Input

Sharpness

Press the Point ◀ button to decrease the sharpness of the image; press the Point ▶ button to increase the sharpness of the image (from 0 to 15).

Gamma

Use the Point ◀▶ buttons to adjust the gamma value to obtain a better balance of contrast (from 0 to 15).

Noise reduction

Noise interference on the screen can be reduced. Select one of the following options to get smoother images.

- Off..... Disabled.
- L1 Lower reduction
- L2 Higher reduction

Progressive

An interlaced video signal can be displayed in progressive mode. Select one of the following options.

- Off..... Disabled.
- L1 For an active picture.
- L2 For a still picture.
- Film..... For watching a film. With this function, the projector reproduces pictures faithful to the original film quality.

Reset

To reset the adjusted data, select **Reset** and press the SELECT button. A confirmation box appears and then select **Yes**. All adjustments will return to their previous figures.

Store

To store the adjusted data, select **Store** and press the SELECT button. Use the Point ▲▼ buttons to select one from Image 1 to 4 and press the SELECT button.

A confirmation box appears and then select **Yes**. Stored data can be called up by selecting an **Image (1–4)** in the Image Mode Selection on page 33.

✓ Note:

- **Noise reduction** and **Progressive** cannot be selected when **480p**, **575p**, **720p**, **1035i**, or **1080i** is selected (p.39).
- Reset and Store icons will be displayed when any adjustment is made.

Store Menu

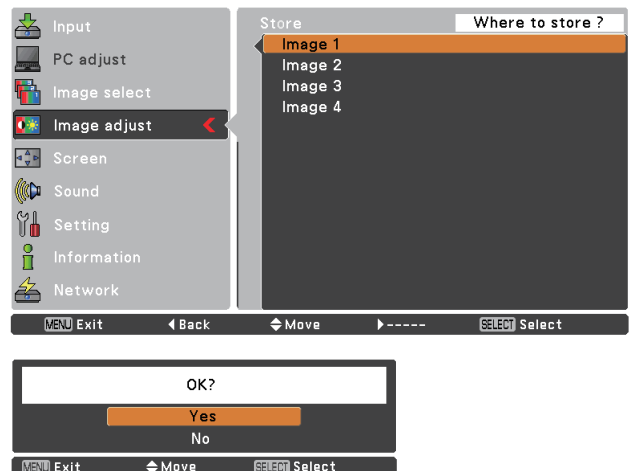

A confirmation box appears and then select **Yes**.

Screen Size Adjustment

This projector has the picture screen resize function, which enables you to customize the image size.

- 1 Press the MENU button to display the On-Screen Menu. Use the Point ▲▼ buttons to select **Screen** and then press the Point ► or the SELECT button.
- 2 Use the Point ▲▼ buttons select the desired item and then press the SELECT button.

Normal

Provide the image at the 4:3 normal video aspect ratio.

Wide

Provide the image at the 16:9 wide screen ratio.

Custom

Adjust the screen scale and position manually with this function.

Press the Point ► button at **Custom** and the **Custom** is displayed on the screen, you can use the Point ▲▼ buttons to choose the item you want to adjust.

Scale H/V Adjust the Horizontal/Vertical screen scale.

H&V When set to **On**, the aspect ratio is fixed. The **Scale V** appears dimmed and becomes unavailable. Adjust the **Scale H**, then the screen scale is automatically modified based on the aspect ratio.

Position H/V Adjust the Horizontal/Vertical screen position.

Common Save the adjusted scale or position to all the inputs. Press the SELECT button at **Common** to display a confirmation box. To save the scale or position, press the SELECT button at **Yes**. When **Custom** is selected, the saved scale or position is used.

Reset Reset the all adjusted values. Press the SELECT button at **Reset** to display a confirmation box. To reset, press the SELECT button at **Yes**.

Screen Menu



✓ Note:

- When no signal is detected, **Normal** is set automatically and the Aspect dialog box disappears.
- The adjustable range for **Scale H/V** and **Position H/V** is limited depending on the input signal.
- **Wide** cannot be operated when **720p**, **1035i**, or **1080i** is selected in the AV System Menu (p.39).

Setting

Setting

This projector has a Setting menu that allows you to set up the other various functions described below.

- 1 Press the MENU button to display the On-Screen Menu. Press the Point ▲▼ buttons to select the **Setting** and press the Point ► or SELECT button to access the submenu items.
- 2 Use the Point ▲▼ buttons to select the desired item and then press the Point ► or SELECT buttons to access the selected item.
- 3 Use the Point ▲▼ buttons select the desired item and then press the SELECT button.

Language

The language used in the On-Screen Menu is available in **English, German, French, Italian, Spanish, Portuguese, Dutch, Swedish, Finnish, Polish, Hungarian, Romanian, Russian, Chinese, Korean, Japanese, and Thai.**

Menu position

This function is used to change the position of the On-Screen Menu. Select **Menu position** and press the SELECT button.

The Menu position changes each time you press SELECT button as follows.

the top left → the top right → the center → the bottom left
→ the bottom right → the top left →.....

Setting Menu

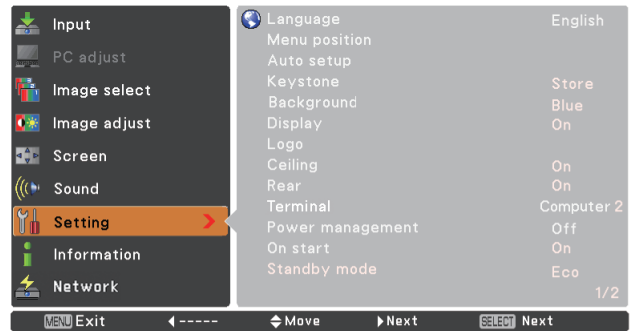

Language



Auto setup

This function enables Input search, Auto Keystone correction and Auto PC adjustment by pressing the AUTO SETUP button on the top control or the AUTO SET button on the remote control. Settings for those functions can be altered as follows:

Input search

This function detects the input signal automatically. When a signal is found, the search will stop. Use the Point ▲▼ buttons to select one of the following options.

Off Input search will not work.

On1 Input search works under the following situation.

- When pressing the AUTO SETUP button on the top control.
- When pressing the AUTO SET button on the remote control.

On2 Input search works under the following situation.

- When turning on the projector by pressing the ON/STAND-BY button on the top control or the remote control.
- When pressing the AUTO SET button on the remote control.
- When pressing the AUTO SETUP button on the top control.
- When the current input signal is cut off.*

* If the No show or Freeze function is active, cancel it to activate the Input search. It is also unavailable when On-Screen menu is displayed.

Auto PC Adj.

On Enables Auto PC Adjustment when pressing the AUTO SET button on the remote control or the AUTO SETUP button on the top control.

Off Disables Auto PC Adjustment.

Auto Keystone

Auto Always works and corrects keystone distortion according to the projector's tilt.

Manual . . . Works only when pressing the AUTO SETUP button on the top control or the AUTO SET button on the remote control.

Off Disables Auto Keystone.

✓ Note:

- While **Input search** is set to **On1** or **On2**, the status of Input and Lamp are displayed every time the signal is switched.
- Only the last selected input source can be detected.
- If the INPUT button on the top control or the COMPUTER 1/2 buttons, VIDEO or S-video or COMPONENT buttons on the remote control is pressed during Input search is in progress, Input search will stop and go back to the previous input signal.
- **Auto PC Adj.** and **Auto Keystone** cannot be set **Off** at the same time.

Auto setup

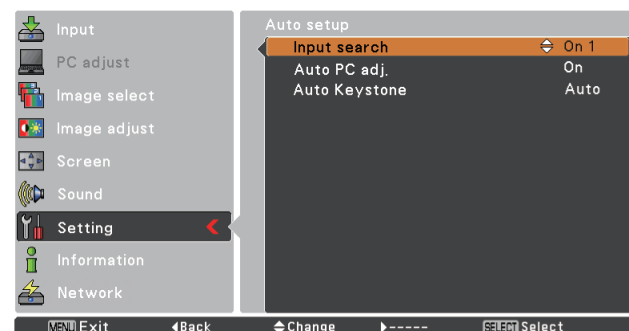
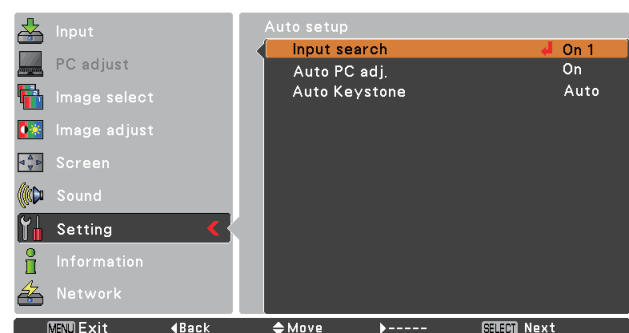
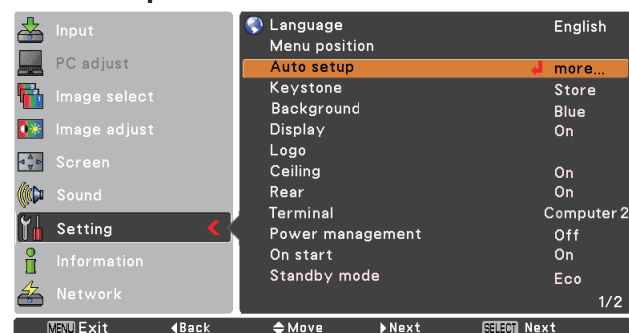

✓ Note:

- **Auto Keystone** corrects vertical distortion only, not correct horizontal distortion.
- The **Auto Keystone** function cannot work when the **Ceiling** feature is set **On** in the Setting menu (p.50).
- Perfect correction of the image distortion cannot be ensured with the Auto setup function. If the distortion is not corrected properly by pressing the AUTO SETUP or AUTO SET button, adjust manually by pressing the KEYSTONE button on the remote control or selecting **Keystone** in the Setting menu (pp.23, 46).
- **Fine sync.**, **Total dots**, **Horizontal** and **Vertical** position of some computers cannot be fully adjusted with the Auto PC Adjustment function. When the image is not provided properly with this operation, manual adjustments are required (pp.31-32).

Keystone

This function is used to store or reset the keystone correction when the AC power cord is unplugged. Use the Point ▲▼ buttons to switch between each option.

Store Keep the keystone correction even when the AC power cord is unplugged.

Reset..... Release the keystone correction when the AC power cord is unplugged.

To correct keystone distortion, press the SELECT button. **Keystone** appears on the screen. Use the Point ▲▼ buttons to correct keystone distortion (p.23).

Background

Select the background screen for when no input signal is detected. Press the Point ▲▼ buttons to switch between each option.

Blue . . . Project a blue background

Black . . Project a black background

User . . . Project an image captured in the Logo setting.

Display

This function decides whether to display On-Screen Displays.

On..... Show all the On-Screen displays. Use this function when you want to project images after the lamp becomes bright enough. The factory default setting is in this option.

Countdown Off..... Show the input image instead of the countdown when turning on the projector. Use this function when you want to project the image as early as possible even when the lamp is not bright enough.

Off..... Hide the On-Screen Displays except;

- On-Screen Menu
- **Power off?** (p.20)
- **No signal** for Power management (p.51)
- Please wait ...
- Arrows for the True function in the Screen Menu (p.35)

Keystone

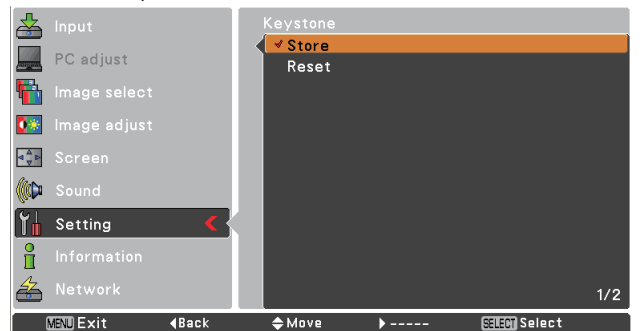
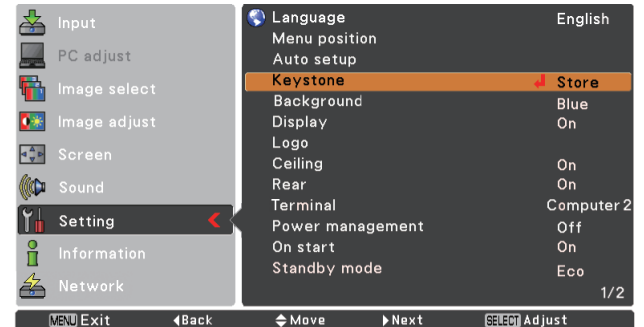

Logo (Logo and Logo PIN code lock settings)

This function allows you to customize the screen logo with **Logo select**, **Capture**, **Logo PIN code lock** and **Logo PIN code change** functions.

✓ **Note:**

When **On** is selected in the Logo PIN code lock function, **Logo select** and **Capture** functions cannot be selected.

Logo select

This function decides on the starting-up display from among following options.

- User** Show the image you captured.
- Default** Show the factory-set logo.
- Off** Show the countdown display only.

Logo select

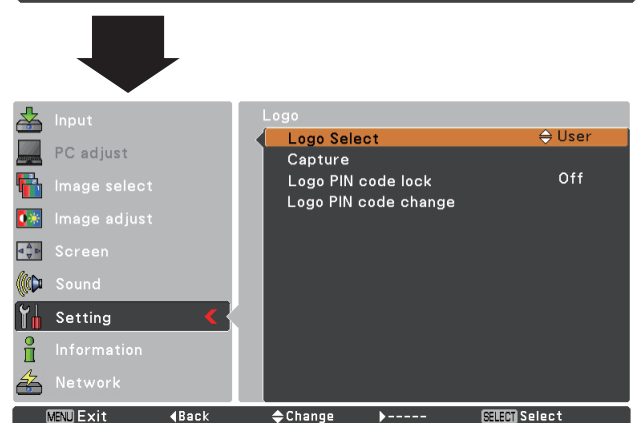
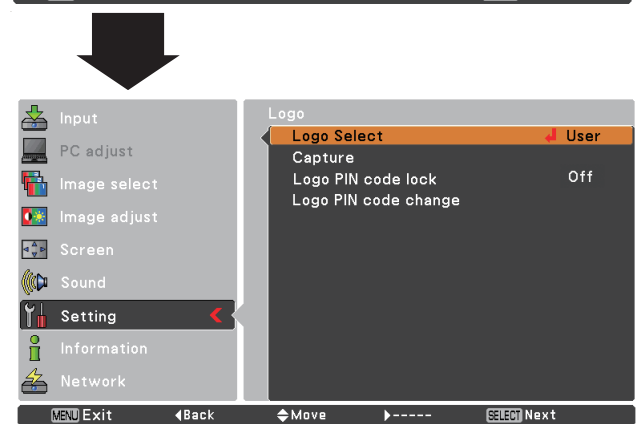
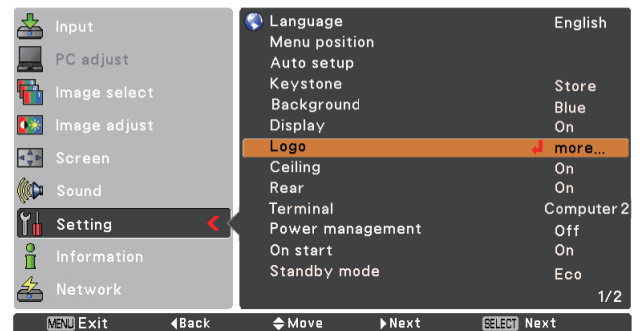

Capture

This function enables you to capture an image being projected to use it for a starting-up display or interval of presentations.

Select **Capture** and press the SELECT button. A confirmation box appears and select **Yes** to capture the projected image.

After capturing the projected image, go to the Logo select function and set it to **User**. Then the captured image will be displayed the next time you turn on the projector.

To cancel the capture function, select **Yes** in the "Quit?" confirmation box.

✓ Note:

- Before capturing an image, select **Standard** in the Image Select Menu to capture a proper image (pp.33, 40).
- A signal from a computer can be captured up to XGA (1024 x 768). A signal from video equipment can be captured except for 720p, 1035i, and 1080i.
- When capturing the image that has been adjusted by the Keystone function, the adjusted data is automatically reset and the projector captures an image without keystone correction.
- When **Logo PIN code lock** is set to **On**, **capture** cannot be selected.
- When starting to capture a new image, the previously stored image is cleared even if you cancel the capturing.
- When there is no captured image or it is interrupted while capturing an image, **User** is not included in Logo Select menu, you can only switch between **Default** and **Off**.

Logo PIN code lock

This function prevents an unauthorized person from changing the screen logo.

Off..... The screen logo can be changed freely from the Logo Menu (p.47).

On..... The screen logo cannot be changed without a Logo PIN code.

If you want to change the **Logo PIN code lock** setting, press the SELECT button and the Logo PIN code dialog box appears. Enter a Logo PIN code by following the steps below. The initial **Logo PIN code** is set to "4321" at the factory.

Capture

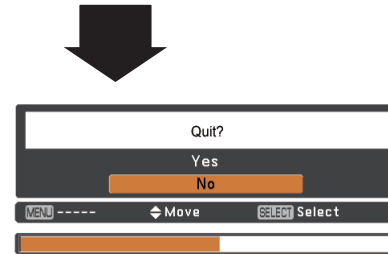
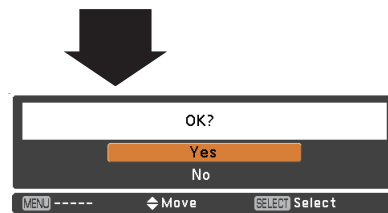
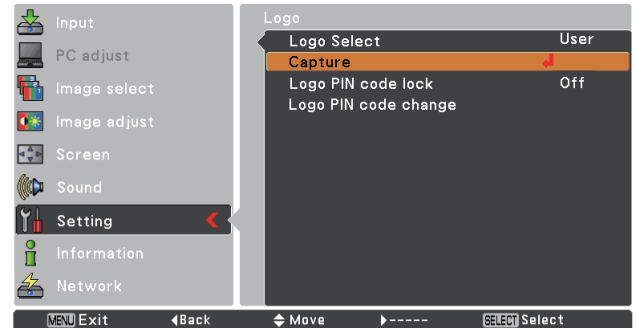

Logo PIN code lock

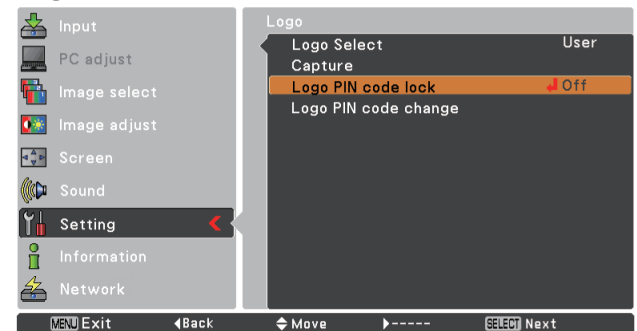

Enter a Logo PIN code

Use the Point ▲▼ buttons to enter a number. Press the Point ► button to fix the number and move the red frame pointer to the next box. The number changes to “*”. If you fixed an incorrect number, use the Point ◀ button to move the pointer to the number you want to correct, and then enter the correct number.

Repeat this step to complete entering a four-digit number.

After entering the four-digit number, move the pointer to **Set**. Press the SELECT button so that you can start to operate the projector.

If you entered an incorrect Logo PIN code, **Logo PIN code** and the number (****) will turn red for a moment. Enter the correct Logo PIN code all over again.

Change the Logo PIN code lock setting

Use the Point ▲▼ buttons to switch **On** or **Off**, and then press the SELECT button to make a choice.

Logo PIN code change

Logo PIN code can be changed to your desired four-digit number. Press the SELECT button to select **Logo PIN code change**. **Logo Pin code** dialog box appears, use the Point ▲▼ buttons to enter the correct code. The New Logo PIN code input dialog box appears. Set a new Logo PIN code, confirmation box appears, choose **Yes** to set the new Logo Pin code.

Be sure to note the new Logo PIN code and keep it on hand. If you lost the number, you could no longer change the Logo PIN code setting.

CAUTION:
WHEN YOU HAVE CHANGED THE LOGO PIN CODE, WRITE DOWN THE NEW PIN CODE IN COLUMN OF THE LOGO PIN CODE NO. MEMO ON PAGE 76, AND KEEP IT SECURELY. SHOULD THE LOGO PIN CODE BE LOST OR FORGOTTEN, THE LOGO PIN CODE SETTING CAN NO LONGER BE CHANGED.

Enter a Logo PIN code

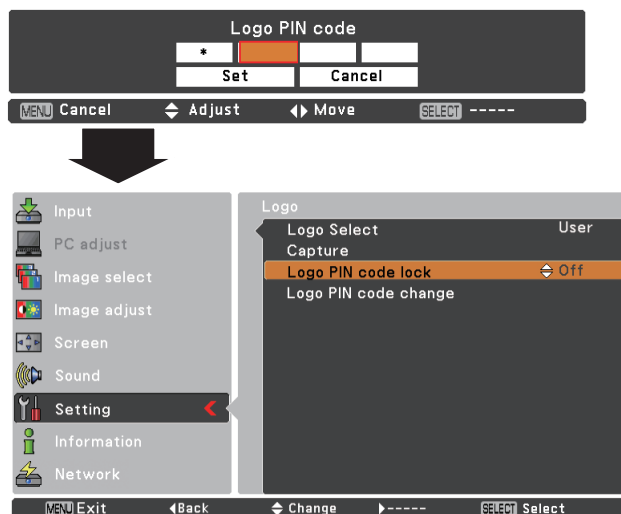

Logo PIN code change

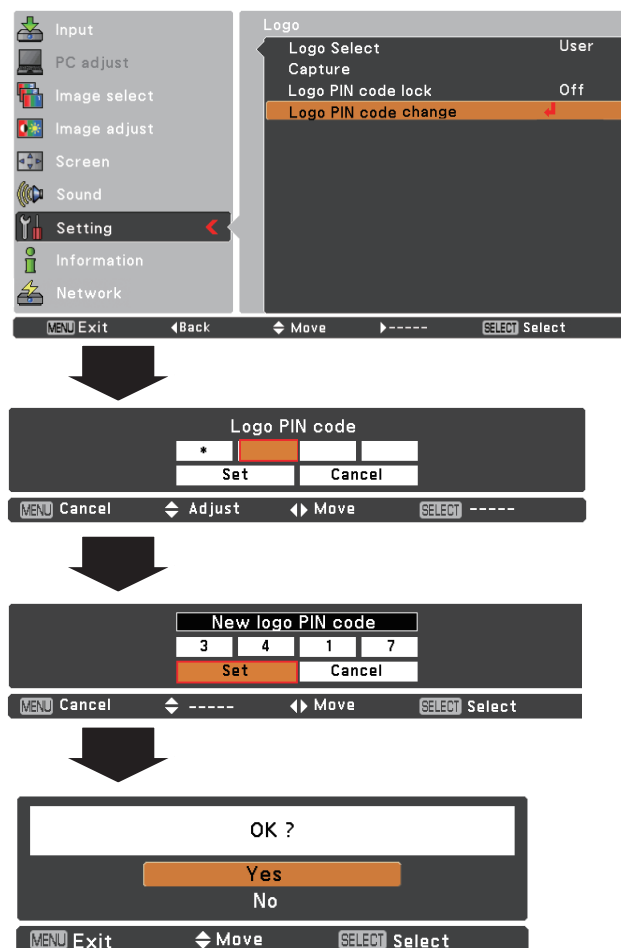

Setting

Ceiling

When this function is set to **On**, the picture will be top/bottom and left/right reversed. This function is used to project the image from a ceiling-mounted projector.

Rear

When this function is set to **On**, the picture will be left/right reversed. This function is used to project the image from rear of the screen.

Ceiling

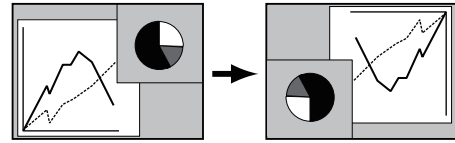

Rear

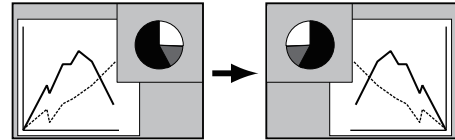

Terminal

The COMPUTER IN 2/MONITOR OUT terminal on the back of the projector is switchable for computer input or monitor output. (See page 9) Select **Computer 2** or **Monitor Out** with the Point ▲▼ buttons.

- Computer 2** . . . computer input
- Monitor Out** . . . monitor out

Terminal function is not available when selecting **Computer 2** to the input source. Change the input source to the others (**Computer1**) so that the Terminal function will be available. (p.25, 37, 38)

Terminal

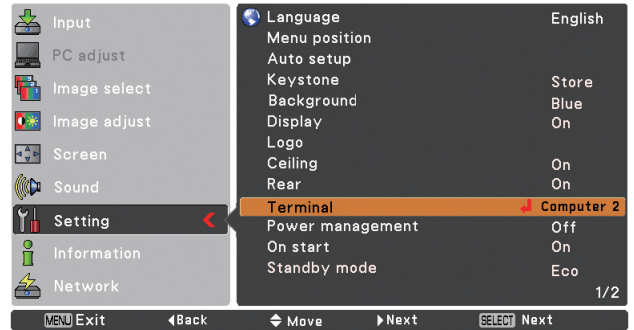

Power management

For reducing power consumption as well as maintaining the lamp life, the Power management function turns off the projection lamp when the projector is not operated for a certain period.

Select one of the following options:

Ready..... When the lamp has been fully cooled down, the POWER indicator changes to green blinking. In this condition, the projection lamp will be turned on if the input signal is reconnected or any button on the top control or remote control is pressed.

Shut down When the lamp has been fully cooled down, the power will be turned off.

Off Power management function is off.

Timer..... If the input signal is interrupted and no button is pressed for more than 30 seconds, the timer display with **No signal** appears. It starts the countdown until the lamp is turned off. Use the Point ▲▼ buttons to set the Timer(1~30min.).

✓**Note:**

Factory default is **Ready: 5 Min.**

Power management



Time left before Lamp is off.

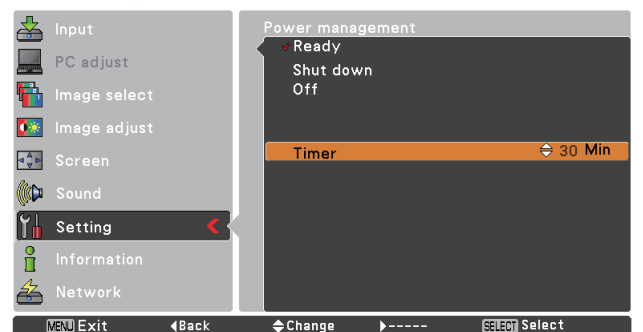
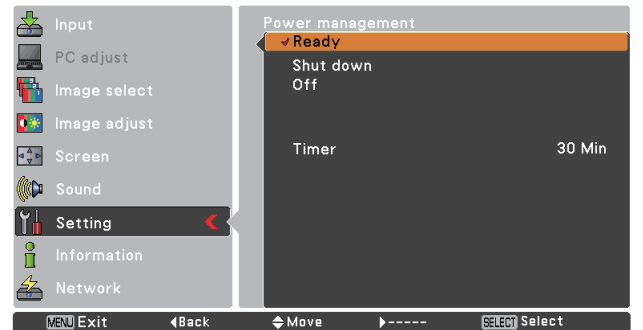
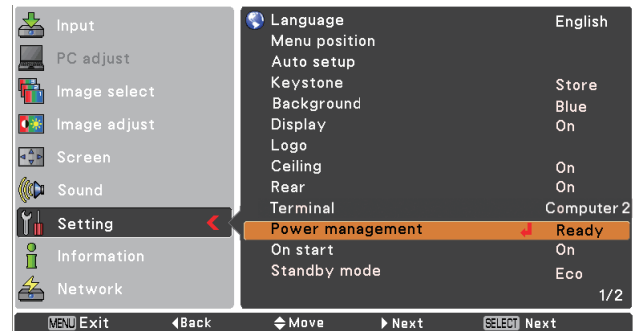

On start

When this function is set to **On**, the projector will be automatically turned on just by connecting the AC power cord to a wall outlet.

✓ Note:

Be sure to turn off the projector properly (see “Turning Off the Projector” on page 20). If the projector is turned off in the incorrect sequence, the On start function does not work properly.

Standby mode

This function is available when operating the projector via network.

Normal Supply the power to the network function even after turning off the projector. You can turn on/off the projector via network, modify network environment, and receive an e-mail about projector status while the projector is powered off.

Eco Select **Eco** when you do not use the projector via network. The projector’s network function will stop when turning off the projector.

Refer to the owner’s manual of “Network Set-up and Operation”.

✓ Note:

- Factory default is **Eco**.
- When selecting **Normal**, the cooling fans may be running depending on the temperature inside the projector even if the projector is turned off.

Closed Caption

Closed Caption is a printed version of the program sound or other information displayed on the screen. If the input signal contains closed captions, you can turn on the feature and switch the channels. Press the Point ▲▼ buttons to select **Off**, **CC1**, **CC2**, **CC3** or **CC4**.

If the closed caption is not clear, you can change the text from **Color** to **White**.

✓ Note:

The Closed Caption is available only under the situation below.

- When the input signal is NTSC of composite and S-video, and the system is set according to the signal or set on **Auto**.
- The system must be set on **NTSC** or **Auto** in Video System Selection. (P.39)
- The icon of Closed Caption is displayed in gray while it is not available.
- The Closed caption is unavailable when On-Screen menu and P-Timer are displayed.

Closed Caption

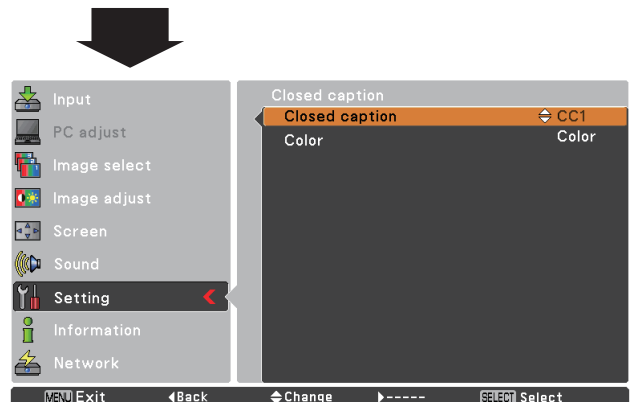
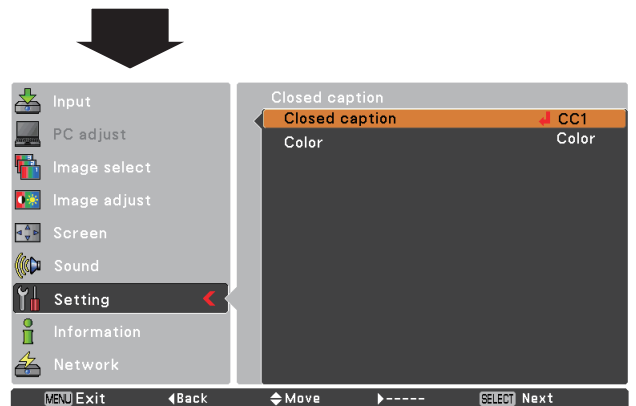
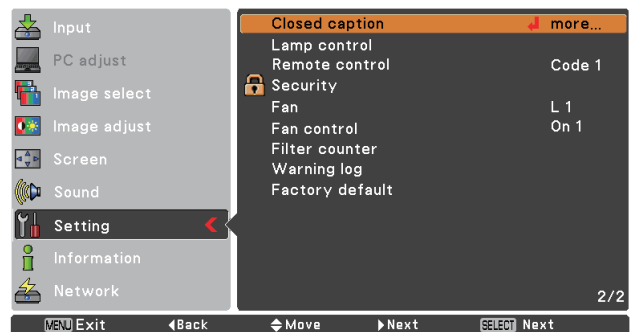

Press the Point ▲▼ buttons to select **Off**, **CC1**, **CC2**, **CC3** or **CC4**, and then Press Select button.

Lamp control

Lamp control

This function allows you to change brightness of the screen.

- 💡 **Normal** Normal brightness
- 💡 **Eco** Lower brightness reduces the lamp power consumption and extends the lamp life.

Lamp life control

Select the lamp operation when the total lighting time of a lamp exceeds the recommended total hours of use.

Mode 1 A lamp can be turned on even after exceeding the recommended total hours of use.

Mode 2 A lamp can be turned on even after exceeding the recommended total hours of use. But the projector turns off automatically after 3 minutes.

✓ Note:

- Lamp mode cannot be changed for a while after turning on the projector. Lamp needs some time to stabilize after the power is turned on. Stored lamp mode will be active after the lamp is stabilized.
- If **Mode 2** has been selected and the projection lamp exceeds the recommended total hours of use, the replacement icon will be displayed at the time of power-on. Then the projector will turn off after 3 minutes.

Lamp replacement icon

Lamp replacement



- The Lamp replacement icon will not appear when the Display function is set to Off (p.46), during **Freeze** (p.25), or **No show** (p.26).

Remote control

This projector provides two different remote control codes: the factory-set initial code (Code 1) and the secondary code (Code 2). This switching function prevents remote control interference when operating several projectors or video equipment at the same time.

When operating the projector in "Code 2", both the projector and the remote control must be switched to "Code 2".

To change the code for the projector:

Select either "Code 1" or "Code 2" in this Setting Menu.

To change the code for the remote control:

Press and hold both the MENU and IMAGE buttons together for 5 seconds or more. After changing the code, make sure the remote control operates properly.

✓ Note:

- When different codes are set on the projector and on the remote control, any operation cannot be made. In that case, switch the code on the remote control to fit the code on the projector.
- If the batteries are removed from the remote control for a long period of time, the remote control code will be reset.

Lamp life control

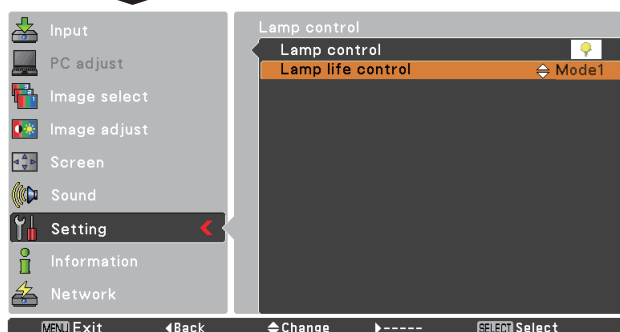
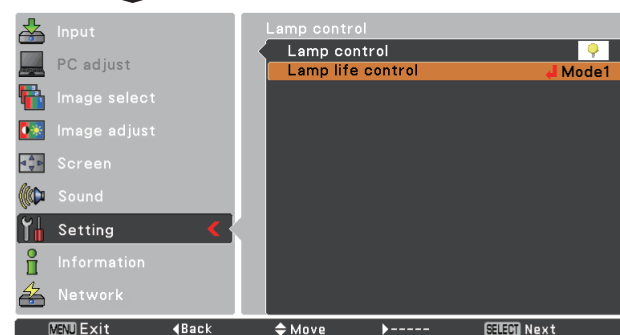
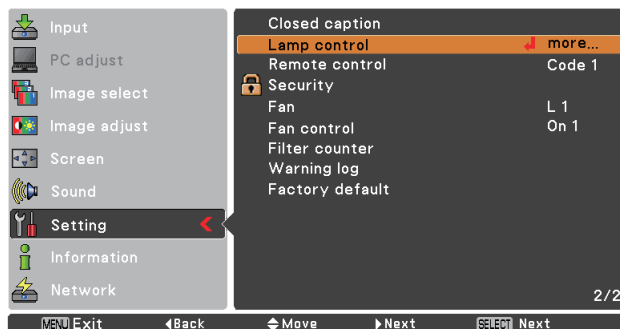

Remote control

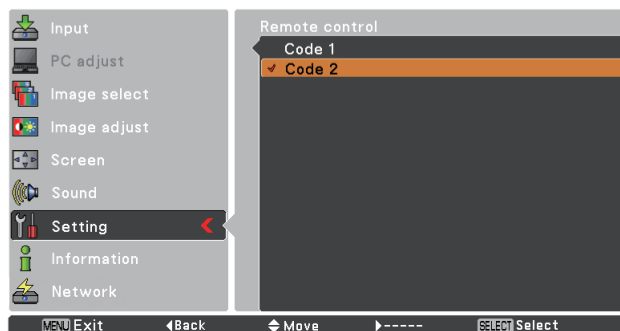



Security (Key lock and PIN code lock)

This function allows you to use the Key lock and PIN code lock function to set the security for the projector operation.

Key lock

This function locks the top control and remote control buttons to prevent operation by unauthorized persons.

Select **Key lock** and then press the SELECT button, and select the desired item by pressing the Point ▲▼ buttons.

..... Unlocked.

..... Lock the operation of the top control. To unlock, use the remote control.

..... Lock the operation of the remote control. To unlock, use the top control.

If the top control accidentally becomes locked and you do not have the remote control nearby or there is something wrong with your remote control, contact the dealer where you purchased the projector or the service center.

PIN code lock

This function prevents the projector from being operated by unauthorized persons and provides the following setting options for security.

- Off..... Unlocked.
- On1..... Enter the PIN code every time turning on the projector.
- On2..... Enter the PIN code to operate the projector once the power cord is disconnected; as long as the AC power cord is connected, the projector can be operated without a PIN code.

Whenever you change the PIN code lock setting or the PIN code (the four-digit number), you are required to enter the PIN code. The “1234” is set as the initial PIN code at the factory.

If you want to change the PIN code lock setting, Press the SELECT button and the PIN code dialog box appears.

When the projector is locked with the PIN code, the Security icon appears on the guide.

Key lock

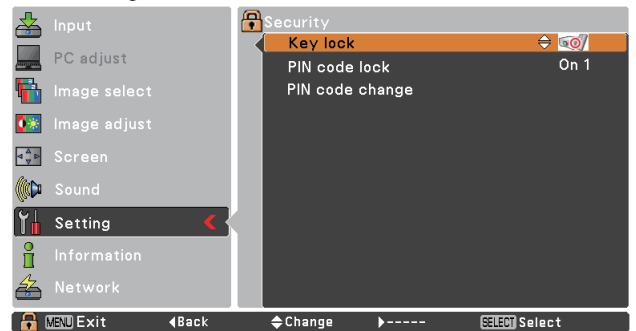
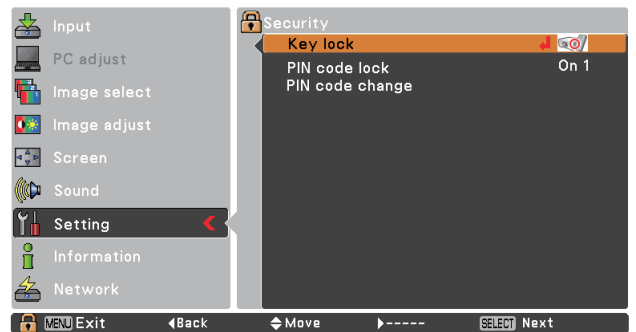

PIN code lock

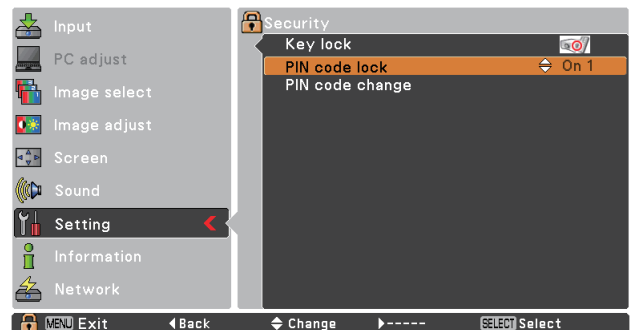

Enter a PIN code

Use the Point ▲▼ buttons to enter a number. Press the Point ► button to fix the number and move the red frame pointer to the next box. The number changes to “*”. If you fixed an incorrect number, use the Point ◀ button to move the pointer to the number you want to correct, and then enter the correct number.

Repeat this step to complete entering a four-digit number.

After entering the four-digit number, move the pointer to “Set.” Press the SELECT button so that you can start to operate the projector.

If you entered an incorrect PIN code, **PIN code** and the number (****) will turn red for a moment. Enter the correct PIN code all over again.

Change the PIN code lock setting

Use the Point ▲▼ buttons to select **Off**, **On1**, or **On2**, and then press the SELECT button to make a choice.

PIN code change

The PIN code can be changed to your desired four-digit number. Press the SELECT button to select **PIN code change**. **Pin code** dialog box appears, use the Point ▲▼ buttons to enter the correct code. The New PIN code input dialog box appears. Set a new PIN code.

CAUTION:
WHEN YOU HAVE CHANGED THE PIN CODE, WRITE DOWN THE NEW PIN CODE IN COLUMN OF THE PIN CODE NO. MEMO ON PAGE 76, AND KEEP IT SECURELY. IF YOU FORGET YOUR PIN CODE, THE PROJECTOR CAN NO LONGER BE STARTED.

Enter a PIN code

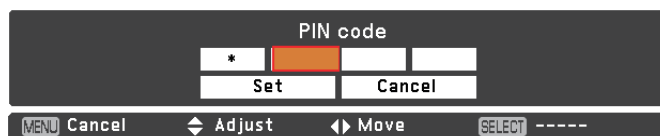

Change the PIN code

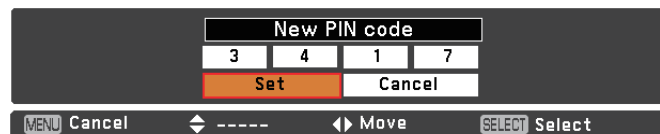
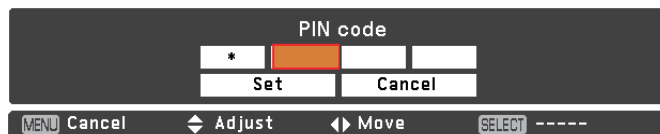
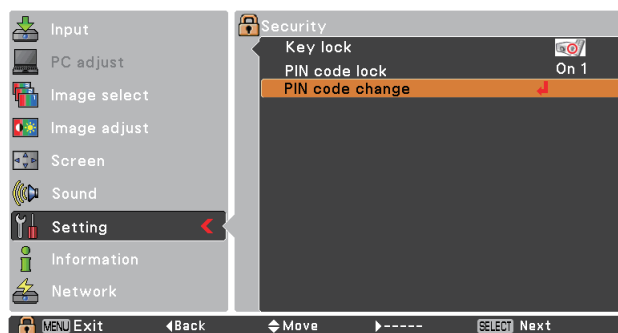

Fan

This function provides the following options in the cooling fans' operation when the projector is turned off (p.20).

L1 Normal operation

L2 Slower and lower-sound than the normal operation (**L1**), but it takes more time to cool the projector down.

Fan control

This projector provides Fan control function in the Setting menu.

Choose the running speed of cooling fans from the following options according to the ground elevation under which you use the projector.

Off..... Normal speed. Set this function to **Off** when using the projector in non-high altitude environment.

On 1..... Faster than Off mode. Select this mode when using the projector in high altitudes (about 1,200 meters or more above the sea level) where the fans have less cooling effect.

On 2..... Faster than On 1 mode. Select this mode when using the projector in higher altitudes than above where the fans have lesser cooling effect.

✓ Note:

The fan noise becomes louder in **On 1** and **On2**.

Filter counter

This function is used to set a frequency for the filter cleaning.

When the projector reached a specified time between cleanings, a Filter warning icon appears on the screen, notifying the cleaning is necessary. After cleaning the filter, be sure to select **RESET** and set the timer. The Filter warning icon will not turn off until the filter counter is reset.

For details about resetting the timer, refer to "Resetting the Filter Counter" on page 60.

Fig.1 Filter warning icon

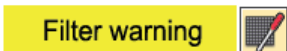

Filter warning icon appears on the screen at a set time.

✓Note:

This icon also appears at turning on.

✓ Note:

The Filter warning icons (Fig.1) will not appear when the Display function is set to **Off** (p.46), during **Freeze**(p.25), or **No show** (p.26).

Filter counter



Press the SELECT button to select Timer, and then use the Point ▲▼ buttons to set the timer. Select from (**Off/100H/ 200H/ 300H**) depending on the use environment.

Warning log

This function records anomalous operations while the projector is in operation and use it when diagnosing faults. Up to 10 warning logs are displayed with the latest warning message at the top of the list, followed by previous warning messages in chronological order.

✓ **Note:**

When the Factory default function is executed, all the warning log records will be deleted.

Factory default

This function returns all setting values except for the **User logo**, **PIN code lock**, **Logo PIN code lock**, **Lamp counter** and **Filter counter** to the factory default settings.

Factory default

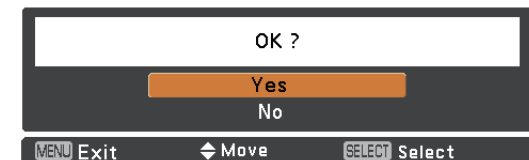
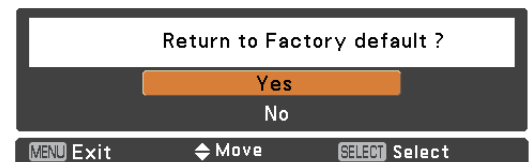

Information

Input Source Information Display

The Information Menu is used for checking the status of the image signal being projected and the operation of the projector.

Direct Operation

Press the INFO. button on the remote control to display the Information Menu.

Remote Control

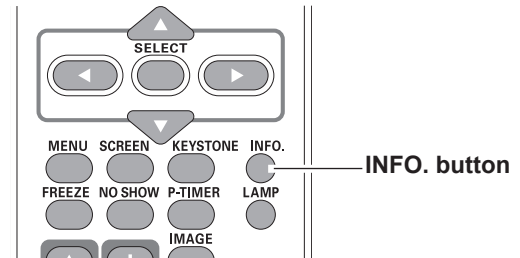

Menu Operation

Press the Point ▲▼ buttons to select the Information. The Information Menu is displayed.

See below for displayed information.

Input

The selected input source is displayed.

H-sync freq.

The horizontal frequency of the input signal is displayed in **KHz**, or - - - - - when no signal.

V-sync freq.

The vertical frequency of the input signal is displayed in **Hz**, or - - - - - when no signal. Numbers of Hz doubles when during Interlace.

Screen

The selected screen size is displayed.

Language

The selected language is displayed.

Lamp status

The selected lamp mode is displayed.

Lamp counter

The cumulative lamp operating time is displayed.

Power management

Off, **Ready**, **Shut down** or **Timer** is displayed.

Key lock

The selected Key lock icon is displayed.

PIN code lock

Off or **On 1** or **On 2** is displayed.

Remote control

The selected remote code is displayed.

Information Menu

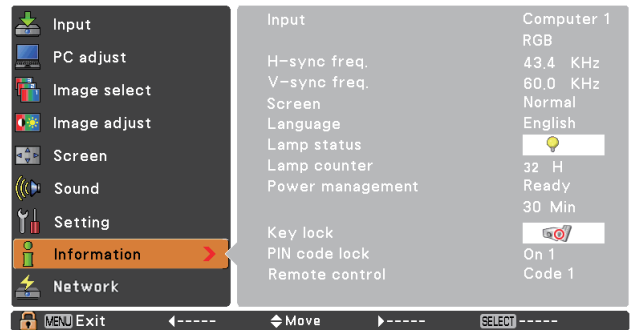

Maintenance and Cleaning

WARNING indicator

The Warning indicator shows the state of the function which protects the projector. Check the state of the Warning indicator and the POWER indicator to take proper maintenance.

The projector is shut down and the Warning indicator is blinking red.

When the temperature inside the projector reaches a certain level, the projector will be automatically shut down to protect the inside of the projector. The POWER indicator is blinking while the projector is being cooled down. When the projector has cooled down enough (to its normal operating temperature), it can be turned on again by pressing the ON/STAND-BY button.

✓ Note:

The WARNING indicator continues to blink even after the temperature inside the projector returns to normal. When the projector is turned on again, the WARNING indicator stops blinking.

Then check the matters below:

- Did you provide appropriate space for the projector to be ventilated? Check the installing condition to see if the air vents of the projector are not blocked.
- Has the projector been installed near an Air-Conditioning/ Heating Duct or Vent? Move the installation of the projector away from the duct or vent.
- Is the filter clean? Clean the filter periodically.

The projector is shut down and the Warning indicator lights red.

When the projector detects an abnormal condition, it is automatically shut down to protect the inside of the projector and the Warning indicator lights red. In this case, unplug the AC power cord and reconnect it, and then turn the projector on once again to verify operation. If the projector cannot be turned on and the Warning indicator still lights red, unplug the AC power cord and contact the service station.



CAUTION

DO NOT LEAVE THE PROJECTOR WITH THE AC POWER CORD CONNECTED UNDER AN ABNORMAL CONDITION. IT MAY RESULT IN FIRE OR ELECTRIC SHOCK.

Top Control

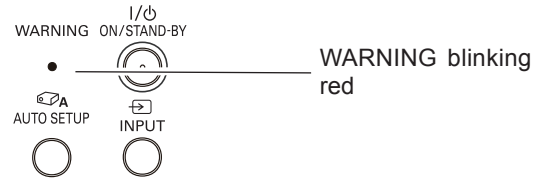

Top Control

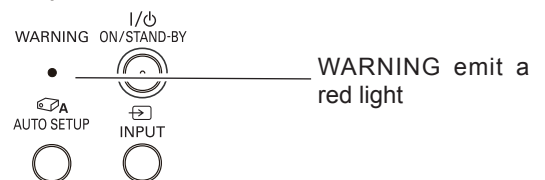

Cleaning the Filters

Filter prevents dust from accumulating on the optical elements inside the projector. Should the filters become clogged with dust particles, it will reduce cooling fans' effectiveness and may result in internal heat buildup and adversely affect the life of the projector. If a "Filter warning" icon appears on the screen, clean the filters immediately. Clean the filters by following the steps below.

- 1 Turn off the projector, and unplug the AC power cord from the AC outlet.
- 2 Turn the projector over and remove the filters .
- 3 Clean the filters softly by using a brush.
- 4 Replace the filters properly. Make sure that the filters are fully inserted to the projector.



CAUTION

Do not operate the projector with the filters removed. Dust may accumulate on the optical elements degrading picture quality. Do not put anything into the air vents. Doing so may result in malfunction of the projector.

RECOMMENDATION

We recommend avoiding dusty/smoky environments when you operate the projector. Usage in these environments may cause poor image quality.

When using the projector under dusty or smoky conditions, dust may accumulate on a lens, LCD panels, or optical elements inside the projector degrading the quality of a projected image. When the symptoms above are noticed, contact your authorized dealer or service station for proper cleaning.

Resetting the Filter Counter

Be sure to reset the Filter counter after cleaning or replacing the filters.

- 1 Press the MENU button to display the On-Screen Menu. Use the Point ▲▼ buttons to select the **Setting** Menu and then press the Point ► or SELECT buttons.
- 2 Use the Point ▲▼ buttons select Filter counter and then press the Point ► or the SELECT button. Use the Point ▲▼ buttons to select **Filter counter Reset** and then press SELECT button. The **Filter counter Reset?** appears. Select **Yes** to continue.
- 3 Another confirmation dialog box appears, select **Yes** to reset the Filter counter.

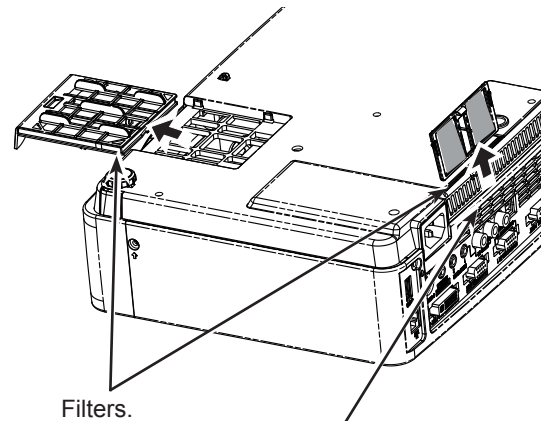

✓ Note:

When reinserting this filters, be sure that the slit part is facing the outer side.

Filter counter

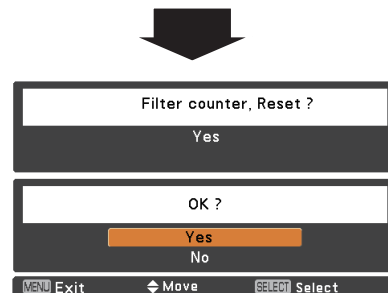

The **Filter counter Reset?** appears.

Select **Yes**, then another confirmation box appears.

Select **Yes** again to reset the Filter counter.

Attaching the Lens Cap

When moving this projector or while not using it over an extended period of time, replace the lens cap.

Attach the lens cap according to the following procedures.

- 1** Thread the string through the hole on the lens cap and then tie a knot in the string to secure it in place.
- 2** To pass the other end of the string into the hole on the top of the projector and pull at it.

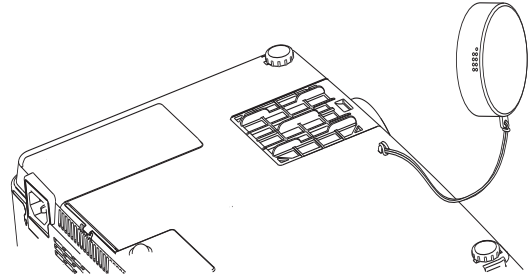

Cleaning the Projection Lens

Unplug the AC power cord before cleaning.

Gently wipe the projection lens with a cleaning cloth that contains a small amount of non-abrasive camera lens cleaner, or use a lens cleaning paper or commercially available air blower to clean the lens.

Avoid using an excessive amount of cleaner. Abrasive cleaners, solvents, or other harsh chemicals might scratch the surface of the lens.

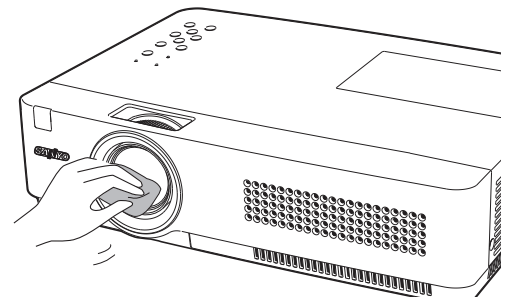

Cleaning the Projector Cabinet

Unplug the AC power cord before cleaning.

Gently wipe the projector body with a soft dry cleaning cloth. When the cabinet is heavily soiled, use a small amount of mild detergent and finish with a soft dry cleaning cloth. Avoid using an excessive amount of cleaner. Abrasive cleaners, solvents, or other harsh chemicals might scratch the surface of the cabinet.

When the projector is not in use, put the projector in an appropriate carrying case to protect it from dust and scratches.

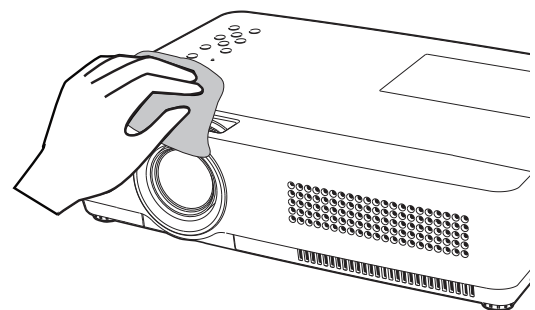

Lamp Replacement

When the projection lamp of the projector reaches its end of life, the Lamp replacement icon appears on the screen and LAMP REPLACE indicator lights yellow. Replace the lamp with a new one promptly. The timing when the LAMP REPLACE indicator should light is depending on the lamp mode.

Top Control

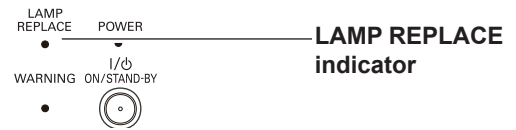

Lamp replacement icon



✓ Note:

- When Mode 2 is selected in the Lamp life control menu, if the projection lamp of the projector reaches its end of life, the lampreplacement icon appears on the screen, and the projector is turned off automatically after 3 minutes.
- The Lamp replacement icon will not appear when the Display function is set to **Off** (p.46), during **Freeze** (p.25), or **No show** (p.26).



CAUTION

Allow a projector to cool for at least 45 minutes before you open the Lamp Cover. The inside of the projector can become very hot.



CAUTION

When replacing the lamp because it has stopped illuminating, there is a possibility that the lamp may be broken.

If replacing the lamp of a projector which has been installed on the ceiling, you should always assume that the lamp is broken, and you should stand to the side of the lamp cover, not underneath it. Remove the lamp cover gently. Small pieces of glass may fall out when the lamp cover is opened. If pieces of glass get into your eyes or mouth, seek medical advice immediately.



CAUTION

For continued safety, replace with a lamp of the same type. Do not drop a lamp or touch a glass bulb! The glass can shatter and may cause injury.

Follow these steps to replace the lamp.

- 1** Unplug the AC power cord. Let the projector cool for at least 45 minutes.
- 2** Loosen the screw and open the lamp cover.
- 3** Loosen the three (3) screws that secure the lamp. Lift the lamp out of the projector by using the handle.
- 4** Replace the lamp with a new one and secure the three (3) screws. Make sure that the lamp is set properly. Close the lamp cover and secure the screw.
- 5** Connect the AC power cord to the projector and turn on the projector.

Lamp Cover

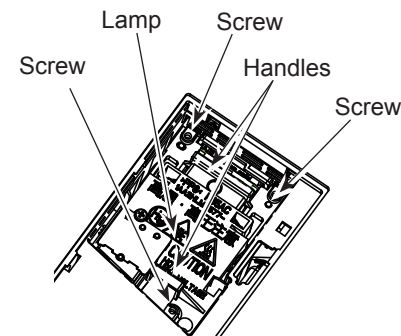
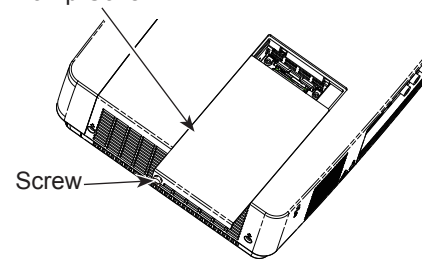

ORDER REPLACEMENT LAMP

Replacement lamp can be ordered through your dealer. When ordering a projection lamp, give the following information to the dealer.

- **Model No. of your projector** : **PLC-XU300, PLC-XU350**
PLC-XU300K, PLC-XU350K
- **Replacement Lamp Type No.** : **POA-LMP131**
(Service Parts No. 610 343 2069)



LAMP HANDLING PRECAUTIONS

This projector uses a high-pressure lamp which must be handled carefully and properly. Improper handling may result in accidents, injury, or create a fire hazard.

- Lamp life may differ from lamp to lamp and according to the environment of use. There is no guarantee of the same life for each lamp. Some lamps may fail or terminate their life in a shorter period of time than other similar lamps.
- If the projector indicates that the lamp should be replaced, i.e., if the LAMP REPLACE indicator lights up, replace the lamp with a new one IMMEDIATELY after the projector has cooled down. (Follow carefully the instructions in the Lamp Replacement section of this manual.) Continuous use of the lamp with the LAMP REPLACE indicator lighted may increase the risk of lamp explosion.
- A Lamp may explode as a result of vibration, shock or degradation as a result of hours of use as its lifetime draws to an end. Risk of explosion may differ according to the environment or conditions in which the projector and lamp are being used.

IF A LAMP EXPLODES, THE FOLLOWING SAFETY PRECAUTIONS SHOULD BE TAKEN.

If a lamp explodes, disconnect the projector's AC plug from the AC outlet immediately. Contact an authorized service station for a checkup of the unit and replacement of the lamp. Additionally, check carefully to ensure that there are no broken shards or pieces of glass around the projector or coming out from the cooling air circulation holes. Any broken shards found should be cleaned up carefully. No one should check the inside of the projector except those who are authorized trained technicians and who are familiar with projector service. Inappropriate attempts to service the unit by anyone, especially those who are not appropriately trained to do so, may result in an accident or injury caused by pieces of broken glass.

Appendix

Troubleshooting

Before calling your dealer or service center for assistance, check the items below once again.

- Make sure you have properly connected the projector to peripheral equipment as described on pages 14-16.
- Make sure all equipment is connected to AC outlet and the power is turned on.
- When the projector does not project an image from the connected computer, restart the computer.

| Problem: | – Solutions |
|--|---|
| No power | <ul style="list-style-type: none">– Plug the power cord of the projector into the AC outlet.– See if the POWER indicator lights red.– Wait until the POWER indicator stops blinking to turn on the projector again. The projector can be turned on after the POWER indicator turns red. See page 18.– Check the WARNING indicator. If the WARNING indicator lights red, projector cannot be turned on. See page 59.– Check the projection lamp. See page 62.– Unlock the Key lock function for the projector. See page 54. |
| The initial display is not shown. | <ul style="list-style-type: none">– Make sure Off or Countdown off are not chosen at display function. See page 46. |
| The initial display is not same as the default set. | <ul style="list-style-type: none">– Make sure User or Off are not chosen at Logo (select) function. See page 47. |
| Input signal switches automatically. (or does not switch automatically) | <ul style="list-style-type: none">– Make sure Input search function is adjusted properly. See page 45. |
| When the projector is on and you press the input button, an icon other than the Lamp mode icon appears. | <ul style="list-style-type: none">– That is the Filter warning icon. See page 56. |
| An icon other than Input mode or Lamp mode icon appears. | <ul style="list-style-type: none">– That is the Lamp replacement icon or the Filter warning icon. See pages 56 or 62. |
| Image is out of focus. | <ul style="list-style-type: none">– Adjust focus of the projector. See page 23.– Provide proper distance between the projector and the projection screen. See page 13.– Check the projection lens to see if it needs cleaning. See page 61.– Moving the projector from a cool to warm place may result in moisture condensation on the projection lens. In such cases, leave the projector off and wait until condensation evaporates. |
| Image is Left/Right reversed. Image is Top/Bottom reversed. | <ul style="list-style-type: none">– Check the Ceiling/Rear function. See page 50.– Check the Top/Bottom function. See page 50. |
| Picture is not bright enough. | <ul style="list-style-type: none">– Check if the Contrast or Brightness are adjusted properly. See pages 34,41.– Check if Image mode is selected properly. See pages 33,40.– Check the lamp control function. See pages 25,53.– Check the LAMP REPLACE indicator. If it lights, the end of lamp life is approaching. Replace the lamp with a new one promptly. See page 62. |

| | |
|--|--|
| No image | <ul style="list-style-type: none"> – Check the connection between your computer or video equipment and the projector. See pages 14-16. – See if the input signal is correctly output from your computer. Some laptop computers may need to change the setting for monitor output when connecting to a projector. See your computer's instruction manual for the setting. – It takes about 30 seconds to display an image after turning on the projector. See page 18. – Check the Input signal, color system, video system or computer system mode. – Make sure the temperature is not out of the specified Operating Temperature (41°F–95°F [5°C–35°C]). – When No Show is operating, the image cannot be displayed. Press the NO SHOW button or any other button on the remote control. |
| No sound | <ul style="list-style-type: none"> – Check the audio cable connection from audio input source. – Adjust the audio source. – Press the Volume + button. See page 24. – Press the Mute button. See page 24. – When the AUDIO OUT is plugged-in, the projector's built-in speaker is not available. – Is the image projected? You will hear the sound only when the image is projected. |
| The color is strange. | <ul style="list-style-type: none"> – Check the Input signal, color system, video system or computer system mode. – Make sure the Blackboard is not selected on Image select menu. See pages 33,40. |
| Some displays are not seen during the operation. | <ul style="list-style-type: none"> – Check the Display function. See page 46. |
| Auto PC adjustment function does not work. | <ul style="list-style-type: none"> – Check the Input signal. Auto PC function can not work when 480p, 575p, 720p, 480i, 575i, 1035i or 1080i is selected. See Page 30. – The icon is not available in grayout when the digital signal is input. |
| The setting does not remain after turning off power. | <ul style="list-style-type: none"> – Make sure you selected Store after adjusting setting. Some settings can not be stored if not registered with "Store". See pages 35,42. |
| Power management does not work. | <ul style="list-style-type: none"> – Power management function can not work while Freeze or No Show function is running. See page 51. |
| Capture function does not work. | <ul style="list-style-type: none"> – Check the connection and the input signal to see if there is signal. |
| Auto setup does not work properly. | <ul style="list-style-type: none"> – Make sure Off is not selected at any function of Auto setup. See page 45. – Make sure On is not selected at the Ceiling function. See page 50. |
| Auto keystone function does not work even when the projector is tipped. | <ul style="list-style-type: none"> – Make sure the Auto keystone function is not set to Manual. Press the AUTO SETUP button on the top control. See pages 23,45. |

Appendix

| | |
|--|--|
| The image is distorted or runs off. | <ul style="list-style-type: none">– Check PC adjustment menu or Screen and adjust them. See pages 31-32, 35-36. |
| PIN code dialog box appears at start-up. | <ul style="list-style-type: none">– PIN code lock is being set. Enter a PIN code (the “1234” or numbers you have set). See pages 19, 54-55. |
| The Remote Control does not work. | <ul style="list-style-type: none">– Check the batteries.– Make sure no obstruction is between the projector and remote control.– Make sure you are not too far from the projector when using the remote control. Maximum operating range is 16.4'(5 m).– Make sure the code of the remote control is conformed to the projector's code. See page 53.– Unlock the Key lock function for the remote control function. See page 54. |
| Indicator blinks or lights. | <ul style="list-style-type: none">– Check the status of the projector with referring to "Indicators and projector Condition". See page 70. |
| The exclamation mark appears on the screen. | <ul style="list-style-type: none">– Your operation is invalid. Operate correctly. |
| Top control does not work. | <ul style="list-style-type: none">– The top control is not available if the top control is locked at Key lock under Security of SETTING section. See page 54. |
| Unable to unlock the Logo PIN code lock, Security key lock or Security PIN code lock. | <ul style="list-style-type: none">– Contact the dealer where you purchased the projector or the service center. |

WARNING :

High voltages are used to operate this projector. Do not attempt to open the cabinet.

If problems still persist after following all operating instructions, contact the dealer where you purchased the projector or the service center. Specify the model number and explain about the problem. We will advise you how to obtain service.



The CE Mark is a Directive conformity mark of the European Community (EC).



Pixelworks ICs used.



This symbol on the nameplate means the product is Listed by Underwriters Laboratories Inc. It is designed and manufactured to meet rigid U.L. safety standards against risk of fire, casualty and electrical hazards.

Menu Tree

Computer Input/Video Input

Input

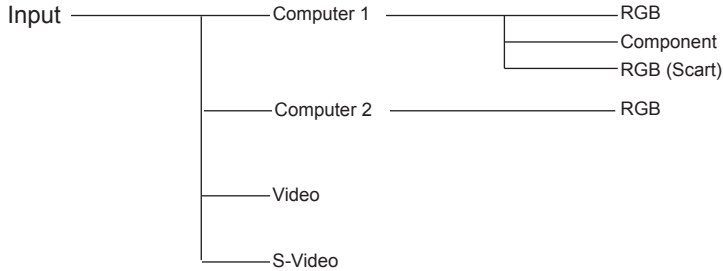

Sound

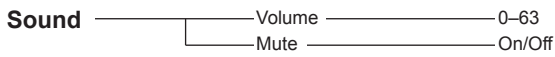

Computer Input

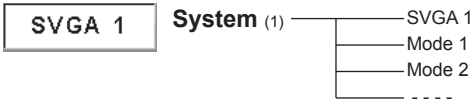

* Systems displayed in the System Menu vary depending on an input signal.

Image Select

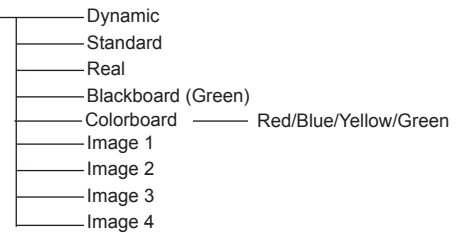

PC Adjust

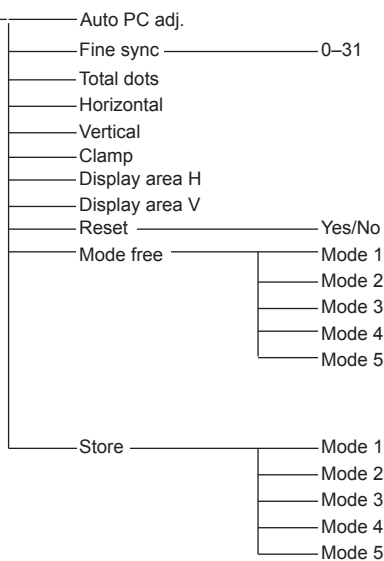
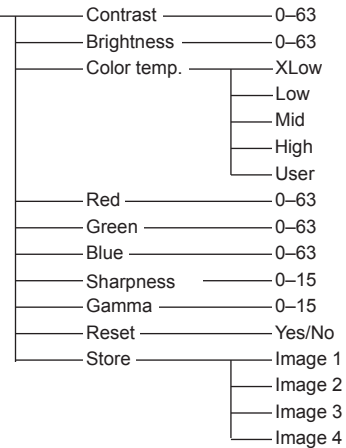
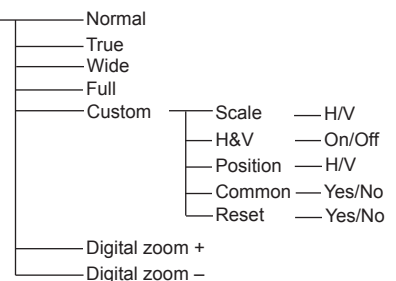

Image Adjust



Screen



Video Input

Auto

System (2)

- Auto
- 1080i
- 1035i
- 720p
- 575p
- 480p
- 575i
- 480i

Auto

System (3)

- Auto
- PAL
- SECAM
- NTSC
- NTSC 4.43
- PAL-M
- PAL-N

Image Select

- Dynamic
- Standard
- Cinema
- Blackboard (Green)
- Colorboard — Red/Blue/Yellow/Green
- Image 1
- Image 2
- Image 3
- Image 4

Image Adjust

- Contrast — 0-63
- Brightness — 0-63
- Color — 0-63
- Tint — 0-63
- Color temp. — XLow
 - Low
 - Mid
 - High
 - User
- Red — 0-63
- Green — 0-63
- Blue — 0-63
- Sharpness — 0-15
- Gamma — 0-15
- Noise reduction — Off
 - L1
 - L2
- Progressive — Off
 - L1
 - L2
 - Film
- Reset — Yes/No
- Store — Image 1
 - Image 2
 - Image 3
 - Image 4

Screen

- Normal
- Wide
- Custom — Scale — H/V
 - H&V — On/Off
 - Position — H/V
 - Common — Yes/No
 - Reset — Yes/No

Setting

Setting

























- Language — 17 languages provided.
- Menu position
- Auto setup — Input search — Off/On1/On2
 - Auto PC adj. — On/Off
 - Auto keystone — Auto
 - Manual
 - Off
- Keystone — Store/Reset
- Background — Blue/Black/User
- Display — On/Countdown off/Off
- Logo — Logo select
 - User
 - Default
 - Off
- Capture — Yes/No
- Logo PIN code lock — Off/On
- Logo PIN code change
- Ceiling — On/Off
- Rear — On/Off
- Terminal — Computer 2/ Monitor out
- Power management — Ready
 - Shut down
 - Off
 - Timer (1-30 Min.)
- On start — On/Off
- Standby mode — Eco/Normal
- Closed Caption — Closed Caption — Off/CC1/CC2/CC3/CC4
 - Color — Color/White
- Lamp control — Lamp control
 - Normal
 - Eco
- Lamp life control — Mode 1/Mode 2
- Remote control — Code 1-Code 2
- Security — Key lock
 - Off
 - Projector
 - Remote control
- PIN code lock — Off/On1/On2
- PIN code change
- Fan — L1/L2
- Fan control — Off/On1/On2
- Filter counter — Filter counter — H
 - Timer — Off/100H/200H/300H
 - Filter counter Reset — Yes/No
- Warning log
- Factory default — Yes/No

Information

Input Source Information Display

Indicators and Projector Condition

Check the indicators for projector condition.

| Indicators | | | Projector Condition |
|---|---|---|--|
| POWER red/green | WARNING red | LAMP REPLACE yellow | |
|  |  |  | The projector is off. (The AC power cord is unplugged.) |
|  |  |  | The projector is in stand-by mode. Press the ON/STAND-BY button to turn on the projector. |
|  |  |  | The projector is operating normally. |
|  |  |  | The projector is preparing for stand-by or the projection lamp is being cooled down. The projector cannot be turned on until cooling is completed and the POWER indicator stops blinking. |
|  |  |  | The projector is in the Power management mode. |
|  |  |  | The temperature inside the projector is abnormally high. The projector cannot be turned on. When the projector is cooled down enough and the temperature returns to normal, the POWER indicator stops blinking and the projector can be turned on. (The WARNING indicator keeps blinking.) |
|  |  |  | The projector has been cooled down enough and the temperature returns to normal. When turning on the projector, the WARNING indicator stops blinking. |
|  |  |  | The projector detects an abnormal condition and cannot be turned on. Unplug the AC power cord and plug it again to turn on the projector. If the projector is turned off again, unplug the AC power cord and contact the dealer or the service center for service and checkup. Do not leave the projector on. It may cause an electric shock or a fire hazard. |

 ••• green.

 ••• red

 ••• off

 ••• blinks green.

 ••• blinks red.

When the projection lamp reaches its end of life, the LAMP REPLACE indicator lights yellow. When this indicator lights yellow, replace the projection lamp with a new one promptly.

Compatible Computer Specifications

Basically this projector can accept the signal from all computers with the V-, H-Frequency mentioned below and less than 140 MHz of Dot Clock.

When selecting these modes, PC adjustment can be limited.

| ON-SCREEN DISPLAY | RESOLUTION | H-Freq. (KHz) | V-Freq. (Hz) | ON-SCREEN DISPLAY | RESOLUTION | H-Freq. (KHz) | V-Freq. (Hz) |
|-------------------|------------|---------------|---------------------------------|-------------------|-------------|---------------|---------------------------------|
| VGA 1 | 640 x 480 | 31.47 | 59.88 | SXGA 1 | 1152 x 864 | 64.20 | 70.40 |
| VGA 2 | 720 x 400 | 31.47 | 70.09 | SXGA 2 | 1280 x 1024 | 62.50 | 58.60 |
| VGA 3 | 640 x 400 | 31.47 | 70.09 | SXGA 3 | 1280 x 1024 | 63.90 | 60.00 |
| VGA 4 | 640 x 480 | 37.86 | 74.38 | SXGA 4 | 1280 x 1024 | 63.34 | 59.98 |
| VGA 5 | 640 x 480 | 37.86 | 72.81 | SXGA 5 | 1280 x 1024 | 63.74 | 60.01 |
| VGA 6 | 640 x 480 | 37.50 | 75.00 | SXGA 6 | 1280 x 1024 | 71.69 | 67.19 |
| VGA 7 | 640 x 480 | 43.269 | 85.00 | SXGA 7 | 1280 x 1024 | 81.13 | 76.107 |
| MAC LC13 | 640 x 480 | 34.97 | 66.60 | SXGA 8 | 1280 x 1024 | 63.98 | 60.02 |
| MAC 13 | 640 x 480 | 35.00 | 66.67 | SXGA 9 | 1280 x 1024 | 79.976 | 75.025 |
| 480p | 640 x 480 | 31.47 | 59.88 | SXGA 10 | 1280 x 960 | 60.00 | 60.00 |
| 575p | 768 x 575 | 31.25 | 50.00 | SXGA 11 | 1152 x 900 | 61.20 | 65.20 |
| 480i | 640 x 480 | 15.734 | ^{60.00} (Interface) | SXGA 12 | 1152 x 900 | 71.40 | 75.60 |
| 575i | 768 x 576 | 15.625 | ^{50.00} (Interface) | SXGA 13 | 1280 x 1024 | 50.00 | ^{86.00} (Interface) |
| SVGA 1 | 800 x 600 | 35.156 | 56.25 | SXGA 14 | 1280 x 1024 | 50.00 | ^{94.00} (Interface) |
| SVGA 2 | 800 x 600 | 37.88 | 60.32 | SXGA 15 | 1280 x 1024 | 63.37 | 60.01 |
| SVGA 3 | 800 x 600 | 46.875 | 75.00 | SXGA 16 | 1280 x 1024 | 76.97 | 72.00 |
| SVGA 4 | 800 x 600 | 53.674 | 85.06 | SXGA 17 | 1152 x 900 | 61.85 | 66.00 |
| SVGA 5 | 800 x 600 | 48.08 | 72.19 | SXGA 18 | 1280 x 1024 | 46.43 | ^{86.70} (Interface) |
| SVGA 6 | 800 x 600 | 37.90 | 61.03 | SXGA 19 | 1280 x 1024 | 63.79 | 60.18 |
| SVGA 7 | 800 x 600 | 34.50 | 55.38 | SXGA 20 | 1280 x 1024 | 91.146 | 85.024 |
| SVGA 8 | 800 x 600 | 38.00 | 60.51 | SXGA+ 1 | 1400 x 1050 | 63.97 | 60.19 |
| SVGA 9 | 800 x 600 | 38.60 | 60.31 | SXGA+ 2 | 1400 x 1050 | 65.35 | 60.12 |
| SVGA 10 | 800 x 600 | 32.70 | 51.09 | SXGA+ 3 | 1400 x 1050 | 65.12 | 59.90 |
| SVGA 11 | 800 x 600 | 38.00 | 60.51 | MAC21 | 1152 x 870 | 68.68 | 75.06 |
| MAC 16 | 832 x 624 | 49.72 | 74.55 | MAC | 1280 x 960 | 75.00 | 75.08 |
| MAC 19 | 1024 x 768 | 60.24 | 75.08 | MAC | 1280 x 1024 | 80.00 | 75.08 |
| XGA 1 | 1024 x 768 | 48.36 | 60.00 | WXGA 1 | 1366 x 768 | 48.36 | 60.00 |
| XGA 2 | 1024 x 768 | 68.677 | 84.997 | WXGA 2 | 1360 x 768 | 47.70 | 60.00 |
| XGA 3 | 1024 x 768 | 60.023 | 75.03 | WXGA 3 | 1376 x 768 | 48.36 | 60.00 |
| XGA 4 | 1024 x 768 | 56.476 | 70.07 | WXGA 4 | 1360 x 768 | 56.16 | 72.00 |
| XGA 5 | 1024 x 768 | 60.31 | 74.92 | WXGA 6 | 1280 x 768 | 47.776 | 59.87 |
| XGA 6 | 1024 x 768 | 48.50 | 60.02 | WXGA 7 | 1280 x 768 | 60.289 | 74.893 |
| XGA 7 | 1024 x 768 | 44.00 | 54.58 | WXGA 8 | 1280 x 768 | 68.633 | 84.837 |
| XGA 8 | 1024 x 768 | 63.48 | 79.35 | UXGA 1 | 1600 x 1200 | 75.00 | 60.00 |
| XGA 9 | 1024 x 768 | 36.00 | ^{87.17} (Interface) | UXGA 2 | 1600 x 1200 | 81.25 | 65.00 |
| XGA 10 | 1024 x 768 | 62.04 | 77.07 | UXGA 3 | 1600 x 1200 | 87.5 | 70.00 |
| XGA 11 | 1024 x 768 | 61.00 | 75.70 | UXGA 4 | 1600 x 1200 | 93.75 | 75.00 |
| XGA 12 | 1024 x 768 | 35.522 | ^{86.96} (Interface) | 720p | 1280 x 720 | 45.00 | 60.00 |
| XGA 13 | 1024 x 768 | 46.90 | 58.20 | 720p | 1280 x 720 | 37.50 | 50.00 |
| XGA 14 | 1024 x 768 | 47.00 | 58.30 | 1035i | 1920 x 1035 | 33.75 | ^{60.00} (Interface) |
| XGA 15 | 1024 x 768 | 58.03 | 72.00 | 1080i | 1920 x 1080 | 33.75 | ^{60.00} (Interface) |
| | | | | 1080i | 1920 x 1080 | 28.125 | ^{50.00} (Interface) |

✓ **Note:**

The specifications are subject to change without notice.

Technical Specifications

Mechanical Information

| | |
|------------------------|--|
| Projector Type | Multi-media Projector |
| Dimensions (W x H x D) | 12.80" x 3.27" x 9.12" (326mm X 83.1mm X 231.6mm) (Not including protrusions) |
| Net Weight | 5.52 lbs (2.5 kg) |
| Feet Adjustment | 0° to 12° |

Panel Resolution

| | |
|------------------|--|
| LCD Panel System | 0.63" TFT Active Matrix type, 3 panels |
| Panel Resolution | 1,024 x 768 dots |
| Number of Pixels | 2,359,296 (1,024 x 768 x 3 panels) |

Signal Compatibility

| | |
|---------------------------|--|
| Color System | PAL, SECAM, NTSC, NTSC4.43, PAL-M, and PAL-N |
| High Definition TV Signal | 480i, 480p, 575i, 575p, 720p, 1035i, and 1080i |
| Scanning Frequency | H-sync. 15 kHz–100 kHz, V-sync. 50–100 Hz |

Optical Information

| | |
|----------------------------------|--|
| Projection Image Size (Diagonal) | Adjustable from 40" to 300" |
| Throw Distance | 4.6' ~ 41.7' (1.4 m ~ 12.7 m) |
| Projection Lens | F 1.60 ~ 1.76 lens with f 22.3 mm ~ 26.8 mm with manual zoom and focus |
| Projection Lamp | 225 W |

Interface

| | |
|---|--|
| Video Input Jack | RCA Type x 1 |
| S-video Input Jack | Mini DIN 4 pin x 1 |
| Audio Input Jacks | RCA Type x 2 |
| Computer 1/Computer 2 Audio Input Jacks | Mini Jack (stereo) x 2 |
| Computer In 1/Component Input Terminal | Mini D-sub 15 pin x 1 |
| Computer In 2/Monitor Output Terminal | Mini D-sub 15 pin x 1 |
| Control Port Connector | D-sub 9 pin x 1 |
| Audio Output Jack | Mini Jack (stereo) x 1 (variable) |
| LAN Connection Terminal | 100 Base-TX (100Mbps)/10 Base-T (10Mbps), RJ45 |

Audio

| | |
|--------------------|-------------------------|
| Internal Audio Amp | 1.0 W RMS |
| Built-in Speaker | 1 speaker, ø1.1"(28 mm) |

Power

| | |
|-------------------------------|---|
| Voltage and Power Consumption | AC 100–120 V (3.7A Max. Ampere), 50/60 Hz (The U.S.A and Canada) AC 200–240 V (2.0A Max. Ampere), 50/60 Hz (Continental Europe and The U.K.) |
|-------------------------------|---|

Operating Environment

| | |
|-----------------------|--------------------------|
| Operating Temperature | 41°F–95°F (5 °C–35 °C) |
| Storage Temperature | 14°F–140°F (-10°C–60 °C) |

Remote Control

| | |
|-----------------|---|
| Battery | AAA or LR03 1.5V ALKALINE TYPE x 2 |
| Operating Range | 16.4' (5 m)/±30° |
| Dimensions | 2.0" (W) x 0.7" (H) x 4.3" (D) (52 mm x 18 mm x 110 mm) |
| Net Weight | 2.37 oz (67 g) (including batteries) |

Accessories

Owner's Manual (CD-ROM)
Quick Reference Guide & Safety Manual
Safety Instructions Manual
AC Power Cord
Remote Control and Batteries
VGA Cable
Lens Cap with String
PIN Code Label
Network Application (CD-ROM)

- The specifications are subject to change without notice.
- LCD panels are manufactured to the highest possible standards. Even though 99.99% of the pixels are effective, a tiny fraction of the pixels (0.01% or less) may be ineffective by the characteristics of the LCD panels.

Optional Parts

The parts listed below are optionally available. When ordering those parts, specify the item name and Model No. to the sales dealer.

| | Model No. |
|----------------------------|------------------|
| COMPONENT~VGA Cable | : POA-CA-COMPVGA |
| SCART~VGA Cable | : POA-CA-SCART |
| VGA-Cable (10 m) | : KA-MC-DB10 |

PJ Link Notice

This projector is compliant with PJLink Standard Class 1 of JBMA (Japan Business Machine and Information System Industries Association). This projector supports all commands defined by PJLink Class 1 and is verified conformance with PJLink Standard Class 1.

For PJ Link password, see the owner's manual of "Network Set-up and Operation."

| Projector Input | PJLink Input | Parameter | |
|---------------------|--------------|-----------|----|
| Computer 2 (Analog) | RGB 1 | 11 | |
| Computer 1 | RGB | RGB 2 | 12 |
| | Component | RGB 3 | 13 |
| | RGB (Scart) | RGB 4 | 14 |
| Video | Video | VIDEO 2 | 22 |
| | S-video | VIDEO 3 | 23 |

PJLink is a registered trademark of JBMA and pending trademark in some countries.



Configurations of Terminals

COMPUTER IN 1 /COMPONENT IN /COMPUTER IN 2/MONITOR OUT (ANALOG)

Terminal: Analog RGB (Mini D-sub 15 pin)

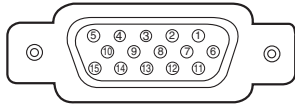

| | | | |
|---|--------------------------|----|---|
| 1 | Red (R/Cr) Input/Output | 9 | +5V Power/----- |
| 2 | Green (G/Y) Input/Output | 10 | Ground (Vert.sync.) |
| 3 | Blue (B/Cb) Input/Output | 11 | Ground/----- |
| 4 | ----- | 12 | DDC Data/----- |
| 5 | Ground (Horiz.sync.) | 13 | Horiz. sync. Input/Output (Composite H/V sync.) |
| 6 | Ground (Red) | 14 | Vert. sync. |
| 7 | Ground (Green) | 15 | DDC Clock/----- |
| 8 | Ground (Blue) | | |

CONTROL PORT CONNECTOR (D-sub 9 pin)

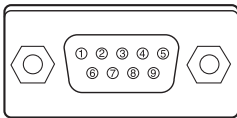

| | Serial |
|---|--------|
| 1 | ----- |
| 2 | R X D |
| 3 | T X D |
| 4 | ----- |
| 5 | SG |
| 6 | ----- |
| 7 | RTS |
| 8 | CTS |
| 9 | ----- |

LAN TERMINAL

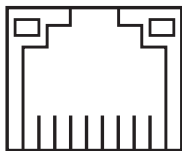

87654321

| | | | |
|---|-------|---|-------|
| 1 | TX + | 5 | ----- |
| 2 | TX - | 6 | RX - |
| 3 | RX + | 7 | ----- |
| 4 | ----- | 8 | ----- |

PIN Code Number Memo

Write down the PIN code number in the column below and keep it with this manual securely. If you forgot or lost the number and unable to operate the projector, contact the service station.

PIN Code Lock No.

| | | | |
|--|--|--|--|
| | | | |
|--|--|--|--|

Factory default set No: 1 2 3 4*

Logo PIN Code Lock No.

| | | | |
|--|--|--|--|
| | | | |
|--|--|--|--|

Factory default set No: 4 3 2 1*

*Should the four-digit number be changed, the factory set number will be invalid.

While the projector is locked with the PIN code.

Put the label below (supplied) on in a prominent place of the projector's body while it is locked with a PIN code.

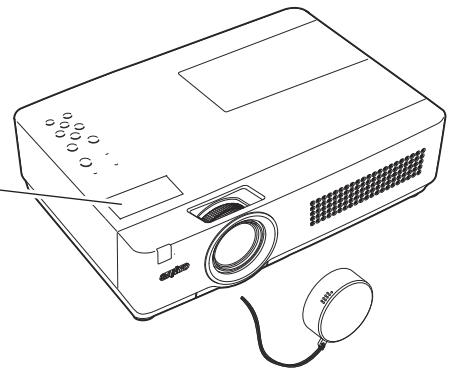

Dimensions

Unit: mm(inch)

↙ Screw Holes for Ceiling Mount
Screw: M4
Depth: 12.0(0.472)

