

Multimedia Rear-Projection Display

MODEL PLC-XR70N

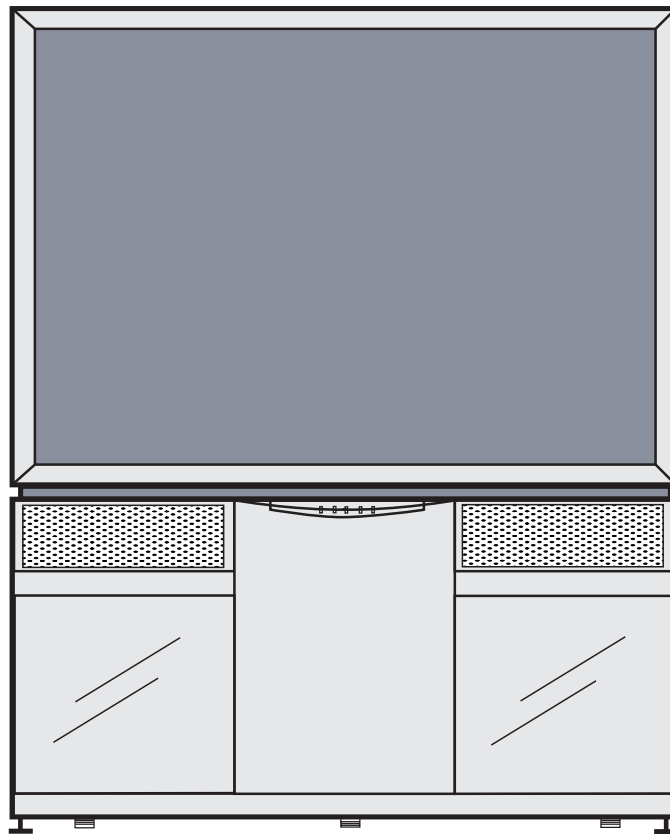

Owner's Manual

INFORMATION TO THE USER

NOTE : This equipment has been tested and found to comply with the limits for a Class A digital device, pursuant to Part 15 of FCC Rules. These limits are designed to provide reasonable protection against harmful interference when the equipment is operated in a commercial environment. This equipment generates, uses, and can radiate radio frequency energy and, if not installed and used in accordance with the instruction manual, may cause harmful interference to radio communications. Operation of this equipment in a residential area is likely to cause harmful interference in which case the user will be required to correct the interference at his own expense.

TO THE OWNER

As the owner of a new Rear-Projection Display, you are probably eager to try out your new projector. Before you do, we suggest that you spend a little time reading this manual to familiarize yourself with the operating procedures, so that you will receive maximum satisfaction from the many features included in your new projector.

This owner's manual will acquaint you with your projector's features. Reading it will help us too. Through the years, we have found that many service requests were not caused by problems with our projectors. They were caused by problems that could have been prevented, if the owner had followed the instructions in the manual.

You can often correct operating problems yourself. If your projector fails to work properly, see "TROUBLESHOOTING" section on page 43 and try the solution marked for each problem.

SAFETY PRECAUTIONS

WARNING:

TO REDUCE THE RISK OF FIRE OR ELECTRIC SHOCK, DO NOT EXPOSE THIS APPLIANCE TO RAIN OR MOISTURE.

This Projector has a grounding-type AC line plug. This is a safety feature to be sure that the plug will fit into the power outlet. Do not try to defeat this safety feature.

This projector produces intense light from the projection lens. Do not stare directly into the lens as possible eye damage could result. Be especially careful that children do not stare directly into the beam.

This projector should not be set in the way indicated. It may result in fire hazard.

If the projector will not be used for an extended time, unplug the projector from the power outlet.

READ AND KEEP THIS OWNER'S MANUAL FOR LATER USE.



CAUTION

**RISK OF ELECTRIC SHOCK
DO NOT OPEN**



CAUTION : TO REDUCE THE RISK OF ELECTRIC SHOCK, DO NOT REMOVE COVER (OR BACK). NO USER-SERVICEABLE PARTS INSIDE EXCEPT LAMP REPLACEMENT. REFER SERVICING TO QUALIFIED SERVICE PERSONNEL.



THIS SYMBOL INDICATES THAT DANGEROUS VOLTAGE CONSTITUTING A RISK OF ELECTRIC SHOCK IS PRESENT WITHIN THIS UNIT.



THIS SYMBOL INDICATES THAT THERE ARE IMPORTANT OPERATING AND MAINTENANCE INSTRUCTIONS IN THE OWNER'S MANUAL WITH THIS UNIT.

IMPORTANT SAFETY INSTRUCTIONS

All the safety and operating instructions should be read before the product is operated.

Read all of the instructions given here and retain them for later use. Unplug this projector from AC power supply before cleaning. Do not use liquid or aerosol cleaners. Use a damp cloth for cleaning.

Do not use attachments not recommended by the manufacturer as they may cause hazards.

Do not place this projector on an unstable cart, stand, or table. The projector may fall, causing serious injury to a child or adult, and serious damage to the projector. Use only with a cart or stand recommended by the manufacturer, or sold with the projector. Wall of shelf mounting should follow the manufacturer's instructions, and should use a mounting kit approved by the manufacturers.

Do not expose this unit to rain or use near water... for example, in a wet basement, near a swimming pool, etc...

Slots and openings in the back and bottom of the cabinet are provided for ventilation, to insure reliable operation of the equipment and to protect it from overheating.

The openings should never be covered with cloth of other materials, and the bottom opening should not be blocked by placing the projector on a bed, sofa, rug, or other similar surface. This projector should never be placed near or over a radiator or heat register.

This projector should not be placed in a built-in installation such as a book case unless proper ventilation is provided.

This projector should be operated only from the type of power source indicated on the marking label. If you are not sure of the type of power supplied, consult your authorized dealer or local power company.

Do not overload wall outlets and extension cords as this can result in fire or electric shock. Do not allow anything to rest on the power cord. Do not locate this projector where the cord may be damaged by persons walking on it.

Never push objects of any kind into this projector through cabinet slots as they may touch dangerous voltage points or short out parts that could result in a fire or electric shock. Never spill liquid of any kind on the projector.

Do not attempt to service this projector yourself as opening or removing covers may expose you to dangerous voltage or other hazards. Refer all servicing to qualified service personnel.

Unplug this projector from wall outlet and refer servicing to qualified service personnel under the following conditions:

- a. When the power cord or plug is damaged or frayed.
- b. If liquid has been spilled into the projector.
- c. If the projector has been exposed to rain or water.
- d. If the projector does not operate normally by following the operating instructions. Adjust only those controls that are covered by the operating instructions as improper adjustment of other controls may result in damage and will often require extensive work by a qualified technician to restore the projector to normal operation.
- e. If the projector has been dropped or the cabinet has been damaged.
- f. When the projector exhibits a distinct change in performance-this indicates a need for service.

When replacement parts are required, be sure the service technician has used replacement parts specified by the manufacturer that have the same characteristics as the original part. Unauthorized substitutions may result in fire, electric shock, or injury to persons.

Upon completion of any service or repairs to this projector, ask the service technician to perform routine safety checks to determine that the projector is in safe operating condition.

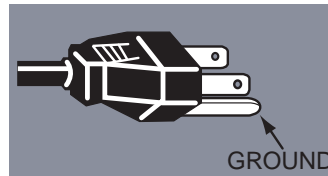

This projector is equipped with a grounding type AC line plug. Should you be unable to insert the plug into the outlet, contact your electrician. Do not defeat the safety purpose of this grounding type plug.

Follow all warnings and instructions marked on the projectors.

For added protection to the projector during a lightning storm, or when it is left unattended and unused for long periods of time, unplug it from the wall outlet. This will prevent damage due to lightning and power line surges.



An appliance and cart combination should be moved with care. Quick stops, excessive force, and uneven surfaces may cause the appliance and cart combination to overturn.

If the projector is to be built into a compartment or similarly enclosed, the minimum distances must be maintained. Do not cover the ventilation slot on the projector. Heat build-up can reduce the service life of your projector, and can also be dangerous. (Refer to pages 6 and 10.)

TABLE OF CONTENTS

FEATURES AND DESIGN 5

INSTALLATION 6

INSTALLING THE PROJECTOR	6
PREPARING THE REMOTE CONTROLS	8
NAME OF EACH PART OF THE PROJECTOR	10
CONNECTING TO THE AC POWER CORD	11

CONNECTING THE PROJECTOR 12

TERMINALS OF THE PROJECTOR	12
CONNECTING TO THE COMPUTER	14
CONNECTING TO THE VIDEO EQUIPMENT	16

BEFORE OPERATION 18

CONTROLS AND INDICATORS	18
OPERATION OF THE REMOTE CONTROLS	20
OPERATING ON-SCREEN MENU	22

BASIC OPERATION 24

TURNING ON / OFF THE PROJECTOR	24
SOUND ADJUSTMENT	25
PICTURE FREEZE FUNCTION	25

COMPUTER MODE 26

SELECTING COMPUTER MODE	26
SELECTING COMPUTER SYSTEM	27
PC ADJUSTMENT	28
COMPATIBLE COMPUTER SPECIFICATIONS	29
PICTURE IMAGE ADJUSTMENT	30
PICTURE POSITION ADJUSTMENT	32
PICTURE SCREEN ADJUSTMENT	32

VIDEO MODE 34

SELECTING VIDEO MODE	34
SELECTING COLOR SYSTEM	35
SELECTING VIDEO SOURCE	35
PICTURE IMAGE ADJUSTMENT	36
PICTURE SCREEN ADJUSTMENT	37

SETTING 38

SETTING MENU	38
SETTING LANGUAGE	38

APPENDIX 39

OPERATING WIRELESS MOUSE	39
MOUSE / KEYBOARD CONNECTION	40
MAINTENANCE	41
TROUBLESHOOTING	43
TECHNICAL SPECIFICATIONS	44

● Each name of corporations or products in the owner's manual is a trademark or a registered trademark of its respective corporation.

FEATURES AND DESIGN

This Multimedia Rear-Projection Display is designed for various use. The projector has large screen and utilizes built-in multimedia features, a palette of 16.77 million colors, and active matrix liquid crystal display (LCD) technology.

◆ Compatibility

This projector is compatible with many different types of personal computers and video devices, including;

- IBM-compatible computers, including laptops, up to 1280 × 1024 resolution.
- Apple Macintosh and PowerBook computers up to 1280 × 1024 resolution.
- Various VCRs, video disc players, video cameras, DVD players, satellite TV tuners or other AV equipment using any of the world wide video standards, including NTSC, NTSC4.43, PAL, SECAM, PAL-M and PAL-N.

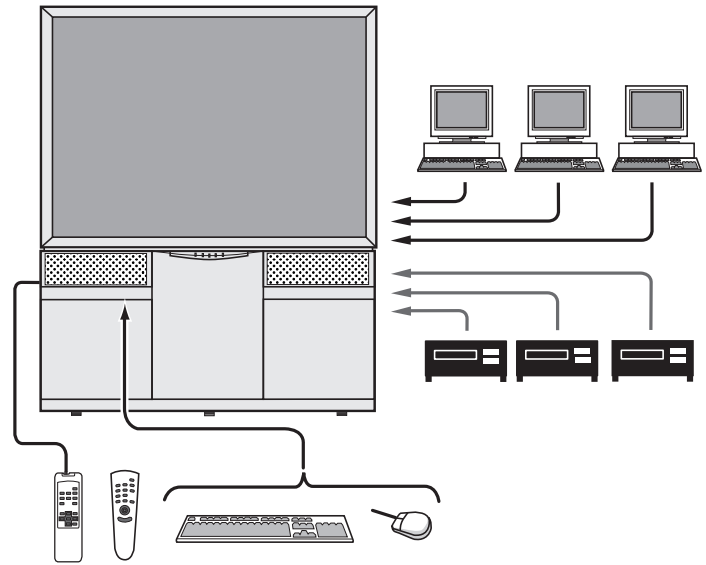

◆ Image Resolution

Picture Image is projected in the resolution of 1024 × 768. The projector provides computer images just as they appear on your computer's monitor. Screen resolutions between 1024 × 768 and 1280 × 1024 are compressed to 1024 × 768. The projector cannot display screen resolutions above 1280 × 1024. If your computer's screen resolution is higher than 1280 × 1024, reset it to a lower resolution before you connect the projector.

◆ Automatic Multiscanning System

This projector can detect output signals from most personal computers currently distributed. It is free from complicated adjustments to project picture images from PC.

◆ Wide Input Terminals

This projector has wide input terminals including; 3 computer input terminals and 3 video source input terminals (including component video inputs). And it also has the Mouse / Keyboard input terminals for controlling the computer easily.

◆ High Quality Audio System

This projector has audio system to produce high quality sound. There are Bass, Treble, and Surround function on the menu of the projector and you can enjoy powerful sound with large screen.

◆ Storage Spaces

This projector has the Storage Spaces on lower side of the cabinet for storing computers and video equipment. Storing the peripheral equipment in the Storage Spaces and connecting them at the rear terminal provide you simple and smart looking.

◆ Other Features

This projector has Picture Freeze and Mute functions, and Air Pad Remote Control.

◆ Accessories

This projector comes with the parts listed below. Check to make sure all are included. If any parts are missing, contact to a sales dealer.

- Owner's Manual
- Installation Manual
- AC Power Cord
- Wireless Remote Control Unit
- Wired/Wireless Remote Control Unit
- Remote Control Cable
- Batteries for Remote Control Units
- VGA Cable
- VGA/MAC Adapter
- Mouse Cable for PS/2 port
- Mouse Cable for serial port
- Mouse Cable for ADB port

INSTALLATION

INSTALLING THE PROJECTOR

Caution to the Installation

Contact the sales dealer and request to install this projector. For installing this appliance properly, technical services are required. Any person who is not familiar with technical terms and skills, should not attempt to install. This projector should be installed referring to the Installation Manual separately attached.



Caution for Installation

When installing and placing this projector, please observe the following precautions:

- Install the projector by two people.
- Any package material should not be left inside the cabinet.
- Be careful not to drop any part or tool like screw into the appliance. If it should, contact a service center.
- Never touch the Projection Screen, Lens and Mirror directly. They may affect the projection image quality.
- Place the projector where is indicated on this Owner's Manual.

This projector never be placed outdoor

Placing and Settling the Projector

When placing the projector, the spaces for ventilation must be maintained. And fix the projector with the Lock Bolts to settle it securely.

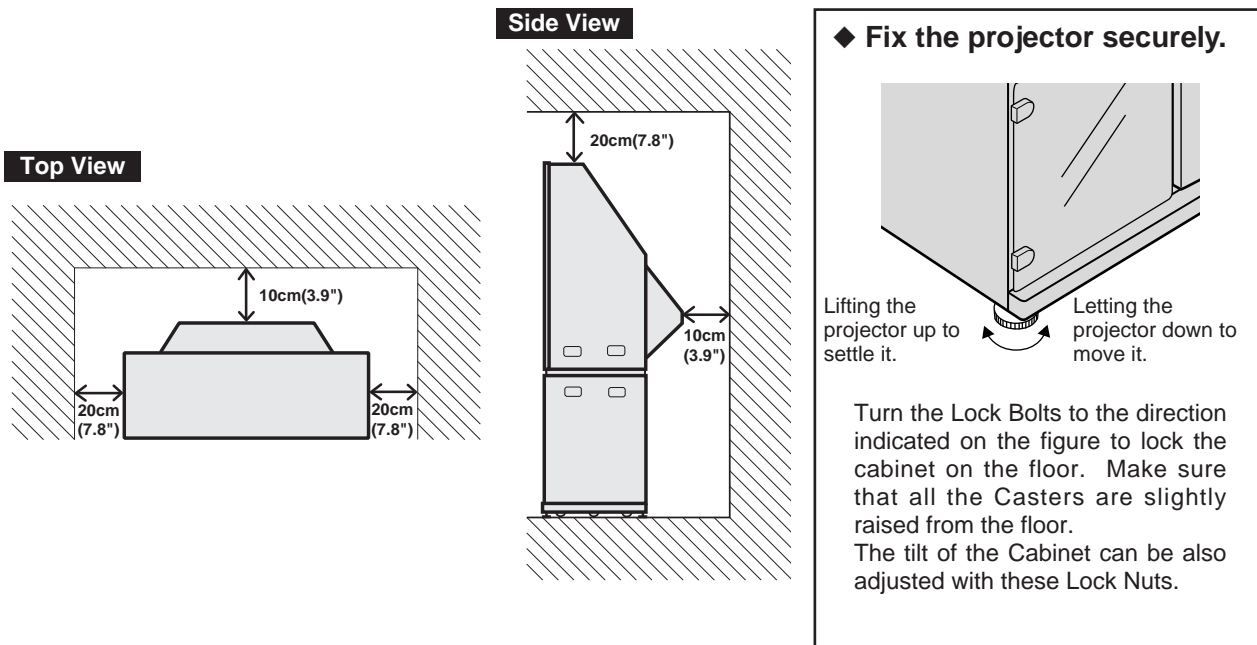



CAUTION FOR INSTALLATION OF THE PROJECTOR

When using or installing the projector, following attention should be taken:

- We recommend to avoid dusty / smoky place for operating the projector. .
When using under the dusty or smoky conditions, dust may accumulate on the LCD panel and Lens inside it, and may be projected on the screen together with the picture. When the symptoms above are noticed, contact your authorized dealer or service station for the cleaning.
- Air blown from the exhaust bent is hot. Do not put a flammable objects near this part. Keep heat-sensitive objects away from the exhaust part. And do not touch this part especially screws and metallic parts. This part will become hot while the projector is used.
- The brightness in the room has a great influence on the quality of a picture. Adjust the light little darker to provide fine pictures.

BE SURE TO USE OR PLACE THE PROJECTOR IN THE TEMPERATURE INDICATED BELOW.

OPERATING TEMPERATURE : 5°C ~ 35°C

STORAGE TEMPERATURE : -10°C ~ 60°C

CARE AND CLEANING

The surface of the cabinet and screen can be damaged if not properly maintained. Many common household aerosol sprays, cleaning agents, solvents and polishes will cause permanent damage to the fine surface.

Clean the cabinet with a soft cloth dampened with glass household detergent and warm water, and dry thoroughly.
Clean the screen with a soft cloth dampened with warm water. Wipe and dry with a soft dry cloth.

DO NOT APPLY SINNER, BENZINE OR AEROSOL SPRAYS. THEY MAY CAUSE PERMANENT DAMAGE ON THE SCREEN.

PREPARING THE REMOTE CONTROLS

Remote Control Battery Installation

WIRELESS REMOTE CONTROL UNIT

- 1** Remove the battery compartment lid.

Press the lid downward and slide it.

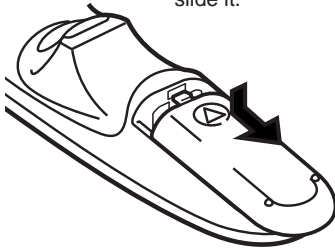

- 2** Slide the batteries into the compartment.

Two AA size batteries

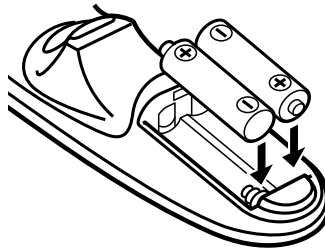

For correct polarity (+ and -), be sure the battery terminals are in contact with the pins in the compartment.

- 3** Replace the compartment lid.

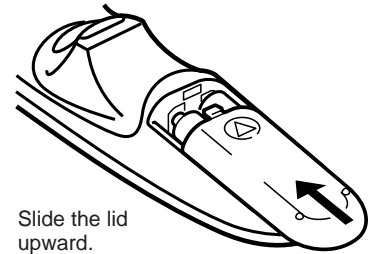

Slide the lid upward.

WIRELESS/WIRED REMOTE CONTROL UNIT

- 1** Remove the battery compartment lid.

Press the lid downward and slide it.

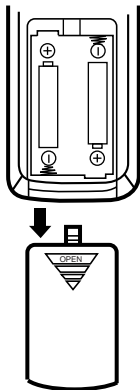

- 2** Slide the batteries into the compartment.

Two AA size batteries

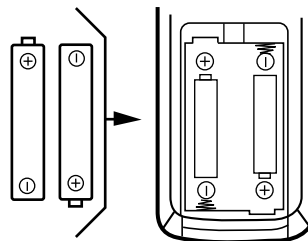

For correct polarity (+ and -), be sure the battery terminals are in contact with the pins in the compartment.

- 3** Replace the compartment lid.

Slide the lid upward.

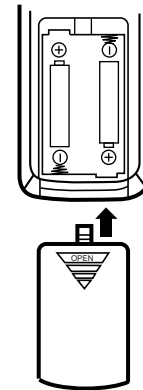

**Caution for handling Remote Control Units**

When operating the Remote Control Units, please observe the following precautions:

- Avoid contact with water.
- Do not expose the Remote Control Units to moisture, or heat.
- Do not drop the Remote Control Units.

**Caution for handling batteries**

Install batteries properly to match the "+" and "-" marks inside the case. If batteries are installed or used incorrectly, it may cause liquid leak, explosion, injury, fire hazard, or pollution. To insure safe operation, please observe the following precautions:

- Change two batteries at the same time.
- Do not use a new battery with a used one .
- Avoid contact with water.
- Charging or reconstructing.
- If batteries have leaked on the Remote Control Units, carefully wipe the case clean and load new batteries.

NAME OF EACH PART OF THE PROJECTOR

Front of the Projector

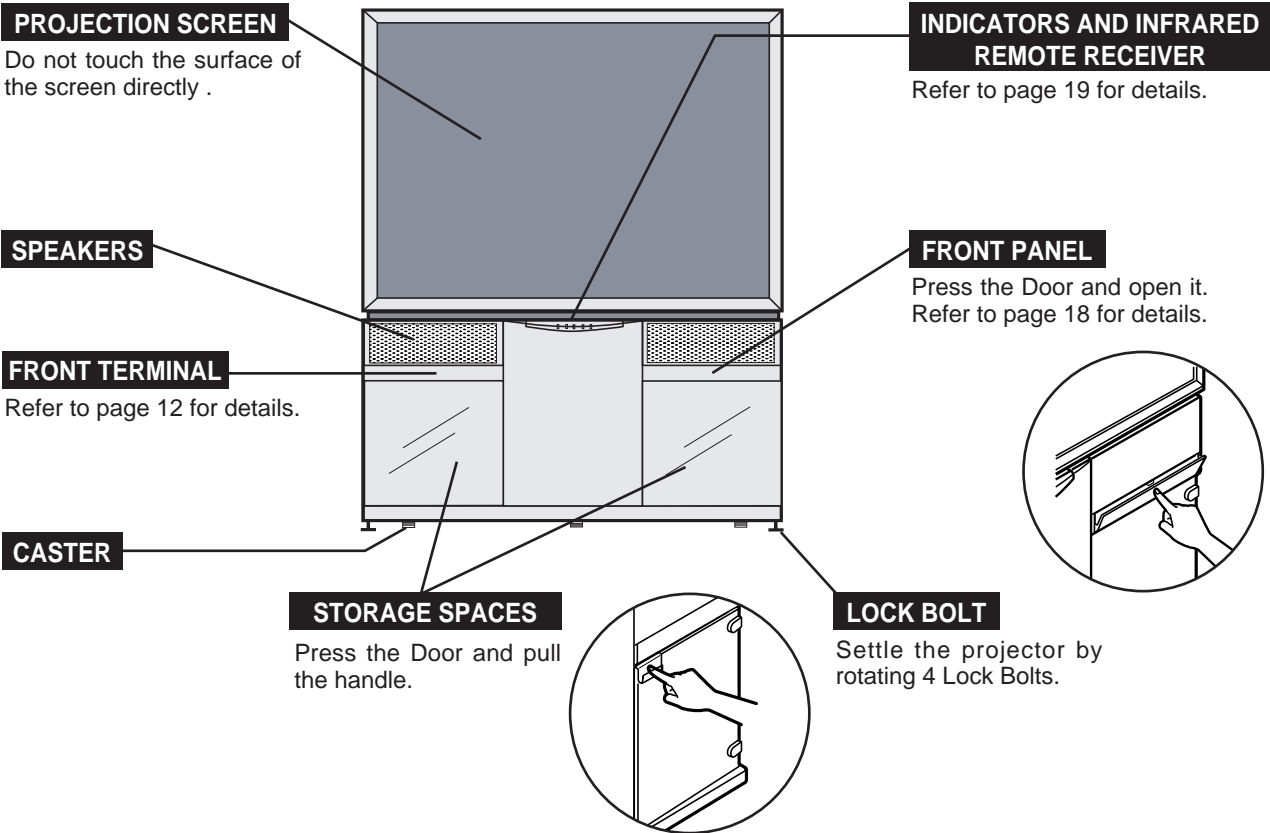

Rear of the Projector

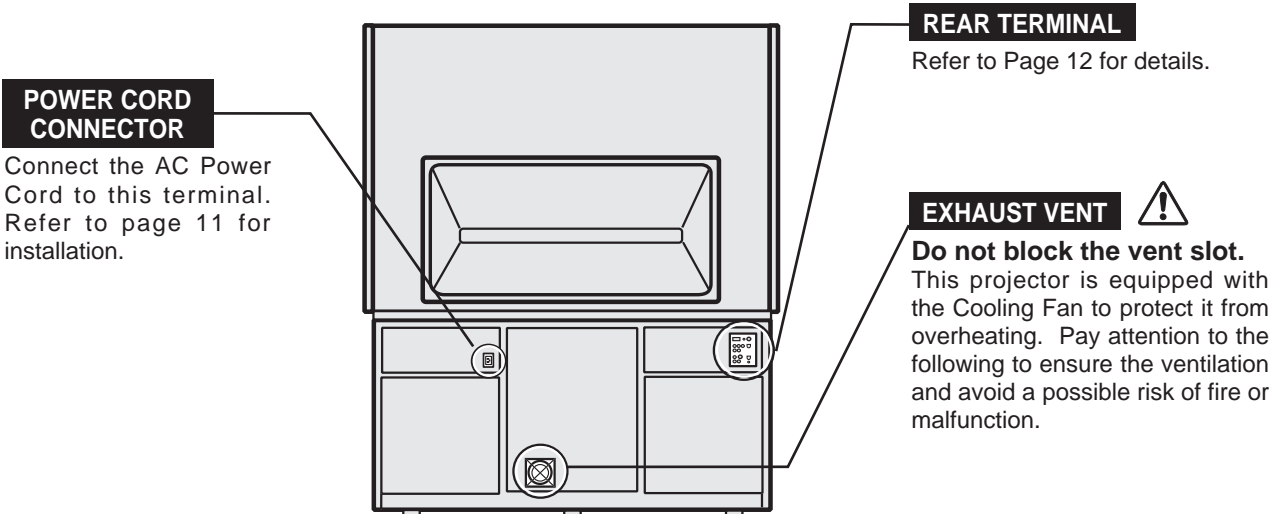

CONNECTING THE AC POWER CORD

This projector uses nominal input voltages of 100 ~ 120 V AC. It is designed to work with single-phase power systems having a grounded neutral conductor. To reduce the risk of electrical shock, do not plug into any other type of power system.

Consult a sales dealer or service station if you are not sure of the type of power supply being in use.

Connect the projector with the peripheral equipment before turning the projector on. (Refer to page 14 ~ 17 for connection.)

- 1** Connect the AC Power Cord (supplied) to the Power Cord Connector on the projector.
- 2** Connect the AC Power Cord to the AC outlet.

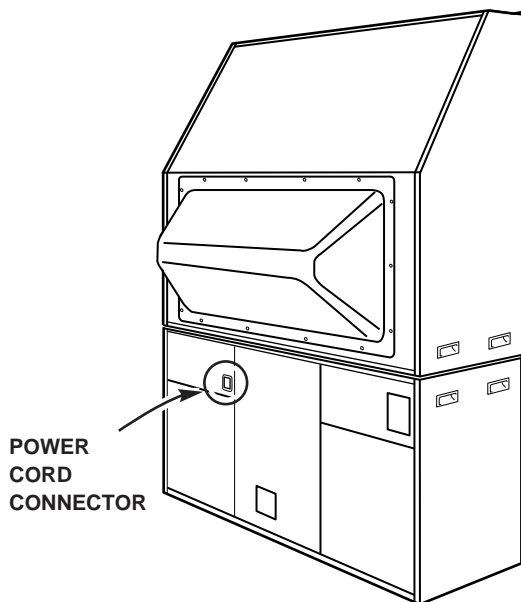

AC POWER CORD

Projector side (Female)

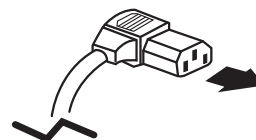

Connect to the Power Cord Connector on the projector.

AC Outlet side (Male)

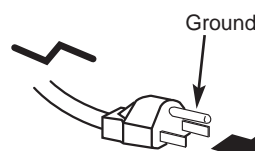

Connect the AC Outlet.



CAUTION

For the safety, unplug the AC Power Cord when the appliance is not used.

CONNECTING THE PROJECTOR

TERMINALS OF THE PROJECTOR

This projector has various kind of terminals to connect with peripheral equipment. Connect the projector with these equipment before turning them on. (Refer to page 14 ~ 17 for connection.)

Rear Terminal

COMPUTER IN 1

Connect the Computer output to this terminal.
(Refer to page 14 and 15.)

VIDEO IN 1, 2

Connect the Video and Audio outputs from the video equipment to these terminals. C/Cb, and Cr terminals are provided for component video input, such as DVD player.
(Refer to page 16 and 17.)

- ◆ When the audio input of the audio equipment is monaural, connect it to the left jack.

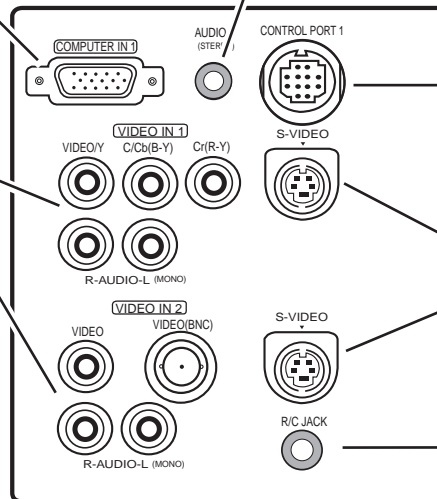

AUDIO IN 1

Connect the Audio output from the computer to this terminal.
(Refer to page 14 and 15.)

CONTROL PORT 1

When controlling the computer with the Wireless Remote Control of this projector, connect the mouse port to this terminal.
(Refer to page 14 and 15.)

S-VIDEO

Connect the S-VIDEO output from the video equipment to this terminal.
(Refer to page 16.)

R/C JACK

When using the Wired/Wireless Remote Control Unit as the Wired Remote Control, Connect the Wired Remote Control Unit to the R/C JACK with the Remote Control Cable (supplied).
(Refer to page 21.)

Front Terminal

COMPUTER IN 2, 3

Connect the Computer outputs to these terminals.
(Refer to page 14 and 15.)

AUDIO IN 2, 3

Connect the Audio outputs from the computers to these terminals.

CONTROL PORT 2, 3

When controlling the computer with the Wireless Remote Control of this projector, connect the mouse port to these terminals.
(Refer to page 14 and 15.)

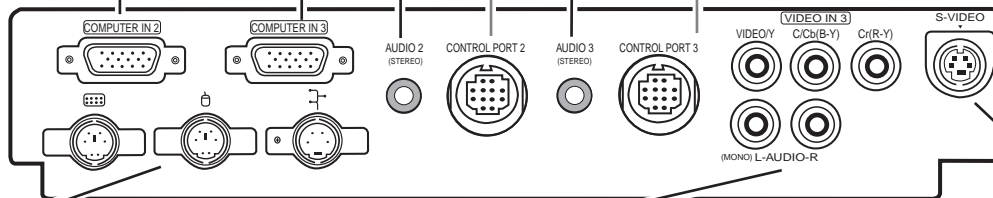

MOUSE / KEYBOARD

To use these terminals, connection of the Mouse/Keyboard Cable inside the Storage Cabinet is required.
(Refer to page 40.)

VIDEO IN 3

Connect the Video and Audio output from the video equipment to these terminal. C/Cb, and Cr terminals are provided for component video input, such as DVD player.
(Refer to page 16 and 17.)

- ◆ When the audio input of the audio equipment is monaural, connect it to the left jack.

S-VIDEO

Connect the S-VIDEO output from the video equipment to this terminal.
(Refer to page 16.)

COMPUTER IN

Terminal : HDB15-PIN

Connect the display output terminal of the computer to the projector with the VGA Cable (supplied). When connecting the Macintosh computer the MAC/VGA Adapter is required.

Pin Configuration

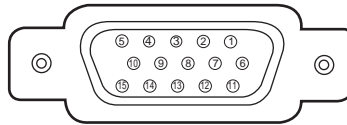

1	Red Input	9	Non Connect
2	Green Input	10	Ground (Vert.sync.)
3	Blue Input	11	Sense 0
4	Sense 2	12	Sense 1
5	Ground (Horiz.sync.)	13	Horiz. sync.
6	Ground (Red)	14	Vert. sync.
7	Ground (Green)	15	Reserved
8	Ground (Blue)		

CONTROL PORT

Terminal : MULTI-POLE 12-PIN

When controlling the computer with the projector's Wireless Remote Control Unit, connect control port (PS/2, Serial or ADB port) on your computer to this terminal. (Three types of cables are supplied.)

Pin Configuration

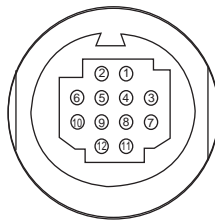

	PS/2	Serial	ADB
1	----	T X D	----
2	CLK	----	ADB
3	DATA	----	----
4	----	----	----
5	----	R X D	----
6	----	----	----
7	----	READY	----
8	----	----	----
9	GND	GND	GND
10	----	----	----
11	----	----	----
12	----	----	----

NOTE : The R X D port (5th pin on the Serial Port is provided on Control Port 1 only. If your control the projector by computer you must connect Control Port 1 connector.

VIDEO IN

VIDEO / Y

Connect the Composite Video output, or the Y signal output from the Component Output Video equipment (like DVD player) to this terminal.

C / Cb

Connect the C component or Cb component signal output from the Component Output Video equipment to this terminal.

Cr

Connect the Cr component signal output from Component Output Video equipment to this terminal.

BNC

Connect the Composite Video output from the BNC terminal to this terminal. When connecting to this terminal, do not connect any input source to the VIDEO terminal.

AUDIO R / L

Connect the Audio output to this terminal. When the audio output of the audio equipment is stereo, be sure to connect the right and left channels to the respective right and left jacks. And when the audio input of the audio equipment is monaural, connect it to the left jack.

CAUTION

When connecting the peripheral equipment to the projector, please observe the following precautions:

- Be sure that the each equipment is turned off.
- Connect the cable securely to the respective terminal.
- When removing the cable, never pull the cord. Hold the plug of the cable and remove it.
- When operating the peripheral equipment, turn off the other equipment that is not used.

CONNECTING TO THE COMPUTER

CONNECTING THE IBM-COMPATIBLE COMPUTER

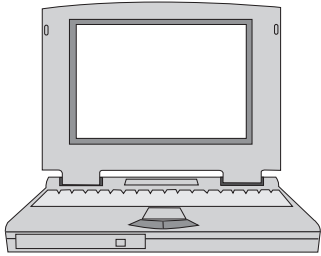

To connect with the IBM-compatible computer, refer to the figure below.

Use Cables and Adapter indicated below.

- VGA CABLE (supplied)
- MOUSE CABLE FOR PS/2 PORT or SERIAL PORT (supplied)
- AUDIO CABLE (not supplied)

◆ Be sure to connect the MOUSE CABLE to match the terminal.

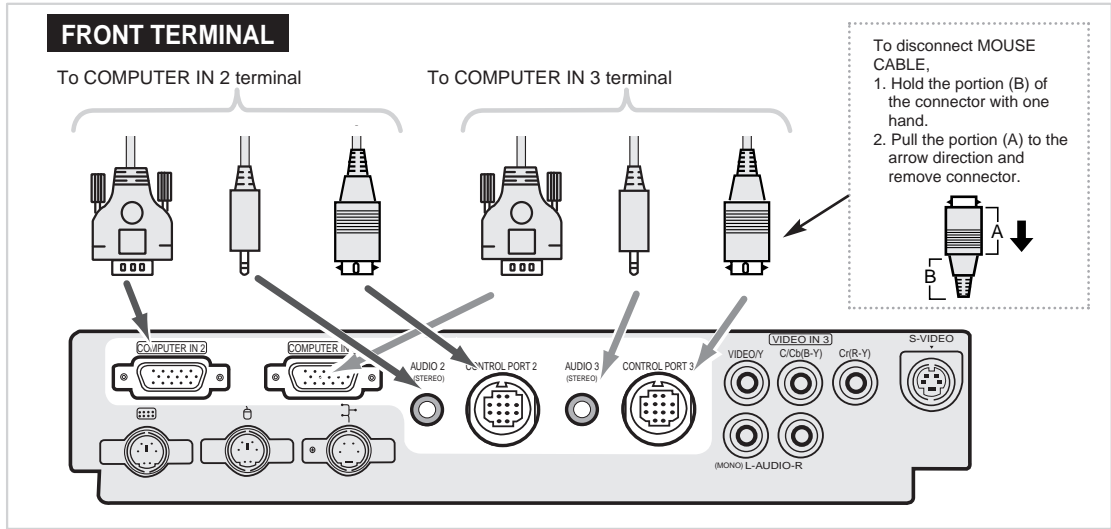
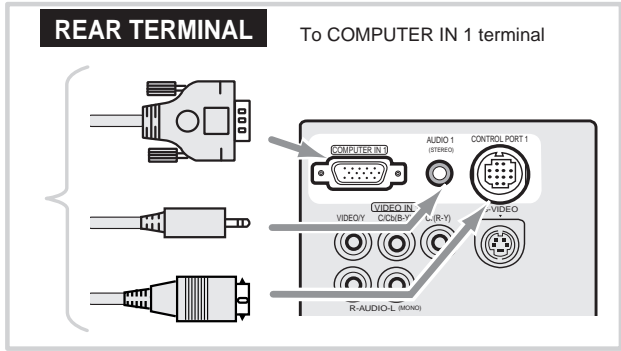
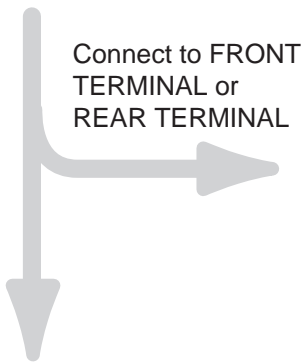
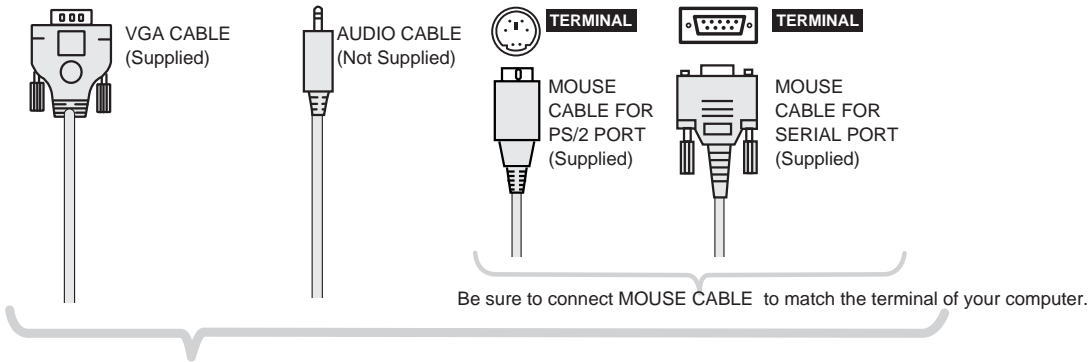

CONNECTING THE MACINTOSH COMPUTER

To connect with the Macintosh computer, refer to the figure below.

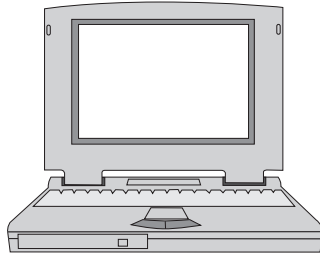

Use Cables and Adapter indicated below.

- VGA CABLE (supplied)
- VGA/MAC ADAPTER (supplied)
- MOUSE CABLE FOR ADB PORT (supplied)
- AUDIO CABLE (not supplied)

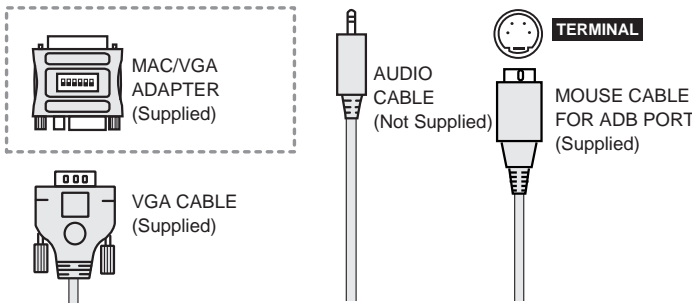

◆ MAC/VGA ADAPTER

Set the switches as shown in the table below depending on the RESOLUTION MODE that you want to use before your turn on the projector and computer

The Switches of the MAC/VGA Adapter

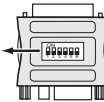

MODE	SWITCHES					
	1	2	3	4	5	6
13"MODE (640 x 480)	ON	ON	OFF	OFF	OFF	OFF
16"MODE (832 x 624)	OFF	ON	OFF	ON	OFF	OFF
19"MODE (1024 x 768)	OFF	ON	ON	OFF	OFF	OFF
21"MODE (1152 x 870)	ON	ON	ON	ON	OFF	OFF

Connect to FRONT TERMINAL or REAR TERMINAL

REAR TERMINAL

To COMPUTER IN 1 terminal

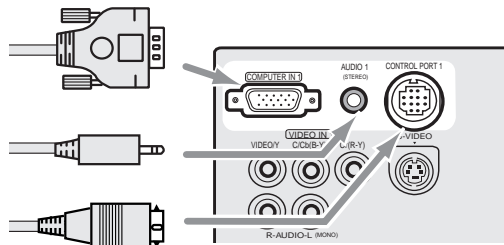

FRONT TERMINAL

To COMPUTER IN 2 terminal

To COMPUTER IN 3 terminal

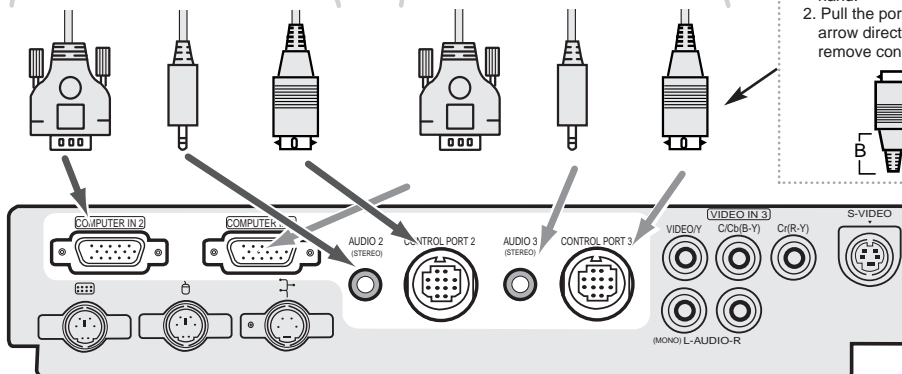

To disconnect MOUSE CABLE,

1. Hold the portion (B) of the connector with one hand.
2. Pull the portion (A) to the arrow direction and remove connector.

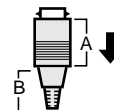

CONNECTING TO THE VIDEO EQUIPMENT

CONNECTING THE VIDEO EQUIPMENT

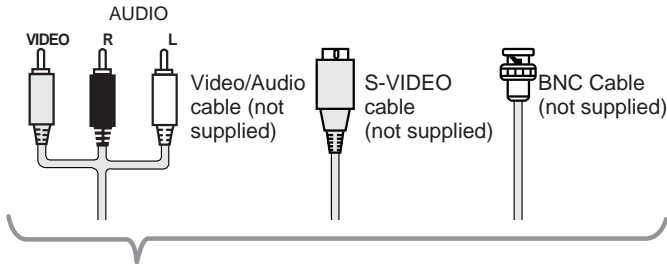
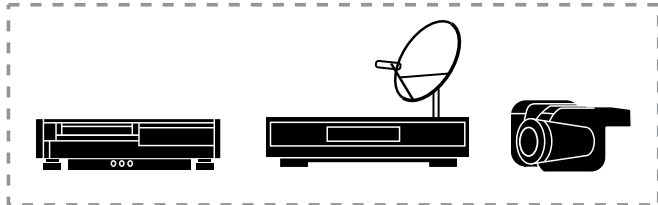

Refer to the figure below for connecting the video equipment like VCR, video disc player, video camera, satellite TV tuner or other video equipment.

- ◆ The Video input includes S-VIDEO Jacks to allow connection to an S-VHS format VCR. The S-VIDEO jack has priority over the VIDEO jack.
- ◆ When connecting the video source to the VIDEO IN 2, connect either the Video cable or the BNC cable to the projector. Do not connect on both terminals.

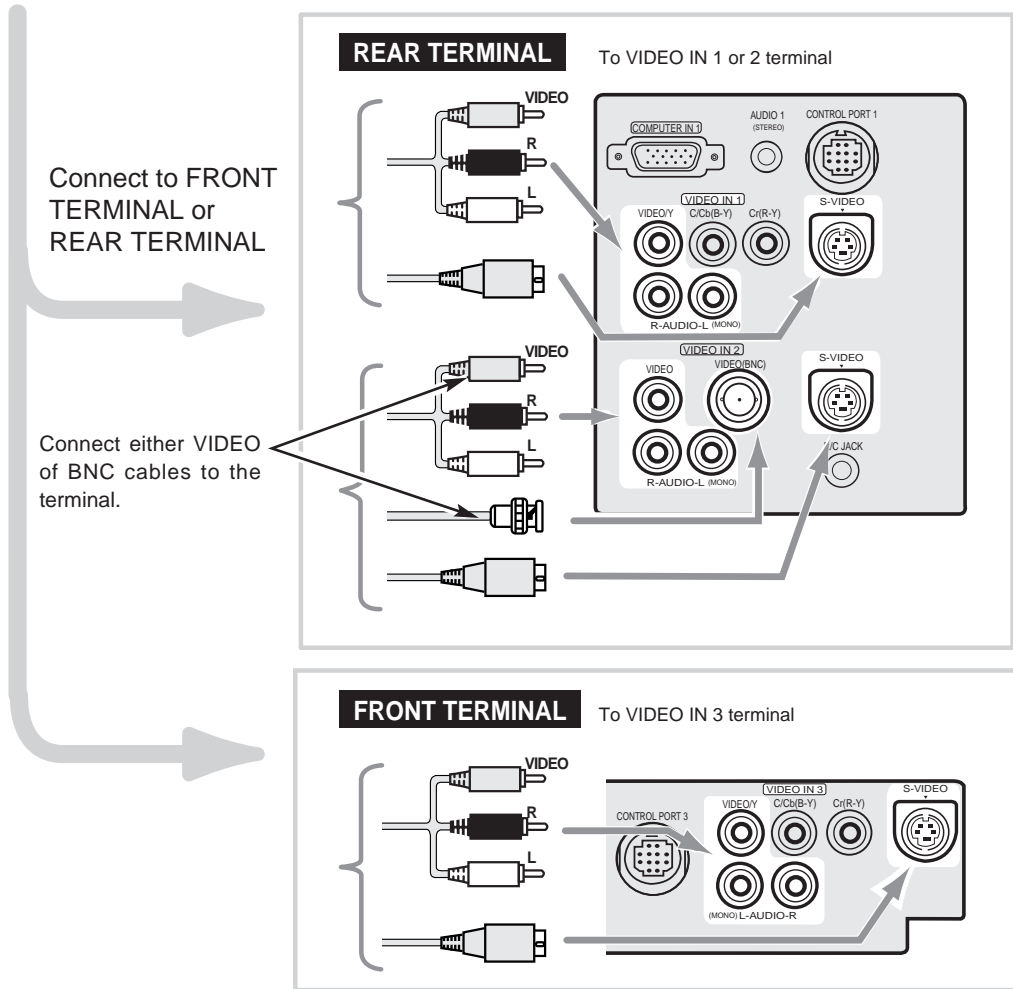

CONNECTING THE COMPONENT VIDEO EQUIPMENT

Refer to the figure below to connect the component video output equipment like DVD player.

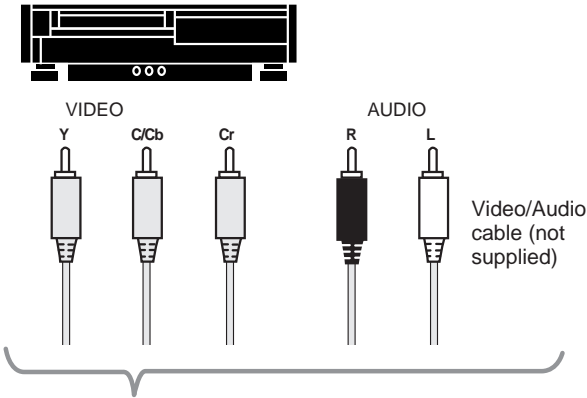

Connect to FRONT TERMINAL or REAR TERMINAL

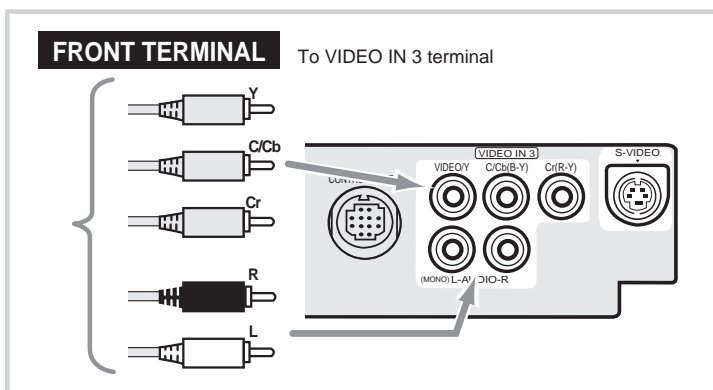
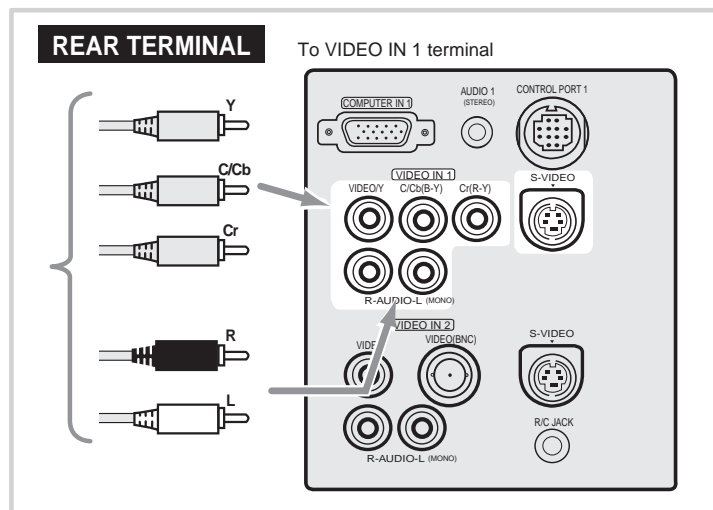

BEFORE OPERATION

CONTROLS AND INDICATORS

CONTROLS OF FRONT PANEL (Within Right Door)

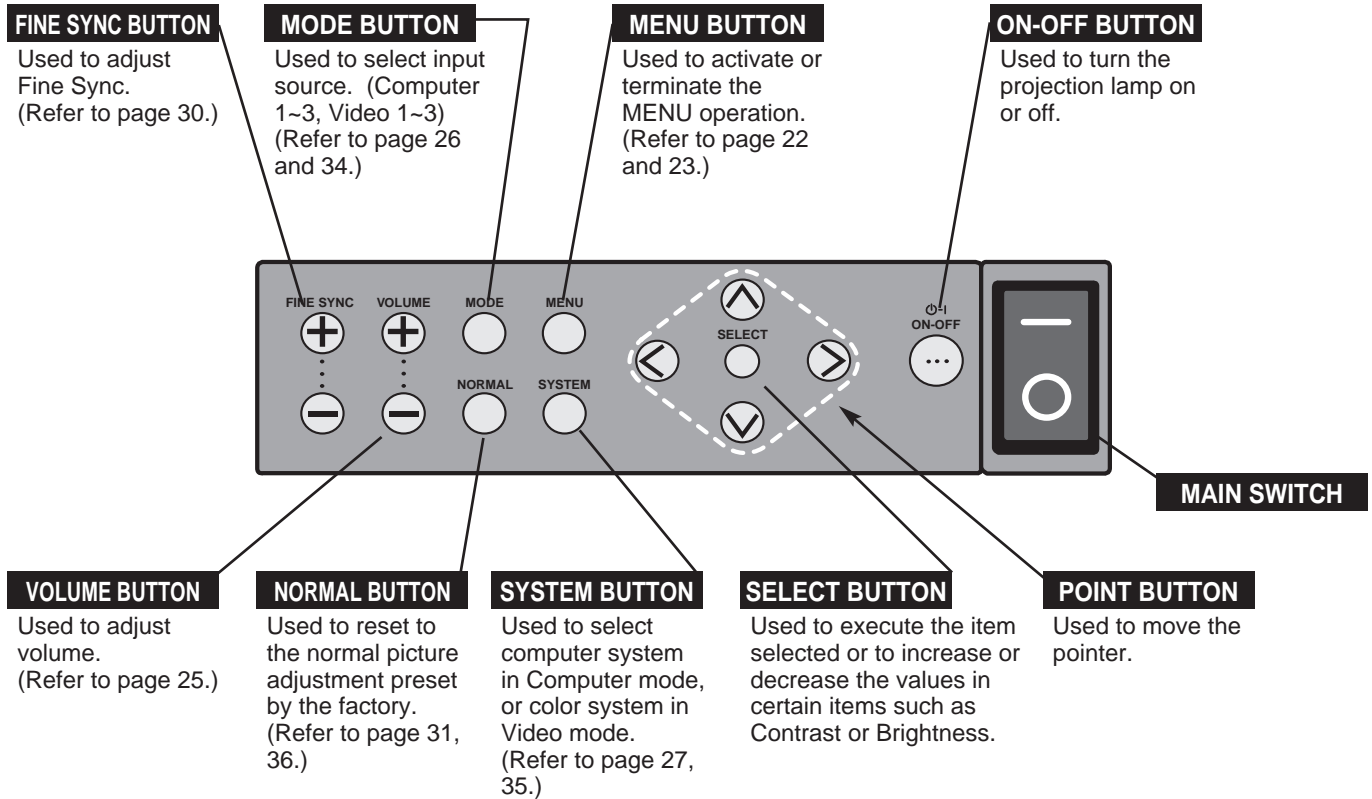

Indicators and Remote Receiver

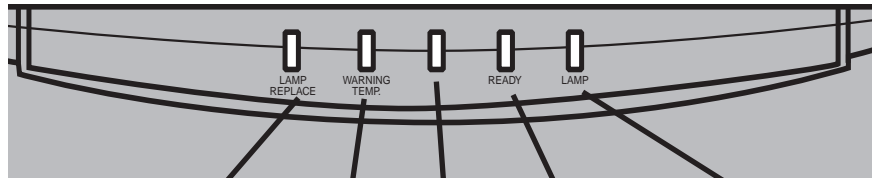

LAMP REPLACEMENT INDICATOR

Light turns to yellow when the life of a projection lamp draws to an end. (Refer to Page 42.)

TEMPERATURE WARNING INDICATOR

Flashes red when internal projector temperature is too high.

LAMP INDICATOR

Light is dim when the projector is on. And light is brightened when the projector is in stand-by mode.

READY INDICATOR

Light is green when the projector is ready to be turned on.

REMOTE RECEIVER

Point the Remote Control Units toward this Receiver when pressing the buttons.

The Operating Range of the Remote Control

Maximum operating range for the Remote Control is about 16.4' (5m) and 60° front of the projector.

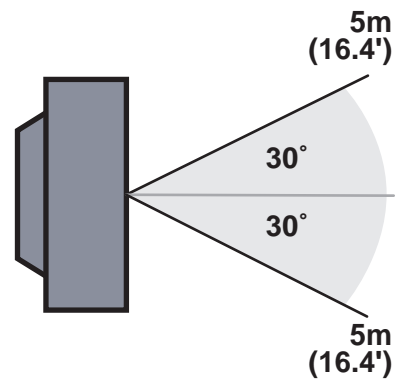

OPERATION OF THE REMOTE CONTROLS

Wireless Remote Control Unit

This remote control unit is not only able to operate the projector but also usable as a wireless mouse for a PC. One pointing pad and two click buttons are used for wireless mouse operation. Wireless mouse is usable when PC mouse pointer is displayed on the screen, the wireless mouse cannot be used when the On-Screen Menu is displayed.

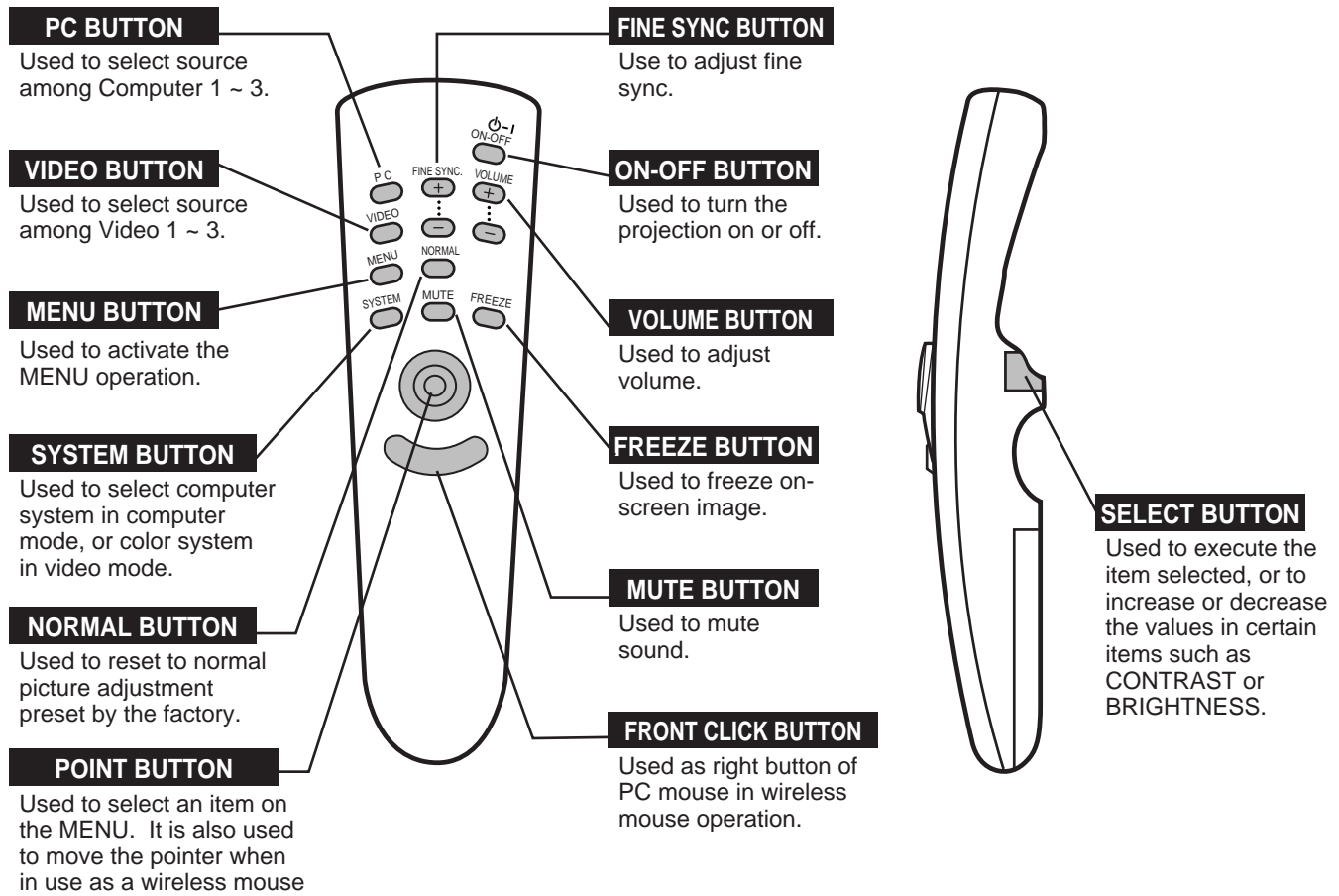

The Wireless Remote Control Unit is designed for easy handling. Grasp the Wireless Remote Control as the figure below.

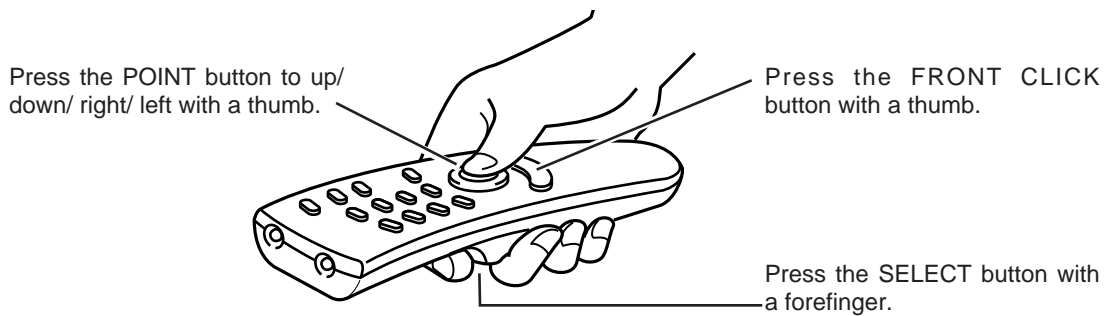

Wireless/Wired Remote Control Unit

When the Remote Control Unit cannot be pointed at the Infrared Remote Receiver, connect the Wired/Wireless Remote Control Unit to the projector with the Remote Control Cable(supplied).

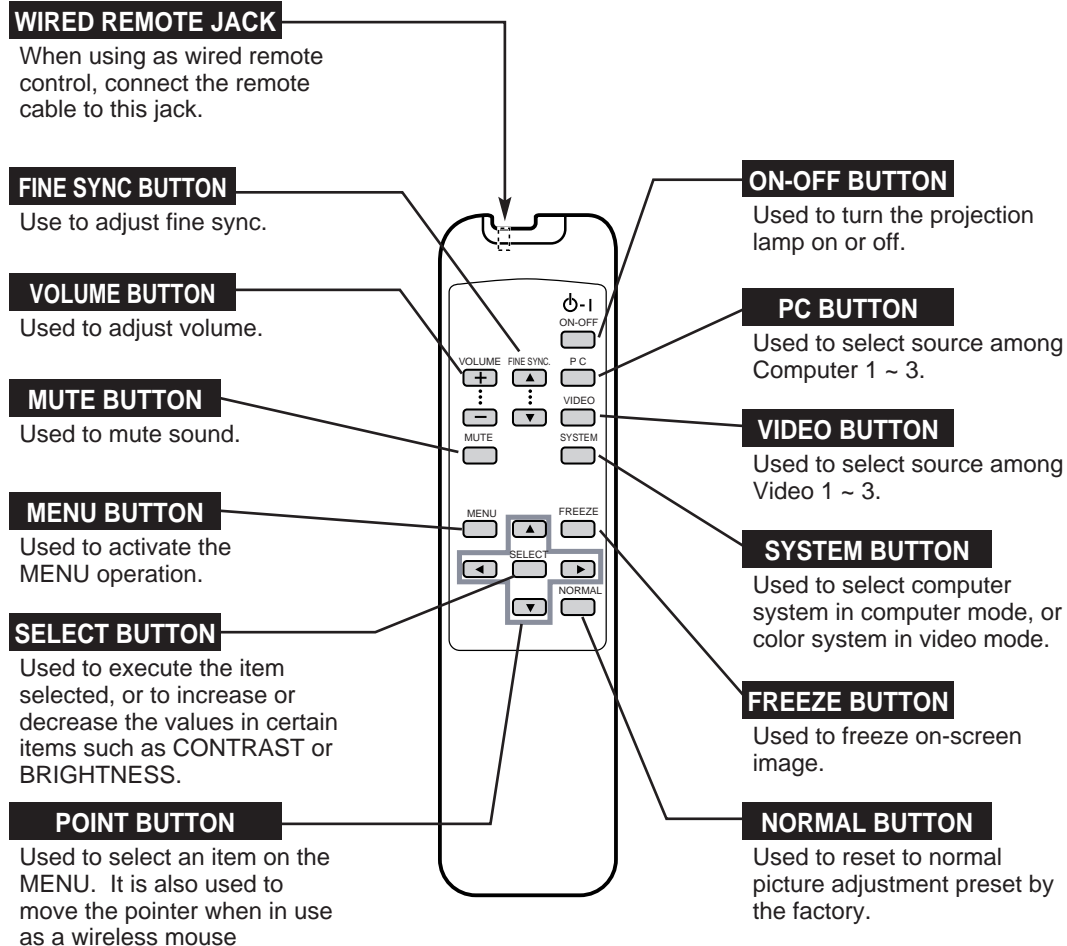

When using the Wired/Wireless Remote Control Unit as the Wired Remote Control, Connect the Wired Remote Control Unit to the R/C JACK with the Remote Control Cable (supplied).
(The battery installation is required when using the Wired Remote Control Unit.)

Rear Terminal

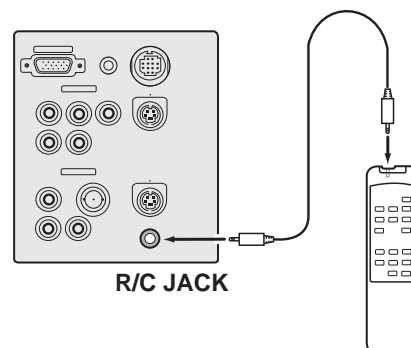

OPERATING ON-SCREEN MENU

HOW TO OPERATE ON-SCREEN MENU

You can control and adjust this projector through ON-SCREEN MENU. Refer to P18 ~35 to operate ON-SCREEN MENU.

1 MOVING THE POINTER

Move the pointer (see the NOTE below) by pressing POINT button(S) on the FRONT CONTROL or the REMOTE CONTROL(S).

2 SELECT THE ITEM

Select the item by pressing SELECT button.

NOTE :Pointer is the icon on the ON-SCREEN Menu to select the item. See the figures on the section "FLOW OF ON-SCREEN MENU" below.

WIRELESS REMOTE CONTROL

POINT BUTTON

Used to move the Pointer to UP/ DOWN/ RIGHT/ LEFT.

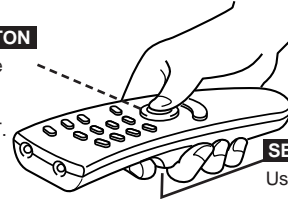

SELECT BUTTON
Used to select the item.

WIRED REMOTE CONTROL

SELECT BUTTON

Used to select the item.

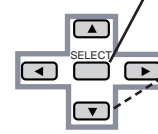

POINT BUTTON

Used to move the Pointer to UP/ DOWN/ RIGHT/ LEFT.

FRONT CONTROL

SELECT BUTTON

Used to select the item.

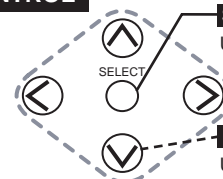

POINT BUTTON

Used to move the Pointer to UP/ DOWN/ RIGHT/ LEFT.

FLOW OF ON-SCREEN MENU

Display ON-SCREEN MENU

1 Press MENU button to display the ON-SCREEN MENU (MENU BAR). The red frame is the POINTER.

Select the MENU

2 Move the POINTER (red frame) to the ITEM ICON that you want to select by pressing POINT RIGHT/ LEFT buttons.

3 Select the ITEM by pressing SELECT button. The dialog box of the ITEM appears.

Control and adjust through ON-SCREEN MENU

4 Move the POINTER downward by pressing POINT DOWN button. (The shape of POINTER become an arrow.)

5 Move the POINTER to the ITEM that you want to adjust and adjust the ITEM by pressing SELECT button. Refer to P24~37 for details of respective adjustments.

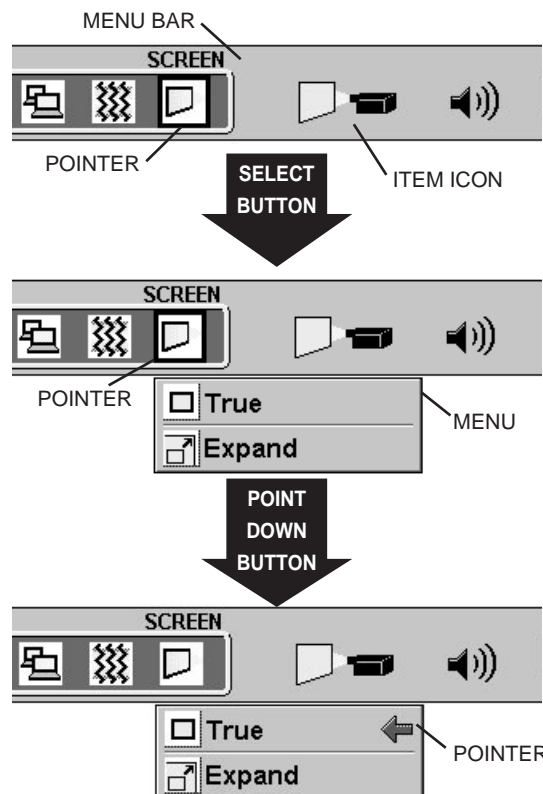

MENU BAR

MENU BAR IN COMPUTER MODE Press MENU BUTTON while being in Computer mode.

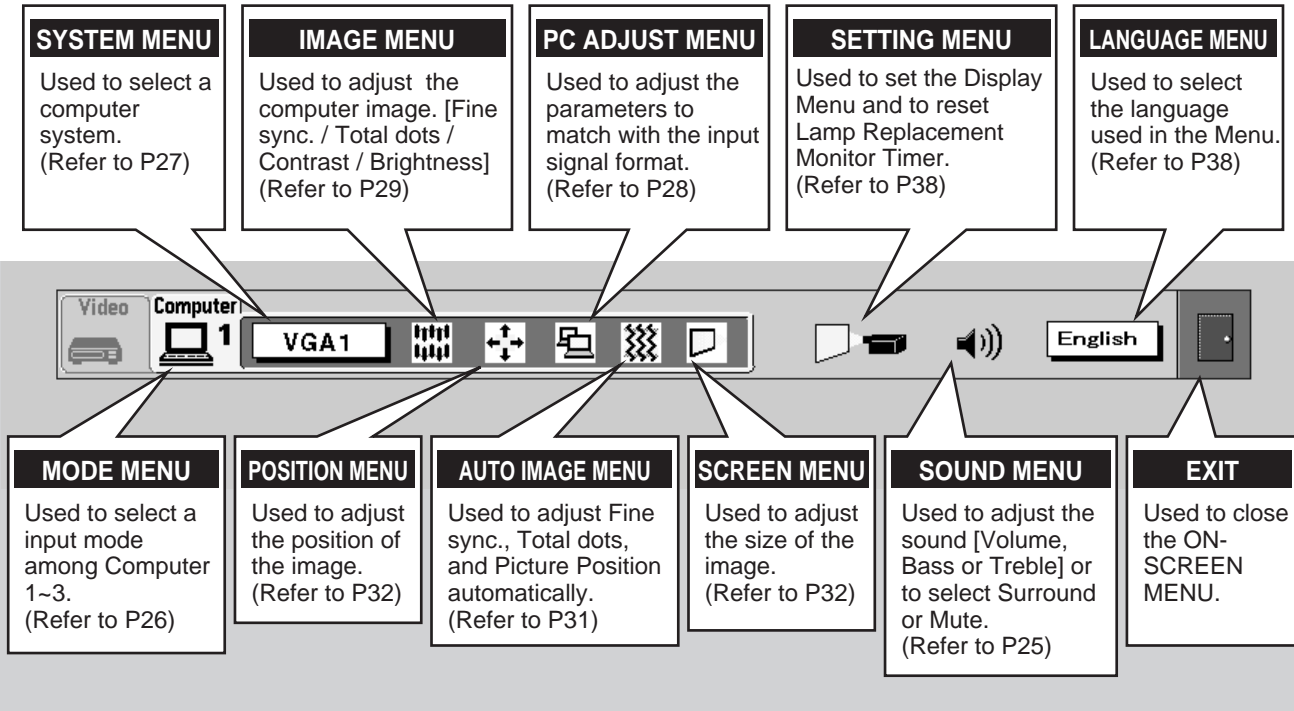

MENU BAR IN VIDEO MODE Press MENU BUTTON while being in Video mode.

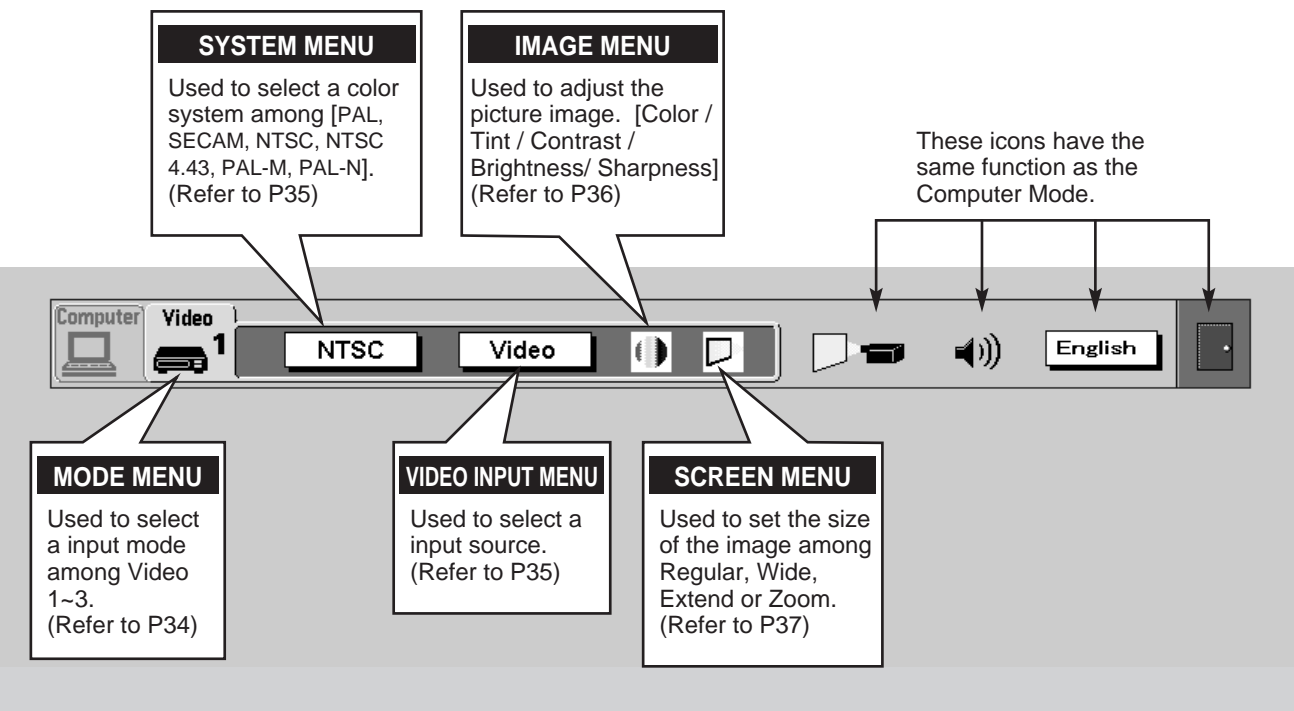

BASIC OPERATION

TURNING ON / OFF THE PROJECTOR

Turning on the Projector

- 1 Connect the peripheral equipment (Computer, VCR, and etc.) before turning on the projector. (Refer to "CONNECTING TO THE PROJECTOR" on Pages 10~15 for connecting those equipment.)
- 2 Connect the projector's AC power cord into a wall outlet and turn the MAIN ON/OFF switch (located on the Front Control) to the ON position. The LAMP POWER indicator lights RED, and the READY indicator lights GREEN.
- 3 Press the power ON/OFF button on the Remote Control Unit or on the projector to ON. The LAMP POWER indicator dims, and the Cooling Fans start to operate. The Preparation Display appears on the screen and the count-down starts. The signal from the source appears after 30 seconds.

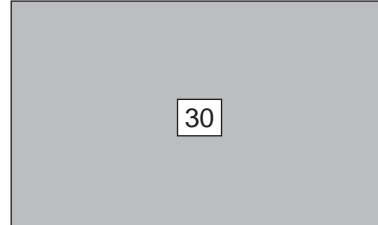

The Preparation Display disappears after 30 seconds.

Turning off the Projector

- 1 Press the power ON/OFF button on the Remote Control Unit or on the Front Control, and the message "Power off?" appears on the screen.
- 2 Press again the power ON/OFF button to turn off the projector. The LAMP POWER indicator lights bright and the READY indicator turns off. The Cooling Fans operate for 1 minute after the projector is turned off. (During this "Cooling Down" period, this appliance cannot be turned on.)
- 3 When the cooling the projector has finished, the READY indicator turns to green again and you can turn the projector on. To power down completely, turn the MAIN ON/OFF switch to the OFF position.

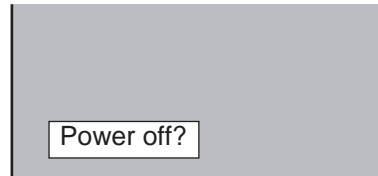

The message disappears after 4 seconds.



THIS PROJECTOR USES AN UHP LAMP. TO MAINTAIN THE LIFE OF THE LAMP, ONCE YOU TURN IT ON, WAIT AT LEAST 5 MINUTES BEFORE TURNING IT OFF.

When the TEMPERATURE WARNING indicator flashes red, the projector is automatically turned off. Wait at least 5 minutes before turning the projector on again.

If the TEMPERATURE WARNING indicator continues to flash, follow procedures below:

1. Press the power ON/OFF button to OFF.
2. Check the air filters for dust accumulation.
3. Remove dust with vacuum cleaner. (See "AIR FILTER CARE AND CLEANING" section on page 46.)
4. Press the LAMP POWER ON/OFF button to ON.

If the TEMPERATURE WARNING indicator still continues to flash, call your authorized dealer or service station.

SOUND ADJUSTMENT

Direct Operation

Sound Volume Adjustment

Press the VOLUME (+/-) buttons (located on the Front Control or on the Remote Control Units) to adjust the volume. The Volume dialog box appears on the screen for a few seconds.

(+) button to increase the volume, and (-) button decreasing.

Sound Mute Setting

Press the MUTE button on the Remote Control Units to cut off the sound. To restore the sound to its previous level, press again or press Volume buttons.

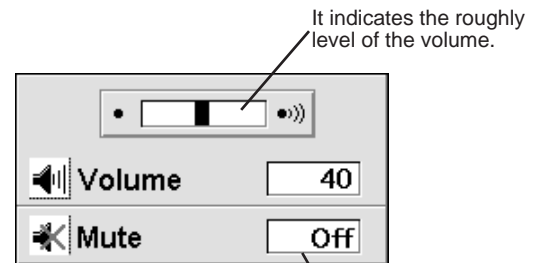

The display disappears after 4 seconds.

Press the MUTE button to set the Mute function On or Off.

Menu Operation

- 1 Press the MENU button and the ON-SCREEN MENU will appear. Press the POINT LEFT/RIGHT buttons to select SOUND and press the SELECT (REAR CLICK) button. Another dialog box SOUND ADJUST Menu will appear.
- 2 Press the POINT DOWN button and a red-arrow icon will appear. Move the arrow to the item that you want to select by pressing the POINT UP/DOWN buttons.

Volume Move the arrow to ▲ or ▼ of "Volume" by pressing the POINT UP/ DOWN buttons. To increase the volume, point the arrow to ▲ and then press the SELECT (REAR CLICK) button. To decrease the volume point the arrow to ▼ and then press the SELECT (REAR CLICK) button.

Treble To adjust the Treble sound, point the arrow to ▲ or ▼ of "Treble" and then press the SELECT button.

Bass To adjust the Bass sound, point the arrow to ▲ or ▼ of "Bass" and then press the SELECT button.

Surround It set the audio sound to "Surround" sound. To set the Surround, turn the Surround "On" by pressing the SELECT button.

Mute To cut off the audio sound, point the arrow to "Mute" and then press the SELECT (REAR CLICK) button. The Mute display is changed On from Off and the sound is cut off. To restore the sound to its previous volume level, set the Mute to Off.

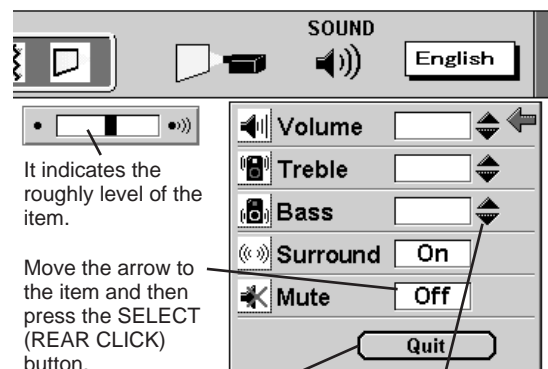

It terminates the Sound Menu.

Move the arrow to ▲ or ▼ and press the SELECT (REAR CLICK) button.

PICTURE FREEZE FUNCTION

Press the FREEZE button on the Remote Control Unit, and the picture will remain on-screen. This function is cancelled when the FREEZE button is pressed again or any other function button is pressed.

COMPUTER MODE

SELECTING COMPUTER MODE

Direct Operation

Press the MODE button on the Front Control or the PC button on Remote Control Units. Select the Mode among Computer1 to Computer 3 corresponding with the input source. The display of "Computer 1," "Computer 2," "Computer 3," "Video 1," "Video 2," or "Video 3" appears on the screen for a few second. (The "Computer 1," "Computer 2," or "Computer 3" appears when pressing the PC button.)

- Computer 1** Displaying the image from "Computer 1" on the Rear Terminal.
- Computer 2** Displaying the image from "Computer 2" on the Front Terminal.
- Computer 3** Displaying the image from "Computer 3" on the Front Terminal.

Menu Operation

- 1** Press the MENU button and the ON-SCREEN MENU will appear. Press the POINT LEFT/RIGHT buttons to select Computer  and press the SELECT (REAR CLICK) button. Another dialog box COMPUTER MODE Menu will appear.
- 2** Press the POINT DOWN button and a red-arrow icon will appear. Move the arrow to the mode among Computer1 to Computer3 that you want to select, and then press the SELECT (REAR CLICK) button.

MODE button

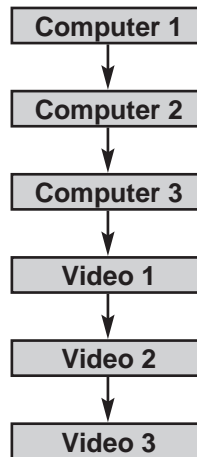

PC button

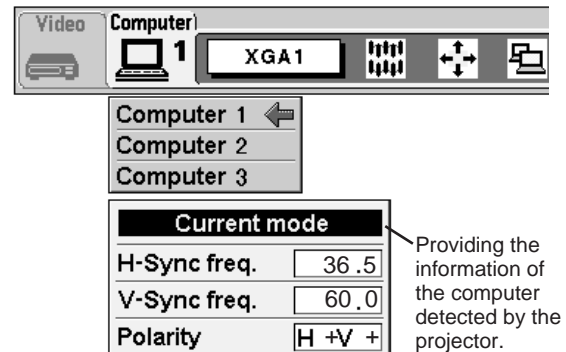
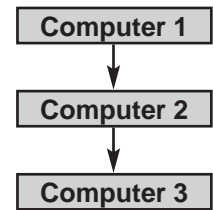

CURRENT MODE DISPLAY

When selecting the "Computer 1," "Computer 2," or "Computer 3" Mode, the Current Mode display appears. It shows the information of the computer of the mode selected.

SELECTING COMPUTER SYSTEM

Automatic Multiscanning system

This projector automatically adapt to most different types of computer based on VGA, SVGA or XGA (refer to "COMPATIBLE COMPUTER SPECIFICATION" on page 28). When selecting "Computer 1," "Computer 2," or "Computer 3", this projector become automatically suited to the incoming signal and projectors the proper image without any special setting. (Setting of the Computer System may be required when connecting some computers.)

Note : The projector may provides the messages below.

Go PC adj. The projector cannot discriminate or detect the input signal from the computer. Adjust and set the computer system manually. (Refer to PC ADJUSTMENT on page 28.)

No signal There is no signal from the computer on the any terminal (the Rear Terminal or the Front Terminal). Make sure the connection of the computer and the projector is set correctly. (Refer to TROUBLESHOOTING on page 43.)

Selecting Computer System Manually

To set the Computer system manually, select the Mode from the COMPUTER SYSTEM Menu on the ON-SCREEN MENU.

- 1 Press the MENU button and the ON-SCREEN MENU will appear. Press the POINT LEFT/RIGHT buttons to select SYSTEM and press the SELECT (REAR CLICK) button. Another dialog box COMPUTER MODE Menu will appear. (The COMPUTER MODE Menu also appears by pressing the SYSTEM button on the Front Control or the Remote Control Units.)
- 2 Press the POINT DOWN button and a red-arrow icon will appear. Move the arrow to the system that you want to set, and then press SELECT (REAR CLICK) button.

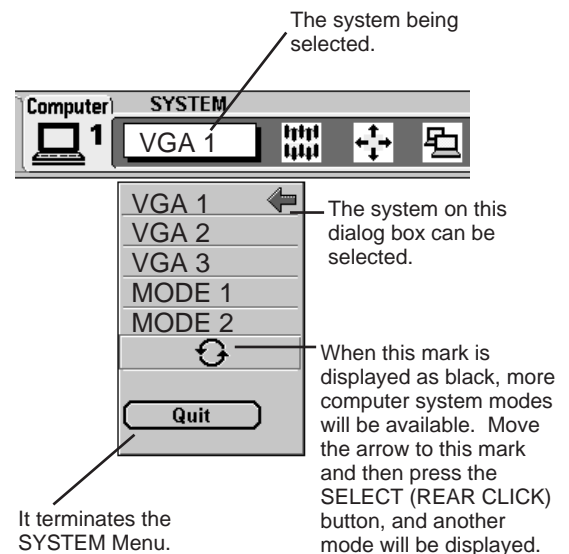
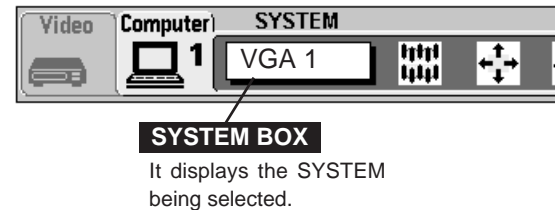

PC ADJUSTMENT

This Projector can automatically detect display signals from most personal computers currently distributed. However, some computers employ special signal formats which are different from the standard ones and may not be detected by this projector. If this happens, the projector cannot reproduce a proper image and the image is recognized as a flickering picture, a non-synchronized picture, a non-centered picture or a skewed picture.

This projector has PC ADJUSTMENT function, to enable you to precisely adjust several parameters to match with the input signal format. The projector has eight independent memory areas where you can store the parameter you have set. This enables you to recall the setting for a specific computer whenever you need it.

1 Press the MENU button and the ON-SCREEN MENU will appear. Press the POINT LEFT/RIGHT buttons to select PC ADJUST  and press the SELECT (REAR CLICK) button. Another dialog box "Where to reserve" Menu will appear.

2 In this dialog box, you can store the parameter into the area from "Mode 1" to "Mode 8." When memorizing the new computer parameter, select the Mode with the message of "Free" by pressing the POINT UP/DOWN buttons and SELECT button. To change the parameters of the Mode previously set, select the Mode with "Stored."

3 When the Mode is selected, Parameter adjustment dialog box appears. Adjust the each item to match with your computer.

Total lines The number of the total vertical lines. Adjust the number to match your PC image.

Total dots The number of the total dots in one horizontal period. Adjust the number to match your PC image.

Horizontal Adjustment of the horizontal picture position. When the image is not centered on the screen, adjust this item.

Vertical Adjustment of the vertical picture position. When the image is not centered on the screen, adjust this item.

Clamp Adjustment of the clamp level. When the image has a dark bar(s), try this adjustment.

Height Adjusting the vertical height of the picture image.

Width Adjusting the horizontal width of the picture image.

4 When the parameter data adjustment finishes to be set, select "Stored" and press the SELECT (REAR CLICK) button. "OK?" dialog box is displayed for confirmation.

5 To select the Mode manually adjusted in PC ADJUSTMENT Menu, select the mode at the SYSTEM SELECT Menu. (Refer to page 27.)

Reset It recall the parameter data that previously adjusted.

Mode free It clear the parameter data previously set the selected Mode.

Stored It stores the parameters in the memory.

Quit It terminates the PC ADJUST Menu.

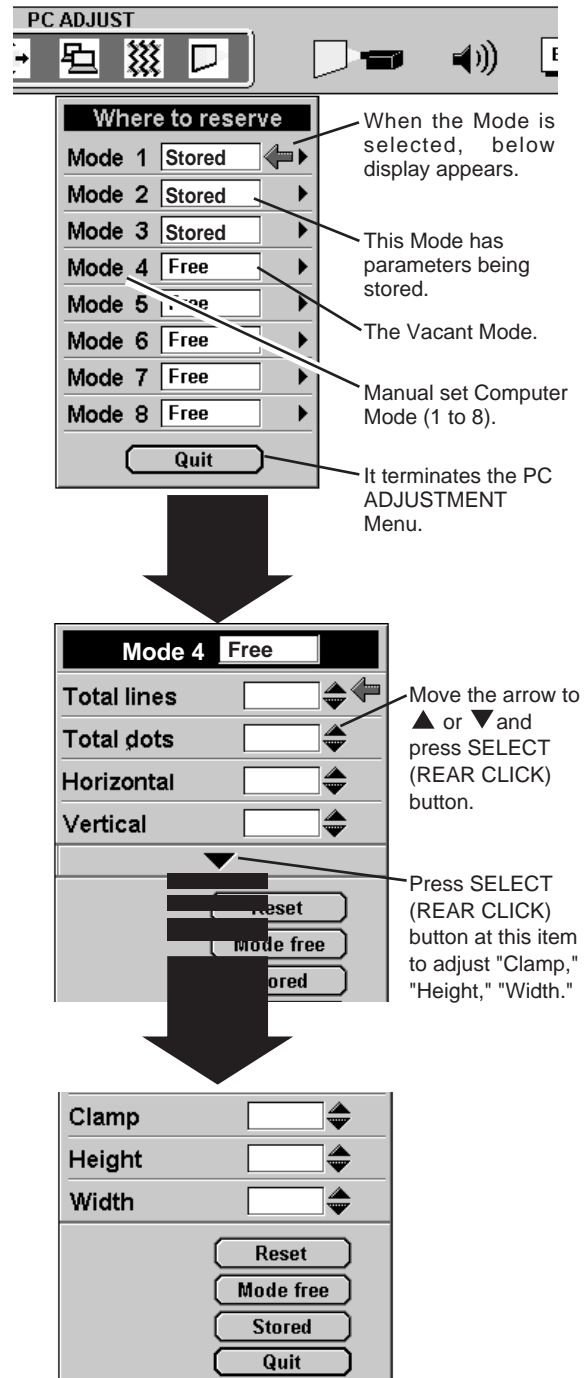

COMPATIBLE COMPUTER SPECIFICATIONS

Basically this projector can accept the signal from all computers with the V, H-Frequency below mentioned and less than 135 MHz of Dot Clock.

ON-SCREEN DISPLAY	RESOLUTION	H-Freq. (kHz)	V-Freq. (Hz)	ON-SCREEN DISPLAY	RESOLUTION	H-Freq. (kHz)	V-Freq. (Hz)
VGA 1	640 × 480	31.47	59.88	XGA 6	1024 × 768	48.50	60.02
VGA 2	720 × 400	31.47	70.09	XGA 7	1024 × 768	44.00	54.58
VGA 3	640 × 400	31.47	70.09	XGA 8	1024 × 768	63.48	79.35
VGA 4	640 × 480	37.86	74.38	XGA 9	1024 × 768 (Interlace)	36.00	87.17
VGA 5	640 × 480	37.86	72.81	XGA 10	1024 × 768	62.04	77.07
VGA 6	640 × 480	37.50	75.00	XGA 11	1024 × 768	61.00	75.70
MAC LC13	640 × 480	34.97	66.60	XGA 12	1024 × 768 (Interlace)	35.522	43.48
MAC 13	640 × 480	35.00	66.67	XGA 13	1024 × 768	46.90	58.20
MAC1 6	832 × 624	49.72	74.55	XGA 14	1024 × 768	47.00	58.30
MAC 19	1024 × 768	60.24	75.08	XGA15	1024 × 768	58.20	72.2
MAC21	1152 × 870	68.68	75.06	SXGA 1	1152 × 864	64.20	70.40
MAC	1280 × 960	75.00	75.08	SXGA 2	1280 × 1024	62.50	58.60
MAC	1280 × 1024	80.00	75.08	SXGA 3	1280 × 1024	63.90	60.00
SVGA 1	800 × 600	35.156	56.25	SXGA 4	1280 × 1024	63.34	59.98
SVGA 2	800 × 600	37.88	60.32	SXGA 5	1280 × 1024	63.74	60.01
SVGA 3	800 × 600	46.875	75.00	SXGA 6	1280 × 1024	71.69	67.19
SVGA 4	800 × 600	53.674	85.06	SXGA 7	1280 × 1024	81.13	76.107
SVGA 5	800 × 600	48.08	72.19	SXGA 8	1280 × 1024	63.98	60.02
SVGA 6	800 × 600	37.90	61.03	SXGA 9	1280 × 1024	79.976	75.025
SVGA 7	800 × 600	34.50	55.38	SXGA 10	1280 × 960	60.00	60.00
SVGA 8	800 × 600	38.00	60.51	SXGA 11	1152 × 900	61.20	65.20
SVGA 9	800 × 600	38.60	60.31	SXGA 12	1152 × 900	71.40	75.60
SVGA 10	800 × 600	47.90	71.92	SXGA 13	1280 × 1024 (Interlace)	50.00	43.00
SVGA 11	800 × 600	32.70	51.09	SXGA 14	1280 × 1024 (Interlace)	50.00	47.00
SVGA 12	800 × 600	38.00	60.51	SXGA 15	1280 × 1024	63.37	60.01
XGA 1	1024 × 768	48.36	60.00	SXGA 16	1280 × 1024	76.97	72.00
XGA 2	1024 × 768	68.677	84.997	SXGA 17	1152 × 900	61.85	66.00
XGA 3	1024 × 768	60.023	75.03	SXGA 18	1280 × 1024 (Interlace)	46.43	43.35
XGA 4	1024 × 768	56.47	70.07	SXGA 19	1280 × 1024	63.79	60.18
XGA 5	1024 × 768	60.31	74.92				

NOTE : Specifications are subject to change without notice.

PICTURE IMAGE ADJUSTMENT

Adjust Picture Image Manually

- 1 Press the MENU button and the ON-SCREEN MENU will appear. Press the POINT LEFT/RIGHT buttons to select IMAGE  and press the SELECT (REAR CLICK) button. Another dialog box PICTURE IMAGE ADJUSTMENT Menu will appear.
- 2 Press the POINT DOWN button and a red-arrow icon will appear. Move the arrow to ▲ or ▼ of the item that you want to change by pressing the POINT UP/DOWN buttons. To increase the value, point the arrow to ▲ and then press the SELECT (REAR CLICK) button. To decrease the value point the arrow to ▼ and then press the SELECT (REAR CLICK) button.

Fine sync Adjust the picture as necessary to eliminate flicker from the display. (From 0 to 127.) This item can be adjusted by pressing the FINE SYNC. button on the Front Control or the Remote Control Units.

Total Dots The number of the total dots in one horizontal period. Adjust the number to match your PC image.

Contrast Point to ▼ to adjust the image lighter, and select ▲ to adjust the image deeper. (From 0 to 63.)

Brightness Point to ▼ to adjust the image darker, and select ▲ to adjust the image brighter. (From 0 to 63.)

- Reset** It recalls the data previously adjusted.
- Stored** It stores the adjusted data in the memory.
- Quit** It terminates the PICTURE IMAGE ADJUSTMENT Menu.

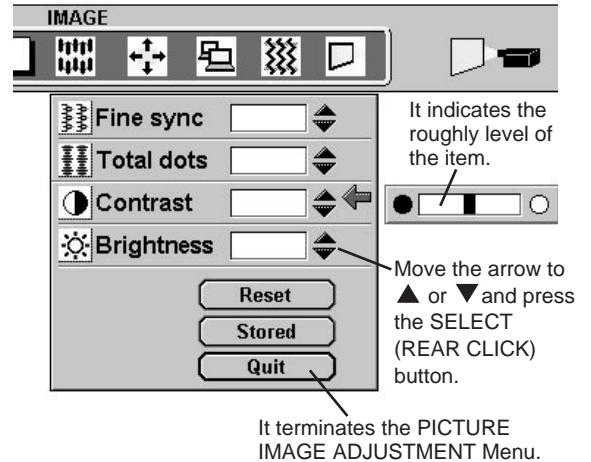

Auto Image Function

The Auto Image function is provided to automatically adjust Fine sync., Total dots, and Picture Position for most computers.

- 1 Press the MENU button and the ON-SCREEN MENU will appear. Press the POINT LEFT/RIGHT buttons to select AUTO IMAGE  and press the SELECT (REAR CLICK) button. Another dialog box AUTO IMAGE Menu will appear.
- 2 Move the arrow to an item that you want to adjust by pressing the POINT UP/DOWN button. Change the setting On or Off by pressing the SELECT button.

Fine sync Adjust the picture as necessary to eliminate flicker from the display. This item can be adjusted manually. (Refer to page 30.)

Total Dots The number of the total dots in one horizontal period. This item can be adjusted manually. (Refer to page 30.)

Position Adjustment of the position of the image. This item can be adjusted manually. (Refer to page 32.)

- 3 Move the arrow to "Go!" and press the SELECT (REAR CLICK) button to start the Auto Image function.

NOTE : The Fine sync., Total dots, and Picture Position of some computers may not be fully adjusted with the Auto Image Function. In that case, manually adjustments is required to make fine image. (Refer to PICTURE IMAGE ADJUSTMENT on page 30 to adjust "Fine sync." or "Total dots" and PICTURE POSITION ADJUSTMENT on page 32 to adjust Picture Position.

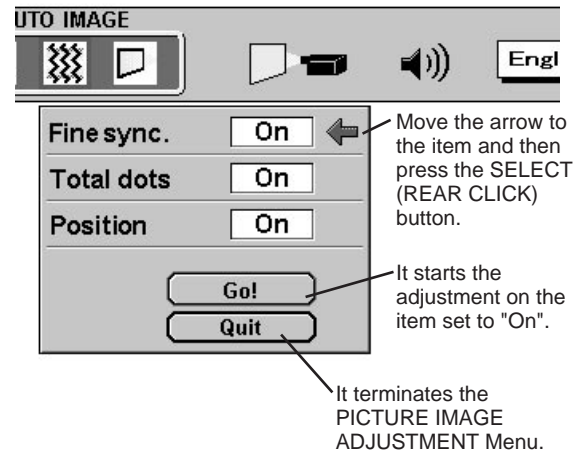

Normal Function

The normal picture level is preset on this projector by the factory and can be restored anytime by pressing the NORMAL button (located on the Front Control or on the Remote Control Units). The "Normal" display will be displayed on the screen for a few seconds.

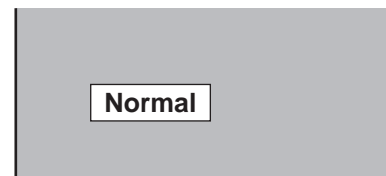

PICTURE POSITION ADJUSTMENT

The position of the image can be adjusted vertically and horizontally through PICTURE POSITION ADJUSTMENT.

- 1 Press the MENU button and the ON-SCREEN MENU will appear. Press the POINT LEFT/RIGHT buttons to select POSITION  and press the SELECT (REAR CLICK) button. Another dialog box PICTURE POSITION Menu will appear.
- 2 Move the arrow to the direction (described as ←, →, ↑, or ↓) that you want to adjust by pressing the POINT UP/DOWN buttons, and then press the SELECT (REAR CLICK) button.

- Reset** It recalls the setting data previously set.
- Stored** It stores the setting data in the memory.
- Quit** It terminates the PICTURE POSITION Menu.

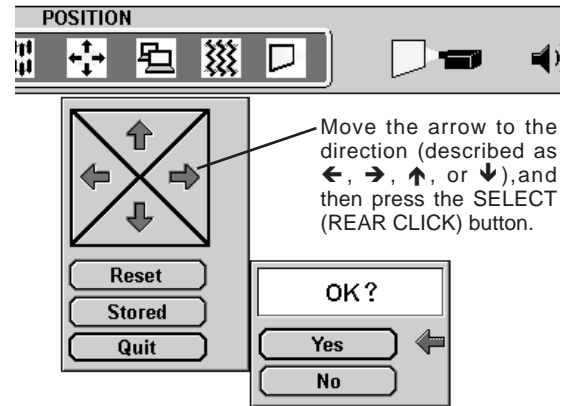

PICTURE SCREEN ADJUSTMENT



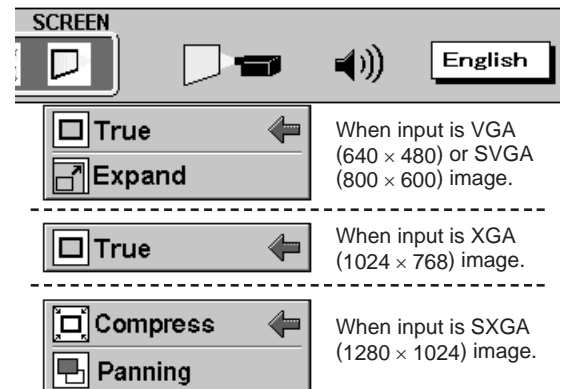

This projector has a picture screen resize function, which enables you to display the image in desirable size.

- 1 Press the MENU button and the ON-SCREEN MENU will appear. Press the POINT LEFT/RIGHT buttons to select SCREEN  and press the SELECT (REAR CLICK) button. Another dialog box PICTURE SCREEN Menu will appear.
- 2 Move the arrow to a screen size that you want to set by pressing the POINT UP/DOWN buttons, and then press the SELECT (REAR CLICK) button.

- True** It set the image size to its original size. This function is available for VGA, SVGA, or XGA size.
- Expand** It expands the image in VGA (640 × 480) or SVGA (1024 × 768) to the screen size (1024 × 768).
- Compressed** It compresses the image in SXGA (1280 × 1024) to the screen size (1024 × 768).
- Panning** It resize the image in SXGA to its original size (1280 × 1024) and the image can be moved by pressing the POINT UP/DOWN/LEFT/RIGHT buttons. (The image moves only vertically or horizontally).

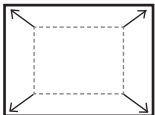

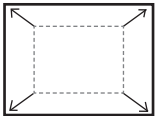
The chart of the image size resized in the SCREEN Menu.

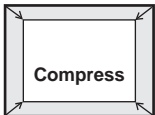
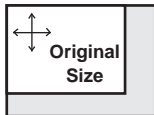
On-Screen Menu Computer	True Mode	Expand Mode	Compress Mode	Panning Mode
VGA image (600 × 480)		 Expand		
SVGA image (800 × 600)		 Expand		
XGA image (1024 × 768)				
SXGA image (1280 × 1024)			 Compress	

Note to the "Panning" Mode

When "Panning" of the PICTURE SCREEN Menu is selected, the display of "Quit" is appearing on the screen.

Press the POINT buttons to move the image vertically or horizontally.

When pressing the SELECT button, the "Panning" mode is terminated and the ON-SCREEN Menu appears. To resize the picture image, select SCREEN  again.

When pressing any key except the POINT buttons or the SELECT button, the "Panning" mode is terminated and the projector starts to work the function of the button you pressed. To resize the picture image, select SCREEN  again.

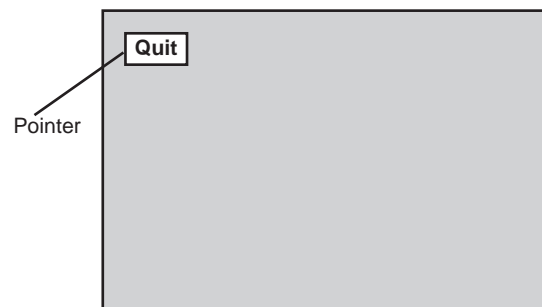

The display of the image in the Panning Mode.

The normal "Panning Operation" may not function properly if the computer system prepared with the "PC Adjust" is used.

VIDEO MODE

SELECTING VIDEO MODE

Direct Operation

Press the MODE button on the Front Control or the VIDEO button on the Remote Control Units. Select the Mode among Video 1 to Video 3 corresponding with the input source. The display of "Video 1," "Video 2," "Video 3," "Computer 1," "Computer 2," or "Computer 3" appears on the screen for a few second. (The "Video 1," "Video 2," or "Video 3" appears when pressing the VIDEO button.)

- Video 1** Displaying the image from "Video 1" on the Rear Terminal.
- Video 2** Displaying the image from "Video 2" on the Rear Terminal.
- Video 3** Displaying the image from "Video 3" on the Front Terminal.

MODE button

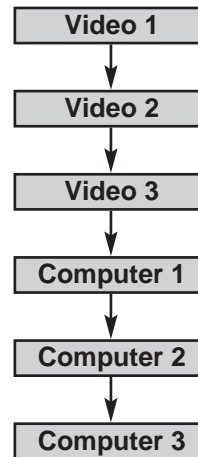

VIDEO button

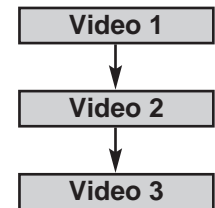

Menu Operation

- 1** Press the MENU button and the ON-SCREEN MENU will appear. Press the POINT LEFT/RIGHT buttons to select Video  and press the SELECT (REAR CLICK) button. Another dialog box VIDEO MODE Menu will appear.
- 2** Press the POINT DOWN button and a red-arrow icon will appear. Move the arrow to the mode among Video1 to Video3 that you want to select, and then press the SELECT (REAR CLICK) button.

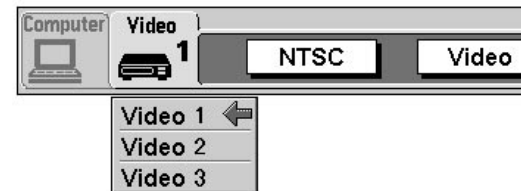

SELECTING COLOR SYSTEM

- 1 Press the MENU button and the ON-SCREEN MENU will appear. Press the POINT LEFT/RIGHT buttons to select SYSTEM and press the SELECT (REAR CLICK) button. Another dialog box VIDEO SYSTEM Menu will appear. (The display also appears by pressing the SYSTEM button on the Front Control or the Remote Control Units.)
- 2 Press the POINT DOWN button and a red-arrow icon will appear. Move the arrow to "Auto", and then press the SELECT (REAR CLICK) button.

Auto

The projector automatically detects the incoming Video system, and adjusts itself to optimize its performance.

When the Video System is PAL-M or PAL-N, select the system manually.

PAL / SECAM / NTSC / NTSC4.43 / PAL-M / PAL-N

If the projector cannot reproduce the proper video image, it is required to select a specific broadcast signal format among PAL, SECAM, NTSC, NTSC 4.43, PAL-M, or PAL-N.

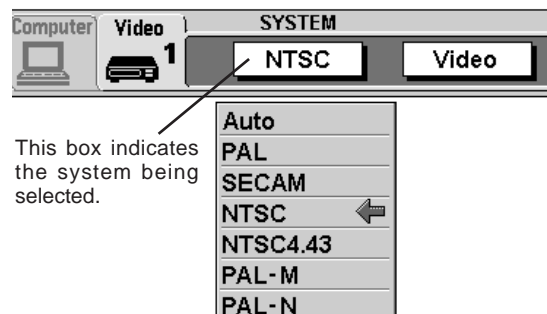

SELECTING VIDEO SOURCE

This projector can detect the signal from the video equipment with component video signal, like DVD player. When connecting to those equipment, select the type of Video source in VIDEO SOURCE Menu.

- 1 Press the MENU button and the ON-SCREEN MENU will appear. Press the POINT LEFT/RIGHT buttons to select VIDEO SOURCE and press the SELECT (REAR CLICK) button. Another dialog box VIDEO SOURCE Menu will appear.
- 2 Press the POINT DOWN button and a red-arrow icon will appear. Move the arrow to the system that you want to select, and then press the SELECT (REAR CLICK) button.

Video When the video source is from VIDEO, S-VIDEO, or BNC terminal, select "Video" in VIDEO SOURCE Menu.

Y, C When connecting the video equipment through VIDEO-Y and VIDEO-C terminals to the projector, select "Y, C" in VIDEO SOURCE Menu.

Y, Cb,, Cr When connecting the video equipment on VIDEO-Y, VIDEO-Cb, and VIDEO-Cr terminals to the projector, select "Y, Cb, Cr" in VIDEO SOURCE Menu.

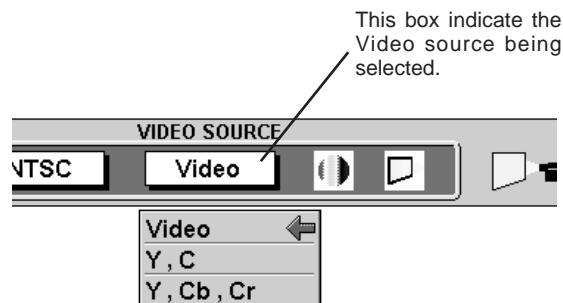

PICTURE IMAGE ADJUSTMENT

Adjusting the Picture Image

- 1 Press the MENU button and the ON-SCREEN MENU will appear. Press the POINT LEFT/RIGHT buttons to select IMAGE  and press the SELECT (REAR CLICK) button. Another dialog box PICTURE IMAGE ADJUSTMENT Menu will appear.
- 2 Press the POINT DOWN button and a red-arrow icon will appear. Move the arrow to ▲ or ▼ of the item that you want to change by pressing the POINT UP/DOWN buttons. To increase the value, point the arrow to ▲ and then press the SELECT (REAR CLICK) button. To decrease the value point the arrow to ▼ and then press the SELECT (REAR CLICK) button.

- Color** Point to ▼ to adjust the image lighter, and select ▲ to adjust the image deeper. (From 0 to 63.)
- Tint** Point to ▼ to adjust the color more purple, and select ▲ to adjust more green. (From 0 to 63.)
- Contrast** Point to ▼ to adjust the image lighter, and select ▲ to adjust the image deeper. (From 0 to 63.)
- Brightness** Point to ▼ to adjust the image darker, and select ▲ to adjust the image brighter. (From 0 to 63.)
- sharpness** Point to ▼ to adjust the image softer, and select ▲ to adjust the image sharper. (From 0 to 63.)

- Reset** It recalls the data previously adjusted.
- Stored** It stores the data in the memory.
- Quit** It terminates the PICTURE IMAGE ADJUSTMENT Menu.

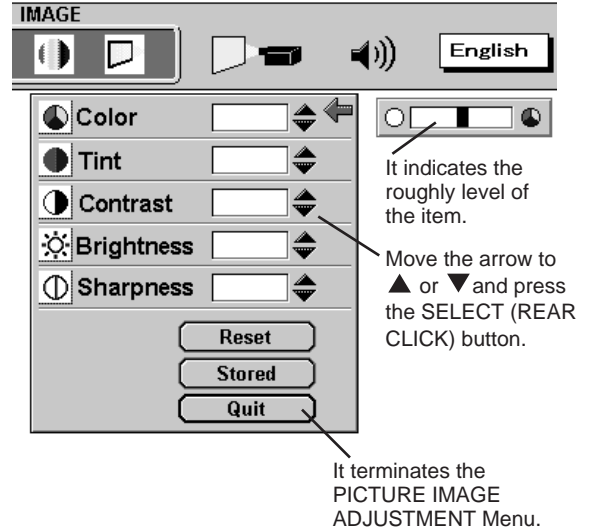

Normal Function

The normal picture level is preset on this projector by the factory and can be restored anytime by pressing the NORMAL button (located on the Front Control or on the Remote Control). The "Normal" display will be displayed on the screen for a few seconds.

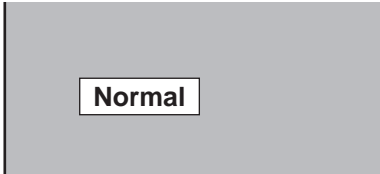

PICTURE SCREEN ADJUSTMENT

This projector has a picture screen resize function, which enables you to display the image in desirable size.

- 1 Press the MENU button and the ON-SCREEN MENU will appear. Press the POINT LEFT/RIGHT buttons to select SCREEN  and press the SELECT (REAR CLICK) button. Another dialog box PICTURE SCREEN ADJUSTMENT DISPLAY will appear.
- 2 Press the POINT DOWN button and a red-arrow icon will appear. Move the arrow to the screen size that you want to set, and then press the SELECT (REAR CLICK) button.

Regular Normal Video Image size with 4 × 3 aspect ratio.

Wide It compresses the image vertically to Wider Video Image size with 16 × 9 aspect ratio.

Extend It extends the image horizontally to Wider Video Image size.

Zoom It adjust the Wider Video image (16:9) to Normal Video image (4:3) by zooming in the center of it.

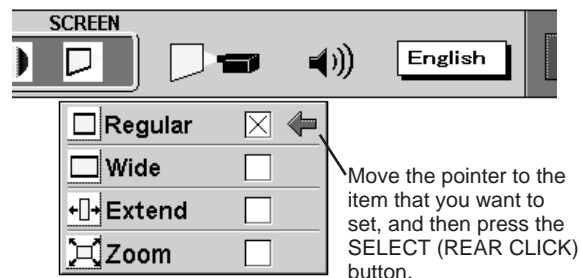

SETTING MENU

- 1 Press the MENU button and the ON-SCREEN MENU will appear. Press the POINT LEFT/RIGHT buttons to select SETTING  and press the SELECT (REAR CLICK) button. Another dialog box SETTING Menu will appear.
- 2 Press the POINT DOWN button and a red-arrow icon will appear. Move the arrow to the item that you want to set, and then press the SELECT (REAR CLICK) button to set it "On" or "Off".

Blue back When this function is in the "On" position, this projector will produce a blue image without video noise on the screen when the video source is unplugged or turned off.

Display When this function is in the "On" position, the On-Screen Displays always appear when adjustments are made. (The following displays disappear by switching this function "Off.")

Preparation Display
(The Number-counting down Display)
Mode Display
Volume Display
Mute Display
Normal Display

Lamp age The Lamp age function is designed to reset the lamp replacement monitor timer. When replacing the lamp, reset the lamp replacement monitor timer by using this function.

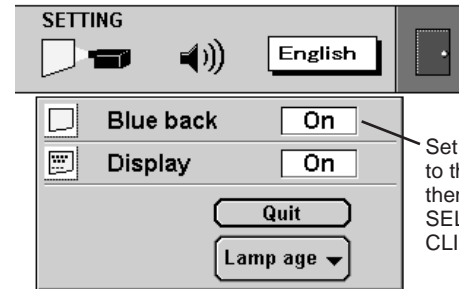

Set the Pointer to the item, and then press the SELECT (REAR CLICK) button.

SETTING LANGUAGE

The language used in the ON-SCREEN MENU is selectable from among English, German, French, Italian, Spanish and Japanese.

- 1 Press the MENU button and the ON-SCREEN MENU will appear. Press POINT LEFT/RIGHT buttons to select LANGUAGE  and press the SELECT (REAR CLICK) button. Another dialog box LANGUAGE Menu will appear.
- 2 Press the POINT DOWN button and a red-arrow icon will appear. Move the arrow to the language that you want to set, and then press the SELECT (REAR CLICK) button.



Move the Pointer to the language that you want to set, and then press the SELECT (REAR CLICK) button.

OPERATING WIRELESS MOUSE

The Wireless Remote Control Unit is not only able to operate the projector but also usable as a wireless mouse for a PC. One Pointing Pad (POINT button) and two click buttons are used for wireless mouse operation. Wireless mouse is usable when PC mouse pointer is displayed on the screen. When the menu or indicator of the projector is displayed on the screen instead of the PC mouse pointer, the wireless mouse cannot be used.

installation

To use the Wireless Remote Control Unit as the Wireless Mouse for a PC, installation of the mouse driver (not supplied) is required. Make sure that the mouse driver is properly installed in your computer. And make sure that the mouse port of the computer connected to Control Port is activated.

- 1 Connect the mouse port of your computer to the Control Port of the projector with the Mouse Cable. (Refer to page 14 and 15 for connection.)
- 2 Turn the projector on first, and then turn on your computer. When the computer is switched on first, the Wireless Mouse may not work properly.

Note : When the computer has no mouse port, connect the Serial Port of the computer to Control Port of the projector with the Mouse Cable for Serial Port.

Controlling Wireless Mouse

When controlling the pointer of the computer, operate the Wireless Mouse with POINT button, SELECT button, and FRONT CLICK button on the Wireless Remote Control Unit.

POINT button

Used to move the pointer. The pointer is moved according to the direction you are pressing.

SELECT (REAR CLICK) button

This button has the same function as the left button in a PC mouse.

FRONT CLICK

This button has the same function as the right button in a PC mouse. Pressing this button does not affect any operation when in Menu mode.

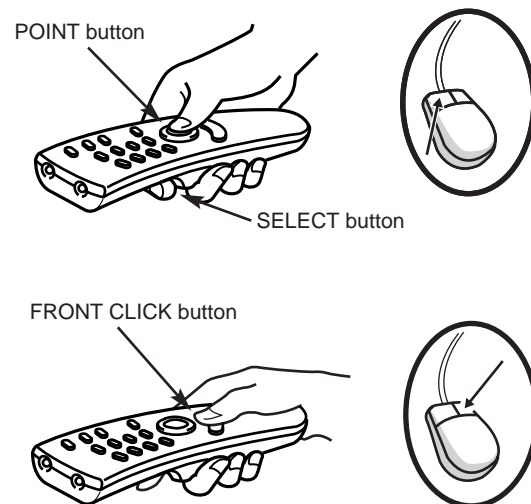

MOUSE/KEYBOARD CONNECTION

This projector equips the Mouse/Keyboard Cables in the Storage Cabinet (left side), and the Mouse/Keyboard Terminals on the Front Terminal. Connecting these cables and terminals enable you to control the computer easily.

Connecting Mouse/Keyboard to the Projector

- 1 Connect the Mouse/Keyboard Cable(s) in the Storage Cabinet (left side) to your computer as the figure below. Be sure to connect the cable(s) corresponding with your computer.
- 2 Connect a Mouse or a Keyboard to the Mouse/Keyboard Terminal on the Front Terminal. Be sure to connect to the terminal corresponding with the input device.
- 3 Connect the computer to the COMPUTER IN 1 terminal(s). Refer to page 14 and 15 for the connection.
- 4 When the steps 1, 2, and 3 are finished, switch the projector on before turning the computer on.

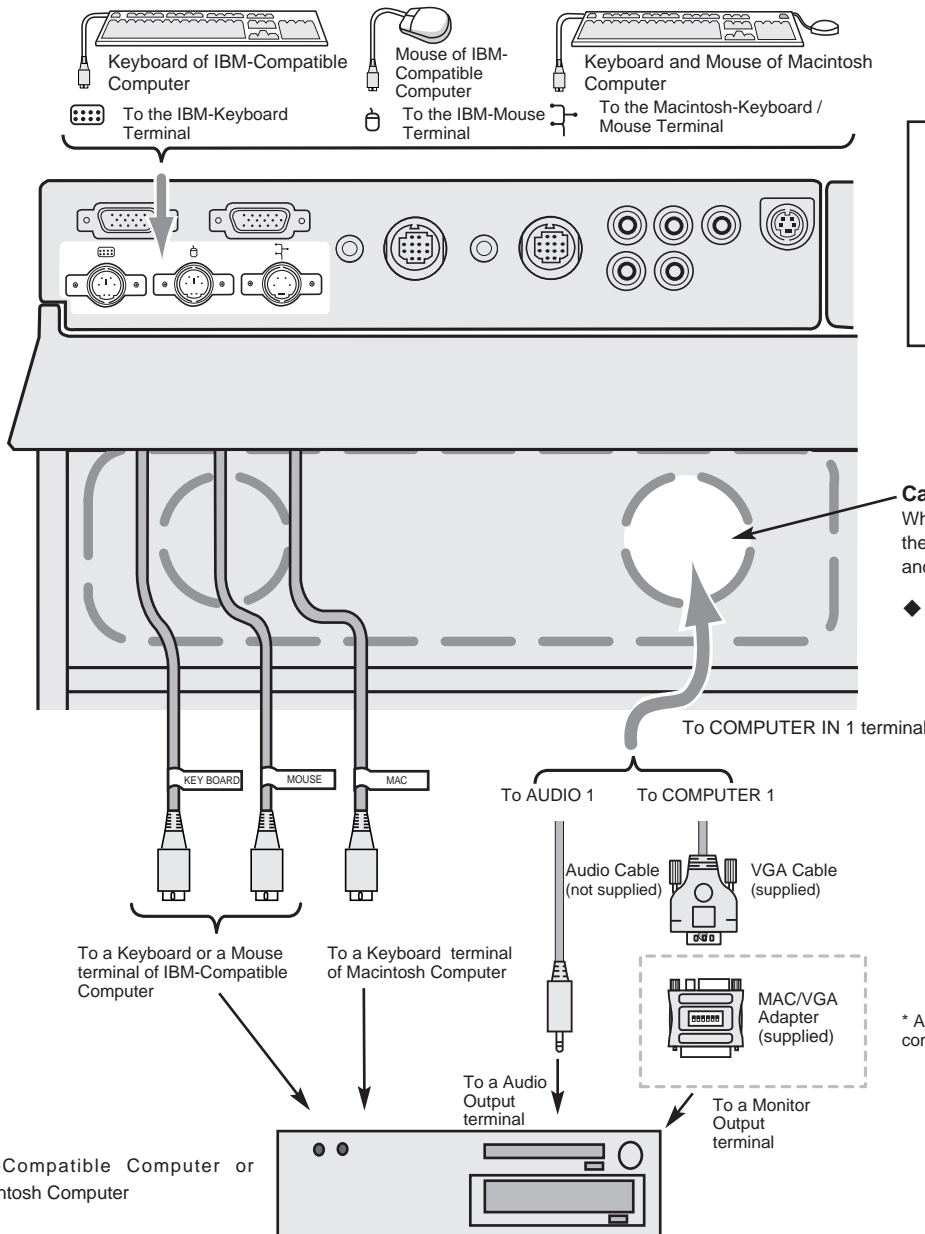

Caution
 Be sure to connect the Mouse/Keyboard Cables corresponding with your computer. And be sure to connect to the Mouse/Keyboard Terminals corresponding with your input devices.

Cable Slot
 When Connecting the computer to the Rear Terminal, cut Cable Slot(s) and run through the cables.
 ◆ Refer to page 14 and 15 for connecting the computer to the projector.

* Adapter is used for Macintosh computer. Refer to the page 15.

MAINTENANCE

TEMPERATURE WARNING INDICATOR

The TEMPERATURE WARNING Indicator flashes red when the internal temperature of the projector exceeds the normal temperature. The Indicator stops to flash when the temperature of the projector become normal.

When the TEMPERATURE WARNING Indicator continues to flash, make sure the matters below.

- 1 The Ventilation slots of the projector are blocked. In such an event, reposition the appliance so that the ventilation slots are not obstructed.
- 2 Air filter is clogged with dust particles. Remove dust from the air filter by following instruction in the AIR FILTER CARE AND CLEANING section below.
- 3 If the TEMPERATURE WARNING Indicator remains on after performing the above checks, the Cooling Fans or the Internal Circuits may be malfunctioning. Request service from an authorized dealer or service station.

AIR FILTER CARE AND CLEANING

The Removable Air Filters prevent dust from accumulating on the surface of the Projection Lens and the Projection Mirror. Should the Air Filters become clogged with dust particles, they will reduce the Cooling Fans' effectiveness and may result in internal heat build up and effect on the life of the projector.

To clean the Air Filters, follow the cleaning procedures below:

- 1 Turn the power ON/OFF button to the OFF, and make sure the Cooling Fans stop to cooling. And then, switch the MAIN ON/OFF switch off and unplug the projector. Wait for 45 minutes that the projector become enough cool.
- 2 Remove the Air Filter Covers. (There are 2 Air Filters on this projector.)
 - 1 : Remove the Speaker Cover on the right side of the projector and remove the Air Filter Cover.
 - 2 : Remove the Center Panel and remove the Air Filter Cover of the Projector.
- 3 Remove the Air Filters from the Air Filter Covers, and clean the Air Filters with a vacuum cleaner.
- 4 Replace the Air Filters. Make sure that the Air Filter Covers are fully inserted.
- 5 Replace the Center Panel to the projector. Be sure to meet the Center Panel and the projector at the upper part first, and set the Center Panel securely.

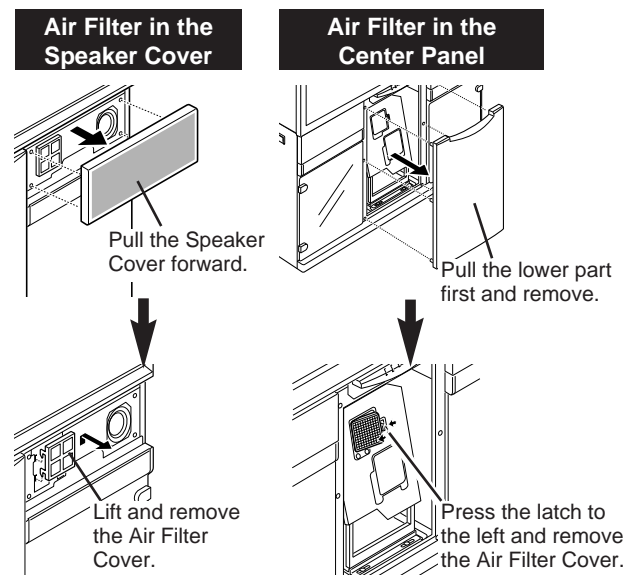

CAUTION

Do not operate the projector with the Air Filter removed. The dust is stuck on the LCD Panel and the Mirror, and it may spoil the fine picture image.

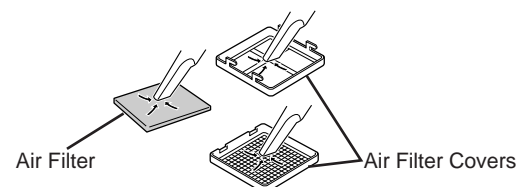

LAMP REPLACEMENT Indicator

When the Lamp of this projector draws to an end, the LAMP REPLACEMENT indicator lights yellow. When the image become dark or the color of the image become unnatural, replacement of the Lamp is required.

Lamp Replacement



CAUTION

- For continued safety, replace with a lamp assembly of the same type.
- Allow the projector to cool for at least 45 minutes before you open the lamp cover. The inside of the projector can become very hot.
- Do not drop the lamp module or touch the glass bulb! The glass can shatter and may cause injury.

Follow these steps to replace the lamp assembly.

- 1** Turn off the projector and disconnect the AC plug. Allow the projector to cool for at least 45 minutes.
- 2** Remove the Center Panel of the projector. Pull the lower part first and remove the Panel.
- 3** Remove a screw with a screwdriver and remove the Lamp Cover.
- 4** Remove 2 screws with a screwdriver and pull out the Lamp Assembly by grasping the handle.
- 5** Replace the Lamp Assembly and tighten 2 screws. Make sure that the Lamp Assembly is set properly.
- 6** Replace the Lamp Cover and tighten a screws, and replace the Center Panel.
NOTE : Be sure to meet the Center Panel and the projector at the upper part first, and set the Center Panel securely.
- 7** Connect the AC Power Cord to the projector and turn the projector on.
- 8** Reset the Lamp Replacement Monitor Timer (refer to the section "Lamp Replacement Monitor Timer" below.)

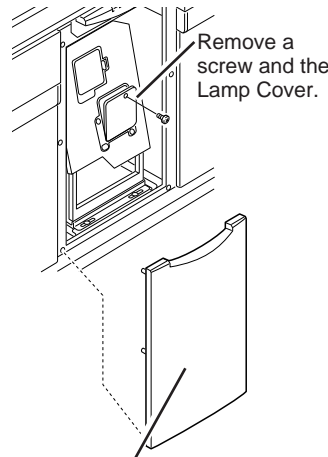

Remove a screw and the Lamp Cover.

Pull the lower part first and remove.

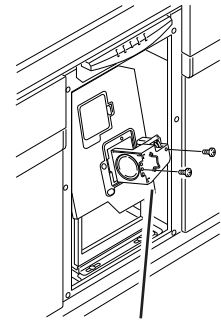

Remove 2 screws and the Lamp Assembly by grasping the handle.

CAUTION
Do not drop the screw inside of the cabinet.

Lamp Replacement Monitor Timer

Be sure to reset the Lamp Replacement Monitor Timer when the Lamp Assembly is replaced. When the Lamp Replacement Monitor Timer is reset, the LAMP REPLACEMENT indicator stops to lighting.

- 1** Turn the projector on, and press the MENU button and the ON-SCREEN MENU will appear. Press the POINT LEFT/RIGHT buttons to select SETTING  and press the SELECT (REAR CLICK) button (refer to the page 38). Another dialog box SETTING MENU Menu will appear.
- 2** Press the POINT DOWN button and a red-arrow icon will appear. Move the arrow to Lamp age, and then press the SELECT (REAR CLICK) button. The message of "Lamp replace monitor Reset?" is displayed.
- 3** Select [Yes] to reset the Timer.

Do not reset the Lamp Replacement Monitor Timer, except after the lamp is replaced.

TROUBLESHOOTING

Before calling your dealer or service station for assistance, check the matters below once again.

1. Make sure you have connected the projector to your equipment as described in section "CONNECTING THE PROJECTOR" on pages 12 ~ 17.
2. Check cable connection. Verify that all computer, video and power cord are properly connected.
3. Verify that all power is switched on.
4. If the projector still does not produce the image, re-start the computer.
5. If the image still does not appear, unplug the projector from the computer and check the computer monitor's display. The problem may be with your graphics controller rather than with the projector. (When you reconnect the projector, remember to turn the computer and monitor off before you power up the projector. Power the equipment back in order of : Projector and computer.)
6. If the problem still exists, check with following chart.

Problem:	Try these Solution
No power.	<ul style="list-style-type: none"> ● Plug the projector into the AC outlet. ● Press the MAIN POWER ON/OFF switch to ON position. ● Be sure READY Indicator light is On. ● Wait one minute after the projector is turned OFF before turning the projector back on. <p>NOTE : After pressing the MAIN POWER ON/OFF switch to OFF, make sure the projector works as follow.</p> <ol style="list-style-type: none"> 1. The LAMP indicator will light and the READY indicator will turn off. 2. after one minute, the READY indicator will light green again and the projector may be turned on by pressing the power ON/OFF button. <ul style="list-style-type: none"> ● Check the TEMPERATURE WARNING indicator. If the indicator flashes red, the projector cannot be turned on. (See "TURNING ON/OFF THE PROJECTOR" section on page 24.) ● Check the Projection Lamp. (Refer to the page 42.)
No image.	<ul style="list-style-type: none"> ● Check the connection between the computer or video equipment and the projector. ● When turning the projector on, it is about 30 seconds to display the image. ● Check the system that you select is corresponding with the computer or the video equipment. ● Make sure the temperature is not out of the Operating Temperature (5° ~ 35°).
No sound.	<ul style="list-style-type: none"> ● Check audio cable connection from audio input source. ● Adjust the audio source. ● Press VOLUME (+) button. ● Press MUTE button.
Remote Control Units dose not work.	<ul style="list-style-type: none"> ● Check the batteries. ● Make sure anything is blocking between the Remote Receiver and the Remote Control Units. ● Make sure you are not too far from the projector when using the Remote Control Units. Maximum operating range is 16.4 feet (5m).
Wireless Mouse function does not work.	<ul style="list-style-type: none"> ● Check the cable connection between the projector and the computer. ● Check the mouse setting on your computer. ● Turn the projector before your turn on the computer.

WARNING : High voltages are used to operate this projector. Do not attempt to open the cabinet.

Sanyo Service is easily obtained. If after following all operating instructions, you find that service is necessary, contact the SFS Corporation in Los Angeles, or the store where you purchased the unit. Give the model number and explain the difficulty. We will advise you how to obtain service.

SPECIFICATIONS

Rear-Projection Display

Type of Projector	LCD Rear-Projection Display
LCD Panel System	1.3" TFT Active Matrix type × 3
Panel Resolution	1,024 × 768 dots
Number of Pixels	2,359,296 (786,432 {1,024 × 768} × 3)
Horizontal Resolution	800 TV lines
Projection Lens	F = 2.5 / f = 23.7 mm
Projection Lamp	UHP, 120watt type
Projection Image Size	70" (4 : 3)
Scanning Frequency	~80kHz (H-sync.), ~100Hz (V-sync.)
Color System	6 color system (PAL, SECAM, NTSC, NTSC 4.43, PAL-M, and PAL-N)
Computer System	SXGA / XGA / SVGA / VGA / MAC
Terminals (Computer)	Computer Input Jack : HDB-15 Terminal (VGA) × 3 Audio Input Jack : Mini Jack (stereo) × 3 Control Port Jack : Multi-pole 12 Pin × 3
Terminals (Video)	Component Video Input : RCA Jack (VIDEO/Y, C/Cb, Cr) × 2 Composite Video Input : RCA Jack and BNC Jack × 1 Separated Video Input : DIN 4 pin (S-VIDEO) × 3 Audio Input Jack : RCA Jack (stereo / Right and Left) × 3
Terminals (Others)	Mouse / Keyboard : Mini DIN 6 pin (for IBM-Compatible Computer) × 2 Mini DIN 4 pin (for Macintosh Computer) × 1
Built-in Speaker	10W × 2 (EIAJ)
Voltage	AC 100 ~ 120 V, 50 / 60 Hz
Power Consumption	3.2 A (Max. Ampere)
Dimensions (W × H × D)	1532mm × 1968mm × 747mm (60.3" × 77.5" × 29.4")
Net Weight	145kg (319.7 lbs) (except for the cabinet shelves.)
Accessories	Wireless Remote Control Transmitter × 1 Wireless / Wired Remote Control Transmitter × 1 Battery for Remote Control Units (AA Type) × 4 AC Power Cord × 1 Remote Control Cable × 1 VGA Cable × 1 Mac / VGA Adapter × 1 Mouse Cable for PS / 2 Port × 1 Mouse Cable for Serial Port × 1 Mouse Cable for ADB Port × 1 Owner's Manual × 1 Installation Manual × 1

- The specifications are subject to change without notice.

Front / Side View of the Projector

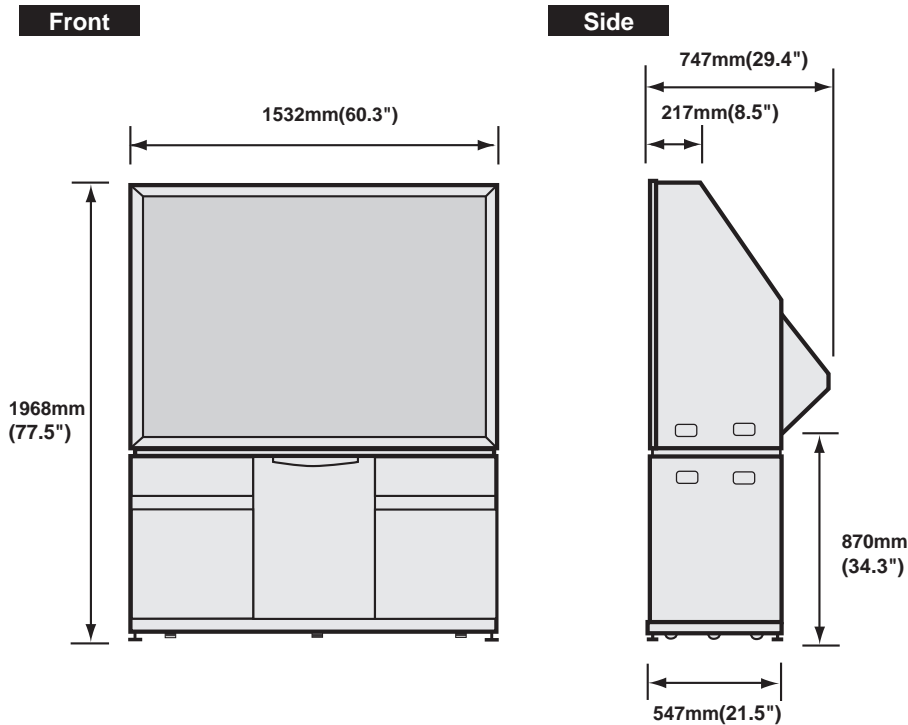

Remote Control Transmitters

WIRED REMOTE CONTROL

Power Source	AA Type × 2
Operating Range	5 m (16.4') / 60°
Dimensions (W × H × D)	56mm × 35mm × 193mm (2.2" × 1.4" × 7.6")
Net Weight	105 g (0.23 lbs) (including the batteries)

WIRED/WIRELESS REMOTE CONTROL

Power Source	AA Type × 2
Operating Range	5 m (16.4') / 60°
Dimensions (W × H × D)	45mm × 19mm × 170mm (1.8" × 0.7" × 6.7")
Net Weight	92 g (0.2 lbs) (including the batteries)



This symbol on the nameplate means the product is Listed by Underwriters Laboratories Inc. It is designed and manufactured to meet rigid U.L. safety standards against risk of fire, casualty and electrical hazards.

**SANYO INDUSTRIAL VIDEO
LCD PROJECTOR LIMITED WARRANTY**

OBLIGATIONS

In order to obtain warranty service, the product must be delivered to and picked up from and Authorized Sanyo Factory Service Center at the user's expense, unless specifically stated otherwise in this warranty. the names and addresses of authorized Sanyo Service Centers may be obtained by calling the toll-free number listed below.

For product operation, authorized service center referral, service assistance or problem resolution, call

**CUSTOMER INFORMATION 1-800-421-5013
Weekdays 8:00 AM - 5:00 PM Pacific Time**

For accessories and/or parts not available form an authorized dealer, call

**PARTS ORDER INFORMATION 1-800-726-9662
Weekdays 8:00 AM - 5:00 PM Pacific Time**

THIS WARRANTY IS VALID ONLY ON SANYO PRODUCTS PURCHASED OR RENTED AND USED IN THE UNITED STATES OF AMERICA, EXCLUDING ALL U.S. TERRITORIES AND PROTECTORATES, FOR INDUSTRIAL PROFESSIONAL OR COMMERCIAL PURPOSES. THIS WARRANTY APPLIES ONLY TO THE ORIGINAL RETAIL USER. THE ORIGINAL DATED BILL OF SALE, SALES SLIP OR RENTAL AGREEMENT MUST BE SUBMITTED TO THE AUTHORIZED SANYO SERVICE CENTER AT THE TIME WARRANTY SERVICE IS REQUESTED.

Subject to the OBLIGATIONS above and EXCLUSIONS below, SANYO FISHER COMPANY (SFC) warrants this SANYO product against defects in materials and workmanship for the periods of LABOR and PARTS specified below. SFC will repair or replace (at its option) the product and any of its parts which fall to conform to this warranty. The warranty period commences on the date the product was first purchased or rented at retail.

LABOR	PARTS	LAMP
1YEAR	1YEAR	90DAYS

EXCLUSIONS

This warranty does not cover (A) the adjustment of customer-operated controls as explained in the appropriate model's instruction manual, or (B) the repair of any product whose serial number has been altered, defaced or removed.

This warranty shall not apply to the cabinet or cosmetic parts, knobs or batteries or routine maintenance.

This warranty does not apply to uncrating, setup, installation, removal of the product for repair or reinstallation of the product after repair.

This warranty does not apply to repairs or replacements necessitated by any cause beyond the control of SFC including, but not limited to, any malfunction, defect or failure caused by or resulting from unauthorized service or parts, improper maintenance, operation contrary to furnished instructions, shipping or transit accidents, modification or repair by the user, abuse, misuse, neglect, accident, incorrect power line voltage, fire, flood or other Acts of God, or normal wear and tear.

The foregoing is in lieu of all other expressed warranties and SFC does not assume or authorize any party to assume for it any other obligation or liability.

SFC DISCLAIMS ALL WARRANTIES WHICH MAY BE IMPLIED BY LAW (INCLUDING THE WARRANTIES OF MERCHANTABILITY AND FITNESS), SFC'S LIABILITY FOR ANY AND ALL LOSSES AND DAMAGES RESULTING FROM ANY CAUSE WHATSOEVER, INCLUDING WARRANTOR'S NEGLIGENCE, ALLEGED DAMAGED OR DEFECTIVE GOODS, WHETHER SUCH DEFECTS ARE DISCOVERABLE OR LATENT, SHALL IN NO EVENT EXCEED THE PURCHASE PRICE OF THE EQUIPMENT.

ATTENTION

For your protection in the event of theft or loss of this product, please fill in the information below for your own personal records.

Model No. _____

Serial No. _____

(Located on back or bottom side of unit.)

Date of Purchase _____ Purchase Price _____

Where Purchased _____



21605 Plummer Street,
Chatsworth, California 91311