

Multimedia Projector

MODEL PLC-XF20

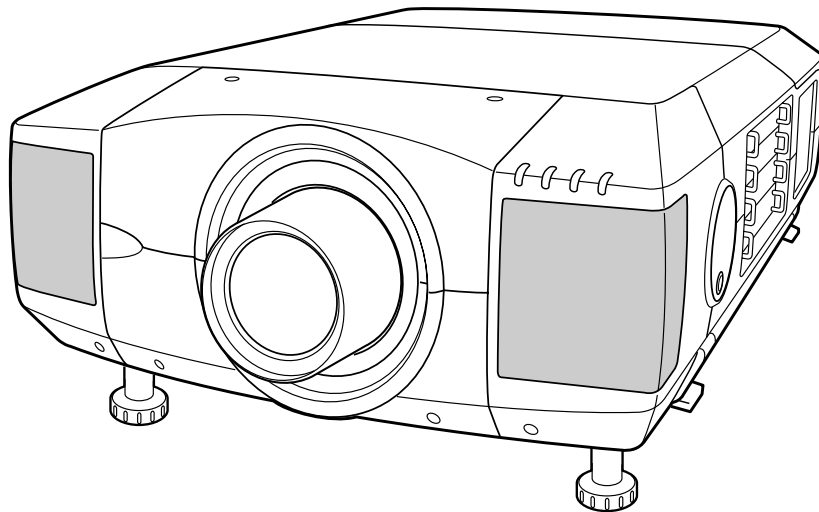

* Projection lens is optional.

Owner's Manual

TO THE OWNER

Before operating this projector, read this manual thoroughly and operate the projector properly.

This projector provides many convenient features and functions. Operating the projector properly enables you to manage those features and maintains it in better condition for a considerable time.

Improper operation may result in not only shortening the product-life, but also malfunctions, fire hazard, or other accidents.

If your projector seems to operate improperly, read this manual again, check operations and cable connections and try the solutions in the "Trouble-shooting" section of the end of this booklet. If the problem still persists, contact the sales dealer where you purchased the projector or the service center.



SAFETY PRECAUTIONS

WARNING : TO REDUCE THE RISK OF FIRE OR ELECTRIC SHOCK, DO NOT EXPOSE THIS APPLIANCE TO RAIN OR MOISTURE.

- This projector produces intense light from the projection lens. Do not stare directly into the lens as possible. Eye damage could result. Be especially careful that children do not stare directly into the beam.
- This projector should be set in the way indicated. If not, it may result in a fire hazard.
- Take appropriate space on the top, sides and rear of the projector cabinet for allowing air circulation and cooling the projector. Minimum distance should be taken. If the projector is to be built into a compartment or similarly enclosed, the minimum distances must be maintained. Do not cover the ventilation slot on the projector. Heat build-up can reduce the service life of your projector, and can also be dangerous.
- Do not put any flammable object or spray can near the projector, hot air is exhausted from the ventilation holes.
- The Remote Control Unit, supplied to this projector, emits the laser beam as the Laser Pointer function from the Laser Light Window while pressing the LASER button (for 1 minute). Do not look into the Laser Light Window or shine the laser beam on yourself or other people. Eye damage may result.
- If the projector is not to be used for an extended time, unplug the projector from the power outlet.

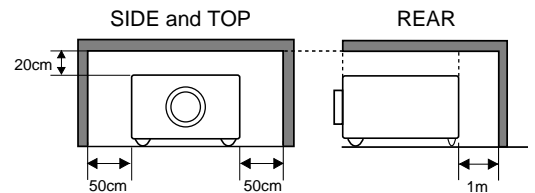

READ AND KEEP THIS OWNER'S MANUAL FOR LATER USE.



CAUTION
RISK OF ELECTRIC SHOCK
DO NOT OPEN



CAUTION : TO REDUCE THE RISK OF ELECTRIC SHOCK, DO NOT REMOVE COVER (OR BACK). NO USER-SERVICEABLE PARTS INSIDE EXCEPT LAMP REPLACEMENT. REFER SERVICING TO QUALIFIED SERVICE PERSONNEL.



THIS SYMBOL INDICATES THAT DANGEROUS VOLTAGE CONSTITUTING A RISK OF ELECTRIC SHOCK IS PRESENT WITHIN THIS UNIT.



THIS SYMBOL INDICATES THAT THERE ARE IMPORTANT OPERATING AND MAINTENANCE INSTRUCTIONS IN THE OWNER'S MANUAL WITH THIS UNIT.

SAFETY PRECAUTIONS

All the safety and operating instructions should be read before the product is operated.

Read all of the instructions given here and retain them for later use. Unplug this projector from AC power supply before cleaning. Do not use liquid or aerosol cleaners. Use a damp cloth for cleaning.

Follow all warnings and instructions marked on the projector.

For added protection to the projector during a lightning storm, or when it is left unattended and unused for long periods of time, unplug it from the wall outlet. This will prevent damage due to lightning and power line surges.

Do not expose this unit to rain or use near water... for example, in a wet basement, near a swimming pool, etc...

Do not use attachments not recommended by the manufacturer as they may cause hazards.

Do not place this projector on an unstable cart, stand, or table. The projector may fall, causing serious injury to a child or adult, and serious damage to the projector. Use only with a cart or stand recommended by the manufacturer, or sold with the projector. Wall or shelf mounting should follow the manufacturer's instructions, and should use a mounting kit approved by the manufacturers.

An appliance and cart combination should be moved with care. Quick stops, excessive force, and uneven surfaces may cause the appliance and cart combination to overturn.



Slots and openings in the back and bottom of the cabinet are provided for ventilation, to insure reliable operation of the equipment and to protect it from overheating.

The openings should never be covered with cloth or other materials, and the bottom opening should not be blocked by placing the projector on a bed, sofa, rug, or other similar surface. This projector should never be placed near or over a radiator or heat register.

This projector should not be placed in a built-in installation such as a book case unless proper ventilation is provided.

Never push objects of any kind into this projector through cabinet slots as they may touch dangerous voltage points or short out parts that could result in a fire or electric shock. Never spill liquid of any kind on the projector.

This projector should be operated only from the type of power source indicated on the marking label. If you are not sure of the type of power supplied, consult your authorized dealer or local power company.

Do not overload wall outlets and extension cords as this can result in fire or electric shock. Do not allow anything to rest on the power cord. Do not locate this projector where the cord may be damaged by persons walking on it.

Do not attempt to service this projector yourself as opening or removing covers may expose you to dangerous voltage or other hazards. Refer all servicing to qualified service personnel.

Unplug this projector from wall outlet and refer servicing to qualified service personnel under the following conditions:

- a. When the power cord or plug is damaged or frayed.
- b. If liquid has been spilled into the projector.
- c. If the projector has been exposed to rain or water.
- d. If the projector does not operate normally by following the operating instructions. Adjust only those controls that are covered by the operating instructions as improper adjustment of other controls may result in damage and will often require extensive work by a qualified technician to restore the projector to normal operation.
- e. If the projector has been dropped or the cabinet has been damaged.
- f. When the projector exhibits a distinct change in performance-this indicates a need for service.

When replacement parts are required, be sure the service technician has used replacement parts specified by the manufacturer that have the same characteristics as the original part. Unauthorized substitutions may result in fire, electric shock, or injury to persons.

Upon completion of any service or repairs to this projector, ask the service technician to perform routine safety checks to determine that the projector is in safe operating condition.

Voor de klanten in Nederland



Bij dit product zijn batterijen geleverd. Wanneer deze leeg zijn, moet u ze niet weggooien maar inleveren als KCA.

COMPLIANCES

Federal Communication Commission Notice

This equipment has been tested and found to comply with the limits for a Class A digital device, pursuant to Part 15 of FCC Rules. These limits are designed to provide reasonable protection against harmful interference when the equipment is operated in a commercial environment. This equipment generates, uses, and can radiate radio frequency energy and, if not installed and used in accordance with the instruction manual, may cause harmful interference to radio communications. Operation of this equipment in a residential area is likely to cause harmful interference in which case the user will be required to correct the interference at his own expense.

AC POWER CORD REQUIREMENT

The AC Power Cord supplied with this projector meets the requirement for use in the country you purchased it.

AC Power Cord for the United States and Canada :

AC Power Cord used in the United States and Canada is listed by the Underwriters Laboratories (UL) and certified by the Canadian Standard Association (CSA). AC Power Cord has a grounding-type AC line plug. This is a safety feature to be sure that the plug will fit into the power outlet. Do not try to defeat this safety feature. Should you be unable to insert the plug into the outlet, contact your electrician.

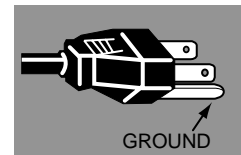

AC Power Cord for the United Kingdom :

This cord is already fitted with a moulded plug incorporating a fuse, the value of which is indicated on the pin face of the plug. Should the fuse need to be replaced, an ASTA approved BS 1362 fuse must be used of the same rating, marked thus \diamond . If the fuse cover is detachable, never use the plug with the cover omitted. If a replacement fuse cover is required, ensure it is of the same colour as that visible on the pin face of the plug (i.e. red or orange). Fuse covers are available from the Parts Department indicated in your User Instructions. If the plug supplied is not suitable for your socket outlet, it should be cut off and destroyed. The end of the flexible cord should be suitably prepared and the correct plug fitted. (See Over)

WARNING : A PLUG WITH BARED FLEXIBLE CORD IS HAZARDOUS IF ENGAGED IN A LIVE SOCKET OUTLET.

The Wires in this mains lead are coloured in accordance with the following code:

Green-and-yellow Earth
Blue Neutral
Brown Live

As the colours of the wires in the mains lead of this apparatus may not correspond with the coloured markings identifying the terminals in your plug proceed as follows:

The wire which is coloured green-and-yellow must be connected to the terminal in the plug which is marked by the letter E or by the safety earth symbol \perp or coloured green or green-and-yellow.

The wire which is coloured blue must be connected to the terminal which is marked with the letter N or coloured black.

The wire which is coloured brown must be connected to the terminal which is marked with the letter L or coloured red.

WARNING : THIS APPARATUS MUST BE EARTHED.

THE SOCKET-OUTLET SHOULD BE INSTALLED NEAR THE EQUIPMENT AND EASILY ACCESSIBLE.

TABLE OF CONTENTS

FEATURES AND DESIGN	6	COMPUTER MODE	27
PREPARATION	7	SELECTING COMPUTER SYSTEM	27
NAME OF EACH PART OF THE PROJECTOR	7	COMPATIBLE COMPUTER SPECIFICATIONS	29
SETTING-UP THE PROJECTOR	8	PC ADJUSTMENT	30
CONNECTING THE AC POWER CORD	8	PICTURE IMAGE ADJUSTMENT	32
LENS INSTALLATION	9	NORMAL FUNCTION	33
POSITIONING THE PROJECTOR	9	PICTURE POSITION ADJUSTMENT	33
LENS SHIFT ADJUSTMENT	9	AUTO IMAGE FUNCTION	33
PICTURE LEVEL AND TILT ADJUSTMENT	10	PICTURE SCREEN ADJUSTMENT	34
MOVING THE PROJECTOR	10		
CONNECTING THE PROJECTOR	11	VIDEO MODE	35
TERMINALS OF THE PROJECTOR	11	SELECTING VIDEO SOURCE	35
CONNECTING TO THE COMPUTER	14	SELECTING COLOR SYSTEM	36
CONNECTING TO THE VIDEO EQUIPMENT	15	PICTURE IMAGE ADJUSTMENT	37
		NORMAL FUNCTION	38
		PICTURE SCREEN ADJUSTMENT	38
BEFORE OPERATION	16	SETTING	39
SIDE CONTROLS AND INDICATORS	16	SETTING MENU	39
OPERATION OF THE REMOTE CONTROL	18	SETTING LANGUAGE	41
OPERATING RANGE	18		
REMOTE CONTROL BATTERIES INSTALLATION	19		
OPERATING ON-SCREEN MENU	20	APPENDIX	42
HOW TO OPERATE THE ON-SCREEN MENU	20	OPERATING WIRELESS MOUSE	42
FLOW OF ON-SCREEN MENU	20	MAINTENANCE	43
MENU BAR	21	TEMPERATURE WARNING INDICATOR	43
		AIR FILTER CARE AND CLEANING	43
		LAMP MANAGEMENT	44
		LAMP REPLACEMENT	45
		CLEANING THE PROJECTION LENS	45
		TROUBLESHOOTING	46
		TECHNICAL SPECIFICATIONS	48
BASIC OPERATION	23		
TURNING ON / OFF THE PROJECTOR	23		
ADJUSTING THE IMAGE	24		
ZOOM ADJUSTMENT	24		
FOCUS ADJUSTMENT	24		
LENS SHIFT ADJUSTMENT	24		
KEY STONE ADJUSTMENT	24		
NO SHOW FUNCTION	25		
PICTURE FREEZE FUNCTION	25		
P-TIMER FUNCTION	25		
SOUND ADJUSTMENT	25		
DIRECT OPERATION	25		
MENU OPERATION	26		
SELECTING INPUT SOURCE	26		
DIRECT OPERATION	26		
MENU OPERATION	26		

TRADEMARKS

- Apple, Macintosh, and PowerBook are trademarks or registered trademarks of Apple Computer, Inc.
- IBM and PS/2 are trademarks or registered trademarks of International Business Machines, Inc.
- Windows and PowerPoint are registered trademarks of Microsoft Corporation.
- Each name of corporations or products in the owner's manual is a trademark or a registered trademark of its respective corporation.

FEATURES AND DESIGN

This Multimedia Projector is designed with the most advanced technology for portability, durability, and ease of use. The projector utilizes built-in multimedia features, a palette of 16.77 million colors, and matrix liquid crystal display (LCD) technology.

◆ Compatibility

This projector widely accepts various video and computer input signals including;

- **Computers**
IBM-compatible and Macintosh computers up to 1280 x 1024 resolution.
- **6 Color Systems**
NTSC, PAL, SECAM, NTSC 4.43, PAL-M or PAL-N color system can be connected.
- **Component Video**
Component video signals, such as a DVD player output, high definition TV signals including 480i, 480p, 575i, 575p, 720p, 1035i, 1080i-50 or 1080i-60, can be connected.
- **S-Video**
S-Video signals, such as a S-VHS VCR output signals, can be connected.

◆ High Resolution Image

This projector provides 1024 x 768 dots resolution for computer input and 800 horizontal TV lines. The resolution from the computer between XGA (1024 x 768) and SXGA (1280 x 1024) is compressed into 1024 x 768 dots. This projector cannot display image of over 1280 x 1024 dots. When the resolution of your computer is over than 1280 x 1024, reset the computer output for lower resolution.

◆ Multi-Scan System

This projector has Multi-Scan System to conform to almost all computer output signals quickly. There is no need for troublesome manual adjustment of frequency and other settings.

◆ One-Touch Auto Imaging

Incoming computer video signals are recognized and the best setting is automatically selected by the Auto Image function. No complicated setup is necessary and projection is always precise.

◆ Progressive Scan Function

This function converts interlace video signals into progressive scan signals and provide fine picture quality.

◆ Multilanguage Menu Display

Operation menu is displayed in; English, Deutsch, Français, Italiano, Español, or Japanese.

◆ Digital Zoom (Computer Mode only)

The Digital Zoom magnifies the image up to 49 times, allowing you to focus on crucial information at a presentation.

◆ Motor-driven Lens Shift

The projection lens can be moved up, down, left and right with the motor-driven lens shift function. This function makes it easy to provide the projected image where you want.

The zoom and focus can be also adjusted with motor-driven operation.

◆ Keystone Correction

Positioning height of the projector may result in distorted images being displayed in a trapezoid shape. Keystone Correction maintains this problem by digitally altering the projection to produce undistorted images.

◆ Power Management

Power Management function is provided to reduce power consumption while the projector is not in use.

This Power Management function operates to turn the Projection Lamp off when the projector detects signal interruption and any button is not pressed over 5 minutes. The Projection Lamp is automatically turned on again when the projector detects the signal or any operation button is pressed.

This projector is shipped with this function ON.

◆ Digital Visual Interface

This projector is equipped with the DVI terminal for connecting DVI (conforming VESA standard) output of the computer.

◆ Multi Versatile Platform

This projector applies various input/output terminals and 4 terminal slots for expansion to tune to diversity of signals from computers and video equipment.

◆ Selectable Terminal Slots

4-built-in Terminal Slots enable you to arrange any combinations of input sources just by changing Terminal Boards. For Terminal Boards, contact the sales dealer where you purchased the projector.

◆ Laser Pointer Function

The Remote Control Unit supplied with this projector includes the Laser Pointer function. This function helps you to make a smart presentation on a projected screen.

◆ Wireless Mouse

The Remote Control Unit supplied with this projector has Wireless Mouse function for the connected computer. This function enables you to operate both projector and computer with this Remote Control Unit only.

PREPARATION

NAME OF EACH PART OF THE PROJECTOR

FRONT OF THE CABINET

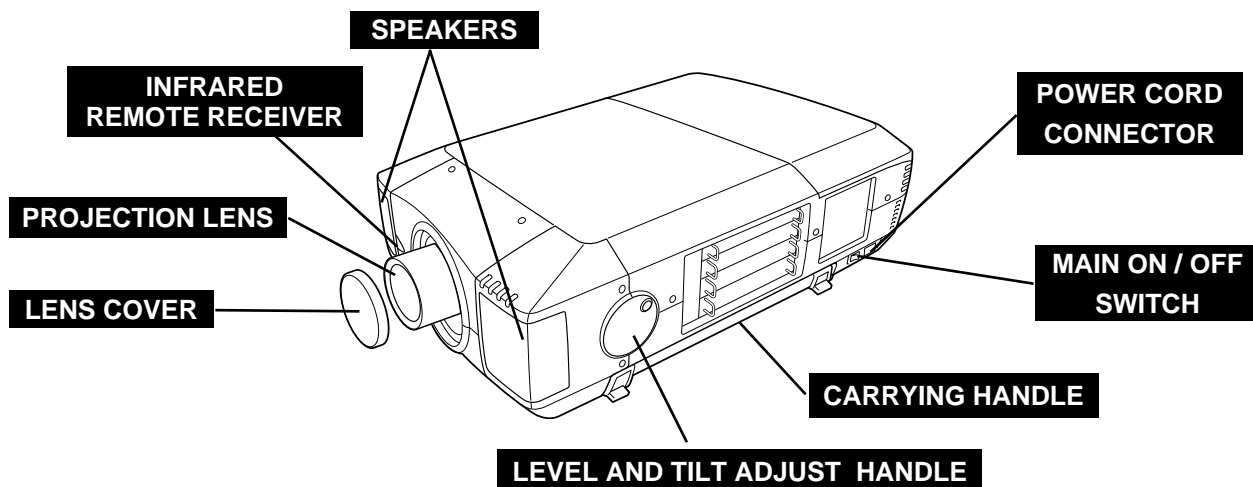

BACK OF THE CABINET

EXHAUST VENT



HOT AIR EXHAUSTED !

Air blown from the exhaust vent is hot. When using or installing the projector, the following precautions should be taken.

- Do not put a flammable object near this vent.
- Keep the rear grills at least 3' (1m) away from any object, especially heat-sensitive object.
- Do not touch this area, especially screws and metallic parts. This area will become hot while the projector is used.

This projector detects the internal temperature and automatically controls the operating power of the Cooling Fans.

INFRARED REMOTE RECEIVER

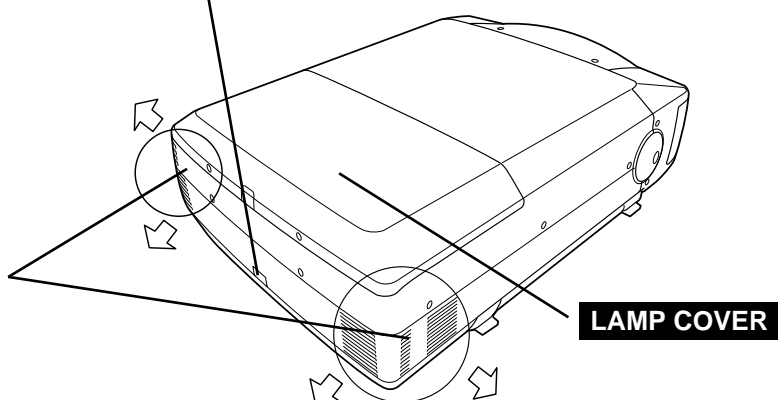

BOTTOM OF THE CABINET

AIR INTAKE VENTS

This projector is equipped with cooling fans for protection from overheating. Pay attention to the following to ensure proper ventilation and avoid a possible risk of fire and malfunction.

- Do not cover the vent slots.
- Keep bottom clear of any objects. Obstructions may block cooling air.

AIR FILTER

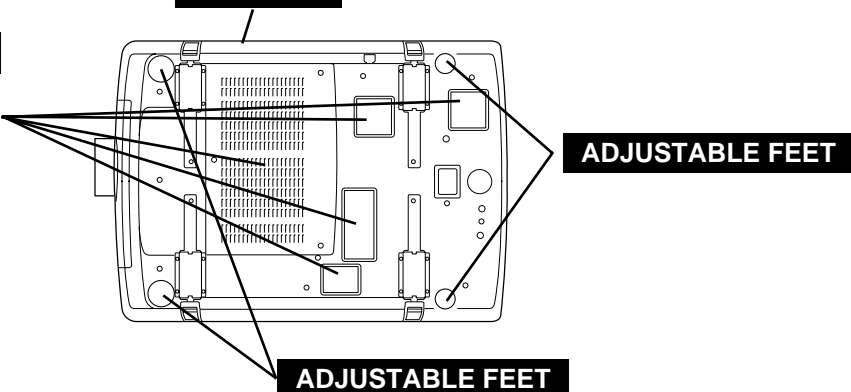

SETTING-UP THE PROJECTOR

CONNECTING THE AC POWER CORD

This projector uses nominal input voltages of 100-120 V or 200-240 V AC. The projector automatically selects the correct input voltage. It is designed to work with single-phase power systems having a grounded neutral conductor. To reduce the risk of electrical shock, do not plug into any other type of power system. Consult your authorized dealer or service station if you are not sure of the type of power supply being in use. Connect the projector with the peripheral equipment before turning the projector on. (Refer to pages 12 ~ 15 for connection.)

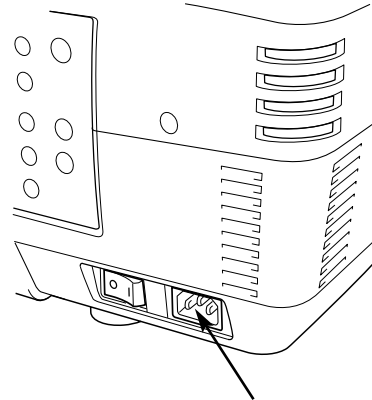

Connect the AC Power Cord (supplied) to the projector. The AC outlet must be near this equipment and must be easily accessible.

NOTE ON THE POWER CORD

The AC Power Cord must meet the requirement of the country where you use the projector. Confirm the AC plug type with the chart below and the proper AC power cord must be used. If the supplied AC Power Cord does not match the AC outlet, contact your sales dealer.

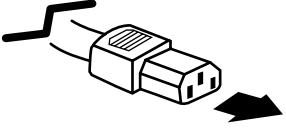
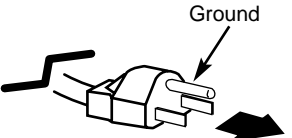
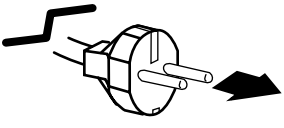
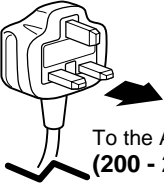
Projector side	AC Outlet side		
 <p>To the POWER CORD CONNECTOR on the projector.</p>	<p>For the U.S.A. and Canada</p>  <p>To the AC Outlet. (120 V AC)</p>	<p>For Continental Europe</p>  <p>To the AC Outlet. (200 - 240 V AC)</p>	<p>For the U.K.</p>  <p>To the AC Outlet. (200 - 240 V AC)</p>

LENS INSTALLATION

Before setting up the projector, install the Projection Lens on the Projector.

1. Before installation, check where the projector is used and prepare suitable lens. For specifications of the Projection Lens, refer to the manual separately attached or contact the sales dealer where you purchased the projector.
2. For installation, refer to the installation manual supplied to the Projector.



When moving or setting up the projector, be sure to replace the Lens Cover to protect the surface. And be careful not to hold or subject the lens to strong forces. It may damage the lens, cabinet, or mechanical parts.

POSITIONING THE PROJECTOR

This projector is designed to project on a flat projection surface.

ROOM LIGHT

The brightness in the room has a great influence on the picture quality. It is recommended to limit ambient lighting in order to provide the best image.

VENTILATION

This projector is equipped with cooling fan to protect it from overheating. Pay attention to the following to ensure proper ventilation and avoid a possible risk of fire and malfunction.



- Do not cover the vents with papers or other materials.
- Keep the rear grill at least 3 feet (1 m) away from any object.
- Make sure that there are no objects under the projector. An object under the projector may prevent the projector from taking the cooling air through the bottom vent.

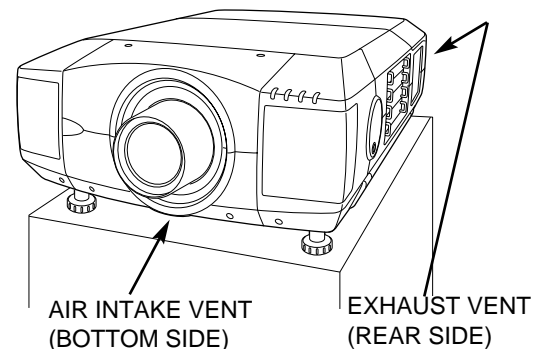
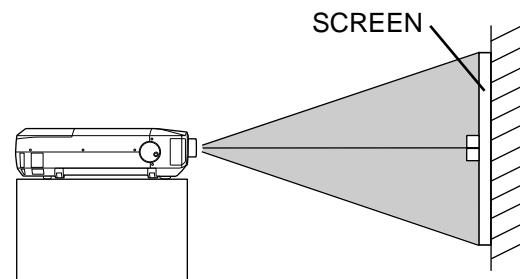

LENS SHIFT ADJUSTMENT

The projection lens can be moved up, down, left and right with the motor-driven lens shift function. This function makes it easy to provide the projected image where you want.

Use the LENS SHIFT button and the POINT UP/DOWN button to move the image up or down.

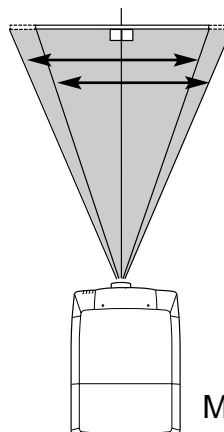
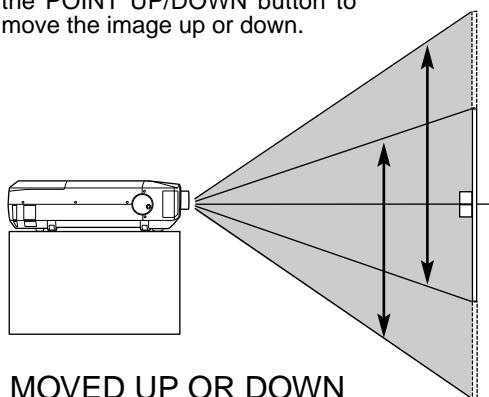

Use the LENS SHIFT button and the POINT LEFT/RIGHT button to move the image left or right.

PICTURE LEVEL AND TILT ADJUSTMENT

Picture tilt and projection angle can be adjusted with handles on both sides of the projector. Projection angle can be adjusted to 5.7 degrees upper way.

- 1** Press the knob on the handle. The handle pop out.
- 2** Turn the handles (right and left) until the picture is projected on proper position. Adjust height of rear adjustable feet by rotating them until projector properly stabled on the table.
- 3** Press knob and retract the handle.

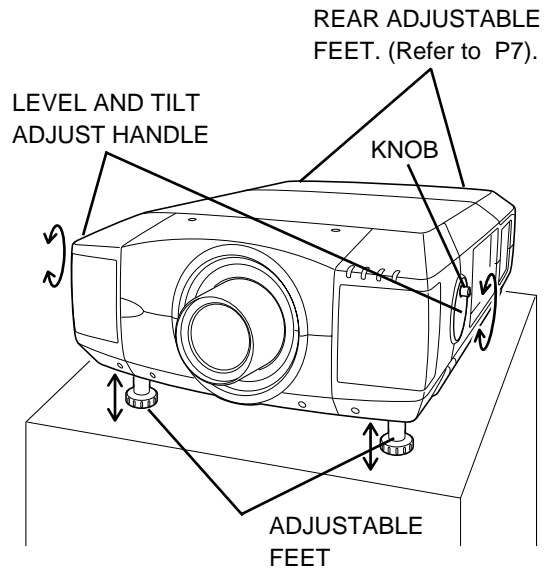

The height of front feet can be adjusted by turning the handles.

MOVING THE PROJECTOR



For safety, be sure to hold Carrying Handles on both sides by 2 or more people when moving the projector. Moving it improperly may result in damage of cabinet or person's injury.
Replace the lens cover and retract the feet to prevent damage to the lens and cabinet.

- 1** Pull up the lock buttons on each side of carrying handles and release the locks.
- 2** Pull carrying handles out fully until it's locked (with a click). Move the projector by holding two handles by 2 or more people.
- 3** To retract carrying handles, pull up the lock buttons and release the lock of handles and press the handles fully in until it's locked.

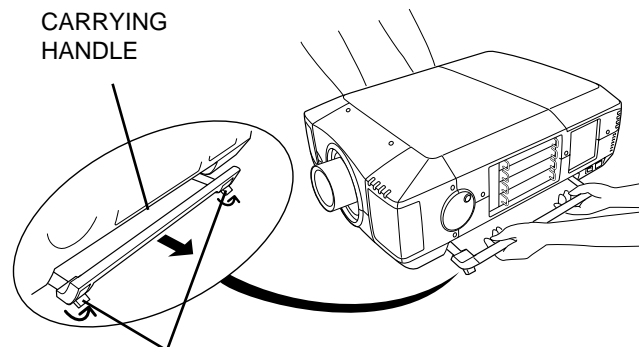

LOCK BUTTONS

Pull up the lock buttons to release the lock.



CAUTION IN CARRYING OR TRANSPORTING THE PROJECTOR

- Do not drop or bump the projector, otherwise damages or malfunctions may result.
- When carrying the projector, use a suitable carrying case.
- Do not transport the projector by using a courier or transport service in an unsuitable transport case. This may cause damage to the projector. To transport the projector through a courier or transport service, consult your dealer and best case should be applied.

CONNECTING THE PROJECTOR

TERMINALS OF THE PROJECTOR

This projector applies various input/output terminals and 4 terminal slots for expansion to tune to diversity of signals from computers and video equipment. 4-built-in Terminal Slots enable you to arrange desired combinations of input sources just by changing Terminal Boards. For Terminal Boards, contact the sales dealer where you purchased the projector.

NOTE; DVI Terminal is unavailable for INPUT 3 and INPUT 4 slots.

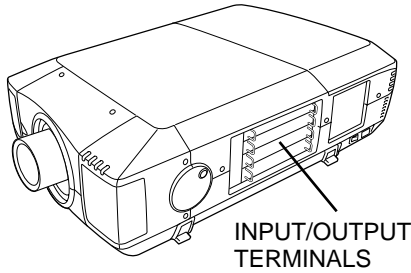

4 TERMINAL SLOTS (Factory set)

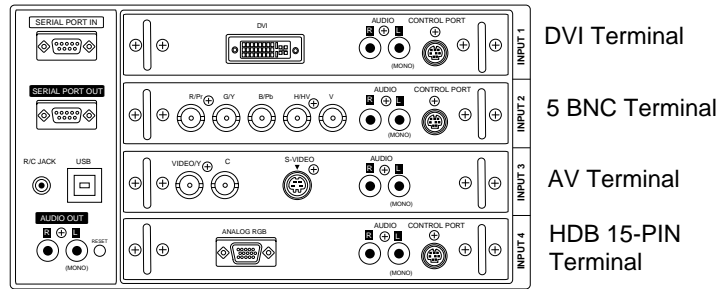

REPLACEMENT OF THE TERMINAL

- 1 Remove 2 Screws on the terminal.
- 2 Pull out the terminal by holding the handle.
- 3 Replace the terminal. Insert the terminal along Guide to fit Plug into Socket.
- 4 Tighten the screws to secure the terminal.

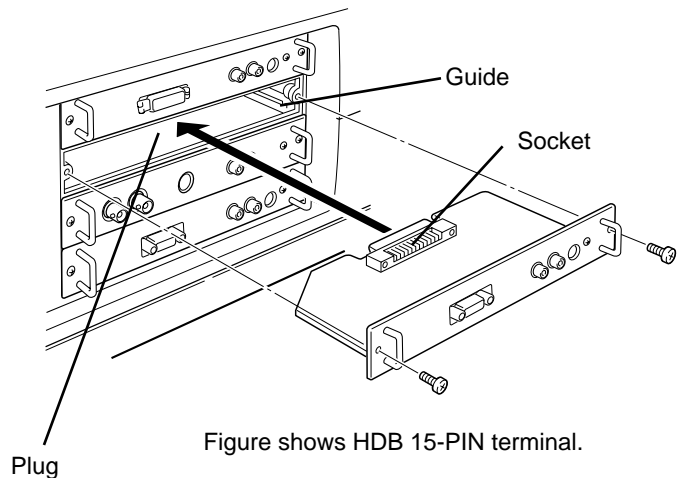
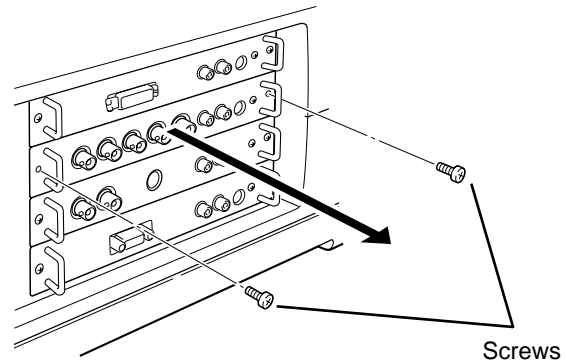

INPUT/OUTPUT TERMINALS AND JACKS

INPUT 2

5 BNC INPUT JACKS

Connect the component video output (Cr, Y, Cb or Pr, Y, Pb) from the video equipment to the R/Pr, G/Y and B/Pb jacks or connect the computer output [5 BNC Type (Red, Green, Blue, Horiz. Sync and Vert. Sync.)] from the computer to the R/Pr, G/Y, B/Pb, H/HV and V jacks. (Refer to P14, 15)

INPUT 1

DVI INPUT TERMINAL

Connect the computer output (Digital/Analog DVI-I type) to this terminal. (Refer to P14.)

INPUT 1/2/3/4

AUDIO INPUT JACKS

Connect the audio output from the computer or video equipment to these jacks. (Refer to P14, 15.)

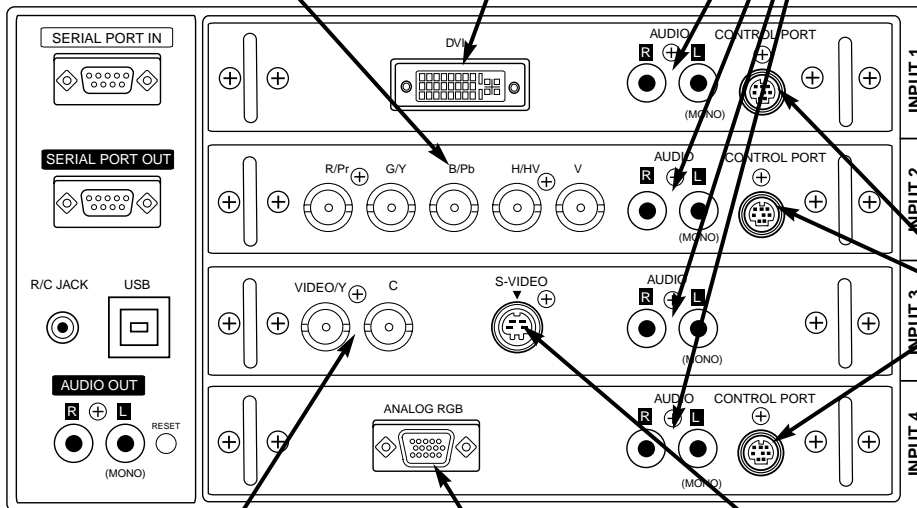

INPUT 1/2/4

CONTROL PORT CONNECTORS

When controlling the computer with the Remote Control of this projector, connect the mouse port of your personal computer to these connectors. (Refer to P14.)

INPUT 3

AV INPUT (VIDEO/Y, C) JACKS

Connect the composite video output from the video equipment to the VIDEO/Y jack or connect the Separate Y/C video outputs to the VIDEO/Y and C jacks. (Refer to P15.)

INPUT 4

HDB 15-PIN INPUT TERMINAL

Connect the computer output (Analog HDB 15-pin type) to this terminal. (Refer to P14.)

INPUT 3

S-VIDEO INPUT JACK

Connect the S-VIDEO output from the video equipment to this jack. (Refer to P15.)

SERIAL PORT IN TERMINAL

If you control the projector by computer, you must connect a cable (not provided) from your computer to this terminal.

SERIAL PORT OUT TERMINAL

This terminal outputs the signal from SERIAL PORT IN. More than two projectors can be controlled with one computer by connecting SERIAL PORT IN. of another projector to this terminal.

USB PORT

This port is used to control the projector with the computer. It is also used to control the computer with the Remote Control of this projector. (Refer to P40, 42.)

Connect the USB port of the computer to this port.

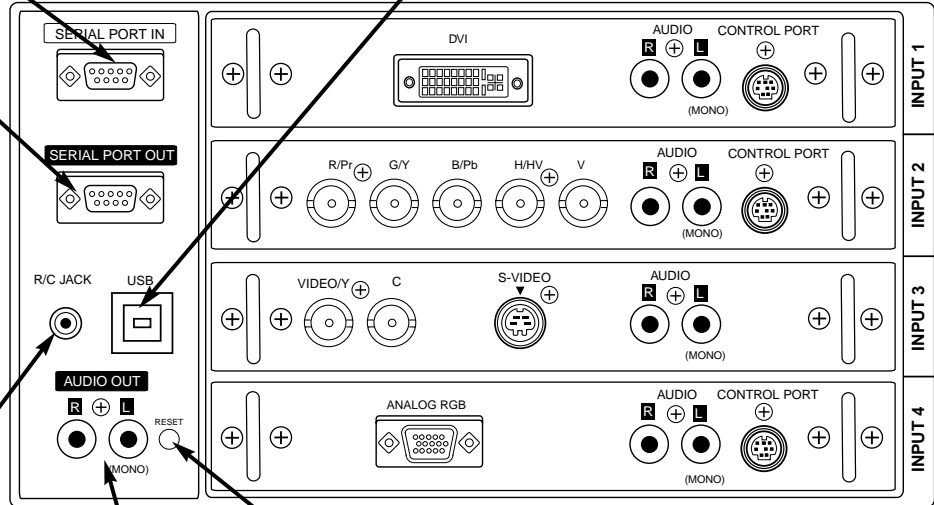

R/C JACK

When using the Wired / Wireless Remote Control Unit as the Wired Remote Control, Connect the Wired Remote Control Unit to this jack with the Remote Control Cable (supplied). (Refer to page 19.)

RESET BUTTON

This projector uses a micro processor to control the unit. Occasionally, the micro processor may malfunction and need to be reset. This can be done by pressing the RESET button with a pen, which will shut down and restart the unit. Do not use the RESET function excessively.

AUDIO OUTPUT JACKS

Connect an external audio amplifier to these jacks. (Refer to P14, 15.)

CONNECTING TO THE COMPUTER

Cables used for connection (* = Cables are not supplied with this projector.)

- VGA Cable (HDB 15 pin)
- Control Cable for PS/2 port, Serial port, or ADB port
- MAC/VGA Adapter
- DVI Cable
- BNC Cable (BNC x 5) *
- Audio Cables (RCA x 2) *



NOTE :

When connecting the cable, the power cords of both the projector and the external equipment should be disconnected from AC outlet. Turn the projector and peripheral equipment on before the computer is switched on.

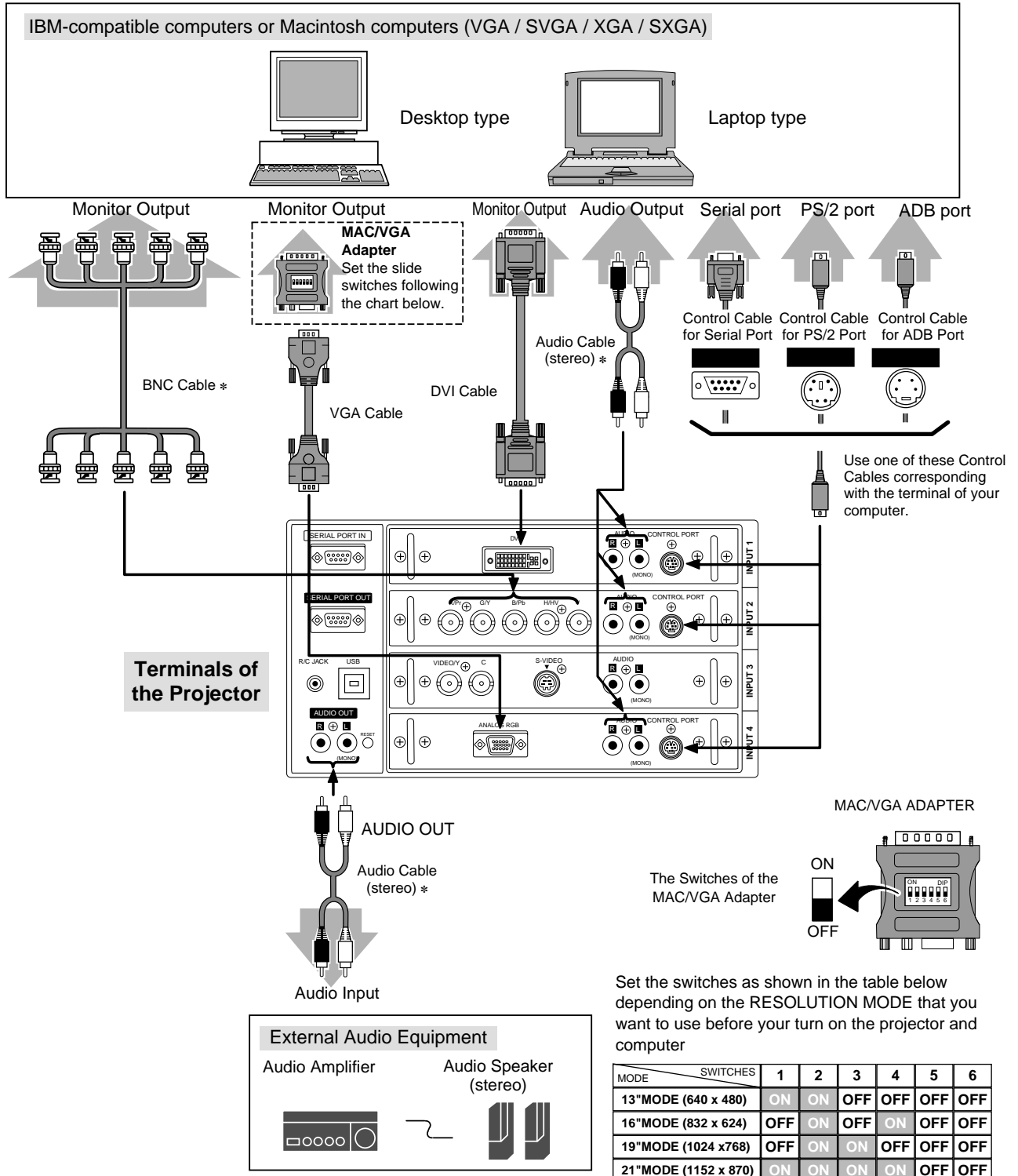

CONNECTING TO THE VIDEO EQUIPMENT

Cables used for connection

- Video Cable (BNC x 1, BNC x 2 or BNC x 3) *
- S-VIDEO Cable *
- Audio Cable (RCA x 2) *

(* = Cables are not supplied with this projector.)

NOTE :
 When connecting the cable, the power cords of both the projector and the external equipment should be disconnected from AC outlet. Turn the projector and peripheral equipment on before the computer is switched on.

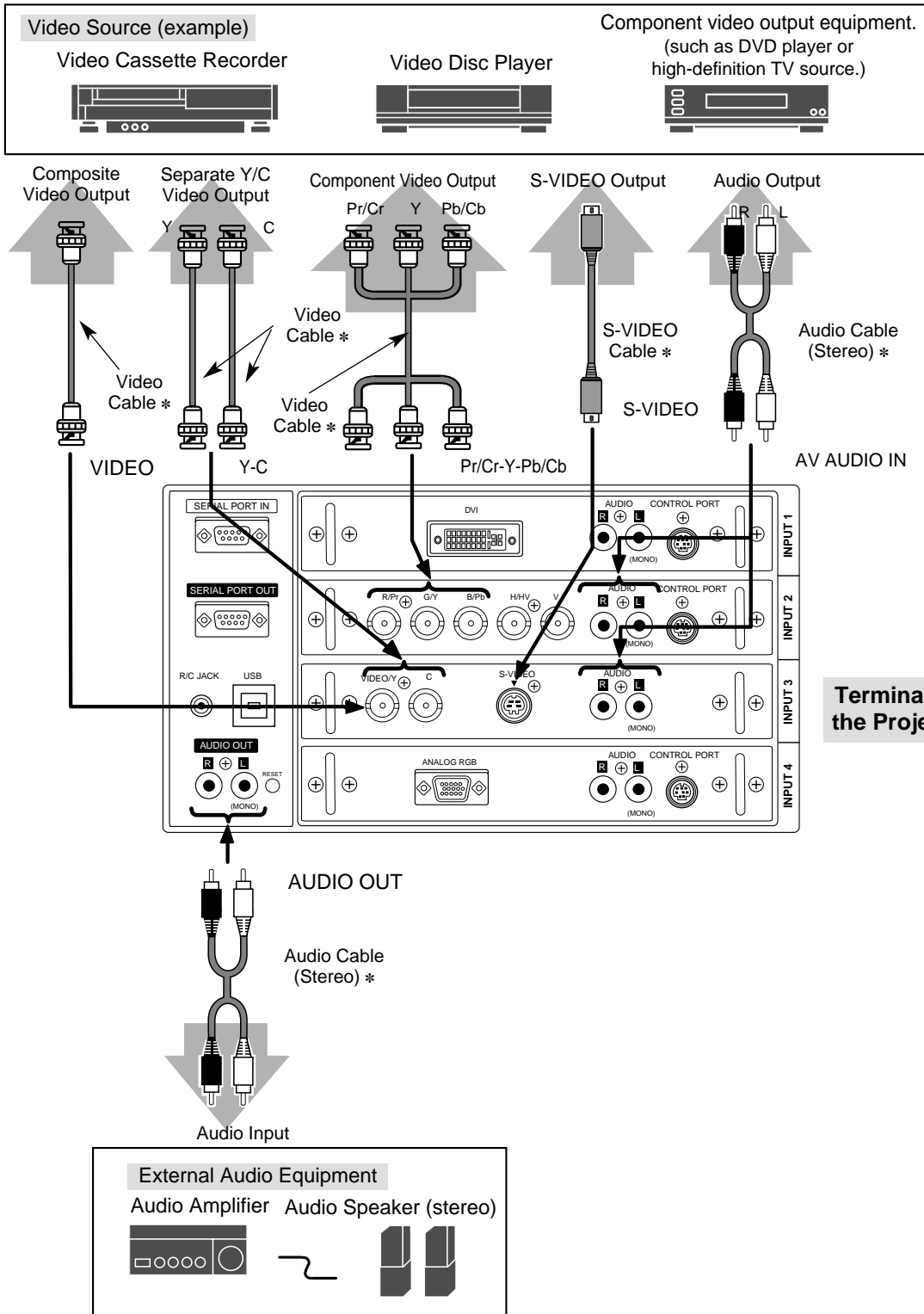

BEFORE OPERATION

SIDE CONTROLS AND INDICATORS

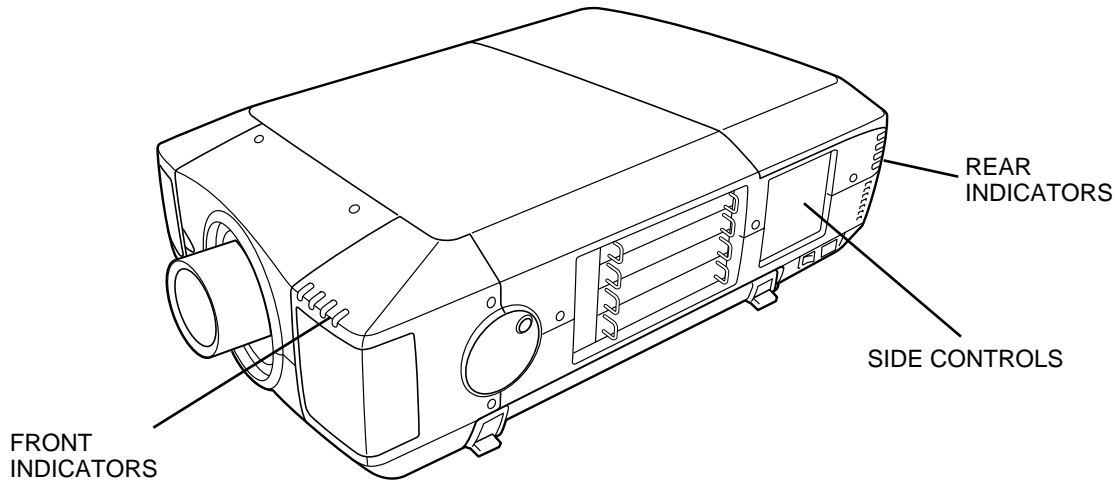

SIDE CONTROLS

ZOOM BUTTONS

Used to adjust zoom. (P24)

FOCUS BUTTONS

Used to adjust focus. (P24)

VOLUME BUTTONS

Used to adjust volume. (P26)

POWER ON-OFF BUTTON

Used to turn the projector on or off. (P23)

MENU BUTTONS

Used to open or close the MENU operation. (P20, 21, 22)

SELECT BUTTON

Used to execute the item selected. It is also used to expand the image in DIGITAL ZOOM mode. (P34)

AUTO IMAGE BUTTON

Used to operate AUTO IMAGE function. (P33)

POINT BUTTONS

Used to select an item or adjust the value in the MENU. It is also used to pan the image in DIGITAL ZOOM mode. (P34)

NORMAL BUTTON

Used to reset to normal picture adjustment preset by factory. (P33, 38)

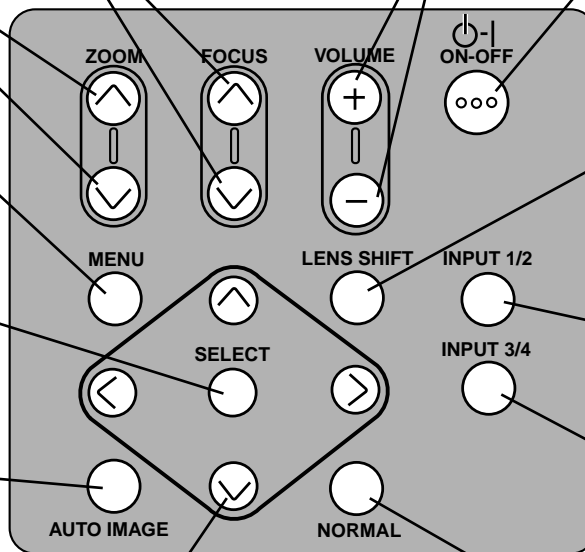

LENS SHIFT BUTTONS

Used to select LENS SHIFT function. (P24)

INPUT 1/2 BUTTON

Used to select input source either INPUT 1 or INPUT 2. (P26)

INPUT 3/4 BUTTON

Used to select input source either INPUT 3 or INPUT 4. (P26)

INDICATORS

FRONT INDICATORS

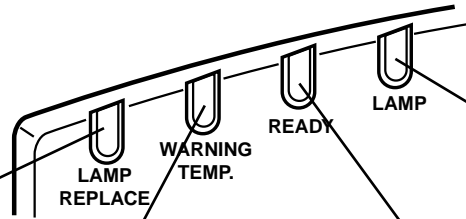

LAMP REPLACE INDICATOR

This LAMP REPLACE indicator lights yellow when any of Projection Lamps is nearing its end, and flashes when any of them becomes out. Check which lamp needs to be replaced on Lamp Status Display. (P44)

WARNING TEMP. INDICATOR

This indicator flashes red when internal projector temperature is too high. (P43)

READY INDICATOR

This indicator lights green when the projector is ready to be turned on. And it flashes green in Power Management mode. (P39)

LAMP INDICATOR

This indicator is dim when the projector is turned on. And bright when the projector is in stand-by mode.

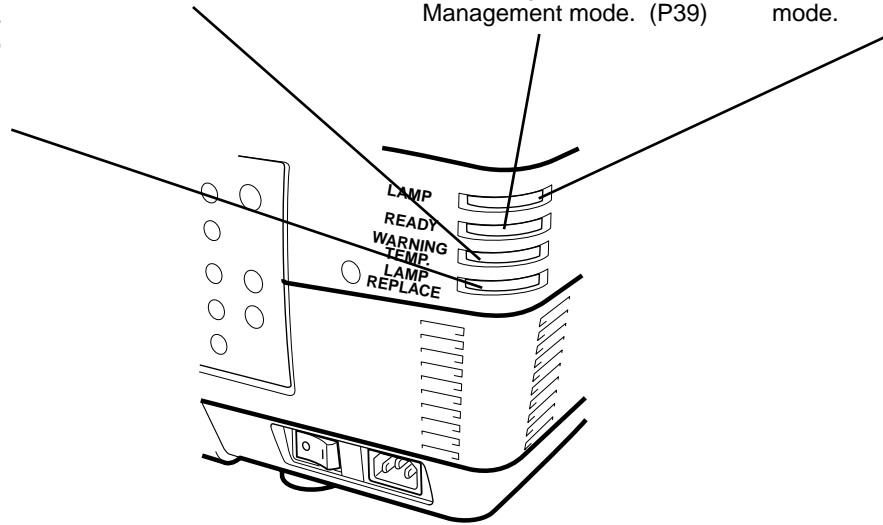

REAR INDICATORS

OPERATION OF THE REMOTE CONTROL

LEFT SIDE

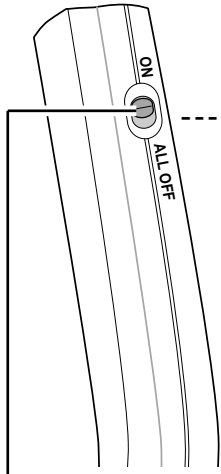

ALL-OFF SWITCH

When using the Remote Control Unit, turn this switch to "ON." And turn it to "ALL OFF" when it is not used.

INPUT 1/2 BUTTON

Used to select input source either INPUT 1 or INPUT 2. (P26)

POWER ON-OFF BUTTON

Used to turn the projector on or off. (P23)

INPUT 3/4 BUTTON

Used to select input source either INPUT 3 or INPUT 4. (P26)

MENU BUTTON

Used to select MENU operation. (P20, 21, 22)

POINT BUTTON

Used to move the pointer on the MENU, to adjust the item, or to pan the image in DIGITAL ZOOM mode. (P34)
It is also used as a PC mouse in Wireless Mouse Operation. (P42)

SELECT BUTTON

Used to execute the item selected or to expand the image in DIGITAL ZOOM mode. (P34)
It is also used as a PC mouse in Wireless Mouse Operation. (P42)

RIGHT CLICK BUTTON

Used to compress the image in DIGITAL ZOOM mode. (P34)
It is also used as a PC mouse in Wireless Mouse Operation. (P42)

LASER BUTTON

Used to operate the laser pointer function. The laser beam is emitted while pressing this button within 1 minute. When using the laser pointer for more than 1 minute, release the button and press it again.

P-TIMER BUTTON

Used to operate P-TIMER function. (P25)

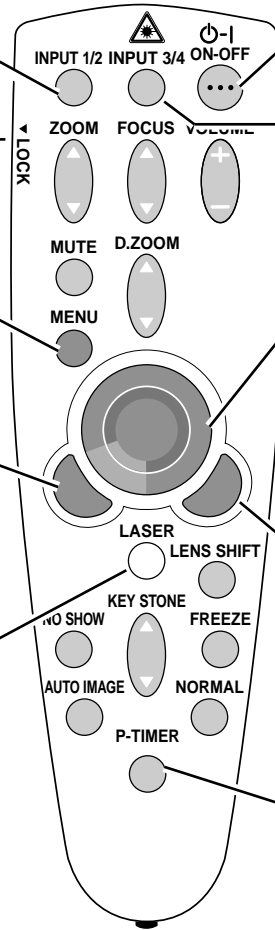

LASER POINTER FUNCTION

This remote control emits a laser beam as the Laser Pointer from the Laser Light Window. When the LASER button is pressed, the laser light goes on. And when the button is pressed more than 1 minute or the button is released, light goes off. Laser light is emitted with the RED light which tells the laser beam being emitted.

The laser emitted is a class II laser; therefore, do not look into the Laser Light Window or shine the laser beam on yourself or other people. The three marks bellow are the caution labels for the laser beam.

CAUTION : Use of controls or adjustments or performance of procedures other than those specified herein may result hazardous radiation exposure.

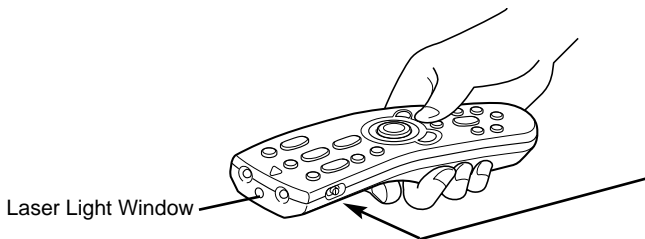

These caution labels are put on the remote control.

<p>CAUTION</p> <p>LASER RADIATION- DO NOT STARE INTO BEAM</p> <p>MAX OUTPUT: 1mW WAVE LENGTH: 650±20nm CLASS II LASER PRODUCT</p> <p><small>This product is complied with 21 CFR part 1040.10</small></p>	<p>LASER RADIATION DO NOT STARE INTO BEAM CLASS 2 LASER PRODUCT LASER-STRAHLUNG NICHT IN DEN STRAHL BLICKEN LASER-KLASSE 2 レーザー放射 クラス2 レーザ製品 ビームをのぞき込まないこと IEC60825-1, Am.1 1997 MAX OUTPUT (最大出力) : 1mW WAVE LENGTH (波長) : 650±20nm</p>
--	--



AVOID EXPOSURE-LASER RADIATION IS EMITTED FROM THIS APERTURE
レーザー光の出口
ビームをのぞき込まないこと

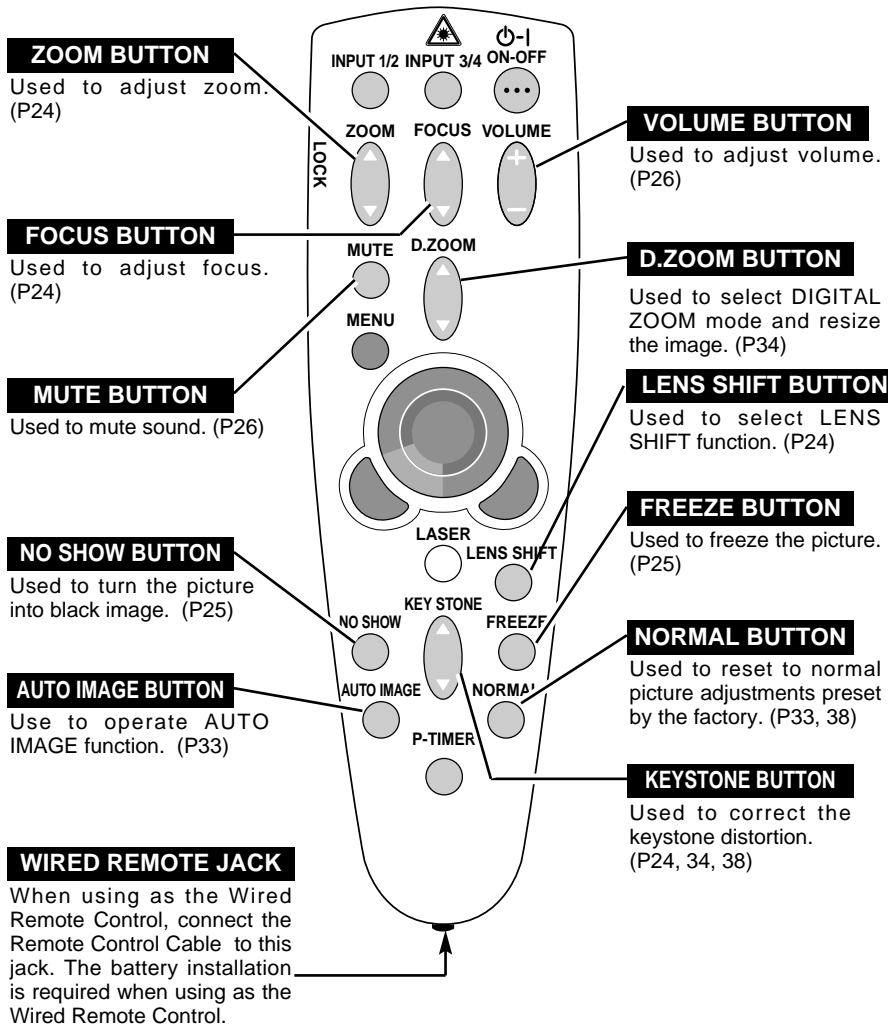

Operating Range

Point the remote control toward the projector (Receiver Window) whenever pressing the buttons. Maximum operating range for the remote control is about 16.4' (5m) and 60° in front and rear of the projector.

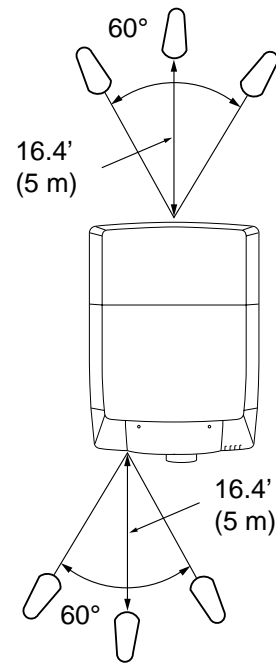

REMOTE CONTROL BATTERIES INSTALLATION

- 1 Remove the battery compartment lid.

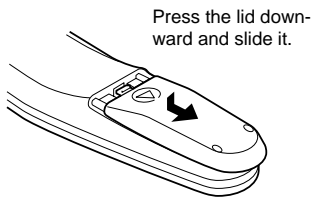

- 2 Slide the batteries into the compartment.

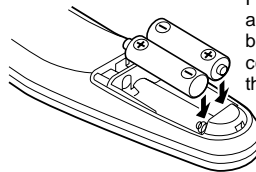

- 3 Replace the compartment lid.

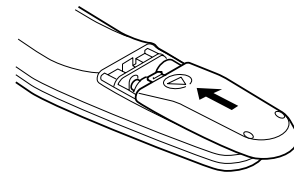

To insure safe operation, please observe the following precautions :

- Use (2) AA, UM3 or R06 type alkaline batteries.
- Replace two batteries at the same time.
- Do not use a new battery with a used battery.
- Avoid contact with water or liquid.
- Do not expose the Remote Control Unit to moisture, or heat.
- Do not drop the remote control unit.
- If batteries have leaked on the remote control, carefully wipe the case clean and load new batteries.

OPERATING ON-SCREEN MENU

HOW TO OPERATE THE ON-SCREEN MENU

You can control and adjust this projector through the ON-SCREEN MENU. Refer to the following pages to operate each adjustment in the ON-SCREEN MENU.

1 MOVING THE POINTER

Move the pointer (see the NOTE below) by pressing POINT button(s) on the SIDE CONTROL or the REMOTE CONTROL.

2 SELECT THE ITEM

Select the item by pressing SELECT button.

NOTE : Pointer is the icon on the ON-SCREEN Menu to select the item. See the figures on the section "FLOW OF ON-SCREEN MENU" below.

WIRELESS REMOTE CONTROL

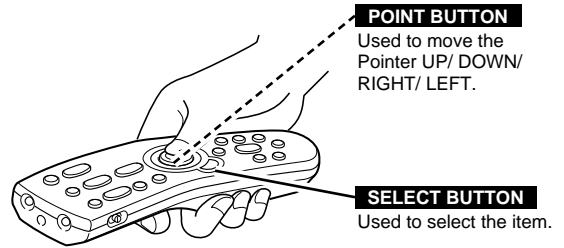

SIDE CONTROL

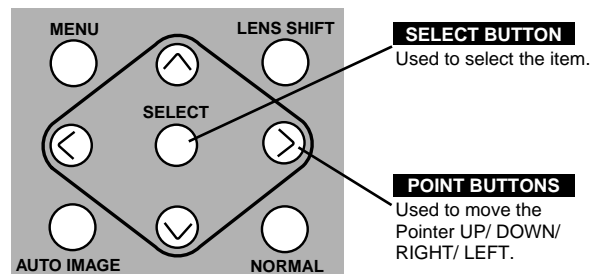

FLOW OF ON-SCREEN MENU

Display ON-SCREEN MENU

1 Press MENU button to display the ON-SCREEN MENU (MENU BAR). The red frame is the POINTER.

Select the Item

2 Move the POINTER (red frame) to the ITEM ICON that you want to select by pressing POINT RIGHT / LEFT buttons.

3 Select the ITEM by pressing SELECT button. The dialog box of the ITEM appears.

Control and adjust through ON-SCREEN MENU

4 Move the POINTER downward by pressing POINT DOWN button. (The shape of the POINTER becomes an arrow.)

5 Move the POINTER to the ITEM that you want to adjust and adjust the ITEM by pressing SELECT button. Refer to the following pages for details of respective adjustments.

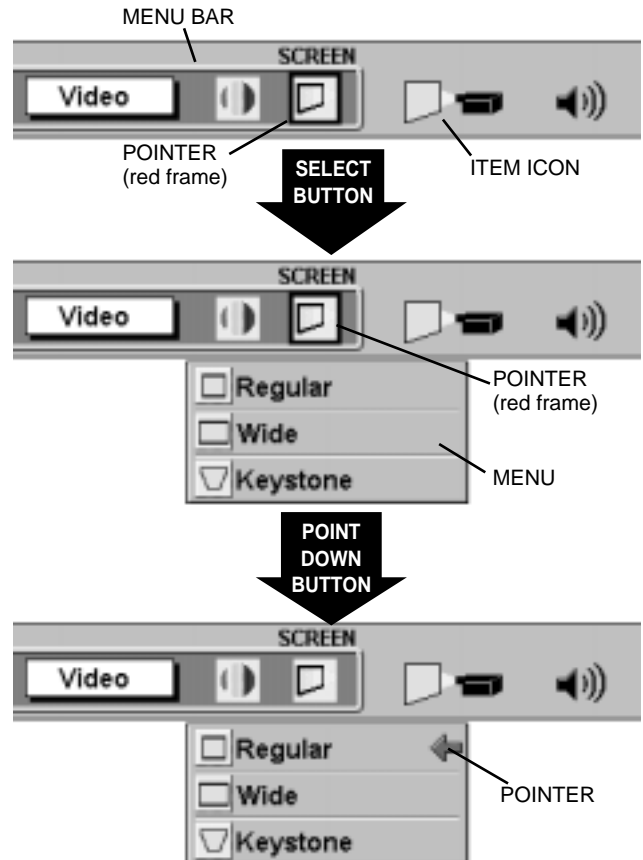

MENU BAR

MENU BAR IN COMPUTER MODE

WHEN SELECT THE DVI TERMINAL

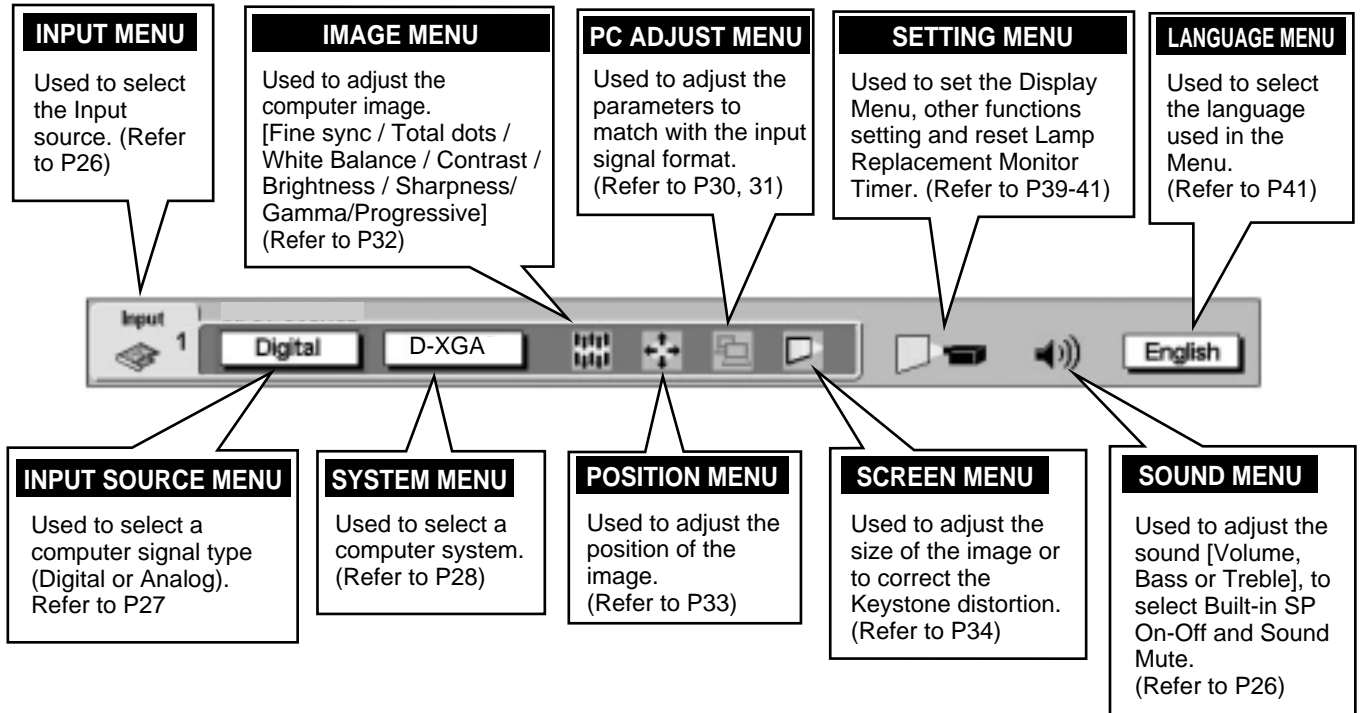

WHEN SELECT THE 5 BNC TERMINAL AND RGB INPUT SELECT



WHEN SELECT THE HDB 15-PIN TERMINAL



BEFORE OPERATION

MENU BAR IN VIDEO MODE

WHEN SELECT THE AV TERMINAL

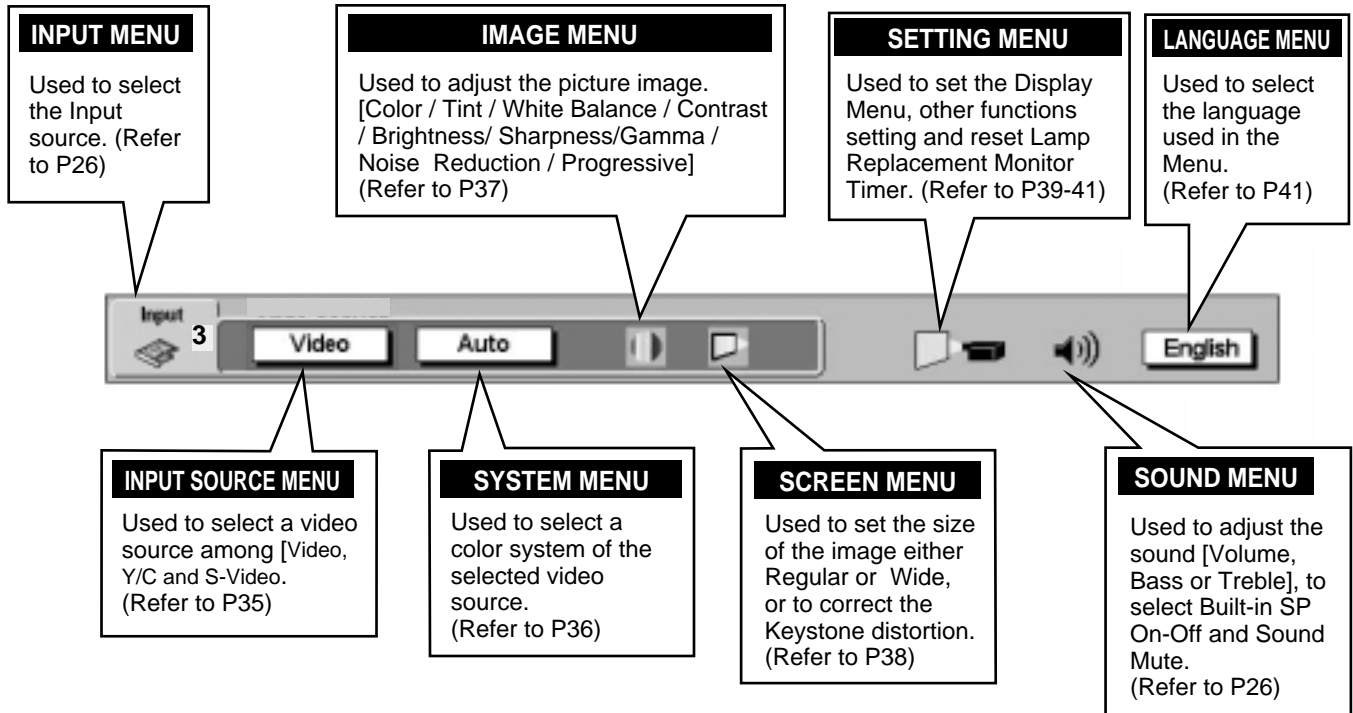

WHEN SELECT THE 5 BNC TERMINAL AND Y, Pb/Cb, Pr/Cr INPUT SELECT

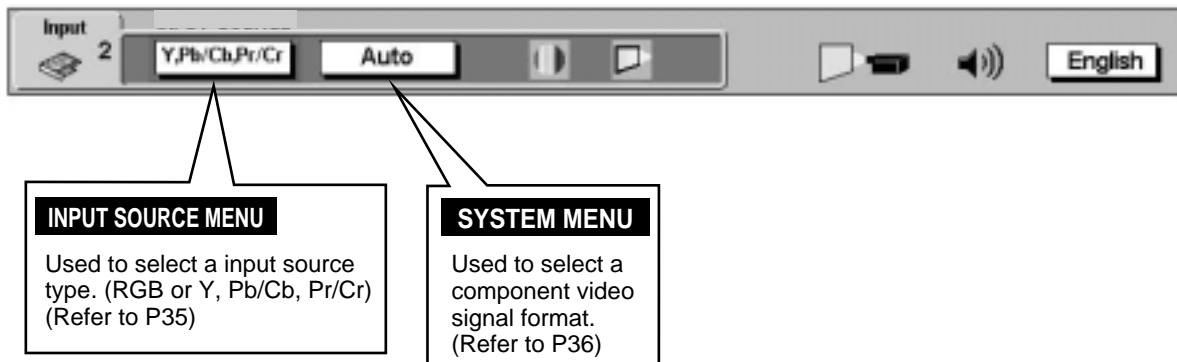

BASIC OPERATION

TURNING ON / OFF THE PROJECTOR

TURNING ON THE PROJECTOR

- 1 Complete the peripheral connections (with Computer, VCR, etc.) before turning on the projector. (Refer to "CONNECTING TO THE PROJECTOR" on Pages 12~15 for connecting that equipment.)
- 2 Connect the projector's AC Power Cord into a wall outlet and turn the MAIN ON / OFF SWITCH to ON. The LAMP indicator lights RED, and the READY indicator lights GREEN.
- 3 Press the POWER ON-OFF button on the Remote Control Unit or on the Side Control to ON. The LAMP indicator dims, and the Cooling Fans start to operate. The Preparation Display appears on the screen and the count-down starts. The signal from the source appears after 30 seconds. Lamp status is also displayed on screen for 10 seconds. (Refer to "LAMP MANAGEMENT" on page 44.)

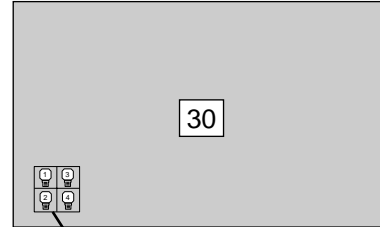

LAMP STATUS

The Preparation Display disappears after 30 seconds.

TURNING OFF THE PROJECTOR

- 1 Press the power ON-OFF button on the Remote Control Unit or on the Side Control, and the message "Power off?" appears on the screen.
- 2 Press the power ON-OFF button again to turn off the projector. The LAMP indicator lights bright and the READY indicator turns off. After approximate 90 seconds, the READY indicator will light green again and the projector may be turned on by pressing the power ON-OFF button.
- 3 The cooling fans will operate for approximate 2 minutes after the projector is turned off. To power down completely, turn the MAIN ON/OFF SWITCH to OFF and disconnect the AC power cord.

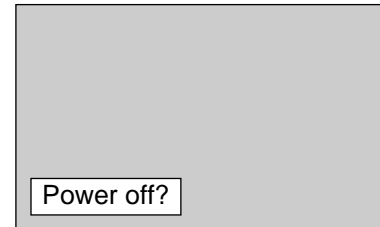

The message disappears after 4 seconds.



TO MAINTAIN THE LIFE OF THE LAMP, ONCE YOU TURN THE PROJECTOR ON, WAIT AT LEAST 5 MINUTES BEFORE TURNING IT OFF.

When the Power Management function is ON, the Projector detects the signal interruption and turns the Projection Lamp off automatically. Refer to "Power Management" on page 39.

When the TEMPERATURE WARNING indicator flashes red, the projector is automatically turned off. Wait at least 5 minutes before turning the projector on again.

When the TEMPERATURE WARNING indicator continues to flash, follow procedures below:

1. Turn the MAIN ON / OFF SWITCH to OFF and disconnect the AC power cord from the AC outlet.
2. Check the air filters for dust accumulation.
3. Clean the Air Filter. (See "AIR FILTER CARE AND CLEANING" section on page 43.)
4. Turn the Projector on again.

If the TEMPERATURE WARNING indicator should still continue to flash, contact the sales dealer where you purchased this projector or service center.

NOTE: The Cooling Fan may work for cooling while the projector is turned off. When the Cooling Fan is working, TEMPERATURE WARNING INDICATOR flashes red.

ADJUSTING THE IMAGE

ZOOM ADJUSTMENT

- 1 Press the ZOOM ▲/▼ button(s) on the Side Control or on the Remote Control Unit. The message “Zoom” is displayed.
- 2 Press the ZOOM ▲ button to make the image larger, and press the ZOOM ▼ button to make the image smaller.



The message disappears after 4 seconds.

FOCUS ADJUSTMENT

- 1 Press the FOCUS ▲/▼ button(s) on the Side Control or on the Remote Control Unit. The message “Focus” is displayed.
- 2 Adjust the focus of the image by pressing the FOCUS ▲/▼ button(s).

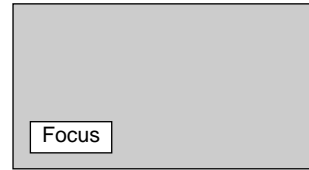

The message disappears after 4 seconds.

LENS SHIFT ADJUSTMENT

- 1 Press the LENS SHIFT button on the Side Control or on the Remote Control Unit. The message “Lens shift” is displayed.
- 2 Press the POINT UP button to move the image up, press the POINT DOWN button to move the image down, press the POINT LEFT to move the image left and press the POINT RIGHT to move the image right.

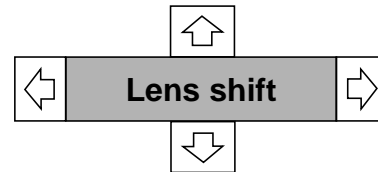

The message disappears after 4 seconds.

KEYSTONE ADJUSTMENT

If the picture has keystone distortion, correct image with KEYSTONE adjustment.

- 1 Press the KEYSTONE ▲/▼ button on the Remote Control Unit or select the Keystone on the SCREEN menu. (Refer to page 34, 38.) The message “Keystone” is displayed.
- 2 Correct the Keystone distortion by pressing the KEYSTONE ▲/▼ button or the POINT UP/DOWN button(s). Press the KEYSTONE ▲ button or the POINT UP button to reduce the upper part of the image, and press the KEYSTONE ▼ button or the POINT DOWN button to reduce the lower part.

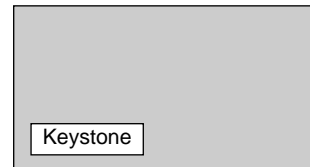

The message disappears after 4 seconds.

Reduce the upper width with the KEY STONE ▲ button or the POINT UP button.

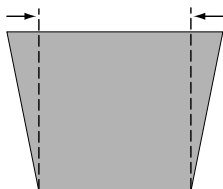

Reduce the lower width with the KEY STONE ▼ button or the POINT DOWN button.

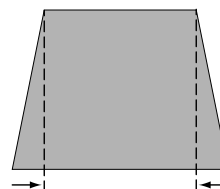

NO SHOW FUNCTION

Press the NO SHOW button on the Remote Control Unit to black out the image. This function is cancelled when the NO SHOW button is pressed again or any other function button is pressed.

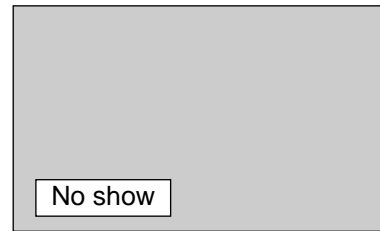

The message disappears after 4 seconds.

PICTURE FREEZE FUNCTION

Press the FREEZE button on the Remote Control Unit to freeze the picture on-screen. This function is cancelled when the FREEZE button is pressed again or any other function button is pressed.

P-TIMER FUNCTION

Press the P-TIMER button on the Remote Control unit. The timer display "00 : 00" appears on the screen and the timer starts to count the time (00 : 00 ~ 59 : 59).

To stop the P-TIMER, press the P-TIMER button. And then, press the P-TIMER button again to cancel the P-TIMER function.



SOUND ADJUSTMENT

DIRECT OPERATION

Sound Volume Adjustment

Press the VOLUME (+/-) button(s) on the Side Control or on the Remote Control Unit to adjust the volume. The Volume dialog box appears on the screen for a few seconds.

(+) button to increase the volume, and (-) button decreasing.

Sound Mute Setting

Press the MUTE button on the Remote Control Unit to cut off the sound. To restore the sound to its previous level, press the MUTE button again or press Volume (+/-) button(s).

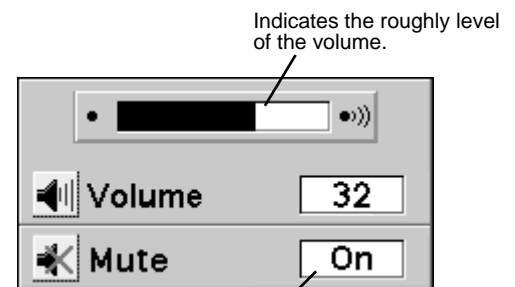

Press the MUTE button to set the Mute function On or Off.

The display disappears after 4 seconds.

MENU OPERATION

- 1 Press the MENU button and the ON-SCREEN MENU will appear. Press the POINT LEFT/RIGHT buttons to select SOUND and press the SELECT button. Another dialog box SOUND ADJUST Menu will appear.
- 2 Press the POINT DOWN button and a red-arrow icon will appear. Move the arrow to the item that you want to select by pressing the POINT UP/DOWN buttons.

Volume

Move the arrow to ▲ or ▼ of "Volume" by pressing the POINT UP/DOWN buttons. To increase the volume, point the arrow to ▲ and then press the SELECT button. To decrease the volume point the arrow to ▼ and then press the SELECT button.

Treble

To adjust the Treble sound, point the arrow to ▲ or ▼ of "Treble" and then press the SELECT button.

Bass

To adjust the Bass sound, point the arrow to ▲ or ▼ of "Bass" and then press the SELECT button.

Built-in SP.

To disconnect the built-in speaker, point the arrow to Built-in SP. and then press the SELECT button. The Built-in SP. display is changed Off from On and Internal speaker is disconnected.

Mute

To cut off the audio sound, point the arrow to "Mute" and then press the SELECT button. The Mute display is changed On from Off and the sound is cut off. To restore the sound to its previous volume level, set the Mute to Off.

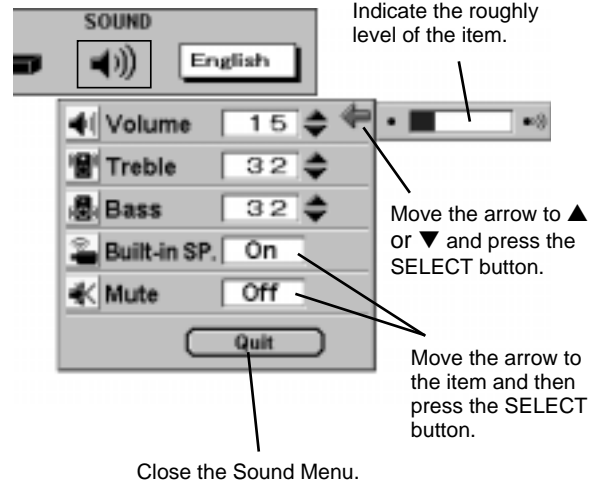

SELECTING INPUT SOURCE

DIRECT OPERATION

Select INPUT source by pressing the INPUT 1/2 and INPUT 3/4 button on the side Control or on the Remote Control Unit.

INPUT 1/2 button

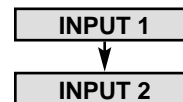

INPUT 3/4 button

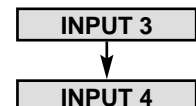

MENU OPERATION

- 1 Press the MENU button and the ON-SCREEN MENU will appear. Press the POINT LEFT/RIGHT buttons to select Input and press the SELECT button. Another dialog box INPUT SELECT Menu will appear.
- 2 Press the POINT DOWN button and a red-arrow icon will appear. Move the arrow to the INPUT source that you want to select, and then press the SELECT button.



SELECTING COMPUTER SYSTEM

WHEN SELECT THE INPUT 1 (DVI SLOT)

When connecting to the computer, select a computer signal type (Digital or Analog) in INPUT SOURCE Menu.

- 1 Press the MENU button and the ON-SCREEN MENU will appear. Press the POINT LEFT/RIGHT buttons to select INPUT SOURCE and press the SELECT button. Another dialog box INPUT SOURCE Menu will appear.
- 2 Press the POINT DOWN button and a red-arrow icon will appear. Move the arrow to the INPUT source that you want to select, and then press the SELECT button.



WHEN SELECT THE INPUT 2 (5 BNC SLOT)

When connecting to those equipment, select the type of Input source in INPUT SOURCE Menu.

- 1 Press the MENU button and the ON-SCREEN MENU will appear. Press the POINT LEFT/RIGHT buttons to select INPUT SOURCE and press the SELECT button. Another dialog box INPUT SOURCE Menu will appear.
- 2 Press the POINT DOWN button and a red-arrow icon will appear. Move the arrow to "RGB", and then press the SELECT button.



RGB

When connect the computer output [5 BNC Type (Red, Green, Blue, Horiz. Sync and Vert. Sync.)] from the computer to the R/Pr, G/Y, B/Pb, H/HV and V jacks.

AUTOMATIC MULTI-SCAN SYSTEM

This projector automatically tunes to most different types of computers based on VGA, SVGA, XGA or SXGA (refer to "COMPATIBLE COMPUTER SPECIFICATION" on page 29). When selecting Computer, this projector automatically tunes to the incoming signal and projects the proper image without any special settings. (Setting of the Computer System may be required when connecting some computers.)

Note : The projector may display one of the following messages.

Go to PC adj. The projector cannot discriminate or detect the input signal from the computer. Adjust and set the computer system manually.

No signal There is no signal input from the computer. Make sure the connection of the computer and the projector is set correctly.

D-VGA, D-SVGA, D-XGA, D-SXGA 1, D-SXGA 2 or D-SXGA 3

The input signal is digital from the DVI terminal.

CURRENT MODE DISPLAY

The Current Mode display appears to show the information of the computer being selected.

SELECT COMPUTER SYSTEM MANUALLY

To set the Computer system manually, select the mode on the ON-SCREEN MENU.

- 1 Press the MENU button and the ON-SCREEN MENU will appear. Press the POINT LEFT/RIGHT buttons to select SYSTEM and press the SELECT button. Another dialog box COMPUTER SYSTEM Menu will appear.
- 2 Press the POINT DOWN button and a red-arrow icon will appear. Move the arrow to the system that you want to set, and then press SELECT button.

SYSTEM BOX

Display the SYSTEM being selected.



When select the DVI terminal.



When select the 5 BNC terminal.



When select the HDB 15-PIN terminal.

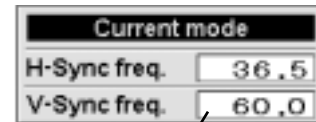

Providing the information of the computer detected by the projector.

The systems on this dialog box can be selected.

When this mark is displayed as black, more computer system modes will be available. Move the arrow to this mark and then press the SELECT button, and the other modes will be displayed.

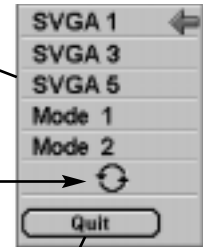

Close the SYSTEM Menu.

COMPATIBLE COMPUTER SPECIFICATIONS

Basically this projector can accept the signal from all computers with the V, H-Frequency mentioned below and less than 202 MHz of Dot Clock.

ON-SCREEN DISPLAY	RESOLUTION	H-Freq. (kHz)	V-Freq. (Hz)	ON-SCREEN DISPLAY	RESOLUTION	H-Freq. (kHz)	V-Freq. (Hz)
VGA 1	640 x 480	31.47	59.88	XGA 10	1024 x 768	62.04	77.07
VGA 2	720 x 400	31.47	70.09	XGA 11	1024 x 768	61.00	75.70
VGA 3	640 x 400	31.47	70.09	XGA 12	1024 x 768 (Interlace)	35.522	43.48
VGA 4	640 x 480	37.86	74.38	XGA 13	1024 x 768	46.90	58.20
VGA 5	640 x 480	37.86	72.81	XGA 14	1024 x 768	47.00	58.30
VGA 6	640 x 480	37.50	75.00	XGA15	1024 x 768	58.03	72.0
VGA 7	640 x 480	43.269	85.00	MAC 19	1024 x 768	60.24	75.08
MAC LC13	640 x 480	34.97	66.60	MAC 21	1152 x 870	68.68	75.06
MAC 13	640 x 480	35.00	66.67	SXGA 1	1152 x 864	64.20	70.40
RGB	(Interlace)	15.734	30	SXGA 2	1280 x 1024	62.50	58.60
RGB	(Interlace)	15.625	25	SXGA 3	1280 x 1024	63.90	60.00
480P	(Progressive)	31.47	60	SXGA 4	1280 x 1024	63.34	59.98
575P	(Progressive)	31.25	50	SXGA 5	1280 x 1024	63.74	60.01
SVGA 1	800 x 600	35.156	56.25	SXGA 6	1280 x 1024	71.69	67.19
SVGA 2	800 x 600	37.88	60.32	SXGA 7	1280 x 1024	81.13	76.107
SVGA 3	800 x 600	46.875	75.00	SXGA 8	1280 x 1024	63.98	60.02
SVGA 4	800 x 600	53.674	85.06	SXGA 9	1280 x 1024	79.976	75.025
SVGA 5	800 x 600	48.08	72.19	SXGA 10	1280 x 960	60.00	60.00
SVGA 6	800 x 600	37.90	61.03	SXGA 11	1152 x 900	61.20	65.20
SVGA 7	800 x 600	34.50	55.38	SXGA 12	1152 x 900	71.40	75.60
SVGA 8	800 x 600	38.00	60.51	SXGA 13	1280 x 1024 (Interlace)	50.00	43.00
SVGA 9	800 x 600	38.60	60.31	SXGA 14	1280 x 1024 (Interlace)	50.00	47.00
SVGA 10	800 x 600	32.70	51.09	SXGA 15	1280 x 1024	63.37	60.01
SVGA 11	800 x 600	38.00	60.51	SXGA 16	1280 x 1024	76.97	72.00
MAC 16	832 x 624	49.72	74.55	SXGA 17	1152 x 900	61.85	66.00
XGA 1	1024 x 768	48.36	60.00	SXGA 18	1280 x 1024 (Interlace)	46.43	43.35
XGA 2	1024 x 768	68.677	84.997	SXGA 19	1280 x 1024	63.79	60.18
XGA 3	1024 x 768	60.023	75.03	SXGA 20	1280 x 1024	91.146	85.024
XGA 4	1024 x 768	56.47	70.07	MAC	1280 x 960	75.00	75.08
XGA 5	1024 x 768	60.31	74.92	MAC	1280 x 1024	80.00	75.08
XGA 6	1024 x 768	48.50	60.02	HDTV720p	(Progressive)	45.00	60.00
XGA 7	1024 x 768	44.00	54.58	HDTV1035i	(Interlace)	33.75	30.00
XGA 8	1024 x 768	63.48	79.35	HDTV1080i	(Interlace)	33.75	30.00
XGA 9	1024 x 768 (Interlace)	36.00	43.59	HDTV1080i	(Interlace)	31.25	25.00

When the input signal is digital from the DVI terminal, refer to the chart below.

ON-SCREEN DISPLAY	RESOLUTION	H-Freq. (kHz)	V-Freq. (Hz)	ON-SCREEN DISPLAY	RESOLUTION	H-Freq. (kHz)	V-Freq. (Hz)
D-VGA	640 x 480	31.469	59.940	D-SXGA 1	1280 x 1024	63.981	60.020
D-SVGA	800 x 600	37.879	60.317	D-SXGA 2	1280 x 1024	60.276	58.069
D-XGA	1024 x 768	48.363	60.004	D-SXGA 3	1280 x 1024	31.65	29.8

NOTE : Specifications are subject to change without notice.

PC ADJUSTMENT

This Projector can automatically tune to the display signals from most personal computers currently distributed. However, some computers employ special signal formats which are different from the standard ones and may not be tuned by the Multi-Scan system of this projector. If this happens, the projector cannot reproduce a proper image and the image may be recognized as a flickering picture, a non-synchronized picture, a non-centered picture or a skewed picture.

This projector has a PC ADJUSTMENT function to enable you to precisely adjust several parameters to match with those special signal formats. This projector has 8 independent memory areas to memorize those parameters manually adjusted. This enables you to recall the setting for a specific computer whenever you use it.

NOTE: This PC ADJUSTMENT function cannot be operated when the input signal is digital from the DVI terminal or "RGB" is selected on the SYSTEM MENU (P28 and 29).

- 1 Press the MENU button and the ON-SCREEN MENU will appear. Press the POINT RIGHT/LEFT button to select PC ADJUST and press the SELECT button. Another dialog box "Where to reserve" Menu will appear.
- 2 In this dialog box, you can store the parameter into the area from "Mode 1" to "Mode 8." When memorizing the new computer parameter, select the Mode with the message "Free" by pressing the POINT UP/DOWN button and the SELECT button. To change the parameters of the Mode previously set, select the Mode with "Stored."
- 3 When the Mode is selected, Parameter adjustment dialog box appears. Move the arrow to the item that you want to change by pressing the POINT UP/DOWN button, and adjust each item by pressing the SELECT button to match with your computer.
- 4 Move the arrow to "Stored" and press the SELECT button. The parameter is memorized in the selected Mode.
- 5 To activate the Mode manually adjusted in this PC ADJUSTMENT Menu, select the Mode at the SYSTEM SELECT Menu. (Refer to page 28.)

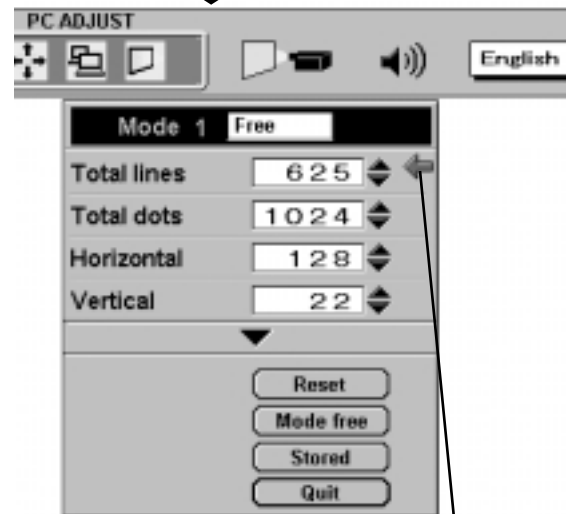
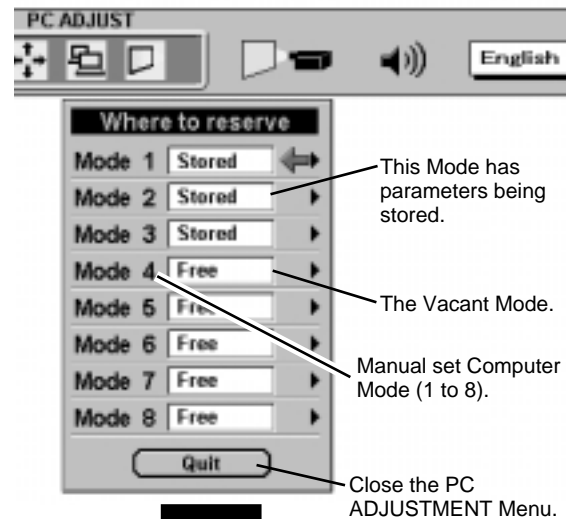

Move the arrow to ▲ or ▼ and press SELECT button.

Total lines

The number of the total vertical lines. Adjust the number to match the image of your personal computer.

Total dots

The number of the total dots in one horizontal period. Adjust the number to match the image of your computer.

Horizontal / Vertical

Adjustment of the horizontal or vertical picture position. When the image is not centered on the screen, adjust each of those items.

Clamp

Adjustment of the clamp level. When the image has a dark bar(s), try this adjustment.

Fine sync

Adjust the picture as necessary to eliminate flicker from the display.

Display area

Adjustment of the area displayed with this projector. Select the resolution at the Display area dialog box, or adjust the number at the column of "H" or "V" to match the resolution of the image.

Horizontal Scale / Vertical Scale

Adjustment of the horizontal height or vertical width of the image.

NOTE : The Display area, the Horiz. scale and the Vert. scale cannot be adjusted when "480p", "575p", "HDTV720p", "HDTV1035i" or "HDTV1080i" is selected on the SYSTEM MENU (P28 and 29).

Each of the keys operates as follow.

Reset Recalls the parameter data that was previously adjusted.

Mode free Clears the parameter data previously set.

Stored Stores the parameters in the memory.

Quit Closes the PC ADJUST Menu.

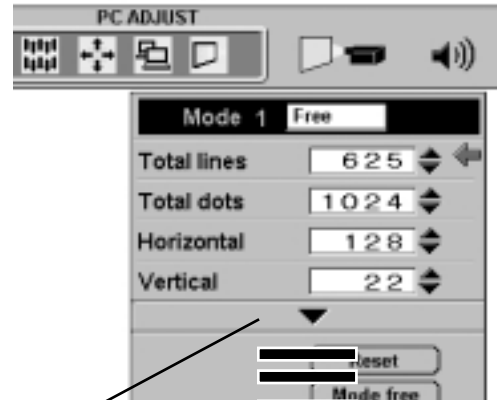

Press the SELECT button at this column to adjust "Clamp", "Fine sync," "Display area", "Horiz. scale" or "Vert. scale".

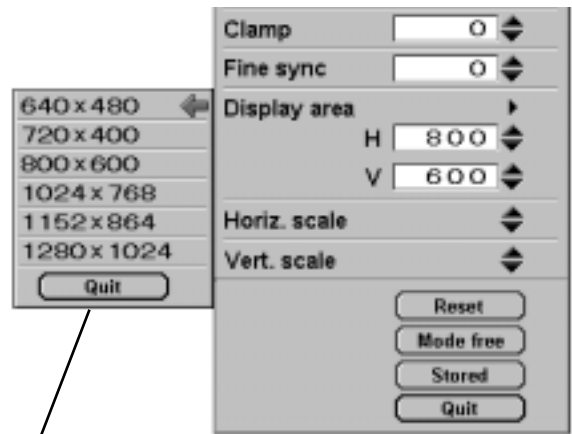

Point the arrow at the Display area and press the SELECT button. The Display area dialog box appears.

PICTURE IMAGE ADJUSTMENTS

- 1 Press the MENU button and the ON-SCREEN MENU will appear. Press the POINT LEFT/RIGHT buttons to select IMAGE and press the SELECT button. Another dialog box PICTURE IMAGE ADJUSTMENT Menu will appear.
- 2 Press the POINT DOWN button and a red-arrow icon will appear. Move the arrow to the function that you want to select and then press SELECT button.

Standard

Normal picture level preset on this projector. This picture level can be set by pressing the NORMAL button.

Real

Picture level adjusted for the picture with fine tone.

Custom

Picture level adjusted manually in the custom setting dialog box.

When selecting “▼” the custom setting dialog box will appear. Move the arrow to the item that you want to change by pressing the POINT UP/DOWN button, and adjust each value by pressing the SELECT button to match with the image.

Fine sync

Adjust the picture as necessary to eliminate flicker from the display. (From 0 to 255.)

Total dots

The number of the total dots in one horizontal period. Adjust the number to match your PC image.

White balance (Red / Green / Blue)

Move the arrow to the color that you want to adjust. Point to ▼ to lighten the color and select ▲ to deepen the color. (From 0 to 63.)

Contrast

Point to ▼ to decrease contrast, and select ▲ to increase contrast. (From 0 to 63.)

Brightness

Point to ▼ to adjust the image darker, and select ▲ to adjust brighter. (From 0 to 63.)

Sharpness

Point to ▼ to soften the image, and select ▲ to sharpen the image. (From 0 to 15.)

Gamma

Point to ▼ or ▲ to obtain better balance of contrast. (From 0 to 16.)

Progressive

Set “On” to provide progressive scan mode.

Each of the keys operates as follow.

- Reset** Recalls the data previously adjusted.
- Stored** Stores the adjusted data in the memory.
- Quit** Closes the PICTURE IMAGE ADJUSTMENT Menu.

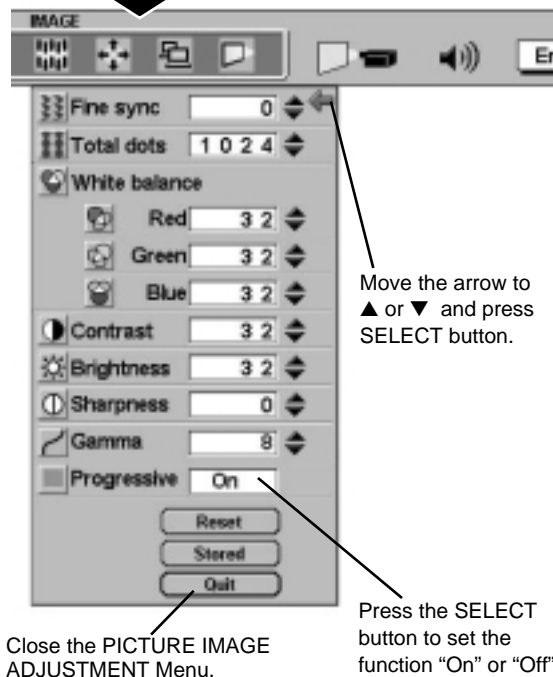
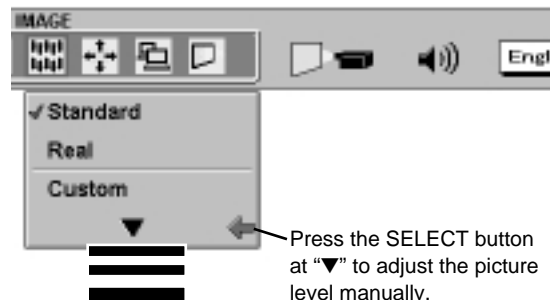
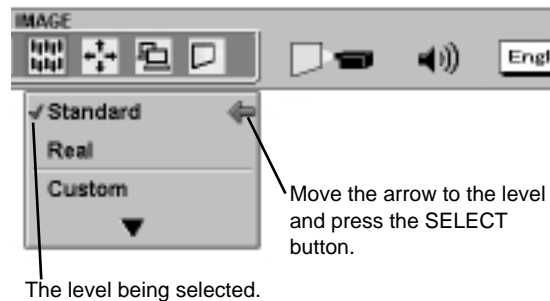

NOTE : The Fine sync and the Total dots cannot be operated when the input signal is digital from DVI terminal or “RGB” is selected on the SYSTEM MENU (P28 and 29). The Progressive cannot be selected when the input signal is digital from DVI terminal or “480p”, “575p” or “HDTV720p” is selected on the SYSTEM MENU (P28 and 29).

NORMAL FUNCTION

The normal picture level is preset on this projector at the factory and can be restored anytime you press the NORMAL button (located on the Side Control or on the Remote Control Unit). The "Standard" display will be displayed on the screen for a few seconds.



PICTURE POSITION ADJUSTMENT

The position of the image can be adjusted vertically and horizontally through PICTURE POSITION ADJUSTMENT.

- 1 Press the MENU button and the ON-SCREEN MENU will appear. Press the POINT LEFT/RIGHT buttons to select POSITION and press the SELECT button. The PICTURE POSITION dialog box will appear.
- 2 Select the arrow to the direction (described as \leftarrow , \rightarrow , \uparrow or \downarrow) that you want to adjust by pressing the POINT UP/DOWN/LEFT/RIGHT buttons, and then press the SELECT button.

Each of the keys operates as follow.

Reset Recalls the setting data previously set.

Stored Stores the setting data in the memory.

Quit Closes the PICTURE POSITION Menu.

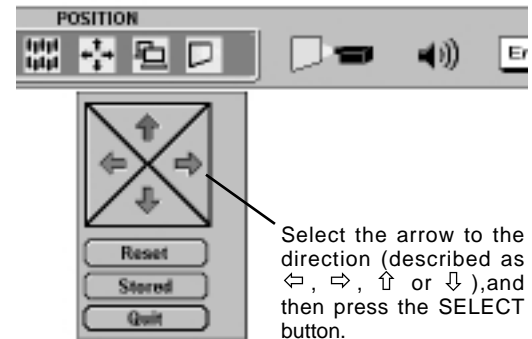

AUTO IMAGE FUNCTION

The AUTO IMAGE function cannot be operated when the input signal is digital from DVI terminal or "RGB", "480p", "575p", "HDTV720p", "HDTV1035i" or "HDTV1080i" is selected on the SYSTEM SELECT menu.

Press the AUTO IMAGE button on the Side Control or on the Remote Control Unit to automatically adjust Fine sync., Total dots and Screen position for most computers. It will take about 10 seconds.

NOTE: Some computers may not be fully adjusted with the "Auto Image Function". In that case, use the "Picture Image" and/or "Picture Position" adjustments (P32, 33) "Auto Image Function" is executed.

PICTURE SCREEN ADJUSTMENT

This projector has a picture screen resize function, which enables you to display the desirable image size.

- 1 Press the MENU button and the ON-SCREEN MENU will appear. Press the POINT LEFT/RIGHT buttons to select SCREEN and press the SELECT button. Another dialog box PICTURE SCREEN Menu will appear.
- 2 Press the POINT DOWN button and a red-arrow icon will appear. Move the arrow to the function that you want to select and then press SELECT button.

True

To make the image into its original size, select True in the dialog box. When the original image size is larger than the screen size (1024 x 768), the image can be panned by pressing the POINT UP/DOWN/LEFT/RIGHT buttons.

Keystone

When the image is distorted vertically, select Keystone in the dialog box. The ON-SCREEN menu and SCREEN ADJUST menu disappears and the message "Keystone" is displayed. Correct the Keystone distortion by pressing the KEYSTONE ▲/▼ button or the POINT UP/DOWN button(s). Refer to KEYSTONE ADJUSTMENT on page 24.

Digital Zoom

To adjust the image size or pan the image, select Digital zoom in the dialog box. The ON-SCREEN menu and SCREEN ADJUST menu disappears, and the magnifying glass icon and the message "D. Zoom" is displayed.

This projector also enters Digital Zoom mode by pressing the D.ZOOM ▲/▼ button on the Remote Control Unit.

Refer to the following for operation.

Expand function

To expand the image size, press the D.ZOOM ▲ button or the SELECT button. The image is magnified by degrees.

Compress function

To compress the image size, press the D.ZOOM ▼ button or the RIGHT CLICK button. The size of image is reduced by degrees.

Panning function

To pan the image, press the POINT UP/DOWN/LEFT/RIGHT buttons. Panning function can work only when the image is larger than the screen size.

To cancel Digital Zoom mode, press any button except D.ZOOM ▲/▼, SELECT, RIGHT CLICK, or POINT button. To adjust the image to 1024 x 768, press NORMAL button.

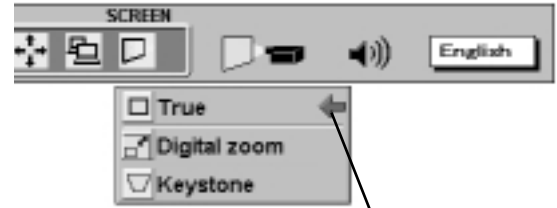

Move the arrow to the function and press the SELECT button.

NOTE

- The True and the Digital Zoom cannot be operated when "RGB", "480p", "575p", "HDTV720p", "HDTV1035i" or "HDTV1080i" is selected on the SYSTEM MENU (P28 and 29).
- This projector cannot display any resolution higher than 1280 X 1024. If your computer's screen resolution is higher than 1280 X 1024, reset the resolution to the lower before connecting the projector.
- The image data in other than XGA (1024 x 768) is modified to fit the screen size in the initial mode.
- The normal "Panning Operation" may not function properly if the computer system prepared with the "PC Adjust" is used.

SELECTING VIDEO SOURCE

WHEN SELECT THE INPUT 2 (5 BNC TERMINAL)

When connecting to those equipment, select the type of Input source in INPUT SOURCE Menu.

- 1 Press the MENU button and the ON-SCREEN MENU will appear. Press the POINT LEFT/RIGHT buttons to select INPUT SOURCE and press the SELECT button. Another dialog box INPUT SOURCE Menu will appear.
- 2 Press the POINT DOWN button and a red-arrow icon will appear. Move the arrow to "Y, Pb/Cb, Pr/Cr" and then press the SELECT button.

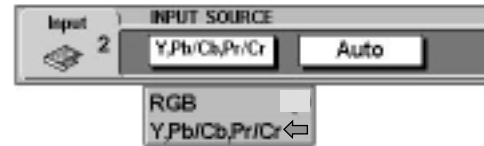

Y, Pb/Cb, Pr/Cr

When connect the component video output (Cr, Y, Cb or Pr, Y, Pb) from the video equipment to the R/Pr, G/Y and B/Pb jacks.

WHEN SELECT THE INPUT 3 (AV TERMINAL)

When connecting to those equipment, select the type of Video source in VIDEO SOURCE Menu.

- 1 Press the MENU button and the ON-SCREEN MENU will appear. Press the POINT LEFT/RIGHT buttons to select VIDEO SOURCE and press the SELECT button. Another dialog box VIDEO SOURCE Menu will appear.
- 2 Press the POINT DOWN button and a red-arrow icon will appear. Move the arrow to the source that you want to select, and then press the SELECT button.

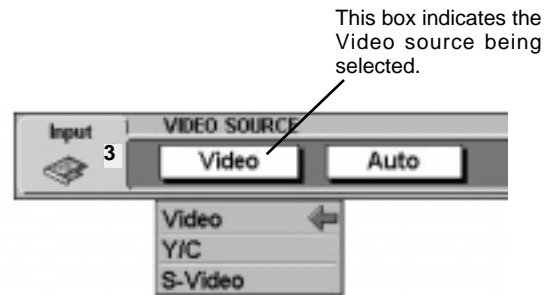

Video When connect the composite video output from the video equipment to the VIDEO/Y jack, select "Video" in VIDEO SOURCE Menu.

Y/C When connect the separate Y/C video output from the video equipment to the VIDEO/Y and C jacks, select "Y/C" in VIDEO SOURCE Menu.

S-Video When connect the S-Video output from the video equipment to the S-Video jack, select "S-Video" in VIDEO SOURCE Menu.

SELECTING COLOR SYSTEM

- 1 Press the MENU button and the ON-SCREEN MENU will appear. Press the POINT LEFT/RIGHT buttons to select SYSTEM and press the SELECT button. Another dialog box VIDEO SYSTEM Menu will appear.
- 2 Press the POINT DOWN button and a red-arrow icon will appear. Move the arrow to "Auto", and then press the SELECT button.

WHEN SELECT THE INPUT 3 (AV TERMINAL)

Auto

The projector automatically detects the incoming Video system, and adjusts itself to optimize its performance. When the Video System is PAL-M or PAL-N, select the system manually.

PAL / SECAM / NTSC / NTSC4.43 / PAL-M / PAL-N

If the projector cannot reproduce the proper video image, it is necessary to select a specific broadcast signal format among PAL, SECAM, NTSC, NTSC 4.43, PAL-M, and PAL-N.

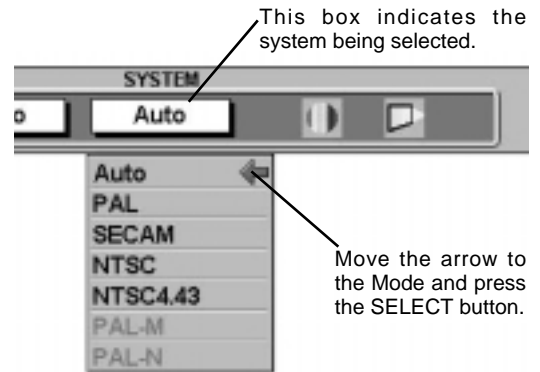

WHEN SELECT THE INPUT 2 (5 BNC TERMINAL)

Auto

The projector automatically detects the incoming Video signal, and adjusts itself to optimize its performance.

COMPONENT VIDEO SIGNAL FORMAT

If the projector cannot reproduce the proper video image, it is necessary to select a specific component video signal format among 480i, 575i, 480p, 575p, 720p, 1035i, 1080i-50 and 1080i-60.

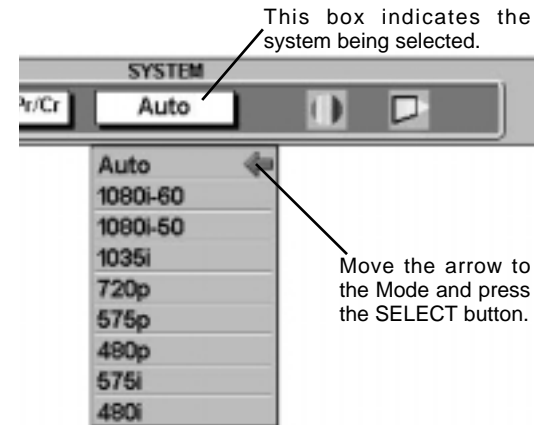

PICTURE IMAGE ADJUSTMENT

- 1 Press the MENU button and the ON-SCREEN MENU will appear. Press the POINT LEFT/RIGHT buttons to select IMAGE and press the SELECT button. Another dialog box PICTURE IMAGE ADJUSTMENT Menu will appear.
- 2 Press the POINT DOWN button and a red-arrow icon will appear. Move the arrow to the function that you want to select and then press SELECT button.

Standard

Normal picture level preset on this projector. This picture level can be set by pressing the NORMAL button.

Cinema

Picture level adjusted for the picture with fine tone.

Custom

Picture level adjusted manually in the custom setting dialog box.

When selecting “▼” the custom setting dialog box will appear. Move the arrow to the item that you want to change by pressing the POINT UP/DOWN button, and adjust each value or change the setting On or Off by pressing the SELECT button to match with the image.

Color

Point to ▼ button to lighten the image, and select ▲ to deepen the image. (From 0 to 63.)

Tint

Point to ▼ button to increase purple, and select ▲ to increase green. (From 0 to 63.)

White balance (Red / Green / Blue)

Move the arrow to the color that you want to adjust. Point to ▼ to lighten the color and select ▲ to deepen the color. (From 0 to 63.)

Contrast

Point to ▼ button to decrease contrast, and select ▲ to increase contrast. (From 0 to 63.)

Brightness

Point to ▼ button to darken the image, and select ▲ to brighten the image. (From 0 to 63.)

Sharpness

Point to ▼ button to soften the image, and select ▲ to sharpen the image. (From 0 to 31.)

Gamma

Point to ▼ or ▲ to obtain better balance of contrast. (From 0 to 16.)

Noise reduction

Set “On” to reduce the noise (rough parts) of the image.

Progressive

Set “On” to provide progressive scan mode.

Each of the keys operates as follow.

Reset Recalls the data previously adjusted.

Stored Stores the data in the memory.

Quit Closes the PICTURE IMAGE ADJUSTMENT Menu.

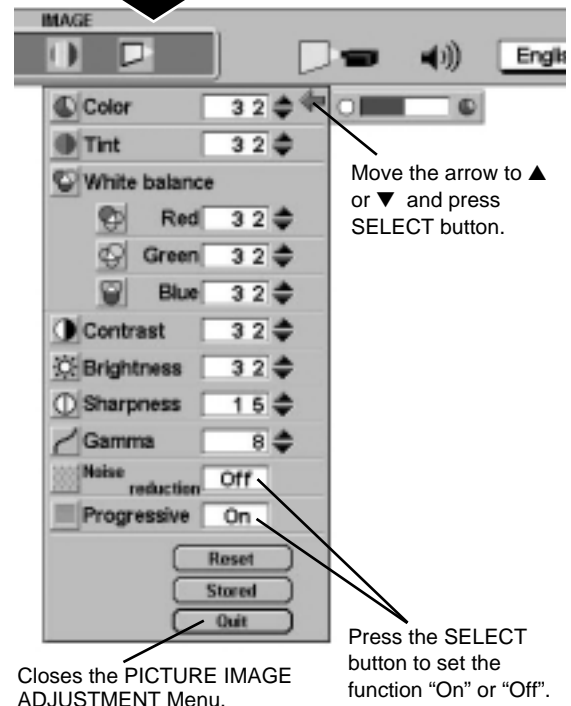
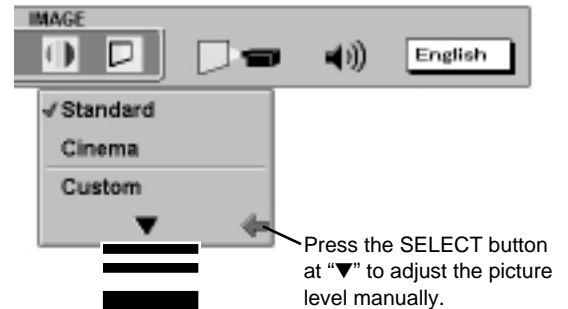
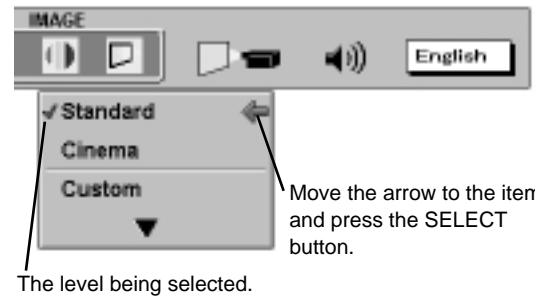

NOTE :

The Noise Reduction cannot be operated when the video signal types and systems as follow.

- Composite video signal (SECAM, NTSC4.43, PAL-M and PAL-N systems).
- Y/C separate video and S-video signal (SECAM, PAL-M and PAL-N systems).
- Component video signal.

The Progressive cannot be operated when “480p”, “575p” or “720p” is selected on the SYSTEM MENU (P36).

NORMAL FUNCTION

The normal picture level is preset on this projector at the factory and can be restored anytime you press the NORMAL button (located on the Side Control or on the Remote Control Unit). The "Standard" display will be displayed on the screen for a few seconds.

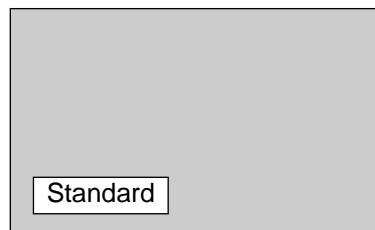

PICTURE SCREEN ADJUSTMENT

This projector has a picture screen resize function, which enables you to display the desirable image size.

- 1 Press the MENU button and the ON-SCREEN MENU will appear. Press the POINT LEFT/RIGHT buttons to select SCREEN and press the SELECT button. Another dialog box PICTURE SCREEN ADJUSTMENT DISPLAY will appear.
- 2 Press the POINT DOWN button and a red-arrow icon will appear. Move the arrow to the screen size that you want to set, and then press the SELECT button.

Regular

Normal Video Image size with 4 x 3 aspect ratio.

Wide

Resizes the image for wide screen size with 16 x 9 aspect ratio.

Keystone

When the image is distorted vertically, select Keystone in the dialog box. Correct the Keystone distortion by pressing KEYSTONE ▲/▼ button or POINT UP/DOWN button(s). Refer to KEYSTONE ADJUSTMENT on page 24.

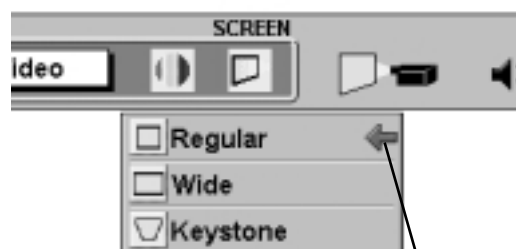

Move the pointer to the function and press the SELECT button.

NOTE : The Regular and the Wide cannot be operated when "720p", "1035i", "1080i-50" or "1080i-60" is selected on the SYSTEM MENU (P36).

SETTING MENU

- 1 Press the MENU button and the ON-SCREEN MENU will appear. Press the POINT LEFT/RIGHT buttons to select SETTING and press the SELECT button. Another dialog box SETTING Menu will appear.
- 2 Press the POINT DOWN button and a red-arrow icon will appear. Move the arrow to the item that you want to set, and then press the SELECT button to set it (For example "On" or "Off").

Blue back

When this function is "On" this projector will produce a blue image instead of the video noise on the screen when the input source is unplugged or turned off.

Display

This function decides whether to display the On-Screen Displays.

On1 ... shows all the On-Screen Displays.

On2 ... shows the On-Screen Displays except the Preparation Display (Our Logo).

Off sets the On-Screen Displays disappeared except;

- ON SCREEN MENU
- "Power off?" message
- P-TIMER

Ceiling

When this function is "On" the top / bottom and the left / right reversed picture is provided to project the image from a ceiling mounted projector.

Rear

When this function is "On" the left / right reversed picture is provided to project the image to a rear projection screen.

Split wipe

Turn this function "On" in the SETTING menu. The picture will change into next one by sliding black image side ways like drawing the black curtains when the input source is turned into another one.

Power management

This function turns the Projection Lamp off when the projector detects signal interruption and the projector is not used for a certain period in order to reduce power consumption and maintain the Lamp-life. (This projector is shipped with this function ON.)

Power Management function operates to turn the Projection Lamp off when the input signal is interrupted and the projector is not operated over 5 minutes. This function operates as follows;

1. When the signal is interrupted, "No signal" and the counting down (5 minutes) display appears.
2. When the Projection Lamp turned off, the READY indicator turns off.
3. After 90 seconds, the READY indicator flashes and the Lamp can be turned on again (Power Management mode).

In this Power Management mode, the Projection Lamp is automatically turned on when the input signal connected or the projector is operated with any button on the Side Control or the Remote Control.



Set the Pointer to the item and press the SELECT button.

Ceiling function

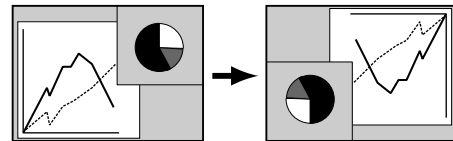

Rear function

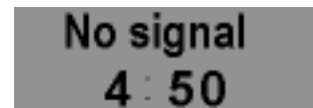
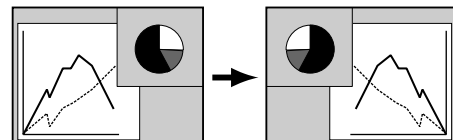

Time left until Lamp off.

On start

When this function is "On" the projector is automatically turned on just by switching the MAIN ON / OFF SWITCH on.

NOTE: Be sure to turn the projector off properly (refer to the section "TURNING OFF THE PROJECTOR" on page 23). If the projector is turned off in the wrong steps, the On Start function does not operate properly.

Lamp Mode

This Projector is equipped with 4 Projection Lamps and the number of using lamps can be switched to 4 lamps or 2 lamps. Using 2 lamps maintains the life of the Projection Lamps.

To change over Lamp Mode

1. Press the MENU button the ON-SCREEN MENU will appear. Press the POINT LEFT/RIGHT buttons to select SETTING and press the SELECT button. Another dialog box SETTING MENU will appear.
2. Press the POINT DOWN button and move a red-arrow icon to Lamp Mode. Set "4 lamps mode" or "2 lamps mode" by pressing the SELECT button. When Lamp Mode is set from "4 lamps mode" to "2 lamps mode," the image becomes little darker. When Lamp Mode is set from "2 lamps mode" to "4 lamps mode," the image become brighter gradually.

NOTE : After changing Lamp Mode, it cannot be switched again for 90 seconds.

USB

This Projector is equipped with USB port for interactive operation between the projector and the computer. Set the mode following steps below.

Wireless Mouse mode

Select "  " when controlling the computer with the Remote Control of this projector.

Projector mode

Select "  " when controlling the projector with the computer.

NOTE: Before you control the projector by computer, install USB driver (optionally sold parts) and set up the computer following instruction in the USB driver package. Contact your authorized dealer.

Remote control

This projector has two different remote transmit codes; the factory-set normal code (Mode 1) and the secondary code (Mode 2). This switching function prevents the remote control operation mixture (jam) when operating several projectors or video equipment together.

When operating the projector in "Mode 2" both projector and Remote Control must be switched to "Mode 2".

To change the code of the projector;

Set the Remote control in the SETTING menu to "Mode 2".

To change the code of the Remote Control;

Press both the MENU and the NORMAL buttons on the Remote Control together for over 10 seconds.

After changing the code, make sure the Remote Control operates properly.

To return to the normal code (Mode 1), operate both projector and Remote Control in the ways above again.

NOTE: When the ALL-OFF switch on the Remote Control Unit is turned to "ALL-OFF" the remote transmit code automatically returns to the normal code (Mode 1).

Lamp replacement monitor timer

Be sure to reset the Lamp Replacement Monitor Timer when the Lamp Assembly is replaced. When the Lamp Replacement Monitor Timer is reset, the LAMP REPLACEMENT indicator stops lighting.

- 1 Turn the projector on, and press the MENU button and the ON-SCREEN MENU will appear. Press the POINT LEFT/RIGHT buttons to select SETTING and press the SELECT button. Another dialog box SETTING MENU will appear.
- 2 Press the POINT DOWN button and a red-arrow icon will appear. Move the arrow to "Lamp age" and then press the SELECT button.
- 3 Move the arrow to replaced lamp number and then press the SELECT button. The message "Lamp replace monitor Reset?" is displayed.

NOTE: Be sure to reset correct lamp number otherwise LAMP REPLACEMENT indicator continues lighting.

- 4 Select [Yes] to reset the Timer.

Do not reset the Lamp Replacement Monitor Timer, except after the lamp is replaced.

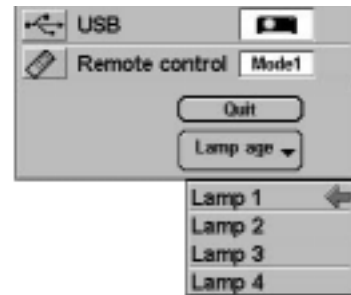
**SELECTING LANGUAGE**

The language used in the ON-SCREEN MENU is selectable from among English, German, French, Italian, Spanish and Japanese.

- 1 Press the MENU button and the ON-SCREEN MENU will appear. Press POINT LEFT/RIGHT buttons to select LANGUAGE and press the SELECT button. Another dialog box LANGUAGE Menu will appear.
- 2 Press the POINT DOWN button and a red-arrow icon will appear. Move the arrow to the language that you want to set, and then press the SELECT button.



Move the Pointer to the language that you want to set, and then press the SELECT button.

OPERATING WIRELESS MOUSE

The Wireless Remote Control Unit is not only able to operate the projector but also usable as a wireless mouse for most Personal Computers. The POINT buttons and the two CLICK buttons are used for the wireless mouse operation.

The wireless mouse is available only when PC mouse pointer is displayed on the screen. When the menu or the indicator of the projector is displayed on the screen instead of the PC mouse pointer, the wireless mouse cannot be used.

INSTALLATION

To use the Wireless Remote Control Unit as the Wireless Mouse for a Personal Computer, installation of the mouse driver (not supplied) is required. Make sure that the mouse driver is properly installed in your computer. And make sure that the mouse port of the computer connected to Control Port is activated.

- 1 Connect the mouse port of your computer to the Control Port of the projector with the Control Cable. (Refer to page 12 to 15 for connection.)
- 2 Turn the projector on first, and then turn on your computer. When the computer is switched on first, the Wireless Mouse may not work properly.

Note : When the computer has no mouse port, connect the Serial Port of the computer to Control Port of the projector with the Control Cable for Serial Port.

USING USB TERMINAL

USB Terminal can be also used as control port for wireless mouse operation. Connect the USB terminal of the computer to USB terminal of this projector with the USB cable (not supplied). In this operation, selecting Wireless Mouse Mode on SETTING Menu is required. (Refer to P40).

OPERATING WIRELESS MOUSE

When controlling the pointer of the computer, operate the Wireless Mouse with POINT button, SELECT button, and RIGHT CLICK button on the Wireless Remote Control Unit.

POINT button

Used to move the pointer. The pointer is moved corresponding with the direction you are pressing.

SELECT (LEFT CLICK) button

This button has the same function as the left button in a PC mouse.

RIGHT CLICK button

This button has the same function as the right button in a PC mouse. Pressing this button does not affect any operation when in Menu mode.

POINT button (Move the pointer)

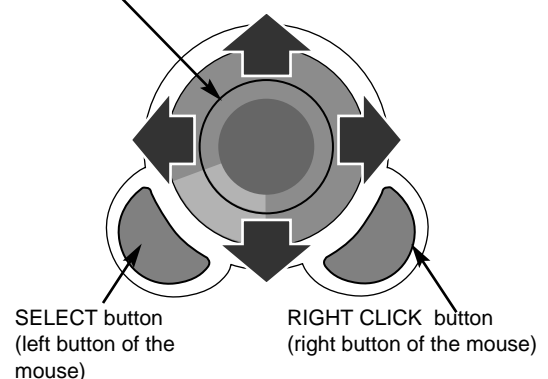

MAINTENANCE

TEMPERATURE WARNING INDICATOR

The TEMPERATURE WARNING Indicator flashes red when the internal temperature of the projector exceeds the normal temperature. The Indicator stops flashing when the temperature of the projector returns to normal. When the TEMPERATURE WARNING Indicator continues to flash, check the items listed below.

- 1** The Ventilation slots of the projector may be blocked. In such an event, reposition the appliance so that the ventilation slots are not obstructed.
- 2** Air filters may be clogged with dust particles. Clean the air filters by following the section AIR FILTER CARE AND CLEANING below.
- 3** If the TEMPERATURE WARNING Indicator remains on after performing the above checks, the Cooling Fans or the Internal Circuits may be malfunctioning. Contact service a personnel from an authorized dealer or service station.

AIR FILTER CARE AND CLEANING

The Removable Air Filter prevents dust from accumulating on the surface of the Projection Lens and the Projection Mirror. Should the Air Filter become clogged with dust particles, it will reduce the Cooling Fans' effectiveness and may result in internal heat build up and adversely affect the life of the projector. Clean the Air Filter following the steps below:

- 1** Turn the power off, and disconnect the AC power cord from the AC outlet.
- 2** Pull out the air filter from the projector.
- 3** Pulling up the center frame of the air filter top, separate the air filter top and sponge from the air filter base.
- 4** Clean the each parts with brush or wash out the dust and particles. Be sure to dry them out.
- 5** Assemble the sponge and the air filter and replace the air filter to the projector.



CAUTION

Do not operate the projector with the Air Filter removed. Dust may accumulate on the LCD Panel and the Mirror degrading picture quality.

Do not put small parts into the Air Intake Vents. It may result in malfunction of the projector.

RECOMMENDATION

We recommend avoiding dusty/smoky environments when operating the projector. Usage in these environments may cause poor image quality.

When using under dusty or smoky conditions, dust may accumulate on the liquid crystal panel, lens, or optical elements inside it. This condition may degrade the quality of the projected image.

When the above symptoms are noticed, contact your authorized dealer or service station for proper cleaning.

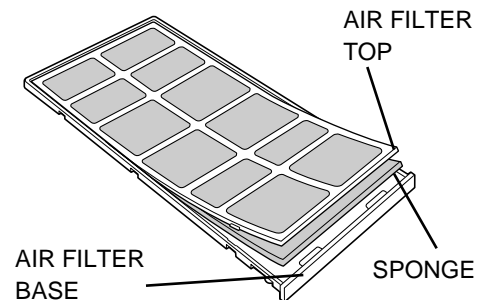
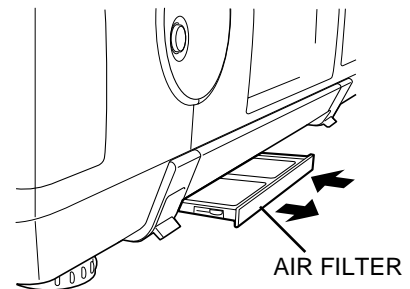

LAMP MANAGEMENT

This Projector is equipped with 4 Projection Lamps to ensure brighter image and those lamps are controlled by Lamp Management Function. Lamp Management Function detects the status of all lamps and shows the status on screen or on the LAMP REPLACE indicator. This function also automatically controls the Lamp Mode when any of lamps is out for the end of life or malfunctions.

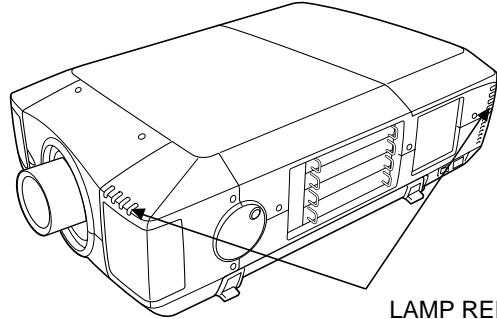

LAMP REPLACE INDICATOR

Lamp Replace Indicator

This LAMP REPLACE indicator lights yellow when any of Projection Lamps is nearing its end, and flashes when any of them becomes out. Check the number of the lamp on Lamp Status Display and replace the lamp.

Lamp Status Display

Lamp Status Display appears on the screen when power switch is on or Menu Bar is displayed. This shows the status of each lamp as; ON, OFF, NEAR END, or OUT. Refer to the following for each status.

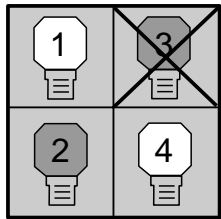

LAMP STATUS DISPLAY

Yellow Lamp ----- The Projection Lamp lights normally.

Dim Lamp ----- The Projection Lamp is turned off.

Red Lamp ----- The Projection Lamp is nearing its end. When the image becomes darker or the color becomes unnatural, replace the lamp. (The LAMP REPLACE indicator lights yellow.)

X Mark on Lamp ----- The Projection Lamp is out and needs to be replaced. (The LAMP REPLACE indicator flashes yellow.)

Lamp Mode Changeover

Lamp Management Function automatically changes the combination of lighting lamp (Lamp Mode) by detecting the status of lamp. When any of 4 lamps becomes out, the Lamp Mode is changed over from 4 lamps to 2 lamps. And when any of 2 lamps are out, the projector operates with 1 lamp. Lamp Mode can be switched to 4 lamps or 2 lamps manually. Refer to SETTING section on page 39, 40.

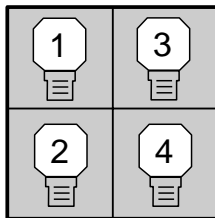

4 LAMP MODE

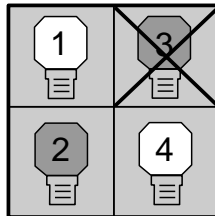

2 LAMP MODE
(Example)

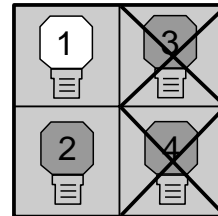

1 LAMP MODE
(Example)

LAMP REPLACEMENT



CAUTION

- For continued safety, replace with a lamp assembly of the same type.
- Allow the projector to cool for at least 45 minutes before you open the lamp cover. The inside of the projector can become very hot.
- Do not drop the lamp assembly or touch the glass bulb! The glass can shatter and may cause injury.

Follow these steps to replace the lamp assembly.

- 1** Check the number of lamp to be replaced on Lamp Status Display.
- 2** Turn off the projector and disconnect the AC Power Cord. Allow the projector to cool down for at least 45 minutes.
- 3** Remove the two screws on the Lamp Cover and press the button to open the Lamp Cover. (See right figure.)
- 4** Loosen the two screws and pull out the Lamp Assembly to be replaced by grasping the handle.
- 5** Replace the Lamp Assembly with a new one and tighten the two screws. Make sure the Lamp is set properly
- 6** Replace the Lamp Cover and tighten the two screws.
- 7** Connect the AC Power Cord to the projector and turn the projector on.
- 8** Reset the Lamp Replacement Monitor Timer. (Refer to the section "Lamp Replacement Monitor Timer" on page 41.)

NOTE : Do not reset the LAMP REPLACEMENT MONITOR TIMER when the lamp is not replaced.

CAUTION : Do not operate the projector while any of lamps is removed. It may result in malfunctions, fire hazard, or other accidents.

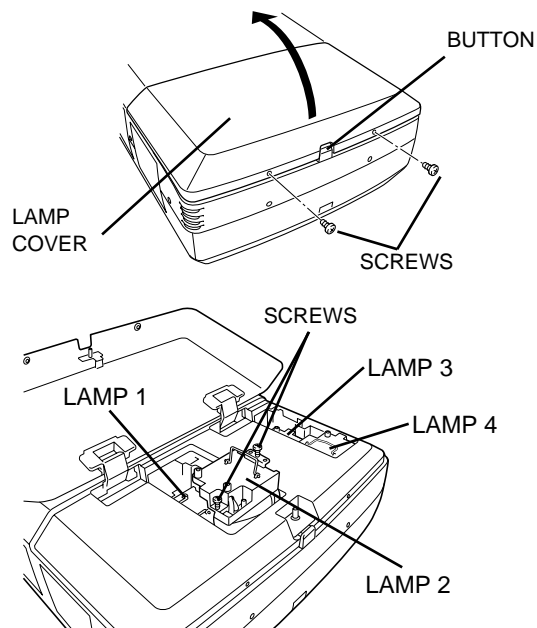

Make sure which number of lamp needs to be replaced on Lamp Status Display. Figure shows the case of replacing the LAMP 2.

ORDER REPLACEMENT LAMP

Replacement Lamp can be ordered through your dealer. When ordering the Lamp, give the following information to the dealer.

- Model No. of your projector : PLC-XF20
- Replacement Lamp Type No. : POA-LMP29
(Service Parts No. 610 284 4627)

CLEANING THE PROJECTION LENS

Follow these steps to clean the projection lens:

- 1** Apply a non-abrasive camera lens cleaner to a soft, dry cleaning cloth. Avoid using an excessive amount of cleaner. Abrasive cleaners, solvents or other harsh chemicals might scratch the lens.
- 2** Lightly wipe the cleaning cloth over the lens.
- 3** When the projector is not in use, replace the lens cover.

TROUBLESHOOTING

Before calling your dealer or service station for assistance, check the items below once again.

1. Make sure you have connected the projector to your equipment as described in section "CONNECTING THE PROJECTOR" on pages 12 ~ 15.
2. Check cable connections. Verify that all computer, video and power cords are properly connected.
3. Verify that power is switched on.
4. If the projector still does not display an image, re-start the computer.
5. If the image still does not display, unplug the projector from the computer and check the computer monitor's display. The problem may be with your graphics controller rather than with the projector. (When you reconnect the projector, remember to turn the computer and monitor off before you power up the projector. Power the equipment back up in order of: Projector and computer)
6. If the problem still exists, check the following chart.

Problem:	Try these Solutions:
No power.	<ul style="list-style-type: none"> ● Plug the projector into an AC outlet. ● Turn the MAIN ON/OFF switch to ON. ● Press the POWER ON/OFF switch to ON. ● Be sure the READY INDICATOR light is ON. ● Wait 90 seconds after the projector is turned OFF before turning the projector back on. <p>NOTE: After pressing the POWER ON/OFF button to OFF. The projector functions as indicated.</p> <ol style="list-style-type: none"> 1. The LAMP POWER indicator will light and the READY indicator will turn off. 2. After 90 seconds, the READY indicator will light green again and the projector may be turned on by pressing the POWER ON/OFF button. <ul style="list-style-type: none"> ● Check temperature warning indicator. If the indicator flashes red, the projector cannot be turned on. (See "BASIC OPERATION" section on page 23). ● Check the projection lamp. ● Replace the lamp cover. (Check the interlock switch inside of the lamp cover.)
Image is out of focus.	<ul style="list-style-type: none"> ● Adjust the focus. ● Check the projection lens to see if it needs cleaning. <p>NOTE: Moving the projector from a cool temperature location to a warm temperature location may result in moisture condensation on the lens. In such an event, leave the projector OFF and wait until condensation disappears.</p>

Problem:	Try these Solutions:
Picture is L/R Reversed.	Check Ceiling/Rear feature. (See "SETTING" section on page 39).
Picture is T/B inverted.	Check Ceiling feature. (See "SETTING" section on page 39).
Some displays are not seen during the operation.	Check Display feature. (See "SETTING" section on page 39).
No sound.	<ul style="list-style-type: none"> ● Check audio cable connection from audio input source. ● Adjust audio source. ● Press the VOLUME (+) button. ● Press the MUTE button.
Remote control unit does not work.	<ul style="list-style-type: none"> ● Check the batteries. ● Make sure nothing is blocking between the remote control sensor and remote control unit. ● Make sure you are not too far from the projector when using the remote control unit. Maximum operate range 16.4 ' (5 m). ● Check the ALL-OFF switch on the Remote Control Unit is set to "ON". ● Check the transmitted signal mode from the remote control unit. (See "SETTING" section on page 39, 40).
Wireless mouse function does not work.	<ul style="list-style-type: none"> ● Check the cable connection between the projector and the computer. ● Check the mouse setting on your computer. ● Turn on the projector before you turn on the computer.

SERVICE

WARNING: High voltages are used to operate this projector. Do not attempt to open the cabinet.

You can often correct operating problems yourself. If the projector fails to work properly, see "TROUBLESHOOTING" section on page 46, 47. To correct the failure, try the "Solutions".

If after following all operating instructions, you find that service is necessary, contact the Sanyo Service Station or the store where you purchased the unit.

Give the model number and explain the difficulty. We will advise you how to obtain service.



This symbol on the nameplate means the product is Listed by Underwriters Laboratories Inc. It is designed and manufactured to meet rigid U.L. safety standards against risk of fire, casualty and electrical hazards.



The CE Mark is a Directive conformity mark of the European Community (EC).

TECHNICAL SPECIFICATIONS

Projector Type	Multi-media Projector
Dimensions (W x H x D)	22.9" (581 mm) x 10" (252 mm) x 30.9" (783 mm)
Net Weight	78.4 lbs (35.5 kg)
LCD Panel System	1.8" TFT Active Matrix type x 3 panels
Number of Pixels	2,359,296 {786,432 (1,024 x 768) x 3}
Color System	6 color system (PAL, SECAM, NTSC, NTSC4.43, PAL-M and PAL-N)
TV Signal	480i, 480p, 575i, 575p, 720p, 1035i, 1080i-50 and 1080i-60
Scanning Frequency	H-sync. 15 ~ 120 KHz, V-sync. 50 ~ 120 Hz
Motorized Lens Shift	Up, Down, Left and Right
Projection Lamp	150 watt type x 4
Input 1 Jack	DVI-I Terminal (Digital/Analog), RCA Type (Audio R and L) and DIN 8-pin (Control port)
Input 2 Jack	BNC Type x 5 (R/Pr, G/Y, B/Pb, H/HV, and V), RCA Type (Audio R and L) and DIN 8-pin (Control port)
Input 3 Jack	BNC Type x 2 (VIDEO/Y, C), RCA Type (Audio R and L) and DIN 4 pin (S-Video)
Input 4 Jack	HDB 15-pin Terminal (Analog), RCA Type (Audio R and L) and DIN 8-pin (Control port)
Other Jack	Serial port in (DB 9), Serial port out (DB 9), USB port, Audio Monitor out (RCA Type R and L) and Wired Remote Jack
Built-in Speaker	INT. SP. Stereo (R and L), 3 watt RMS (T.H.D.10%)
Image Elevation Adjustment	Up to 5.7°
Voltage and Power Consumption	AC 100 ~120 V (10A Max. Ampere), 50/60 Hz (The U.S.A and Canada) AC 200 ~240 V (5A Max. Ampere), 50/60 Hz (Continental Europe and The U.K.)
Operating Temperature	41°F ~ 95°F (5°C ~ 35°C)
Storage Temperature	14°F ~ 140°F (-10°C ~ 60°C)
Remote Control Transmitters	Power Source :AA, UM3 or R06 Type x 2 Operating Range :16.4' (5m)/±30° Dimensions :2.2" x 1.3" x 7.6" (55mm x 34mm x 192mm) Net Weight :0.36 lbs (165 g) (including batteries) Laser Pointer :Class II Laser (Max. Output: 1mW/Wave length : 650±20nm)
Accessories	Owner's Manual AC Power Cord Wireless/Wired Remote Control Transmitter and Batteries Remote Control Cable VGA Cable and DVI Cable MAC/VGA Adapter and DVI/VGA Adapter 3 Types Control Cable (For PS/2, Serial and ADB port) 6 Types Light-Block Sheet Lens Mounting Adapter Protective Dust Cover

● The specifications are subject to change without notice.

CONFIGURATIONS OF THE TERMINALS

DVI-I TERMINAL (DIGITAL/ANALOG)

This terminal accepts only Digital (TMDS) or Analog (RGB) output signal. Connect the display output terminal of the computer to this terminal with the DVI cable (supplied).

Pin Configuration

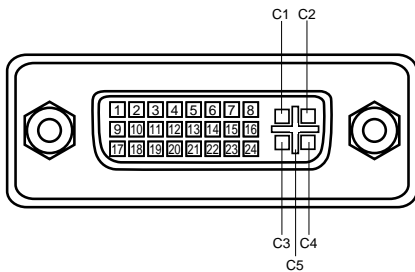

C1	Analog Red Input
C2	Analog Green Input
C3	Analog Blue Input
C4	Analog Horiz. sync
C5	Analog Ground (R/G/B)

1	T.M.D.S. Data2-	9	T.M.D.S. Data1-	17	T.M.D.S. Data0-
2	T.M.D.S. Data2+	10	T.M.D.S. Data1+	18	T.M.D.S. Data0+
3	T.M.D.S. Data2 Shield	11	T.M.D.S. Data1 Shield	19	T.M.D.S. Data0 Shield
4	No Connect	12	No Connect	20	No Connect
5	No Connect	13	No Connect	21	No Connect
6	DDC Clock	14	+5V Power	22	T.M.D.S. Clock Shield
7	DDC Data	15	Ground (for +5V)	23	T.M.D.S. Clock+
8	Analog Vert. sync	16	Hot Plug Detect	24	T.M.D.S. Clock-

HDB 15-PIN TERMINAL (ANALOG)

Connect the display output terminal of the computer to this terminal with the VGA Cable (supplied).

- When connecting the Macintosh computer, use MAC/VGA Adapter (supplied).
- When connecting the Analog signal from DVI terminal of the computer to this terminal, use DVI/VGA Adapter (supplied).

Pin Configuration

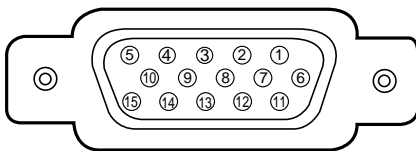

1	Red Input	9	No Connect
2	Green Input	10	Ground (Vert.sync.)
3	Blue Input	11	Sense 0
4	Sense 2	12	Sense 1
5	Ground (Horiz.sync.)	13	Horiz. sync.
6	Ground (Red)	14	Vert. sync.
7	Ground (Green)	15	Reserved
8	Ground (Blue)		

CONTROL PORT CONNECTOR

Terminal : Mini DIN 8-PIN

Connect control port (PS/2, Serial or ADB port) on your computer to this terminal with the Control Cable (supplied).

Pin Configuration

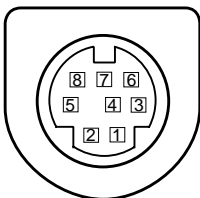

	PS/2	Serial	ADB
1	----	R X D	----
2	CLK	----	ADB
3	DATA	----	----
4	GND	GND	GND
5	----	RTS	----
6	----	T X D	----
7	GND	GND	----
8	----	GND	GND

SERIAL PORT IN/OUT TERMINAL

Pin Configuration

Connect the serial port output terminal of the computer to this terminal with the Serial Cable (not supplied).

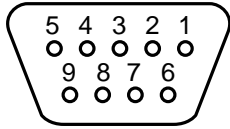

1	-----
2	RxD
3	TxD
4	-----
5	Ground
6	-----
7	-----
8	-----
9	-----

USB PORT TERMINAL

Pin Configuration

Connect the USB port output terminal of the computer or peripheral equipment to this terminal with the USB port Cable (not supplied).

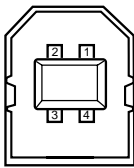

1	Vcc
2	- Data
3	+ Data
4	Ground

Printed in Japan
Part No. 610 287 0534 (1AA6P1P2359-- ML6A)



SANYO Electric Co., Ltd