

***myprojectorlamps.com***

**The most trusted, dependable name  
in projector lamp sales.**



<http://www.myprojectorlamps.com>



<http://www.myprojectorlamps.ca>



<http://www.myprojectorlamps.eu>

The following projector manual has not been modified or altered in any way.

**SANYO**

---

**Multimedia Projector**

**MODEL PLC-XC50**

**PLC-XC55**

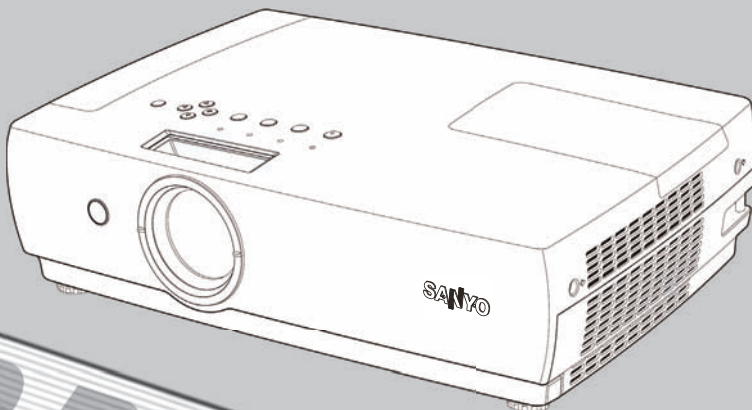

**PROJECTOR**

**Owner's Manual**

# Features and Design

This Multimedia Projector is designed with the most advanced technology for portability, durability, and ease of use. This projector utilizes built-in multimedia features, a palette of 16.77 million colors, and matrix liquid crystal display (LCD) technology.

## ◆ Compatibility

---

The projector widely accepts various video and computer input signals including: Computers, 6 Color systems (PAL, SECAM, NTSC, NTSC4.43, PAL-M, and PAL-N), Component video, S-video and RGB scart.

## ◆ Simple Computer System Setting

---

The projector has the Multi-scan system to conform to almost all computer output signals quickly. (p.27)

## ◆ Digital Zoom (for Computer)

---

The digital zoom function expands (to approx. 16 times of the screen size) or compresses (to approx. a half of the screen size) the image size, allowing you to focus on crucial information during the presentation. (p.36)

## ◆ Blackboard Function

---

Blackboard\* can be used as a projection screen.

\*The board color is limited to Green. (pp.31-32, 40-41)

## ◆ Colorboard Function

---

This enables you to get the close color image to the color image projected on a white screen by selecting the similar color to the wall color from the preset four colors.

## ◆ Quick Termination

---

The AC power cord can be unplugged immediately after turning off the projector without waiting for the termination of the cooling fan rotation.

## ◆ Auto setup Function

---

This function enables Input search, Auto Keystone correction and AUTO PC adjustment by simple pressing the AUTO SETUP button on the top control or the AUTO SET button on the remote control. (p.46)

## ◆ Multilanguage Menu Display

---

Operation menu is available in 16 languages: English, German, French, Italian, Spanish, Portuguese, Dutch, Swedish, Finnish, Polish, Hungarian, Romanian, Russian, Chinese, Korean, and Japanese. (p.45)

## ◆ Logo Function

---

The Logo function allows you to customize the screen logo with the Logo functions. (pp.48-49) You can capture an image for the screen logo, choose a logo between provided and captured.

## ◆ Power Management

---

The Power management function reduces power consumption and maintains the lamp life. (p.50)

## ◆ Lamp Control

---

Brightness of the projection lamp can be selected. (pp.24,51)

## ◆ Security Function

---

The Security function helps you to ensure the security with the Key lock (p.53) and the PIN code lock (pp.18, 53, 54) functions. You can lock the operation on the projector and the remote control. Also you can prevent unauthorized persons from using the projector.

## ◆ Closed Caption

---

This is a printed version of the program sound or other information displayed on the screen. You can turn on the feature and switch the channels. (p.51)

## ◆ Automatic Filter Replacement Function

---

The projector monitors the condition of the filter and replaces a filter automatically when it detects the clogging.

### ✓ Notes:

- The On-Screen Menu and figures in this manual may differ slightly from the product.
- The contents of this manual are subject to change without notice.

# Table of Contents

|  |           |
|--|-----------|
| <b>Features and Design</b> .....                                 | <b>2</b>  |
| <b>Table of Contents</b> .....                                   | <b>3</b>  |
| <b>To the Owner</b> .....  | <b>4</b>  |
| <b>Safety Instructions</b> .....                                 | <b>5</b>  |
| Air Circulation  | 6         |
| Installing the Projector in Proper<br>Position                   | 6         |
| Moving the Projector   | 6         |
| <b>Compliance</b> .....  | <b>7</b>  |
| <b>Part Names and Functions</b> .....                            | <b>8</b>  |
| Front  | 8         |
| Back   | 8         |
| Bottom   | 8         |
| Rear Terminal  | 9         |
| Top Control  | 10        |
| Remote Control   | 11        |
| Remote Control Battery Installation                              | 12        |
| Operating Range  | 12        |
| <b>Installation</b> .....  | <b>13</b> |
| Positioning the Projector  | 13        |
| Adjustable Feet  | 13        |
| Connecting to a Computer   | 14        |
| Connecting to Video Equipment                                    | 15        |
| Connecting to Component Video<br>and RGB (Scart) Equipment       | 16        |
| Connecting the AC Power Cord                                     | 17        |
| <b>Basic Operation</b> .....                                     | <b>18</b> |
| Turning On the Projector   | 18        |
| Turning Off the Projector  | 19        |
| How to Operate the On-Screen Menu                                | 20        |
| Menu Bar   | 21        |
| Zoom and Focus Adjustment  | 22        |
| Auto setup function  | 22        |
| Keystone Correction  | 22        |
| Sound Adjustment   | 23        |
| Remote Control Operation   | 23        |
| <b>Computer Input</b> .....                                      | <b>25</b> |
| Input Source Selection (RGB: Computer 1<br>(Analog)/Computer 2 ) | 25        |

|   |           |
|---|-----------|
| Input Source Selection (RGB(PC digital),<br>RGB(AV HDCP)) | 26        |
| Computer System Selection                                 | 27        |
| Auto PC Adjustment  | 28        |
| Manual PC Adjustment                                      | 29        |
| Image Level Selection                                     | 31        |
| Image Level Adjustment                                    | 33        |
| Screen Size Adjustment                                    | 34        |
| <b>Video Input</b> .....                                  | <b>37</b> |
| Input Source Selection (Video,S-video)                    | 37        |
| Input Source Selection<br>(Component, RGB Scart 21-pin)   | 38        |
| Video System Selection                                    | 39        |
| Image Level Selection                                     | 40        |
| Image Level Adjustment                                    | 42        |
| Screen Size Adjustment                                    | 44        |
| <b>Setting</b> .....                                      | <b>45</b> |
| Setting   | 45        |
| <b>Maintenance and Care</b> .....                         | <b>57</b> |
| Filter Instructions                                       | 57        |
| Replacing the Filter Cartridge                            | 58        |
| Resetting the Filter Counter                              | 59        |
| Resetting the Scroll Counter                              | 59        |
| Lamp Replacement  | 60        |
| Resetting the Lamp Counter                                | 62        |
| Warning TEMP. indicator                                   | 63        |
| Cleaning the Lens Cover                                   | 64        |
| Cleaning the Projector Cabinet                            | 64        |
| <b>Appendix</b> .....                                     | <b>65</b> |
| Troubleshooting   | 65        |
| Menu Tree   | 68        |
| Indicators and Projector Condition                        | 71        |
| Compatible Computer Specifications                        | 73        |
| Technical Specifications                                  | 75        |
| Optional Parts  | 76        |
| Configurations of Terminals                               | 77        |
| Dimensions  | 78        |
| PIN Code Number Memo                                      | 79        |

## Trademarks

Each name of corporations or products in this book is either a registered trademark or a trademark of its respective corporation.

# To the Owner

Before operating this projector, read this manual thoroughly and operate the projector properly.

This projector provides many convenient features and functions. Operating the projector properly enables you to manage those features and maintains it in better condition for a considerable time.

Improper operation may result in not only shortening the product-life, but also malfunctions, fire hazard, or other accidents.

If your projector seems to operate improperly, read this manual again, check operations and cable connections and try the solutions in the "Troubleshooting" section on pages 65-67 of this manual. If the problem still persists, contact the dealer where you purchased the projector or the service center.

|  |
|--|
| <div style="display: inline-block; text-align: center; background-color: black; color: white; padding: 5px; margin: 0 10px;"> <b>CAUTION</b><br/> <b>RISK OF ELECTRIC SHOCK</b><br/> <b>DO NOT OPEN</b> </div> |
| <b>CAUTION:</b> TO REDUCE THE RISK OF ELECTRIC SHOCK, DO NOT REMOVE COVER (OR BACK). NO USER-SERVICEABLE PARTS INSIDE EXCEPT LAMP REPLACEMENT. REFER SERVING TO QUALIFIED SERVICE PERSONNEL.                   |
| THIS SYMBOL INDICATES THAT DANGEROUS VOLTAGE CONSTITUTING A RISK OF ELECTRIC SHOCK IS PRESENT WITHIN THIS UNIT.  |
| THIS SYMBOL INDICATES THAT THERE ARE IMPORTANT OPERATING AND MAINTENANCE INSTRUCTIONS IN THE OWNER'S MANUAL WITH THIS UNIT.  |

**NOTE:** This symbol and recycle system are applied to EU countries only and not applied to the countries in the other area of the world.

Your SANYO product is designed and manufactured with high quality materials and components which can be recycled and reused.

This symbol means that electrical and electronic equipment, at their end-of-life, should be disposed of separately from your household waste.

Please dispose of this equipment at your local community waste collection/recycling centre. In the European Union there are separate collection systems for used electrical and electronic products.

Please help us to conserve the environment we live in!

## Safety Precaution

- WARNING:**
- THIS APPARATUS MUST BE EARTHED.
  - TO REDUCE THE RISK OF FIRE OR ELECTRIC SHOCK, DO NOT EXPOSE THIS APPLIANCE TO RAIN OR MOISTURE.
- This projector produces intense light from the projection lens. Do not stare directly into the lens, otherwise, eye damage could result. Be especially careful that children do not stare directly into the beam.
  - Install the projector in a proper position. If not, it may result in a fire hazard.
  - Provide appropriate space on the top, sides and rear of the projector cabinet for allowing air circulation and cooling the projector. Minimum clearance must be maintained. If the projector is to be built into a compartment or similarly enclosed, the minimum distances must be maintained. Do not cover the ventilation slot on the projector. Heat build-up can reduce the service life of your projector, and can also be dangerous.

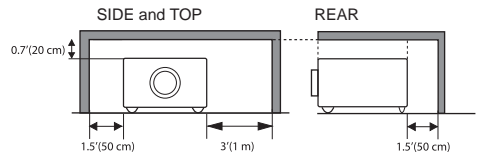

- If the projector is not to be used for an extended time, unplug the projector from the power outlet.

## CAUTION

**DO NOT SET THE PROJECTOR IN GREASY, WET, OR SMOKY CONDITIONS SUCH AS IN A KITCHEN TO PREVENT A BREAKDOWN OR A DISASTER. IF THE PROJECTOR COMES IN CONTACT WITH OIL OR CHEMICALS, IT MAY BECOME DETERIORATED.**

### CAUTION

Not for use in a computer room as defined in the Standard for the Protection of Electronic Computer/Data Processing Equipment, ANSI/NFPA 75.

Ne peut être utilisé dans une salle d'ordinateurs telle que définie dans la norme ANSI/NFPA 75 Standard for Protection of Electronic Computer/Data Processing Equipment.

**READ AND KEEP THIS OWNER'S MANUAL FOR LATER USE.**

# Safety Instructions

All the safety and operating instructions should be read before the product is operated.

Read all of the instructions given here and retain them for later use. Unplug this projector from AC power supply before cleaning. Do not use liquid or aerosol cleaners. Use a damp cloth for cleaning.

Follow all warnings and instructions marked on the projector.

For added protection to the projector during a lightning storm, or when it is left unattended and unused for long periods of time, unplug it from the wall outlet. This will prevent damage due to lightning and power line surges.

Do not expose this unit to rain or use near water... for example, in a wet basement, near a swimming pool, etc...

Do not use attachments not recommended by the manufacturer as they may cause hazards.

Do not place this projector on an unstable cart, stand, or table. The projector may fall, causing serious injury to a child or adult, and serious damage to the projector. Use only with a cart or stand recommended by the manufacturer, or sold with the projector. Wall or shelf mounting should follow the manufacturer's instructions, and should use a mounting kit approved by the manufacturers.

An appliance and cart combination should be moved with care. Quick stops, excessive force, and uneven surfaces may cause the appliance and cart combination to overturn.



Slots and openings in the back and bottom of the cabinet are provided for ventilation, to ensure reliable operation of the equipment and to protect it from overheating.

The openings should never be covered with cloth or other materials, and the bottom opening should not be blocked by placing the projector on a bed, sofa, rug, or other similar surface. This projector should never be placed near or over a radiator or heat register.

This projector should not be placed in a built-in installation such as a book case unless proper ventilation is provided.

Never push objects of any kind into this projector through cabinet slots as they may touch dangerous voltage points or short out parts that could result in a fire or electric shock. Never spill liquid of any kind on the projector. Do not install the projector near the ventilation duct of air-conditioning equipment.

This projector should be operated only from the type of power source indicated on the marking label. If you are not sure of the type of power supplied, consult your authorized dealer or local power company.

Do not overload wall outlets and extension cords as this can result in fire or electric shock. Do not allow anything to rest on the power cord. Do not locate this projector where the cord may be damaged by persons walking on it.

Do not attempt to service this projector yourself as opening or removing covers may expose you to dangerous voltage or other hazards. Refer all servicing to qualified service personnel.

Unplug this projector from wall outlet and refer servicing to qualified service personnel under the following conditions:

- a. When the power cord or plug is damaged or frayed.
- b. If liquid has been spilled into the projector.
- c. If the projector has been exposed to rain or water.
- d. If the projector does not operate normally by following the operating instructions. Adjust only those controls that are covered by the operating instructions as improper adjustment of other controls may result in damage and will often require extensive work by a qualified technician to restore the projector to normal operation.
- e. If the projector has been dropped or the cabinet has been damaged.
- f. When the projector exhibits a distinct change in performance-this indicates a need for service.

When replacement parts are required, be sure the service technician has used replacement parts specified by the manufacturer that have the same characteristics as the original part. Unauthorized substitutions may result in fire, electric shock, or injury to persons.

Upon completion of any service or repairs to this projector, ask the service technician to perform routine safety checks to determine that the projector is in safe operating condition.

## NOTE FOR CUSTOMERS IN THE US

 LAMP(S) INSIDE THIS PRODUCT CONTAIN MERCURY AND MUST BE RECYCLED OR DISPOSED OF ACCORDING TO LOCAL, STATE OR FEDERAL LAWS.

# Safety Instructions

## Air Circulation

Openings in the cabinet are provided for ventilation and to ensure reliable operation of the product and to protect it from overheating, and these openings must not be blocked or covered.

### CAUTION

Hot air is exhausted from the exhaust vent. When using or installing the projector, the following precautions should be taken.

- Do not put any flammable object or spray can near the projector, hot air is exhausted from the ventilation holes.
- Keep the exhaust vent at least 3' (1 m) away from any objects.
- Do not touch a peripheral part of the exhaust vent, especially screws and metallic part. This area will become hot while the projector is being used.
- Do not put anything on the cabinet. Objects put on the cabinet will not only get damaged but also cause fire hazard by heat.

Cooling fans are provided to cool down the projector. The fans' running speed is changed according to the temperature inside the projector.

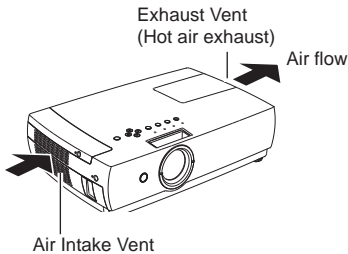

## Installing the Projector in Proper Position

Install the projector properly. Improper Installation may reduce the lamp life and cause a fire hazard.

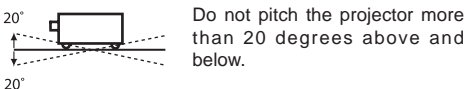
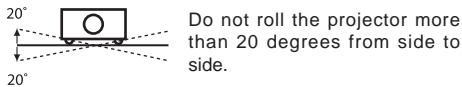

Do not point the projector up to project an image.



Do not point the projector down to project an image.



Do not put the projector on either side to project an image.

## Moving the Projector

When moving the projector, close the slide shutter and retract the adjustable feet to prevent damage to the lens and cabinet. When the projector is not in use for an extended period, put it into a suitable case to protect the projector.

When handling the projector, do not drop, bump, subject it to strong forces, or put other things on the cabinet.



### USE CAUTION IN CARRYING OR TRANSPORTING THE PROJECTOR

- Do not drop or bump the projector, otherwise damages or malfunctions may result.
- When carrying the projector, use a suitable carrying case.
- Do not transport the projector by using a courier or transport service in an unsuitable transport case. This may cause damage to the projector. To transport the projector through a courier or transport service, consult your dealer for their information.
- Do not put the projector in a case before the projector is cooled enough.

# Compliance

## Federal Communications Commission Notice

Note: This equipment has been tested and found to comply with the limits for a Class B digital device, pursuant to Part 15 of the FCC Rules. These limits are designed to provide reasonable protection against harmful interference in a residential installation. This equipment generates, uses, and can radiate radio frequency energy, and if not installed and used in accordance with the instructions, may cause harmful interference to radio communications. However, there is no guarantee that interference will not occur in a particular installation. If this equipment does cause harmful interference to radio or television reception, which can be determined by turning the equipment off and on, the user is encouraged to try to correct the interference by one or more of the following measures:

- Reorient or relocate the receiving antenna.
- Increase the separation between the equipment and receiver.
- Connect the equipment into an outlet on a circuit different from that to which the receiver is connected.
- Consult the dealer or an experienced radio/TV technician for help.

Use of shielded cable is required to comply with class B limits in Subpart B of Part 15 of FCC Rules.

Do not make any changes or modifications to the equipment unless otherwise specified in the instructions. If such changes or modifications should be made, you could be required to stop operation of the equipment.

Model Number : PLC-XC50 / PLC-XC55  
Trade Name : Sanyo  
Responsible party : SANYO FISHER COMPANY  
Address : 21605 Plummer Street, Chatsworth, California 91311  
Telephone No. : (818)998-7322

## AC Power Cord Requirement

The AC Power Cord supplied with this projector meets the requirement for use in the country you purchased it.

### AC Power Cord for the United States and Canada:

AC Power Cord used in the United States and Canada is listed by the Underwriters Laboratories (UL) and certified by the Canadian Standard Association (CSA).

AC Power Cord has a grounding-type AC line plug. This is a safety feature to be sure that the plug will fit into the power outlet. Do not try to defeat this safety feature. Should you be unable to insert the plug into the outlet, contact your electrician.



### AC Power Cord for the United Kingdom:

This cord is already fitted with a moulded plug incorporating a fuse, the value of which is indicated on the pin face of the plug. Should the fuse need to be replaced, an ASTA approved BS 1362 fuse must be used of the same rating, marked thus  $\diamond$ . If the fuse cover is detachable, never use the plug with the cover omitted. If a replacement fuse cover is required, ensure it is of the same colour as that visible on the pin face of the plug (i.e. red or orange). Fuse covers are available from the Parts Department indicated in your User Instructions.

If the plug supplied is not suitable for your socket outlet, it should be cut off and destroyed.

The end of the flexible cord should be suitably prepared and the correct plug fitted.

**WARNING : A PLUG WITH BARED FLEXIBLE CORD IS HAZARDOUS IF ENGAGED IN A LIVE SOCKET OUTLET.**

The Wires in this mains lead are coloured in accordance with the following code:

- Green-and-yellow . . . . . Earth
- Blue . . . . . Neutral
- Brown . . . . . Live

As the colours of the wires in the mains lead of this apparatus may not correspond with the coloured markings identifying the terminals in your plug proceed as follows:

The wire which is coloured green-and-yellow must be connected to the terminal in the plug which is marked by the letter E or by the safety earth symbol  $\perp$  or coloured green or green-and-yellow.

The wire which is coloured blue must be connected to the terminal which is marked with the letter N or coloured black.

The wire which is coloured brown must be connected to the terminal which is marked with the letter L or coloured red.

**WARNING: THIS APPARATUS MUST BE EARTHED.**

**THE SOCKET-OUTLET SHOULD BE INSTALLED NEAR THE EQUIPMENT AND EASILY ACCESSIBLE.**



# Part Names and Functions

## Front

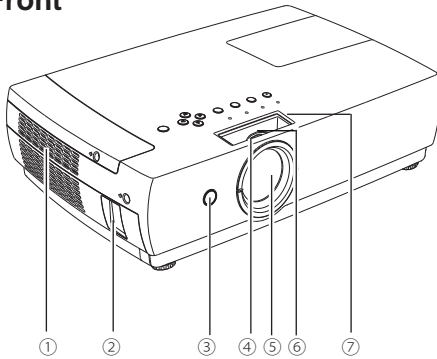

- ① Air Intake Vent
- ② Power Cord Connector
- ③ Infrared Remote Receiver
- ④ Focus Ring (front)
- ⑤ Lens and Lens cover
- ⑥ Zoom Ring (rear)
- ⑦ Slide Shutter

## Back

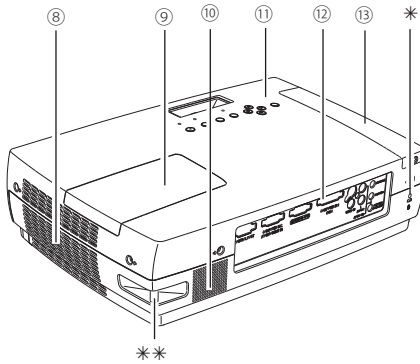

- ⑧ Exhaust Vent



### CAUTION

Hot air is exhausted from the exhaust vent. Do not put heat-sensitive objects near this side.

- ⑨ Lamp Cover
- ⑩ Speaker
- ⑪ Top Controls and Indicators
- ⑫ Terminals and Connectors
- ⑬ Filter Cover
- ⑭ Adjustable feet

## Bottom

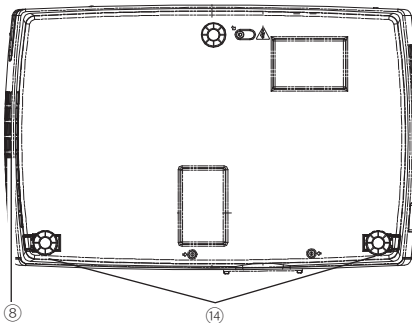

### \* Kensington Security Slot

This slot is for a Kensington lock used to deter theft of the projector.

\*Kensington is a registered trademark of ACCO Brands Corporation.

### \*\*Security Bar

A commercially available anti-theft chain or wire can be attached to the security bar on the projector.

## Rear Terminal

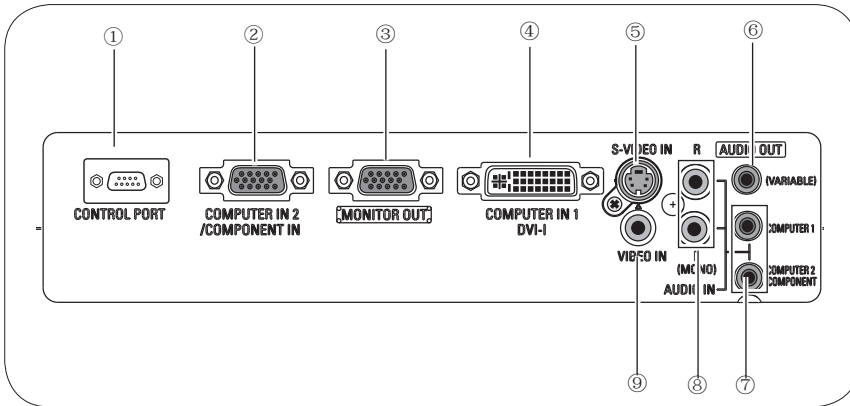

## ① CONTROL PORT

When the projector is controlled by a computer, connect to this jack with serial control cable.

## ② COMPUTER IN 2 / COMPONENT IN

Connect output signal from a computer, RGB scart 21-pin video output or component video output to this terminal. (pp.14,16)

## ③ MONITOR OUT

This terminal can be used to output the incoming RGB signal from COMPUTER IN 1 / DVI-I terminal or COMPUTER IN 2/COMPONENT IN terminal to the other monitor (p.14).

## ④ COMPUTER IN 1 / DVI-I

Connect computer output (Digital/Analog DVI-I type) to this terminal (p.14).

## ⑤ S-VIDEO IN

Connect the S-VIDEO output signal from video equipment to this jack (p.15).

## ⑥ AUDIO OUT (VARIABLE)

Connect an external audio amplifier to this jack. (pp.14 - 16)

This terminal outputs sound from AUDIO IN terminal (⑦ or ⑧).

## ⑦ COMPUTER1/ COMPUTER2 COMPONENT AUDIO IN

Connect the audio output (stereo) from a computer or video equipment connected to ② or ④ to this jack. (pp.14, 16)

## ⑧ AUDIO IN

Connect the audio output from video equipment connected to ⑤ or ⑨ to this jack. (When the audio output is monaural, connect it to L (MONO) jack.). (p.15)

## ⑨ VIDEO IN

Connect the composite video output from video equipment to VIDEO jack. (p.15)

Top Control

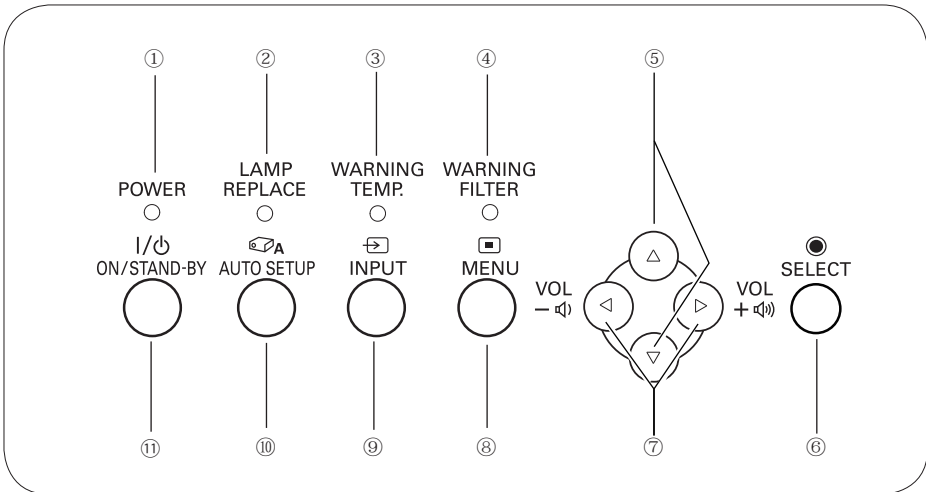

① **POWER indicator**

- Light red when the projector is in stand-by mode.
- Light green during operations.
- Blink green in the Power management mode . (p.50)
- Blink red during cooling down.

② **LAMP REPLACE indicator**

Turn yellow when the life of the projection lamp draws to an end. (pp.60, 71-72)

③ **WARNING TEMP. indicator**

Emit a red light when the projector detects an abnormal condition. This also blinks red when the internal temperature of the projector exceeds the operating range. (pp.63, 71-72)

④ **WARNING FILTER indicator**

- Blink slow when the filter is being scrolled . (pp.57, 71)
- Blink fast when the filter cartridge is not installed. (pp.57, 72)
- Light orange when the clogging of the filter is detected or the filter counter reaches a time set in the timer setting, urging immediate filter/ filter cartridge replacement. (pp.55, 57, 72)

⑤ **POINT (▲▼) buttons**

- Select an item or adjust the value in the On-Screen Menu. (p.20)
- Pan the image in Digital zoom + mode. (p.36)

⑥ **SELECT button**

- Execute the selected item. (p.20)
- Expand or compress the image in Digital zoom mode. (p.36)

⑦ **POINT (◀▶) buttons**

- Select an item or adjust the value in the On-Screen Menu. (p.20)
- Pan the image in Digital zoom + mode. (p.36)

⑧ **MENU button**

Open or close the On-Screen Menu. (p.20)

⑨ **INPUT button**

Select an input source. (pp.25-26, 37-38)

⑩ **AUTO SETUP button**

Execute the setting of Auto setup (includes Input search, Auto PC adj. and Auto Keystone functions) in the setting menu. (pp.22,24,28,46)

⑪ **POWER ON/STAND-BY button**

Turn the projector on or off. (pp.18, 19)

## Remote Control

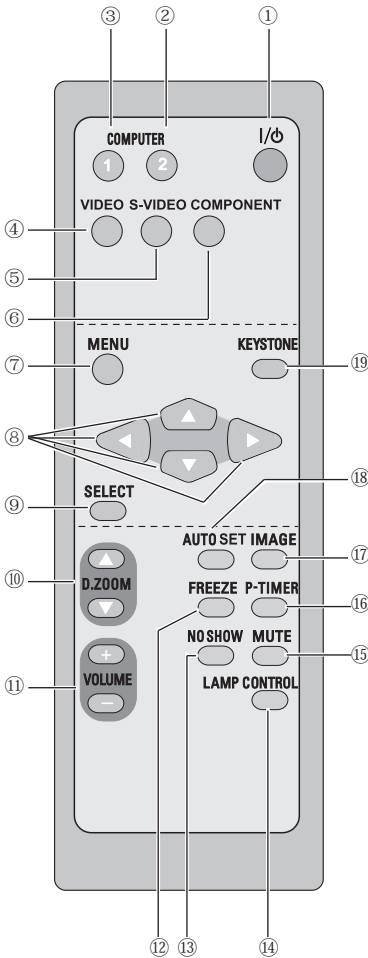

- ① **POWER ON/STAND-BY button**  
Turn the projector on or off. (pp.18, 19)
- ② **COMPUTER 2 button**  
Select COMPUTER 2 input source. (pp.25, 38)
- ③ **COMPUTER 1 button**  
Select Computer 1 (Analog) or Computer 1 (Digital) input source. (pp.25, 26)
- ④ **VIDEO button**  
Select VIDEO input source. (p.37)
- ⑤ **S-VIDEO button**  
Select S-VIDEO input source. (p.37)
- ⑥ **COMPONENT button**  
Select COMPONENT input source. (p. 38)
- ⑦ **MENU button**  
Open or close the On-Screen Menu. (p.20)
- ⑧ **Point ▲▼◀▶ buttons**  
– Select an item or adjust the value in the On-Screen Menu. (p.20)  
– Pan the image in Digital zoom + mode. (p.36)
- ⑨ **SELECT button**  
– Execute the selected item. (p.20)  
– Expand or compress the image in Digital zoom mode. (p.36)
- ⑩ **D.ZOOM ▲▼ buttons**  
Zoom in and out the images. (pp.24, 36)
- ⑪ **VOLUME + / – buttons**  
Adjust the volume level. (p.23)
- ⑫ **FREEZE button**  
Freeze the picture. (p.23)
- ⑬ **NO SHOW button**  
Temporarily turn off the image on the screen. (p.24)
- ⑭ **LAMP CONTROL button**  
Select the lamp mode. (pp.24, 51)
- ⑮ **MUTE button**  
Mute the sound. (p.23)
- ⑯ **P-TIMER button**  
Operate the P-timer function. (p.24)
- ⑰ **IMAGE button**  
Select the image level. (pp.24, 31, 40)
- ⑱ **AUTO SET button**  
Execute the setting of Auto setup (includes Input search function, Auto PC adj. function and Auto Keystone function). (pp.22, 24, 28, 46)
- ⑲ **KEYSTONE button**  
Correct the keystone distortion. (pp.22, 47)



To ensure safe operation, please observe the following precautions:

- Do not bend, drop or expose the remote control to moisture or heat.
- For cleaning, use soft dry cloth. Do not apply benzene, thinner, spray or any chemical material.

### Remote Control Battery Installation

- 1** Open the battery compartment lid.

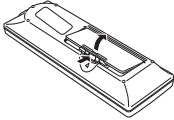

- 2** Install new batteries into the compartment.

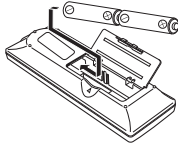

**Two AA size batteries**  
For correct polarity (+ and -), be sure battery terminals are in contact with pins in the compartment.

- 3** Replace the compartment lid.

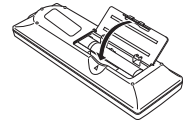

To ensure safe operation, please observe the following precautions:

- Use two (2) AA or LR6 type alkaline batteries.
- Always replace batteries in sets.
- Do not use a new battery with a used battery.
- Avoid contact with water or liquid.
- Do not expose the remote control to moisture or heat.
- Do not drop the remote control.
- If the battery has leaked on the remote control, carefully wipe the case clean and install new batteries.
- Risk of explosion if a battery is replaced by an incorrect type.
- Dispose of used batteries according to the instructions.

### Operating Range

Point the remote control toward the projector (Infrared Remote Receiver) when pressing any button. Maximum operating range for the remote control is about 16.4' (5 m) and 60° in front of the projector.

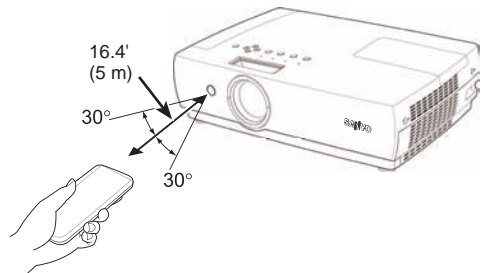

# Installation

## Positioning the Projector

For projector positioning, see the figures below. The projector should be set horizontally to the flat screen.

✓ **Notes:**

- The brightness in the room has a great influence on picture quality. It is recommended to limit ambient lighting in order to obtain the best image.
- The values shown below are approximate and may vary from the actual sizes.

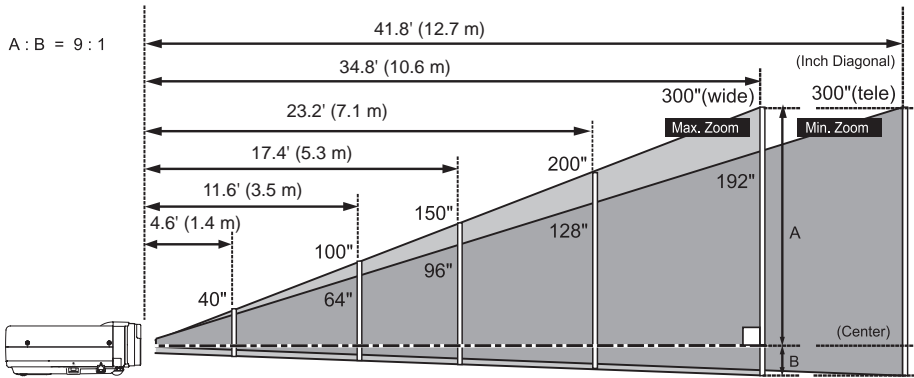

| Screen Size (W x H) mm | 40"          | 100"          | 150"          | 200"          | 300"           |
|------------------------|--------------|---------------|---------------|---------------|----------------|
| 4 : 3 aspect ratio     | 813 x 610    | 2032 x 1524   | 3048 x 2286   | 4064 x 3048   | 6096 x 4572    |
| Zoom (max)             | 4.6' (1.4 m) | 11.6' (3.5 m) | 17.4' (5.3 m) | 23.2' (7.1 m) | 34.8' (10.6 m) |
| Zoom (min)             | 5.5' (1.7 m) | 13.9' (4.2 m) | 20.9' (6.4 m) | 27.8' (8.5 m) | 41.8' (12.7 m) |

## Adjustable Feet

Projection angle can be adjusted up to 10.0 degrees with the adjustable feet.

- 1 Lift the front of the projector and push the feet lock latches on the projector.
- 2 Release the feet lock latches to lock the adjustable feet and rotate the adjustable feet to adjust the position and tilt.
- 3 To retract the adjustable feet, lift the front of the projector and push and undo the feet lock latches. Keystone distortion of the projected image can be corrected with the remote control or menu operation. (pp.22, 46)

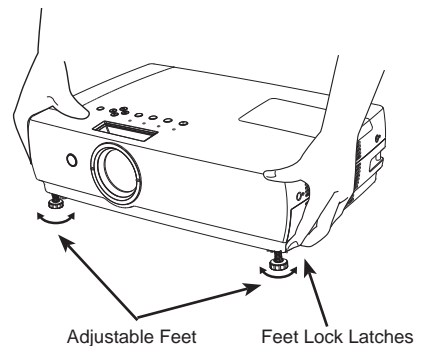

## Connecting to a Computer

### Cables used for connection

- DVI Cable or DVI-VGA Cable
  - VGA Cables (Mini D-sub 15 pin) (Only one cable is supplied.)
  - Audio Cables (Mini Plug: stereo)
- ( Not all the cables are supplied with this projector.)

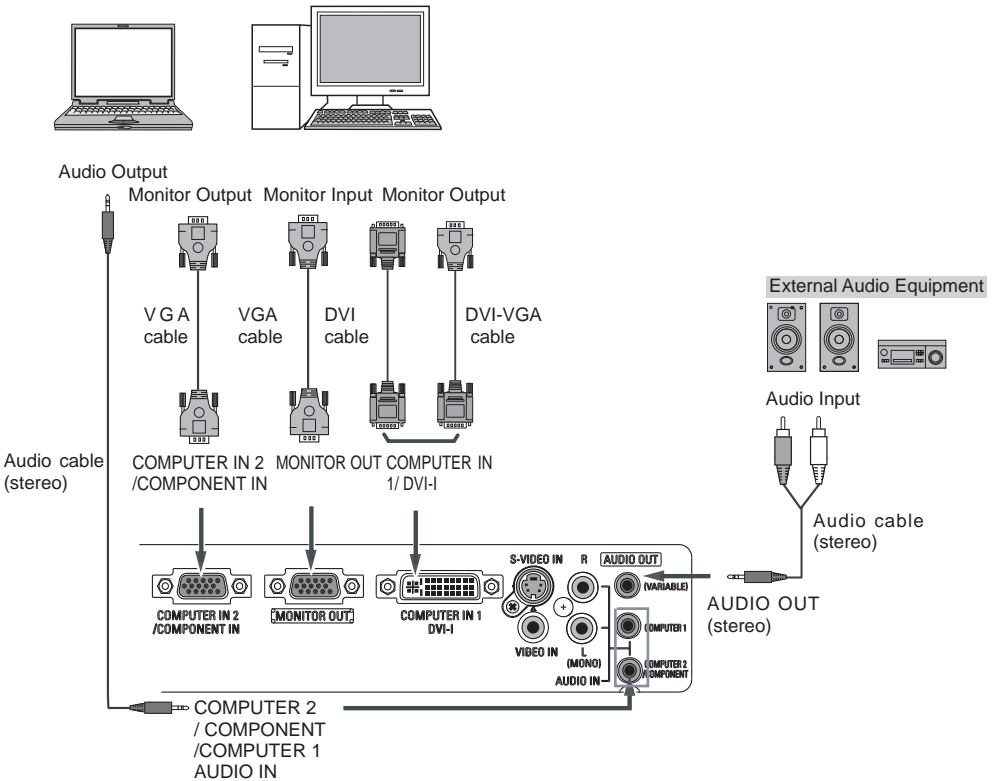

✓ **Notes:**

- Input sound to the COMPUTER 2 / COMPONENT AUDIO IN terminal when using the COMPUTER IN 2 / COMPONENT IN as input.
- Input sound to the COMPUTER 1 AUDIO IN terminal when using the COMPUTER IN 1 / DVI-I terminal as input.
- When the AUDIO OUT is plugged-in, the projector's built-in speaker is not available.

 Unplug the power cords of both the projector and external equipment from the AC outlet before connecting cables.

## Connecting to Video Equipment

Cables used for connection

- Video and Audio Cable (RCA x 3)
  - S-video Cable
  - Audio Cables (RCA x 2, Mini Plug: stereo)
- (Cables are not supplied with the projector.)

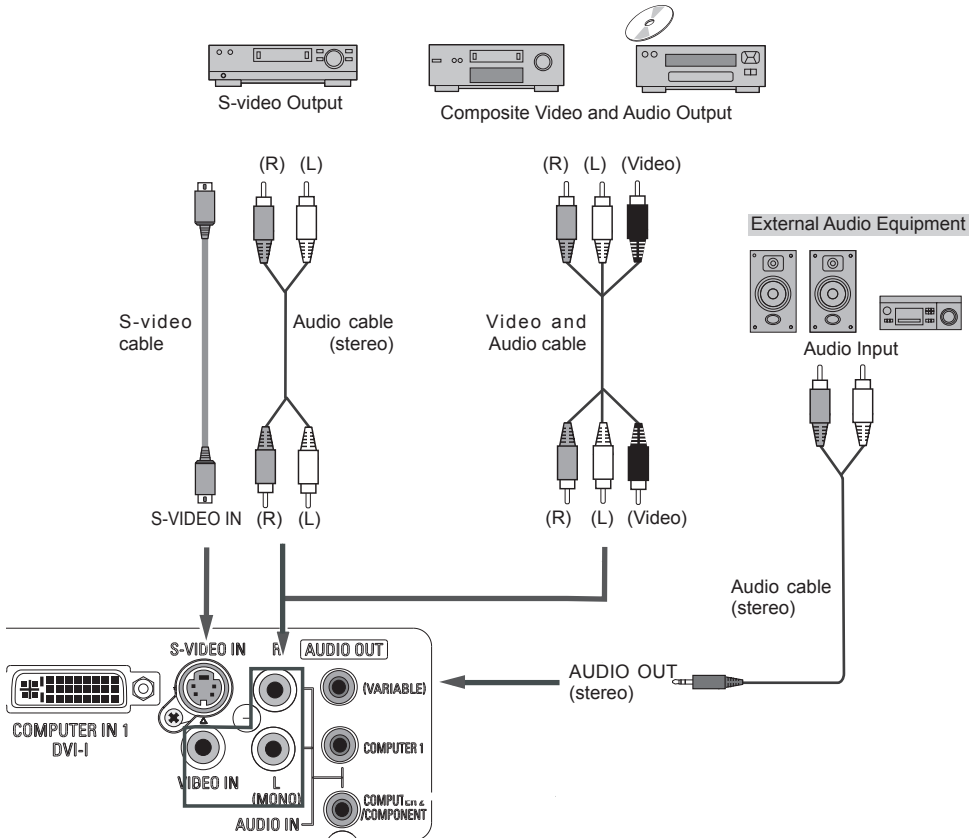

✓ **Note:**

- When the AUDIO OUT is plugged-in, the projector's built-in speaker is not available.



Unplug the power cords of both the projector and external equipment from the AC outlet before connecting cables.



# Installation

## Connecting to Component Video and RGB (Scart) Equipment

Cables used for connection

- Audio Cables (Mini Plug :stereo)
  - Scart-VGA Cable
  - Component Cable
  - Component-VGA Cable
- (Cables are not supplied with the projector.)

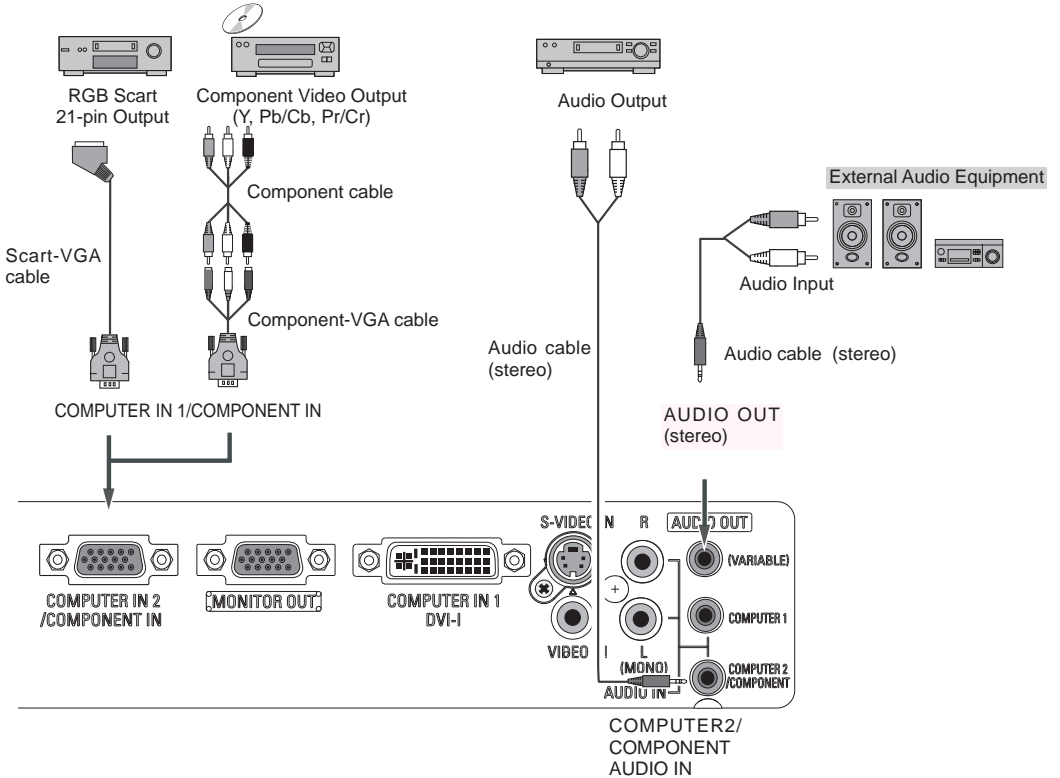

### ✓ Notes:

- When the AUDIO OUT is plugged-in, the projector's built-in speaker is not available.
- See page 76 for ordering optional parts.



Unplug the power cords of both the projector and external equipment from the AC outlet before connecting cables.

## Connecting the AC Power Cord

This projector uses nominal input voltages of 100-120 V or 200-240 V AC. This projector automatically selects the correct input voltage. It is designed to work with single-phase power systems having a grounded neutral conductor. To reduce the risk of electrical shock, do not plug into any other type of power system. Consult your authorized dealer or service station if you are not sure of the type of power being supplied. Connect the projector with all peripheral equipment before turning the projector on. (See pages 14-16 for connection)

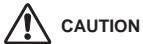

**CAUTION**

The AC outlet must be near this equipment and must be easily accessible.

✓ **Note:**

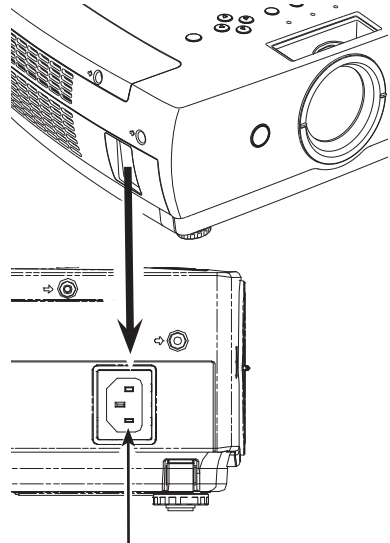

Unplug the AC power cord when the projector is not in use. When this projector is connected to an outlet with the AC power cord, it is in Stand-by mode and consumes a little electric power.



Connect the AC power cord (supplied) to the projector.

### NOTE ON THE POWER CORD

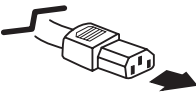
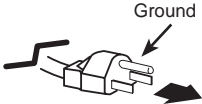
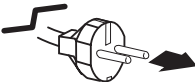
AC power cord must meet requirement of the country where you use the projector. Confirm the AC plug type with the chart below and proper AC power cord must be used. If supplied AC power cord does not match your AC outlet, contact your sales dealer.

| Projector side  | AC outlet side   |   |  |
|---|--|---|--|
|  <p data-bbox="84 1224 239 1287">To power cord connector on your projector.</p> | <p data-bbox="291 1089 508 1109">For the U.S.A. and Canada</p>  <p data-bbox="436 1127 500 1146">Ground</p> <p data-bbox="315 1240 453 1282">To the AC outlet.<br/>(120 V AC)</p> | <p data-bbox="556 1089 747 1109">For Continental Europe</p>  <p data-bbox="573 1250 717 1292">To the AC outlet.<br/>(200 - 240 V AC)</p> | <p data-bbox="856 1089 953 1109">For the U.K.</p>  <p data-bbox="859 1250 1003 1292">To the AC outlet.<br/>(200 - 240 V AC)</p> |

# Basic Operation

## Turning On the Projector

- 1 Complete peripheral connections (with a computer, VCR, etc.) before turning on the projector.
- 2 Connect the projector's AC power cord into an AC outlet. The POWER indicator becomes red.
- 3 Press the POWER ON/STAND-BY button on the top control or on the remote control. The POWER indicator becomes green and the cooling fans start to operate. The preparation display appears on the screen and the count down starts.
- 4 After the countdown, the input source that was selected the last time and the Lamp mode status icon (see page 51) appears on the screen.

If the projector is locked with a PIN code, PIN code Input Dialog Box appears. Enter the PIN code as instructed below.

### To Enter a PIN code

Select a number by pressing the Point ▲▼ buttons, and then press the Point ► button to fix the number and move the pointer. The number changes to "\*". If you fixed an incorrect number, move the pointer to the number you want to correct by pressing the Point ◀ button, and then select the correct number by pressing the Point ▲▼ buttons.

Repeat this step to complete entering a four-digit number. "1234" is set as the initial PIN code at the factory.

After entering the four-digit number, move the pointer to "Set" by pressing the Point ► button. Press the SELECT button so that you can start to operate the projector.

If you entered an incorrect PIN code, "PIN code" and the number (\* \*\* \*) turns red. Enter the correct PIN code all over again.

### What is PIN code?

PIN (Personal Identification Number) code that allows the person who knows it to operate the projector. Setting a PIN code prevents unauthorized use of the projector.

A PIN code consists of a four-digit number. Refer to the PIN code lock function in the Setting on pages 53 and 54 for locking operation of the projector with your PIN code.



#### CAUTION ON HANDLING PIN CODE

If you forget your PIN code, the projector can no longer be started. Set a new PIN code with special care, write it down in column on page 79 of this manual, and keep it on hand. Should the PIN code be missing or forgotten, consult your dealer or service center.

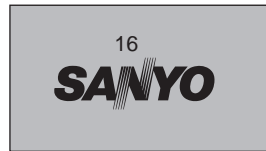

The preparation display disappears after 30 seconds.

### Selected Input Source and Lamp Mode



(See page 51 for Lamp mode.)

✓Note:

The Filter warning and Lamp replacement icons may appear on the screen depending on the usage state of the projector.

### PIN Code Input Dialog Box

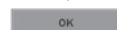
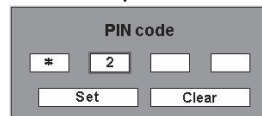
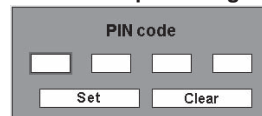

After the OK icon disappears, you can operate the projector.

✓Notes:

- When the Input Search function is set On1 or On2, the input signal will be searched automatically (p.46)
- When the Logo select function is off, the logo is not shown on the screen. (p.48)
- When the "Countdown off" or "Off" is selected in the Display function, the countdown is not shown on the screen. (p.47)
- During the countdown period, all operations are invalid.
- If the PIN code number is not input for three minutes after the PIN code dialog box appeared, the projector is turned off automatically.

## Turning Off the Projector

- 1 Press the POWER ON/STAND-BY button on the top control or on the remote control, and a message "Power off?" appears on the screen.
- 2 Press the POWER ON/STAND-BY button again to turn off the projector. The POWER indicator starts to blink red, and the cooling fans keep running. (You can select the level of fan quietness and rotation speed. See page 55.)  
At this time you can disconnect the AC power cord even if the fans are still running.
- 3 When the projector has cooled down enough, the POWER indicator stops blinking and you can turn on the projector.



The message disappears after 4 seconds.

 TO MAINTAIN THE LIFE OF THE LAMP, ONCE YOU TURN THE PROJECTOR ON, WAIT AT LEAST FIVE MINUTES BEFORE TURNING IT OFF.

 DO NOT OPERATE THE PROJECTOR CONTINUOUSLY WITHOUT REST. CONTINUOUS USE MAY RESULT IN SHORTENING THE LAMP LIFE. TURN OFF THE PROJECTOR AND GIVE IT A REST ABOUT AN HOUR IN EVERY 24 HOURS.

### ✓ Notes:

- When the On start function is on, this projector is turned on automatically by connecting the AC power cord to an AC outlet. (p.51)
- The running speed of cooling fans is changed according to the temperature inside the projector.
- Do not put the projector in a case before the projector is cooled enough.
- If the WARNING TEMP. indicator blinks or emits a red light, see "Indicators and Projector Condition" on pages 71-72.
- While the POWER indicator is blinking, lamp is being cooled down and the projector cannot be turned on. Wait until the POWER indicator stops blinking to be turned on again.
- The fan rotation will terminate directly if the AC power cord is unplugged immediately after the projector is turned off.
- The projector can be turned on after the POWER indicator turns red. The waiting time to restart will be shortened when the normal power-off processing for fan cooling is completed, compared with the time the AC power cord is immediately unplugged after the power-off.

## How to Operate the On-Screen Menu

The projector can be adjusted or set via the On-Screen Menu. Refer to the following pages regarding each adjustment and setting procedures.

- 1 Press the MENU button to display the On-Screen Menu.
- 2 Press the Point ◀▶ buttons to select a Menu icon to adjust and press the Point ▲▼ buttons to select an item to adjust.
- 3 Press the SELECT button to show the item data. To adjust the data, press the Point ◀▶ buttons. Refer to the following pages for each adjustment.

To close the On-Screen Menu, press the MENU button again.

✓ **Note:**

The selected item is not active until the SELECT button is pressed.

### Top Control

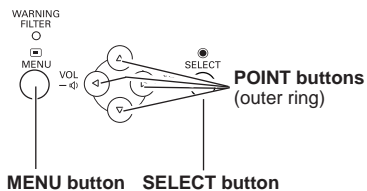

### Remote Control

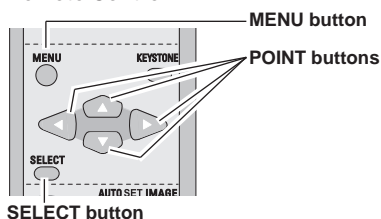

### On-Screen Menu

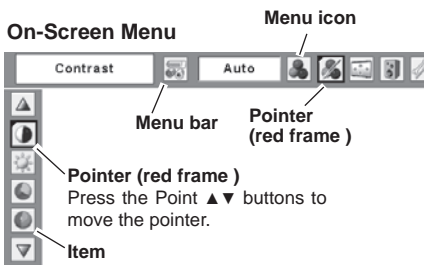

Press the SELECT button here to display previous items.

Press the SELECT button here to display next items.

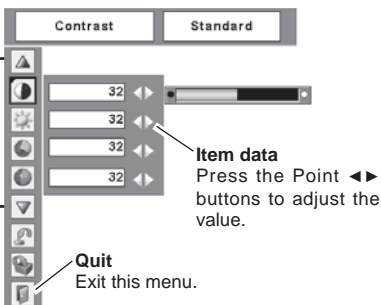

## Menu Bar

For detailed functions, see Menu Tree on pages 68-70.

### For computer source

**Guide Window**  
Show the selected Menu of the On-Screen Menu.

**PC System Menu**  
Used to select computer system. (p.27)

**Image Select Menu**  
Used to select an image level among Dynamic, Standard, Real, Blackboard (Green), Colorboard and Image 1 ~ 4. (pp.31-32)

**Screen Menu**  
Used to adjust size of image. [Normal / True / Wide / Full / Custom configurations / Digital zoom +/-] (pp34-36)

**Setting Menu**  
Used to set the projector's operating configurations. (pp.45-56)

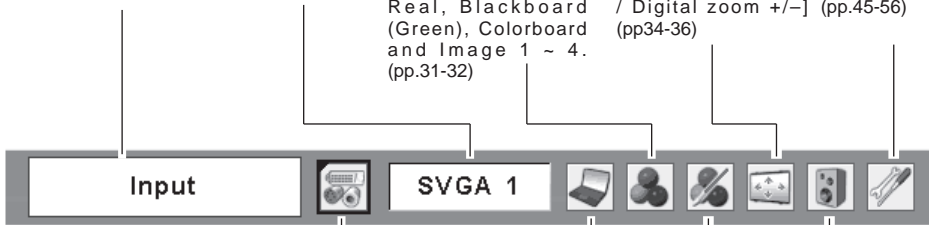

**Input Menu**  
Used to select input source either Computer or Video. (pp.25,26)

**PC Adjust Menu**  
Used to adjust parameters to match with input signal format. (pp.28-30)

**Image Adjust Menu**  
Used to adjust computer image. [Contrast / Brightness / Color temp. / White balance (R/G/B) / Sharpness / Gamma] (pp.33-34)

**Sound Menu**  
Used to adjust the volume or mute the sound. (p.23)

✓ **Note:**

Items will be same as the items in video source when 480i, 575i, 480p, 575p, 720p, 1035i or 1080i is selected.

### For video source

**Input Menu**  
Used to select input source either Video or Computer. (pp.37, 38)

**Image Select Menu**  
Used to select an image level among Dynamic, Standard, Cinema, Blackboard (Green), Colorboard and Image 1 ~ 4. (pp.40-41)

**Screen Menu**  
Used to set size of image to Normal, Wide or Custom. (p.44)

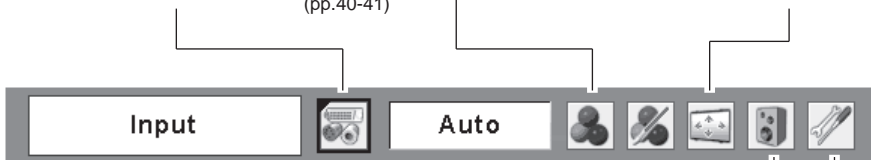

Same function as menu for computer source.

**AV System Menu**  
Used to select system of selected video source. (p.39)

**Image Adjust Menu**  
Used to adjust picture image. [Contrast / Brightness / Color / Tint / Color temp. / White balance (R/G/B) / Sharpness / Gamma / Noise reduction / Progressive] (pp.42-43)

Same function as computer menu.

## Zoom and Focus Adjustment

Open the slide shutter.  
 Rotate the Zoom Ring to zoom in and out.  
 Rotate the Focus Ring to adjust the projected picture focus.  
 Close the slide shutter.

✓ **Note:**

Close the slide shutter of lens operation part to keep out dust just after zoom and focus adjustments.

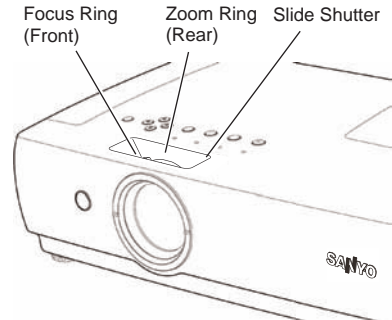

## Auto setup function

Auto setup function is provided to automatically execute the setting of Auto setup (includes Input search, Auto PC adj. and Auto Keystone functions) in the setting menu by just pressing the AUTO SETUP button on the top control or AUTO SET button on the remote control. Refer to page 46 for the setting of the Auto setup function.

## Keystone Correction

If a projected picture still has keystone distortion after pressing the AUTO SETUP button on the top control, correct the image manually as follows:

Press the KEYSTONE button on the remote control. The keystone dialog box appears.  
 Correct keystone distortion by pressing the Point ▲▼ buttons. Keystone adjustment can be memorized. (p.47)

Reduce the upper width with Point ▲ button.

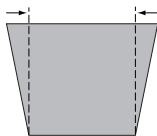

Reduce the lower width with Point ▼ button.

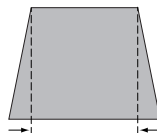

### Top Control



### Remote Control



- The arrows are white when there is no correction.
- The direction of the arrow being corrected turns red.
- The arrows disappear at the maximum correction.
- If you press the KEYSTONE button on the remote control once more while the keystone dialog box is being displayed, the keystone adjustment is canceled.
- The adjustable range is limited depending on the input signal.

### Top Control

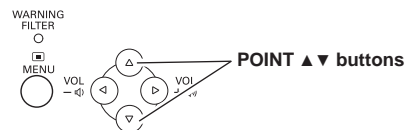

### Remote Control

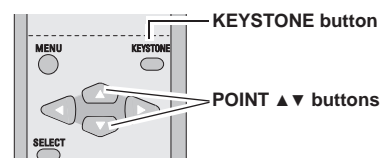

## Sound Adjustment

### Direct Operation

#### Volume

Press the VOLUME+/- buttons on the top control or on the remote control to adjust the volume. The volume dialog box appears on the screen for a few seconds.

#### Mute

Press the MUTE button on the remote control to cut off the sound. To restore the sound to its previous level, press the MUTE button again or press the VOLUME +/- buttons. Mute function is also effective for AUDIO OUT jack.

### Menu Operation

- 1 Press the MENU button to display the On-Screen Menu. Press the Point ◀▶ buttons to move the red frame pointer to the Sound Menu icon.
- 2 Press the Point ▲▼ buttons to move the red frame pointer to the item that you want to select, and then press the SELECT button.

#### Volume

Press the Point ▶ buttons to turn up the volume, and press the Point ◀ button to turn down the volume.

#### Mute

Press the Point ◀▶ buttons to cut off the sound. Dialog box display changes to "On" and the sound is cut off. To restore the sound to its previous level, press the Point ◀▶ buttons again.

## Remote Control Operation

For some frequently used operations, using the remote control is advisable.

Just pressing one of the buttons enables you to make the operation, and no need for calling up the On-Screen Menu.

### COMPUTER/ VIDEO / S-VIDEO /COMPONENT buttons

Press the COMPUTER or VIDEO or S-VIDEO or COMPONENT button on the remote control to select the input source. For more detail, see pages 25,26,37 and 38.

### FREEZE button

Press the FREEZE button on the remote control to freeze the picture on the screen. To cancel the Freeze function, press the FREEZE button again or press any other button.

### Top Control

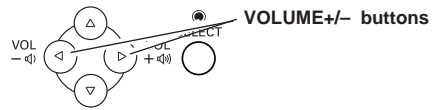

### Remote Control

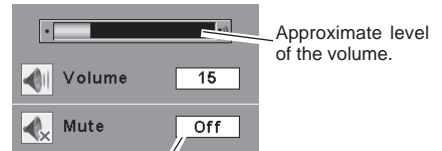
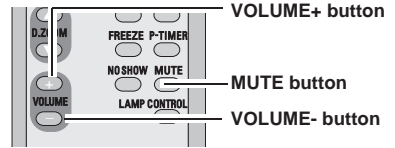

Press the MUTE button to set the Mute function On/Off. The display disappears after 4 seconds.

### Sound Menu

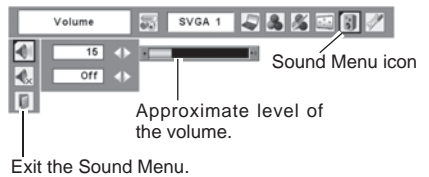

### Remote Control

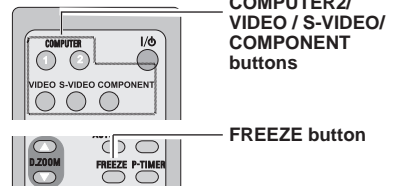

### ✓ Note:

See the next page for the other buttons.



# Basic Operation

## AUTO SET button

Press the AUTO SET button on the remote control to operate the Auto setup function. For more detail, see pages 22, 28,46.

## D.ZOOM buttons

Press the D.ZOOM buttons on the remote control to zoom in and zoom out the images. For more detail, see page 36.

## NO SHOW button

Press the NO SHOW button on the remote control to black out the image. To restore to normal, press the NO SHOW button again or press any other button. When a projected image is captured and set as "User" in the Logo selection (p.48), the screen changes each time you press the NO SHOW button as follows.

black out → the captured image → normal →.....

## KEystone button

For detail, see page 22.

## IMAGE button

Press the IMAGE button on the remote control to select a desired image level of the screen. For more detail, see pages 31 and 40.

## P-TIMER button

Press the P-TIMER button on the remote control. The timer display "00 : 00" appears on the screen and the timer starts to count time (00 : 00 ~ 59 : 59).

To stop the P-Timer, press the P-TIMER button. Press the P-TIMER button again, then the P-timer display disappears.

## LAMP CONTROL button

Press the LAMP CONTROL button on the remote control to select the lamp mode for changing the brightness of the screen.

- ☺ Normal . . . normal brightness
- ☺ Auto . . . . . brightness according with the input signal
- ☺ Eco..... lower brightness reduces the lamp power consumption and extends the lamp life.

✓ Note:

Lamp mode cannot be changed for a while after turning on the projector. Lamp needs some time to stabilize after the power is turned on. Stored lamp mode will be active after the lamp is stabilized.

## Remote Control

### D.ZOOM buttons

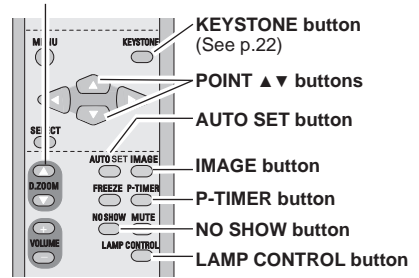

✓ Note:

See the previous page for the other buttons.

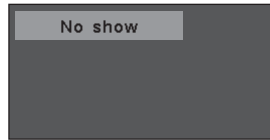

The message disappears after 4 seconds.



P-Timer display

# Computer Input

## Input Source Selection (RGB: Computer 1 (Analog)/Computer 2 )

### Direct Operation

Choose Computer 1 (Analog) or Computer 2 by pressing the INPUT button on the top control or choose Computer 1 (Analog) by pressing the COMPUTER 1 button on the remote control or choose computer 2 by pressing COMPUTER 2 button on the remote control. Before using these buttons, correct input source should be selected through Menu operation as described below.

### Top Control

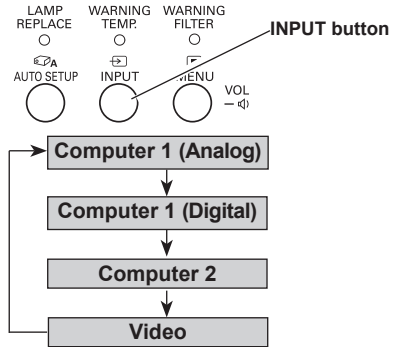

### Remote Control

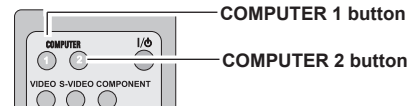

### COMPUTER 1 button

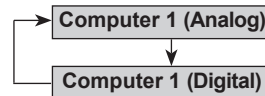

### Input Menu

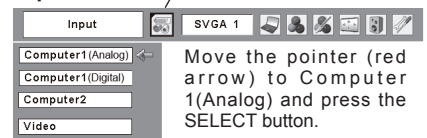

### Input Menu

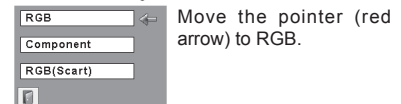
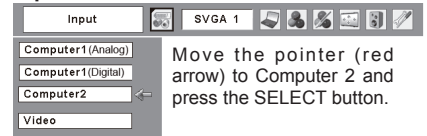

### Menu Operation

- 1 Press the MENU button to display the On-Screen Menu. Press the Point ◀▶ buttons to move the red frame pointer to the Input Menu icon.
- 2 Press the Point ▲▼ buttons to move the red arrow pointer to either Computer 1 (Analog) or Computer 2, and then press the SELECT button.
- 3 When selecting Computer 1 (Analog), RGB input source will be selected directly. When selecting Computer 2, the Source Select Menu appears. Move the pointer to RGB and then press the SELECT button.

### ✓ Note:

When the Input Search function is set On1 or On2, the input signal will be searched automatically. (p.46)

## Input Source Selection (RGB(PC digital), RGB(AV HDCP))

### Direct Operation

Choose Computer 1 (Digital) by pressing the INPUT button on the top control or press the COMPUTER 1 button on the remote control.

Before using these buttons, correct input source should be selected through Menu operation as described below.

### Top Control

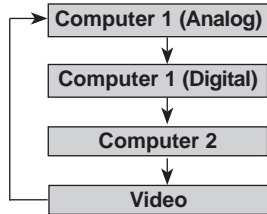
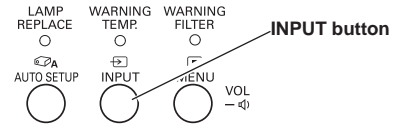

### Remote Control

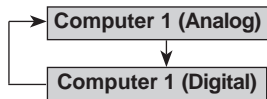
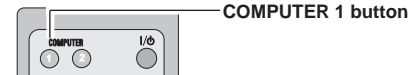

### Menu Operation

- 1 Press the MENU button to display the On-Screen Menu. Press the Point ◀▶ buttons to move the red frame pointer to the Input Menu icon.
- 2 Press the Point ▲▼ buttons to move the red arrow pointer to Computer 1 (Digital), and then press the SELECT button.
- 3 After the Source Select Menu appeared for Computer 1 (Digital), move the pointer to RGB (PC digital) or RGB (AV HDCP), and then press the SELECT button.

### Input Menu

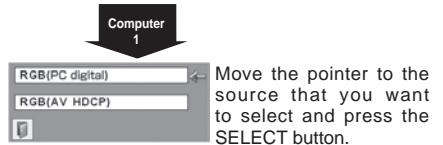
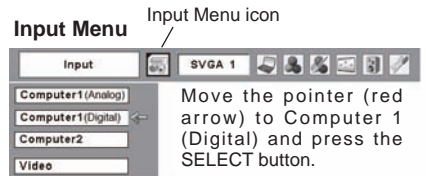

✓ Notes:

- HDCP (High-bandwidth Digital Content Protection) is a system for protecting digital entertainment content delivered by DVI (Digital Visual Interface) from being copied. The specification of HDCP is decided and controlled by Digital Content Protection, LLC. Should the specification be changed, this projector may not display the digital content protected by HDCP.
- When the Input Search function is set On1 or On2, the input signal will be searched automatically (p.46)

## Computer System Selection

This projector automatically tunes to various types of computers based on VGA, SVGA, XGA, SXGA, WXGA, or UXGA with its Multi-scan system and Auto PC Adjustment. If Computer is selected as a signal source, this projector automatically detects the signal format and tunes to project a proper image without any additional setting. (Signal formats provided in this projector is shown on pages 73-74)

One of the following messages may appear when:

**Auto** The projector cannot recognize the connected signal conforming to the provided PC Systems. The message "Auto" is displayed on the PC System Menu icon and the Auto PC Adjustment function works to display proper images. If the image is not projected properly, a manual adjustment is required. (pp.29-30)

**----** There is no signal input from computer. Check the connection between your computer and the projector. (See "Troubleshooting" on pages 65-67.)

**Mode 1** The preset system is manually adjusted in the PC Adjust Menu. The adjusted data can be stored in Mode 1 ~ 5. (pp.29-30)

**SVGA 1** PC Systems provided in this projector is chosen. The projector chooses a proper system provided in the projector and displays it.

\*Mode 1 and SVGA 1 are examples.

### PC System Menu

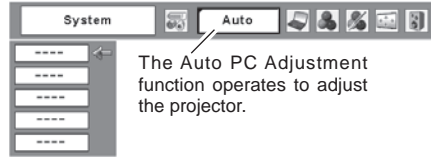

### PC System Menu

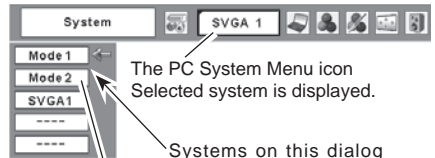

### Selecting Computer System Manually

PC system can also be selected manually.

- 1 Press the MENU button to display the On-Screen Menu. Press the Point ◀▶ buttons to move the red frame pointer to the PC System Menu icon.
- 2 Press the Point ▲▼ buttons to move the red arrow pointer to the system that you want to set, and then press the SELECT button.

Custom Mode (1 ~ 5) set in the PC Adjust Menu. (p.30)

## Auto PC Adjustment

Auto PC Adjustment function is provided to automatically adjust Fine sync, Total dots, Horizontal, and Vertical to conform to your computer. Auto PC Adjustment function can be operated as follows.

### Direct Operation

The Auto PC adjustment function can be operated directly by pressing the AUTO SETUP button on the top control or the AUTO SET button on the remote control. (p.46)

### Menu Operation

#### Auto PC Adj.

- 1 Press the MENU button to display the On-Screen Menu. Press the Point ◀▶ buttons to move the red frame pointer to PC Adjust Menu icon.
- 2 Press the Point ▲▼ buttons to move the red frame pointer to Auto PC Adj. item and then press the SELECT button twice.

### To store adjustment parameters

Adjustment parameters from Auto PC Adjustment can be memorized in this projector. Once parameters are memorized, the setting can be done just by selecting Mode in the PC System Menu (p.27). See "Store" on page 30.

### ✓ Notes:

- Fine sync, Total dots, Horizontal, and Vertical of some computers cannot be fully adjusted with this Auto PC Adjustment function. When the image is not provided properly with this operation, manual adjustments are required. (pp.29-30)
- The Auto PC Adjustment cannot be operated when 480i, 575i, 480p, 575p, 720p, 1035i, or 1080i is selected in the PC System Menu, or when the digital signal is input into DVI terminal. (p.27)

### Remote Control

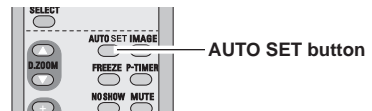

### Top Control

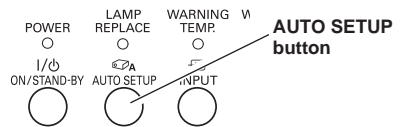

### PC Adjust Menu

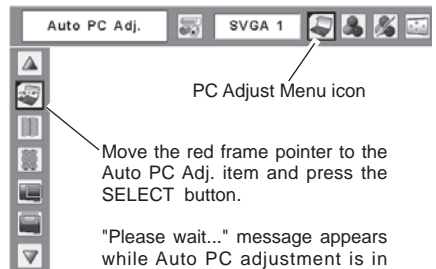

## Manual PC Adjustment

Some computers employ special signal formats which may not be tuned by Multi-scan system of this projector. Manual PC Adjustment enables you to precisely adjust several parameters to match those signal formats. The projector has 5 independent memory areas to memorize those parameters manually adjusted. It allows you to recall the setting for a specific computer.

- 1 Press the MENU button to display the On-Screen Menu. Press the Point ◀▶ buttons to move the red frame pointer to the PC Adjust Menu icon.
- 2 Press the Point ▲▼ buttons to move the red frame pointer to the item that you want to adjust and then press the SELECT button to display the adjustment dialog box. Press the Point ◀▶ buttons to adjust the value.

### Fine sync

Eliminate flicker from the image displayed. Press the Point ◀▶ buttons to adjust the value. (From 0 to 31.)

### Total dots

Adjust the number of total dots in one horizontal period. Press the Point ◀▶ buttons to adjust number to match your PC image.

### Horizontal

Press the Point ◀▶ buttons to adjust the horizontal picture position.

### Vertical

Press the Point ◀▶ buttons to adjust the vertical picture position.

### Current mode

Press the SELECT button to show H-sync freq. and V-sync freq. of the connected computer.

### Clamp

Adjust clamp level. When the image has dark bars, try this adjustment.

**PC Adjust Menu** PC Adjust Menu icon

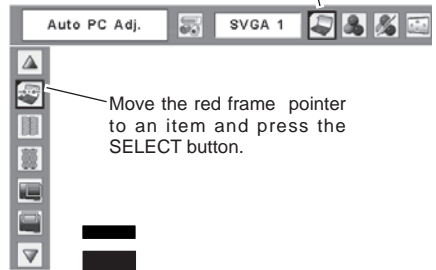

Move the red frame pointer to an item and press the SELECT button.

Status (Stored/Free) of the selected Mode.

Selected Mode

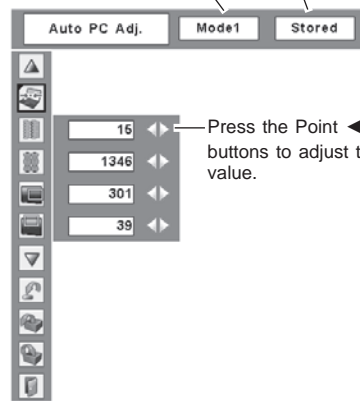

Press the Point ◀▶ buttons to adjust the value.

Current mode Mode1 Stored

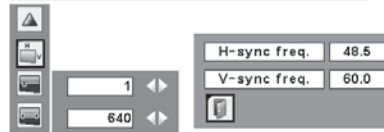

Press the SELECT button at the Current mode item to show the information of the connected computer.

# Computer Input

## Display area H

Adjust the horizontal area displayed by this projector. Press the Point ◀▶ buttons to decrease/increase the value.

## Display area V

Adjust the vertical area displayed by this projector. Press the Point ◀▶ buttons to decrease/increase the value.

## Reset

To reset the adjusted data, select Reset and press the SELECT button. The confirmation box appears and then select [Yes]. All adjustments return to their previous figures.

## Mode free

To clear the stored data, move the red frame pointer to the Mode free item and then press the SELECT button. Move the red arrow pointer to the Mode that you want to clear and then press the SELECT button.

## Store

To store adjusted data, move the red frame pointer to the Store item and then press the SELECT button. Move the red arrow pointer to any of Mode 1 to 5 in which you want to store and then press the SELECT button.

## Quit

Exit the PC Adjust Menu.

### ✓ Note:

- Display area (H/V) cannot be selected when 480i, 575i, 480p, 575p, 720p, 1035i, or 1080i is selected in the PC System Menu (p.27).
- PC Adjust Menu cannot be selected when Computer 1(Digital) is selected in the Input Menu. (p.26)

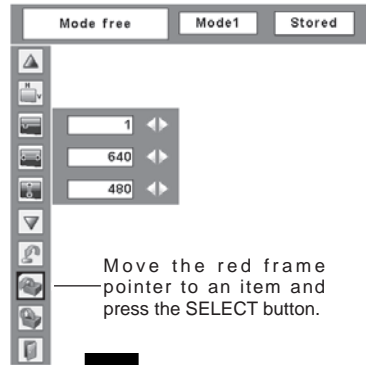

Move the red frame pointer to an item and press the SELECT button.



This Mode has stored parameters.

## To clear adjusted data

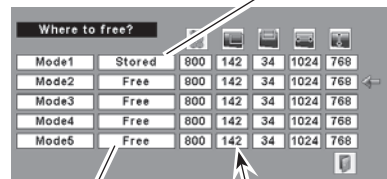

Vacant Mode

Values of "Total dots", "Horizontal", "Vertical", "Display area H" and "Display area V".

## To store adjusted data

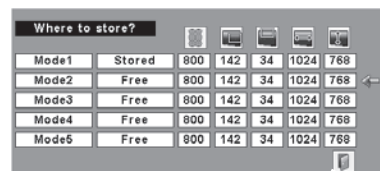

Close this dialog box.

## Image Level Selection

### Direct Operation

Select an image level among Dynamic, Standard, Real, Blackboard (Green), Colorboard, Image 1, Image 2, Image 3, and Image 4 by pressing the IMAGE button on the remote control.

### Dynamic

Picture level suitable for viewing picture in a bright room.

### Standard

Normal picture level preset on this projector.

### Real

Picture level with improved halftone for graphics.

### Blackboard (Green)

Picture level suitable for the image projected on a blackboard. This mode assists to enhance the image projected on a blackboard. This is mainly effective on a green colored board, not truly effective on a black colored board.

### Colorboard

At the time of simple projection on the colored wall, you can get the close color image to the color image projected on a white screen by selecting the similar color to the wall color from the preset four colors.

### Image 1 ~ 4

User preset image in the Image Adjust Menu. (pp.33-34)

### Remote Control

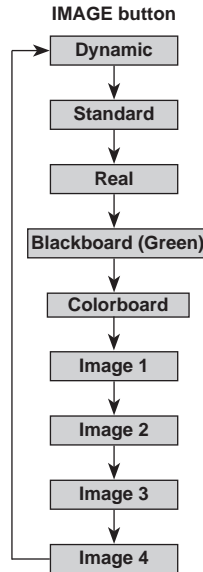
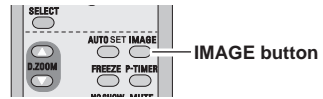



## Menu Operation

- 1 Press the MENU button to display the On-Screen Menu. Press the Point ◀▶ buttons to move the red frame pointer to the Image Select Menu icon.
- 2 Press the Point ▲▼ buttons to move the red frame pointer to the level that you want to set and then press the SELECT button.

### **Dynamic**

Picture level suitable for viewing picture in a bright room.

### **Standard**

Normal picture level preset on this projector.

### **Real**

Picture level with improved halftone for graphics.

### **Blackboard (Green)**

Picture level suitable for the image projected on a blackboard. See above for further description.

### **Colorboard**

At the time of simple projection on the colored wall, you can get the close color image to the color image projected on a white screen by selecting the similar color to the wall color from the preset four colors. Press the SELECT button to choose the color.

### **Image 1 ~ 4**

User preset image in the Image Adjust Menu. (pp.33-34)

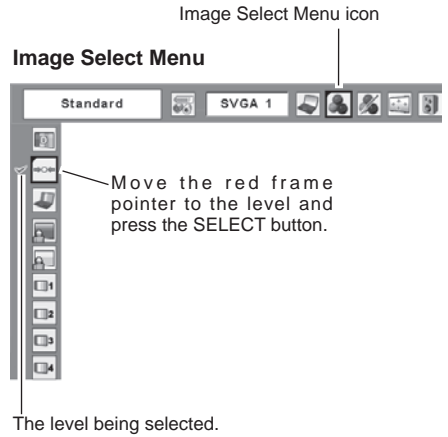

## Image Level Adjustment

- 1 Press the MENU button to display the On-Screen Menu. Press the Point ◀▶ buttons to move the red frame pointer to the Image Adjust Menu icon.
- 2 Press the Point ▲▼ buttons to move the red frame pointer to the item that you want to adjust, and then press the SELECT button. The level of each item is displayed. Adjust each level by pressing the Point ◀▶ buttons.

### Contrast

Press the Point ◀ button to decrease the contrast and the Point ▶ button to increase contrast. (From 0 to 63.)

### Brightness

Press the Point ◀ button to adjust the image darker and the Point ▶ button to adjust the image brighter. (From 0 to 63.)

### Color temp.

Press the Point ◀ button or the Point ▶ button for Color temp. level that you want to select. (XLow, Low, Mid, or High)

### White balance (Red)

Press the Point ◀ button to lighten the red tone and the Point ▶ button to deepen the red tone. (From 0 to 63.)

### White balance (Green)

Press the Point ◀ button to lighten the green tone and the Point ▶ button to deepen the green tone. (From 0 to 63.)

### White balance (Blue)

Press the Point ◀ button to lighten the blue tone and the Point ▶ button to deepen the blue tone. (From 0 to 63.)

### Sharpness

Press the Point ◀ button to soften the image and the Point ▶ button to sharpen the image. (From 0 to 15.)

### Gamma

Press the Point ◀▶ buttons to obtain better balance of contrast. (From 0 to 15.)

### Reset

To reset the adjusted data, select Reset and press the SELECT button. The confirmation box appears and then select [Yes]. All adjustments returns to their previous figures.

## Image Adjust Menu

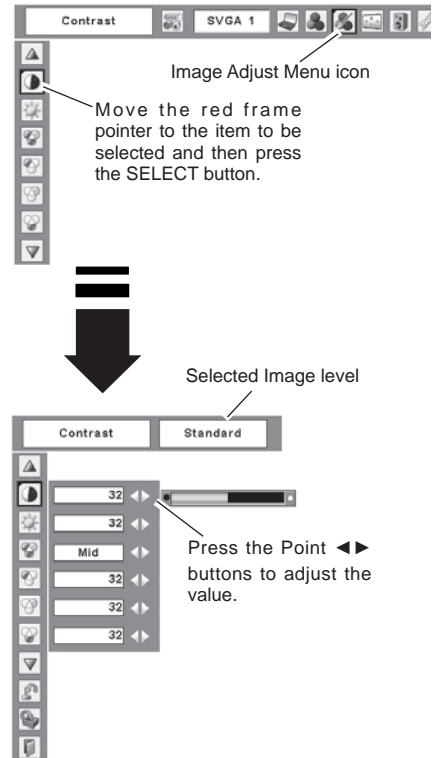

### ✓ Note:

After adjusting any of the White balance Red, Green, or Blue, the Color temp changes to "Adj."

## Store

To store the adjusted data, select Store and press the SELECT button. Select a level from Image 1 to 4 with the Point ▲▼ buttons and press the SELECT button. A confirmation box appears and then select [Yes]. Stored data can be called up by selecting "Image" in the Image Level Selection on page 31.

## Quit

Exit the Image Adjust Menu.

## Screen Size Adjustment

This projector has the picture screen resize function, which enables you to customize the image size.

- 1 Press the MENU button to display the On-Screen Menu. Press the Point ◀▶ buttons to move the red frame pointer to the Screen Menu icon.
- 2 Press the Point ▲▼ buttons and move the red frame pointer to the function that you want to select and then press the SELECT button.

## Normal

Provide the image to fit the screen size.

## True

Provide the image in its original size. When the original image size is larger than the screen size (1024 x 768), this projector enters panning mode automatically. Pan the image with Point ▲▼◀▶ buttons. When adjusted, the arrows turn red. When reached to the correction limit, the arrows disappear.

### ✓ Notes:

- This Screen Menu, except for "Normal" and "Custom", cannot be operated when 720p(HDTV), 1035i (HDTV), or 1080i (HDTV) is selected in the PC System Menu (p.27).
- The projector cannot display any resolution higher than 1600x1200. If your computer's screen resolution is higher than it, reset the resolution to the lower before connecting to the projector.
- The image data in other than XGA (1024x768) is modified to fit the screen size in initial mode.
- True, Full, and Digital zoom +/- cannot be selected when 480i, 575i, 480p, or 575p is selected in the PC System Menu (p.27).

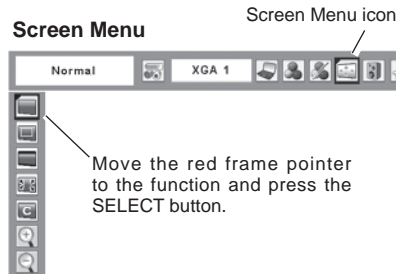
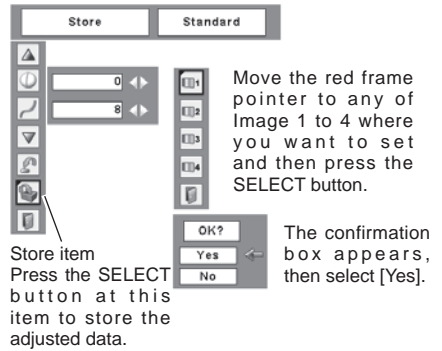

 **Wide**

Provide the image to fit wide video aspect ratio (16:9) by expanding the image width uniformly. This function can be used for providing a squeezed video signal at 16:9.

 **Full**

Provide the full screen image.

 **Custom**

Adjust the screen scale and position manually with this function.

Press the SELECT button at Custom and the "Custom" is displayed on the screen for a few seconds and then the Aspect dialog box appears.

- Scale H/V ..... Adjust the Horizontal/Vertical screen scale.
- H&V..... When set to "On", the aspect ratio is fixed. The "Scale V" appears dimmed and becomes unavailable. Adjust the "Scale H", then the screen scale is automatically modified based on the aspect ratio.
- Position H/V..... Adjust the Horizontal/Vertical screen position.
- Common ..... Save the adjusted scale to all the inputs. Press the SELECT button at Common to display a confirmation box. To save the scale, press the SELECT button at "Yes", When Custom is selected, the saved scale is used.
- Reset..... Reset the all adjusted values. Press the SELECT button at Reset to display a confirmation box. To reset, press the SELECT button at "Yes".

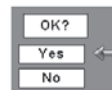
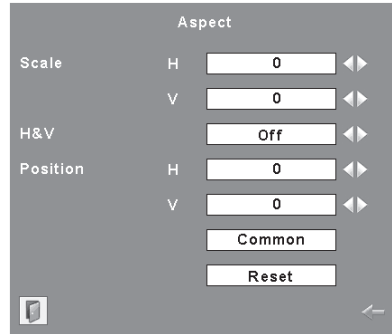

Press the SELECT button at Common or Reset, to display a confirmation box.

✓ **Notes:**

- When no signal is detected, "Normal" is set automatically and the Aspect dialog box disappears.
- The adjustable range for Scale H/V and Position H/V is limited depending on the input signal.

## For zooming in and out the images

### Digital zoom +

When the Digital zoom + is selected, the On-Screen Menu disappears and the message "D. zoom +" is displayed. Press the SELECT button to expand the image size. And press the Point ▲▼◀▶ buttons to pan the image. The Panning function can work only when the image is larger than the screen size.

A projected image can be also expanded by pressing the D.ZOOM ▲ button on the remote control.

### Digital zoom -

When Digital zoom - is selected, the On-Screen Menu disappears and the message "D. zoom -" is displayed. Press the SELECT button to compress image size.

A projected image can be also compressed by pressing the D.ZOOM ▼ button on the remote control.

To exit the Digital zoom +/- mode, press any button except the D.ZOOM ▲▼ buttons, SELECT, and Point buttons.

To return to the previous screen size, select a screen size from the Screen Size Adjustment or select an input source from the Input Source Selection (p.26) again, or adjust the screen size with the D.ZOOM ▲▼ buttons.

## Remote Control

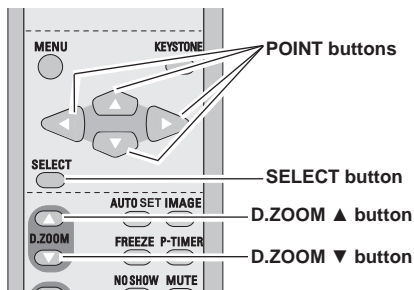

### ✓ Notes:

- The panning function may not operate properly if the stored Mode in the PC Adjust Menu is used. (p.30)
- The minimum compression ratio can be limited depending on the input signal or when the Keystone function is working or when the Custom is selected for the screen size.
- True, Full, and Digital zoom +/- cannot be selected when 480i, 575i, 480p, or 575p is selected in the PC System Menu. (p.27)
- Digital zoom +/- cannot be selected when Full or True is selected.

# Video Input

## Input Source Selection (Video, S-video)

### Direct Operation

Choose Video by pressing the INPUT button on the top control or choose Video by pressing the VIDEO button on the remote control.

Before using these buttons, correct input source should be selected through menu operation as described below.

### Top Control

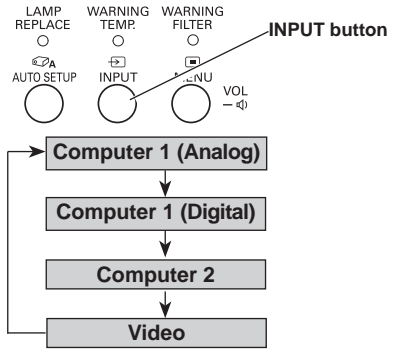

### Remote Control

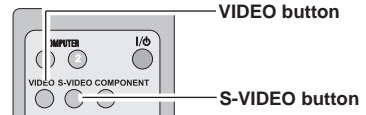

### Menu Operation

- 1 Press the MENU button to display the On-Screen Menu. Press the Point ◀▶ buttons to move the red frame pointer to the Input Menu icon.
- 2 Press the Point ▲▼ buttons to move the red arrow pointer to Video, and then press the SELECT button.
- 3 Move the pointer to the desired source and then press the SELECT button.

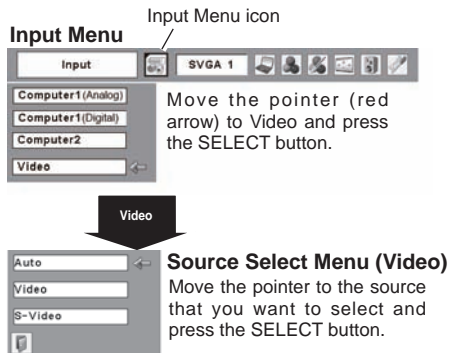

### ✓ Note:

When the Input Search function is set On1 or On2, the input signal will be searched automatically (p.46)

## Input Source Selection (Component, RGB Scart 21-pin)

### Direct Operation

Choose Computer 2 by pressing the INPUT button on the top control or press the COMPUTER 2 button on the remote control. Choose Component by pressing COMPONENT button on the remote control.

Before using these buttons, correct input source should be selected through Menu operation as described below.

### Top Control

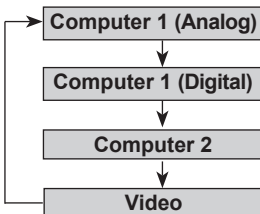
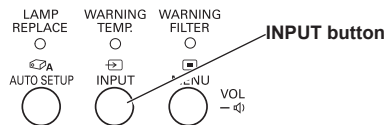

### Remote Control

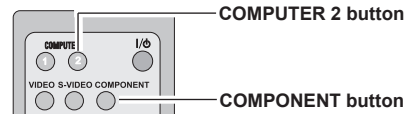

### Menu Operation

- 1 Press the MENU button to display the On-Screen Menu. Press the Point ◀▶ buttons to move the red frame pointer to the Input Menu icon.
- 2 Press the Point ▲▼ buttons to move the red arrow pointer to Computer 2 and then press the SELECT button.
- 3 After the Source Select Menu appeared for Computer 2, move the pointer to Component or RGB(Scart) and then press the SELECT button.

### Input Menu

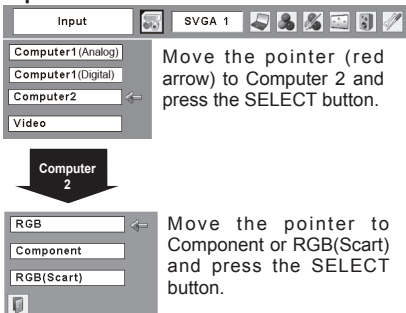

**Component** When the input source is coming from video equipment connected to the COMPUTER IN 2/COMPONENT IN terminal with a Component-VGA Cable, select Component.

**RGB (Scart)** When the input source is coming from video equipment connected to the COMPUTER IN 2/COMPONENT IN terminal with a Scart-VGA Cable, select RGB (Scart).

✓ **Note:**

When the Input Search function is set to “On1” or “On2”, the input signal will be searched automatically (p.46).

## Video System Selection

- 1 Press the MENU button to display the On-Screen Menu. Press the Point ◀▶ buttons to move the red frame pointer to the AV System Menu icon.
- 2 Press the Point ▲▼ buttons to move the red arrow pointer to the system that you want to select and then press the SELECT button.

## Video or S-video

### Auto

The projector automatically detects incoming video system, and adjusts itself to optimize its performance. When Video System is PAL-M or PAL-N, select system manually.

### PAL/SECAM/NTSC/NTSC4.43/PAL-M/PAL-N

If the projector cannot reproduce proper video image, it is necessary to select a specific broadcast signal format among PAL, SECAM, NTSC, NTSC 4.43, PAL-M, and PAL-N.

### AV System Menu (Video or S-video)

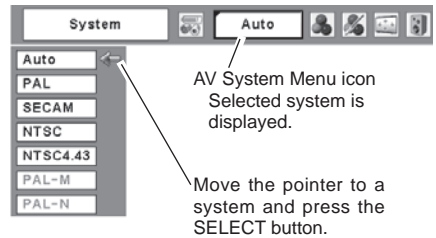

## Component

### Auto

The projector automatically detects incoming video signal, and adjusts itself to optimize its performance.

### COMPONENT VIDEO SIGNAL FORMAT

If the projector cannot reproduce proper video image, it is necessary to select a specific component video signal format among 480i, 575i, 480p, 575p, 720p, 1035i, and 1080i.

### AV System Menu (Component)

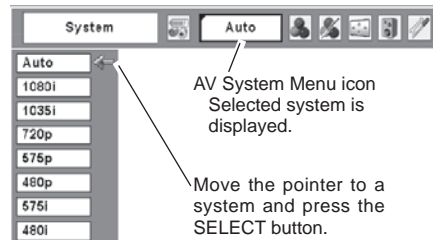

### ✓ Note:

The AV System Menu cannot be selected when selecting RGB (Scart).



## Image Level Selection

### Direct Operation

Select an image level among Dynamic, Standard, Cinema, Blackboard (Green), Colorboard, Image 1, Image 2, Image 3, and Image 4 by pressing the IMAGE button on the remote control.

### Dynamic

Picture level suitable for viewing picture in a bright room.

### Standard

Normal picture level preset on this projector.

### Cinema

Picture level adjusted for the picture with fine tone.

### Blackboard (Green)

Picture level suitable for the image projected on a blackboard. This is mainly effective on a green colored board, not truly effective on a black colored board.

### Colorboard

At the time of simple projection on the colored wall, you can get the close color image to the color image projected on a white screen by selecting the similar color to the wall color from the preset four colors.

### Image 1 ~ 4

User preset image in the Image Adjust Menu (pp.42-43).

### Remote Control

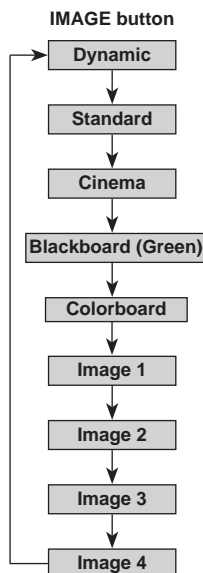
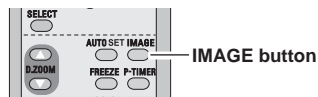

## Menu Operation

- 1 Press the MENU button to display the On-Screen Menu. Press the Point ◀▶ buttons to move the red frame pointer to the Image Select Menu icon.
- 2 Press the Point ▲▼ buttons to move the red frame pointer to the level that you want to set and then press the SELECT button.

### **Dynamic**

Picture level suitable for viewing picture in a bright room.

### **Standard**

Normal picture level preset on this projector.

### **Cinema**

Picture level adjusted for the picture with fine tone.

### **Blackboard (Green)**

Picture level suitable for the image projected on a blackboard. See above for further description.

### **Colorboard**

At the time of simple projection on the colored wall, you can get the close color image to the color image projected on a white screen by selecting the similar color to the wall color from the preset four colors. Press the SELECT button to choose the color.

### **Image 1 ~ 4**

User preset image in the Image Adjust Menu. (pp.42-43)

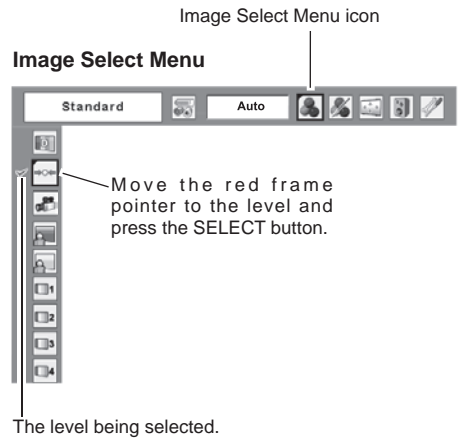

## Image Level Adjustment

- 1 Press the MENU button to display the On-Screen Menu. Press the Point ◀▶ buttons to move the red frame pointer to the Image Adjust Menu icon.
- 2 Press the Point ▲▼ buttons to move the red frame pointer to the item that you want to adjust, and then press the SELECT button. The level of each item is displayed. Adjust each level by pressing the Point ◀▶ buttons.

### Contrast

Press the Point ◀ button to decrease the contrast and the Point ▶ button to increase contrast. (From 0 to 63.)

### Brightness

Press the Point ◀ button to adjust the image darker and the Point ▶ button to adjust the image brighter. (From 0 to 63.)

### Color

Press the Point ◀ button to lighten the color and the Point ▶ button to deepen the color. (From 0 to 63.)

### Tint

Press the Point ◀▶ buttons to obtain a proper color. (From 0 to 63.)

### Color temp.

Press the Point ◀ button or the Point ▶ button for Color temp. level that you want to select. (XLow, Low, Mid, or High)

### White balance (Red)

Press the Point ◀ button to lighten the red tone and the Point ▶ button to deepen the red tone. (From 0 to 63.)

### White balance (Green)

Press the Point ◀ button to lighten the green tone and the Point ▶ button to deepen the green tone. (From 0 to 63.)

### White balance (Blue)

Press the Point ◀ button to lighten the blue tone and the Point ▶ button to deepen the blue tone. (From 0 to 63.)

#### ✓ Notes:

- The Tint cannot be selected when the video system is PAL, SECAM, PAL-M, or PAL-N.
- After adjusting any of the White balance Red, Green, or Blue, the Color temp. changes to "Adj."

## Image Adjust Menu

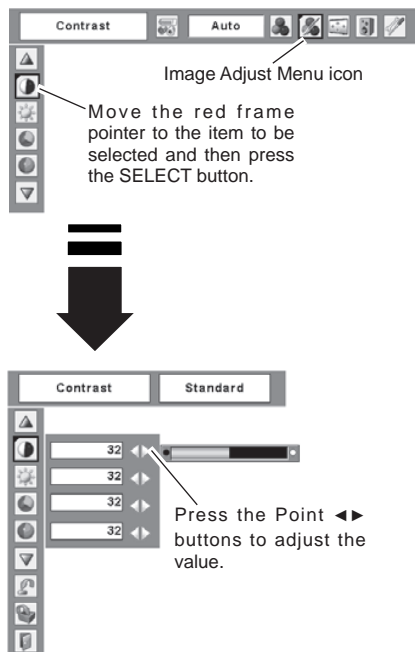

 **Sharpness**

Press the Point ◀ button to soften the image and the Point ▶ button to sharpen the image. (From 0 to 15.)

 **Gamma**

Press the Point ◀▶ buttons to obtain better balance of contrast. (From 0 to 15.)

 **Noise reduction**

Noise interference on the screen can be reduced. Select one of the following to get smoother images.

- Off . . . . disabled.
- L1 . . . . lower reduction
- L2 . . . . higher reduction

 **Progressive**

Interlaced video signal can be displayed in a progressive picture. Select one of the following.

- Off . . . . disabled.
- L1 . . . . Select "L1" for an active picture.
- L2 . . . . Select "L2" for a still picture.
- Film . . . . Select "Film" for watching a film. With this function, the projector reproduces pictures faithful to the original film quality.

 **Reset**

To reset the adjusted data, select Reset and press the SELECT button. The confirmation box appears and then select [Yes]. All adjustments returns to their previous figures.

 **Store**

To store the adjusted data, select Store and press the SELECT button. Select a level from Image 1 to 4 with the Point ▲▼ buttons and press the SELECT button. A confirmation box appears and then select [Yes]. Stored data can be called up by selecting "Image" in the Image Level Selection on pages 40-41.

 **Quit**

Exit the Image Adjust Menu.

✓ **Note:**  
Noise reduction and Progressive cannot be selected when 480p, 575p, 720p, 1035i, or 1080i is selected. (p.39)

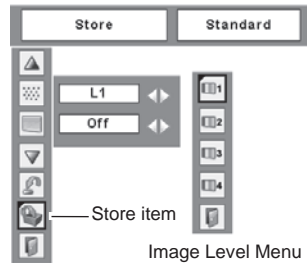

**Image Level Menu**  
Move the red frame pointer to an image item to be set and then press the SELECT button.

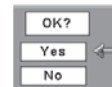

The confirmation box appears and then select [Yes].

## Screen Size Adjustment

This projector has the picture screen resize function, which enables you to customize the image size.

- 1 Press the MENU button to display the On-Screen Menu. Press the Point ◀▶ buttons to move the red frame pointer to the Screen Menu icon.
- 2 Press the Point ▲▼ buttons and move the red frame pointer to the function that you want to select and then press the SELECT button.

### Normal

Provide the image at a normal video aspect ratio of 4:3.

### Wide

Provide the image at a wide screen ratio of 16:9.

### Custom

Adjust the screen scale and position manually with this function. Press the SELECT button at Custom and the "Custom" is displayed on the screen for a few seconds and then the Aspect dialog box appears.

- Scale H/V ..... Adjust the Horizontal/Vertical screen scale.
- H&V ..... When set to "On", the aspect ratio is fixed. The "Scale V" appears dimmed and becomes unavailable. Adjust the "Scale H", then the screen scale is automatically modified based on the aspect ratio.
- Position H/V ..... Adjust the Horizontal/Vertical screen position.
- Common ..... Save the adjusted scale to all the inputs. Press the SELECT button at Common to display a confirmation box. To save the scale, press the SELECT button at "Yes". When Custom is selected, the saved scale is used.
- Reset ..... Reset the all adjusted values. Press the SELECT button at Reset to display a confirmation box. To reset, press the SELECT button at "Yes".

### Screen Menu

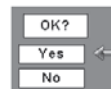
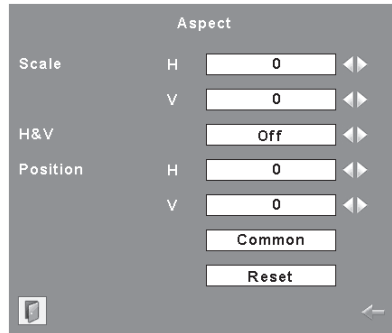
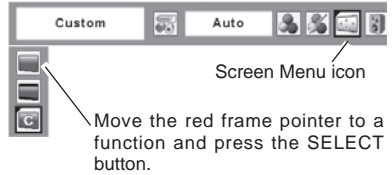

Press the SELECT button at Common or Reset, to display a confirmation box.

### ✓ Notes:

- Wide cannot be operated when 720p, 1035i, or 1080i is selected in the AV System Menu (p.39).
- When no signal is detected, "Normal" is set automatically and the Aspect dialog box disappears.
- The adjustable range for Scale H/V and Position H/V is limited depending on the input signal.

# Setting

## Setting

This projector has Setting menu that allows you to set up the other various functions described as follows:

- 1 Press the MENU button to display the On-Screen Menu. Press the Point ◀▶ buttons to move the red frame pointer to the Setting Menu icon.
- 2 Press the Point ▲▼ buttons to move the red frame pointer to the item that you want to set and then press the SELECT button. The Setting dialog box appears.

### Language

The language used in the On-Screen Menu is available in English, German, French, Italian, Spanish, Portuguese, Dutch, Swedish, Finnish, Polish, Hungarian, Romanian, Russian, Chinese, Korean, or Japanese.

See the next pages for other items.

### Setting Menu (Language)

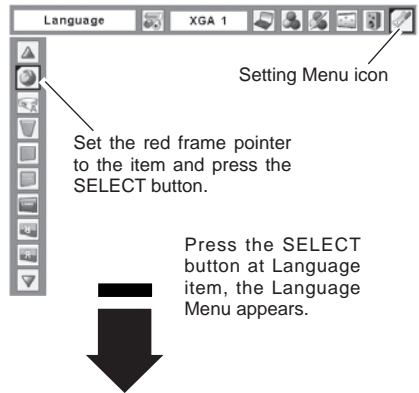

## Auto setup

This function enables Input search, Auto Keystone correction and Auto PC adjustment by pressing the AUTO SETUP button on the top control or the AUTO SET button on the remote control. Settings for those functions can be altered as follows:

### Input search \*

This function detects the input signal automatically. When finding a signal, the search will stop. Use the Point ◀▶ buttons to select one of the following.

- Off . . . . Input search does not work.
- On1 . . . . Input search works under the situation below.
  - When pressing the AUTO SETUP button on the top control or the AUTO SET button on the remote control.
- On2 . . . . Input search works under the situation below.
  - When turning on the projector with pressing the POWER ON/STAND-BY button on the top control or on the remote control.
  - When pressing the AUTO SETUP button on the top control or the AUTO SET button on the remote control.
  - When missing the current input signal.

- \*
- If the No show or Freeze function is active, cancel it to activate the Input search. It is also unavailable when On-Screen menu is displayed.
  - While Input Search is set On1 or On2, the status of Input and Lamp mode are displayed every time the signal is switched.
  - If any of the COMPUTER 1/2, VIDEO, S-VIDEO or COMPONENT buttons on the remote control, or AUTO SETUP button on the top control is pressed while Input search is on, Input search will stop.

### Auto PC Adj.

- On . . . . Enables Auto PC Adjustment when pressing the AUTO SETUP button on the top control.
- Off . . . . Disables Auto PC Adjustment.

### Auto Keystone

- Auto . . . . Always works and corrects keystone distortion according to the projector's tilt.
- Manual . . Works only when pressing the AUTO SETUP button on the top control or the AUTO SET button on the remote control.
- Off . . . . Disables Auto Keystone.

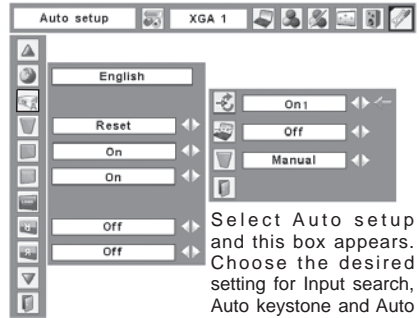

Select Auto setup and this box appears. Choose the desired setting for Input search, Auto keystone and Auto PC adj. with the Point ◀▶ buttons.

### ✓ Notes:

- Input search, Auto PC Adj. and Auto Keystone cannot be set "Off" at the same time.
- Auto Keystone adjusts automatically by pressing the AUTO SETUP button either it is set on "Auto" or "Manual" in setting menu.
- Auto Keystone corrects vertical distortion only, not correct horizontal distortion.
- The Auto Keystone cannot work when Ceiling feature is set "On" in the Setting menu (p.50).
- Perfect correction of the image distortion cannot be ensured with the Auto setup function. If the distortion is not corrected properly by pressing the AUTO SETUP button, adjust manually by pressing the KEYSTONE button on the remote control or selecting Keystone in the Setting menu (pp.22, 24, 47).
- Fine sync, Total dots, Horizontal and Vertical position of some computers cannot be fully adjusted with the Auto PC Adjustment function. When the image is not provided properly with this operation, manual adjustments are required (pp.29–30).

 **Keystone**

This function corrects distortion of a projected image. Select either Store or Reset with the Point ◀▶ buttons, and then press the SELECT button. The keystone dialog box appears. Correct keystone with the Point ▲▼ buttons. see page 22.

Store . . . . store the keystone correction even when the AC power cord is unplugged.

Reset . . . . reset the keystone correction when the AC power cord is unplugged.

 **Blue back**

Press the Point ◀▶ buttons to switch On/Off. When this function is "On", a blue image is displayed while the input signal is not detected.

 **Display**

Press the Point ◀▶ buttons to switch Off/Countdown off/On. This function decides to display On-Screen Displays.

Off. . . . . Do not show On-Screen Displays, except.

Countdown off . . . Show the input image instead of the countdown when turning on the projector. Use this function when you want to project the image as early as possible even when the lamp is not bright enough.

On. . . . . Show all the On-Screen Displays. Use this function when you want to project images after the lamp becomes bright enough. Factory default setting is this mode.

- On-Screen Menu
- "Power off?" message
- P-Timer
- "No signal" message for Power management item. (p.50)
- "Please wait ..." for Auto PC adjustment.
- Arrows for panning mode in the Screen Menu. (p.34)



## Logo (Logo and Logo PIN code lock settings)

This function allows you to customize the screen logo with Logo select, Capture, and Logo PIN code lock functions.

### ✓ Note:

When On is selected in Logo PIN code lock function, Logo select and Capture functions cannot be selected.

## Logo select

This function decides the start-up display as follows:

- User . . . . the image you captured
- Default . . . the factory-set logo
- Off . . . . . countdown only

## Capture

This function enables you to capture the image being projected and use it for a start-up display or interval of presentations.

After capturing the projected image, go to the Logo select function and set it to "User". Then the captured image is displayed when turning on the projector next time or pressing the NO SHOW button. (p.24)

To capture the image, select [Yes]. To cancel the Capture function, select [No].

### ✓ Notes:

- Before capturing an image, select Standard in the Image Select Menu to capture a proper image. (pp.31-32, 40-41)
- A signal from a computer can be captured up to XGA (1024x768). A signal from video equipment can be captured except for 720p, 1035i, and 1080i.
- When capturing the image that has been adjusted by the Keystone function, the adjustment data is automatically reset and the projector captures an image without keystone adjustment.
- When the Logo PIN code lock function is "On", Capture menu cannot be selected.
- When starting to capture a new image, the previously stored image is cleared even if you cancel the capturing.
- "User" cannot be selected when the image is not captured.

## Logo select

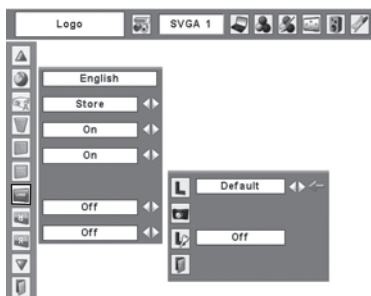

## Capture

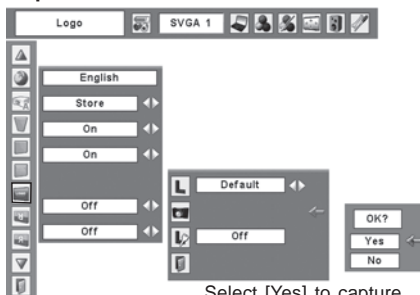

Select [Yes] to capture the projected image.



 **Logo PIN code lock**

This function prevents an unauthorized person from changing the screen logo.

- Off . . . . . the screen logo can be changed freely from the Logo select menu. (p.48)
- On . . . . . the screen logo cannot be changed without the Logo PIN code.

If you want to change the Logo PIN code lock setting, enter a Logo PIN code along the following steps. The initial Logo PIN code is set "4321" at the factory.

**To Enter the Logo PIN code**

Select a number by pressing the Point ▲▼ buttons. And then press the Point ►button to fix the number and move the pointer. The number changes to "\*". If you fixed an incorrect number, move the pointer to the number you want to correct by pressing the Point ◀ button, and then select the correct number by pressing the Point ▲▼ buttons.

Repeat this step to complete entering a four-digit number.

After entering the four-digit number, move the pointer to "Set" by pressing the Point ►button. Press the SELECT button so that you can change the Logo PIN code lock setting.

If you entered an incorrect Logo PIN code, "Logo PIN code" and the number (\*\*\*\*) turns red. Enter a correct Logo PIN code all over again.

**To Change the Logo PIN code**

Logo PIN code can be changed to your desired four-digit number. Select "Logo PIN code change" with the Point ▼button and press the SELECT button. Set a new Logo PIN code.

Be sure to note the new Logo PIN code and keep it on hand. If you lost the number, you could no longer change the Logo PIN code setting. For details on PIN code setting, refer to relevant instructions of the PIN code lock function on pages 53 and 54.

**CAUTION:**  
**WHEN YOU HAVE CHANGED THE LOGO PIN CODE, WRITE DOWN THE NEW PIN CODE IN COLUMN OF THE LOGO PIN CODE NO. MEMO ON PAGE 79, AND KEEP IT SECURELY. SHOULD THE LOGO PIN CODE BE LOST OR FORGOTTEN, THE PROJECTOR CAN NO LONGER BE OPERATED.**

**Logo PIN code lock**

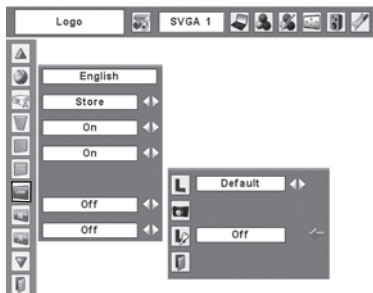

**Logo PIN code lock Dialog Box**

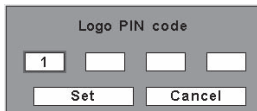

After a correct Logo PIN code is entered, the following dialog box appears.



Select On/Off by pressing the Point ◀► buttons or change the Logo PIN code.

## Ceiling

When this function is "On", the picture is top/bottom and left/right reversed. This function is used to project the image from a ceiling mounting the projector.

## Ceiling

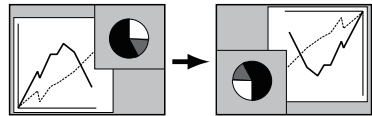

## Rear

When this function is "On", the picture is left/right reversed. This function is used to project the image to a rear projection screen.

## Rear

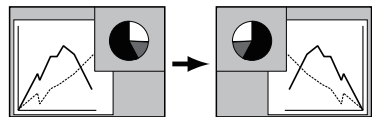

## Standby mode

This function is available when the projector is turned off and in Stand-by. It is recommended to use Eco under normal condition.

Normal . . . . . normal power consumption in Stand-by condition.

Eco . . . . . lower power consumption than Normal mode in Stand-by condition.

## Power management

For reducing power consumption as well as maintaining the lamp life, the Power management function turns off the projection lamp when the projector is not used for a certain period.

When the input signal is interrupted and no button is pressed for more than 30 seconds, the timer display with "No signal" appears. The countdown starts to turn off the lamp.

## Power management



Time left before Lamp is off.

Select one of the operations:

Ready . . . . . When the lamp has been fully cooled down, the POWER indicator changes to green blinking. In this condition, the projection lamp is turned on if the input signal is reconnected or any button on the top control or remote control is pressed.

Shut down . . . . . When the lamp has been fully cooled down, the power is turned off.

Off . . . . . Power management function is off.

Then set the countdown timer with the Point ◀▶ buttons.

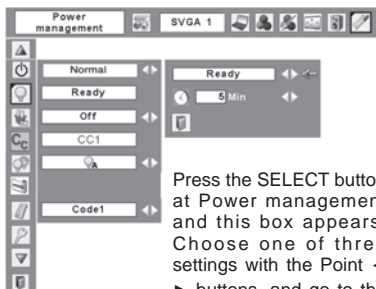

Press the SELECT button at Power management and this box appears. Choose one of three settings with the Point ◀ ▶ buttons, and go to the timer with the Point ▲ ▼ buttons and set time with the Point ◀▶ buttons.

✓ Note:

Factory default is " Ready, 5 min".

 **On start**

When this function is "On", the projector is automatically turned on just by connecting the AC power cord to a wall outlet.

✓ **Note:**

Be sure to turn the projector off properly (see "Turning Off the Projector" on page 19). If the projector is turned off in the incorrect sequence, the On start function does not operate properly.

**On start**

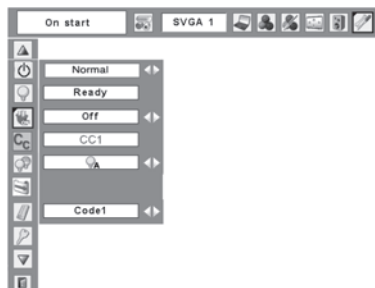

 **Closed Caption**

Closed Caption is a printed version of the program sound or other information displayed on the screen. If the input signal contains closed captions, you can turn on the feature and switch the channels. Press the Point ◀▶ buttons to select CC1, CC2, CC3 or CC4. If the closed caption is not clear, you can change the text from Color to White.

✓ **Notes:**

The Closed Caption is available only under the situation below.

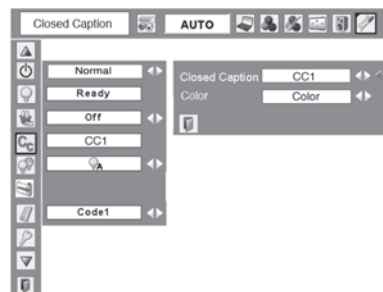

- When the input signal is NTSC of composite and S-video, and the system is set according to the signal or set on "Auto".
- The system must be set on NTSC or Auto in Video System Selection. (P.39)
- The icon of Closed Caption is displayed in gray while it is not available.
- The closed caption is unavailable when On-Screen menu and P-Timer are displayed.

**Closed Caption**



 **Lamp control**

This function allows you to change brightness of the screen.

-  Normal . . . . . normal brightness
-  Auto . . . . . brightness according with the input signal
-  Eco . . . . . lower brightness reduces the lamp power consumption and extends the lamp life.

✓ **Note:**

Lamp mode cannot be changed for a while after turning on the projector. Lamp needs some time to stabilize after the power is turned on. Stored lamp mode will be active after the lamp is stabilized.

## Filter control

You can replace the filter with this function. Press the SELECT button at Filter control to display a confirmation box. To replace, press the SELECT button at "YES" and the electrically operated filter starts to scroll.

✓ **Note:**

- Filter replacement icon and "Please wait..." message appear on the screen when the filter is being scrolled.
- The filter cannot be rewound.
- When the filter is replaced, the total accumulated time of the filter use is automatically set to 0.

## Filter control

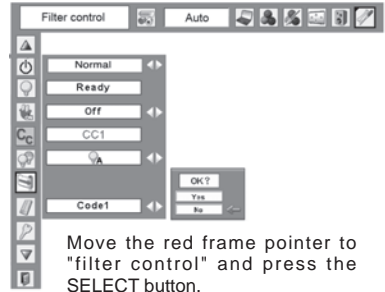

## Remote control

This projector provides two different remote control codes: the factory-set initial code (Code 1) and the secondary code (Code 2). This switching function prevents remote control interference when operating several projectors or video equipment at the same time.

When operating the projector in "Code 2", both the projector and the remote control must be switched to "Code 2".

### To change the code for the projector:

Select either "Code 1" or "Code 2" in this Setting Menu.

### To change the code for the remote control:

Press and hold both the MENU and IMAGE buttons together for 5 seconds or more. After changing the code, make sure the remote control operates properly.

## Remote control

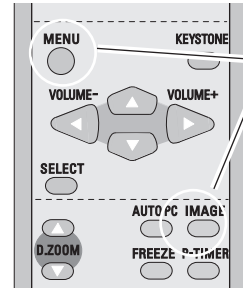

Press and hold MENU and IMAGE buttons for more than 5 seconds.

✓ **Note:**



If the batteries are removed from the remote control for a long period of time, the remote control code will be reset.

 **Security (Key lock and PIN code lock settings)**

This function allows you to use Key lock and PIN code lock function to set the security for the projector operation.

 **Key lock**

This function locks operation of the top control or the remote control. It is useful to prevent operation by an unauthorized person.

-  . . . . . not locked.
-  . . . . . lock the operation of the top control. To unlock, use the remote control.
-  . . . . . lock the operation of the remote control. To unlock, use the top control.

If the top control accidentally becomes locked and you do not have the remote control or there is something wrong with your remote control, contact the dealer where you purchased the projector or the service center.

 **PIN code lock**

This function prevents the projector from being operated by an unauthorized person and provides the following settings for security options.

- Off . . . . . the projector is not locked with a PIN code.
- On1 . . . . . require to enter a PIN code every time turning on the projector.
- On2 . . . . . require to enter a PIN code to operate the projector once the power cord is disconnected; as long as the AC power cord is connected, the projector can be operated without a PIN code.

Whenever to change the PIN code lock setting or the PIN code (the four-digit number), you are required to enter the PIN code. The "1234" is set as the initial PIN code at the factory.

**Key lock**

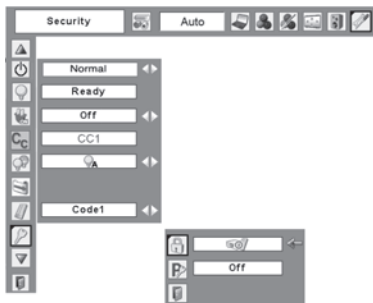

Select Key lock. Choose one of the alternatives with the Point ▲ ▼ buttons and select [Yes] to activate it.



**PIN code lock**

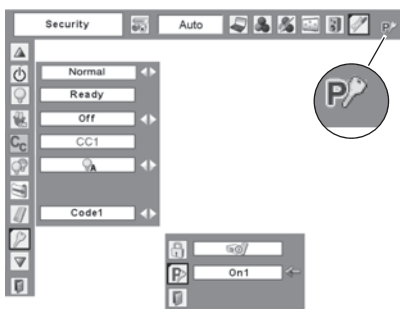

When the projector is locked with the PIN code, the PIN code lock mark appears on the menu bar.

## To Enter the PIN code

Select a number by pressing the Point ▲▼ buttons. And then press the Point ► button to fix the number and move the pointer. The number changes to "\*". If you fixed an incorrect number, move the pointer to the number you want to correct by pressing the Point ◀ button, and then select the correct number by pressing the Point ▲▼ buttons.

Repeat this step to complete entering a four-digit number.

After entering the four-digit number, move the pointer to "Set" by pressing the Point ► button. Press the SELECT button so that you can change the following PIN code lock settings.

If you entered an incorrect PIN code, "PIN code" and the number (\*\*\*\*) turns red. Enter a correct PIN code all over again.

## To Change the PIN code lock setting

Select Off, On1, or On2 with the Point ◀► buttons and then move the red frame pointer to "Quit" with the Point ▼ button. Press the SELECT button to close the dialog box.

## To Change the PIN code

The PIN code can be changed to your desired four-digit number.

Select "PIN code change" with the Point ▼ button, and press the SELECT button to display the New PIN code input dialog box.

Select a number by pressing the Point ▲▼ buttons. And then press the Point ► button to fix the number and move the pointer. Repeat it to complete entering a four-digit number. After entering the four-digit number, move the pointer to "Set" by pressing the Point ► button. Then press the SELECT button.

**CAUTION:**  
**WHEN YOU HAVE CHANGED THE PIN CODE, WRITE DOWN THE NEW PIN CODE IN COLUMN OF THE PIN CODE NO. MEMO ON PAGE 79, AND KEEP IT SECURELY. IF YOU FORGET YOUR PIN CODE, THE PROJECTOR CAN NO LONGER BE STARTED.**

## Enter a PIN code

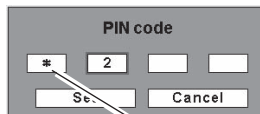
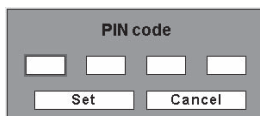

The input numbers change to "\*" for security.

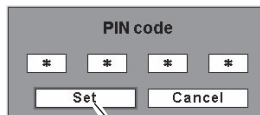

Move the pointer to "Set" by pressing the Point ► button. And then press the SELECT button.

## Change the PIN code lock setting



Select a desired setting with the Point ◀► buttons.

## Change the PIN code



Select PIN code change and press the SELECT button. The New PIN code input dialog box appears.

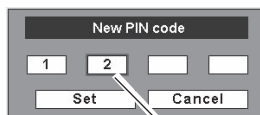

The input numbers are being displayed for confirmation.

**Fan**

This function provides the following alternatives in the cooling fans' operation after turning off the projector. (p.19)

- L1. . . . . normal operation
- L2. . . . . slower and lower-sound than the normal operation (L1), but it takes longer to cool the projector down.

**Warning log**

This function records anomalous operations while the projector is in operation and use it when diagnosing faults. Up to 10 warning logs are displayed with the latest warning message at the top of the list, followed by previous warning messages in chronological order.

**✓ Note:**

When the Factory default function is executed, all the warning log records will be deleted.

**Lamp counter**

This function is used to reset the lamp replacement counter. When replacing the projection lamp, reset the lamp replacement counter by using this function. See page 62 for operation.

**✓ Note:**

Do not reset the Lamp replacement counter without implementation of lamp replacement. Be sure to reset the Lamp replacement counter only after replacing the lamp.

Lamp replacement icon

**Lamp replacement**



This icon appears on the screen when the end of lamp life is reached.

**✓ Note:**

This icon also appears at turning on and selecting input source.



## Filter counter

This function is used to set a frequency for the filter replacement.

Use the Point ▲▼ buttons to move the red frame pointer to Filter counter and then press the SELECT button. A dialog box appears showing the Used time option and the Scrolls remaining option.

**Used Time . . . . .** Show the total accumulated time of the filter use, timer setting option and the Reset options. When the projector reaches a time set in the timer setting, the Filter replacement icon (Fig. 1) appears on the screen and the total accumulated time turns red, indicating that the filter replacement is necessary. If the filter is out of scroll and the projector reaches a time set in the timer setting, Fig. 2 appears on the screen, indicating that the filter cartridge replacement is necessary.

**Scrolls remaining. . .** Show the scroll counter and the Reset options. When the filter scroll is counted down to 1 (Scroll counter on the screen is showing “0 scroll(s)”), the last scroll icon (Fig. 3) appears on the screen. When the filter scroll is counted down to 0, the Filter cartridge replacement icon (Fig. 4) appears on the screen and the WARNING FILTER indicator lights orange, indicating that the filter cartridge replacement is necessary.

To set a timer, press the SELECT button on Used time option. Move the red arrow pointer to the timer setting option and use the Point ◀▶ buttons to select from (Off/400H/700H/1000H) depending on the use environment. When replacing the Filter cartridge, reset the Filter counter and the Scroll counter (p.59).

✓Note:

- Do not reset the counter(s) when the filter or the filter cartridge are not replaced.
- Timer setting notifies that the filter needs replacement. To replace the filter, use the filter control function (p.52).

## Factory default

This function returns all setting values except for the user logo, PIN code lock, Logo PIN code lock, and the lamp counter to the factory default settings.

## Quit

Exit the Setting Menu.

## Filter counter

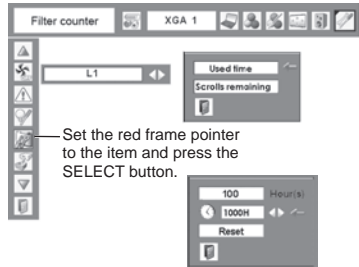

Set the red frame pointer to the item and press the SELECT button.

Use the Point ◀▶ buttons to set the timer. Select from (Off/400H/700H/1000H) depending on the use environment.

Fig.1 Filter replacement icon



Filter replacement icon appears on the screen at a set time.

Fig.2



Fig.3 Last scroll icon



Last scroll icon appears on the screen when the filter is down to the last scroll.

Fig.4 Filter cartridge replacement icon



Filter cartridge replacement icon appears on the screen when the filter scroll is counted down to 0 scroll.

✓Note:

- Fig.1, Fig. 2, Fig. 3 and Fig. 4 appear at turning on and selecting input source.
- Fig.1, Fig. 2, Fig. 3 and Fig. 4 will not appear when the Display function is set to “Off” (p.47), during “Freeze” (p.23), or “No show” (p.24).

## Factory default

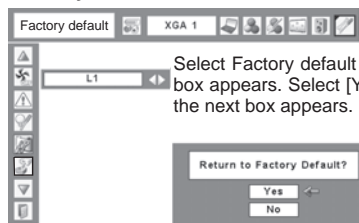

Select Factory default and this box appears. Select [Yes], and the next box appears.



Select [Yes] to activate it.

# Maintenance and Care

## Filter Instructions

Filter prevents dust from accumulating on the optical elements inside the projector. Should the filter becomes clogged with dust particles, it will reduce cooling fans' effectiveness and may result in internal heat buildup and adversely affect the life of the projector. This projector has an electrically operated filter which helps you to replace the filter easily. The projector monitors the condition of the filter at all time and replaces a filter with a new one automatically when it detects the clogging.

If the projector reaches a time set in the timer setting (p.56), a Filter replacement icon (Fig.1) appears on the screen and the WARNING FILTER indicator on the top control lights up . When you see this icon, replace the filter as soon as possible (p.52) and reset the Filter counter (p.59). If the filter is out of scroll and the projector reaches a time set in the timer setting, Fig. 2 appears on the screen, indicating that the filter cartridge replacement is necessary.

When the filter scroll is counted down to 1, the Last scroll icon (Fig.3) appears on the screen, indicating that there is one scroll left in the filter cartridge (p.56).

If the projector detects that the filter is clogged and no scroll is left in the filter cartridge, a Filter cartridge replacement icon (Fig. 4) appears on the screen and the WARNING FILTER indicator on the top control lights up . When you see this icon, replace the filter cartridge (p.58) and reset the Filter counter (p.59) and the Scroll counter (p.59).

When the filter is being scrolled using the Filter control function in the setting menu (p.52), a Filter replacement icon and "Please wait..." message (Fig.5) appear on the screen and the WARNING FILTER indicator blinks slow (approx. 2 seconds ON, 2 seconds OFF).

The WARNING FILTER indicator blinks fast when the projector detects an abnormal condition, the filter cartridge is not installed properly, or the filter scroll is not working properly .

### ✓ Notes:

- Fig.1, Fig.2, Fig.3, Fig. 4 and Fig.5 will not appear when the Display function is set to "Off" (p.47), during "Freeze" (p.23), or "No show" (p.24).
- The filter cannot be rewind.
- The filter can be scrolled 9 times since the filter cartridge has 10 scrolls.
- The filter cartridge is disposable. Do not clean and reuse the filter cartridge.
- Do not expose the filter cartridge to water or liquid, or it may cause a breakdown.
- Replace the filter cartridge after all the scroll is used up. If you replace the filter cartridge when there are some scrolls left in the filter cartridge, the filter counter and the scroll counter do not recognize the correct number of remaining scrolls and the reset function cannot work properly. It may cause a breakdown.
- Do not use the filter cartridge with other projector. The filter counter and the scroll counter do not recognize the correct number of remaining scrolls of the used filter cartridge and the reset function cannot work properly. It may cause a breakdown.



Fig.1 Filter replacement icon



Fig.2



Fig.3 Last scroll icon



Fig.4 Filter cartridge replacement icon



Please wait . . .

Fig.5 Filter replacement icon and "Please wait..." message.

- Make sure that the projection lamp is turn off when you are replacing the filter cartridge. If you replace the filter cartridge when the projection lamp is turn on, the projector will be shut down automatically for safety purpose
- When you forget to reset the filter counter, the projector cannot recognize the correct number of remaining scrolls and may cause a breakdown.
- Do not forget to reset the filter counter and the scroll counter in the setting menu after replacing the filter cartridge. If you forget to reset the filter counter and the scroll counter, the projector cannot recognize the correct number of remaining scrolls and may cause a breakdown.
- When the projector is kept used for 3 minutes without getting the filter cartridge replaced after the Fig.4 appears on the screen, the projector is turned off automatically to prevent the damage of optical components.

### Replacing the Filter Cartridge

- 1 Turn off the projector, and unplug the AC power cord from the AC outlet.
- 2 First, clean up the dust on the projector and around the air vents.
- 3 Loosen 2 screws of the filter cover with a screwdriver and open the filter cover.
- 4 Rotate the handle of the filter and pull out the filter cartridge.
- 5 Put the new one back into the position and rotate back the handle. Make sure that the filter cartridge is properly and fully inserted.
- 6 Connect the AC power cord to the projector and turn on the projector.
- 7 Reset the filter counter and the scroll counter (p.59).



#### CAUTION

Make sure the filter cartridge is inserted in the projector. If the filter cartridge is not inserted, the projector cannot be turned on.

Do not put anything into the air vents. Doing so may result in malfunction of the projector.

#### RECOMMENDATION

We recommend avoiding dusty/smoky environments when operating the projector. Usage in these environments may cause a poor image quality.

When using the projector under dusty or smoky conditions, dust may accumulate on a lens, liquid crystal panels, or optical elements inside the projector. Such condition may degrade the quality of the projected image.

When the symptoms above are noticed, contact your authorized dealer or service station for proper cleaning.

#### ORDER REPLACEMENT FILTER CARTRIDGE

Replacement filter cartridge can be ordered through your dealer. When ordering, give the following information to the dealer.

- Model No. of your projector  
PLC-XC50/PLC-XC55
- Replacement Filter Cartridge Type No.  
POA-FIL-063  
(Service Parts No. 610 339 7665)

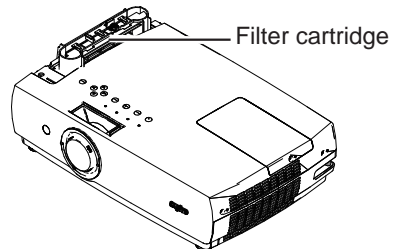
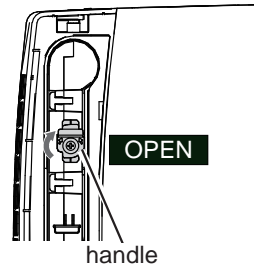
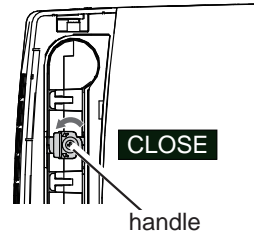
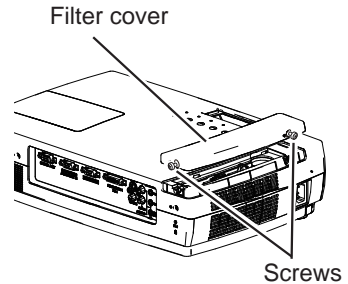

## Resetting the Filter Counter

Be sure to reset the Filter counter after replacing the filter cartridge.

- 1 Press the MENU button to display the On-Screen Menu. Use the Point ◀▶ buttons to move the red frame pointer to the Setting Menu icon.
- 2 Use the Point ▲▼ buttons to move the red frame pointer to Filter counter and then press the SELECT button. A dialog box appears showing the Used time option and the Scrolls remaining option. Use the Point ▲▼ buttons to select Used time.
- 3 Used time shows the total accumulated time of the filter use, a timer setting option, and the Reset option. Select Reset and the "Filter counter Reset?" appears. Select [Yes] to continue.
- 4 Another confirmation dialog box appears, select [Yes] to reset the Filter counter.

### Filter counter

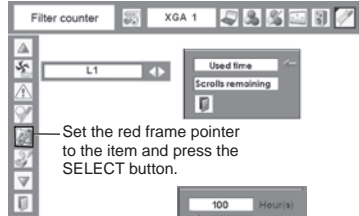

Select Reset and the "Filter counter Reset?" appears.

Select [Yes], then another confirmation box appears.

Select [Yes] again to reset the Filter counter.

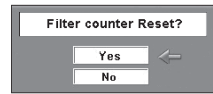

## Resetting the Scroll Counter

Be sure to reset the Scroll counter after replacing the filter cartridge.

- 1 Press the MENU button to display the On-Screen Menu. Use the Point ◀▶ buttons to move the red frame pointer to the Setting Menu icon.
- 2 Use the Point ▲▼ buttons to move the red frame pointer to Filter counter and then press the SELECT button. A dialog box appears showing the Used time option and the Scrolls remaining option. Use the Point ▲▼ buttons to select Scroll(s) remaining.
- 3 Scroll(s) remaining shows the number of the remaining scrolls and the Reset option. Select Reset and the "Scroll counter Reset?" appears. Select [Yes] to continue.
- 4 Another confirmation dialog box appears, select [Yes] to reset the Scroll counter.

### Scroll counter

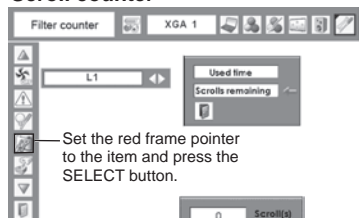

Select Reset and the "Scroll counter Reset?" appears.

Select [Yes], then another confirmation box appears.

Select [Yes] again to reset the Scroll counter.

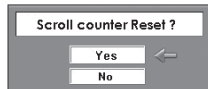

### Lamp Replacement

When the life of the projection lamp of this projector draws to an end, the Lamp replacement icon appears on the screen and LAMP REPLACE indicator lights yellow. Replace the lamp with a new one promptly. The timing when the LAMP REPLACE indicator should light is depending on the lamp mode.

#### Top Control

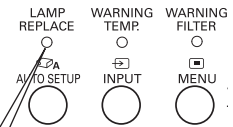

This indicator is yellow when the life of the projection lamp draws to an end.

#### Lamp replacement icon

Lamp replacement



#### ✓ Note:

The Lamp replacement icon will not appear when the Display function is set to "Off" (p.47), during "Freeze" (p.23), or "No show" (p.24).



### CAUTION

Allow a projector to cool, for at least 45 minutes before you open the Lamp cover. The inside of the projector can become very hot.



### CAUTION

For continued safety, replace with a lamp of the same type. Do not drop a lamp or touch a glass bulb! The glass can shatter and may cause injury.



### CAUTION

When replacing the lamp because it has stopped illuminating, there is a possibility that the lamp may be broken.

If replacing the lamp of a projector which has been installed on the ceiling, you should always assume that the lamp is broken, and you should stand to the side of the lamp cover, not underneath it. Remove the lamp cover gently. Small pieces of glass may fall out when the lamp cover is opened. If pieces of glass get into your eyes or mouth, seek medical advice immediately.

Refer to the next page for replacing a lamp.

Follow these steps to replace the lamp.

- 1** Turn off the projector and disconnect the AC power cord. Allow the projector to cool for at least 45 minutes.
- 2** Loosen the screw with a screwdriver, slide and open the lamp cover.
- 3** Loosen 2 screws of the lamp with a screwdriver and pull out the lamp upwards vertically by grasping the handle.
- 4** Replace the lamp with a new one and tighten the 2 screws back into position. Make sure that the lamp is set properly. Replace the lamp cover and tighten the screw.
- 5** Connect the AC power cord to the projector and turn on the projector.
- 6** **Reset the lamp replacement counter.**  
See "Resetting the Lamp Counter" on the next page .

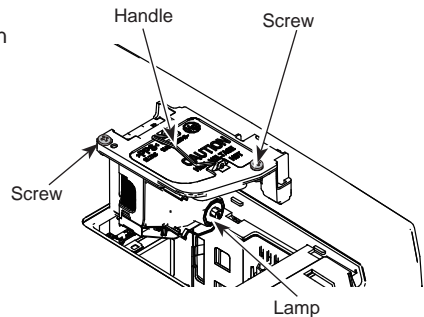
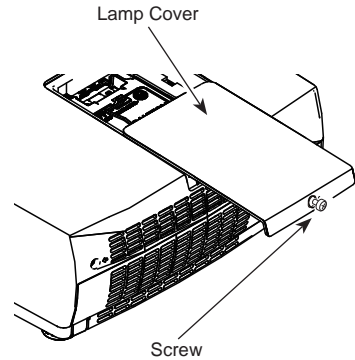

### **ORDER REPLACEMENT LAMP**

Replacement lamp can be ordered through your dealer. When ordering a projection lamp, give the following information to the dealer.

- Model No. of your projector : PLC-XC50 / PLC-XC55
- Replacement Lamp Type No. : POA-LMP127  
(Service Parts No. 610 339 8600)

### Resetting the Lamp Counter

Be sure to reset the Lamp replacement counter after the lamp is replaced. When the Lamp replacement counter is reset, the LAMP REPLACE indicator stops lighting.

- 1 Turn the projector on, press the MENU button to display the On-Screen Menu. Press the Point ◀▶ buttons to move the red frame pointer to the Setting Menu icon.
- 2 Press the Point ▲▼ buttons to move the red frame pointer to the Lamp counter function and then press the SELECT button. The first dialog box appears and shows the total accumulated time of the lamp usage and the reset option. If you select "Reset", a "Lamp replacement counter Reset?" message appears. Select [Yes] to continue.
- 3 Another confirmation dialog box appears, select [Yes] to reset the Lamp replacement counter.

✓ **Note:**

Do not reset the Lamp replacement counter without implementation of lamp replacement. Be sure to reset the Lamp replacement counter only after replacing the lamp.

To reset the lamp counter, move the pointer to Reset and then press the SELECT button. "Lamp replacement counter Reset?" dialog box is displayed.

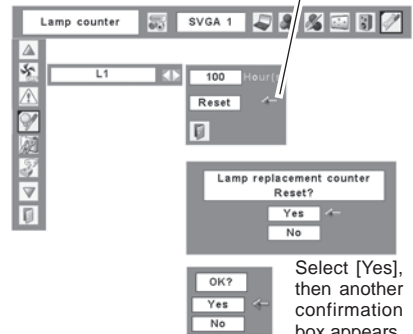

Select [Yes] again to reset the lamp counter.

Select [Yes], then another confirmation box appears.



### LAMP HANDLING PRECAUTIONS

This projector uses a high-pressure lamp which must be handled carefully and properly. Improper handling may result in accidents, injury, or create a fire hazard.

- Lamp life may differ from lamp to lamp and according to the environment of use. There is no guarantee of the same life for each lamp. Some lamps may fail or terminate their life in a shorter period of time than other similar lamps.
- If the projector indicates that the lamp should be replaced, i.e., if the LAMP REPLACE indicator lights up, replace the lamp with a new one IMMEDIATELY after the projector has cooled down. (Follow carefully the instructions in the Lamp Replacement section of this manual.) Continuous use of the lamp with the LAMP REPLACE indicator lighted may increase the risk of lamp explosion.
- A Lamp may explode as a result of vibration, shock or degradation as a result of hours of use as its lifetime draws to an end. Risk of explosion may differ according to the environment or conditions in which the projector and lamp are being used.

#### IF A LAMP EXPLODES, THE FOLLOWING SAFETY PRECAUTIONS SHOULD BE TAKEN.

If a lamp explodes, disconnect the projector's AC plug from the AC outlet immediately. Contact an authorized service station for a checkup of the unit and replacement of the lamp. Additionally, check carefully to ensure that there are no broken shards or pieces of glass around the projector or coming out from the cooling air circulation holes. Any broken shards found should be cleaned up carefully. No one should check the inside of the projector except those who are authorized trained technicians and who are familiar with projector service. Inappropriate attempts to service the unit by anyone, especially those who are not appropriately trained to do so, may result in an accident or injury caused by pieces of broken glass.

## WARNING TEMP. indicator

The WARNING TEMP. indicator shows the state of the function which protects the projector. Check the state of the WARNING TEMP. indicator and the POWER indicator to take proper maintenance.

### The projector is shut down and the WARNING TEMP. indicator is blinking red.

When the temperature inside the projector reaches a certain level, the projector is automatically shut down to protect the inside of the projector. The POWER indicator is blinking while the projector is being cooled down. When the projector has cooled down sufficiently (to its normal operating temperature), it can be turned on again by pressing the POWER ON/STAND-BY button.

✓ **Note:**

After the temperature inside the projector returns to normal, the WARNING TEMP. indicator still continues to blink. When the projector is turned on again, the WARNING TEMP. indicator stops blinking.

#### Then check the matters below:

- Did you provide appropriate space for the projector to be ventilated? Check the installing condition to see if ventilation slots are not blocked.
- Is the projector not installed near the ventilation duct of air-conditioning equipment which may be hot? Install the projector away from the ventilation duct of air-conditioning equipment.
- Is the air filter clean? Replace the filter periodically. (p.52)

### The projector is shut down and the WARNING TEMP. indicator emits a red light.

When the projector detects an abnormal condition, it is automatically shut down to protect the inside and the WARNING TEMP. indicator becomes red. In this case, disconnect the AC power cord and reconnect it, and then turn the projector on once again for check. If the projector cannot be turned on and the WARNING TEMP. indicator emits a red light, disconnect the AC power cord and contact the service station for check and repair.



**CAUTION**

DO NOT LEAVE THE PROJECTOR WITH THE AC POWER CORD CONNECTED UNDER THE ABNORMAL CONDITION. IT MAY RESULT IN FIRE OR ELECTRIC SHOCK.

#### Top Control

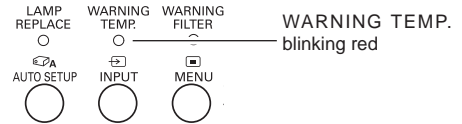

#### Top Control

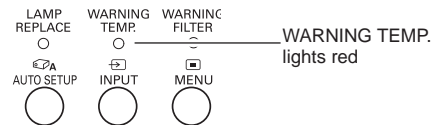



### Cleaning the Lens Cover

Follow these steps to clean the lens cover.

- 1** Disconnect the AC power cord before cleaning.
- 2** Softly wipe the lens cover with a cleaning cloth that contains a small amount of non-abrasive camera lens cleaner, or use lens cleaning paper or a commercially available air blower to clean the lens. Avoid using an excessive amount of cleaner. Abrasive cleaners, solvent, or other harsh chemicals might scratch the surface.

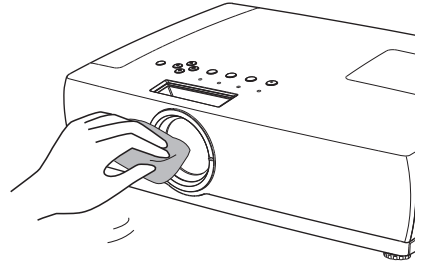

### Cleaning the Projector Cabinet

Follow these steps to clean the projector cabinet.

- 1** Disconnect the AC power cord before cleaning.
- 2** Softly wipe the projector body with a soft, dry cleaning cloth. When it is heavily soiled, use a small amount of mild detergent and finish with a soft, dry cleaning cloth. Avoid using an excessive amount of cleaner. Abrasive cleaners, solvent, or other harsh chemicals might scratch the surface.
- 3** When the projector is not in use, put the projector in an appropriate carrying case to protect it from dust and scratches.

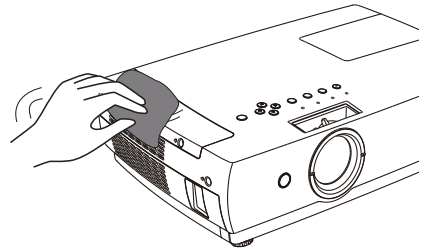

# Appendix

## Troubleshooting

Before calling your dealer or service center for assistance, check the items below once again.

- Make sure you have properly connected the projector to peripheral equipment as described on pages 14-16.
- Make sure all equipment is connected to AC outlet and the power is turned on.
- When you operate the projector with a computer and it does not project an image, restart the computer.

| <b>Problem</b>  | <b>Solutions</b>  |
|---|---|
| <b>No power</b>   | <ul style="list-style-type: none"><li>– Plug the power cord of the projector into the AC outlet.</li><li>– See if the POWER indicator lights red.</li><li>– Wait until the POWER indicator stops blinking to turn on the projector again. The projector can be turned on after the POWER indicator turns red. (See page 18)</li><li>– Check the indicators. If the WARNING TEMP. indicator lights and the other indicators blink, the projector cannot be turned on. (See page 63)</li><li>– Check the projection lamp. (See page 60)</li><li>– Unlock the Key lock function. (See page 53)</li><li>– See if the filter cartridge is inserted.</li></ul>  |
| <b>The initial display is not shown.</b>                                      | <ul style="list-style-type: none"><li>– Make sure "Off" or "Countdown off" are not chosen at Display function. (see page 47)</li></ul>  |
| <b>The initial display is not same as the default set</b>                     | <ul style="list-style-type: none"><li>– Make sure "User" or "Off" are not chosen at Logo (select) as the default set. (see page 48)</li></ul>   |
| <b>Input signal switches automatically (or does not switch automatically)</b> | <ul style="list-style-type: none"><li>– Make sure Input search function is adjusted properly. (See page 46)</li></ul>   |
| <b>Image is out of focus</b>  | <ul style="list-style-type: none"><li>– Adjust the focus of the projector. (See page 22)</li><li>– Provide proper distance between the projector and the projection screen. (See page 13)</li><li>– Check the lens cover to see if it needs cleaning. (See page 64)</li><li>– Moving the projector from a cool to warm place may result in moisture condensation on the projection lens. If this occurs, leave the projector off and wait until condensation evaporates.</li></ul>  |
| <b>No image</b>   | <ul style="list-style-type: none"><li>– Check the connection between your computer or video equipment and the projector. (See pages 14-16)</li><li>– See if the input signal is correctly output from your computer. For some laptop computers, you may need to change the setting for the monitor output when connecting to a projector. See your computer's instruction manual for the setting.</li><li>– It takes about 30 seconds to display an image after turning on the projector. See if the selected system is corresponding to your computer or video equipment. (See pages 27 and 39)</li><li>– Select a correct input source once again through menu operation. (See pages 25, 26, 37 and 38)</li><li>– Make sure the temperature is not out of the specified operating temperature (41°F ~ 95°F [5°C ~ 35°C]).</li></ul> |

## Appendix

|   |   |
|---|---|
| <b>Image is Left/Right reversed<br/>Image is Top/Bottom reversed</b>          | <ul style="list-style-type: none"><li>– Check the Ceiling/Rear function. (See page 50)</li><li>– Check the Ceiling function. (See page 50)</li></ul>  |
| <b>No sound</b>   | <ul style="list-style-type: none"><li>– Check audio cable connections from the audio input source.</li><li>– Adjust the audio source.</li><li>– Press the VOLUME + button. (See page 23)</li><li>– Press the MUTE button. (See page 23)</li><li>– Is the image projected? You will hear the sound only when the image is projected.</li></ul> |
| <b>The color is strange</b>   | <ul style="list-style-type: none"><li>– Check the Input signal, color system, video system or computer system mode.</li><li>– Make sure the "Blackboard" or "Colorboard" is not selected on Image select menu. (see pages 31, 32, 40, 41)</li></ul>   |
| <b>Some displays are not seen during operations</b>                           | <ul style="list-style-type: none"><li>– Check the Display item. (See page 47)</li></ul>   |
| <b>Auto PC adjustment function does not work</b>                              | <ul style="list-style-type: none"><li>– Check the Input signal. Auto PC function can not work when 480p, 575p, 720p, 480i, 575i, 1035i or 1080i is selected, or digital signal is input into DVI terminal. (see Page 28)</li></ul>  |
| <b>The setting does not remain after turning off power</b>                    | <ul style="list-style-type: none"><li>– Make sure you select "Store" after adjusting setting. Some settings can not be stored if not registered with "Store". (see pages 30, 43)</li></ul>  |
| <b>Power management does not work</b>   | <ul style="list-style-type: none"><li>– Power management function can not work while "Freeze" or "No Show" function is running. (see pages 23,24)</li></ul>   |
| <b>Capture function does not work</b>   | <ul style="list-style-type: none"><li>– Check the connection and the input signal to see if there is signal.</li></ul>  |
| <b>Auto setup does not work properly</b>                                      | <ul style="list-style-type: none"><li>– Make sure "Off" is not selected at any function of "Auto setup". (see page 46)</li><li>– Make sure "On" is not selected at the Ceiling function. (see page 50)</li></ul>  |
| <b>Auto keystone does not work properly even when the projector is tipped</b> | <ul style="list-style-type: none"><li>– Make sure the Auto keystone function is not set to "Manual". Press the AUTO SETUP button on the top control or the AUTO SET button on the remote control. (see pages 22, 46)</li></ul>  |
| <b>The image is distorted or runs off</b>                                     | <ul style="list-style-type: none"><li>– Check PC adjustment menu or Screen menu and adjust them. (see pages 29-30, 34-35)</li></ul>   |
| <b>PIN code dialog box appears at the start-up</b>                            | <ul style="list-style-type: none"><li>– PIN code lock is being set. Input a PIN code (1234 or numbers you have set). (See pages 18, 53 and 54)</li></ul>  |

|   |   |
|---|---|
| <b>The Remote Control does not work</b>   | <ul style="list-style-type: none"> <li>– Check the batteries.</li> <li>– Make sure there is no obstruction between the projector and remote control.</li> <li>– Make sure you are not too far from the projector when using the remote control. Maximum operating range is 16.4' (5 m).</li> <li>– Make sure the code of the remote control is conformed to that of the projector. (See page 52)</li> <li>– Unlock the Key lock function for the remote control. (See page 53)</li> </ul> |
| <b>Indicator blinks or lights</b>   | <ul style="list-style-type: none"> <li>– Check the status of the projector with referring to "Indicators and projector Condition". (see pages 71-72)</li> </ul>   |
| <b>The exclamation mark appears on the screen</b>   | <ul style="list-style-type: none"> <li>– Your operation is invalid. Operate correctly.</li> </ul>   |
| <b>The Top Control does not work</b>  | <ul style="list-style-type: none"> <li>– Unlock the Key lock function for the top control of the projector.</li> </ul>  |
| <b>Unable to unlock the Logo PIN code lock, Security key lock or Security PIN code lock</b> | <ul style="list-style-type: none"> <li>– Contact the dealer where you purchased the projector or the service center.</li> </ul>   |

**WARNING:**

**High voltages are used to operate this projector. Do not attempt to open the cabinet.**

If problems still persist after following all operating instructions, contact the dealer where you purchased the projector or the service center. Give the model number and explain about the problem. We will advise you how to obtain service.



The CE Mark is a Directive conformity mark of the European Community (EC).



This symbol on the nameplate means the product is Listed by Underwriters Laboratories Inc. It is designed and manufactured to meet rigid U.L. safety standards against risk of fire, casualty and electrical hazards.



Pixelworks ICs used.

## Menu Tree

### Computer Input/Video Input

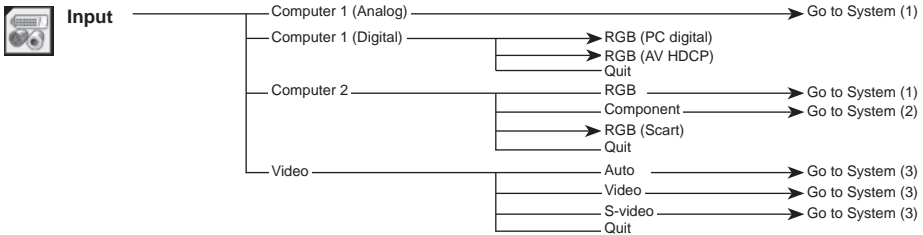

### Sound

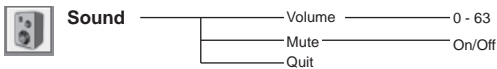

### Computer Input

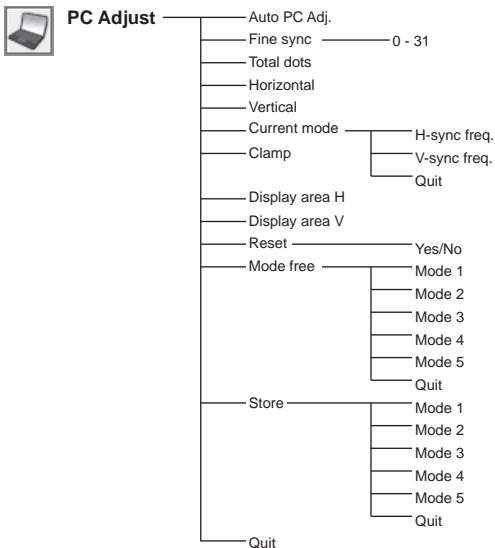
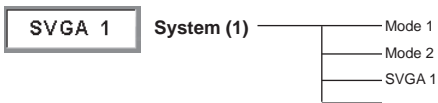

## Video Input

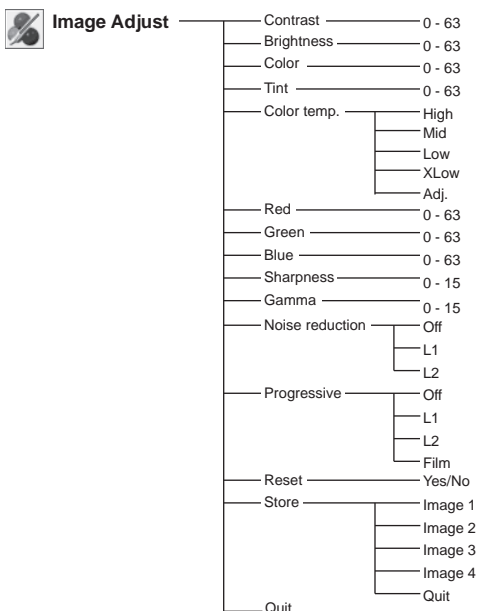
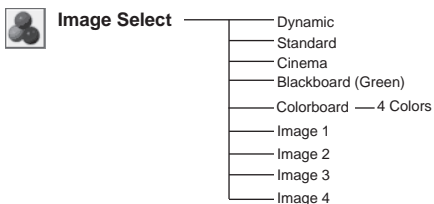
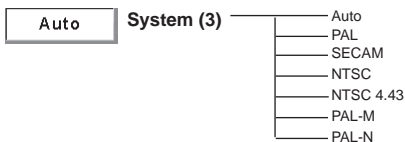
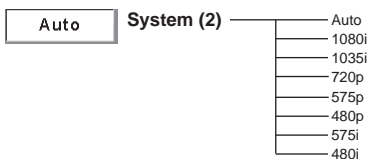
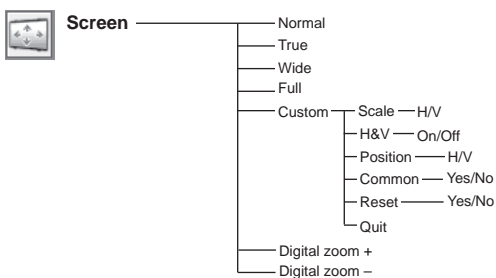
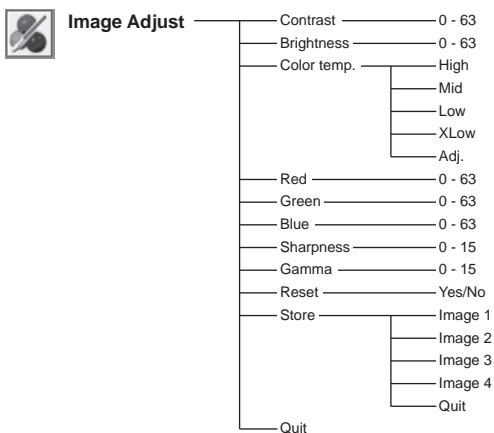
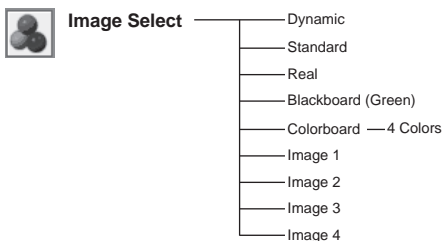

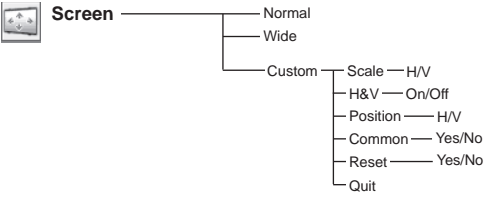

## Setting

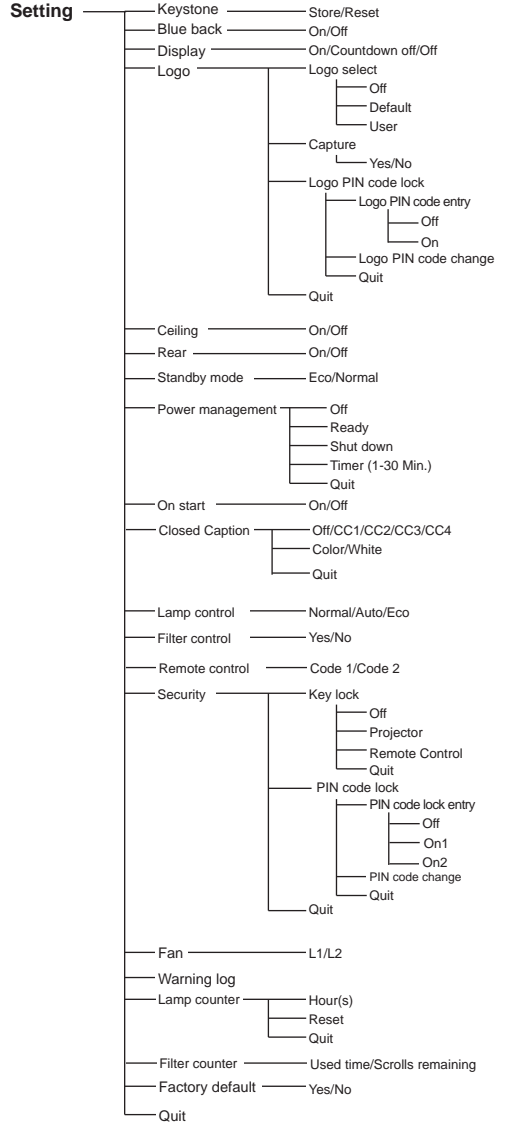
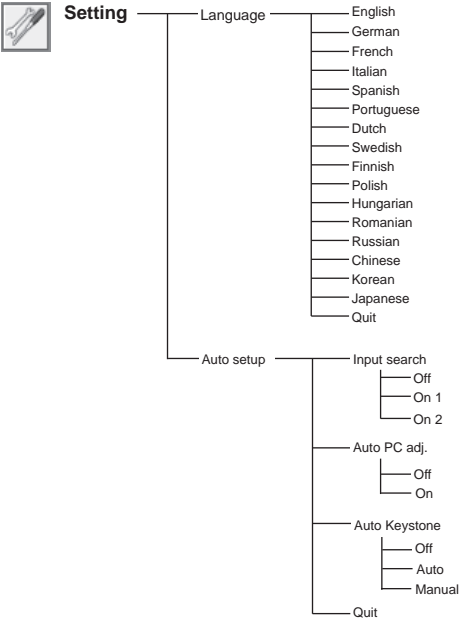

## Indicators and Projector Condition

Check the indicators for the projector condition.

**The projector is operating normally.**

| Indicators  |                         |                             |                           | Projector Condition  |
|---|-------------------------|-----------------------------|---------------------------|--|
| POWER<br>red/green  | WARNING<br>TEMP.<br>red | WARNING<br>FILTER<br>orange | LAMP<br>REPLACE<br>yellow |  |
|   |                         |                             |                           | The projector is off. (The AC power cord is unplugged.)  |
|   |                         |                             |                           | The projector is in stand-by mode. Press the POWER ON/STAND-BY button to turn on the projector.  |
| <br>green   |                         |                             |                           | The projector is operating normally.   |
| <br>blinking fast red   |                         |                             |                           | The projector is preparing for stand-by or the projection lamp is being cooling down. The projector cannot be turned on until cooling is completed.  |
| <br>blinking fast green   |                         |                             |                           | The projector is in the Power management mode.   |
| <br>green   |                         |                             |                           | The filter is scrolled using the Filter control function in the setting menu.<br>When the filter is being scrolled, the Filter replacement icon and "Please wait..." message (Fig. 1) appear on the screen for about 30 seconds. |
|  <div style="border: 1px solid black; padding: 5px; display: inline-block;">Please wait . . .</div> |                         |                             |                           |  |





















Fig.1 Filter replacement icon and "Please wait..."

**The projector is detecting abnormal condition.**

| Indicators            |                         |                             |                           | Projector Condition  |
|-----------------------|-------------------------|-----------------------------|---------------------------|--|
| POWER<br>red/green    | WARNING<br>TEMP.<br>red | WARNING<br>FILTER<br>orange | LAMP<br>REPLACE<br>yellow |  |
| <br>green             |                         |                             |                           | The temperature inside the projector is elevated close to the abnormally high level.   |
| <br>blinking fast red | <br>blinking fast red   |                             |                           | The temperature inside the projector is abnormally high. The projector cannot be turned on. When the projector is cooled down enough and the temperature returns to normal, the POWER indicator lights red and the projector can be turned on. (The WARNING TEMP. indicator keeps blinking.) Check and replace the filter. |

- green / orange / yellow   
 ••• off   
 ••• red   
 ••••• blinking slow  
 (approx. 2 seconds ON, 2 seconds OFF)
- blinking fast  
 (approx. 0.5 seconds ON, 0.5 seconds OFF)



| Indicators  |   |  |  | Projector Condition  |
|---|---|--|--|--|
| POWER<br>red/green  | WARNING<br>TEMP.<br>red   | WARNING<br>FILTER<br>orange  | LAMP<br>REPLACE<br>yellow  |  |
| <br>red                                     |    |                               |                               | The projector has been cooled down enough and the temperature returns to normal. When turning on the projector, the WARNING TEMP. indicator stops blinking. Check and replace the filter.  |
| Any   |    |                               | <br>yellow                    | The lamp has been used overtime. Replace the lamp immediately and then reset the lamp counter. The indicator will be turned off after resetting the counter.   |
| Any   |    | <br>orange                    |                               | <p>If the Filter counter reached a time set in the timer setting, a Filter replacement icon (Fig.2) appears on the screen and the WARNING FILTER indicator on the top control lights up. Replace the filter as soon as possible. If the filter is out of scroll and the projector reaches a time set in the timer setting, Fig. 3 appears on the screen and the WARNING FILTER indicator lights up. Replace the filter cartridge as soon as possible. If the filter is clogged and no scroll is left in the filter cartridge, a Filter cartridge replacement icon (Fig.4) appears on the screen and the WARNING FILTER indicator lights up. Replace the filter cartridge as soon as possible.</p> <p>✓Note:</p> <ul style="list-style-type: none"> <li>• Fig.2, Fig.3 and Fig.4 icon will not appear when the Display function is set to “Off” (p.47), during “Freeze” (p.23), or “No show” (p.24).</li> </ul> |
| <br>Fig.2 Filter replacement icon           |   |  |  |  |
| <br>Fig.3                                   |   |  |  |  |
| <br>Fig.4 Filter cartridge replacement icon |   |  |  |  |
|   |  | <br>blinking fast<br>orange | <br>blinking fast<br>yellow | The filter cartridge is not installed in the projector. Check the filter compartment to see if the filter cartridge is installed in the projector. When the filter cartridge is installed and the indicators continue to light and blink, read the column below.   |
|   |  |                             |                             | The projector detects an abnormal condition and cannot be turned on. Unplug the AC power cord and plug it again to turn on the projector. If the projector is turned off again, unplug the AC power cord and contact the dealer or the service center. Do not leave the projector on. It may cause an electric shock or a fire hazard.   |

 When the filter detects clogging, reaches a time set in the timer setting or runs out of the filter scroll, the WARNING FILTER indicator lights orange. When this indicator lights orange, replace the filter or the filter cartridge with a new one promptly. Reset the Filter counter and Scroll counter after replacing the filter cartridge (p.59).

 When the projection lamp reaches its end of life, the LAMP REPLACE indicator lights yellow. When this indicator lights yellow, replace the projection lamp with a new one promptly. Reset the lamp counter after replacing the lamp (p.62).

## Compatible Computer Specifications

Basically this projector can accept the signal from all computers with the V, H-Frequency below mentioned and less than 140 MHz of Dot Clock for Analog signal and 110 MHz of Dot Clock for digital signal.

When selecting these modes, PC adjustment can be limited.

| ON-SCREEN DISPLAY | RESOLUTION | H-Freq. (kHz) | V-Freq. (Hz)         | ON-SCREEN DISPLAY | RESOLUTION  | H-Freq. (kHz) | V-Freq. (Hz)         |
|-------------------|------------|---------------|----------------------|-------------------|-------------|---------------|----------------------|
| VGA 1             | 640 x 480  | 31.47         | 59.88                | SXGA 1            | 1152 x 864  | 64.20         | 70.40                |
| VGA 2             | 720 x 400  | 31.47         | 70.09                | SXGA 2            | 1280 x 1024 | 62.50         | 58.60                |
| VGA 3             | 640 x 400  | 31.47         | 70.09                | SXGA 3            | 1280 x 1024 | 63.90         | 60.00                |
| VGA 4             | 640 x 480  | 37.86         | 74.38                | SXGA 4            | 1280 x 1024 | 63.34         | 59.98                |
| VGA 5             | 640 x 480  | 37.86         | 72.81                | SXGA 5            | 1280 x 1024 | 63.74         | 60.01                |
| VGA 6             | 640 x 480  | 37.50         | 75.00                | SXGA 6            | 1280 x 1024 | 71.69         | 67.19                |
| VGA 7             | 640 x 480  | 43.269        | 85.00                | SXGA 7            | 1280 x 1024 | 81.13         | 76.107               |
| MAC LC13          | 640 x 480  | 34.97         | 66.60                | SXGA 8            | 1280 x 1024 | 63.98         | 60.02                |
| MAC 13            | 640 x 480  | 35.00         | 66.67                | SXGA 9            | 1280 x 1024 | 79.976        | 75.025               |
| 480i              | —————      | 15.734        | 60.00<br>(Interface) | SXGA 10           | 1280 x 960  | 60.00         | 60.00                |
| 575i              | —————      | 15.625        | 50.00<br>(Interface) | SXGA 11           | 1152 x 900  | 61.20         | 65.20                |
| SVGA 1            | 800 x 600  | 35.156        | 56.25                | SXGA 12           | 1152 x 900  | 71.40         | 75.60                |
| SVGA 2            | 800 x 600  | 37.88         | 60.32                | SXGA 13           | 1280 x 1024 | 50.00         | 66.00<br>(Interface) |
| SVGA 3            | 800 x 600  | 46.875        | 75.00                | SXGA 14           | 1280 x 1024 | 50.00         | 94.00<br>(Interface) |
| SVGA 4            | 800 x 600  | 53.674        | 85.06                | SXGA 15           | 1280 x 1024 | 63.37         | 60.01                |
| SVGA 5            | 800 x 600  | 48.08         | 72.19                | SXGA 16           | 1280 x 1024 | 76.97         | 72.00                |
| SVGA 6            | 800 x 600  | 37.90         | 61.03                | SXGA 17           | 1152 x 900  | 61.85         | 66.00                |
| SVGA 7            | 800 x 600  | 34.50         | 55.38                | SXGA 18           | 1280 x 1024 | 46.43         | 66.70<br>(Interface) |
| SVGA 8            | 800 x 600  | 38.00         | 60.51                | SXGA 19           | 1280 x 1024 | 63.79         | 60.18                |
| SVGA 9            | 800 x 600  | 38.60         | 60.31                | SXGA 20           | 1280 x 1024 | 91.146        | 85.024               |
| SVGA 10           | 800 x 600  | 32.70         | 51.09                | SXGA +1           | 1400 x 1050 | 63.979        | 60.190               |
| SVGA 11           | 800 x 600  | 38.00         | 60.51                | SXGA +2           | 1400 x 1050 | 65.346        | 60.116               |
| MAC 16            | 832 x 624  | 49.72         | 74.55                | SXGA +3           | 1400 x 1050 | 65.121        | 59.902               |
| XGA 1             | 1024 x 768 | 48.36         | 60.00                | MAC21             | 1152 x 870  | 68.68         | 75.06                |
| XGA 2             | 1024 x 768 | 68.677        | 84.997               | MAC               | 1280 x 960  | 75.00         | 75.08                |
| XGA 3             | 1024 x 768 | 60.023        | 75.03                | MAC               | 1280 x 1024 | 80.00         | 75.08                |
| XGA 4             | 1024 x 768 | 56.476        | 70.07                | 480p              | —————       | 31.47         | 59.88                |
| XGA 5             | 1024 x 768 | 60.31         | 74.92                | 575p              | —————       | 31.25         | 50.00                |
| XGA 6             | 1024 x 768 | 48.50         | 60.02                | 720p              | —————       | 37.50         | 50.00                |
| XGA 7             | 1024 x 768 | 44.00         | 54.58                | 720p              | —————       | 45.00         | 60.00                |
| XGA 8             | 1024 x 768 | 63.48         | 79.35                | 1035i             | —————       | 33.75         | 60.00<br>(Interface) |
| XGA 9             | 1024 x 768 | 36.00         | 60.00<br>(Interface) | 1080i             | —————       | 33.75         | 60.00<br>(Interface) |
| XGA 10            | 1024 x 768 | 62.04         | 77.07                | 1080i             | —————       | 28.125        | 50.00<br>(Interface) |
| XGA 11            | 1024 x 768 | 61.00         | 75.70                | WXGA 1            | 1366 x 768  | 48.36         | 60.00                |
| XGA 12            | 1024 x 768 | 35.522        | 66.96<br>(Interface) | WXGA 2            | 1360 x 768  | 47.70         | 60.00                |
| XGA 13            | 1024 x 768 | 46.90         | 58.20                | WXGA 3            | 1376 x 768  | 48.36         | 60.00                |
| XGA 14            | 1024 x 768 | 47.00         | 58.30                | WXGA 4            | 1360 x 768  | 56.16         | 72.00                |
| XGA 15            | 1024 x 768 | 58.03         | 72.00                | WXGA 6            | 1280 x 768  | 47.776        | 59.87                |
| MAC 19            | 1024 x 768 | 60.24         | 75.08                | WXGA 7            | 1280 x 768  | 60.289        | 74.893               |
|                   |            |               |                      | WXGA 8            | 1280 x 768  | 68.633        | 84.837               |
|                   |            |               |                      | UXGA 1            | 1600 x 1200 | 75.00         | 60.00                |
|                   |            |               |                      | UXGA 2            | 1600 x 1200 | 81.25         | 65.00                |
|                   |            |               |                      | UXGA 3            | 1600 x 1200 | 87.5          | 70.00                |
|                   |            |               |                      | UXGA 4            | 1600 x 1200 | 93.75         | 75.00                |

# Appendix

When the input signal is digital from DVI terminal, refer to the chart below.

| ON-SCREEN DISPLAY | RESOLUTION | H-Freq. (KHz) | V-Freq. (Hz) | ON-SCREEN DISPLAY | RESOLUTION  | H-Freq. (KHz) | V-Freq. (Hz)      |
|-------------------|------------|---------------|--------------|-------------------|-------------|---------------|-------------------|
| D-VGA             | 640 x 480  | 31.47         | 59.94        | D-SXGA1           | 1280 x 1024 | 63.98         | 60.02             |
| D-480p            | 640 x 480  | 31.47         | 59.88        | D-SXGA2           | 1280 x 1024 | 60.276        | 58.069            |
| D-575p            | 768 x 575  | 31.25         | 50.00        | D-SXGA3           | 1280 x 1024 | 31.65         | 29.80             |
| D-SVGA            | 800 x 600  | 37.879        | 60.32        | D-SXGA+1          | 1400 x 1050 | 63.97         | 60.19             |
| D-XGA             | 1024 x 768 | 43.363        | 60.00        | D-720p            | 1280 x 720  | 37.50         | 50.00             |
| D-WXGA 1          | 1366 x 768 | 48.36         | 60.00        | D-720p            | 1280 x 720  | 45.00         | 60.00             |
| D-WXGA 2          | 1360 x 768 | 47.70         | 60.00        | D-1035i           | 1920 x 1035 | 33.75         | 60.00 (Interface) |
| D-WXGA 3          | 1376 x 768 | 48.36         | 60.00        | D-1080i           | 1920 x 1080 | 33.75         | 60.00 (Interface) |
| D-WXGA 4          | 1360 x 768 | 56.160        | 72.000       | D-1080i           | 1920 x 1080 | 28.125        | 50.00 (Interface) |
| D-WXGA 5          | 1366 x 768 | 46.500        | 50.000       |                   |             |               |                   |
| D-WXGA 6          | 1280 x 768 | 47.776        | 59.870       |                   |             |               |                   |
| D-WXGA 7          | 1280 x 768 | 60.289        | 74.893       |                   |             |               |                   |

✓ **Note:**

- When the input signal is D-SXGA 1, D-SXGA 2, D-SXGA 3, or D-SXGA+1, images may not be displayed properly depending on computers.
- The specifications are subject to change without notice.

## Technical Specifications

### Mechanical Information

|                        |   |
|------------------------|---|
| Projector Type         | Multi-media Projector                                     |
| Dimensions (W x H x D) | 410.0 mm x 85.0 mm x 262.8 mm (Not including protrusions) |
| Net Weight             | 8.82lbs (4.0 kg)  |
| Foot Adjustment        | 0° to 10.0°   |

### Panel Resolution

|                  |  |
|------------------|--|
| LCD Panel System | 0.63" TFT Active Matrix type, 3 panels |
| Panel Resolution | 1,024 x 768 dots                       |
| Number of Pixels | 2,359,296 (1,024 x 768 x 3 panels)     |

### Signal Compatibility

|                           |  |
|---------------------------|--|
| Color System              | PAL, SECAM, NTSC, NTSC4.43, PAL-M, and PAL-N   |
| High Definition TV Signal | 480i, 480p, 575i, 575p, 720p, 1035i, and 1080i |
| Scanning Frequency        | H-sync. 15 ~ 100 KHz, V-sync. 50 ~ 100 Hz      |

### Optical Information

|                                  |   |
|----------------------------------|---|
| Projection Image Size (Diagonal) | Adjustable from 40" to 300"   |
| Projection Lens                  | F 1.60-1.76 lens with f =22.33 mm ~ 26.80 mm with manual zoom and focus |
| Throw Distance                   | 4.6' ~ 41.3' (1.4 m ~ 12.6 m)   |
| Projection Lamp                  | 220W  |

### Interface

|                                       |   |
|---------------------------------------|---|
| Video Input Jack                      | RCA Type x 1                                |
| S-video Input Jack                    | Mini DIN 4 pin x 1                          |
| Audio Input Jacks                     | RCA Type x 2                                |
| Computer Input 1/DVI-I                | Digital/Analog RGB (DVI-I) Terminal x 1     |
| Computer Input 2/Component Input      | Analog RGB (Mini D-sub 15 pin) Terminal x 1 |
| Monitor Output                        | Analog RGB (Mini D-sub 15 pin) Terminal x 1 |
| Computer2/ Component Audio Input Jack | Mini Jack (stereo) x 1                      |
| Computer1 Audio Input Jack            | Mini Jack (stereo) x 1                      |
| Control Input                         | Mini D-sub 9 pin x 1                        |
| Audio Output Jack                     | Mini Jack (stereo) x 1 (Variable)           |

### Audio

|                    |                          |
|--------------------|--------------------------|
| Internal Audio Amp | 7.0 W RMS                |
| Built-in Speaker   | 1 speaker, ø1.46" (37mm) |

### Power

|                               |   |
|-------------------------------|---|
| Voltage and Power Consumption | AC 100 ~ 120 V (3.4A Max. Ampere), 50/60 Hz (The U.S.A and Canada)<br>AC 200 ~ 240 V (1.7A Max. Ampere), 50/60 Hz (Continental Europe and The U.K.) |
|-------------------------------|---|

### Operating Environment

|                       |                             |
|-----------------------|-----------------------------|
| Operating Temperature | 41°F ~ 95°F (5°C ~ 35°C)    |
| Storage Temperature   | 14°F ~ 140°F (-10°C ~ 60°C) |

### Remote Control

|                 |  |
|-----------------|--|
| Battery         | AA or LR6 1.5 V ALKALINE TYPE x 2                          |
| Operating Range | 16.4' (5 m)/±30°   |
| Dimensions      | 1.9" (W) x 0.87" (H) x 5.7" (D) (49 mm x 22 mm x 145.3 mm) |
| Net Weight      | 3.53 oz (100 g) (including batteries)                      |

### Accessories

---

Owner's Manual (CD-ROM)  
Quick Reference Guide  
AC Power Cord  
Remote Control and Batteries  
VGA Cable  
PIN Code Label

- The specifications are subject to change without notice.
- LCD panels are manufactured to the highest possible standards. Even though 99.99% of the pixels are effective, a tiny fraction of the pixels (0.01% or less) may be ineffective by the characteristics of the LCD panels.

### Optional Parts

The parts listed below are optionally available. When ordering those parts, specify the item and Model No. to the sales dealer.

|                            | <b>Model No.</b> |
|----------------------------|------------------|
| <b>COMPONENT-VGA Cable</b> | : POA-CA-COMPVGA |
| <b>SCART-VGA Cable</b>     | : POA-CA-SCART   |
| <b>VGA Cable (10m)</b>     | : KA-MC-DB10     |

## Configurations of Terminals

### COMPUTER INPUT/COMPONENT INPUT/MONITOR OUTPUT TERMINAL (ANALOG)

#### DVI-I (DIGITAL/ANALOG)

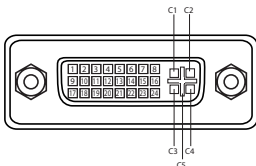

|    |                       |
|----|-----------------------|
| C1 | Analog Red Input      |
| C2 | Analog Green Input    |
| C3 | Analog Blue Input     |
| C4 | Analog Horiz. sync    |
| C5 | Analog Ground (R/G/B) |

|   |                       |    |                       |    |                       |
|---|-----------------------|----|-----------------------|----|-----------------------|
| 1 | T.M.D.S. Data2-       | 9  | T.M.D.S. Data1-       | 17 | T.M.D.S. Data0-       |
| 2 | T.M.D.S. Data2+       | 10 | T.M.D.S. Data1+       | 18 | T.M.D.S. Data0+       |
| 3 | T.M.D.S. Data2 Shield | 11 | T.M.D.S. Data1 Shield | 19 | T.M.D.S. Data0 Shield |
| 4 | No Connect            | 12 | No Connect            | 20 | No Connect            |
| 5 | No Connect            | 13 | No Connect            | 21 | No Connect            |
| 6 | DDC Clock             | 14 | +5V Power             | 22 | T.M.D.S. Clock Shield |
| 7 | DDC Data              | 15 | Ground (for +5V)      | 23 | T.M.D.S. Clock+       |
| 8 | Analog Vert. sync     | 16 | Hot Plug Detect       | 24 | T.M.D.S. Clock-       |

#### Terminal : Analog RGB (Mini D-sub 15 pin)

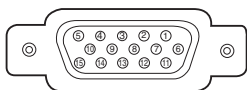

|   |                                |    |  |
|---|--------------------------------|----|--|
| 1 | Red (R/Cr) Input/R Output      | 9  | 5V / ---   |
| 2 | Green (G/Y) Input/G Output     | 10 | Ground (Vert.sync.)                                  |
| 3 | Blue (B/Cb/---) Input/B Output | 11 | Ground   |
| 4 | -----                          | 12 | DDC data / ---                                       |
| 5 | Ground (Horiz.sync.)           | 13 | Horiz. sync. Input/Output (Composite H/V sync.Input) |
| 6 | Ground (Red)                   | 14 | Vert. sync. Input/Output                             |
| 7 | Ground (Green)                 | 15 | DDC clock / ---                                      |
| 8 | Ground (Blue)                  |    |  |

#### CONTROL PORT CONNECTOR (D-sub 9 pin)

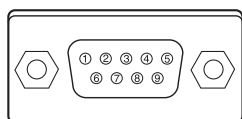

|   | Serial |
|---|--------|
| 1 | -----  |
| 2 | R X D  |
| 3 | T X D  |
| 4 | -----  |
| 5 | SG     |
| 6 | -----  |
| 7 | RTS    |
| 8 | CTS    |
| 9 | -----  |

# Appendix

## Dimensions

Unit: inch (mm)

↙ Screw Holes for Ceiling Mount  
Screw: M4  
Depth: 0.47(12.0)

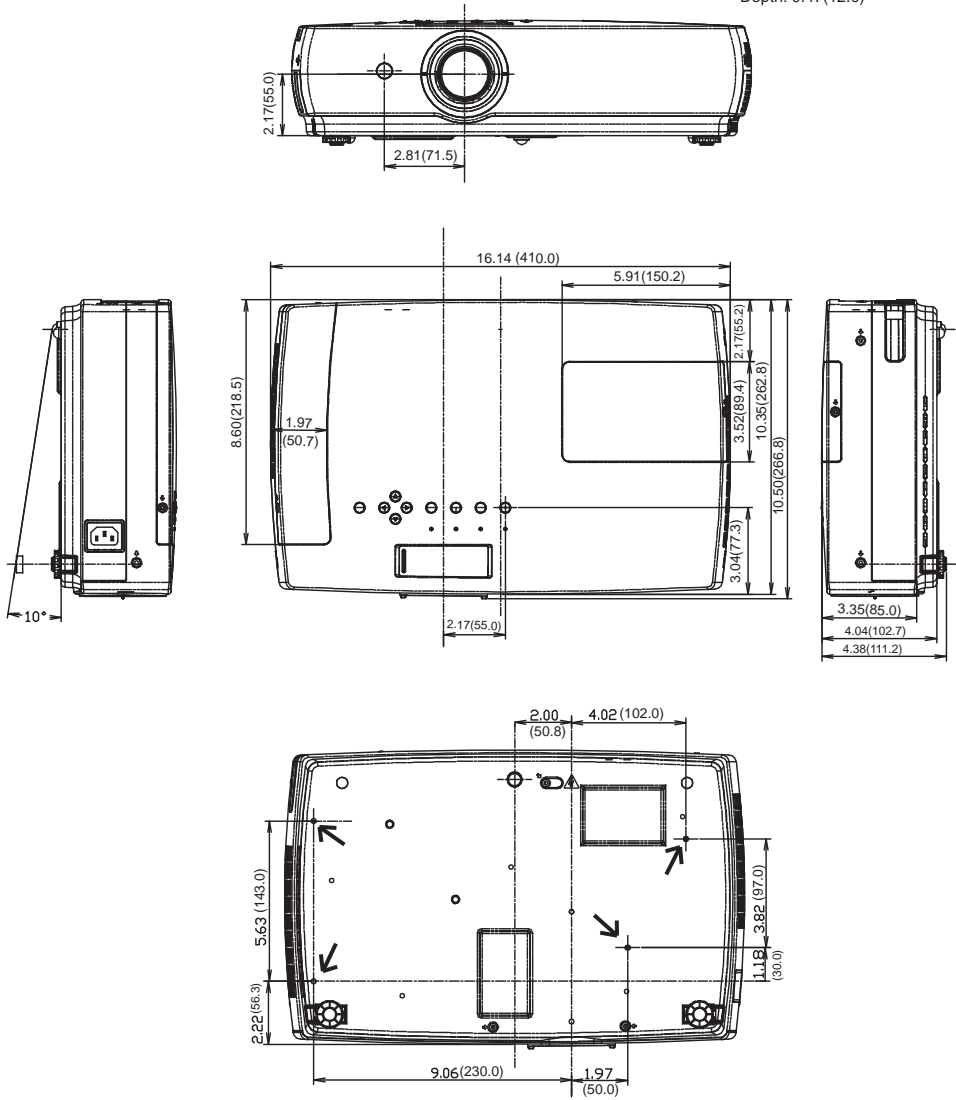

## PIN Code Number Memo

Write down the PIN code number in the column below and keep it with this manual securely. If you forgot or lost the number and unable to operate the projector, contact the service station.

**PIN Code Lock No.**

|  |  |  |  |
|--|--|--|--|
|  |  |  |  |
|--|--|--|--|

Factory default set No: 1 2 3 4\*

**Logo PIN Code Lock No.**

|  |  |  |  |
|--|--|--|--|
|  |  |  |  |
|--|--|--|--|

Factory default set No: 4 3 2 1\*

\* Should the four-digit number be changed, the factory set number will be invalid.

While the projector is locked with the PIN code....

Put the label below (supplied) on in a prominent place of the projector's body while it is locked with a PIN code.

