

SANYO

Multimedia Projector

MODEL PLC-SW35

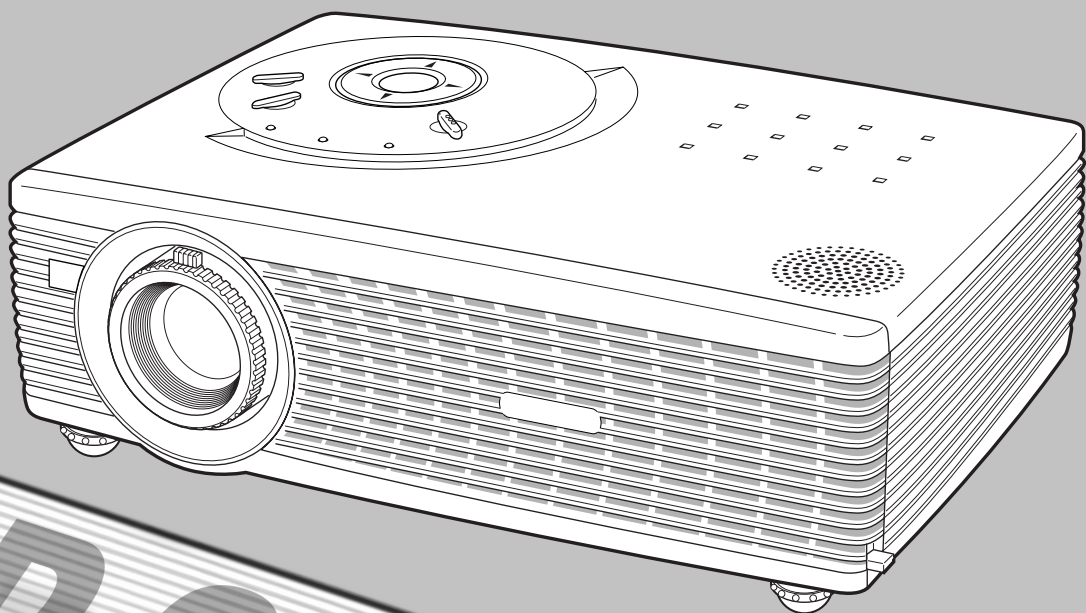

PROJECTOR

Owner's Manual

Features and Design

This Multimedia Projector is designed with the most advanced technology for portability, durability, and ease of use. This projector utilizes built-in multimedia features, a palette of 16.77 million colors, and matrix liquid crystal display (LCD) technology.

◆ **Compact Design**

This projector is designed compact in size and weight. It is easy to carry and work anywhere you wish to use.

◆ **Compatibility**

The projector widely accepts various video and computer input signals including; Computers, 6 Color systems (PAL, SECAM, NTSC, NTSC4.43, PAL-M, PAL-N), Component video, S-video and RGB scart.

◆ **Simple Computer System Setting**

The projector has the Multi-scan system to conform to almost all computer output signals quickly. (See page 25.)

◆ **Auto PC Adjustment**

Incoming computer signals are recognized and the best adjustment is automatically set by Auto PC Adjustment. No complicated setup is necessary and projection is always precise. (See page 26.)

◆ **Blackboard Function**

Blackboard* can be used as a projection screen.
*The board color is limited to Green.
(See page 29 and 34)

◆ **Digital Zoom (for Computer)**

The digital zoom function expands (to approx. 16 times of screen size) or compress the image size, allowing you to focus on crucial information at a presentation. (See page 31.)

◆ **Film Function**

The Film function reproduces pictures faithful to the original film quality from 3-2 pull-down video contents. (See page 36.)

◆ **Multi-language Menu Display**

Operation menu is available in 12 languages; English, German, French, Italian, Spanish, Portuguese, Dutch, Swedish, Russian, Chinese, Korean, or Japanese. (See page 38.)

◆ **Keystone Adjustment**

The keystone correction function is provided to correct distortion of the projected image allowing you to use the projector without locational constraints. (See page 22 and 38.)

◆ **Power management**

The Power management function reduces power consumption and maintain the lamp life. (See page 41.)

◆ **User's Logo**

A projected image can be captured and used for the starting display of the projector with the Capture function. You can also display the captured image in an interval during your presentation instead of blackout image with the No show function. (See page 22 and 40.)

◆ **Selectable Lamp Mode**

Brightness of the projection lamp can be selected in the Setting menu. (See page 41.)

◆ **Key Lock Function**

Provided to lock the operation of the projector. This function protects the projector from being tampered with by third persons. (See page 42)

◆ **PIN Code Lock Function**

The PIN code lock function prevents others except users from using the projector. (See page 17 and 43.)

Table of Contents

Features and Design	2	Computer Input	24
Table of Contents	3	Input Source Selection	24
To the Owner	4	Computer System Selection	25
Safety Instructions	5	Auto PC Adjustment	26
Air Circulation	6	Manual PC Adjustment	27
Installing the Projector in Proper Position	6	Image Level Selection	29
Moving the Projector	6	Image Level Adjustment	30
Compliance	7	Screen Size Adjustment	31
Part Names and Functions	8	Video Input	32
Front	8	Input Source Selection	32
Back	8	Video System Selection	33
Bottom	8	Image Level Selection	34
Rear Terminal	9	Image Level Adjustment	35
Top Control	10	Screen Size Adjustment	37
Remote Control	11	Setting	38
Operating Range	11	Setting	38
Remote Control Battery Installation	12	Maintenance and Cleaning	45
Installation	13	Warning Indicator	45
Positioning the Projector	13	Cleaning the Air Filters	46
Adjustable Feet	13	Cleaning the Projection Lens	47
Connecting the AC Power Cord	14	Cleaning the Projector Cabinet	47
Connecting to a Computer	15	Attaching the Lens Cover	47
Connecting to Video Equipment	16	Lamp Replacement	48
Basic Operation	17	Lamp Replace Counter	49
Turning On the Projector	17	Appendix	50
Turning Off the Projector	18	Troubleshooting	50
Zoom and Focus Adjustment	19	Menu Tree	52
How to Operate the On-Screen Menu	20	Indicators and Projector Condition	54
Menu Bar	21	Compatible Computer Specifications	55
Keystone Adjustment	22	Technical Specifications	56
Picture Freeze Function	22	Optional Parts	57
No Show Function	22	Configurations of Terminals	58
P-Timer Function	23	PIN Code Number Memo	59
Sound Adjustment	23		

Trademarks

Each name of corporations or products in this book is either a registered trademark or a trademark of its respective corporation.





To the Owner

Before operating this projector, read this manual thoroughly and operate the projector properly.

This projector provides many convenient features and functions. Operating the projector properly enables you to manage those features and maintains it in better condition for a considerable time.

Improper operation may result in not only shortening the product-life, but also malfunctions, fire hazard, or other accidents.

If your projector seems to operate improperly, read this manual again, check operations and cable connections and try the solutions in the "Troubleshooting" section in the end of this booklet. If the problem still persists, contact the dealer where you purchased the projector or the service center.

	CAUTION RISK OF ELECTRIC SHOCK DO NOT OPEN	
CAUTION : TO REDUCE THE RISK OF ELECTRIC SHOCK, DO NOT REMOVE COVER (OR BACK). NO USER-SERVICEABLE PARTS INSIDE EXCEPT LAMP REPLACEMENT. REFER SERVICING TO QUALIFIED SERVICE PERSONNEL.		
	THIS SYMBOL INDICATES THAT DANGEROUS VOLTAGE CONSTITUTING A RISK OF ELECTRIC SHOCK IS PRESENT WITHIN THIS UNIT.	
	THIS SYMBOL INDICATES THAT THERE ARE IMPORTANT OPERATING AND MAINTENANCE INSTRUCTIONS IN THE OWNER'S MANUAL WITH THIS UNIT.	



Safety Precaution

WARNING : TO REDUCE THE RISK OF FIRE OR ELECTRIC SHOCK, DO NOT EXPOSE THIS APPLIANCE TO RAIN OR MOISTURE.

- This projector produces intense light from the projection lens. Do not stare directly into the lens as possible. Eye damage could result. Be especially careful that children do not stare directly into the beam.
- Install the projector in a proper position. If not, it may result in a fire hazard.
- Provide appropriate space on the top, sides and rear of the projector cabinet for allowing air circulation and cooling the projector. Minimum clearance must be maintained. If the projector is to be built into a compartment or similarly enclosed, the minimum distances must be maintained. Do not cover the ventilation slot on the projector. Heat build-up can reduce the service life of your projector, and can also be dangerous.

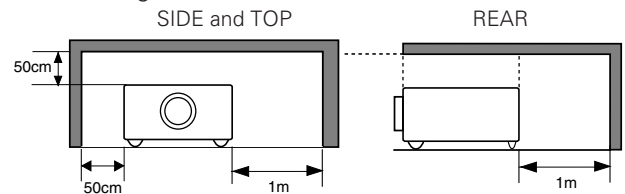

- Do not put any flammable object or spray can near the projector, hot air is exhausted from the ventilation holes.
- If the projector is not to be used for an extended time, unplug the projector from the power outlet.

READ AND KEEP THIS OWNER'S MANUAL FOR LATER USE.

CAUTION

Not for use in a computer room as defined in the Standard for the Protection of Electronic Computer/Data Processing Equipment, ANSI/NFPA 75.

Ne peut être utilisé dans une salle d'ordinateurs telle que définie dans la norme ANSI/NFPA 75 Standard for Protection of Electronic Computer/Data Processing Equipment

Safety Instructions

All the safety and operating instructions should be read before the product is operated.

Read all of the instructions given here and retain them for later use. Unplug this projector from AC power supply before cleaning. Do not use liquid or aerosol cleaners. Use a damp cloth for cleaning.

Follow all warnings and instructions marked on the projector.

For added protection to the projector during a lightning storm, or when it is left unattended and unused for long periods of time, unplug it from the wall outlet. This will prevent damage due to lightning and power line surges.

Do not expose this unit to rain or use near water... for example, in a wet basement, near a swimming pool, etc...

Do not use attachments not recommended by the manufacturer as they may cause hazards.

Do not place this projector on an unstable cart, stand, or table. The projector may fall, causing serious injury to a child or adult, and serious damage to the projector. Use only with a cart or stand recommended by the manufacturer, or sold with the projector. Wall or shelf mounting should follow the manufacturer's instructions, and should use a mounting kit approved by the manufacturers.

An appliance and cart combination should be moved with care. Quick stops, excessive force, and uneven surfaces may cause the appliance and cart combination to overturn.



Slots and openings in the back and bottom of the cabinet are provided for ventilation, to ensure reliable operation of the equipment and to protect it from overheating.

The openings should never be covered with cloth or other materials, and the bottom opening should not be blocked by placing the projector on a bed, sofa, rug, or other similar surface. This projector should never be placed near or over a radiator or heat register.

This projector should not be placed in a built-in installation such as a book case unless proper ventilation is provided.

Never push objects of any kind into this projector through cabinet slots as they may touch dangerous voltage points or short out parts that could result in a fire or electric shock. Never spill liquid of any kind on the projector.

Do not install the projector near the ventilation duct of air-conditioning equipment.

This projector should be operated only from the type of power source indicated on the marking label. If you are not sure of the type of power supplied, consult your authorized dealer or local power company.

Do not overload wall outlets and extension cords as this can result in fire or electric shock. Do not allow anything to rest on the power cord. Do not locate this projector where the cord may be damaged by persons walking on it.

Do not attempt to service this projector yourself as opening or removing covers may expose you to dangerous voltage or other hazards. Refer all servicing to qualified service personnel.

Unplug this projector from wall outlet and refer servicing to qualified service personnel under the following conditions:

- When the power cord or plug is damaged or frayed.
- If liquid has been spilled into the projector.
- If the projector has been exposed to rain or water.
- If the projector does not operate normally by following the operating instructions. Adjust only those controls that are covered by the operating instructions as improper adjustment of other controls may result in damage and will often require extensive work by a qualified technician to restore the projector to normal operation.
- If the projector has been dropped or the cabinet has been damaged.
- When the projector exhibits a distinct change in performance-this indicates a need for service.

When replacement parts are required, be sure the service technician has used replacement parts specified by the manufacturer that have the same characteristics as the original part. Unauthorized substitutions may result in fire, electric shock, or injury to persons.

Upon completion of any service or repairs to this projector, ask the service technician to perform routine safety checks to determine that the projector is in safe operating condition.



Voor de klanten in Nederland

Bij dit product zijn batterijen geleverd.

Wanneer deze leeg zijn, moet u ze niet weggooien maar inleveren als KCA.



Air Circulation

Openings in the cabinet are provided for ventilation and to ensure reliable operation of the product and to protect it from overheating, and these openings must not be blocked or covered.

CAUTION

Hot air is exhausted from the exhaust vent. When using or installing the projector, the following precautions should be taken.

- Do not put any flammable objects near the vent.
- Keep the exhaust vent at least 3'(1m) away from any objects.
- Do not touch a peripheral part of the exhaust vent, especially screws and metallic part. This area will become hot while the projector is being used.
- Do not put anything on the projector. The materials put on the cabinet will not only get damaged but also cause fire hazard by heat.

Cooling fans are provided to cool down the projector. This projector monitors internal temperature and control the running speed of the cooling fans.

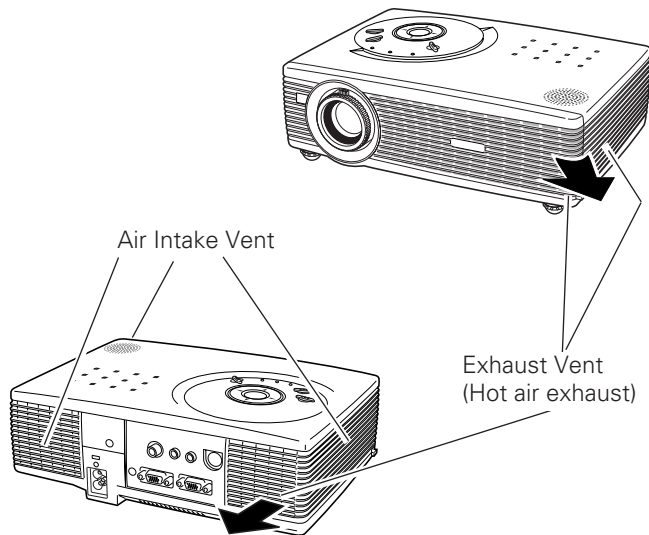

Installing the Projector in Proper Position

Install the projector properly. Improper Installation may reduce the lamp life and cause a fire hazard.

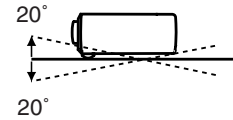

Do not tilt the projector more than 20 degrees above and below.



Do not point the projector up to project an image.



Do not point the projector down to project an image.



Do not put the projector on either side to project an image.

Moving the Projector

When moving the projector, replace the Lens Cover and retract Adjustable Feet to prevent damage to the lens and cabinet.

When the projector is not in use for an extended period, put it into the case (carrying bag) supplied with the projector.

CAUTION

Carrying Bag (supplied) is intended for protection from dust and scratches on the surface of a cabinet, and it is not designed to protect an appliance from external forces. Do not transport a projector through a courier or transport services with this bag, otherwise the projector can be damaged. When handling a projector, do not drop, bump, subject it to strong forces or put other things on the cabinet.

USE CAUTION IN CARRYING OR TRANSPORTING THE PROJECTOR

- Do not drop or bump a projector, otherwise damages or malfunctions may result.
- When carrying a projector, use a suitable carrying case.
- Do not transport a projector by using a courier or transport service in an unsuitable transport case. This may cause damage to a projector. To transport a projector through a courier or transport service, consult your dealer for their information.

Federal Communication Commission Notice

Note : This equipment has been tested and found to comply with the limits for a Class B digital device, pursuant to part 15 of the FCC Rules. These limits are designed to provide reasonable protection against harmful interference in a residential installation. This equipment generates, uses and can radiate radio frequency energy and, if not installed and used in accordance with the instructions, may cause harmful interference to radio communications. However, there is no guarantee that interference will not occur in a particular installation. If this equipment does cause harmful interference to radio or television reception, which can be determined by turning the equipment off and on, the user is encouraged to try to correct the interference by one or more of the following measures :

- Reorient or relocate the receiving antenna.
- Increase the separation between the equipment and receiver.
- Connect the equipment into an outlet on a circuit different from that to which the receiver is connected.
- Consult the dealer or an experienced radio/TV technician for help.

Use of shielded cable is required to comply with class B limits in Subpart B of Part 15 of FCC Rules.

Do not make any changes or modifications to the equipment unless otherwise specified in the instructions. If such changes or modifications should be made, you could be required to stop operation of the equipment.

Model Numbers : PLC-SW35
Trade Name : Sanyo
Responsible party : SANYO FISHER COMPANY
Address : 21605 Plummer Street, Chatsworth, California 91311
Telephone No. : (818)998-7322

AC Power Cord Requirement

The AC Power Cord supplied with this projector meets the requirement for use in the country you purchased it.

AC Power Cord for the United States and Canada :

AC Power Cord used in the United States and Canada is listed by the Underwriters Laboratories (UL) and certified by the Canadian Standard Association (CSA).

AC Power Cord has a grounding-type AC line plug. This is a safety feature to be sure that the plug will fit into the power outlet. Do not try to defeat this safety feature. Should you be unable to insert the plug into the outlet, contact your electrician.

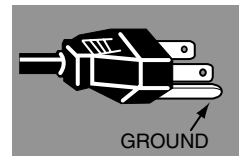

AC Power Cord for the United Kingdom :

This cord is already fitted with a moulded plug incorporating a fuse, the value of which is indicated on the pin face of the plug. Should the fuse need to be replaced, an ASTA approved BS 1362 fuse must be used of the same rating, marked thus \diamond . If the fuse cover is detachable, never use the plug with the cover omitted. If a replacement fuse cover is required, ensure it is of the same colour as that visible on the pin face of the plug (i.e. red or orange). Fuse covers are available from the Parts Department indicated in your User Instructions.

If the plug supplied is not suitable for your socket outlet, it should be cut off and destroyed.

The end of the flexible cord should be suitably prepared and the correct plug fitted. (See Over)

WARNING : A PLUG WITH BARED FLEXIBLE CORD IS HAZARDOUS IF ENGAGED IN A LIVE SOCKET OUTLET.

The Wires in this mains lead are coloured in accordance with the following code:

Green-and-yellow Earth
Blue Neutral
Brown Live

As the colours of the wires in the mains lead of this apparatus may not correspond with the coloured markings identifying the terminals in your plug proceed as follows:

The wire which is coloured green-and-yellow must be connected to the terminal in the plug which is marked by the letter E or by the safety earth symbol \perp or coloured green or green-and-yellow.

The wire which is coloured blue must be connected to the terminal which is marked with the letter N or coloured black.

The wire which is coloured brown must be connected to the terminal which is marked with the letter L or coloured red.

WARNING : THIS APPARATUS MUST BE EARTHED.

THE SOCKET-OUTLET SHOULD BE INSTALLED NEAR THE EQUIPMENT AND EASILY ACCESSIBLE.

Part Names and Functions

Front

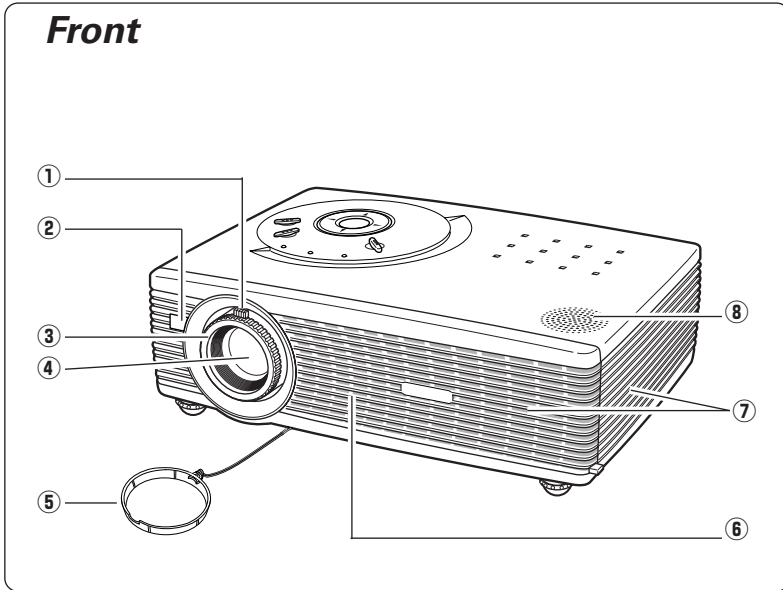

- ① Zoom Lever
- ② Infrared Remote Receiver
- ③ Focus Ring
- ④ Projection Lens
- ⑤ Lens Cover
- ⑥ Air Intake Vent
- ⑦ Exhaust Vent



CAUTION

Hot air is exhausted from the exhaust vent. Do not put heat-sensitive objects near this side.

- ⑧ Speaker

Back

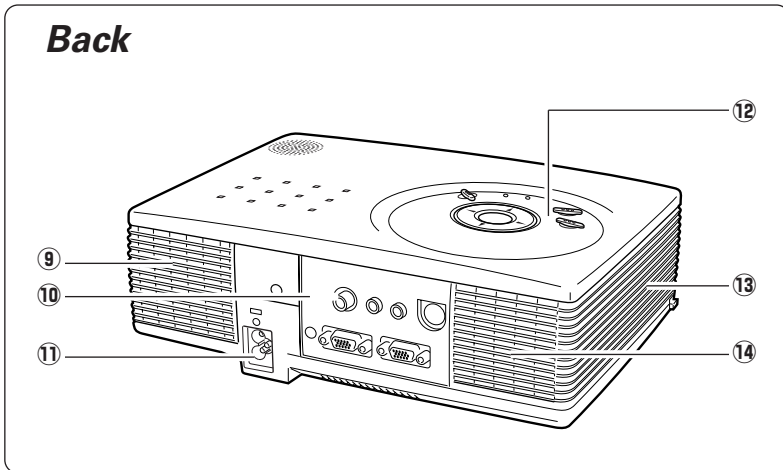

- ⑨ Air Intake Vent
- ⑩ Terminals and Connectors
- ⑪ Power Cord Connector
- ⑫ Top Controls and Indicators
- ⑬ Air Intake Vent
- ⑭ Exhaust Vent



CAUTION

Hot air is exhausted from the exhaust vent. Do not put heat-sensitive objects near this side.

Bottom

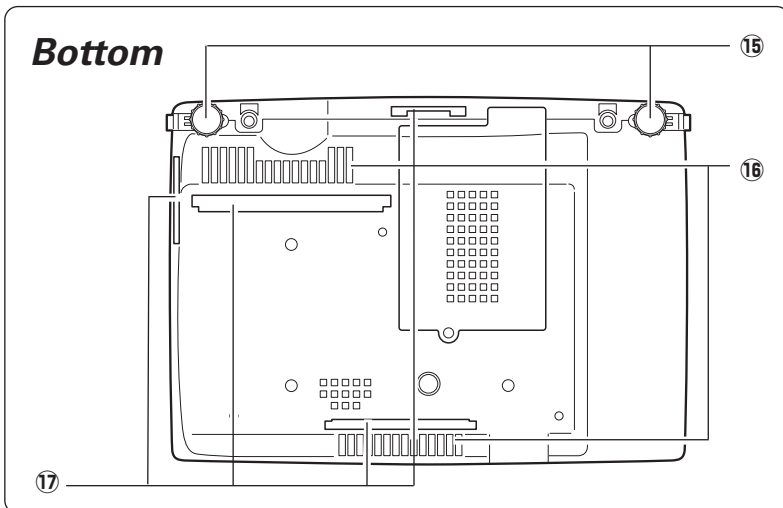

- ⑮ Adjustable Feet
- ⑯ Air Intake Vents
- ⑰ Air Filters

Rear Terminal

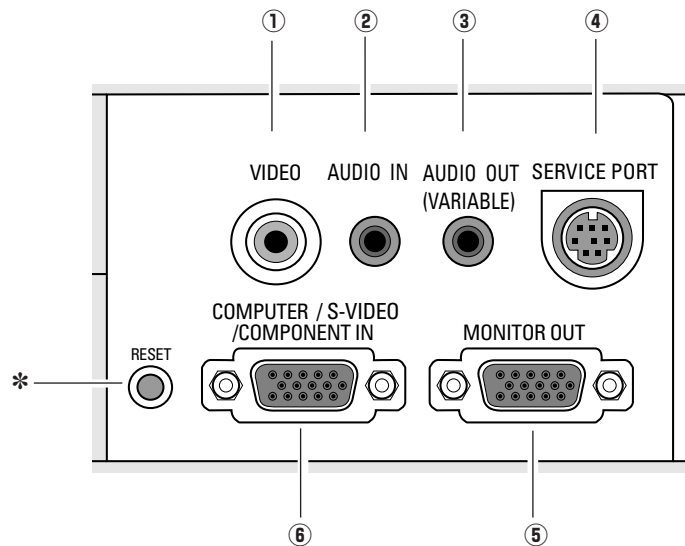

- ① **VIDEO**
Connect the composite video output from video equipment to VIDEO jack. (p16)
- ② **AUDIO IN (Stereo)**
Connect the audio output from computer or video equipment connected to ① or ⑥ to this jack. (p15, 16)
- ③ **AUDIO OUT (VARIABLE)**
Connect an external audio amplifier to this jack. (p15, 16)
This terminal outputs sound from AUDIO IN terminal.
- ④ **SERVICE PORT**
This jack is used to service this projector.
- ⑤ **MONITOR OUT**
This terminal outputs the signal coming from COMPUTER / S-VIDEO / COMPONENT IN terminal. (This terminal cannot output RGB(Scart) signal from COMPUTER / S-VIDEO / COMPONENT IN terminal.) (p15)
- ⑥ **COMPUTER / S-VIDEO / COMPONENT IN**
Connect S-video output, RGB Scart 21-pin video output, component video output or computer output to this connector. (p15)

* A built-in micro processor which controls this unit may occasionally malfunction and need to be reset. This can be done by pressing the RESET button with a pen, which will shut down and restart the unit. Do not use the RESET function excessively.

✓ **Note:**

- Audio out and Monitor out terminal works only when the projector is under operation and do not work when the projector is in stand-by state or Power management mode (p41).

Top Control

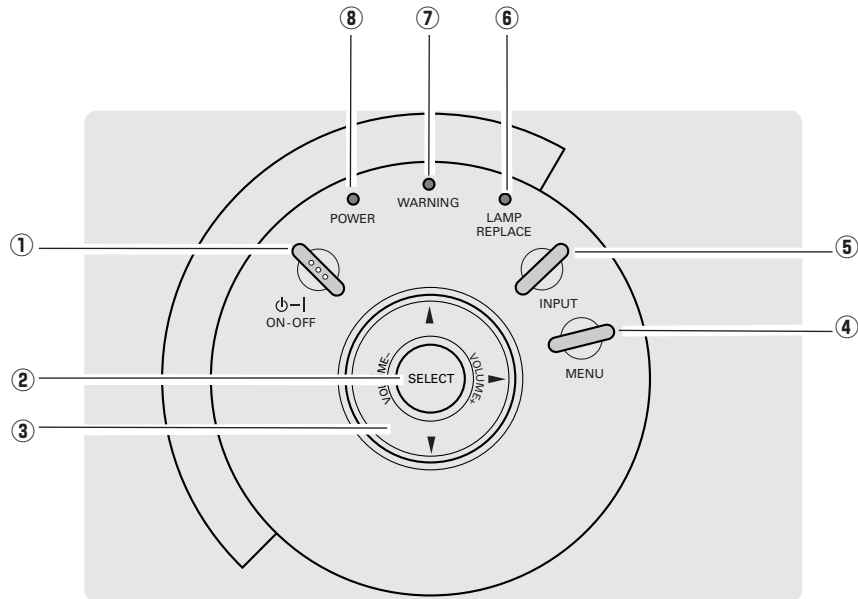

- ① **POWER ON-OFF button**
Turn the projector on or off. (p17,18)
- ② **SELECT button**
Execute the item selected. It is also used to expand/ compress the image in Digital zoom +/- mode. (p31)
- ③ **POINT (▲▼◀▶) button**
Select an item or adjusts value in the On-Screen Menu. These are also used to pan the image in the Digital zoom +/- mode. (p31)
Point ◀▶ button are used as VOLUME +/- button. (p23)
- ④ **MENU button**
Open or closes the On-Screen Menu. (p20)
- ⑤ **INPUT button**
Select input source. (p24, 32)
- ⑥ **LAMP REPLACE indicator**
Turn yellow when the life of the projection lamp draws to an end. (p48)
- ⑦ **WARNING indicator**
Light red when the projector detects abnormal condition. This also blinks red when the internal temperature of the projector exceeds the operating range. (p45)
- ⑧ **POWER indicator**
Blink red until the projector gets ready to be turned on. It turns red when the projector is in the stand-by mode. It remains green while the projector is under operation.

Remote Control

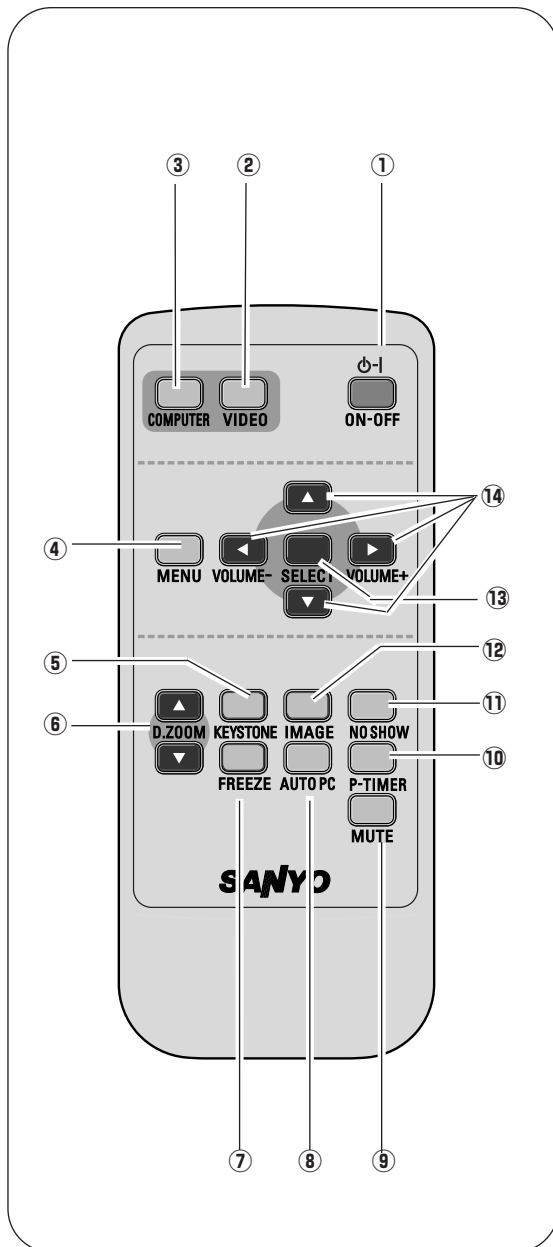

- ① **POWER ON-OFF button**
Turn the projector on or off. (p17, 18)
- ② **VIDEO button**
Select VIDEO input. (p32)
- ③ **COMPUTER button**
Select COMPUTER input source. (p24, 32)
- ④ **MENU button**
Open or closes the On-Screen Menu. (p20)
- ⑤ **KEYSTONE button**
Correct the keystone distortion. (p22, 38)
- ⑥ **D.ZOOM ▲▼ button**
Select the Digital zoom +/- mode and resize the image. (p31)
- ⑦ **FREEZE button**
Freeze the picture. (p22)
- ⑧ **AUTO PC button**
Automatically adjust a computer image to its optimum setting. (p26)
- ⑨ **MUTE button**
Mute the sound. (p23)
- ⑩ **P-TIMER button**
Operate the P-timer function. (p23)
- ⑪ **NO SHOW button**
Temporarily turn off the image on the screen. (p22)
- ⑫ **IMAGE button**
Select image level. (p29, 34)
- ⑬ **SELECT button**
Execute the selected item, or to expand or compress the image in Digital Zoom +/- mode. (p31)
- ⑭ **Point ▲▼◀▶ (VOLUME +/-) buttons**
Select an item or adjust value in the On-Screen Menu. These are also used to pan the image in the Digital zoom +/- mode. (p31)
Point ◀▶ buttons are also used as VOLUME +/- mode. (p23)

Operating Range

Point the remote control toward the projector (Infrared Remote Receiver) whenever pressing any button. Maximum operating range for the remote control is about 16.4' (5m) and 60° in front of the projector.

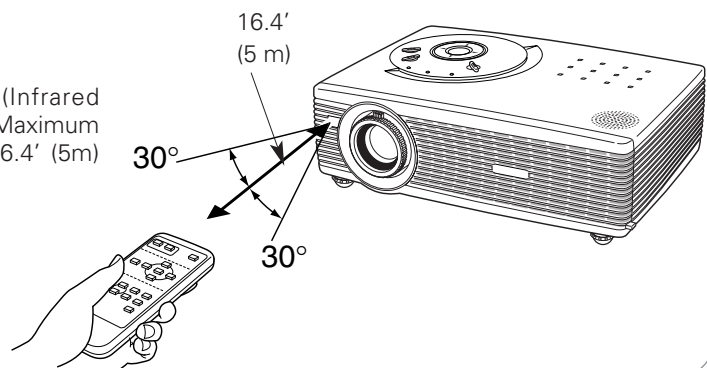

Remote Control Battery Installation

- 1** Remove the battery compartment lid.

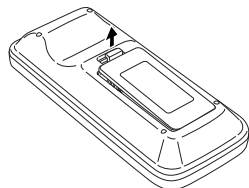

- 2** Slide the batteries into the compartment.

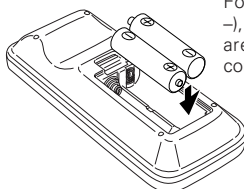

Two AAA size batteries
For correct polarity (+ and -), be sure battery terminals are in contact with pins in compartment.

- 3** Replace the compartment lid.

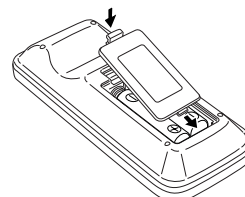

To insure safe operation, please observe the following precautions :

- Use (2) AAA, SUM-4 or R03 type alkaline batteries.
- Replace two batteries at the same time.
- Do not use a new battery with a used battery.
- Avoid contact with water or liquid.
- Do not expose the remote control to moisture, or heat.
- Do not drop the remote control.
- If a battery has leaked on remote control, carefully wipe case clean and install new batteries.
- Risk of explosion if battery is replaced by an incorrect type.
- Dispose of used batteries according to the instructions.

Installation

Positioning the Projector

This projector is designed to project on a flat projection surface and can be focused from 4.3'(1.3m) - 21.3'(6.5m). Refer to the figure and the table below for the screen size and the distance between the projector and the screen.

A : B = 9 : 1

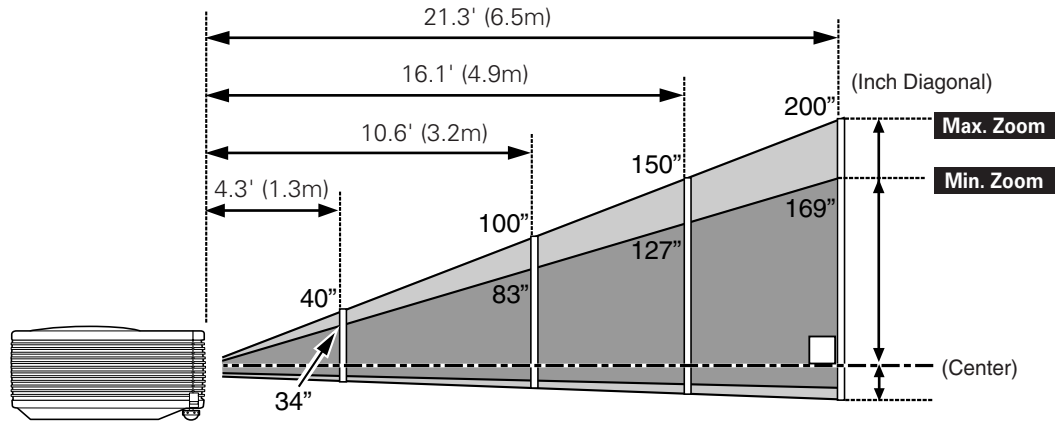

Screen Size (W x H) mm	34"	40"	100"	150"	200"
4 : 3 aspect ratio	691 x 518	813 x 610	2032 x 1524	3048 x 2286	4064 x 3048
Zoom (min)	4.3' (1.3m)	4.9' (1.5m)	12.5' (3.8m)	19.0' (5.8m)	—
Zoom (max)	—	4.3' (1.3m)	10.6' (3.2m)	16.1' (4.9m)	21.3' (6.5m)

✓ Note:

- The brightness in a room has a great influence on picture quality. It is recommended to limit ambient lighting in order to obtain the best image.
- The values shown above are approximate and may vary from the actual size.

Adjustable Feet

Projection angle can be adjusted up to 8.0 degrees with the adjustable feet.

- 1 Lift the front of the projector and pull upward the feet lock latches on both sides of the projector.
- 2 Release the feet lock latches to lock the adjustable feet and rotate the adjustable feet to adjust the position and tilt.
- 3 To retract the adjustable feet, lift the front of the projector and pull and undo the feet lock latches.
Keystone distortion of the projected image can be adjusted by Menu operation. (p22, 38)

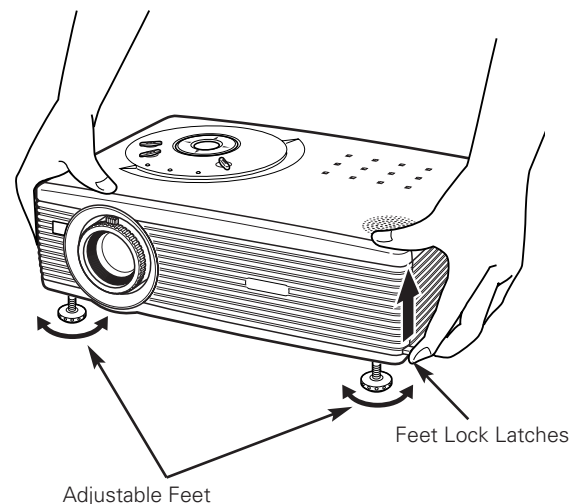

Connecting the AC Power Cord

This projector uses nominal input voltages of 100-120 V or 200-240 V AC. This projector automatically selects the correct input voltage. It is designed to work with single-phase power systems having a grounded neutral conductor. To reduce risk of electrical shock, do not plug into any other type of power system. Consult your authorized dealer or service station if you are not sure of the type of power being supplied. Connect the projector with all peripheral equipment before turning the projector on. (See page 15, 16 for connection.)

CAUTION

For safety, unplug AC power cord when the projector is not in use. When this projector is connected to an outlet with AC power cord, it is in Stand-by mode and consumes a little electric power.

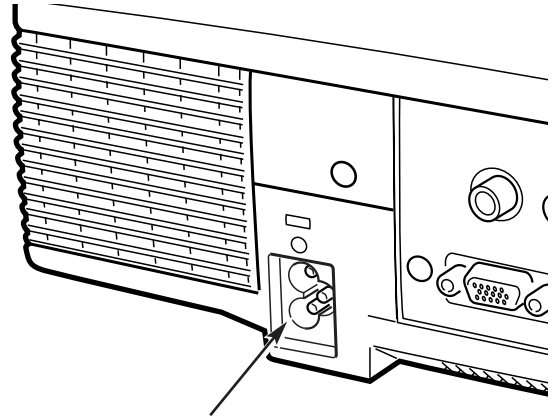

Connect AC power cord (supplied) to the projector. The AC outlet must be near this equipment and must be easily accessible.

NOTE ON THE POWER CORD

AC power cord must meet requirement of the country where you use a projector. Confirm an AC plug type with the chart below and proper AC power cord must be used. If supplied AC power cord does not match your AC outlet, contact your sales dealer.

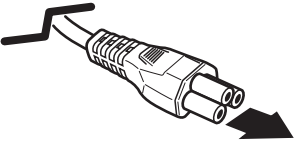
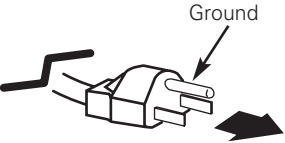
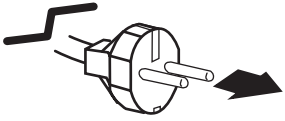
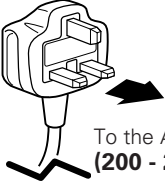
Projector side	AC outlet side		
 <p>To power cord connector on your projector.</p>	<p>For the U.S.A. and Canada</p>  <p>To the AC outlet. (120 V AC)</p>	<p>For Continental Europe</p>  <p>To the AC outlet. (200 - 240 V AC)</p>	<p>For the U.K.</p>  <p>To the AC outlet. (200 - 240 V AC)</p>

Connecting to a Computer

Cables used for connection

- VGA Cable (Mini D-sub 15 pin)
 - Audio Cable (Mini Plug: stereo) *
- (* = Not supplied with this projector.)

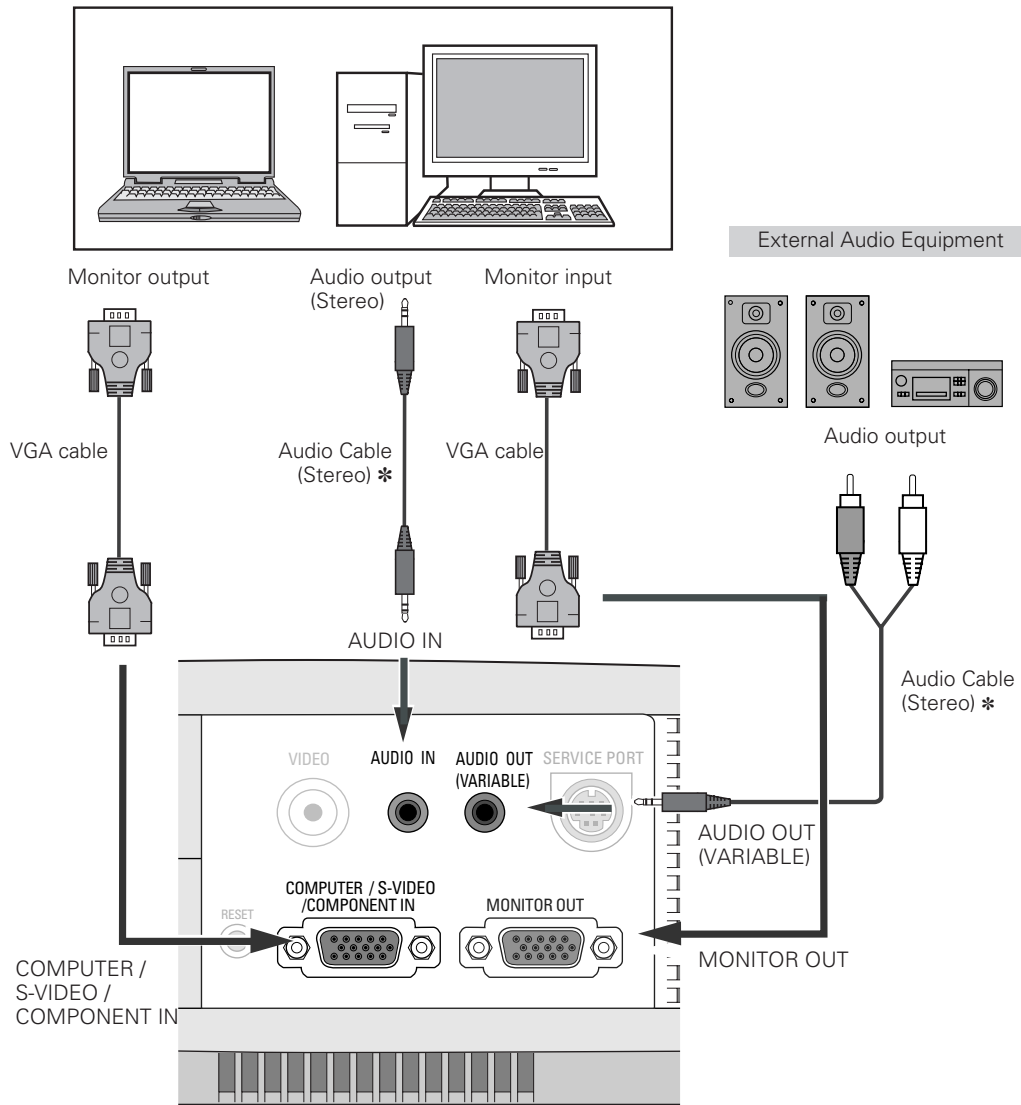

✓ **Note:**

- When connecting AUDIO OUT to external audio equipment, the projector's built-in speaker is disconnected.
- Audio out and Monitor out terminal works only when the projector is under operation and do not work when the projector is in stand-by state or Power management mode (p41).
- See p57 for ordering optional parts.



Note:

When connecting the cable, the power cords of both the projector and the external equipment should be disconnected from AC outlet.

Connecting to Video Equipment

Cables used for connection

- Scart-VGA Cable *
 - S-VIDEO-VGA Cable *
 - Component-VGA Cable *
 - Component Cable *
 - Video Cable *
 - Audio Cables (Mini Plug: stereo) *
 - VGA Cable (Mini D-sub 15 pin)
- (* = Not supplied with this projector.)

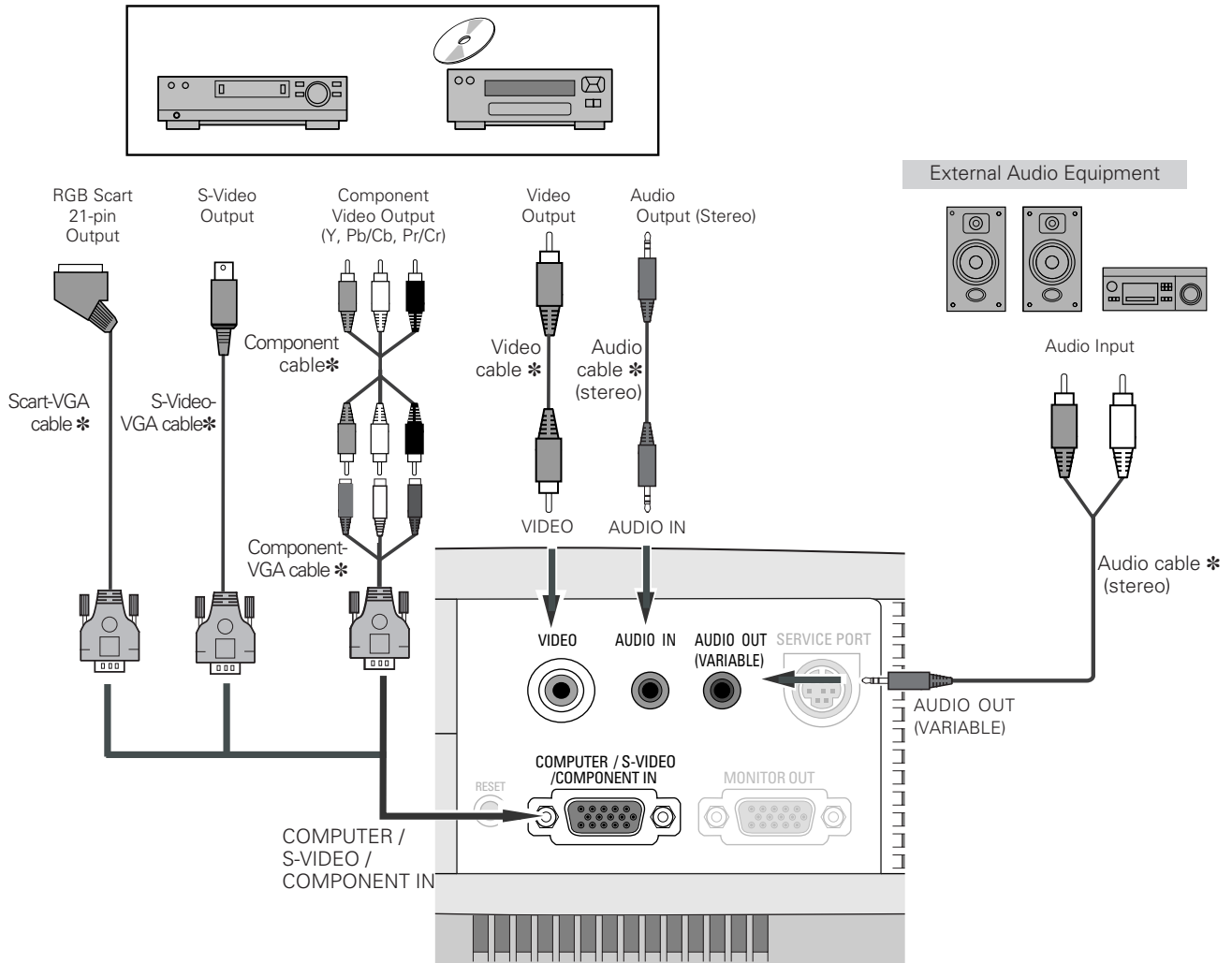

✓ **Note:**

- When connecting AUDIO OUT to external audio equipment, the projector's built-in speaker is disconnected.
- Audio out and Monitor out terminal works only when the projector is under operation and do not work when the projector is in stand-by state or Power management mode (p41).
- See p57 for ordering optional parts.



Note:

When connecting the cable, the power cords of both the projector and the external equipment should be disconnected from AC outlet.

Turning On the Projector

- 1 Complete peripheral connections (with a computer, VCR, etc.) before turning on the projector.
- 2 Connect the projector's AC power cord into an AC outlet. The POWER indicator blinks red in a moment and lights red.
- 3 Press the POWER ON-OFF button on the top control or on the remote control. The POWER indicator turns green lighting and the cooling fans start to operate. The preparation display appears on the screen and the count down starts.
- 4 After the count-down, the input source that was selected last and the Lamp mode status icon (see page 41) appear on the screen.

If the projector is locked with a PIN code, PIN code Input Dialog Box will appear. Enter the PIN code as instructed below.

Enter a PIN code

Select a number by pressing the Point ◀▶ button and fix the number with the SELECT button. The number will change to "*". If you fixed a wrong number, move the pointer to "Set" or "Clear" once by pressing the Point ▼ button, then return to "PIN code". Enter the correct number again. Repeat this step to complete entering a four-digit number.

When the four-digit number is fixed, the pointer will automatically move to "Set". Press the SELECT button so that you can start to operate the projector.

If you entered a wrong PIN code, "PIN code" and the number (****) will turn red and disappear. Enter a correct PIN code all over again.

What is PIN code?

PIN code is a security code using Personal Identification Number that allows the person who knows it to operate the projector. Setting PIN code prevents others except the specific users from operating the projector.

A PIN code consists of a four-digit number. Refer to PIN Code Lock function in Setting on page 43 for locking operation of the projector with your PIN code.



CAUTION ON HANDLING PIN CODE

If you forget your PIN code, the projector can no longer be started. Set a new PIN code with special care, write it down in column on page 59 of this manual, and keep it at hand. Should the PIN code be missing or forgotten, consult your dealer or service center.



The preparation display disappears after 20 seconds.

Selected Input Source and Lamp Mode

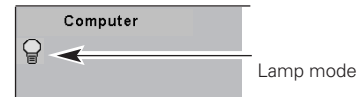

(See page 41 for Lamp mode.)

PIN code Input Dialog Box

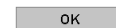

After the OK icon disappears, you can operate the projector.

Turning Off the Projector

- 1** Press the POWER ON-OFF button on the top control or on the remote control, and a message "Power off?" appears on the screen.
- 2** Press the POWER ON-OFF button again to turn off the projector. The POWER indicator starts to blink red, and it continues while the cooling fans are operating for about 90 seconds. (About 120 seconds when the fan mode is L2. See page 44.)
- 3** When the projector has cooled down enough to be turned on again, the POWER indicator lights red. Then you can disconnect the AC power cord.

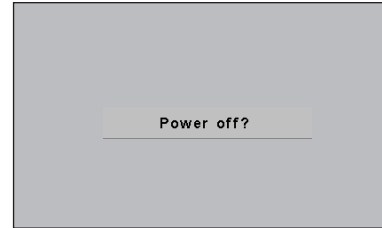

The message disappears after 4 seconds.



TO MAINTAIN THE LIFE OF LAMP, ONCE YOU TURN PROJECTOR ON, WAIT AT LEAST 5 MINUTES BEFORE TURNING IT OFF.
DO NOT DISCONNECT AC POWER CORD WHILE COOLING FANS ARE RUNNING OR BEFORE POWER INDICATOR LIGHTS RED. OTHERWISE IT WILL RESULT IN SHORTENING LAMP LIFE.

✓ Note:

- The projector cannot be turned on during the cooling period with the POWER indicator blinking red. You can turn it on again after the POWER indicator lights red.
- When the On start function is on, this projector is turned on automatically by connecting the AC power cord to an AC outlet. (See page 41 for the On start function.)
- Do not operate the projector continuously without rest. Continuous use may result in shortening the lamp life. Turn off the projector and give it a rest about an hour in every 24 hours.
- This projector monitors internal temperature and automatically controls the running speed of the cooling fans.
- If the WARNING indicator blinks or lights red, see "Warning Indicator" on page 45.

Zoom and Focus Adjustment

Rotate the Zoom Lever to zoom in and out.
Rotate the Focus Ring to adjust the projected picture focus.

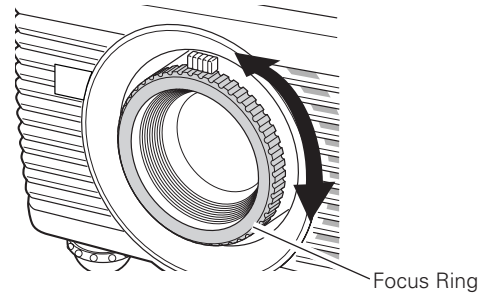
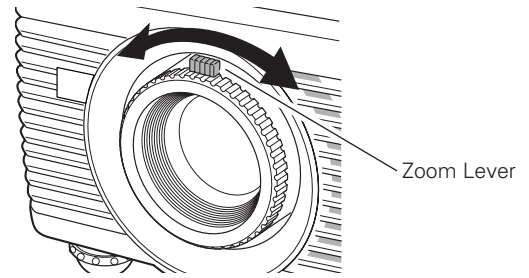

How to Operate the On-Screen Menu

The projector can be adjusted or set via the On-Screen Menu. Refer to the following pages regarding each adjustment and setting procedure.

- 1 Press the MENU button to display the On-Screen Menu.
- 2 Press the Point ◀▶ buttons to select a Menu icon to adjust. Press the Point ▲▼ buttons to select an item to adjust.
- 3 Press the SELECT button to show the item data. Press the Point ◀▶ buttons to adjust the data. Refer to the following pages for respective adjustment.

✓ **Note:**

- The selected item is not in effective until the SELECT button is pressed.

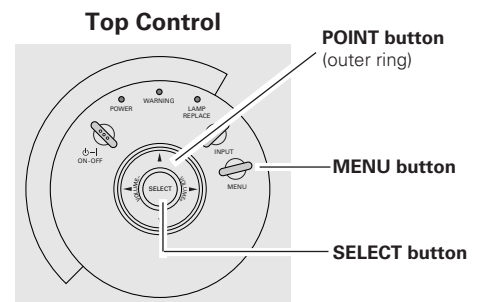
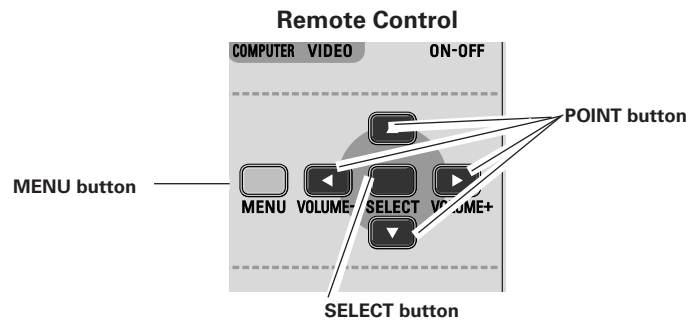
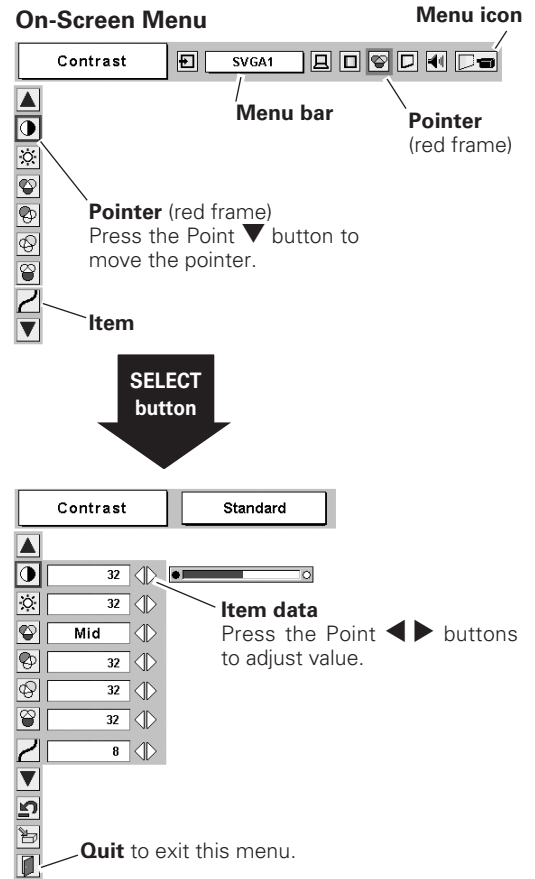

Menu Bar

For computer source

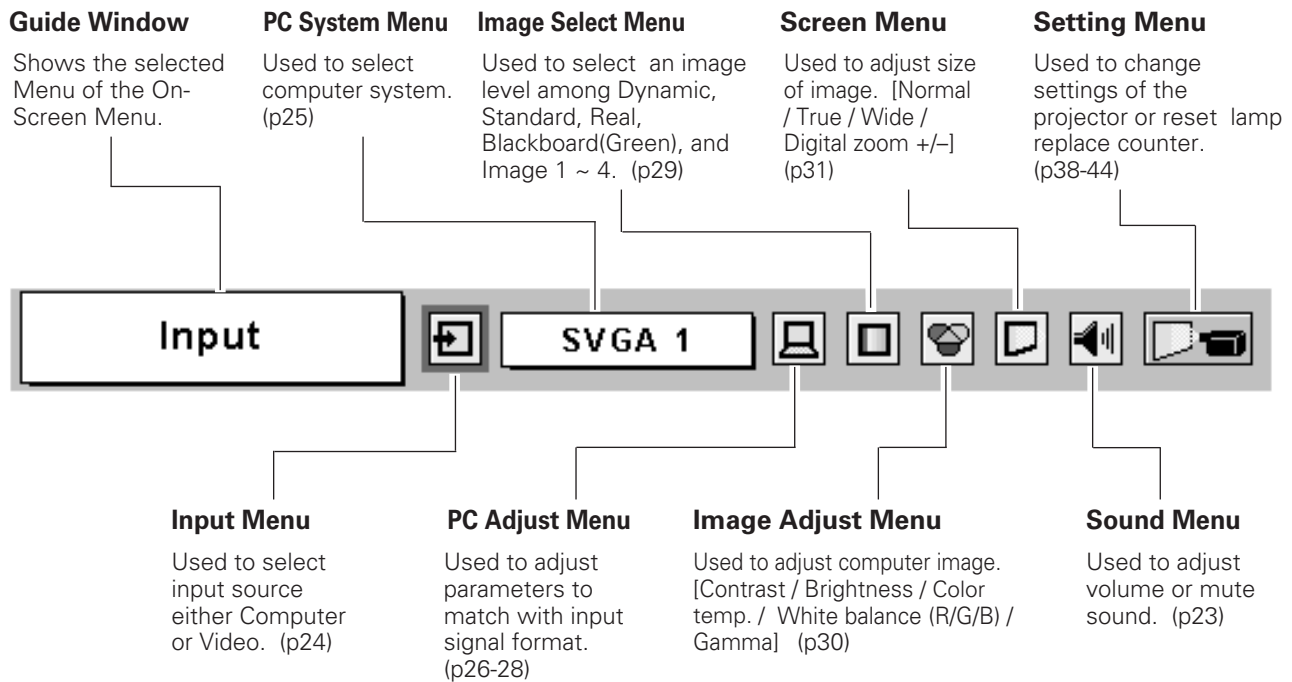

For video source

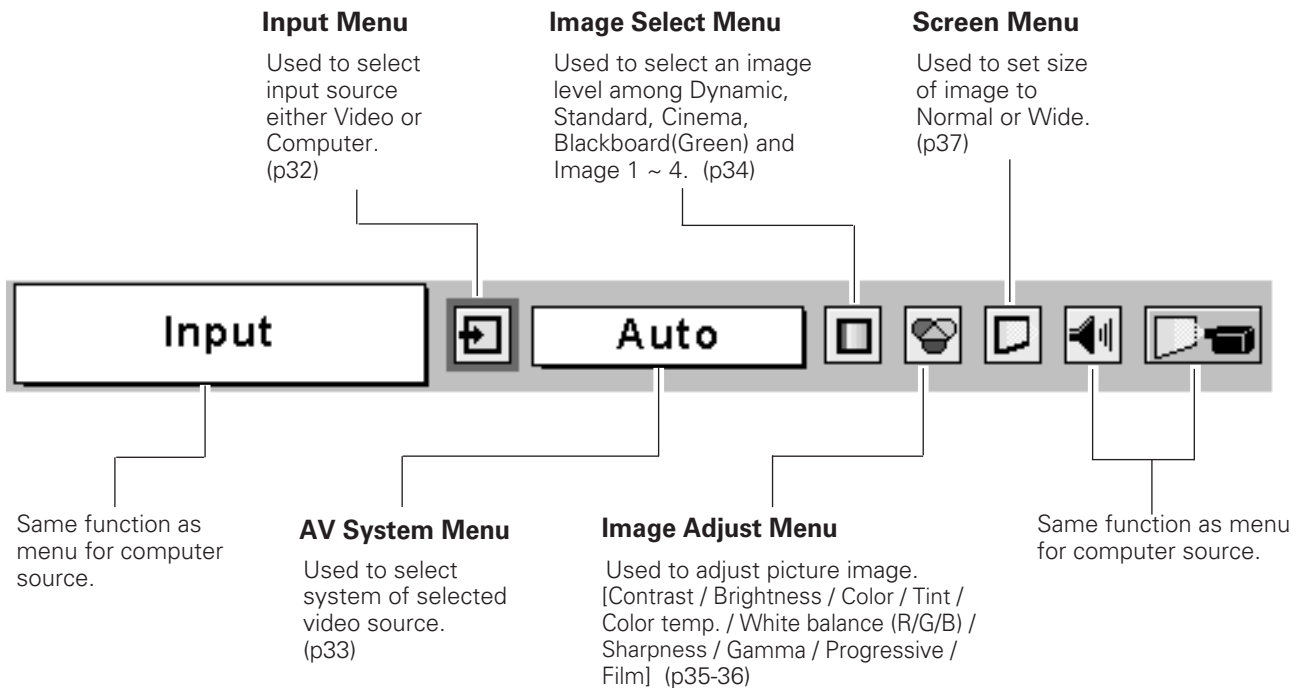

Keystone Adjustment

If a projected picture has keystone distortion, correct image with the keystone adjustment.

- 1 Press KEYSTONE button on the remote control or select Keystone on the Setting menu (p38) to display the Keystone dialog box.
- 2 Correct keystone distortion by pressing Point ▲▼ buttons. Press Point ▲ button to reduce the upper part of image, and press Point ▼ button to reduce the lower part.



- Arrows are white in no correction.
- The arrow of direction being corrected turns red.
- The arrow disappears at the maximum correction.
- If you press the KEYSTONE on the remote control once more while the keystone dialog box is being displayed, the adjustment will be canceled.

Reduce the upper width with Point ▲ button.

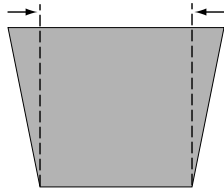

Reduce the lower width Point ▼ button.

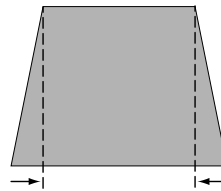

Picture Freeze Function

Press the FREEZE button on the remote control to freeze the picture on the screen. To cancel FREEZE, press the FREEZE button again or press any other button. (p11)

No Show Function

Press the NO SHOW button on the remote control to black out the image. To restore to normal, press the NO SHOW button again or press any other button. When a projected image is captured and set as "User" in the Logo item in the Setting Menu (p40), the screen changes each time you press the NO SHOW button as follows.

black out → the captured image → normal →

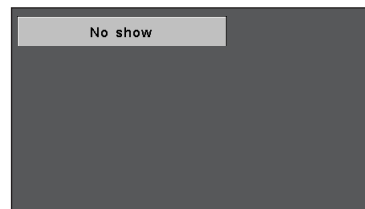

The message disappears after 4 seconds.

P-Timer Function

Press the P-TIMER button on the remote control. The timer display "00 : 00" appears on the screen and the timer starts to count time (00 : 00 ~ 59 : 59).

To stop the P-Timer, press the P-TIMER button. And then, press the P-TIMER button again to cancel the P-Timer function.



Sound Adjustment

Direct Operation

Volume

Press the VOLUME (+/-) button on the top control or on the remote control to adjust volume. The volume dialog box appears on the screen for a few seconds.

(+) button to turn up the volume and (-) button to turn down the volume.

Mute

Press the MUTE button on the remote control to cut off sound. To restore sound to its previous level, press the MUTE button again or press the VOLUME (+/-) button.

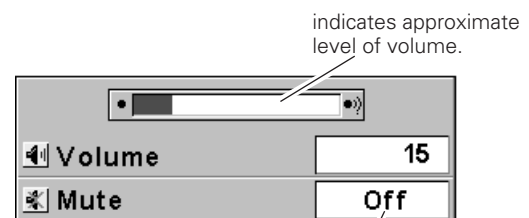

Press the MUTE button to set the Mute function On or Off.

The display disappears after 4 seconds.

Menu Operation

1 Press the MENU button and the On-Screen Menu will appear. Press the Point ◀▶ button to move the red frame pointer to the Sound Menu icon.

2 Press the Point ▼ button to move the red frame pointer to the item that you want to select, and then press the SELECT button.



Press the Point ▶ button to turn up the volume, and press the Point ◀ button to turn down the volume.



Press the Point ◀▶ button to cut off sound. Dialog box display is changed to "On" and sound is cut off. To restore sound to its previous level, press the Point ◀▶ button again.

Sound Menu

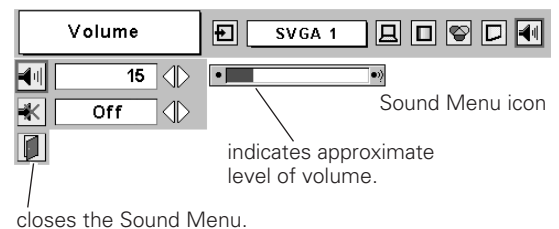

Computer Input

Input Source Selection

Direct Operation

Choose Computer by pressing the INPUT button on the top control or press the COMPUTER button on the remote control. Before using these buttons, correct input source should be selected through menu operation as described below.

INPUT button

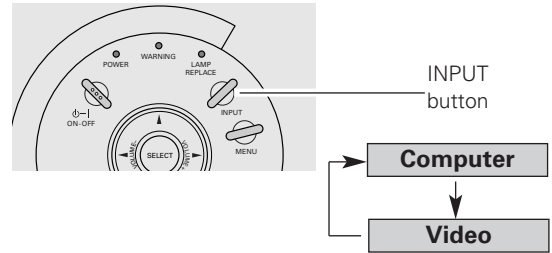

Remote Control

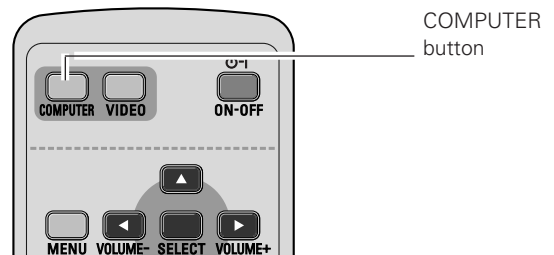

Menu Operation

- 1 Press the MENU button and the On-Screen Menu will appear. Press the Point ◀▶ button to move the red frame pointer to the Input Menu icon.
- 2 Press the Point ▼ button to move the red arrow pointer to Computer and then press the SELECT button.
- 3 After the Source Select Menu appears for Computer, move the pointer to RGB and then press the SELECT button.

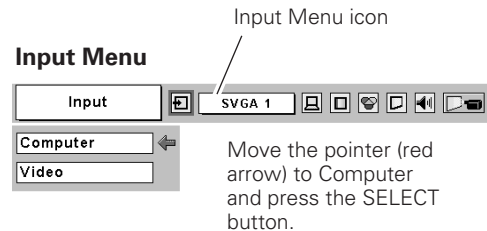

Computer System Selection

This projector automatically tunes to various types of computers based on VGA, SVGA, XGA or SXGA with its Multi-scan system and Auto PC Adjustment. If Computer is selected as a signal source, this projector automatically detects the signal format and tunes to project a proper image without any additional setting. (Signal formats provided in this projector is shown on page 55)

✓ Note:

The projector may display one of the following messages.

Auto When the projector cannot recognize connected signal conforming to PC Systems provided in this projector, Auto PC Adjustment function works to display proper images and the message "Auto" is displayed on the PC System menu box. When the image is not projected properly, manual adjustment is required. (p27, 28)

----- There is no signal input from computer. Check the connection of your computer and the projector. (See "Troubleshooting" p50)

Mode 1 User preset system manually adjusted in PC Adjust menu. Adjustment data can be stored in Mode 1 - 5. (p27, 28)

SVGA 1 PC Systems provided in the projector. The projector chooses a proper system and displays it.

*Mode 1 and SVGA 1 are examples.

PC System Menu

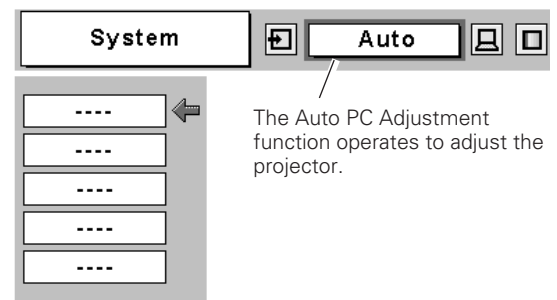

Selecting Computer System Manually

PC system can also be selected manually.

- 1** Press the MENU button and the On-Screen Menu will appear. Press the Point ◀▶ buttons to move the red frame pointer to the PC System Menu icon.
- 2** Press the Point ▼ button to move the red arrow pointer to the system that you want to set, and then press the SELECT button.

PC System Menu

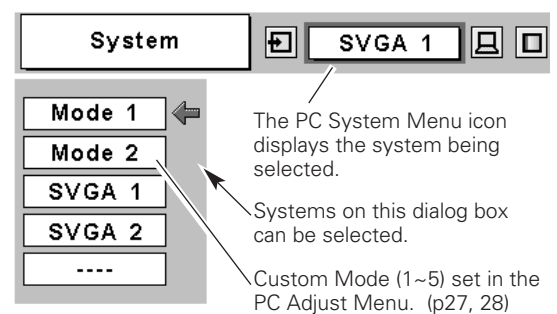

Auto PC Adjustment

Auto PC Adjustment function is provided to automatically adjust Fine sync, Total dots, Horizontal, and Vertical to conform to your computer. Auto PC Adjustment function can be operated as follows.

Auto PC Adj.

- 1 Press the MENU button to display the On-Screen Menu. Press the Point ◀▶ button to move the red frame pointer to PC Adjust Menu icon.
- 2 Press the Point ▼ button to move the red frame pointer to Auto PC Adj. icon and then press the SELECT button twice. This Auto PC Adjustment can be also executed by pressing the Auto PC button on the remote control unit.

To store adjustment parameters

Adjustment parameters from Auto PC Adjustment can be memorized in this projector. Once parameters are memorized, the setting can be done just by selecting Mode in the PC System Menu (p25). See "Store" on page 28.

✓ Note:

- Fine sync, Total dots and Picture Position of some computers can not be fully adjusted with this Auto PC Adjustment function. When the image is not provided properly with this operation, manual adjustments are required. (p 25, 27, 28)
- The Auto PC Adjust cannot be operated when 480i, 575i, 480p, 575p, 720p, 1035i, or 1080i is selected in the PC System Menu.

PC Adjust Menu

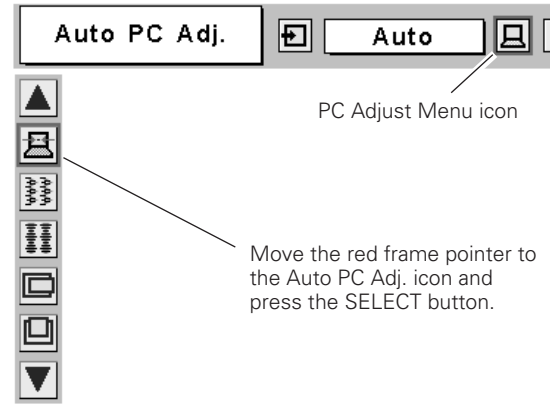

Manual PC Adjustment

Some computers employ special signal formats which may not be tuned by Multi-scan system of this projector. Manual PC Adjustment enables you to precisely adjust several parameters to match those signal formats. The projector has 5 independent memory areas to memorize those parameters manually adjusted. It allows you to recall the setting for a specific computer.

- 1 Press the MENU button and the On-Screen Menu will appear. Press the Point ◀▶ button to move the red frame pointer to the PC Adjust Menu icon.
- 2 Press the Point ▼ button to move the red frame pointer to the item that you want to adjust and then press the SELECT button. An adjustment dialog box will appear. Press the Point ◀▶ button to adjust value.

Fine sync

Eliminates flicker from the image displayed. Press the Point ◀▶ button to adjust value. (From 0 to 31)

Total dots

Adjusts the number of total dots in one horizontal period. Press the Point ◀▶ button and adjust number to match your PC image.

Horizontal

Adjusts horizontal picture position. Press the Point ◀▶ button to adjust the position.

Vertical

Adjusts vertical picture position. Press the Point ◀▶ button to adjust the position.

Current mode

Press the SELECT button to show H-Freq. and V-Freq. of the connected computer.

Clamp

Adjusts clamp level. When the image has dark bars, try this adjustment.

PC Adjust Menu

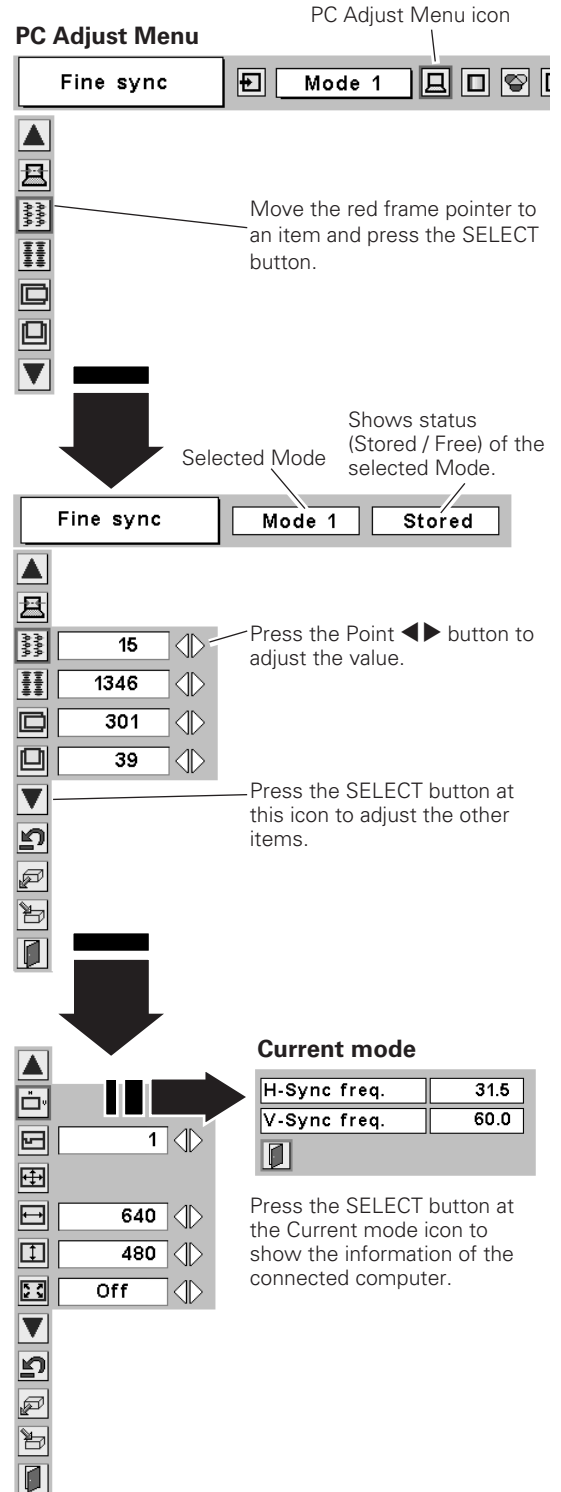

PC Adjust Menu icon

Fine sync Mode 1

Move the red frame pointer to an item and press the SELECT button.

Shows status (Stored / Free) of the selected Mode.

Selected Mode

Fine sync Mode 1 Stored

Press the Point ◀▶ button to adjust the value.

15 1346 301 39

Press the SELECT button at this icon to adjust the other items.

Current mode

H-Sync freq.	31.5
V-Sync freq.	60.0

Press the SELECT button at the Current mode icon to show the information of the connected computer.

 **Display area**

Select the resolution at the Display area dialog box.

 **Display area H**

Adjusts the horizontal area displayed by this projector. Press the Point ◀▶ button to decrease/increase value and then press the SELECT button.

 **Display area V**

Adjusts the vertical area displayed by this projector. Press the Point ◀▶ button to decrease/increase value and then press the SELECT button.

 **Full screen**

With this function on, SXGA image is fully displayed at 4 : 3 aspect ratio. It is displayed at 5 : 4 aspect ratio with this function off.

 **Reset**

Resets all adjustment to their previous levels.

 **Mode free**

To clear adjustment data previously set, move the red frame pointer to the Mode free icon and then press the SELECT button. Move the red arrow pointer to the Mode that you want to clear and then press the SELECT button.

 **Store**

To store adjustment data, move the red frame pointer to the Store icon and then press the SELECT button. Move the red arrow pointer to any of Mode 1 to 5 in which you want to store and then press the SELECT button.

 **Quit**

Exits the PC Adjust Menu.

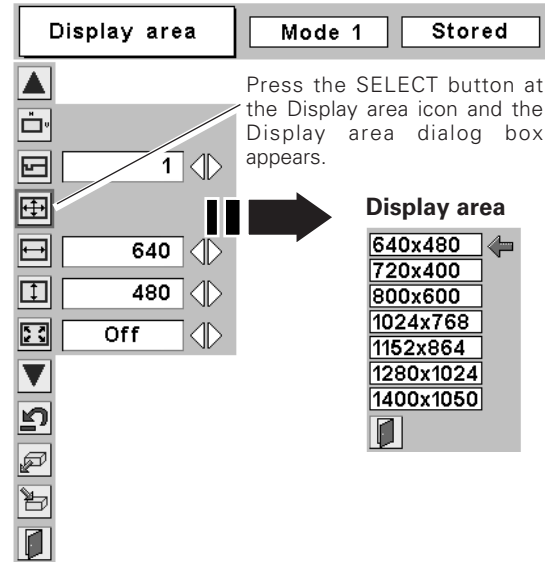

To store adjustment data

This Mode has parameters being stored.

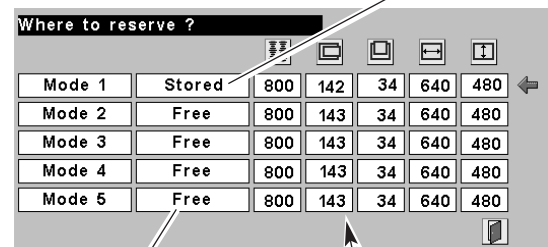

To clear adjustment data

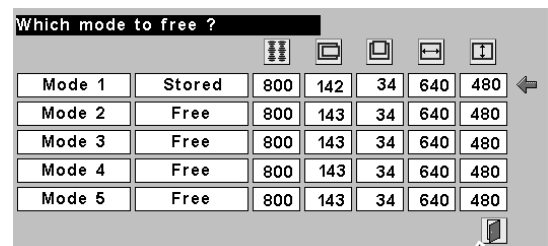

✓ **Note:**

- Auto PC Adjust, Display area, Display area (H/V), and Full screen cannot be selected when "480i", "575i", "480p", "575p", "720p", "1035i", or "1080i" is selected in the PC System Menu (p25).

Image Level Selection

Direct Operation

Select an image level among Dynamic, Standard, Real, Blackboard(Green), Image 1, Image 2, Image 3, and Image 4 by pressing the IMAGE button on the remote control.

Dynamic

Picture level suitable for viewing picture in a bright room.

Standard

Normal picture level preset on this projector.

Real

Picture level with improved halftone for graphics.

Blackboard(Green)

Picture level suitable for the image projected on a blackboard. This mode assists to enhance the image projected on a blackboard. This is mainly effective on a green colored board, not truly effective on a black colored board.

Image 1~4

User preset image in the Image Adjust Menu (p30).

Menu Operation

- 1 Press the MENU button and the On-Screen Menu will appear. Press the Point ◀▶ button to move the red frame pointer to the Image Select Menu icon.
- 2 Press the Point ▼ button to move the red frame pointer to the level that you want to set and then press the SELECT button.

Dynamic

Picture level suitable for viewing picture in a bright room.

Standard

Normal picture level preset on this projector.

Real

Picture level with improved halftone for graphics.

Blackboard(Green)

Picture level suitable for the image projected on a blackboard. See above for further description.

Image 1~4

User preset image in the Image Adjust Menu (p30).

Remote Control

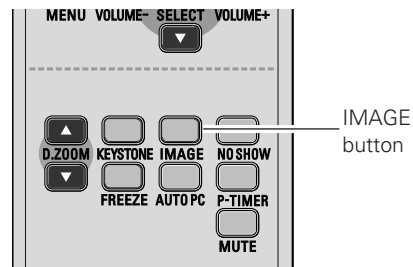

IMAGE button

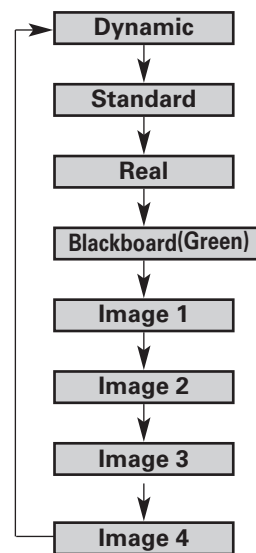

Image Select Menu

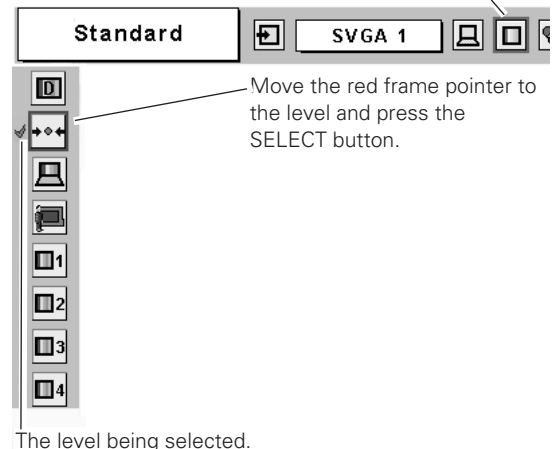

Image Level Adjustment

- 1 Press the MENU button and the On-Screen Menu will appear. Press the Point ◀▶ button to move the red frame pointer to the Image Adjust Menu icon.
- 2 Press the Point ▼ button to move the red frame pointer to the item that you want to adjust, and then press the SELECT button. The level of each item is displayed. Adjust each level by pressing the Point ◀▶ button.

Contrast

Press the Point ◀ button to decrease contrast and the Point ▶ button to increase contrast. (From 0 to 63.)

Brightness

Press the Point ◀ button to adjust image darker and the Point ▶ button to adjust image brighter. (From 0 to 63.)

Color temp.

Press the Point ◀ button or the Point ▶ button for Color temp. level that you want to select. (XLow, Low, Mid, or High)

White balance (Red)

Press the Point ◀ button to lighten red tone and the Point ▶ button to deepen red tone. (From 0 to 63.)

White balance (Green)

Press the Point ◀ button to lighten green tone and the Point ▶ button to deepen green tone. (From 0 to 63.)

White balance (Blue)

Press the Point ◀ button to lighten blue tone and the Point ▶ button to deepen blue tone. (From 0 to 63.)

Gamma

Press the Point ◀▶ button to obtain better balance of contrast. (From 0 to 15.)

Reset

Resets all adjustment to their previous levels.

Store

To store the image data adjusted manually, move the red frame pointer to the Store icon and press the SELECT button. The Image Level Menu will appear. Move the red frame pointer to the Image 1 to 4 where you want to set and then press the SELECT button.

Quit

Closes the Image Adjust Menu.

✓ Note:

- After adjusting any of the White balance Red, Green or Blue, the Color temp. will change to "User".

Image Adjust Menu

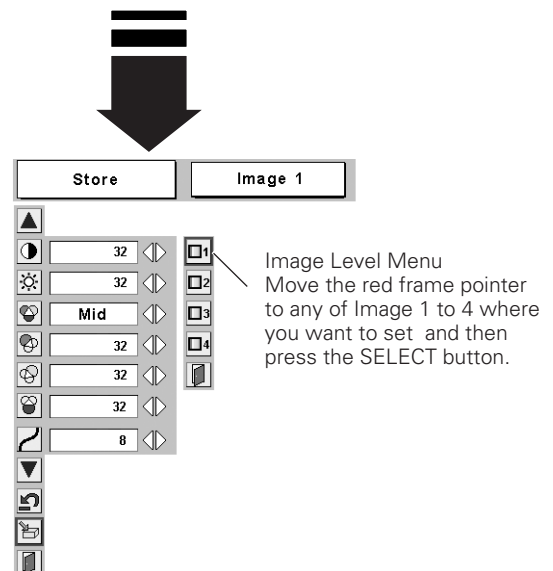
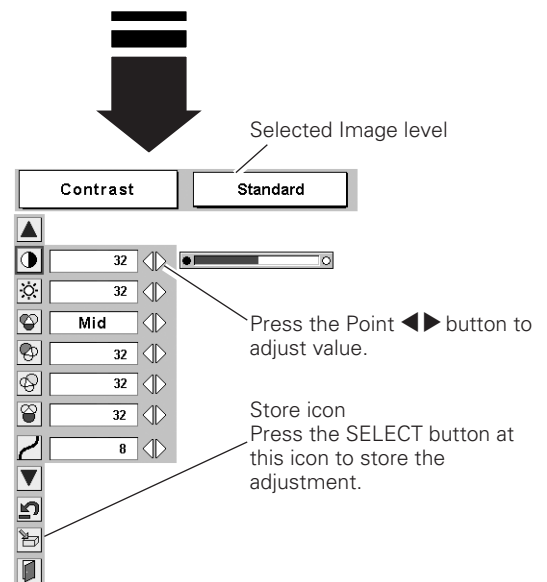
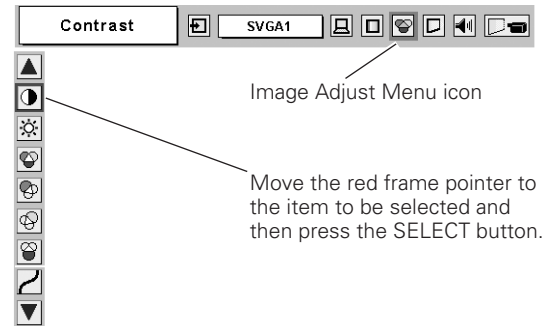

Screen Size Adjustment

This projector has a picture screen resize function, which enables you to display the desirable image size.

- 1 Press the MENU button and the On-Screen Menu will appear. Press the Point ◀▶ button to move the red frame pointer to the Screen Menu icon.
- 2 Press the Point ▼ button and move the red frame pointer to the function that you want to select and then press the SELECT button.

Normal

Provides image to fit screen size.

True

Provides image in its original size. When the original image size is larger than the screen size (800 x 600), this projector enters "Digital zoom +" mode automatically.

Wide

Provides image to fit wide video aspect ratio (16 : 9) by expanding image width uniformly. This function can be used for providing a squeezed video signal at 16 : 9.

Digital Zoom +

When the Digital Zoom + is selected, the On-Screen Menu disappears and the message "D. Zoom +" is displayed. Press the SELECT button to expand the image size. And press the Point ▲▼◀▶ button to pan the image. The Panning function can work only when the image is larger than the screen size.

A projected image can be also expanded by pressing the D.ZOOM ▲ button on the remote control.

Digital Zoom -

When the Digital Zoom - is selected, the On-Screen Menu disappears and the message "D. Zoom -" is displayed. Press the SELECT button to compress the image size.

A projected image can be also compressed by pressing the D.ZOOM ▼ button on the remote control.

To exit the Digital Zoom +/- mode, press any button except the D.ZOOM ▲▼, SELECT, and Point button.

To return to the normal screen, press KEYSTONE button or D. ZOOM ▲▼ button or select Normal from the Screen menu.

✓ Note:

- This Screen Menu cannot be operated when "720p(HDTV)", "1035i (HDTV)", or "1080i (HDTV)" is selected in the PC System Menu (p25).
- The True and Digital Zoom +/- cannot be selected when "480i", "575i", "480p", or "575p" is selected in the PC System Menu (p25).
- This projector cannot display any resolution higher than 1280 x 1024. If your computer's screen resolution is higher than 1280 X 1024, reset the resolution to the lower before connecting to the projector.
- The image data in other than SVGA (1280 x 1024) is modified to fit the screen size in initial mode.
- The panning function may not operate properly if the computer system prepared in the PC Adjust Menu is used.

Screen Menu

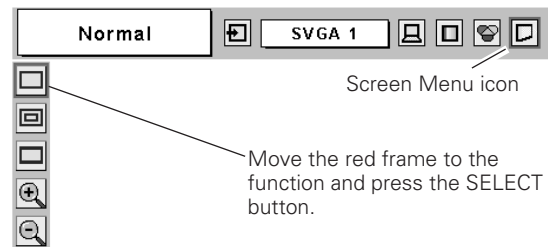

Video Input

Input Source Selection

Direct Operation

Choose either VIDEO or COMPUTER by pressing the INPUT button on the top control or VIDEO or COMPUTER button on the remote control.

Before using these buttons, correct input source should be selected through menu operation as described below.

INPUT button

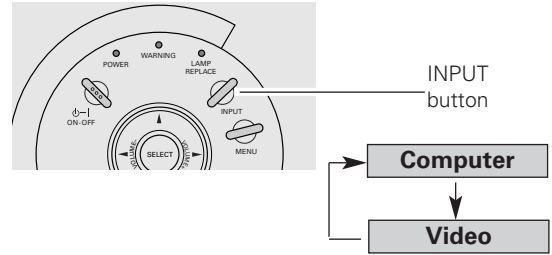

Remote Control

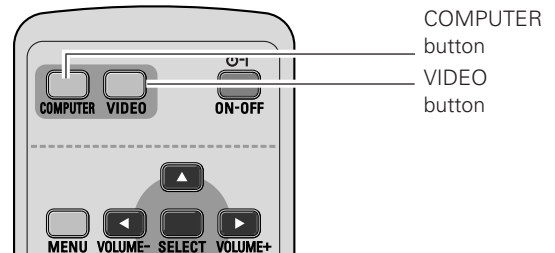

Menu Operation

- 1 Press the MENU button and the On-Screen Menu will appear. Press the Point ◀▶ button to move the red frame pointer to the Input Menu icon.
- 2 Press the Point ▼ button to move the red arrow pointer to VIDEO or COMPUTER and then press the SELECT button. The Source Select Menu will appear. When you select VIDEO, video input is selected. When you select COMPUTER, go to step 3 to select input source.
- 3 Move the pointer to the correct input source and then press the SELECT button.

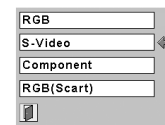
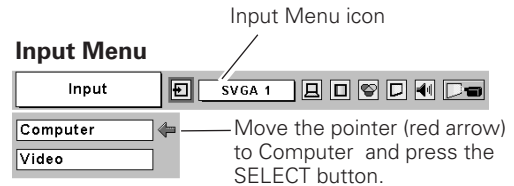

Source Select Menu

Move the pointer to S-Video, Component, RGB (Scart) and press the SELECT button.

S-Video When the input source is connected to the COMPUTER / S-VIDEO / COMPONENT IN with a S-Video-VGA Cable, select S-Video.

Component When the input source is coming from video equipment connected to the COMPUTER / S-VIDEO / COMPONENT IN with a Component-VGA Cable, select Component.

RGB (Scart) When the input source is coming from video equipment connected to the COMPUTER / S-VIDEO / COMPONENT IN with a Scart-VGA Cable, select RGB (Scart).

✓ Note:

- S-Video-VGA Cable, Component-VGA Cable and Scart-VGA Cable are optionally supplied. See page 57 for order.

Video System Selection

- 1 Press the MENU button and the On-Screen Menu will appear. Press the Point ◀▶ button to move the red frame pointer to the AV System Menu icon.
- 2 Press the Point ▼ button to move the red arrow pointer to the system that you want to select and then press the SELECT button.

Video or S-Video

Auto

The projector automatically detects incoming video system, and adjusts itself to optimize its performance. When Video System is PAL-M or PAL-N, select system manually.

PAL / SECAM / NTSC / NTSC4.43 / PAL-M / PAL-N

If the projector cannot reproduce proper video image, it is necessary to select a specific broadcast signal format among PAL, SECAM, NTSC, NTSC 4.43, PAL-M, and PAL-N.

AV System Menu (Video or S-Video)

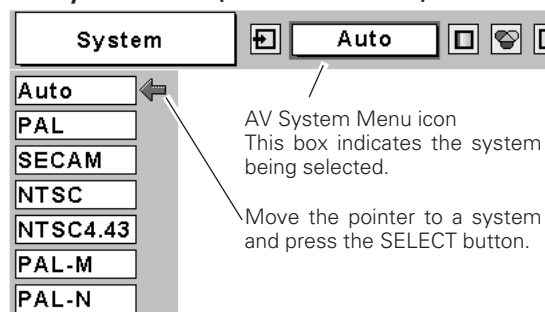

Component

Auto

The projector automatically detects incoming video signal, and adjusts itself to optimize its performance.

COMPONENT VIDEO SIGNAL FORMAT

If the projector cannot reproduce proper video image, it is necessary to select a specific component video signal format among 480i, 575i, 480p, 575p, 720p, 1035i, and 1080i.

AV System Menu (Component)

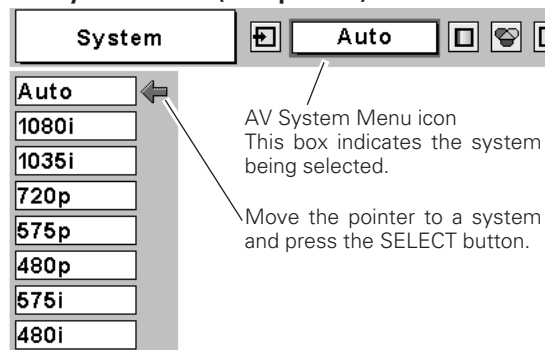

Image Level Selection

Direct Operation

Select a desired image level among Dynamic, Standard, Cinema, Blackboard (Green), Image 1, Image 2, Image 3, and Image 4 by pressing the IMAGE button on the remote control.

Dynamic

Picture level suitable for viewing picture in a bright room.

Standard

Normal picture level preset on this projector.

Cinema

Picture level adjusted for the picture with fine tone.

Blackboard(Green)

Picture level suitable for the image projected on a blackboard
This mode assists to enhance the image projected on a blackboard. This is mainly effective on a green colored board, not truly effective on a black colored board.

Image 1~4

User preset image in the Image Adjust Menu (p35, 36).

Menu Operation

- 1 Press the MENU button and the On-Screen Menu will appear. Press the Point ◀▶ button to move the red frame pointer to the Image Select Menu icon.
- 2 Press the Point ▼ button to move the red frame pointer to the level that you want to set and then press the SELECT button.

Dynamic

Picture level suitable for viewing picture in a bright room.

Standard

Normal picture level preset on this projector.

Cinema

Picture level adjusted for the picture with fine tone.

Blackboard(Green)

Picture level suitable for the image projected on a blackboard. See above for further description.

Image1~4

User preset image in the Image Adjust Menu (p35, 36).

Remote Control

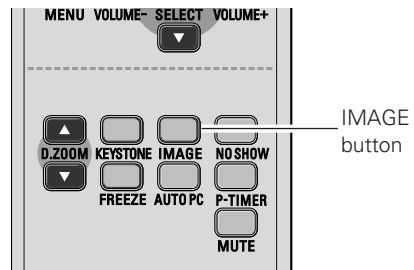

IMAGE button

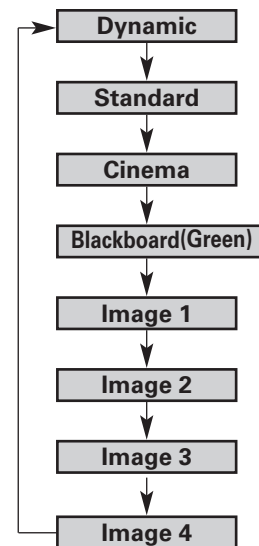

Image Select Menu

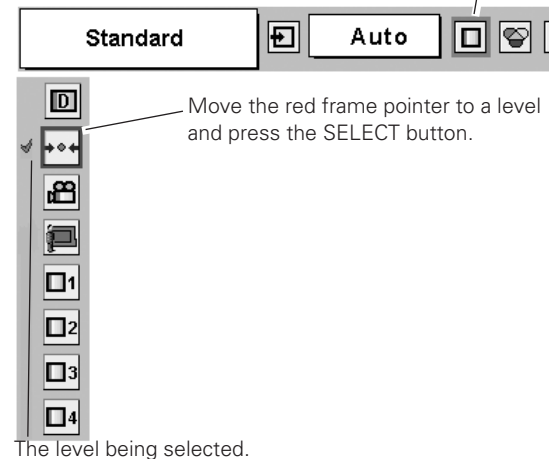

Image Level Adjustment

- 1 Press the MENU button and the On-Screen Menu will appear. Press the Point ◀▶ button to move the red frame pointer to the Image Adjust Menu icon.
- 2 Press the Point ▼ button to move the red frame pointer to the item that you want to adjust and then press the SELECT button. The level of each item is displayed. Adjust each level by pressing the Point ◀▶ button.

Contrast

Press the Point ◀ button to decrease contrast and the Point ▶ button to increase contrast. (From 0 to 63.)

Brightness

Press the Point ◀ button to adjust image darker and the Point ▶ button to adjust image brighter. (From 0 to 63.)

Color

Press the Point ◀ button to lighten color and the Point ▶ button to deepen color. (From 0 to 63.)

Tint

Press the Point ◀▶ button to obtain proper color. (From 0 to 63.)

Color temp.

Press the Point ◀▶ button for Color temp. level that you want to select. (XLow, Low, Mid, or High)

White balance (Red)

Press the Point ◀ button to lighten red tone and the Point ▶ button to deepen red tone. (From 0 to 63.)

White balance (Green)

Press the Point ◀ button to lighten green tone and the Point ▶ button to deepen green tone. (From 0 to 63.)

White balance (Blue)

Press the Point ◀ button to lighten blue tone and the Point ▶ button to deepen blue tone. (From 0 to 63.)

Sharpness

Press the Point ◀ button to soften the image and the Point ▶ button to sharpen the image. (From 0 to 15.)

Gamma

Press the Point ◀▶ button to obtain better balance of contrast. (From 0 to 15.)

✓ Note:

- The Tint cannot be adjusted when the video system is PAL, SECAM, PAL-M, or PAL-N.
- After adjusting any of the White balance Red, Green or Blue, the Color temp. will change to "User".

Image Adjust Menu

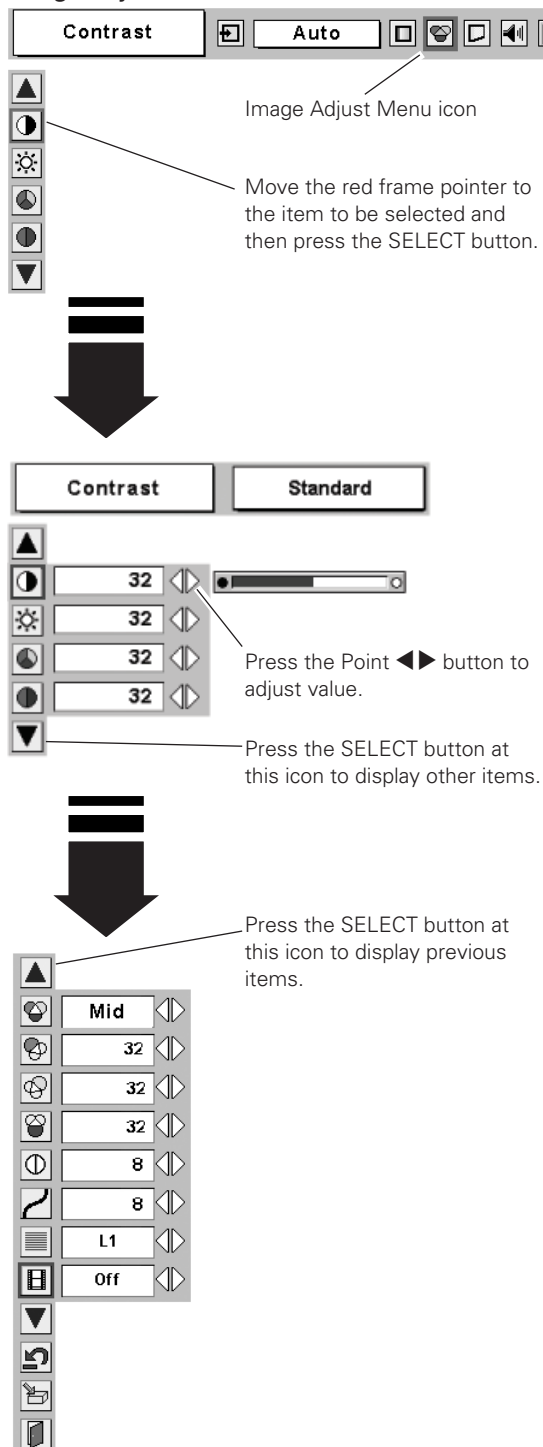

Progressive

Interlaced video signal can be displayed in a progressive picture.

OffNot activated.

L1Select "L1" for an active picture.

L2Select "L2" for a still picture.

Film

This function is effective on 3-2 pulldown video sources. With this function On, the projector reproduces pictures faithful to the original film quality.

Reset

Resets all adjustment to their previous figure.

Store

To store the adjustment data, move the red frame pointer to the Store icon and press the SELECT button. The Image Level Menu will appear. Move the red frame pointer to the Image Level 1 to 4 and then press the SELECT button.

Quit

Closes the Image Adjust Menu.

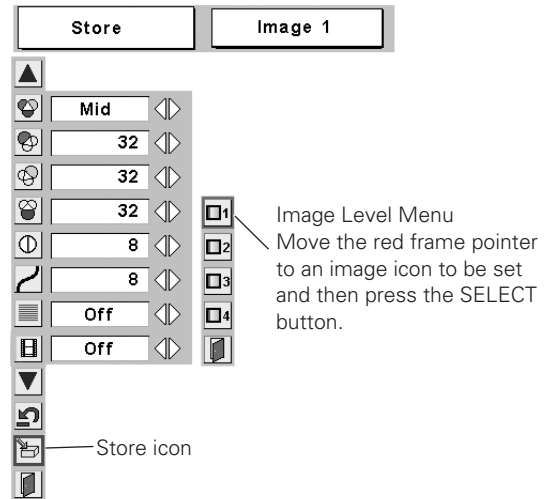

✓ **Note:**

- Progressive cannot be selected when 480p, 575p, 720p, 1035i, or 1080i is selected. (p33)
- Film can only be activated when selecting NTSC and 480i for Video System and L1 / L2 for Progressive.
- 3-2 Pulldown or Telecine transfer is the process of changing images from film mode to video mode. While film runs at 24 frames per second (fps), NTSC television signals (or video) have a run rate of 30fps so the 24 fps film needs to be speeded up to 30fps and transferred using a proper field pattern to get the best film-like images.

Screen Size Adjustment

This projector has a picture screen resize function, which enables you to display the desirable image size.

- 1 Press the MENU button and the On-Screen Menu will appear. Press the Point ◀▶ button to move the red frame pointer to the Screen Menu icon.
- 2 Press the Point ▼ button and move the red frame pointer to the function that you want to select and then press the SELECT button.

Normal

Provides image at a normal video aspect ratio of 4 : 3.

Wide

Provides image at a wide screen ratio of 16 : 9.

✓ **Note:**

- Screen Menu cannot be operated when "720p", "1035i", or "1080i" is selected in the AV System Menu (p33).

Screen Menu

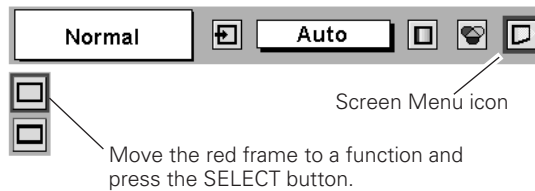

Setting

This projector has Setting menu that allows you to set up the other various functions described as follows;

- 1 Press the MENU button to display the On-Screen Menu. Press the Point ◀▶ button to move the red frame pointer to the Setting Menu icon.
- 2 Press the Point ▼ button to move the red frame pointer to the item that you want to set and then press the SELECT button. The Setting dialog box appears.

Language

The language used in the On-Screen Menu is available in English, German, French, Italian, Spanish, Portuguese, Dutch, Swedish, Russian, Chinese, Korean, or Japanese.

Keystone

This function corrects distortion of a projected image. Select either Store or Reset with the Point ◀▶ button, and then press the Select button. The keystone dialog box appears. Adjust keystone with the Point ▲▼ button.

Store stores the keystone adjustment even if the AC power cord is disconnected.

Reset resets the keystone adjustment when the AC power cord is disconnected.

Blue back

When this function is "On," the projector produces a blue image while input signal is not detected.

Display

This function decides whether to display On-Screen Displays.

On shows all the On-Screen Displays.

Off does not show On-Screen Displays except;

- On-Screen Menu
- "Power off?" message
- P-Timer
- "No signal" message
- "Wait a moment!" message

Setting Menu (Language)

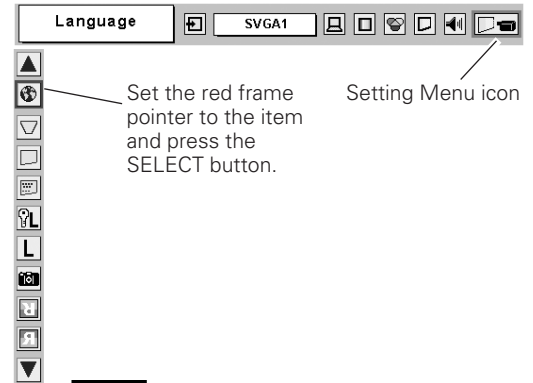

When pressing the SELECT button at Language, the Language Menu appears.

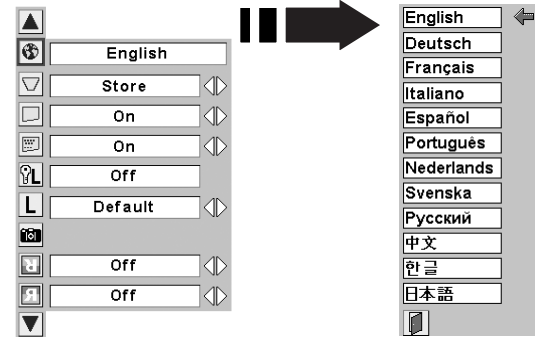

 **Logo PIN code lock**

This function prevents an unauthorized person from changing the Logo setting.

- Offthe Logo setting can be changed freely from the Logo menu. (p40)
- Onthe Logo setting cannot be changed without the Logo PIN code.

If you want to change the Logo PIN code lock setting, enter a Logo PIN code along the following steps. The initial Logo PIN code is set "4321" at the factory.

Enter a Logo PIN code

Select a number by pressing the Point ◀▶ button and fix the number with the SELECT button. The number will change to "*". If you fixed a wrong number, move the pointer to "Set" or "Clear" once by pressing the Point ▼ button, then return to "Logo PIN code". Enter the correct number again.

Repeat this step to complete entering a four-digit number.

When the four-digit number is fixed, the pointer will automatically move to "Set". Press the SELECT button so that you can change the Logo PIN code lock setting.

If you entered a wrong Logo PIN code, "Logo PIN code" and the number (****) will turn red and disappear. Enter a correct Logo PIN code all over again.

Change the Logo PIN code

Logo PIN code can be changed to your desired four-digit number. Select "Logo PIN code change" with the Point ▼ button and press the SELECT button. Set a new Logo PIN code.

Be sure to note the new Logo PIN code and keep it at hand. If you lost the number, you could no longer change the Logo PIN code setting. For details on PIN code setting, refer to relevant instructions of the PIN code lock function on page 43.

Logo PIN code lock

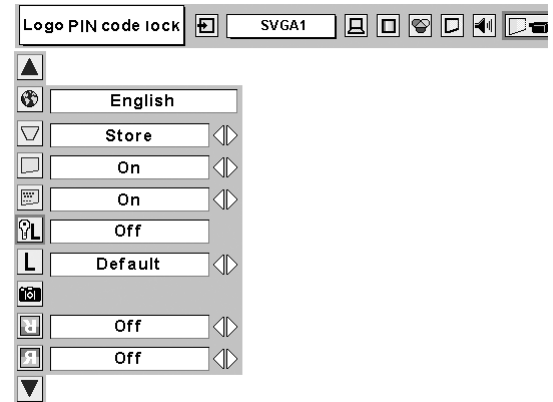

Logo PIN code lock Dialog Box

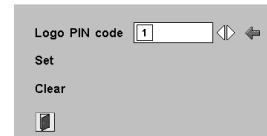

After a correct Logo PIN code is entered, the following dialog box will appear.



Select On/Off by pressing the Point ◀▶ button or change the Logo PIN code.

L Logo

This function decides what to be displayed on the starting-up display as follows:

- Userthe image you captured
- Defaultthe factory-set logo
- Offcount-down only

Capture

This function enables you to capture the image being projected and use it for a starting-up display or interval of presentations.

After capturing the projected image, go to the Logo function and set it to "User". Then the captured image can be displayed when turning on the projector next time or pressing the NO SHOW button. (p22)

To capture the image, select [Yes]. To cancel the Capture function, select [No].

✓ Note:

- Before capturing an image, select Standard in the Image Select Menu to capture a proper image. (See page 29, 34.)
- A signal from a computer can be captured up to XGA(1024 x 768). A signal from video equipment can be captured except for 720p, 1035i, and 1080i.
- When capturing the image that has been adjusted by the Keystone function, the adjustment data is automatically reset and the projector captures an image without keystone adjustment.
- When the PIN code lock function is On, the Logo and Capture menu cannot be selected.

R Ceiling

When this function is "On," the picture is top/bottom and left/right reversed. This function is used to project the image from a ceiling mounting the projector.

R Rear

When this function is "On," the picture is left/right reversed. This function is used to project the image to a rear projection screen.

Capture

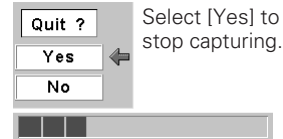
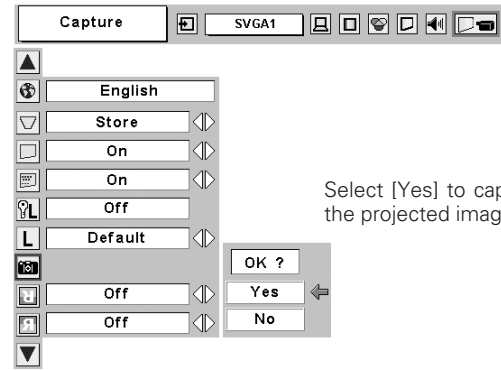

Ceiling

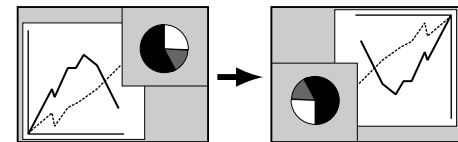

Rear

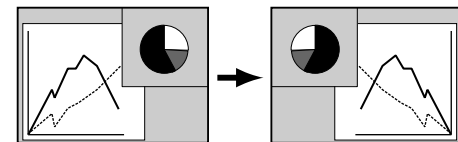

 **Power management**

For reducing power consumption as well as maintaining the lamp life, the Power Management function turns off the projection lamp when the input signal is interrupted and no button is pressed for a certain period.

If the input signal is interrupted and no button is pressed for 30 seconds or more, the timer display with the message "No signal" appears on the screen. The count-down of the set time will get started. The count-down time can be set between 1 and 30 minutes. Set the count-down time with Point ◀▶ button.

When the count-down time has been elapsed, the lamp will be turned off to cool itself down. The POWER indicator is blinking red during this cooling-off period. The next operation depends on the setting as follows :

- ReadyWhen the lamp has been fully cooled down, the POWER indicator changes to green blinking. In this condition, the projection lamp will be turned on if the input signal is reconnected or any button on the top control or remote control unit is pressed.
- ShutdownWhen the lamp has been fully cooled down, the power will be turned off.
- OffThe Power Management function is canceled.

 **On start**



When this function is "On," the projector is automatically turned on just by connecting the AC power cord to a wall outlet.

✔ **Note:**

Be sure to turn the projector off properly (see "Turning Off the Projector" on page 18). If the projector is turned off in the wrong steps, the On start function does not operate properly.

 **Lamp mode**

This function allows you to change brightness of the screen.

-  Normal.....normal brightness
-  Auto.....brightness according with the input signal
-  Ecolower brightness reduces the lamp power consumption and extends the lamp life.

Power management



Time left until Lamp off

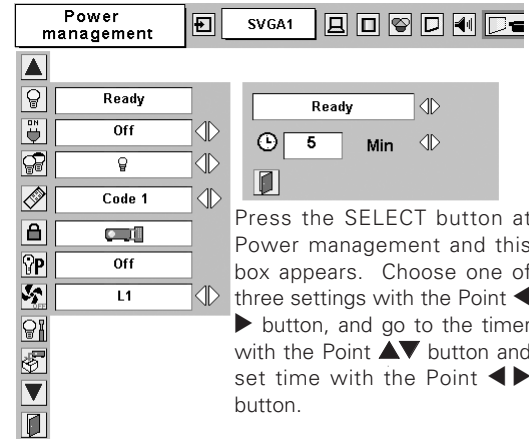

Press the SELECT button at Power management and this box appears. Choose one of three settings with the Point ◀▶ button, and go to the timer with the Point ▲▼ button and set time with the Point ◀▶ button.

 **Remote control**

This projector has two different remote control codes; the factory-set normal code (Code 1) and the secondary code (Code 2). This switching function prevents remote control interference when operating several projectors or video equipment at the same time. When operating the projector in "Code 2", both the projector and remote control must be switched to "Code 2".

To change the code of the projector :

Set the remote control in the Setting menu to "Code 2."

To change the code of the remote control :

Press and hold both MENU and IMAGE buttons on the remote control together for 10 seconds or more. After changing the code, make sure the remote control operates properly.

To return to the normal code (Code 1), operate both the projector and remote control in the ways above again.

 **Note :**

When battery of the remote control is replaced, the remote control code automatically returns to the normal code (Code 1).

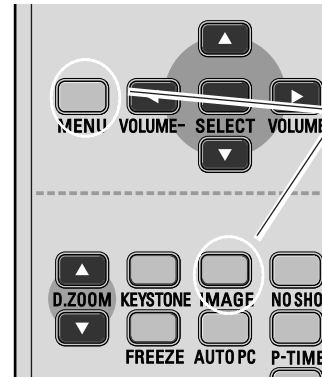

Remote control



Press and hold MENU and IMAGE buttons for 10 seconds or more.

 **Key lock**

This function locks operation of the top control and remote control. It is useful to prevent operation by an unauthorized person.

-  not locked.
-  locks operation of the top control. To unlock, use the remote control.
-  locks operation of the remote control. To unlock, use the top control.

If the top control accidentally becomes locked and you do not have the remote control nearby, disconnect the AC power cord from the AC outlet, and then with pressing the SELECT button, reinsert the AC power cord. This will cancel the top control lock.

Key lock

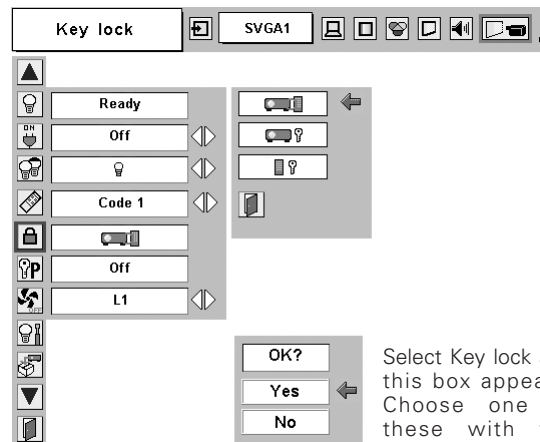

Select Key lock and this box appears. Choose one of these with the Point ▲▼ button and select [Yes] to activate it.

🔑 PIN code lock

This function prevents the projector from being operated by an unauthorized person and provides the following settings for security options.

- Off.....the projector is unlocked with the PIN code.
- On1requires to enter the PIN code every time turning on the projector.
- On2.....requires to enter the PIN code to operate the projector once the power cord is disconnected; as long as the AC power cord is connected, the projector can be operated without the PIN code.

Whenever to change the PIN code lock setting or the PIN code (the four-digit number), you are required to enter the PIN code. "1234" is set as the initial PIN code at the factory.

Enter a PIN code

Select a number by pressing the Point ◀▶ button and fix the number with the SELECT button. The number will change to "*". If you fixed a wrong number, move the pointer to "Set" or "Clear" once by pressing the Point ▼ button, then return to "PIN code". Enter the correct number again. Repeat this step to complete entering a four-digit number.

When the four-digit number is fixed, the pointer will automatically move to "Set". Press the SELECT button so that you can change the following PIN code lock settings.

If you entered a wrong PIN code, "PIN code" and the number (****) will turn red and disappear. Enter a correct PIN code all over again.

To Change the PIN code lock setting

Select Off, On1, or On2 with the Point ◀▶ button and then "Quit" with the Point ▼ button and press the SELECT button to close the dialog box.

To Change the PIN code

The PIN code can be changed to your desired four-digit number. Select "PIN code change" with the Point ▼ button, and press the SELECT button. The New PIN code input dialog box will appear.

Select a number with the Point ◀▶ button and fix the number with the SELECT button. Repeat it to complete entering a four-digit number. When the four-digit number is fixed, the pointer will automatically move to "Set". Then press the SELECT button.

CAUTION:
WHEN YOU HAVE CHANGED PIN CODE, WRITE DOWN THE NEW PIN CODE IN COLUMN OF THE PIN CODE NO. MEMO ON PAGE 59, AND KEEP IT SECURELY. SHOULD THE PIN CODE BE LOST OR FORGOTTEN, THE PROJECTOR CAN NO LONGER BE OPERATED.

PIN code lock

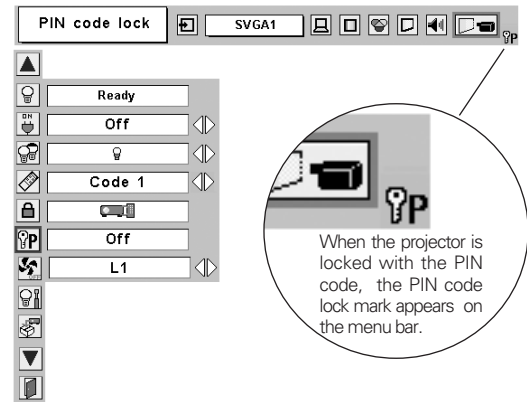

Enter a PIN code

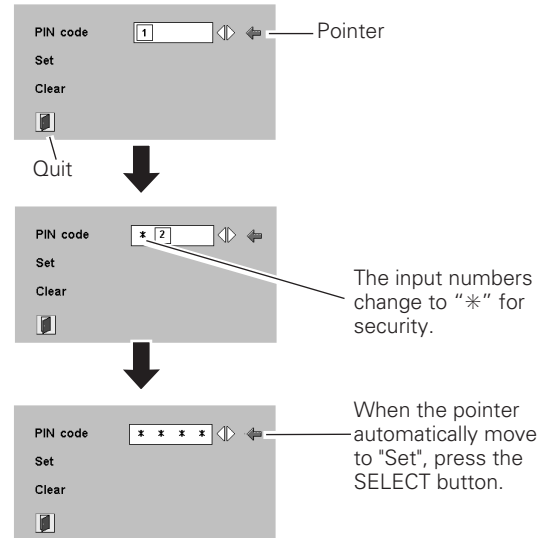

Change the PIN code lock setting



Change the PIN code

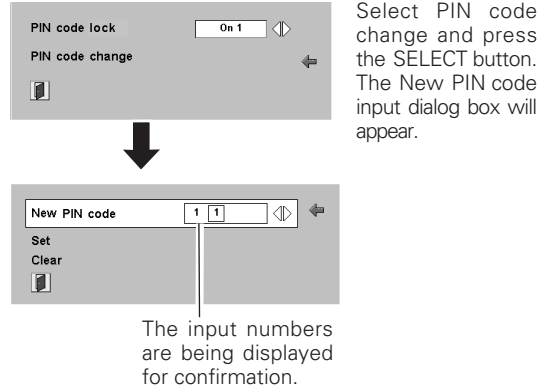

 **Fan**

This function provides you the following alternatives in the cooling fans operation after turning off the projector. (p18)

- L1normal operation
- L2slower operation than the normal (L1), but takes longer to cool down the projector. In this mode, cooling time after turning off the projector will be extended longer than in the normal mode.

 **Lamp counter reset**

This function is used to reset the lamp replace counter. When replacing the projection lamp, reset the lamp replace counter by using this function. See page 49 for operation.

 **Factory default**

This function returns all setting values except for the user logo, PIN code lock, Logo PIN code lock and the lamp counter to the factory default settings.

Fan

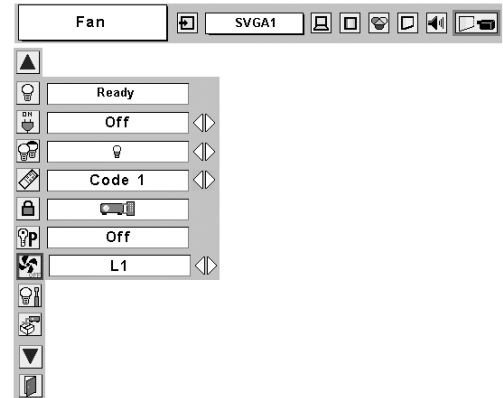

Factory default

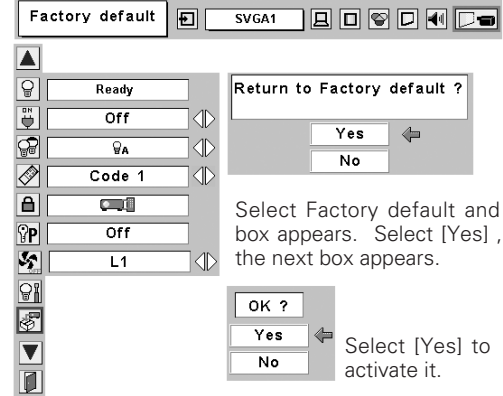

Warning Indicator

The WARNING indicator shows the state of the function which protects the projector. Check the state of the WARNING indicator and the POWER indicator to take proper maintenance.

The projector is shut down and the WARNING indicator is blinking red.

When the temperature inside the projector exceeds the normal temperature, the projector is automatically shut down to protect the inside of the projector. The POWER indicator is blinking and the projector is being cooled down. When the temperature inside the projector returns to normal, the POWER indicator lights red and the projector can be turned on.

✓ **Note:**

- After the temperature inside the projector returns to normal, the WARNING indicator still continues to blink. When the projector is turned on again, the WARNING indicator stops blinking.

Then check the matters below:

- Did you provide appropriate space for the projector to be ventilated? Check the installing condition to see if ventilation slots are not blocked.
- Is the projector not installed near the ventilation duct of air-conditioning equipment which may be hot? Install the projector away from the ventilation duct of air-conditioning equipment.
- Are the air filters clean? Clean the air filters periodically. (p46)

The projector is shut down and the WARNING indicator lights red.

When the projector detects an abnormal condition, it is automatically shut down to protect the inside and the WARNING indicator lights red. In this case, disconnect the AC power cord and reconnect it, and then turn the projector on once again for check. If the projector is still turned off and the WARNING indicator lights red, disconnect the AC power cord and contact the service station for check and repair.



CAUTION

DO NOT LEAVE THE PROJECTOR WITH THE AC POWER CORD CONNECTED UNDER THE ABNORMAL CONDITION. IT MAY RESULT IN FIRE OR ELECTRIC SHOCK.

TOP CONTROL

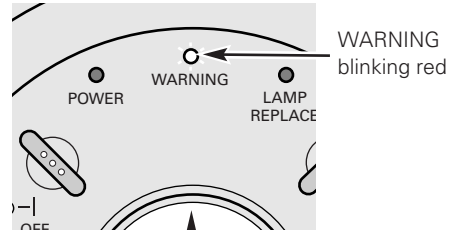

TOP CONTROL

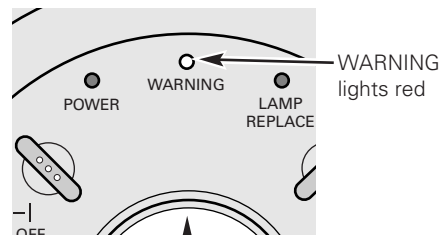

Cleaning the Air Filters

Air filters prevent dust from accumulating on the surface of the optical elements inside the projector. Should the air filters become clogged with dust particles, it will reduce cooling fans' effectiveness and may result in internal heat build up and adversely affect the life of the projector. Clean the air filters following the steps below.

- 1** Turn off the projector, and disconnect the AC power cord from the AC outlet.
- 2** Turn the projector upside down and remove the air filters by pulling the latches upward.
- 3** Clean the air filters with a brush or rinse them softly.
- 4** When cleaning the air filters by rinsing, dry them well. Replace the air filters properly. Make sure that the air filters are fully inserted.



CAUTION

Do not operate the projector with the air filters removed. Dust may accumulate on the LCD panel and the projection mirror degrading picture quality. Do not put small parts into the air intake vents. It may result in malfunction of the projector.

RECOMMENDATION

We recommend avoiding dusty/smoky environments when operating the projector. Usage in these environments may cause poor image quality.

When using the projector under dusty or smoky conditions, dust may accumulate on a lens, LCD panels, or optical elements inside the projector. This condition may degrade the quality of a projected image.

When the symptoms above are noticed, contact your authorized dealer or service station for proper cleaning.

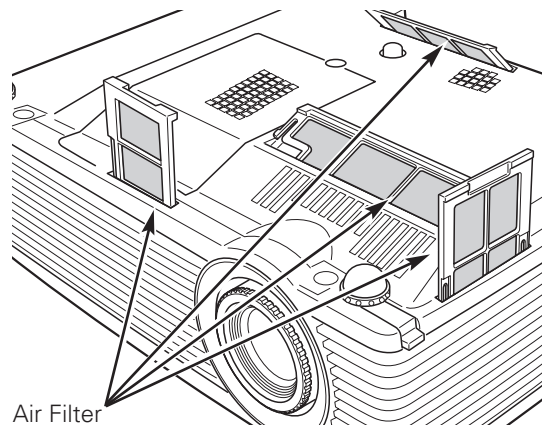

Air Filter
Pull up and remove.

Cleaning the Projection Lens

Follow these steps to clean the projection lens.

- 1** Disconnect the AC power cord before cleaning.
- 2** Softly wipe the projection lens with a cleaning cloth that contains a small amount of non-abrasive camera lens cleaner, or use lens cleaning paper or a commercially available air blower to clean the lens. Avoid using an excessive amount of cleaner. Abrasive cleaners, solvents, or other harsh chemicals might scratch the surface.
- 3** When the projector is not in use, replace the lens cover.

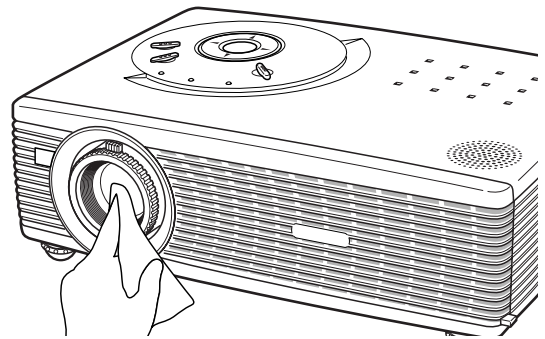

Cleaning the Projector Cabinet

Follow these steps to clean the projector cabinet.

- 1** Disconnect the AC power cord before cleaning.
- 2** Softly wipe the projector body with a soft, dry cleaning cloth. When it is heavily soiled, use a small amount of mild detergent and finish with a soft, dry cleaning cloth. Avoid using an excessive amount of cleaner. Abrasive cleaners, solvents, or other harsh chemicals might scratch the surface.
- 3** When the projector is not in use, put the projector in an appropriate carrying case to protect it from dust and scratches.

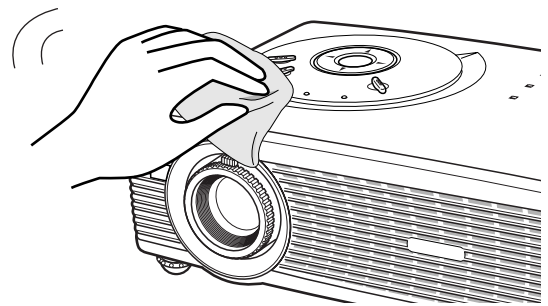

Attaching the Lens Cover

When moving this projector or while not using it over an extended period of time, replace the lens cover.

- 1** Thread the string through the hole on the lens cover and then tie a knot in the string to secure it in place.
- 2** Thread the other end of the string through the hole at the bottom of the projector. Then pass the lens cover through the resulting loop of the string. Tie a knot in the string to secure it in place.

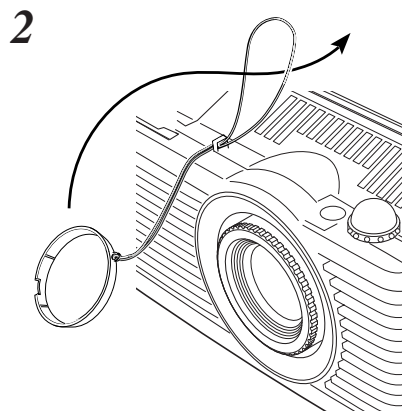
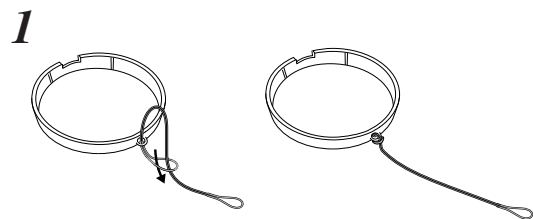

Lamp Replacement

When the life of the projection lamp of this projector draws to an end, the LAMP REPLACE indicator lights yellow. If this indicator lights yellow, replace the lamp with a new one promptly.

This indicator lights yellow when the life of the projection lamp draws to an end.

Top Control

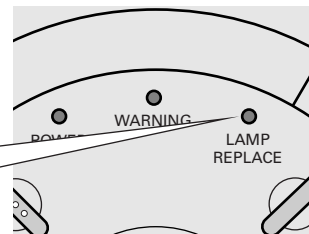

CAUTION

Allow a projector to cool, for at least 45 minutes before you open the Lamp cover. The inside of the projector can become very hot.



CAUTION

For continued safety, replace with a lamp of the same type. Do not drop a lamp or touch a glass bulb! The glass can shatter and may cause injury.

Follow these steps to replace the lamp.

- 1** Turn off the projector and disconnect the AC plug. Allow the projector to cool for at least 45 minutes.
- 2** Loosen the screw with a screwdriver, and remove the lamp cover.
- 3** Loosen 2 screws of the lamp with a screwdriver and pull out the lamp by grasping the handle.
- 4** Replace the lamp with a new one and tighten the 2 screws back into position. Make sure that the lamp is set properly. Replace the lamp cover and tighten the screw.
- 5** Connect the AC power cord to the projector and turn on the projector.
- 6** Reset the Lamp replace counter. See "Lamp Replace Counter" on the next page .

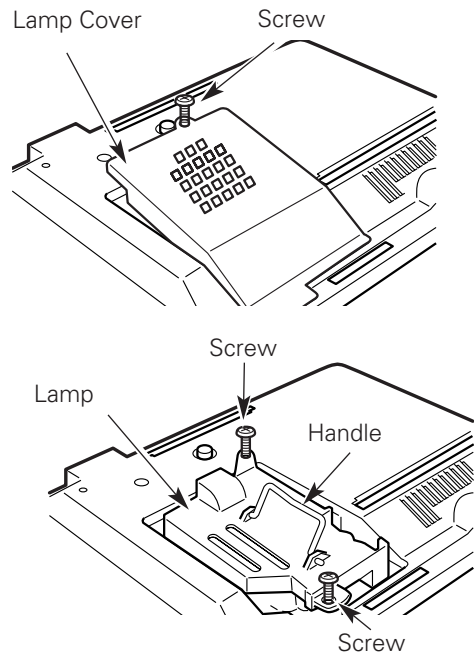

ORDER REPLACEMENT LAMP

Replacement lamp can be ordered through your dealer. When ordering a projection lamp, give the following information to the dealer.

- **Model No. of your projector** : **PLC-SW35**
- **Replacement Lamp Type No.** : **POA-LMP91**
(Service Parts No.610 321 3804)

Lamp Replace Counter

Be sure to reset the lamp replace counter after the lamp is replaced. When the lamp replace counter is reset, the LAMP REPLACE indicator stops lighting.

- 1 Turn the projector on, press the MENU button and the On-Screen Menu will appear. Press the Point ◀▶ button to move the red frame pointer to the Setting Menu icon.
- 2 Press the Point ▼ button to move the red frame pointer to the Lamp counter reset item and then press the SELECT button. The message "Lamp replace counter reset?" is displayed. Move the pointer to [Yes] and then press the SELECT button.
- 3 Another confirmation dialog box appears and select [Yes] to reset the Lamp replace counter.

✓ **Note:**

- Do not reset the Lamp replace counter without implementation of lamp replacement. Be sure to reset the Lamp replace counter only after replacing the lamp.

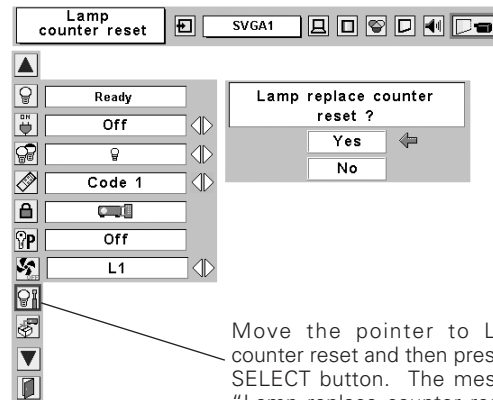

Move the pointer to Lamp counter reset and then press the SELECT button. The message "Lamp replace counter reset?" is displayed.



LAMP HANDLING PRECAUTIONS

This projector uses a high-pressure lamp which must be handled carefully and properly. Improper handling may result in accidents, injury, or create a fire hazard.

- Lamp life may differ from lamp to lamp and according to the environment of use. There is no guarantee of the same life for each lamp. Some lamps may fail or terminate their life in a shorter period of time than other similar lamps.
- If the projector indicates that the lamp should be replaced, i.e., if the LAMP REPLACE indicator lights up, replace the lamp with a new one IMMEDIATELY after the projector has cooled down. (Follow carefully the instructions in the Lamp Replacement section of this manual.) Continuous use of the lamp with the LAMP REPLACE indicator lighted may increase the risk of lamp explosion.
- A Lamp may explode as a result of vibration, shock or degradation as a result of hours of use as its lifetime draws to an end. Risk of explosion may differ according to the environment or conditions in which the projector and lamp are being used.

IF A LAMP EXPLODES, THE FOLLOWING SAFETY PRECAUTIONS SHOULD BE TAKEN.

If a lamp explodes, disconnect the projector's AC plug from the AC outlet immediately. Contact an authorized service station for a checkup of the unit and replacement of the lamp. Additionally, check carefully to ensure that there are no broken shards or pieces of glass around the projector or coming out from the cooling air circulation holes. Any broken shards found should be cleaned up carefully. No one should check the inside of the projector except those who are authorized trained technicians and who are familiar with projector service. Inappropriate attempts to service the unit by anyone, especially those who are not appropriately trained to do so, may result in an accident or injury caused by pieces of broken glass.

Troubleshooting

Before calling your dealer or service center for assistance, check the items below once again.

- Make sure you have properly connected the projector to peripheral equipment as described in "Connecting to a Computer" and "Connecting to Video Equipment" on page 15, 16.
- Make sure all equipment is connected to AC outlet and the power is turned on.
- When you operate the projector with a computer and it does not project an image, restart the computer.

Problem:

– Solutions

No power

- Plug the power cord of the projector into the AC outlet.
 - See if the POWER indicator lights red.
 - Wait 90-120 seconds after the projector is turned OFF when turning the projector back on. The projector can be turned on after the POWER indicator turns red. (See "Turning Off the Projector" on page 18.)
 - Check the WARNING indicator. If the WARNING indicator lights red, the projector cannot be turned on. (See "Warning Indicator" on page 45.)
 - Check the projection lamp. (See page 48.)
 - Unlock Key lock for the projector in the Setting Menu. (See page 42.)
-

Image is out of focus.

- Adjust focus of the projector. (See page 19.)
 - Provide proper distance between the projector and the projection screen. (See page 13.)
 - Check the projection lens to see if it needs cleaning. (See page 47.)
 - Moving the projector from a cool to a warm place may result in moisture condensation on the projection lens. In such cases, leave the projector OFF and wait until condensation disappears.
-

No image

- Check the connection between your computer or video equipment and the projector. (See page 15, 16)
 - See if the input signal is correctly output from your computer. Some laptop computers may need to change the setting for monitor output when connecting to a projector. See your computer's instruction manual for the setting.
 - It takes about 20 seconds to display an image after turning on the projector.
 - See if the selected system is corresponding with your computer or video equipment. (See page 25 and 33)
 - Select correct input source once again through menu operation. (See page 24, 32)
 - Make sure the temperature is not out of the specified Operating Temperature (5°C ~ 35°C).
-

**Image is Left/Right reversed.
Image is Top/Bottom reversed.**

- Check the Ceiling / Rear item. (See "Setting" on page 40.)
 - Check the Ceiling item. (See "Setting" on page 40.)
-

No sound

- Check audio cable connection from audio input source.
 - Adjust the audio source.
 - Press the Volume (+) button. (See page 23.)
 - Press the Mute button. (See page 23.)
-

Some displays are not seen during the Operation.

- Check the Display item. (See “Setting” on page 38.)

PIN code dialog box appears at start-up.

- PIN code lock is being set. Input a PIN code (1234 or numbers you have set). (See “PIN code lock” on page 17 and 43.)

The Remote Control does not work.

- Check the batteries.
- Make sure no obstruction is between the projector and remote control.
- Make sure you are not too far from the projector when using the remote control. Maximum operating range is 16.4' (5m).
- Make sure the code of the remote control is conformed to the projector. (See page 42.)
- Unlock Key lock for the remote control in the Setting Menu. (See page 42.)

WARNING :

High voltages are used to operate this projector. Do not attempt to open the cabinet.

If problems still persist after following all operating instructions, contact the dealer where you purchased the projector or the service center. Give the model number and explain about the problem. We will advise you how to obtain service.



The CE Mark is a Directive conformity mark of the European Community (EC).



This symbol on the nameplate means the product is Listed by Underwriters Laboratories Inc. It is designed and manufactured to meet rigid U.L. safety standards against risk of fire, casualty and electrical hazards.



Pixelworks ICs used.

Menu Tree

Computer Input / Video Input

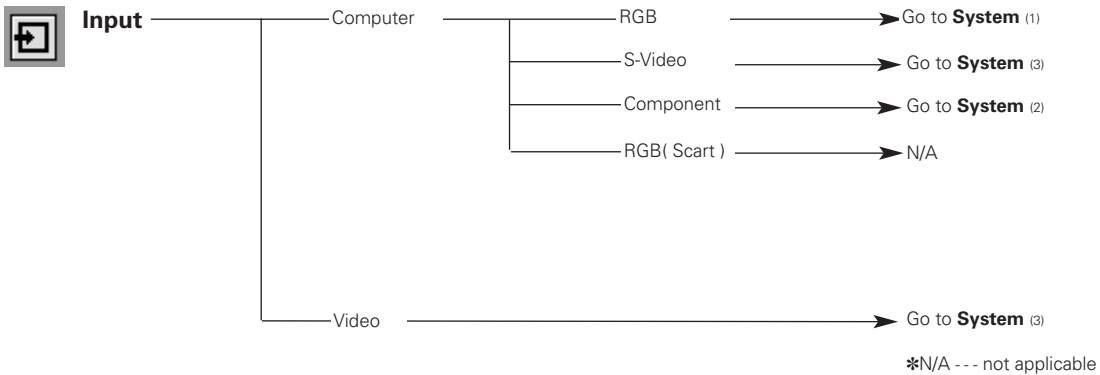

Sound

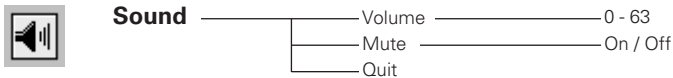

Computer Input

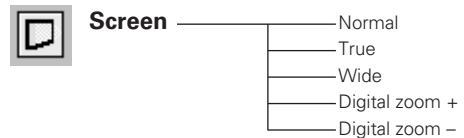
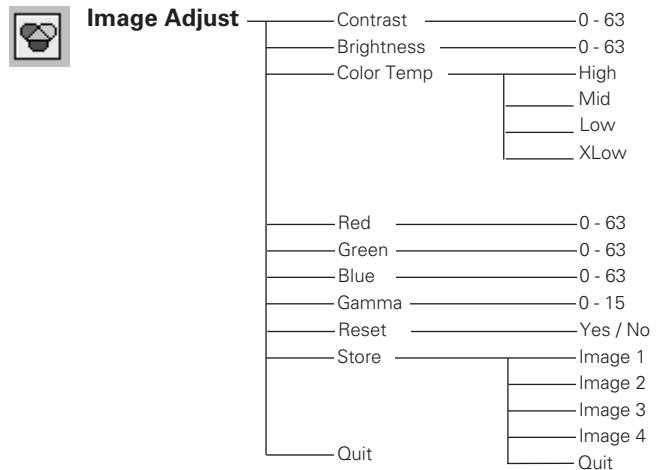
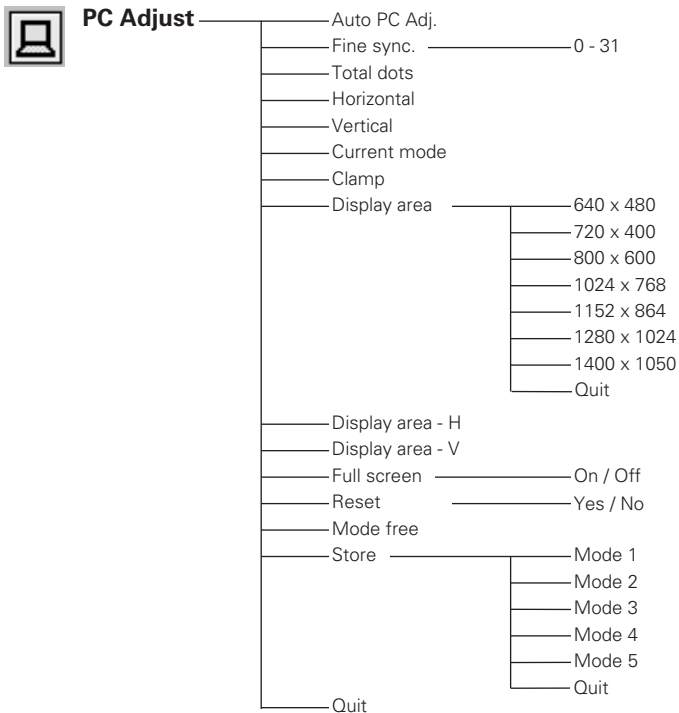
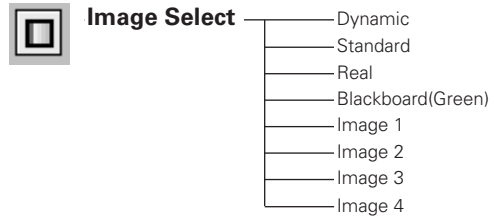
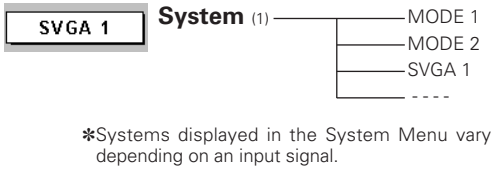

Video Input

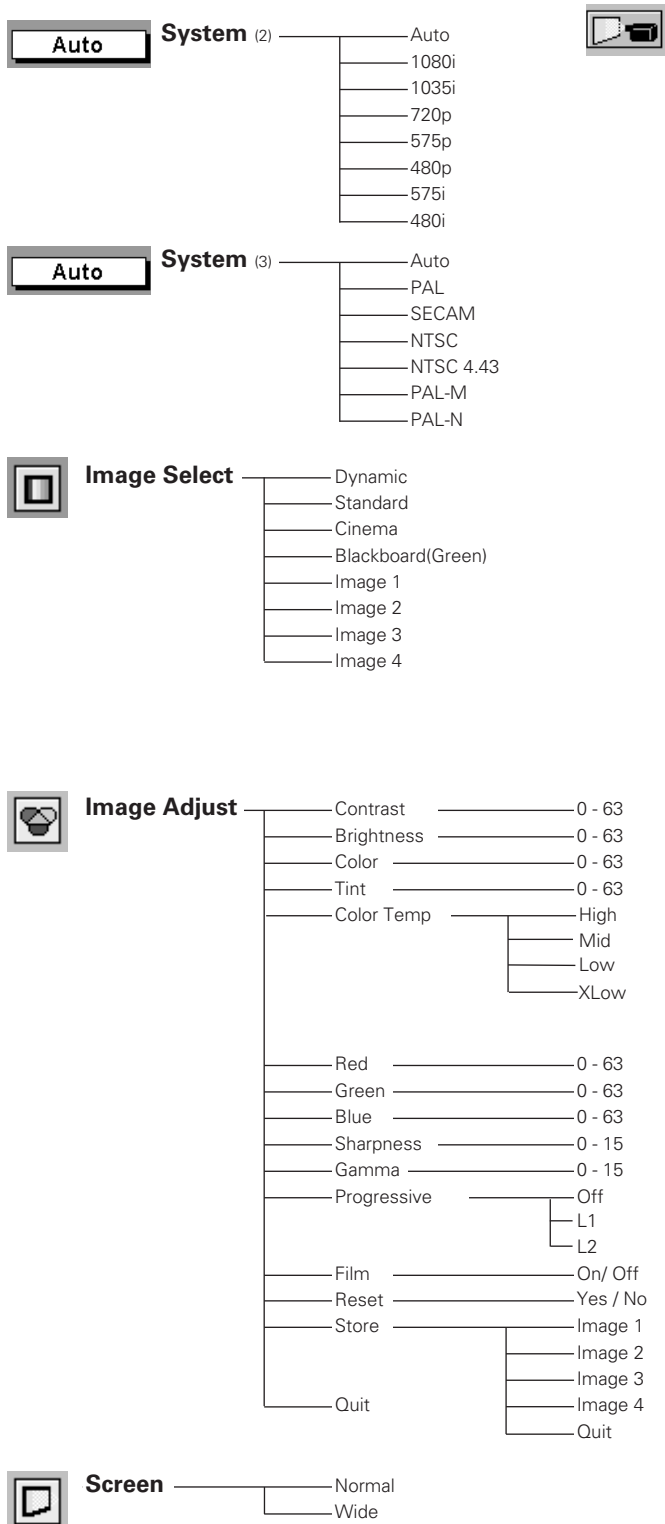

Setting

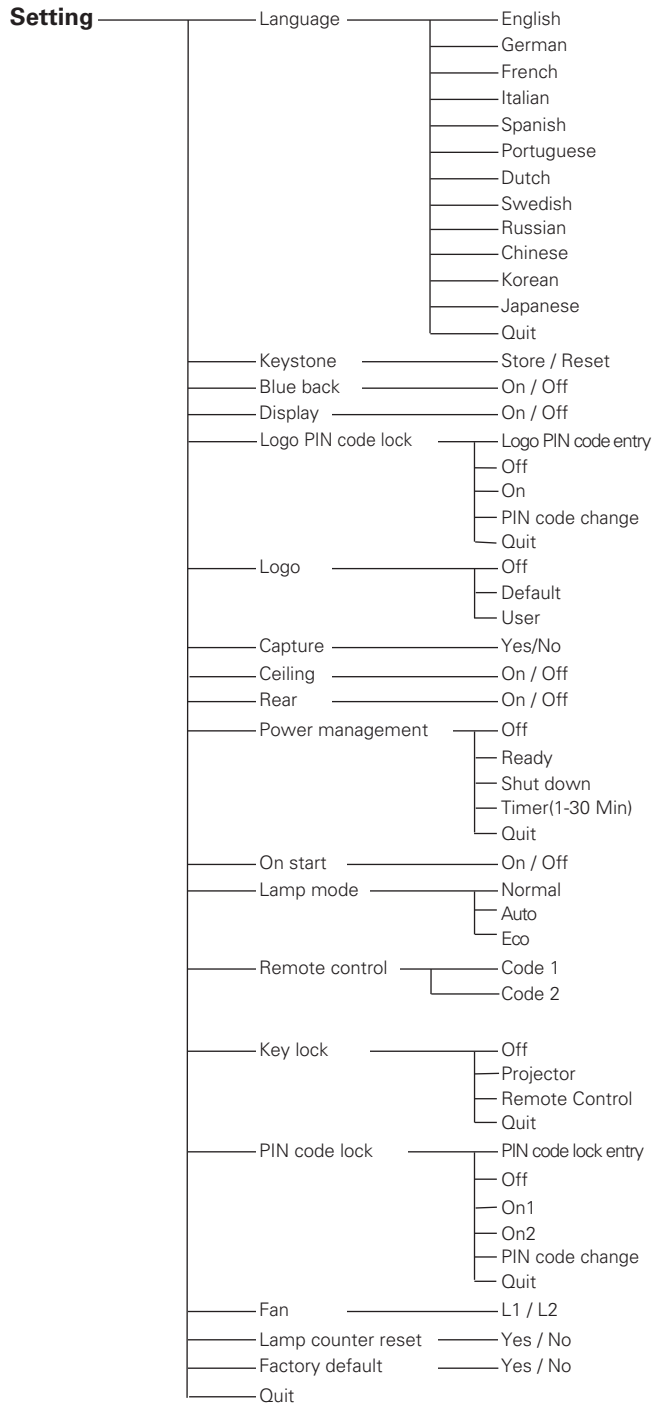

Indicators and Projector Condition

Check the indicators for projector condition.

Indicators			Projector Condition
POWER red/green	WARNING red	LAMP REPLACE yellow	
●	●	●	The projector is OFF. (The AC power cord is unplugged.)
⦿	●	*	The projector is preparing for stand-by or the projection lamp is being cooled down. The projector cannot be turned on until cooling is completed.
⦿	●	*	The projector is ready to be turned on with the POWER ON-OFF button.
○	●	*	The projector is operating normally.
⦿	●	*	The projector is in the Power management mode.
⦿	⦿	*	The temperature inside the projector is abnormally high. The projector cannot be turned on. When the projector is cooled down enough and the temperature returns to normal, the POWER indicator lights red and the projector can be turned on. (The WARNING indicator keeps blinking.) Check and clean the Air filter.
⦿	⦿	*	The projector has been cooled down enough and the temperature returns to normal. When turning on the projector, the WARNING indicator stops blinking. Check and clean the air filters.
●	⦿	*	The projector detects an abnormal condition and cannot be turned on. Unplug the AC power cord and plug it again to turn on the projector. If the projector is turned off again, disconnect the AC power cord and contact the dealer or the service center for service and checkup. Do not leave the projector on. It may cause electric shock or a fire hazard.

○ ●●● lights green.

⦿ ●●● blinks green.

⦿ ●●● lights red.

⦿ ●●● blinks red.

● ●●● off

* When the life of the projection lamp draws to an end, the LAMP REPLACE indicator lights yellow. When this indicator lights yellow, replace the projection lamp with a new one promptly. Reset the Lamp replace counter after replacement of the lamp. See page 48 and 49.

Compatible Computer Specifications

Basically this projector can accept the signal from all computers with the V, H-Frequency below mentioned and less than 100 MHz of Dot Clock.

ON-SCREEN DISPLAY	RESOLUTION	H-Freq. (kHz)	V-Freq. (Hz)	ON-SCREEN DISPLAY	RESOLUTION	H-Freq. (kHz)	V-Freq. (Hz)
VGA 1	640 x 480	31.47	59.88	XGA 2	1024 x 768	68.677	84.997
VGA 2	720 x 400	31.47	70.09	XGA 3	1024 x 768	60.023	75.03
VGA 3	640 x 400	31.47	70.09	XGA 4	1024 x 768	56.476	70.07
VGA 4	640 x 480	37.86	74.38	XGA 5	1024 x 768	60.31	74.92
VGA 5	640 x 480	37.86	72.81	XGA 6	1024 x 768	48.50	60.02
VGA 6	640 x 480	37.50	75.00	XGA 7	1024 x 768	44.00	54.58
VGA 7	640 x 480	43.269	85.00	XGA 8	1024 x 768	63.48	79.35
MAC LC13	640 x 480	34.97	66.60	XGA 9	1024 x 768	36.00	^{87.17} (Interlace)
MAC 13	640 x 480	35.00	66.67	XGA 10	1024 x 768	62.04	77.07
480p	————	31.47	59.88	XGA 11	1024 x 768	61.00	75.70
575p	————	31.25	50.00	XGA 12	1024 x 768	35.522	^{86.96} (Interlace)
480i	————	15.734	⁶⁰ (Interlace)	XGA 13	1024 x 768	46.90	58.20
575i	————	15.625	⁵⁰ (Interlace)	XGA 14	1024 x 768	47.00	58.30
SVGA 1	800 x 600	35.156	56.25	XGA 15	1024 x 768	58.03	72.00
SVGA 2	800 x 600	37.88	60.32	MAC 19	1024 x 768	60.24	75.08
SVGA 3	800 x 600	46.875	75.00	MAC 21	1152 x 870	68.68	75.06
SVGA 4	800 x 600	53.674	85.06	SXGA 1	1152 x 864	64.20	70.40
SVGA 5	800 x 600	48.08	72.19	SXGA 11	1152 x 900	61.20	65.20
SVGA 6	800 x 600	37.90	61.03	SXGA 13	1280 x 1024	50.00	^{86.00} (Interlace)
SVGA 7	800 x 600	34.50	55.38	SXGA 14	1280 x 1024	50.00	^{94.00} (Interlace)
SVGA 8	800 x 600	38.00	60.51	SXGA 17	1152 x 900	61.85	66.00
SVGA 9	800 x 600	38.60	60.31	SXGA 18	1280 x 1024	46.43	^{86.70} (Interlace)
SVGA 10	800 x 600	32.70	51.09	720p (HDTV)	————	45.00	60.00
SVGA 11	800 x 600	38.00	60.51	1035i (HDTV)	————	33.75	^{60.00} (Interlace)
MAC 16	832 x 624	49.72	74.55	1080i (HDTV)	————	33.75	^{60.00} (Interlace)
XGA 1	1024 x 768	48.36	60.00	1080i (HDTV)	————	28.125	^{50.00} (Interlace)

Technical Specifications

Mechanical Information

Projector Type	Multi-media Projector
Dimensions (W x H x D)	10.63" x 3.07" x 7.48" (270mm x 78mm x 190mm) (not including Adjustable Feet)
Net Weight	4.8lbs (2.2 kg)
Feet Adjustment	0° to 8,0°

Panel Resolution

LCD Panel System	0.5" TFT Active Matrix type, 3 panels
Panel Resolution	800 x 600 dots
Number of Pixels	1,440,000 (800 x 600 x 3 panels)

Signal Compatibility

Color System	PAL, SECAM, NTSC, NTSC4.43, PAL-M, PAL-N
High Definition TV Signal	480i, 480p, 575i, 575p, 720p, 1035i, and 1080i
Scanning Frequency	H-sync. 15 ~ 80 KHz, V-sync. 50 ~ 100 Hz

Optical Information

Projection Image Size (Diagonal)	Adjustable from 34" to 200"
Projection Lens	F 1.6 ~ 1.8 lens with f 18.3 mm ~ 21.9 mm with manual zoom and focus
Throw Distance	4.3' ~ 21.2' (1.3m ~ 6.5m)
Projection Lamp	160W

Interface

Video Input Jack	RCA Type x 1
Audio Input Jack	Mini Jack (Stereo) x 1
Monitor Out Terminal	Analog RGB (Mini D-sub 15 pin)
Computer / S-Video / Component Input Terminal	Analog RGB (Mini D-sub 15 pin)
Service Port Connector	Mini DIN 8 pin x 1
Audio Output Jack	Mini Jack (stereo) x 1 (Variable)

Audio

Internal Audio Amp	0.8 W RMS
Built-in Speaker	1 speaker, ø1.3" (32mm)

Power

Voltage and Power Consumption	AC 100 ~ 120 V (3.6 A Max. Ampere), 50 / 60 Hz (The U.S.A and Canada) AC 200 ~ 240 V (1.8 A Max. Ampere), 50 / 60 Hz (Continental Europe and The U.K.)
-------------------------------	---

Operating Environment

Operating Temperature	41 °F ~ 95 °F (5 °C ~ 35 °C)
Storage Temperature	14 °F ~ 140 °F (-10°C ~ 60 °C)

Remote Control

Battery	AAA, SUM-04 or R03 type x 2
Operating Range	16.4' (5m) / ±30°
Dimensions	2.0" (W) x 0.91" (H) x 4.8" (D) (51.5mm x 23.2mm x 123mm)
Net Weight	2.11 oz (60 g) (including batteries)

Accessories

Owner's Manual
 AC Power Cord
 Remote Control and Batteries
 VGA Cable
 Lens Cover with String
 Soft Carrying Bag
 PIN Code Label

- The specifications are subject to change without notice.
- LCD panels are manufactured to the highest possible standards. Even though 99.99% of the pixels are effective, a tiny fraction of the pixels (0.01% or less) may be ineffective by the characteristics of the LCD panels.
- The On-Screen Menu and figures in this manual may differ slightly from the product.

Optional Parts

The parts listed below are optionally available. When ordering those parts, give the item name and Model No. to the sales dealer.

	<i>Model No.</i>
COMPONENT-VGA Cable	<i>: POA-CA-COMPVGA</i>
SCART-VGA Cable	<i>: POA-CA-SCART</i>
S-Video-VGA Cable	<i>: POA-CA-VGAS</i>
MAC Adapter	<i>: POA-MACAP</i>
Presentation Kit	<i>: POA-RCKIT02</i>

Configurations of Terminals

COMPUTER INPUT/S-VIDEO INPUT/COMPONENT INPUT/MONITOR OUTPUT TERMINAL (ANALOG)

Terminal : HDB15-PIN

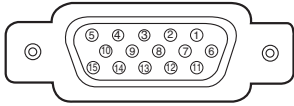

1	Red (R/Cr) Input / Output	9	----
2	Green (G/Y) Input / Output	10	Ground (Vert.sync.)
3	Blue (B/Cb) Input / Output	11	Ground / ----
4	----	12	----
5	Ground (Horiz.sync.)	13	Horiz. sync. Input/Output (Composite H/V sync.)
6	Ground (Red)	14	Vert. sync.
7	Ground (Green)	15	----
8	Ground (Blue)		

SERVICE PORT CONNECTOR

Terminal : Mini DIN 8-PIN

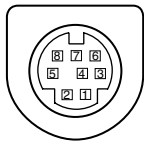

	Serial
1	R X D
2	----
3	----
4	GND
5	RTS / CTS
6	T X D
7	GND
8	GND

PIN Code Number Memo

Write down the PIN code number in the column below and keep it with this manual securely. If you forgot or lost the number and unable to operate the projector, contact the service station.

PIN Code Lock No.

--	--	--	--

Factory default set No: 1 2 3 4*

Logo PIN Code Lock No.

--	--	--	--

Factory default set No: 4 3 2 1*

*Should the four-digit number be changed, the factory set number will be invalid.

While the projector is locked with the PIN code...

Put the label below (supplied) on in a prominent place of the projector's body while it is locked with a PIN code.

