

***myprojectorlamps.com***

**The most trusted, dependable name  
in projector lamp sales.**



<http://www.myprojectorlamps.com>



<http://www.myprojectorlamps.ca>



<http://www.myprojectorlamps.eu>

The following projector manual has not been modified or altered in any way.

Multimedia Projector

## Quick Reference Guide

MODEL PDG-DWL100

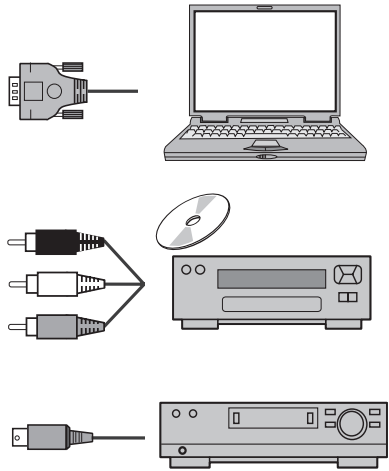
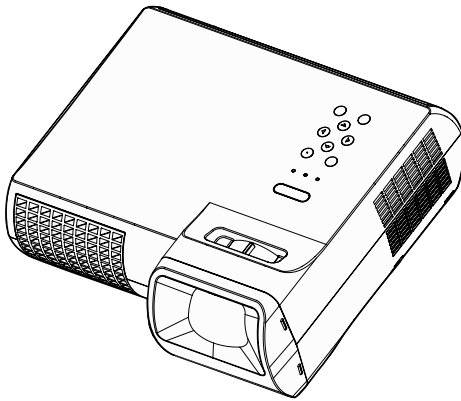

English

Français

Español

Deutsch

Italiano

Português

Use this book as a reference guide when setting up the projector. For detailed information about installation, setup, and operation of the projector, refer to the owner's manual on the CD-ROM.



**READ THE SAFETY INSTRUCTIONS IN THE OWNER'S MANUAL (CD-ROM) BEFORE USING THE PROJECTOR.**

The manual is provided in the Adobe Portable Document Format (PDF). To read the PDF file, you need the Adobe Reader (Acrobat Reader) Version 6.0 or later software in your computer. The Adobe Reader can be obtained from the Adobe website.

Before installing and operating the projector, read this manual thoroughly.

This projector provides many convenient features and functions. Operating the projector properly enables you to manage those features and maintains it in better condition for many years to come.

Improper operation may result in not only shortening the product life, but also malfunctions, fire hazard, or other accidents.

|                                                                                                                                                                                         |                                                                                                                      |
|-----------------------------------------------------------------------------------------------------------------------------------------------------------------------------------------|----------------------------------------------------------------------------------------------------------------------|
| <b>CAUTION</b>                                                                                                                                                                          |                                                                                                                      |
| <b>RISK OF ELECTRIC SHOCK<br/>DO NOT OPEN</b>                                                                                                                                           |                                                                                                                      |
| CAUTION: TO REDUCE THE RISK OF ELECTRIC SHOCK, DO NOT REMOVE COVER (OR BACK). NO USER-SERVICEABLE PARTS INSIDE EXCEPT LAMP REPLACEMENT. REFER SERVICING TO QUALIFIED SERVICE PERSONNEL. |                                                                                                                      |
|                                                                                                         | THIS SYMBOL INDICATES THAT DANGEROUS VOLTAGE CONSTITUTING A RISK OF ELECTRIC SHOCK IS PRESENT WITHIN THIS UNIT.      |
|                                                                                                         | THIS SYMBOL INDICATES THAT THERE ARE IMPORTANT OPERATING AND MAINTENANCE INSTRUCTIONS IN THIS MANUAL WITH THIS UNIT. |

**Federal Communications Commission Notice**

This equipment has been tested and found to comply with the limits for a Class B digital device, pursuant to Part 15 of the FCC Rules. These limits are designed to provide reasonable protection against harmful interference in a residential installation. This equipment generates, uses, and can radiate radio frequency energy. If it is not installed and used in accordance with the instructions, it may cause harmful interference to radio communications. However, there is no guarantee that interference will not occur in a particular installation. If this equipment does cause harmful interference to radio or television reception, which can be determined by turning the equipment off and on, the user is encouraged to try to correct the interference by one or more of the following measures:

- Reorient or relocate the receiving antenna.
- Increase the separation between the equipment and receiver.
- Connect the equipment into an outlet on a circuit different from that to which the receiver is connected.
- Consult the dealer or an experienced radio/TV technician for help.

 **Safety Precaution**

- This apparatus must be earthed.
- To reduce the risk of fire or electric shock, do not expose this apparatus to rain or moisture.
- This projector produces intense light from the projection lens. Do not stare directly into the lens, otherwise eye damage could result. Be especially careful that children do not stare directly into the beam.
- Do not set the projector in greasy, wet, or smoky conditions such as in a kitchen to prevent a breakdown or a disaster. If the projector comes in contact with oil or chemicals, it may become deteriorated.
- Install the projector in a proper position. Improper positioning may reduce the lamp life and result in severe accident or fire hazard.
- If the projector is unused for an extended time, unplug the projector from the power outlet.
- Care must be taken when handling the projector; do not drop, bump, subject it to strong forces, or put other things on the cabinet.
- Do not cover the ventilation slots on the projector. Heat build-up can reduce the service life of your projector, and can also be dangerous.
- Allowing the proper amount of space on the top, sides, and rear of the projector cabinet is critical for proper air circulation and cooling of the unit. The diagrams shown here indicates the minimum space required. If the projector is to be built into a compartment or similarly enclosed, these minimum distances must be maintained.

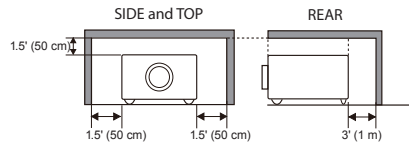

- Avoid positioning the projector as described below when installing.

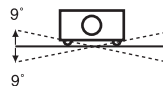

Do not roll the projector more than 9 degrees from side to side.

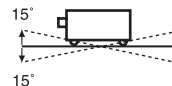

Do not pitch the projector more than 15 degrees from above and below.



Do not point the projector up/down to project an image.



Do not put the projector on either side to project an image.

## Safety Instructions

All the safety and operating instructions should be read before the product is operated.

Read all of the instructions given here and retain them for later use. Unplug this projector from AC power supply before cleaning. Do not use liquid or aerosol cleaners. Use a damp cloth for cleaning.

Follow all warnings and instructions marked on the projector.

For added protection to the projector during a lightning storm, or when it is left unattended and unused for long periods of time, unplug it from the wall outlet. This will prevent damage due to lightning and power line surges.

Do not expose this unit to rain or use near water... for example, in a wet basement, near a swimming pool, etc...

Do not use attachments not recommended by the manufacturer as they may cause hazards.

Do not place this projector on an unstable cart, stand, or table. The projector may fall, causing serious injury to a child or adult, and serious damage to the projector. Use only with a cart or stand recommended by the manufacturer, or sold with the projector. Wall or shelf mounting should follow the manufacturer's instructions, and should use a mounting kit approved by the manufacturers.

An appliance and cart combination should be moved with care. Quick stops, excessive force, and uneven surfaces may cause the appliance and cart combination to overturn.



Slots and openings in the back and bottom of the cabinet are provided for ventilation, to ensure reliable operation of the equipment and to protect it from overheating.

The openings should never be covered with cloth or other materials, and the bottom opening should not be blocked by placing the projector on a bed, sofa, rug, or other similar surface. This projector should never be placed near or over a radiator or heat register.

This projector should not be placed in a built-in installation such as a book case unless proper ventilation is provided.

Never push objects of any kind into this projector through cabinet slots as they may touch dangerous voltage points or short out parts that could result in a fire or electric shock. Never spill liquid of any kind on the projector.

Do not install the projector near the ventilation duct of air-conditioning equipment.

This projector should be operated only from the type of power source indicated on the marking label. If you are not sure of the type of power supplied, consult your authorized dealer or local power company.

Do not overload wall outlets and extension cords as this can result in fire or electric shock. Do not allow anything to rest on the power cord. Do not locate this projector where the cord may be damaged by persons walking on it.

Do not attempt to service this projector yourself as opening or removing covers may expose you to dangerous voltage or other hazards. Refer all servicing to qualified service personnel.

Unplug this projector from wall outlet and refer servicing to qualified service personnel under the following conditions:

- a. When the power cord or plug is damaged or frayed.
- b. If liquid has been spilled into the projector.
- c. If the projector has been exposed to rain or water.
- d. If the projector does not operate normally by following the operating instructions. Adjust only those controls that are covered by the operating instructions as improper adjustment of other controls may result in damage and will often require extensive work by a qualified technician to restore the projector to normal operation.
- e. If the projector has been dropped or the cabinet has been damaged.
- f. When the projector exhibits a distinct change in performance-this indicates a need for service.

When replacement parts are required, be sure the service technician has used replacement parts specified by the manufacturer that have the same characteristics as the original part. Unauthorized substitutions may result in fire, electric shock, or injury to persons.

Upon completion of any service or repairs to this projector, ask the service technician to perform routine safety checks to determine that the projector is in safe operating condition.

Hot air is exhausted from the exhaust vent. When using or installing the projector, the following precautions should be taken.

- Do not put any flammable object or spray can near the projector, hot air is exhausted from the ventilation holes.
- Keep the exhaust vent at least 3' (1 m) away from any objects.
- Do not touch a peripheral part of the exhaust vent, especially screws and metallic part. This area will become hot while the projector is being used.
- Do not put anything on the cabinet. Objects put on the cabinet will not only get damaged but also cause fire hazard by heat.
- Do not cover vents with papers or other materials.
- Make sure that there are no objects under the projector. An object under the projector may prevent the projector from taking cooling air through bottom vent.

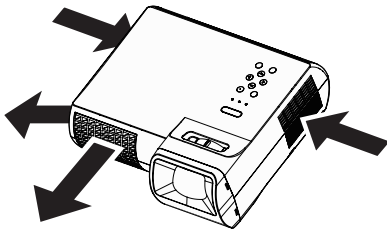

- When carrying the projector, retract the adjustable feet to prevent damage to the lens and cabinet and use a suitable carrying case.
- Do not put the projector in a case before it is cooled enough.
- Do not transport the projector by courier or any other transport service in an unsuitable transport case. This may cause damage to the projector. For information about transporting the projector by courier or any other transport service, consult your dealer.
- When this projector is not in use for an extended period, put it into a suitable case to protect the projector.
- For ceiling mounting, you need the ceiling mount kit designed for this projector. When not mounted properly, the projector may fall, causing hazards or injury. For details, consult your dealer. The warranty on this projector does not cover any damage caused by use of any non-recommended ceiling mount kit or installation of the ceiling mount kit in an improper location.

#### FOR EU USERS

The symbol mark and recycling systems described below apply to EU countries and do not apply to countries in other areas of the world. Your SANYO product is designed and manufactured with high quality materials and components which can be recycled and/or reused. The symbol mark means that electrical and electronic equipment, batteries and accumulators, at their end-of-life, should be disposed of separately from your household waste.

#### Note:

If a chemical symbol is printed beneath the symbol mark, this chemical symbol means that the battery or accumulator contains a heavy metal at a certain concentration. This will be indicated as follows: Hg: mercury, Cd: cadmium, Pb: lead. In the European Union there are separate collection systems for used electrical and electronic equipment, batteries and accumulators. Please, dispose of them correctly at your local community waste collection/recycling centre.

Please, help us to conserve the environment we live in!



#### NOTE FOR CUSTOMERS IN THE US

 LAMP(S) INSIDE THIS PRODUCT CONTAIN MERCURY AND MUST BE RECYCLED OR DISPOSED OF ACCORDING TO LOCAL, STATE OR FEDERAL LAWS.

Not for use in a computer room as defined in the Standard for the Protection of Electronic Computer/ Data Processing Equipment, ANSI/NFPA 75.

#### TÜRK KULLANICILAR İÇİN

Bu ürün, EEE yönetmeliğine uygundur.  
(ELEKTRİKLI VE ELEKTRONİK EŞYALARDA BAZI ZARARLI MADDELERİN KULLANIMININ SINIRLANDIRILMASINA DAİR YÖNETMELİK)

臺灣使用者



廢電池請回收

Authorized Representative and Address:

**SANYO Sales & Marketing Europe GmbH**  
Stahlgruberring 4, D-81829 Munich, Germany

Manufacturer and Address:

**SANYO Electric Co., Ltd.**  
5-5, Keihan-hondori 2-chome, Moriguchi City, Osaka  
570-8677, Japan

# Package Overview

*This projector comes with all the items shown below. Check to make sure your unit is complete. Contact your dealer immediately if anything is missing.*

**Note**

❖ Due to the difference in applications for each country, some regions may have different accessories.

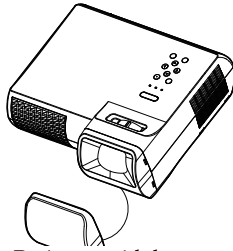

Projector with lens cap



Wireless Remote Control

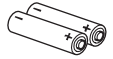

2 x AAA Batteries

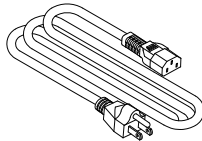

Power Cable

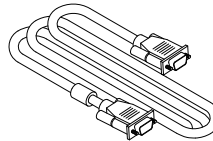

VGA Cable

| Cable                                   | Factory code |
|-----------------------------------------|--------------|
| AC Power Cable (for U.S.A.)             | 42.00105G011 |
| AC Power Cable (for Continental Europe) | 42.00120G011 |
| AC Power Cable (for UK)                 | 42.00110G011 |
| VGA Cable                               | 42.00200G005 |

**Documentation:**

- CD-ROM User's Manual
- Quick Reference Guide

# Product Overview

## Projector

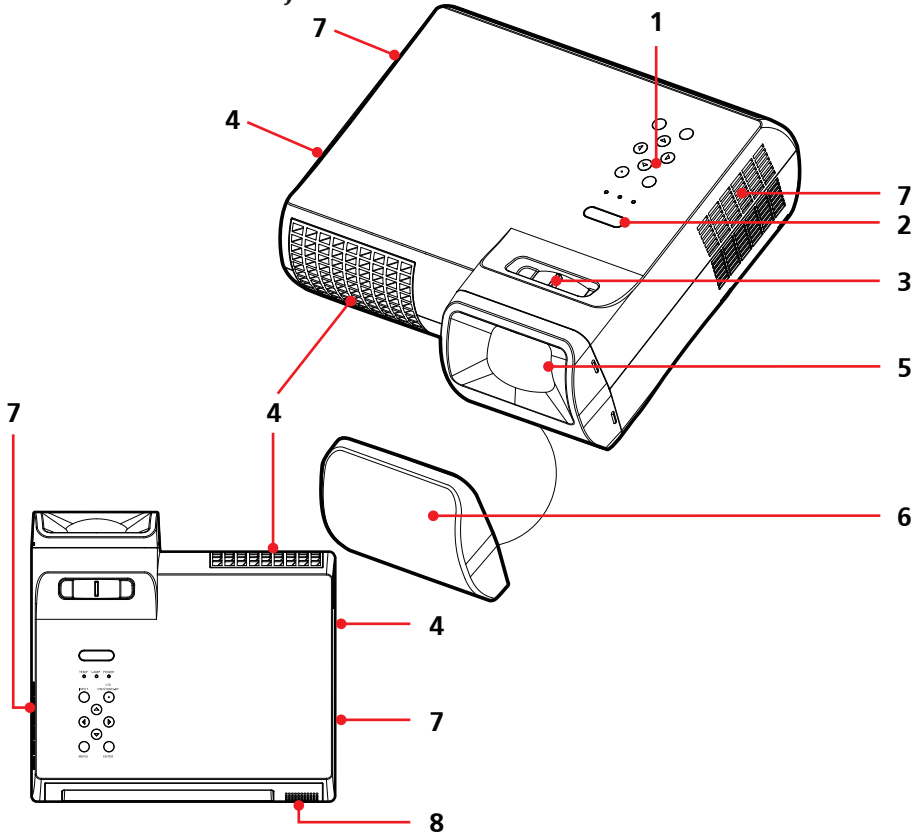

1. Control Panel
2. Remote Sensor
3. Focus Ring
4. Ventilation (outlet)
5. Lens
6. Lens Cap (with String)
7. Ventilation (inlet)
8. Speaker

## Connection Ports

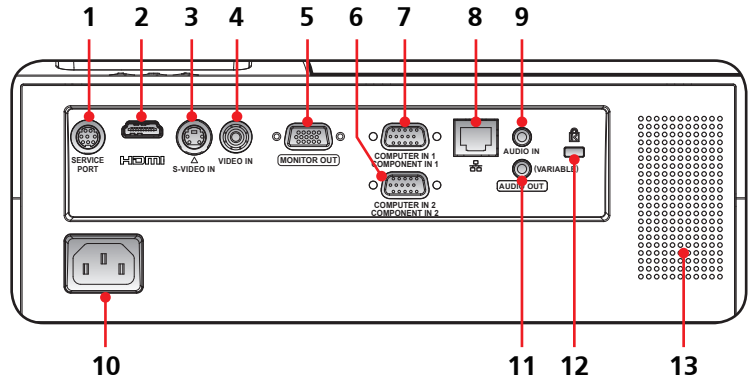

- |                                                                                                                                                                                                                                                |                                                                                                                                                                                                                                                         |
|------------------------------------------------------------------------------------------------------------------------------------------------------------------------------------------------------------------------------------------------|---------------------------------------------------------------------------------------------------------------------------------------------------------------------------------------------------------------------------------------------------------|
| <ol style="list-style-type: none"> <li>1. SERVICE Port</li> <li>2. HDMI Port</li> <li>3. S-VIDEO IN Connector</li> <li>4. VIDEO IN Connector</li> <li>5. MONITOR OUT Connector</li> <li>6. COMPUTER IN 2/<br/>COMPONENT 2 Connector</li> </ol> | <ol style="list-style-type: none"> <li>7. COMPUTER IN 1/<br/>COMPONENT 1 Connector</li> <li>8. Network Port</li> <li>9. AUDIO IN Jack</li> <li>10. AC IN</li> <li>11. AUDIO OUT Jack</li> <li>12. Kensington™ Lock Port</li> <li>13. Speaker</li> </ol> |
|------------------------------------------------------------------------------------------------------------------------------------------------------------------------------------------------------------------------------------------------|---------------------------------------------------------------------------------------------------------------------------------------------------------------------------------------------------------------------------------------------------------|

## Control Panel

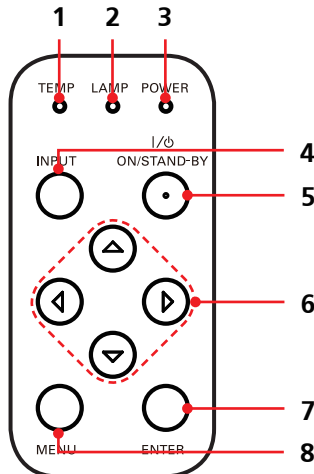

1. TEMP LED
2. LAMP LED
3. POWER LED
4. INPUT Button
5. ON/STAND-BY Button
6. Four Directional Select Keys
7. ENTER Button
8. MENU Button



## Remote Control

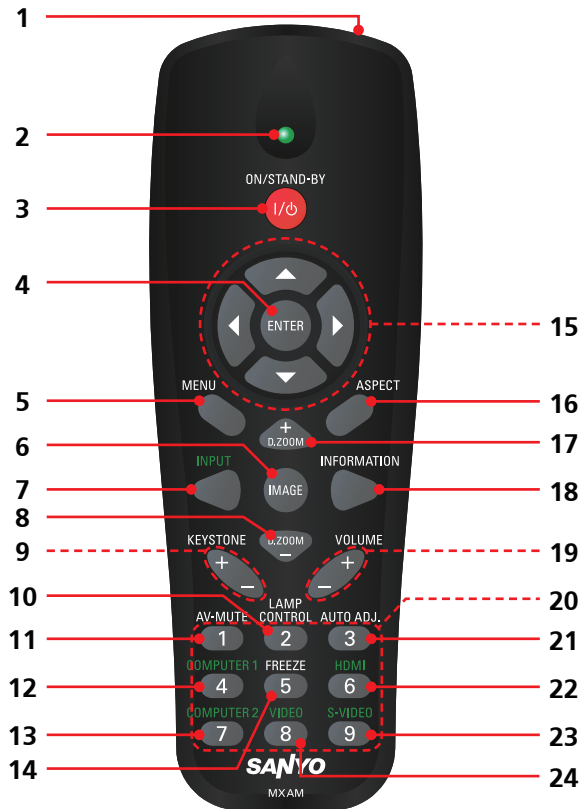
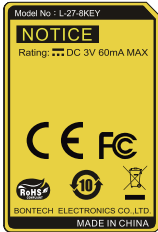

|   |                      |                                                                                                                 |
|---|----------------------|-----------------------------------------------------------------------------------------------------------------|
| 1 | Infrared transmitter | Sends signals to the projector.                                                                                 |
| 2 | Infrared indicator   | Signals indicator for sending.                                                                                  |
| 3 | ON/STAND-BY          | Refer to the "Power On/Off the Projector" section.                                                              |
| 4 | ENTER                | Confirm your section of items in sub menu operation.                                                            |
| 5 | MENU                 | Press "MENU" to launch the Onscreen display (OSD), back to the top level of OSD for the OSD main menu operation |
| 6 | IMAGE                | Select the Image mode from Presentation, Movie, sRGB, Bright and User.                                          |

**Note**

❖ To quick change remote control code, press "MENU" and "IMAGE" buttons about 10 seconds at the same time.

**Note**

The bottom side of OSD menu might be out of display when user adjusts keystone value, under the status of low resolution signal input and different aspect ratio setting. To solve this problem, please adjust keystone value in "Aspect Ratio" of "4:3" then switch back to your desired aspect ratio.

|    |                              |                                                                                                      |
|----|------------------------------|------------------------------------------------------------------------------------------------------|
| 7  | INPUT                        | Press "INPUT" to choose RGB, SCART, Component, S-Video, Composite and HDMI sources.                  |
| 8  | D.ZOOM -                     | Zoom out the projector display.                                                                      |
| 9  | KEYSTONE +/-                 | Adjust the image to compensate for distortion caused by tilting the projector.                       |
| 10 | LAMP CONTROL                 | Select the lamp mode. (refer "ECO Mode" function)                                                    |
| 11 | AV-MUTE                      | Momentarily turn off/on the audio and video.                                                         |
| 12 | COMPUTER 1                   | Press "COMPUTER 1" to choose Computer in 1/Component in 1 connector.                                 |
| 13 | COMPUTER 2                   | Press "COMPUTER 2" to choose Computer in 2/Component in 2 connector.                                 |
| 14 | FREEZE                       | Pause the screen image. Press again to resume the screen image.                                      |
| 15 | Four Directional Select Keys | Use ▲ or ▼ or ◀ or ▶ to select items or make adjustments to your selection.                          |
| 16 | ASPECT                       | Display the "Aspect Ratio" section of the on-screen display menu to select the desired aspect ratio. |
| 17 | D.ZOOM +                     | Zoom in the projector display.                                                                       |
| 18 | INFORMATION                  | Display information menu.                                                                            |
| 19 | VOLUME +/-                   | Increase/decrease speaker volume.                                                                    |
| 20 | Keypad 1~9                   | For input a password in the "Security settings".                                                     |
| 21 | AUTO. ADJ                    | Automatically synchronize the projector to the input source.                                         |
| 22 | HDMI                         | Press "HDMI" to choose HDMI connector.                                                               |
| 23 | S-VIDEO                      | Press "S-VIDEO" to choose S-Video connector.                                                         |
| 24 | VIDEO                        | Press "VIDEO" to choose Video connector.                                                             |

## Remote Control Battery Installation

- 1 Open the battery compartment lid.

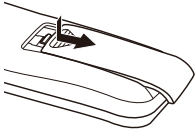

- 2 Install new batteries into the compartment.

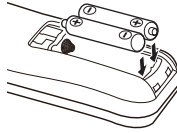

Two AAA size batteries  
For correct polarity (+ and -), be sure battery terminals are in contact with pins in the compartment.

- 3 Replace the compartment lid.

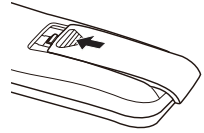

To ensure safe operation, please observe the following precautions :

- Use two (2) AAA type batteries.
- Always replace batteries in sets.
- Do not use a new battery with a used battery.
- Avoid contact with water or liquid.
- Do not expose the remote control to moisture or heat.
- Do not drop the remote control.
- If the battery has leaked on the remote control, carefully wipe the case clean and install new batteries.
- Risk of an explosion if battery is replaced by an incorrect type.
- Dispose of used batteries according to the instructions.
- If the new battery are installed into the compartment within 3~4 hours, the remote control code will not be returned to default.
- The original setting will be kept and will not be erased.

### Note

- ❖ Infrared Remote Receiver is provided on the top of the projector.
- ❖ Point the remote control from obliquely above toward the Infrared Remote Receiver when operating the remote control.

## Remote Control Operating Range

Point the remote control toward the projector (Infrared Remote Receiver) when pressing any button. Maximum operating range for the remote control is about 39.4' (12m) and 60° in top of the projector.

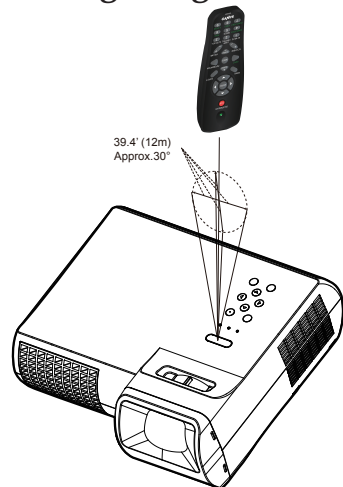

# Connecting the Projector

## Connect to Computer/Notebook

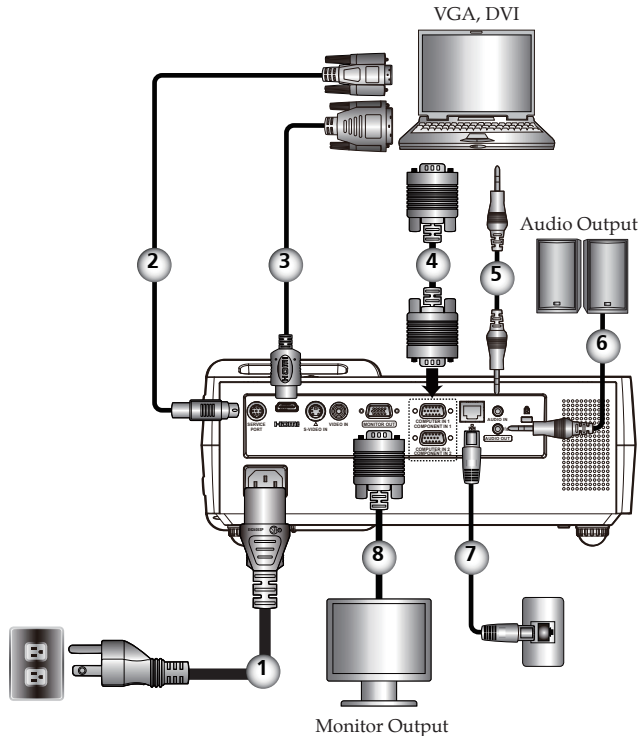

*Note*

- ❖ Make sure that the power plug is fully inserted into both the projector AC inlet and the wall outlet.
- ❖ The AC outlet must be near this equipment and must be easily accessible.

*Note*

- ❖ Due to the difference in applications for each country, some regions may have different accessories.
- ❖ When AUDIO OUTPUT is plugged-in, the projector's build-in speaker is not available.

|        |                              |
|--------|------------------------------|
| 1..... | Power cable (supplied)       |
| 2..... | RS232 cable                  |
| 3..... | HDMI-DVI cable               |
| 4..... | VGA cable (supplied)         |
| 5..... | Audio in cable jack to jack  |
| 6..... | Audio out cable jack to jack |
| 7..... | Network cable                |
| 8..... | Monitor out cable            |

- ❖ To ensure the projector works well with your computer, please make sure the timing of the display mode is compatible with your projector.

### Note

- ❖ Make sure that the power plug is fully inserted into both the projector AC inlet and the wall outlet.
- ❖ The AC outlet must be near this equipment and must be easily accessible.
- ❖ Other than the analog RGB signal, COMPUTER IN 1/2-COMPONENT IN 1/2 Connectors can be used to project the incoming Component and RGB Scart signals. (See Page 20 for the Optional Parts.)

### Note

- ❖ Due to the difference in applications for each country, some regions may have different accessories.
- ❖ When AUDIO OUTPUT is plugged-in, the projector's build-in speaker is not available.

## Connect to Video

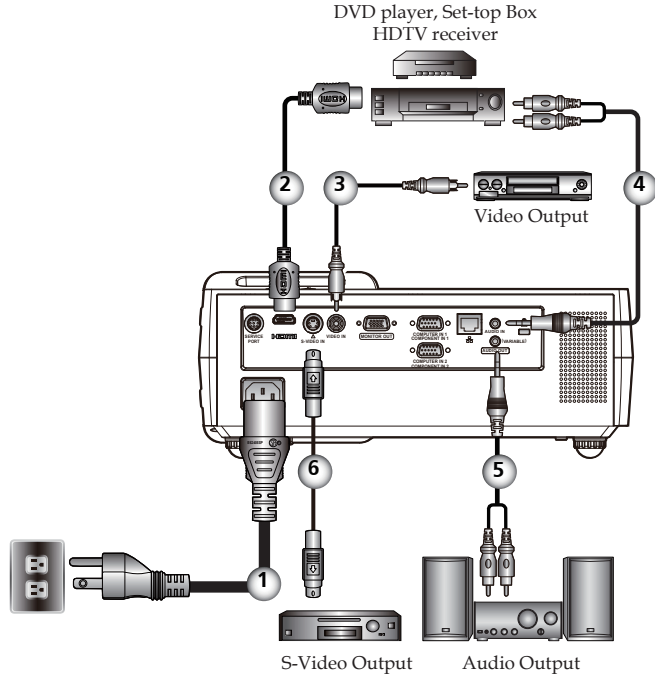

- |        |                              |
|--------|------------------------------|
| 1..... | Power cable (supplied)       |
| 2..... | HDMI cable                   |
| 3..... | Composite video cable        |
| 4..... | Audio in cable jack to jack  |
| 5..... | Audio out cable jack to jack |
| 6..... | S-Video cable                |

- ❖ To ensure the projector works well with your computer, please make sure the timing of the display mode is compatible with your projector.

# Adjusting the Projected Image

## Adjusting the Height of Projector Image

The projector is equipped with adjustable feet to raise and lower the image to fill the screen.

To raise/lower the image:

1. Use ❶ to fine-tune the display angle.

### Note

❖ You can raise the projector front up to 3 degrees by rotating the adjustable feet.

Front Adjustable feet ❶  
Maximum Length: 7mm

Rear Adjustable feet ❶  
Maximum Length: 2mm

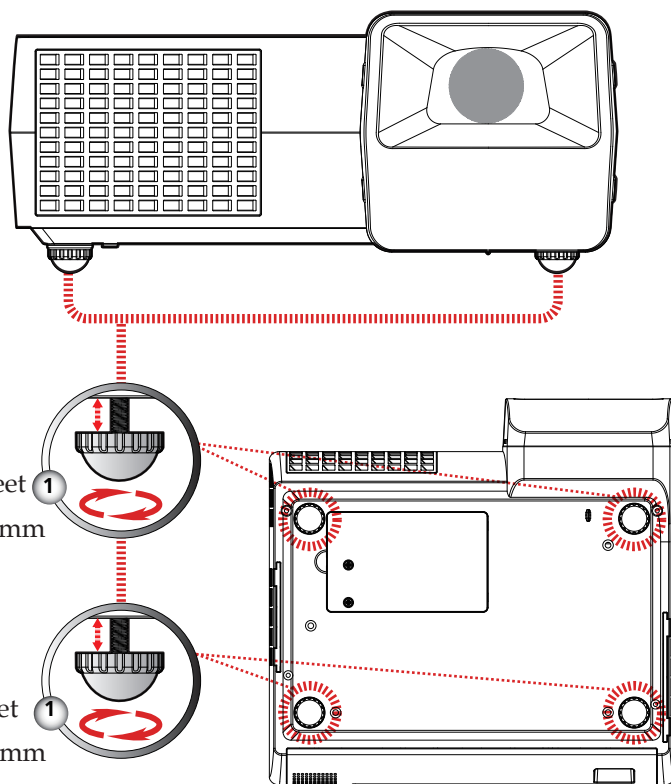

## Adjusting the Projector Focus

To focus the image, rotate the focus ring until the image is clear. The projector will focus at distances from 1.65 to 12.13 feet (0.5 to 3.7 meters) with mechanical travel.

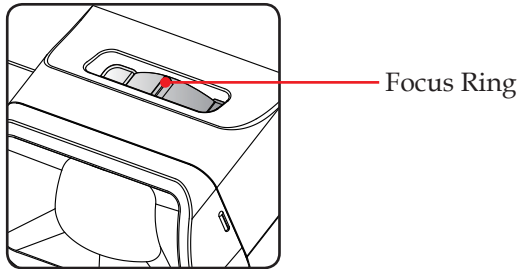

## Adjusting Projection Image Size

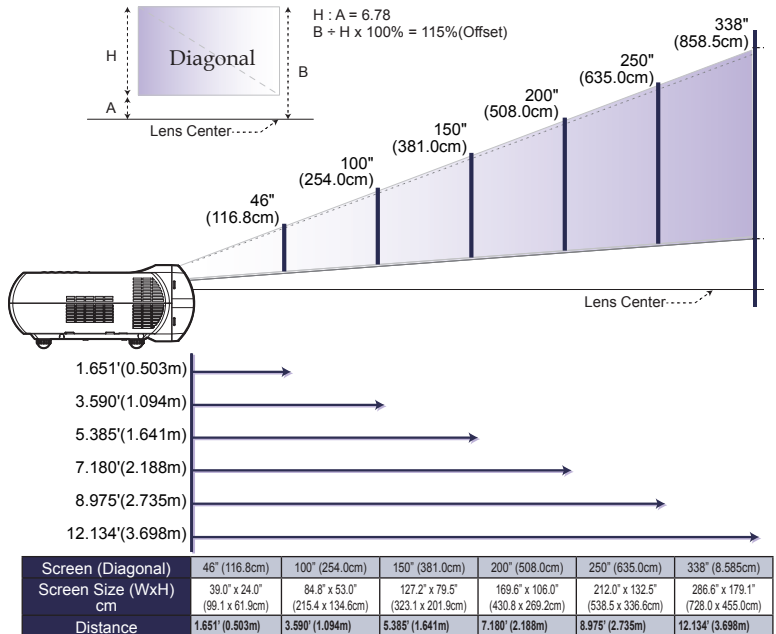

❖ This graph is for user's reference only.

# Powering On/Off the Projector

## Powering On the Projector

1. Ensure that the power cable and signal cable are securely connected. The POWER LED will turn orange.
  2. Remove the lens cap. ❶
  3. Turn on the lamp by pressing "ON/STAND-BY" on the control panel. ❷ The POWER LED will now flash green. The startup screen will display in approximately 5 seconds. When disappear startup screen, the POWER LED will turn green.
  4. Turn on your source (computer, notebook, video player, etc.) The projector will detect your source automatically.
- ❖ If you connect multiple sources at the same time, use the "INPUT" on the remote control or use "COMPUTER 1", "COMPUTER 2", "S-VIDEO", "VIDEO", "HDMI" on the remote control to switch inputs.

### Note

❖ Please adjust external speaker volume to the minimum before turning on the projector.

❖ After the user presses the power button and green LED glitters, it takes a little time for the projector to project the image.

### Note

❖ Turn on the projector first and then the signal sources.

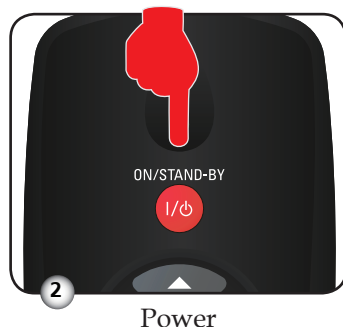
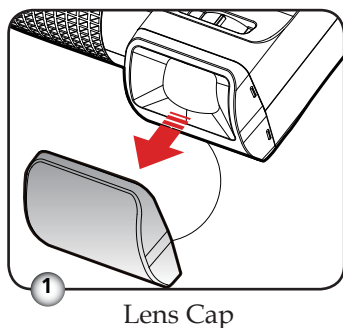



## Powering Off the Projector

1. Press the “ON/STAND-BY” to turn off the projector lamp, you will see a message as below on the on-screen display.

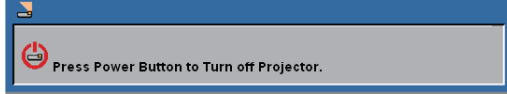

2. Press the “ON/STAND-BY” again to confirm.
3. The cooling fan continues to operate for about 60 seconds for cooling cycle and the POWER LED will flash green. When the light starts flashing orange, the projector has entered standby mode.

If you wish to turn the projector back on, you must wait until the projector has completed the cooling cycle and has entered standby mode. Once in standby mode, simply press “ON/STAND-BY” to restart the projector.

4. Disconnect the power cable from the electrical outlet and the projector.
5. Do not turn on the projector immediately following a power off procedure.

# On Screen Display

The Projector has a multilingual On Screen Display that allows you to make image adjustments and change a variety of settings. The projector will automatically detect the source.

## How to operate

1. To open the OSD, press “MENU” on the Remote Control.
2. When OSD is displayed, use ◀ ▶ keys to select any item in the main menu. While making a selection on a particular page, press ▼ key to enter sub menu.
3. Use ▲ ▼ keys to select the desired item in the sub menu and adjust the settings by ◀ ▶ key.
4. If the setting has ↵ icon, you could press “ENTER” to enter another sub menu. Press “MENU” to close the sub menu after adjustment.
5. After adjusting the settings, press “MENU” go back to the main menu.
6. To exit, press “MENU” again. The OSD will be closed and the projector will automatically save the new settings.

### Note

❖ If no button operation is made for 30 seconds, the OSD will be closed automatically.

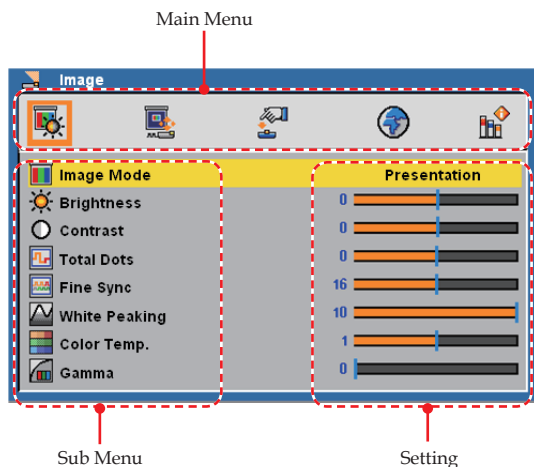

# Replacing the lamp

The projector will detect the lamp life itself. It will show you a warning message



Warning: To avoid burns, allow the projector to cool for at least 45 minutes before you replace the lamp!

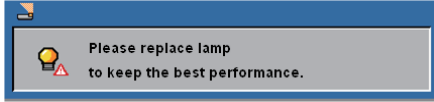

When you see this message, change the lamp as soon as possible. Make sure the projector has been cooled down for at least 45 minutes before changing the lamp.

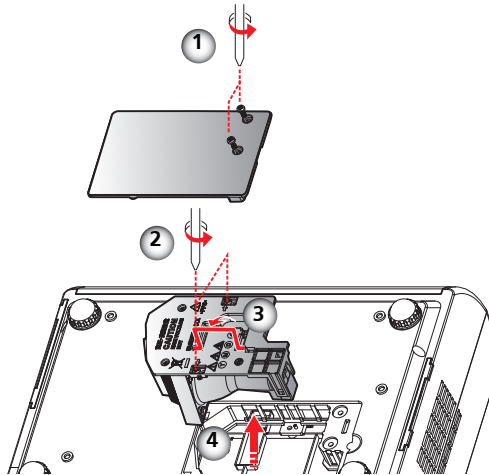

Warning: To reduce the risk of personal injury, do not drop the lamp module or touch the lamp bulb. The bulb may shatter and cause injury if it is dropped.

Warning: For continued safety replace with a lamp of the same type.

## Lamp Replacing Procedure:

1. Switch off the power of the projector by pressing the "ON/STAND-BY".
2. Allow the projector to cool down at least 45 minutes.
3. Disconnect the power cable.
4. Use a screwdriver to remove the 2 screws from the cover. ❶
5. Push up and remove the cover.
6. Remove the 2 screws from the lamp module ❷ and pull up the lamp bar. ❸
7. Pull out the lamp module by force. ❹
8. Install the new lamp module by reversing the previous steps.
9. After replacing the lamp, turn on the power, and select the menu ->[Setting] ->[Lamp Counter Reset] to reset the lamp usage hours.

## ORDER REPLACEMENT LAMP

Replacement lamp can be ordered through your dealer. When ordering a projection lamp, give the following information to the dealer.

- Model No. of your projector : PDG-DWL100
- Replacement Lamp Type No. : POA-LMP138  
(Service Parts No. CHSP8EM01GC01 or 610 346 4633)



## LAMP HANDLING PRECAUTIONS

This projector uses a high-pressure lamp which must be handled carefully and properly.

Improper handling may result in accidents, injury, or create a fire hazard.

- Lamp life may differ from lamp to lamp and according to the environment of use. There is no guarantee of the same life for each lamp. Some lamps may fail or terminate their life in a shorter period of time than other similar lamps.
- If the projector indicates that the lamp should be replaced, i.e., if the lamp life warning message appears, replace the lamp with a new one IMMEDIATELY after the projector has cooled down. (Follow carefully the instructions in the Lamp Replacement section of this manual.) Continuous use of the lamp with showing the lamp life warning message may increase the risk of lamp explosion.
- A Lamp may explode as a result of vibration, shock or degradation as a result of hours of use as its lifetime draws to an end. Risk of explosion may differ according to the environment or conditions in which the projector and lamp are being used.

### IF A LAMP EXPLODES, THE FOLLOWING SAFETY PRECAUTIONS SHOULD BE TAKEN.

If a lamp explodes, disconnect the projector's AC plug from the AC outlet immediately. Contact an authorized service station for a checkup of the unit and replacement of the lamp. Additionally, check carefully to ensure that there are no broken shards or pieces of glass around the projector or coming out from the cooling air circulation holes. Any broken shards found should be cleaned up carefully. No one should check the inside of the projector except those who are authorized trained technicians and who are familiar with projector service. Inappropriate attempts to service the unit by anyone, especially those who are not appropriately trained to do so, may result in an accident or injury caused by pieces of broken glass.

# Specifications

|                                |                                                                                                                                                                                                                                                                                                                                                                                                                                                                                                   |
|--------------------------------|---------------------------------------------------------------------------------------------------------------------------------------------------------------------------------------------------------------------------------------------------------------------------------------------------------------------------------------------------------------------------------------------------------------------------------------------------------------------------------------------------|
| Projection System              | Single Chip DLP® Technology by Texas Instruments                                                                                                                                                                                                                                                                                                                                                                                                                                                  |
| Number of Pixels               | WXGA: 1280 pixels(H) X 800 lines(V), up to UXGA (1600 X 1200) with scaling technology                                                                                                                                                                                                                                                                                                                                                                                                             |
| Lamp                           | 225W (170W on ECO mode)                                                                                                                                                                                                                                                                                                                                                                                                                                                                           |
| Projection Lens                | F#2.6 f=7.198mm with manual focus                                                                                                                                                                                                                                                                                                                                                                                                                                                                 |
| Projection Screen Size (Diag.) | 46 to 338 inches (1.16 to 8.59 meters) Diagonal                                                                                                                                                                                                                                                                                                                                                                                                                                                   |
| Projection Distance            | 1.65 to 12.13 feet (0.5 to 3.7 meters)                                                                                                                                                                                                                                                                                                                                                                                                                                                            |
| Video Compatibility            | - NTSC-M/NTSC-4.43/PAL-B, D, G, H, I/PAL-M/PAL-N/SECAM<br>- Component: SDTV(480i/576i), EDTV(480p, 576p), HDTV(720p, 1080i/p)                                                                                                                                                                                                                                                                                                                                                                     |
| H. Frequency                   | 31.35kHz~79.98kHz horizontal scan                                                                                                                                                                                                                                                                                                                                                                                                                                                                 |
| V. Frequency                   | 50Hz~75Hz vertical refresh                                                                                                                                                                                                                                                                                                                                                                                                                                                                        |
| Power Supply                   | Universal AC input 100-240V ; Input Frequency 50-60Hz                                                                                                                                                                                                                                                                                                                                                                                                                                             |
| Power Consumption              | Normal mode:320W<br>Standby mode <1 Watt                                                                                                                                                                                                                                                                                                                                                                                                                                                          |
| Input Current                  | 2.5-1.0A (100-240V AC)                                                                                                                                                                                                                                                                                                                                                                                                                                                                            |
| I/O Connectors                 | - Power: AC power input socket<br>- Computer Input: 2x 15-pin D-Sub VGA for analog/component and HDTV signal<br>- RS232 Input: 1x Mini DIN 8-Pin for RS232 control input<br>- HDMI Input: 1x 19-Pin HDMI(V1.3) for digital video input<br>- RJ-45 Input: 1x RJ-45 for network management<br>- Video Input:<br>1x Composite video RCA input<br>1x S-Video input<br>- Audio Input: 1x Stereo Mini Jack<br>- Computer Output: 1x 15-pin D-Sub VGA for monitor<br>- Audio Output: 1x Stereo Mini Jack |
| Built-in Speaker               | 8W (monaural)                                                                                                                                                                                                                                                                                                                                                                                                                                                                                     |
| Weight                         | 8.2lbs / 3.7kgs                                                                                                                                                                                                                                                                                                                                                                                                                                                                                   |
| Dimensions (W x D x H)         | 12.1 x 11.5 x 4.7 inches (306.5x 292.2 x 120.5 mm) (Including protrusions)<br>12.1 x 9.9 x 4.1 inches (306.5x 252.3 x 105.0 mm) (not including protrusions)                                                                                                                                                                                                                                                                                                                                       |
| Environmental                  | - Operating Temperature: 41~95°F (5~ 35°C)<br>Humidity: 80% maximum (Non-condensing)<br>- Storage Temperature: -4~140°F (-20~60°C)<br>Humidity: 80% maximum (Non-condensing)                                                                                                                                                                                                                                                                                                                      |
| Optional Parts                 | - COMPONENT-VGA Cable : POA-CA-COMPVGA<br>- Serial control cable : POA-MCSRL<br>- VGA cable (10m) : KA-MC-DB10<br>- SCART-VGA Cable : POA-CA-SCART                                                                                                                                                                                                                                                                                                                                                |