

myprojectorlamps.com

**The most trusted, dependable name
in projector lamp sales.**



<http://www.myprojectorlamps.com>



<http://www.myprojectorlamps.ca>



<http://www.myprojectorlamps.eu>

The following projector manual has not been modified or altered in any way.

SANYO

Multimedia Projector

MODEL PDG-DSU30

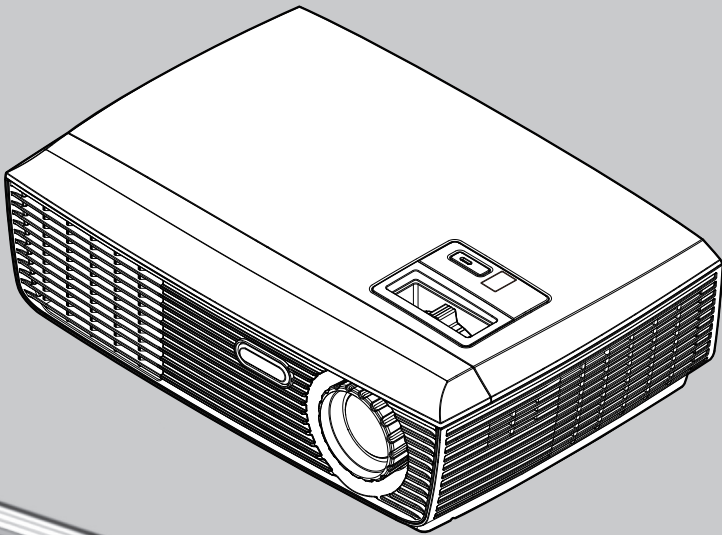

PROJECTOR

Owner's Manual

Table of Contents

Table of Contents

Usage Notice

Precautions.....	2
------------------	---

Introduction

Product Features.....	5
Package Overview.....	6
Product Overview.....	7
Connection Ports.....	8
Remote Control.....	9
Remote Control Battery Installation.....	11
Remote Control Operating Range.....	11

Installation

Connecting the Projector.....	12
Connect to Computer/Notebook.....	12
Connect to Video.....	13
Powering On/Off the Projector.....	14
Powering On the Projector.....	14
Powering Off the Projector.....	15
Warning Indicator.....	16
Adjusting the Projected Image.....	17
Adjusting the Height of Projector Image.....	17
Adjusting the Projector Zoom and Focus.....	18
Adjusting Projection Image Size.....	18

User Controls

On Screen Display.....	19
How to operate.....	19
IMAGE.....	20
IMAGE Advanced.....	22
IMAGE Advanced Color.....	23
IMAGE Advanced Input.....	23
SCREEN.....	24
SETTING Language.....	26
SETTING.....	26
SETTING Signal.....	28
SETTING Advanced.....	29
OPTIONS.....	30
OPTIONS Advanced.....	31
OPTIONS Lamp Settings.....	32

Appendices

Troubleshooting.....	33
Replacing the lamp.....	38
Specifications.....	40
Computer Compatibility.....	41
Configurations of Terminals.....	42
Terminal : Analog RGB (Mini D-sub 15 pin).....	42
Terminal : Mini DIN 3-pin.....	42
Regulation & Safety Notices.....	43
Serial Control Interface.....	46
Operation.....	46
Functional Execution Command.....	47
Status Read Command.....	48
Dimensions.....	49

Usage Notice

Precautions



Follow all warnings, precautions and maintenance as recommended in this user's guide to maximize the life of your unit.

- Warning- This apparatus must be earthed.
- Warning- Do not look into the projector's lens when the lamp is on. The bright light may hurt your eyes.
- Warning- To reduce the risk of fire or electric shock, do not expose this projector to rain or moisture.
- Warning- Please do not open or disassemble the projector as this may cause electric shock.
- Warning- When replacing the lamp, please allow unit to cool down, and follow all replacement instructions..
- Warning- This projector will detect the life of the lamp itself. Please be sure to change the lamp when it shows warning messages.
- Warning- Reset the "Lamp Counter Reset" function from the on-screen display "Options | Lamp Settings" menu after replacing the lamp module (refer to page 32).
- Warning- When switching the projector off, please ensure the cooling cycle has been completed before disconnecting power. Allow 120 seconds for the projector to cool down.
- Warning- Do not use lens cap when projector is powered on.
- Warning- Turn on the projector first and then the signal sources.
- Warning- When the lamp reaches the end of its life, it will burn out and may make a loud popping sound. If this happens, the projector will not turn back on until the lamp module has been replaced. To replace the lamp, follow the procedures listed under "Replacing the Lamp".

Usage Notice

■ Warning-

Allowing the proper amount of space on the top, sides, and rear of the projector cabinet is critical for proper air circulation and cooling of the unit. The dimensions shown here indicate the minimum space required. If the projector is to be built into a compartment or similarly enclosed, these minimum distances must be maintained.

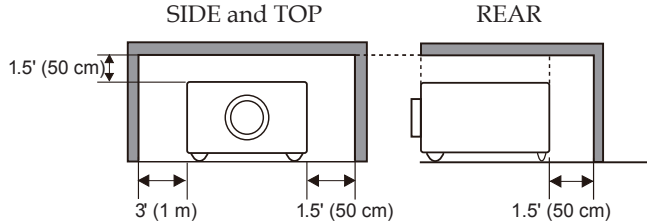

■ Warning-

Avoid positioning the projector as described below when installing.

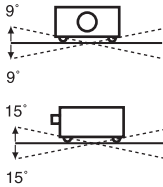

Do not roll the projector more than 9 degrees from side to side.

Do not pitch the projector more than 15 degrees from above and below.



Do not point the projector up to project an image.



Do not point the projector down to project an image.



Do not put the projector on either side to project an image.

Usage Notice

Do:

- Turn off the product before cleaning.
- Use a soft cloth moistened with mild detergent to clean the display housing.
- Disconnect the power plug from AC outlet if the product is not being used for a long period of time.

Do not:

- Block the slots and openings on the unit provided for ventilation.
- Use abrasive cleaners, waxes or solvents to clean the unit.
- Use under the following conditions:
 - Extremely heat, cold or humidity.
 - In areas susceptible to excessive dust and dirt.
 - Near any appliance generating a strong magnetic field.
 - In direct sunlight.

Product Features

This product is a SVGA single chip 0.55" DLP® projector. Outstanding features include:

- True SVGA, 800 x 600 addressable pixels
- Single chip DLP® technology
- NTSC3.58/NTSC4.43/PAL(B/D/G/H/I/M/N)/SECAM (B/D/G/K/K1/L) and SDTV(480i/576i), EDTV(480p/576p), HDTV(720p/1080i/1080p) compatible
- Multi-Auto functions: Auto detection, Auto image and Auto saving the adjustments
- Full function remote control
- User friendly multilingual on screen display
- Advanced digital keystone correction and high quality full screen image re-scaling
- Built-in mono 2-Watt speaker.
- UXGA, WXGA, SXGA+, SXGA, XGA compression and VGA re-sizing
- Macintosh compatible

Introduction

Package Overview

This projector comes with all the items shown below. Check to make sure your unit is complete. Contact your dealer immediately if anything is missing.

Note

❖ Due to the difference in applications for each country, some regions may have different accessories.

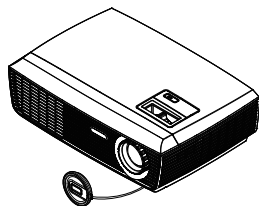

Projector with lens cap



Wireless Remote Control



Battery

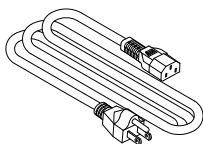

Power Cable

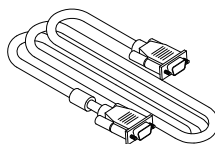

VGA Cable

Cable	Factory code
AC Power Cable (for U.S.A.)	42.00105G011
AC Power Cable (for Continental Europe)	42.00120G011
AC Power Cable (for UK)	42.00110G011
VGA Cable	42.00200G005

Documentation:

- CD-ROM User's Manual
- Quick Reference Guide

Introduction

Product Overview

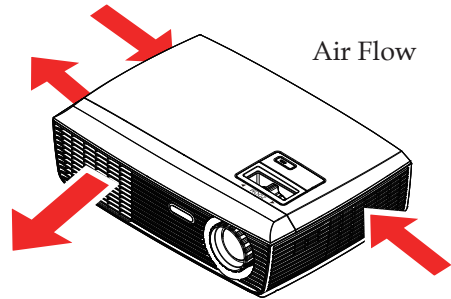
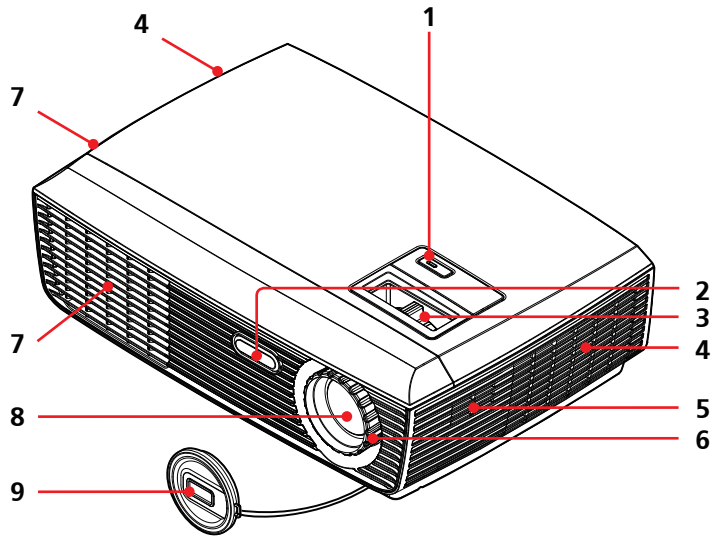

1. ON/STAND-BY button and LED indicator
2. Remote Sensor
3. Zoom Ring
4. Ventilation (inlet)
5. Speaker
6. Focus Ring
7. Ventilation (outlet)
8. Lens
9. Lens Cap

Introduction

Connection Ports

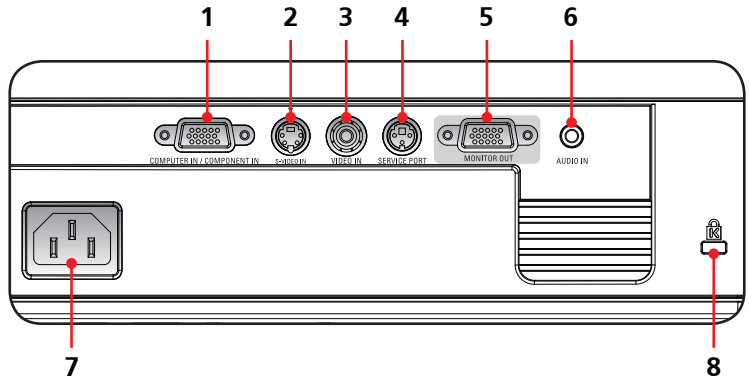

1. COMPUTER IN/COMPONENT IN Connector
2. S-VIDEO IN Connector
3. VIDEO IN Connector
4. SERVICE Port
5. MONITOR OUT Connector
6. AUDIO IN Jack
7. AC IN
8. Kensington™ Lock

Introduction

Remote Control

Note

❖ Before using the remote control for the first time, remove the transparent insulation tape. See page 11 for battery installation.

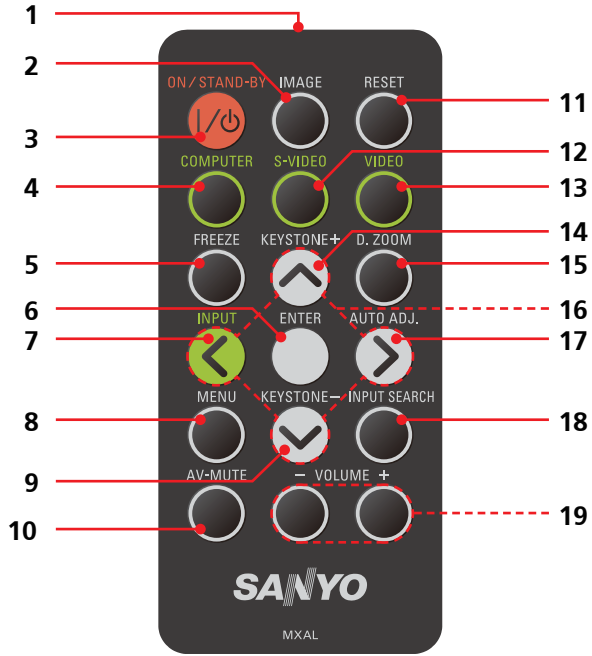
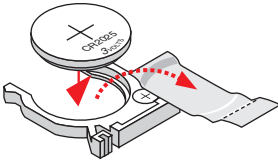

1	Infrared transmitter	Sends signals to the projector.
2	IMAGE	Select the Image mode from Presentation, Bright, Movie, sRGB, Blackboard, Classroom, User1 and User2.
3	ON/STAND-BY	Refer to the “Power On/Off the Projector” section. (See pages 14~15)
4	COMPUTER	Press “COMPUTER” to choose Computer in/Component in connector.
5	FREEZE	Pause the screen image. Press again to resume the screen image.
6	ENTER	Confirm your section of items in sub menu operation.

Note

❖ You can only turn the projector on/off with ON/STAND-BY button on the projector. You can operate all of the functions of the projector via the remote control. Make sure not to lose the remote control.

Introduction

7	INPUT	Press "INPUT" to choose RGB, Component, S-Video and Composite sources.
8	MENU	Press "MENU" to launch the On-screen display (OSD), back to the top level of OSD for the OSD main menu operation
9	KEYSTONE -	Adjust the image to compensate for distortion caused by tilting the projector.
10	AV-MUTE	Momentarily turn off/on the audio and video.
11	RESET	Return the adjustments and settings to the factory default values. (except for lamp counter)
12	S-VIDEO	Press "S-VIDEO" to choose S-Video in connector.
13	VIDEO	Press "VIDEO" to choose Video in connector.
14	KEYSTONE +	Adjust the image to compensate for distortion caused by tilting the projector.
15	D.ZOOM	Zoom out or Zoom in the projector display.
16	Four Directional Select Keys	Use ▲ or ▼ or ◀ or ▶ to select items or make adjustments to your selection.
17	AUTO ADJ.	Automatically synchronize the projector to the input source.
18	INPUT SEARCH	This function detects the input signal automatically. When finding a signal, the search will stop. (See page 23 and 30)
19	VOLUME +/-	Increase/decrease speaker volume.

Introduction

Remote Control Battery Installation

- 1 Press firmly and slide the battery cover off.

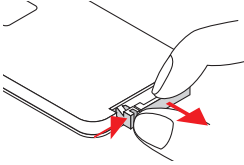

- 2 Install new battery into the compartment.

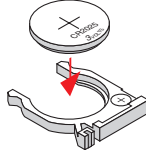

Remove the old Lithium coin cell and install new one (CR2025). Ensure that the side with a "+" is facing up.

- 3 Put the cover back.

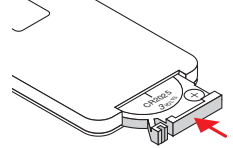

To ensure safe operation, please observe the following precautions :

- Use CR2025 type battery.
- Avoid contact with water or liquid.
- Do not expose the remote control to moisture or heat.
- Do not drop the remote control.
- If the battery has leaked in the remote control, carefully wipe the case clean and install new battery.
- Risk of an explosion if battery is replaced by an incorrect type.
- Dispose of used battery according to the instructions.

Remote Control Operating Range

Point the remote control toward the projector (Infrared Remote Receiver) when pressing any button. Maximum operating range for the remote control is about 23.0' (7m) and 30° in front of the projector.

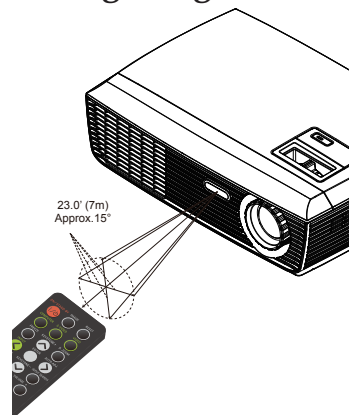

Installation

Connecting the Projector

Connect to Computer/Notebook

Note

- ❖ Make sure that the power plug is fully inserted into both the projector AC inlet and the wall outlet.
- ❖ The AC outlet must be near this equipment and must be easily accessible.

Note

- ❖ Due to the difference in applications for each country, some regions may have different accessories.

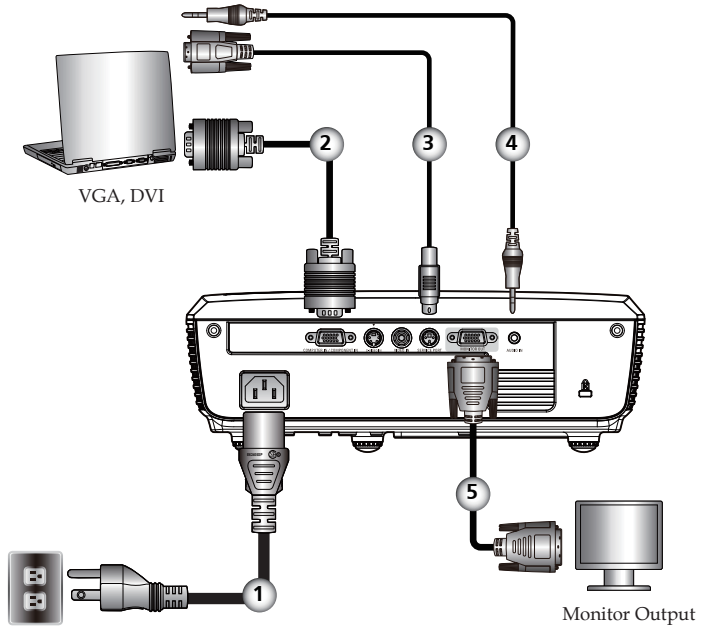

- | | |
|--------|-----------------------------|
| 1..... | Power cable (supplied) |
| 2..... | VGA cable (supplied) |
| 3..... | RS232 cable |
| 4..... | Audio in cable jack to jack |
| 5..... | Monitor out cable |

- ❖ To ensure the projector works well with your computer, please make sure the timing of the display mode is compatible with your projector.

Note

- ❖ Make sure that the power plug is fully inserted into both the projector AC inlet and the wall outlet.
 - ❖ The AC outlet must be near this equipment and must be easily accessible.
 - ❖ Other than the analog RGB signal, VGA-IN Connectors can be used to project the incoming Component signals.
- (See Page 40 for the Optional Parts.)

Note

- ❖ Due to the difference in applications for each country, some regions may have different accessories.

Connect to Video

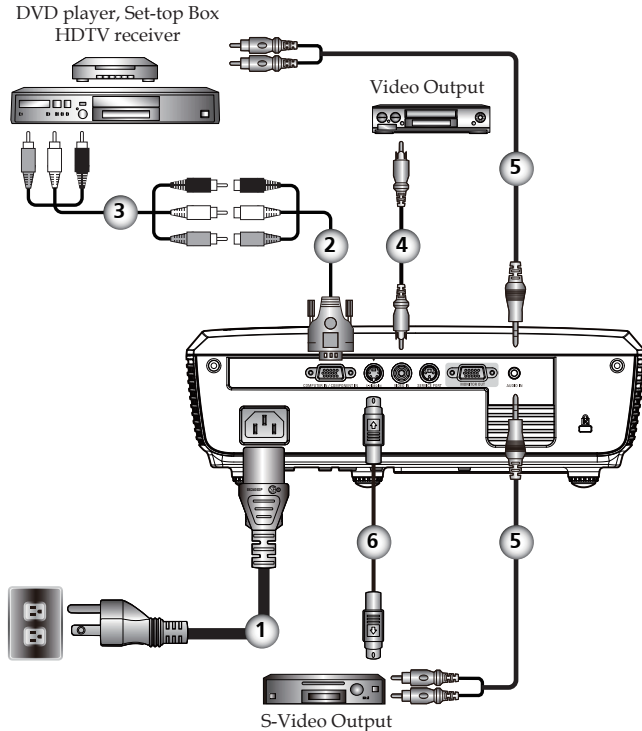

- | | |
|--------|-----------------------------|
| 1..... | Power cable (supplied) |
| 2..... | COMPONENT-VGA Cable |
| 3..... | 3 RCA Component Cable |
| 4..... | Composite video cable |
| 5..... | Audio in cable jack to jack |
| 6..... | S-Video cable |

- ❖ To ensure the projector works well with your computer, please make sure the timing of the display mode is compatible with your projector.

Installation

Powering On/Off the Projector

Powering On the Projector

1. Ensure that the power cable and signal cable are securely connected. The POWER LED will turn red.
2. Remove the lens cap. ❶
3. Turn on the lamp by pressing “ON/STAND-BY” on the control panel or the remote control. ❷ The POWER LED will flash blue.

The startup screen will display in approximately 5 seconds. When disappear startup screen, the POWER LED will turn blue.

4. Turn on your source (computer, notebook, video player, etc.) The projector will detect your source automatically.
- ❖ If you connect multiple sources at the same time, use the “INPUT” on the remote control or use “COMPUTER”, “S-VIDEO”, “VIDEO” on the remote control to switch inputs.

Note

❖ Turn on the projector first and then the signal sources.

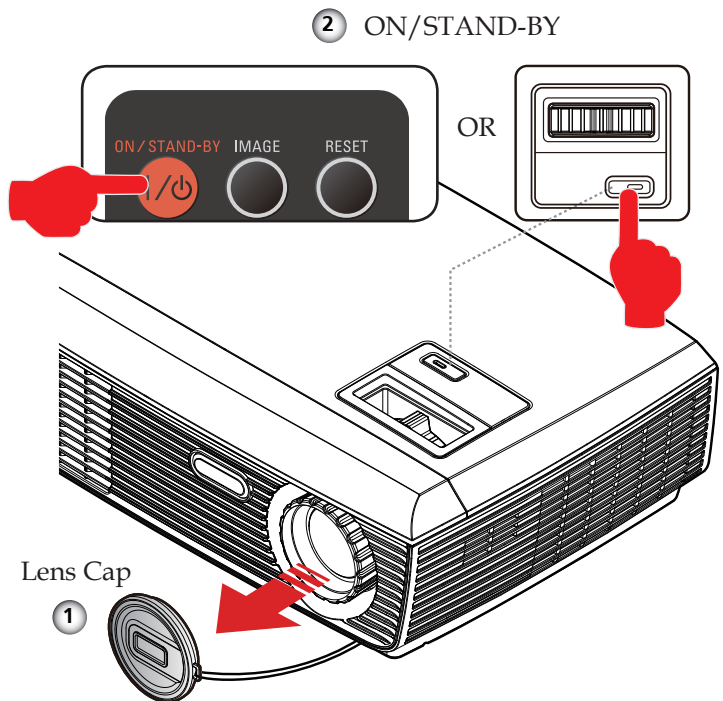

Powering Off the Projector

1. Press the “ON/STAND-BY” to turn off the projector lamp, you will see a message as below on the on-screen display.

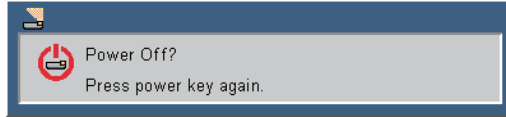

2. Press the “ON/STAND-BY” again to confirm.
3. The cooling fan continues to operate for about 120 seconds for cooling cycle and the POWER LED will flash blue. When the light stop flashing and turn red, the projector has entered standby mode.

If you wish to turn the projector back on, you must wait until the projector has completed the cooling cycle and has entered standby mode. Once in standby mode, simply press “ON/STAND-BY” to restart the projector.

4. Disconnect the power cable from the electrical outlet and the projector.
5. Do not turn on the projector immediately following a power off procedure.

Warning Indicator

- ❖ When the “POWER” LED indicator flashes red (1 sec on, 1 sec off), it indicates the projector has overheated. The projector will automatically shut itself down.

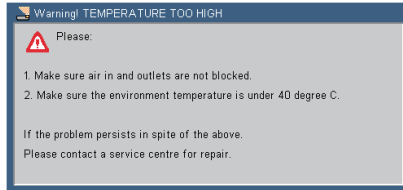

- ❖ When you see the message below displays on-screen, the projector has detected that the lamp is approaching its end of life. Please change the lamp as soon as possible or contact your local dealer or our service center.



- ❖ When the “POWER” LED indicator flashes red (0.5 sec on, 2 secs off) and the message below displays on-screen, it indicates the fan failed. Stop using the projector and disconnect the power cable from the electrical outlet, then contact your local dealer or our service center.



Adjusting the Projected Image

Adjusting the Height of Projector Image

The projector is equipped with adjustable feet to raise and lower the image to fill the screen.

To raise/lower the image:

1. Use ❶ to fine-tune the display angle.

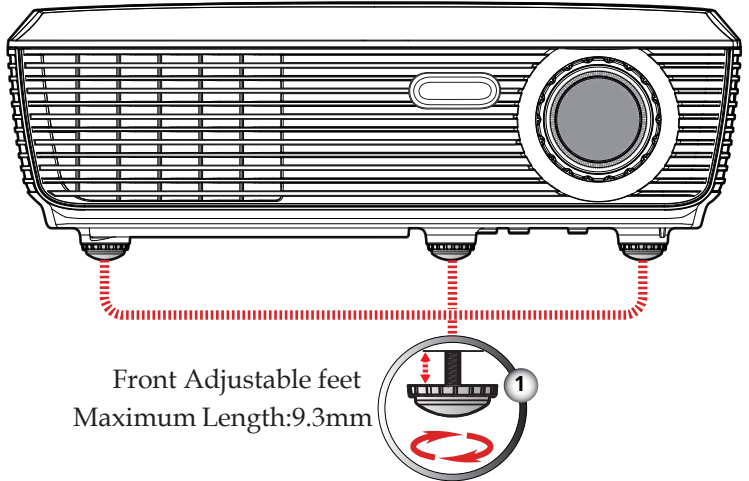

Note

❖ You can raise the projector front up to 3.7 degrees by rotating the adjustable feet.

Installation

Adjusting the Projector Zoom and Focus

You may turn the zoom ring to zoom in or out. To focus the image, rotate the focus ring until the image is clear. The projector will focus at distances from 3.94 to 39.36 feet (1.2 to 12.0 meters) with mechanical travel.

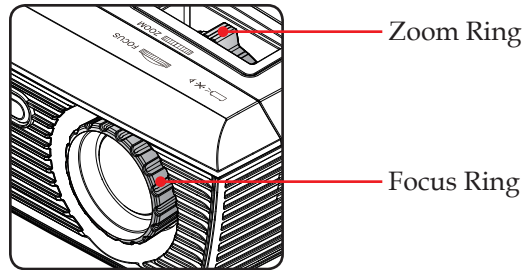

Adjusting Projection Image Size

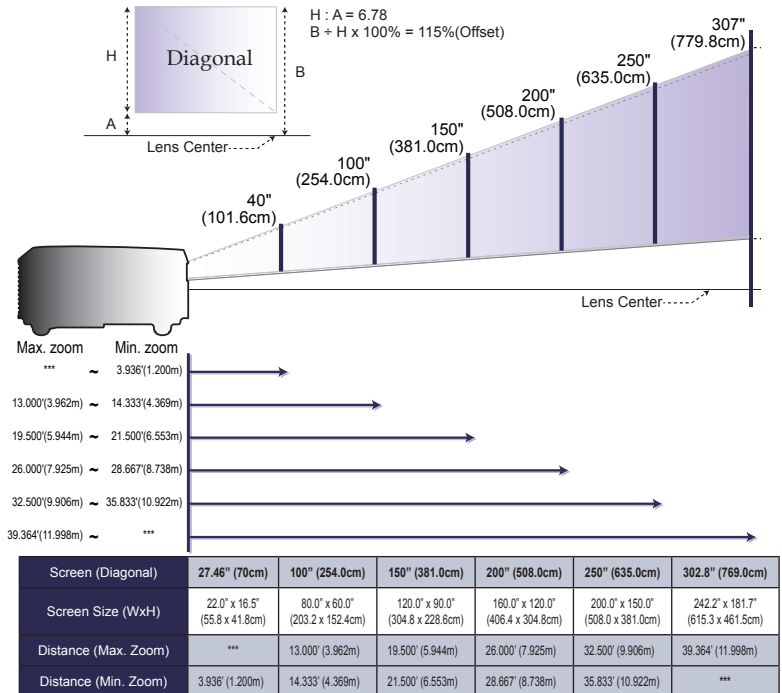

❖ This graph is for user's reference only.

On Screen Display

The Projector has a multilingual On Screen Display that allows you to make image adjustments and change a variety of settings. The projector will automatically detect the source.

How to operate

1. To open the OSD, press “MENU” on the Remote Control.
2. When OSD is displayed, use ◀ ▶ keys to select any item in the main menu. While making a selection on a particular page, press ▼ key to enter sub menu.
3. Use ▲ ▼ keys to select the desired item in the sub menu and adjust the settings by ◀ ▶ key.
4. If the setting has ↵ icon, you could press “ENTER” to enter another sub menu. Press “MENU” to close the sub menu after adjustment.
5. After adjusting the settings, press “MENU” go back to the main menu.
6. To exit, press “MENU” again. The OSD will be closed and the projector will automatically save the new settings.

Note

❖ If no button operation is made for 30 seconds, the OSD will be closed automatically.

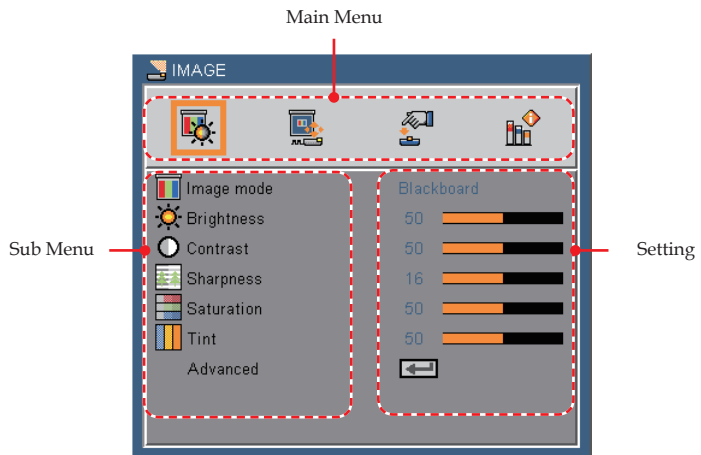

User Controls

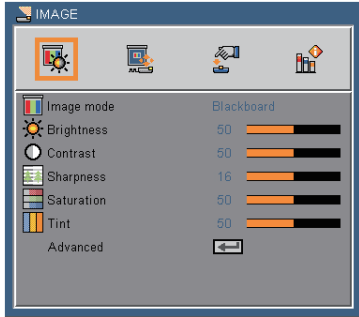

IMAGE

Image Mode

There are many factory presets optimized for various types of images. Use the ◀ or ▶ to select the item.

- ▶ Presentation: For computer or notebook.
- ▶ Bright: For bright room.
- ▶ Movie: For home theater.
- ▶ sRGB: For standard color.
- ▶ Blackboard: This mode should be selected to achieve optimum color settings when projecting onto a blackboard (green).
- ▶ Classroom: This mode is recommended for projecting in a classroom.
- ▶ User1/User2: Memorize user's settings.

Brightness

Adjust the brightness of the image.

- ▶ Press the ◀ to darken image.
- ▶ Press the ▶ to lighten the image.

Contrast

The contrast controls the degree of difference between the lightest and darkest parts of the picture. Adjusting the contrast changes the amount of black and white in the image.

- ▶ Press the ◀ to decrease the contrast.
- ▶ Press the ▶ to increase the contrast.

Sharpness

Adjust the sharpness of the image.

- ▶ Press the ◀ to decrease the sharpness.
- ▶ Press the ▶ to increase the sharpness.

Saturation

Adjust a video image from black and white to fully saturated color.

- ▶ Press the ◀ to decrease the amount of color in the image.
- ▶ Press the ▶ to increase the amount of color in the image.

Note

❖ “Sharpness”, “Saturation” and “Tint” functions are only supported under Video mode.

Tint

Adjust the color balance of red and green.

- ▶ Press the ◀ to increase the amount of green in the image.
- ▶ Press the ▶ to increase the amount of red in the image.

User Controls

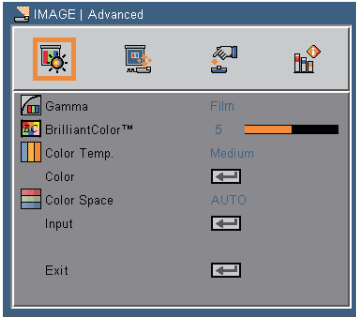

IMAGE | Advanced

Gamma

This allows you to choose a gamma table that has been fine-tuned to bring out the best image quality for the input.

- ▶ Film: For home theater.
- ▶ Video: For video or TV source.
- ▶ Graphics: For image source.
- ▶ PC: For computer or notebook.

BrilliantColor™

Produces an expanded onscreen color spectrum that delivers enhanced color saturation for bright, true-to-life images.

Color Temp.

Adjust the color temperature. At higher temperature, the screen looks colder; at lower temperature, the screen looks warmer.

Color Space

Select an appropriate color matrix type from AUTO, RGB or YUV.

User Controls

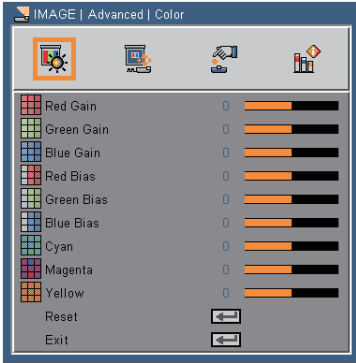

IMAGE | Advanced | Color

Color

Use these settings for advanced adjustment of the individual Red, Green, Blue, Cyan, Magenta and Yellow Colors.

Reset

Choose “Yes” to return the factory default settings for “Color” menu.

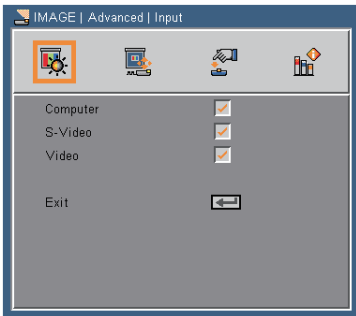
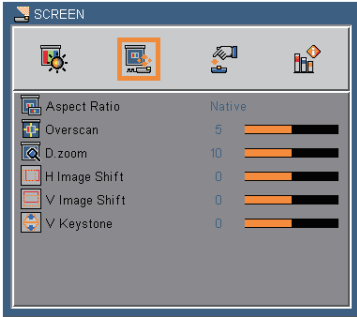

IMAGE | Advanced | Input

Input

Use this option to enable / disable input sources. Press **←** to enter the sub menu and select which sources you require. Press “Enter” to finalize the selection. The projector will not search for inputs that are not selected. (p.30)

User Controls



SCREEN

Aspect Ratio

Use this function to choose your desired aspect ratio.

- ▶ 4:3: This format is for 4×3 input sources not enhanced for Wide-screen TV.
- ▶ 16:9-I: This format is for 16×9 input sources, like HDTV and DVD enhanced for Wide screen TV. (576i/p)
- ▶ 16:9-II: This format is for 16×9 input sources, like HDTV and DVD enhanced for Wide screen TV. (480i/p)
- ▶ Native: This format displays the original image without any scaling.
- ▶ AUTO: Automatically selects the appropriate display format.

Aspect ratio (source detected)	Resize image
	SVGA model
4:3	800 x 600 center
16:9-I	800 x 450 center
16:9-II	854 x 480 catch 800 x 480 center
Native	1:1 mapping center

Overscan

Overscan function removes the noise in a video image. Overscan the image to remove video encoding noise on the edge of video source.

D. zoom

Adjust the size of projector's display area.

- ▶ Press the ◀ to reduce the size of an image on the projection screen.
- ▶ Press the ▶ to magnify an image on the projection screen.

H Image Shift

Shift the projected image position horizontally.

V Image Shift

Shift the projected image position vertically.

V Keystone

Press the ◀ or ▶ to adjust image distortion vertically and makes a rectangular image.

User Controls

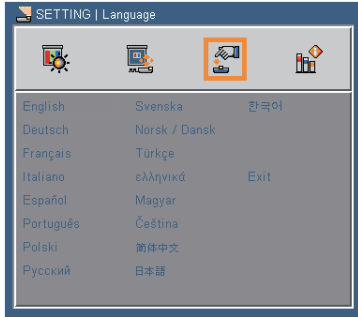

SETTING | Language

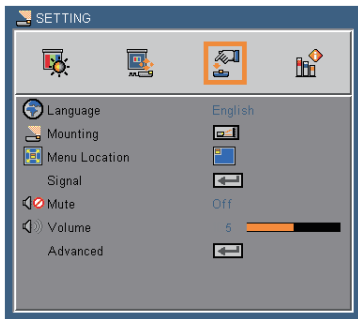

Language

Choose the multilingual OSD. Press ▼ into the sub menu and then use the ▲ or ▼ or ◀ or ▶ key to select your preferred language. Press “ENTER” to finalize the selection.



SETTING

Mounting

- ▶  Front-Desktop
The factory default setting. The image is projected straight on the screen.
- ▶  Rear-Desktop
When you select this function, the projector reverses the image so you can project behind a translucent screen.
- ▶  Front-Ceiling
When you select this function, the projector turns the image upside down for ceiling-mounted projection.

- ▶  Rear-Ceiling

When you select this function, the projector reverses and turns the image upside down at same time. You can project from behind a translucent screen with ceiling mounted projection.

Menu Location

Choose the menu location on the display screen.

Mute

- ▶ Choose “On” to mute the volume.
- ▶ Choose “Off” to restore the volume.

Volume

- ▶ Press the ◀ to decrease the volume.
- ▶ Press the ▶ to increase the volume.

User Controls

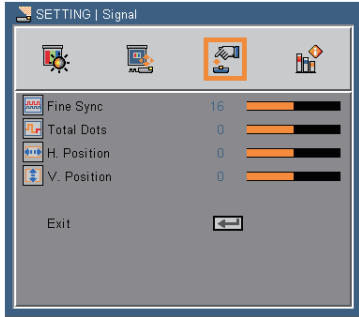

SETTING | Signal



Note

❖ "Signal" is only supported in Analog VGA (RGB) signal.

Fine Sync

Eliminate flicker from the image displayed. Use the ◀ or ▶ to adjust the value.

Total Dots

Adjust the number of total dots in one horizontal period. Use the ◀ or ▶ to adjust number to match your PC image.

H. Position (Horizontal Position)

- ▶ Press the ◀ to move the image left.
- ▶ Press the ▶ to move the image right.

V. Position (Vertical Position)

- ▶ Press the ◀ to move the image down.
- ▶ Press the ▶ to move the image up.

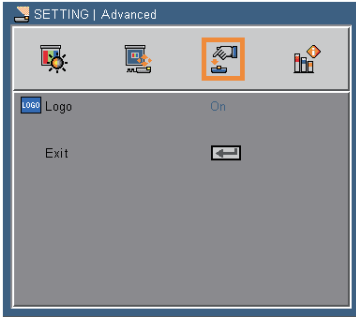

SETTING | Advanced

Logo

Use this function to set the desired startup screen. If changes are made they will take effect the next time the projector is powered on.

- ▶ On: SANYO startup screen.
- ▶ Off: No logo is displayed.

User Controls

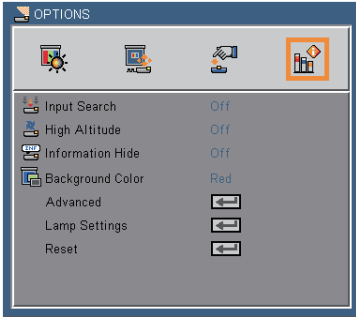

OPTIONS

Input Search

When this function is turned “On”, the projector will search for other signals if the current input signal is lost. When this function is turned “Off”, it will only search a specified connection port. (p.23)

High Altitude

When “On” is selected, the fans will spin faster. This feature is useful in high altitude areas where the air is thin.

Information Hide

- ▶ On: Choose “On” to hide the “searching” message.
- ▶ Off: Choose “Off” to show the “searching” message.

Background Color

Use this feature to display a “Black”, “Red”, “Blue”, “Green” or “White”, screen when no signal is available.

Reset

Return the adjustments and settings to the factory default values. (except for lamp counter)



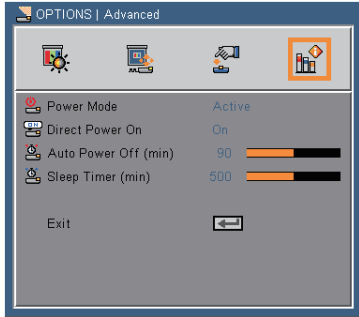

OPTIONS | Advanced

Power Mode

- ▶ Standby: Choose “Standby” to save power dissipation further < 1W.
- ▶ Active: Choose “Active” to return to normal standby mode and the “MONITOR OUT” port will be enabled.

Direct Power On

Choose “On” to activate Direct Power mode. The projector will automatically power on when AC power is supplied, without pressing the “ON/STAND-BY” key on the projector control panel or “ON/STAND-BY” key on the remote control.

Auto Power Off (min)

Sets the countdown timer interval. The countdown timer will start, when there is no signal being sent to the projector. The projector will automatically power off when the countdown has finished (in minutes).

Sleep Timer (min)

Sets the countdown timer interval. The countdown timer will start, with or without a signal being sent to the projector. The projector will automatically power off when the countdown has finished (in minutes).

User Controls

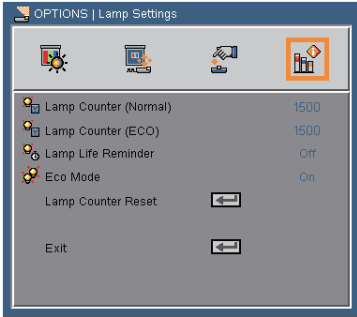

OPTIONS | Lamp Settings

Lamp Counter (Normal)

Display the projection time of normal mode.

Lamp Counter (ECO)

Display the projection time of ECO mode.

Lamp Life Reminder

- ▶ On: Choose "On" to show the lamp end of life warning message.
- ▶ Off: Choose "Off" to hide the lamp end of life warning message.

Eco Mode

- ▶ On: Choose "On" to dim the projector lamp which will lower power consumption and extend the lamp life.
- ▶ Off: Choose "Off" to increase the brightness.

Lamp Counter Reset

Reset the lamp hour counter after replacing the lamp. (p.38)

Troubleshooting

If you experience trouble with the projector, refer to the following information. If the problem persists, please contact your local dealer or service center.

Problem: No image appears on screen

- ▶ Ensure all the cables and power connections are correctly and securely connected as described in the “Installation” section.
- ▶ Ensure the pins of connectors are not crooked or broken.
- ▶ Check if the projection lamp has been securely installed. Please refer to the “Replacing the lamp” section.
- ▶ Make sure you have removed the lens cap and the projector is switched on.
- ▶ Ensure that the “AV-MUTE” feature is not turned on.

Problem: Partial, scrolling or incorrectly displayed image

- ▶ Press “AUTO ADJ.” on the remote control.
- ▶ If you are using a PC:

For Windows 95, 98, 2000, XP:

1. From the “My Computer” icon, open the “Control Panel” folder, and double click the “Display” icon.
2. Select the “Settings” tab
3. Click on the “Advanced Properties”.

For Windows Vista:

1. From the “My Computer” icon, open the “Control Panel” folder, and double click the “Appearance and Personalization”
2. Select “Personalization”
3. Click “Adjust screen resolution” to display “Display Settings”. Click on the “Advanced Settings”.

If the projector is still not projecting the whole image, you will also need to change the monitor display you are using. Refer to the following steps.

Appendices

4. Verify the resolution setting is less than or equal to 1600 x 1200 resolution.
 5. Select the "Change" under the "Monitor" tab .
 6. Click on "Show all devices". Next, select "Standard monitor types" under the SP box; choose the resolution mode you need under the "Models" box.
- ▶ If you are using a Notebook:
1. First, follow the steps above to adjust resolution of the computer.
 2. Press the toggle output settings. example: [Fn]+[F4]

Compaq=>	[Fn]+[F4]	Hewlett	
Dell =>	[Fn]+[F8]	Packard =>	[Fn]+[F4]
Gateway=>	[Fn]+[F4]	NEC=>	[Fn]+[F3]
IBM=>	[Fn]+[F7]	Toshiba =>	[Fn]+[F5]

Macintosh Apple:
System Preference-->Display-->Arrangement-->Mirror display

- ▶ If you experience difficulty changing resolutions or your monitor freezes, restart all equipment including the projector.

Problem: The screen of the Notebook or PowerBook computer is not displaying a presentation

- ▶ If you are using a Notebook PC:

Some Notebook PCs may deactivate their own screens when a second display device is in use. Each has a different way to be reactivated. Refer to your computer's documentation for detailed information.

Problem: Image is unstable or flickering

- ▶ Adjust the "Total Dots" or "Fine Sync" to correct it. Refer to the "Setting | signal" section for more information.
- ▶ Change the monitor color setting from your computer.

- ▶ Check and reconfigure the display mode of your graphic card to make it compatible with the product.

Problem: Image is out of focus

- ▶ Adjust the Focus Ring on the projector lens.
- ▶ Make sure the projection screen is between the required distance 3.94 to 39.36 feet (1.2 to 12.0 meters) from the projector (refer to page 18).

Problem: The image is stretched when displaying 16:9 DVD

The projector automatically detects 16:9 DVD and adjusts the aspect ratio by digitizing to full screen with 4:3 default setting.

If the image is still stretched, you will also need to adjust the aspect ratio by referring to the following:

- ▶ Please select 4:3 aspect ratio type on your DVD player if you are playing a 16:9 DVD.
- ▶ If you can't select 4:3 aspect ratio type on your DVD player, please select 4:3 aspect ratio in the on screen menu.

Problem: Image is too small or too large

- ▶ Adjust the Zoom Ring on the top of the projector.
- ▶ Move the projector closer to or further from the screen.
- ▶ Press "MENU" button on the remote control or projector panel, go to "Screen --> Aspect Ratio" and try the different settings.

Problem: Image is reversed

- ▶ Select "Setting-->Mounting" from the OSD and adjust the projection direction.

Problem: Lamp burns out or makes a popping sound

- ▶ When the lamp reaches its end of life, it will burn out and may make a loud popping sound. If this happens, the projector will

Appendices

not turn on until the lamp module has been replaced. To replace the lamp, follow the procedures in the “Replacing the Lamp”.

Problem: LED lighting message

Message	POWER-LED	
	(Blue)	(Red)
Standby (Input power cable)	○	☀
Normal (Power on)	☀	○
Powering up (Warming up)	Flashing(1 sec)	○
Power off (Cooling-I: It can't accept any key at this status)	Flashing(0.5 sec)	○
Power off (Cooling-II: It can accept power key to turn on the projector)	Flashing(1 sec)	○
Error (Lamp failed)	○	Flashing(0.5 sec)
Error (Fan lock)	○	Flashing(1 sec)
Error (Over temp.)	○	Flashing (0.5 sec on, 2 secs off)

Note

Steady light => ☀
No light => ○

Problem: Message Reminders

- ▶ Over temperature - the projector has exceeded its recommended operating temperature and must be allowed to cool down before it may be used.

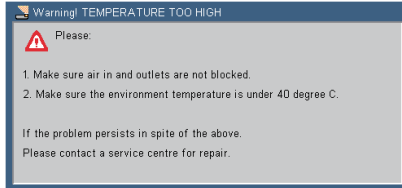

- ▶ Replacing the lamp - the lamp is about to reach its maximum life-time. Prepare to replace it soon.



- ▶ Fan failed - the system fan is not working.

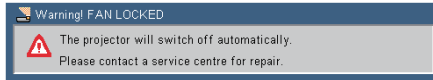

Replacing the lamp

The projector will detect the lamp life itself. It will show you a warning message



Warning: To avoid burns, allow the projector to cool for at least 45 minutes before you replace the lamp!

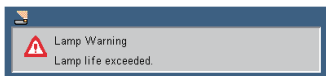

When you see this message, change the lamp as soon as possible. Make sure the projector has been cooled down for at least 45 minutes before changing the lamp.

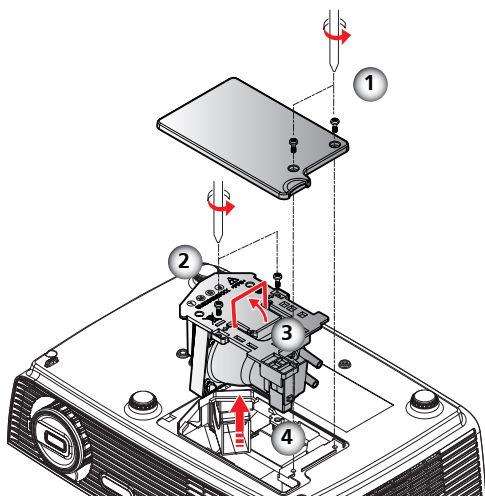

Warning: To reduce the risk of personal injury, do not drop the lamp module or touch the lamp bulb. The bulb may shatter and cause injury if it is dropped.

Warning: For continued safety replace with a lamp of the same type.

Lamp Replacing Procedure:

1. Switch off the power to the projector by pressing the "ON/STAND-BY".
2. Allow the projector to cool down at least 45 minutes.
3. Disconnect the power cable.
4. Use a screwdriver to remove the 2 screws from the cover. ❶
5. Push up and remove the cover.
6. Remove the 2 screws from the lamp module ❷ and pull up the lamp bar. ❸
7. Pull out the lamp module by force. ❹
8. Install the new lamp module by reversing the previous steps.
9. After replacing the lamp, turn on the power, and select the menu ->[Options | Lamp Settings] ->[Lamp Counter Reset] to reset the lamp usage hours. See page 32.

ORDER REPLACEMENT LAMP

Replacement lamp can be ordered through your dealer. When ordering a projection lamp, give the following information to the dealer.

- Model No. of your projector : PDG-DSU30
- Replacement Lamp Type No. : POA-LMP133
(Service Parts No. CHSP8CS01GC01)



LAMP HANDLING PRECAUTIONS

This projector uses a high-pressure lamp which must be handled carefully and properly.

Improper handling may result in accidents, injury, or create a fire hazard.

- Lamp life may differ from lamp to lamp and according to the environment of use. There is no guarantee of the same life for each lamp. Some lamps may fail or terminate their life in a shorter period of time than other similar lamps.
- If the projector indicates that the lamp should be replaced, i.e., if the lamp life warning message appears, replace the lamp with a new one IMMEDIATELY after the projector has cooled down. (Follow carefully the instructions in the Lamp Replacement section of this manual.) Continuous use of the lamp with showing the lamp life warning message may increase the risk of lamp explosion.
- A Lamp may explode as a result of vibration, shock or degradation as a result of hours of use as its lifetime draws to an end. Risk of explosion may differ according to the environment or conditions in which the projector and lamp are being used.

IF A LAMP EXPLODES, THE FOLLOWING SAFETY PRECAUTIONS SHOULD BE TAKEN.

If a lamp explodes, disconnect the projector's AC plug from the AC outlet immediately. Contact an authorized service station for a checkup of the unit and replacement of the lamp. Additionally, check carefully to ensure that there are no broken shards or pieces of glass around the projector or coming out from the cooling air circulation holes. Any broken shards found should be cleaned up carefully. No one should check the inside of the projector except those who are authorized trained technicians and who are familiar with projector service. Inappropriate attempts to service the unit by anyone, especially those who are not appropriately trained to do so, may result in an accident or injury caused by pieces of broken glass.

Appendices

Specifications

Projection System	Single Chip DLP® Technology by Texas Instruments
Number of Pixels	SVGA: 800 pixels(H) × 600 lines(V), up to UXGA (1600 X 1200) with scaling technology
Lamp	180W (160W on ECO mode)
Projection Lens	F#2.41~2.55 f=21.8~24 mm with 1.1× manual zoom lens
Projection Screen Size (Diag.)	27.46 to 302.80 inches (0.7 to 7.7 meters) Diagonal
Projection Distance	3.94 to 39.36 feet (1.2 to 12.0 meters)
Video Compatibility	- NTSC-M/NTSC-4.43/PAL-B, D, G, H, I/PAL-M/PAL-N/SECAM - Component: SDTV(480i/576i), EDTV(480p, 576p), HDTV(720p, 1080i/p)
H. Frequency	31.35kHz~91.1kHz horizontal scan
V. Frequency	56Hz~85Hz vertical refresh
Power Supply	Universal AC input 100-240V ; Input Frequency 50-60Hz
Power Consumption	Normal mode: 255W Standby mode <1 Watt
Input Current	2.5-1.0A (100-240V AC)
I/O Connectors	- Power: AC power input socket - Computer Input: 1 × 15-pin D-Sub VGA for analog/component and HDTV signal - RS232 Input: 1 × Mini DIN 3-Pin for RS232 control input - Video Input: 1 × Composite video RCA input 1 × S-Video input - Audio Input: 1 × Stereo Mini Jack - Computer Output: 1 × 15-pin D-Sub VGA for monitor
Built-in Speaker	2W (monaural)
Weight	4.65bs / 2.3kgs
Dimensions (W × D × H)	11.3 × 7.6 × 3.5 inches (286.3 × 192.0 × 88.0 mm) (not including protrusions)
Environmental	- Operating Temperature: 41~95°F (5~35°C) Humidity: 80% maximum (Non-condensing) - Storage Temperature: -4~140°F (-20~60°C) Humidity: 80% maximum (Non-condensing)
Optional Parts	- COMPONENT-VGA Cable : POA-CA-COMPVGA - VGA cable (10m) : KA-MC-DB10

Computer Compatibility

Modes	Resolution	V.Frequency (Hz)	H.Frequency (kHz)
VGA	640 x 350	85	37.90
	640 x 400	85	37.90
	640 x 480	60	31.50
	640 x 480	72	37.90
	640 x 480	75	37.50
	640 x 480	85	43.30
	720 x 400	70	31.50
SVGA	720 x 400	85	37.90
	800 x 600	56	35.20
	800 x 600	60	37.90
	800 x 600	72	48.10
	800 x 600	75	46.90
XGA	800 x 600	85	53.70
	*1024 x 768	60	48.40
	*1024 x 768	70	56.50
	*1024 x 768	75	60.00
	*1024 x 768	85	68.70
WXGA	*1280 x 768	60	47.40
	*1280 x 768	75	60.30
	*1280 x 720	60	45.00
	*1280 x 800	60	49.30
SXGA	*1152 x 864	60	53.80
	*1152 x 864	70	63.80
	*1152 x 864	75	67.50
	*1152 x 864	85	77.10
	*1280 x 1024	60	63.98
	*1280 x 1024	75	79.98
	*1280 x 1024	85	91.10
SXGA+	*1280 x 960	60	60.00
	*1400 x 1050	60	65.31
UXGA	*1600 x 1200	60	75.00
MAC LC 13"	640 x 480	66.66	35.00
MAC 16"	*832 x 624	74.55	49.10
MAC 19"	*1024 x 768	75	60.24
MAC	*1152 x 870	75.06	68.68
MAC G4	640 x 480	66.619	34.98
i Mac DV	*1024 x 768	75	60.20
i Mac DV	*1152 x 870	75	68.68
i Mac DV	*1280 x 960	75	75

Note

Note: "*" compressed computer image.

Note

Note: The projector only support a separate sync signal. Composite sync and sync on green are not supported.

Configurations of Terminals

Terminal : Analog RGB (Mini D-sub 15 pin)

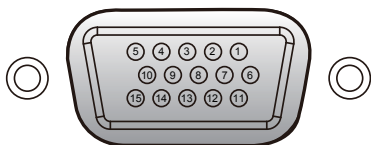

1	Red (R/Cr) Input/R Output	9	5V / ***
2	Green (G/Y) Input/G Output	10	Ground (Ver. sync.)
3	Blue (B/Cb) Input/B Output	11	ICP download
4	***	12	DDC data / ***
5	Ground (Horiz.sync.)	13	Horiz. sync. Input / Output (Composite H/V sync. Input)
6	Ground (Red)		
7	Ground (Green)	14	Vert. sync. Input / Output
8	Ground (Blue)	15	DDC clock / ***

Terminal : Mini DIN 3-pin

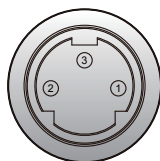

1	TXD
2	RXD
3	GND

Regulation & Safety Notices

This appendix lists the general notices of your Projector.

FCC notice

This device has been tested and found to comply with the limits for a Class B digital device pursuant to Part 15 of the FCC rules. These limits are designed to provide reasonable protection against harmful interference in a residential installation. This device generates, uses and can radiate radio frequency energy and, if not installed and used in accordance with the instructions, may cause harmful interference to radio communications.

However, there is no guarantee that interference will not occur in a particular installation. If this device does cause harmful interference to radio or television reception, which can be determined by turning the device off and on, the user is encouraged to try to correct the interference by one or more of the following measures:

- Reorient or relocate the receiving antenna.
- Increase the separation between the device and receiver.
- Connect the device into an outlet on a circuit different from that to which the receiver is connected.
- Consult the dealer or an experienced radio/television technician for help.

FCC Tested To Comply with FCC standards FOR HOME OR OFFICE USE

Declaration of Conformity

Model number: PDG-DSU30

Trade name: SANYO

Responsible party: SANYO North America Corporation

Address: 21605 Plummer Street Chatsworth, California 91311

Telephone: (818) 998-7322



Warning: this product contains a chemical known to the state of California to cause cancer, birth defects or other reproductive harm.

Notice: Shielded cables

All connections to other computing devices must be made using shielded cables to maintain compliance with FCC regulations.

Caution

Changes or modifications not expressly approved by the manufacturer could void the user's authority, which is granted by the Federal Communications Commission, to operate this projector.

Operation conditions

This device complies with Part 15 of the FCC Rules. Operation is subject to the following two conditions:

1. This device may not cause harmful interference and
2. This device must accept any interference received, including interference that may cause undesired operation.

Notice: Canadian users

This Class B digital apparatus complies with Canadian ICES-003.

Remarque à l'intention des utilisateurs canadiens

Cet appareil numérique de la classe B est conforme à la norme NMB-003 du Canada.

Declaration of Conformity for EU countries

- EMC Directive 2004/108/EC (including amendments)
- Low Voltage Directive 2006/95/EC

FOR EU USERS

The symbol mark and recycling systems described below apply to EU countries and do not apply to countries in other areas of the world.

Your product is designed and manufactured with high quality materials and components which can be recycled and/or reused.

The symbol mark means that electrical and electronic equipment, batteries and accumulators, at their end-of-life, should be disposed of separately from your household waste.

Note:

If a chemical symbol is printed beneath the symbol mark, this chemical symbol means that the battery or accumulator contains a heavy metal at a certain concentration. This will be indicated as follows: Hg: mercury, Cd: cadmium, Pb: lead

In the European Union there are separate collection systems for used electrical and electronic equipment, batteries and accumulators.

Please, dispose of them correctly at your local community waste collection/recycling centre.

Please, help us to conserve the environment we live in!



NOTES ON Lithium Battery (CALIFORNIA USA ONLY)

This product uses a Lithium Battery which contains Perchlorate Material - special handling may apply.

See www.dtsc.ca.gov/hazardouswaste/perchlorate

Manufacturer and Address:

SANYO Electric Co.,Ltd.

5-5, Keihan-hondori, 2-chome, Moriguchi City, Osaka, Japan

Authorized Representative and Address:

SANYO Sales & Marketing Europe GmbH

Stahlgruberring 4, D-81829 Munich, Germany

Serial Control Interface

This projector provides a function to control and monitor the projector's operations by using the RS-232C serial port.

Operation

1. Connect the specified RS-232C control cable to SERVICE PORT on the projector and serial port on the PC.
2. Launch a communication software provided with PC and setup the communication condition as follows:
3. Type the command for controlling the projector and then enter the "Enter" key.

Example

When you want to change the input to Computer, Type 'C' '0' '5' 'Enter'.

Baud rate	: 9600 bps
Parity check:	: none
Stop bit	: 1
Flow control	: none
Data bit	: 8

Note

- The default of the baud rate is set to 9600 bps. If an error occurs in the communication, change the serial port.
- Enter with ASCII 64-byte capital characters and one-byte characters.

ORDER RS-232C CONTROL CABLE

RS-232C control cable can be ordered through your dealer. When ordering, give the following information to the dealer.

- Model No. of your projector : PDG-DSU30
- RS-232C control cable : Service parts No. CH4200272G002

Functional Execution Command

Format

The command is sent from PC to the projector with the format below;

'C' [Command] 'CR'

Command: two characters (refer to the command table below.

- The projector decodes the command and returns the 'ACK' with the format below;

'ACK' 'CR'

- When the projector cannot decode the command, it returns with format below.

'?' 'CR' projector and serial port on the PC.

Command	Function	Command	Function
C00	POWER ON	C30	D.zoom +
C01	POWER OFF (Immediate POWER OFF)	C31	D.zoom -
		C3A	POINTER RIGHT
C05	Computer	C3B	POINTER LEFT
C09	Volume +	C3C	POINTER UP
C0A	Volume -	C3D	POINTER DOWN
C0B	SOUND MUTE ON	C33	VIDEO
C0C	SOUND MUTE OFF	C34	S-VIDEO
C0D	AV MUTE ON	C43	FREEZE ON
C0E	AV MUTE OFF	C44	FREEZE OFF
C0F	Aspect 4:3	C89	AUTO ADJ.
C10	Aspect 16:9-I	C8E	KEystone +
C11	Image mode Presentation	C8F	KEystone -
C12	Image mode Movie		
C13	Image mode sRGB		
C14	Image mode Bright		
C15	Image mode User 1		
C16	Image mode User 2		
C17	Image mode Classroom		
C18	Image mode Blackboard		

Status Read Command

Format

The command is sent from PC to the projector with the format below;

'CR' [Command] 'CR'

Command: one character (refer to the command table below.

- The projector decodes the command and returns the 'Character string' with the format below;

Note

The tables on pages 46~48 show the typical command lists for controlling the projector. Please consult your local dealer for further information of other commands.

Command	Function	Projector Return	Projector status
CR0	Status Read	00	Power ON
		80	Standby mode
CR1	Input Mode Read		
CR3	Lamp Time Read		
CR4	Setting Read		

Dimensions

