

SANYO

Multimedia Projector

MODEL PDG-DXL100

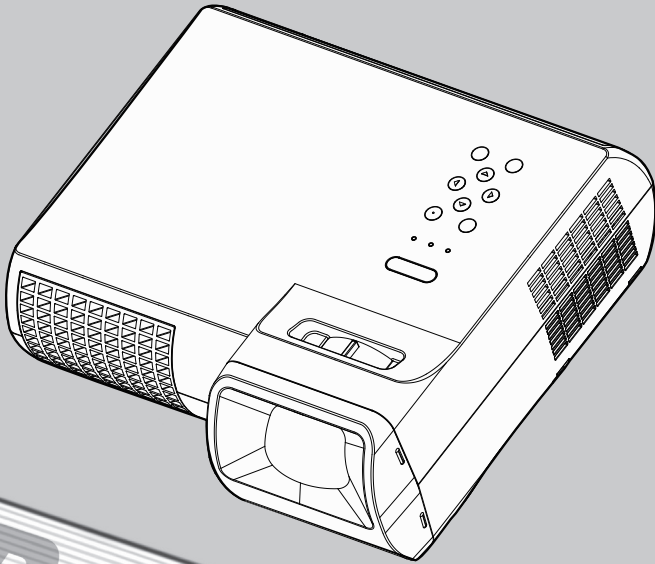

PROJECTOR

Owner's Manual

PJLink™

Table of Contents

Table of Contents

Usage Notice

Precautions.....	2
------------------	---

Introduction

Product Features.....	5
Package Overview.....	6
Product Overview.....	7
Projector.....	7
Connection Ports.....	8
Control Panel.....	8
Remote Control.....	9
Remote Control Battery Installation.....	12
Remote Control Operating Range.....	12

Installation

Connecting the Projector.....	13
Connect to Computer/Notebook.....	13
Connect to Video.....	14
Powering On/Off the Projector.....	15
Powering On the Projector.....	15
Powering Off the Projector.....	16
Warning Indicator.....	17
Adjusting the Projected Image.....	18
Adjusting the Height of Projector Image.....	18
Adjusting the Projector Focus.....	19
Adjusting Projection Image Size.....	19

User Controls

On Screen Display.....	20
How to operate.....	20
Image(PC Mode).....	21
Image(Video Mode).....	23
Screen.....	25
Setting.....	27
Setting/Network.....	30
Language.....	31
Information.....	31
Controlling the Projector From Web.....	32
Configuring the Network Setting.....	32
Home Page.....	35
Control Panel Page.....	36

Network Setting Page.....	37
Security Setting Page.....	38
Alert Setting Page.....	39
Logout Page.....	40

Appendices

Troubleshooting.....	41
Replacing the lamp.....	46
Cleaning the Air Filters.....	48
Specifications.....	49
Computer Compatibility (Analog).....	50
Computer Compatibility (Digital-HDMI).....	51
Configurations of Terminals.....	53
Terminal : Analog RGB (Mini D-sub 15 pin).....	53
Terminal : Mini DIN 8-pin.....	53
Regulation & Safety Notices.....	54
Serial Control Interface.....	56
Operation.....	56
Functional Execution Command.....	57
Status Read Command.....	58
Use of Telnet.....	59
PJLink Notice.....	60
Dimensions.....	61

Usage Notice

Precautions



Follow all warnings, precautions and maintenance as recommended in this user's guide to maximize the life of your unit.

- Warning- This apparatus must be earthed.
- Warning- Do not look into the projector's lens when the lamp is on. The bright light may hurt your eyes.
- Warning- To reduce the risk of fire or electric shock, do not expose this projector to rain or moisture.
- Warning- Please do not open or disassemble the projector as this may cause electric shock.
- Warning- When replacing the lamp, please allow unit to cool down, and follow all replacement instructions..
- Warning- This projector will detect the life of the lamp itself. Please be sure to change the lamp when it shows warning messages.
- Warning- Reset the "Lamp Counter Reset" function from the on-screen display "Setting" menu after replacing the lamp module (refer to page 29).
- Warning- When switching the projector off, please ensure the cooling cycle has been completed before disconnecting power. Allow 120 seconds for the projector to cool down.
- Warning- Do not use lens cap when projector is powered on.
- Warning- Turn on the projector first and then the signal sources.
- Warning- When the lamp reaches the end of its life, it will burn out and may make a loud popping sound. If this happens, the projector will not turn back on until the lamp module has been replaced. To replace the lamp, follow the procedures listed under "Replacing the Lamp".

Usage Notice

■ Warning-

Allowing the proper amount of space on the top, sides, and rear of the projector cabinet is critical for proper air circulation and cooling of the unit. The dimensions shown here indicate the minimum space required. If the projector is to be built into a compartment or similarly enclosed, these minimum distances must be maintained.

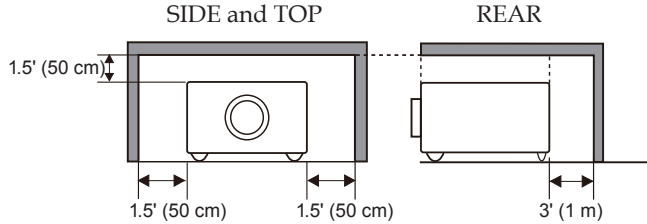

■ Warning-

Avoid positioning the projector as described below when installing.

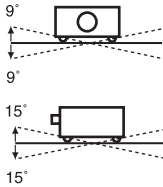

Do not roll the projector more than 9 degrees from side to side.

Do not pitch the projector more than 15 degrees from above and below.



Do not point the projector up to project an image.



Do not point the projector down to project an image.



Do not put the projector on either side to project an image.

Usage Notice

Do:

- Turn off the product before cleaning.
- Use a soft cloth moistened with mild detergent to clean the display housing.
- Disconnect the power plug from AC outlet if the product is not being used for a long period of time.

Do not:

- Block the slots and openings on the unit provided for ventilation.
- Use abrasive cleaners, waxes or solvents to clean the unit.
- Use under the following conditions:
 - Extremely heat, cold or humidity.
 - In areas susceptible to excessive dust and dirt.
 - Near any appliance generating a strong magnetic field.
 - In direct sunlight.

Product Features

This product is an XGA single chip 0.55" DLP® projector. Outstanding features include:

- True XGA, 1024 x 768 addressable pixels
- Single chip DLP® technology
- NTSC3.58/NTSC4.43/PAL(B/D/G/H/I/M/N)/SECAM (B/D/G/K/K1/L) and SDTV(480i/576i), EDTV(480p/576p), HDTV(720p/1080i/1080p) compatible
- Multi-Auto functions: Auto detection, Auto image and Auto saving the adjustments
- Full function remote control
- User friendly multilingual on screen display
- Advanced digital keystone correction and high quality full screen image re-scaling
- Built-in mono 8-Watt speaker.
- UXGA, WXGA, SXGA+, SXGA compression and VGA, SVGA re-sizing
- Macintosh compatible

Introduction

Package Overview

This projector comes with all the items shown below. Check to make sure your unit is complete. Contact your dealer immediately if anything is missing.

Note

❖ Due to the difference in applications for each country, some regions may have different accessories.

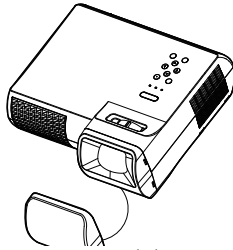

Projector with lens cap



Wireless Remote Control

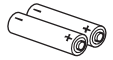

2 x AAA Batteries

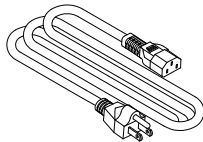

Power Cable

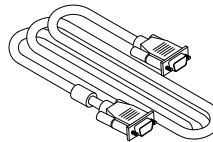

VGA Cable

Cable	Factory code
AC Power Cable (for U.S.A.)	42.00105G011
AC Power Cable (for Continental Europe)	42.00120G011
AC Power Cable (for UK)	42.00110G011
VGA Cable	42.00200G005

Documentation:

- CD-ROM User's Manual
- Quick Reference Guide

Introduction

Product Overview

Projector

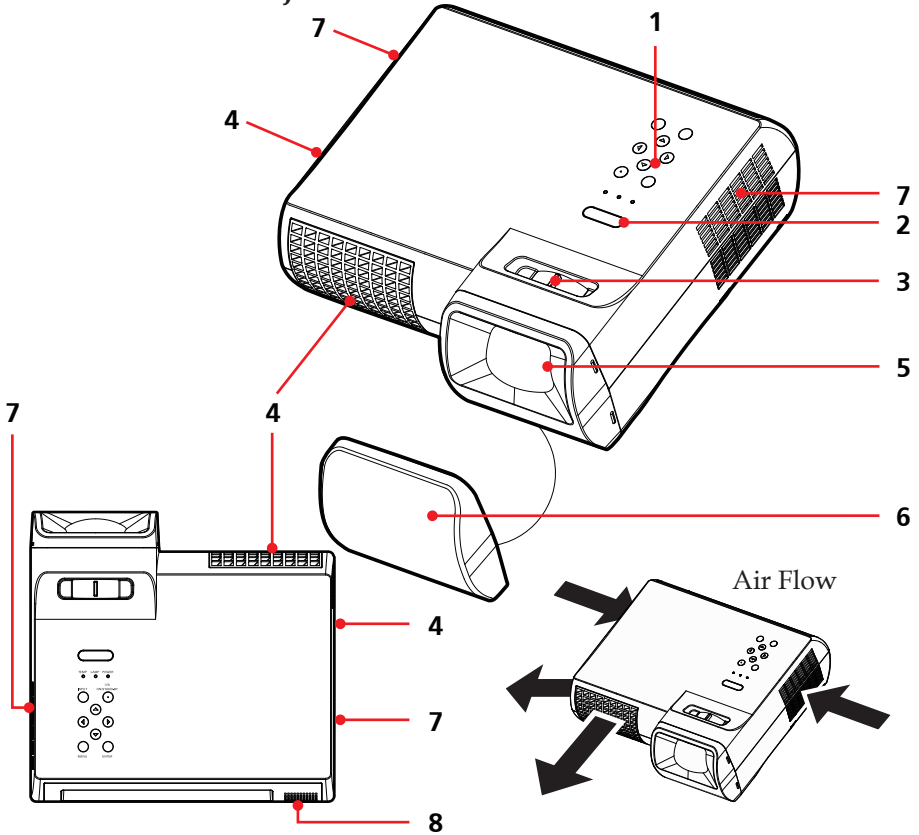

1. Control Panel
2. Remote Sensor
3. Focus Ring
4. Ventilation (outlet)
5. Lens
6. Lens Cap (with String)
7. Ventilation (inlet)
8. Speaker

Introduction

Connection Ports

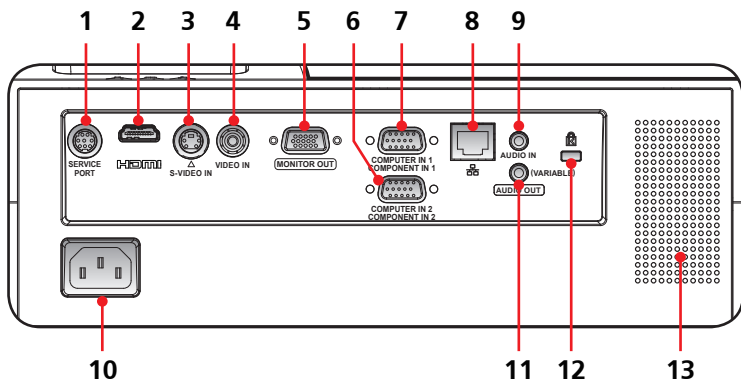

1. SERVICE Port
2. HDMI Port
3. S-VIDEO IN Connector
4. VIDEO IN Connector
5. MONITOR OUT Connector
6. COMPUTER IN 2/
COMPONENT 2 Con-
nector
7. COMPUTER IN 1/
COMPONENT 1 Con-
nector
8. Network Port
9. AUDIO IN Jack
10. AC IN
11. AUDIO OUT Jack
12. Kensington™ Lock Port
13. Speaker

Control Panel

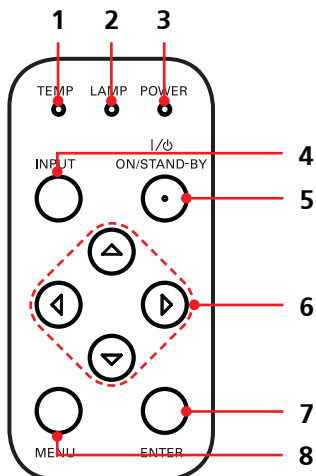

1. TEMP LED
2. LAMP LED
3. POWER LED
4. INPUT Button
5. ON/STAND-BY Button
6. Four Directional Select
Keys
7. ENTER Button
8. MENU Button

Introduction

Remote Control

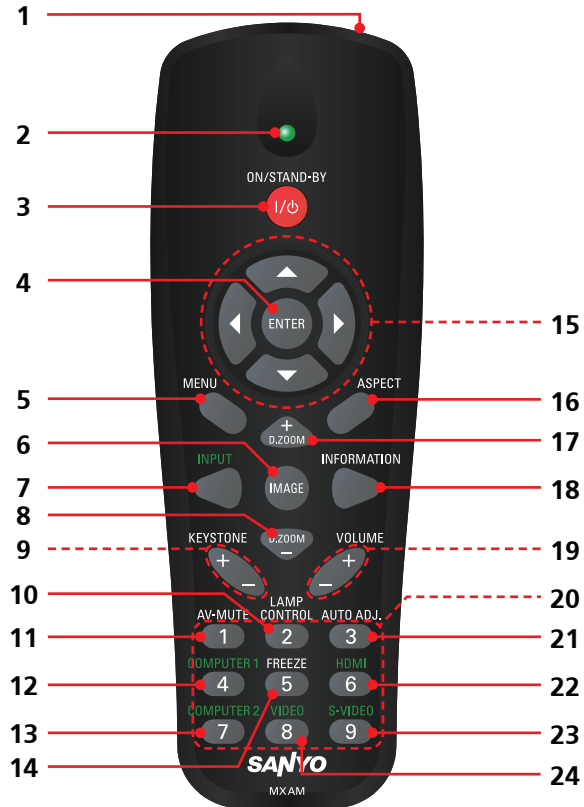

1	Infrared transmitter	Sends signals to the projector.
2	Infrared indicator	Signals indicator for sending.
3	ON/STAND-BY	Refer to the "Power On/Off the Projector" section. (See pages 15~16)
4	ENTER	Confirm your section of items in sub menu operation.

Introduction

Note

❖ To quick change remote control code, press "MENU" and "IMAGE" buttons about 10 seconds at the same time.

5	MENU	Press "MENU" to launch the On-screen display (OSD), back to the top level of OSD for the OSD main menu operation
6	IMAGE	Select the Image mode from Presentation, Movie, sRGB, Bright and User.
7	INPUT	Press "INPUT" to choose RGB, SCART, Component, S-Video, Composite and HDMI sources.
8	D.ZOOM -	Zoom out the projector display.
9	KEYSTONE +/-	Adjust the image to compensate for distortion caused by tilting the projector.
10	LAMP CONTROL	Select the lamp mode. (refer "ECO Mode" function)
11	AV-MUTE	Momentarily turn off/on the audio and video.
12	COMPUTER 1	Press "COMPUTER 1" to choose Computer in 1/Component in 1 connector.
13	COMPUTER 2	Press "COMPUTER 2" to choose Computer in 2/Component in 2 connector.
14	FREEZE	Pause the screen image. Press again to resume the screen image.
15	Four Directional Select Keys	Use ▲ or ▼ or ◀ or ▶ to select items or make adjustments to your selection.
16	ASPECT	Display the "Aspect Ratio" section of the on-screen display menu to select the desired aspect ratio.
17	D.ZOOM +	Zoom in the projector display.
18	INFORMATION	Display information menu.

Introduction

19	VOLUME +/-	Increase/decrease speaker volume.
20	Keypad 1~9	For input a password in the "Security settings".
21	AUTO. ADJ	Automatically synchronize the projector to the input source.
22	HDMI	Press "HDMI" to choose HDMI connector.
23	S-VIDEO	Press "S-VIDEO" to choose S-Video connector.
24	VIDEO	Press "VIDEO" to choose Video connector.

Introduction

Remote Control Battery Installation

- 1 Open the battery compartment lid.

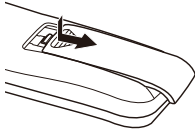

- 2 Install new batteries into the compartment.

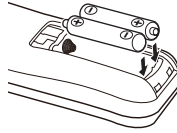

Two AAA size batteries
For correct polarity (+ and -), be sure battery terminals are in contact with pins in the compartment.

- 3 Replace the compartment lid.

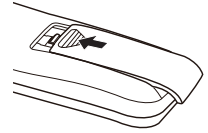

To ensure safe operation, please observe the following precautions :

- Use two (2) AAA type batteries.
- Always replace batteries in sets.
- Do not use a new battery with a used battery.
- Avoid contact with water or liquid.
- Do not expose the remote control to moisture or heat.
- Do not drop the remote control.
- If the battery has leaked on the remote control, carefully wipe the case clean and install new batteries.
- Risk of an explosion if battery is replaced by an incorrect type.
- Dispose of used batteries according to the instructions.
- If the new battery are installed into the compartment within 3~4 hours, the remote control code will not be returned to default.
- The original setting will be kept and will not be erased.

Note

- ❖ Infrared Remote Receiver is provided on the top of the projector.
- ❖ Point the remote control from obliquely above toward the Infrared Remote Receiver when operating the remote control.

Remote Control Operating Range

Point the remote control toward the projector (Infrared Remote Receiver) when pressing any button. Maximum operating range for the remote control is about 39.4' (12m) and 60° above top of the projector.

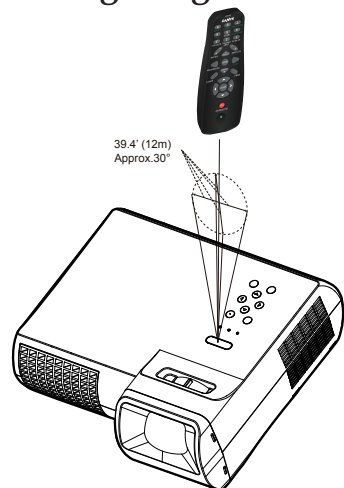

Connecting the Projector

Connect to Computer/Notebook

VGA, DVI



Audio Output

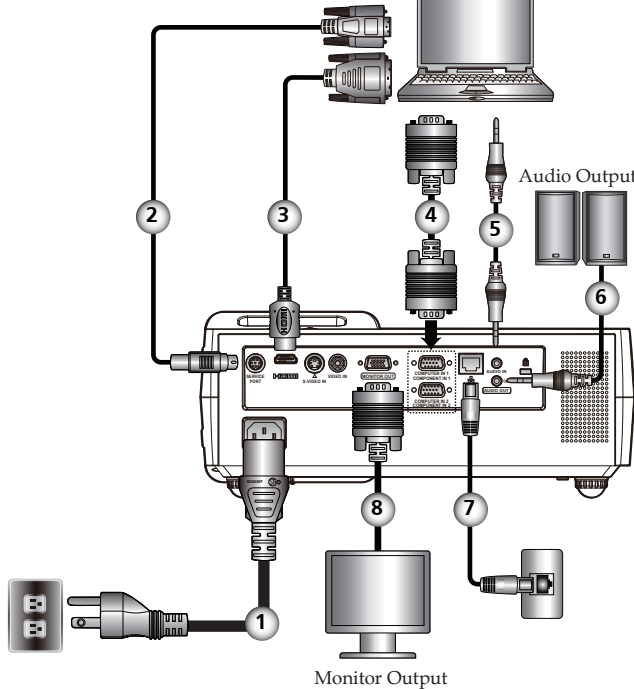

Monitor Output

Note

- ❖ Make sure that the power plug is fully inserted into both the projector AC inlet and the wall outlet.
- ❖ The AC outlet must be near this equipment and must be easily accessible.

Note

- ❖ Due to the difference in applications for each country, some regions may have different accessories.
- ❖ When AUDIO OUTPUT is plugged-in, the projector's built-in speaker is not available.

1.....	Power cable (supplied)
2.....	RS232 cable
3.....	HDMI-DVI cable
4.....	VGA cable (supplied)
5.....	Audio in cable jack to jack
6.....	Audio out cable jack to jack
7.....	Network cable
8.....	Monitor out cable

- ❖ To ensure the projector works well with your computer, please make sure the timing of the display mode is compatible with your projector.

Installation

Note

- ❖ Make sure that the power plug is fully inserted into both the projector AC inlet and the wall outlet.
- ❖ The AC outlet must be near this equipment and must be easily accessible.
- ❖ Other than the analog RGB signal, COMPUTER IN 1/2-COMPONENT IN 1/2 Connectors can be used to project the incoming Component and RGB Scart signals. (See Page 49 for the Optional Parts.)

Note

- ❖ Due to the difference in applications for each country, some regions may have different accessories.
- ❖ When AUDIO OUTPUT is plugged-in, the projector's built-in speaker is not available.

Connect to Video

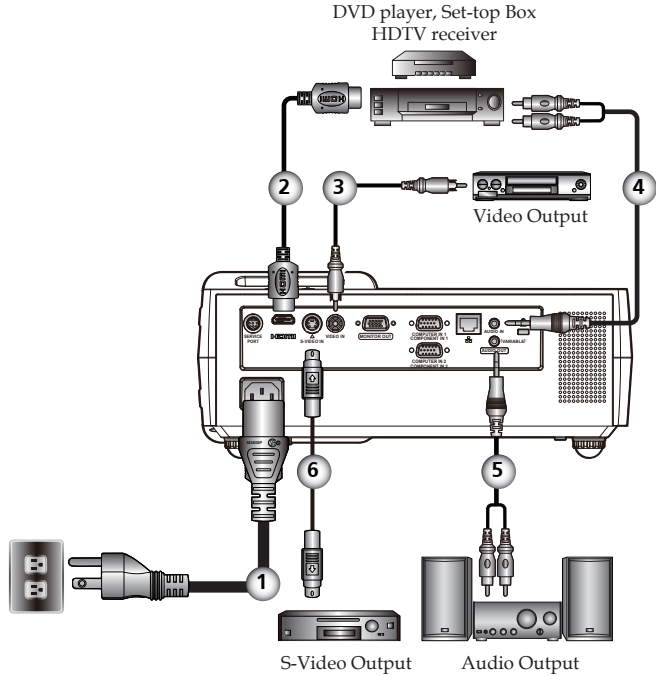

- | | |
|--------|------------------------------|
| 1..... | Power cable (supplied) |
| 2..... | HDMI cable |
| 3..... | Composite video cable |
| 4..... | Audio in cable jack to jack |
| 5..... | Audio out cable jack to jack |
| 6..... | S-Video cable |

- ❖ To ensure the projector works well with your computer, please make sure the timing of the display mode is compatible with your projector.

Powering On/Off the Projector

Powering On the Projector

1. Ensure that the power cable and signal cable are securely connected. The POWER LED will turn orange.
 2. Remove the lens cap. ❶
 3. Turn on the lamp by pressing “ON/STAND-BY” on the control panel. ❷ The POWER LED will now flash green. The startup screen will display in approximately 5 seconds. When disappear startup screen, the POWER LED will turn green.
 4. Turn on your source (computer, notebook, video player, etc.) The projector will detect your source automatically.
- ❖ If you connect multiple sources at the same time, use the “INPUT” on the remote control or use “COMPUTER 1”, “COMPUTER 2”, “S-VIDEO”, “VIDEO”, “HDMI” on the remote control to switch inputs.

Note

❖ Turn on the projector first and then the signal sources.

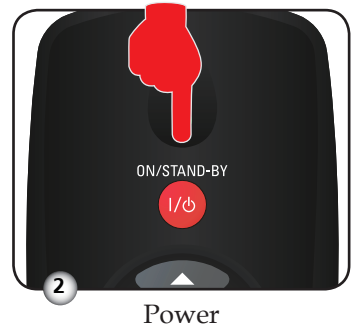
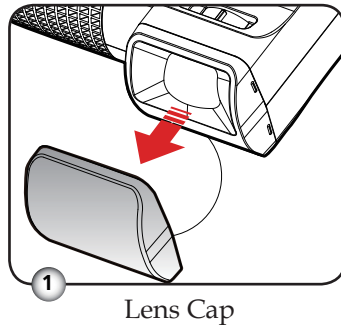

Powering Off the Projector

1. Press the “ON/STAND-BY” to turn off the projector lamp, you will see a message as below on the on-screen display.

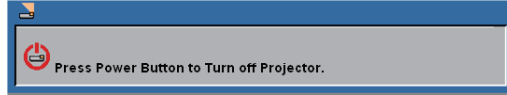

2. Press the “ON/STAND-BY” again to confirm.
3. The cooling fan continues to operate for about 60 seconds for cooling cycle and the POWER LED will flash green. When the light starts flashing orange, the projector has entered standby mode.

If you wish to turn the projector back on, you must wait until the projector has completed the cooling cycle and has entered standby mode. Once in standby mode, simply press “ON/STAND-BY” to restart the projector.

4. Disconnect the power cable from the electrical outlet and the projector.
5. Do not turn on the projector immediately following a power off procedure.

Warning Indicator

- ❖ When the “TEMP” LED indicator turns red, it indicates the projector has overheated. The projector will automatically shut itself down.



- ❖ When you see the message below displays on-screen, the projector has detected that the lamp is approaching its end of life. Please change the lamp as soon as possible or contact your local dealer or our service center.



- ❖ When the “TEMP” LED indicator flashes red and the message below displays on-screen, it indicates the fan failed. Stop using the projector and disconnect the power cable from the electrical outlet, then contact your local dealer or our service center.



Installation

Adjusting the Projected Image

Adjusting the Height of Projector Image

The projector is equipped with adjustable feet to raise and lower the image to fill the screen.

To raise/lower the image:

1. Use ① to fine-tune the display angle.

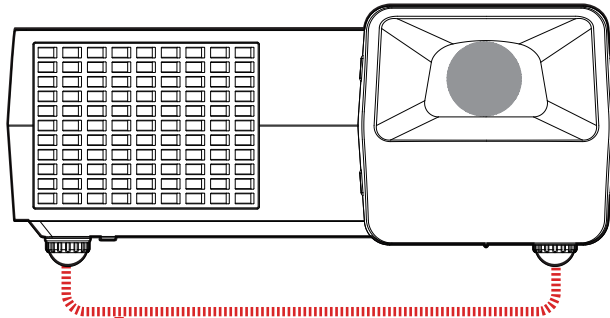

Note

❖ You can raise the projector front up to 3 degrees by rotating the adjustable feet.

Front Adjustable feet ①
Maximum Length:7mm

Rear Adjustable feet ①
Maximum Length:2mm

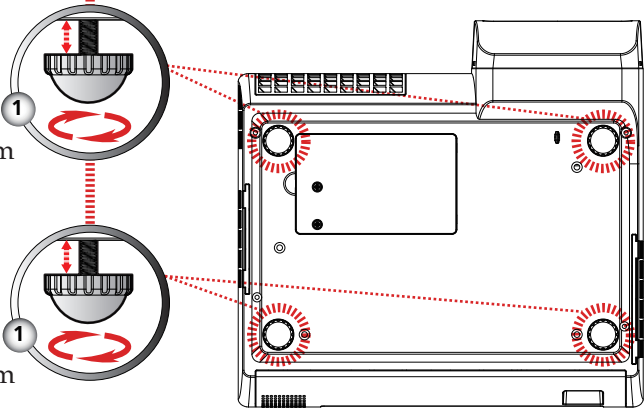

Installation

Adjusting the Projector Focus

To focus the image, rotate the focus ring until the image is clear. The projector will focus at distances from 1.62 to 12.46 feet (0.5 to 3.8 meters) with mechanical travel.

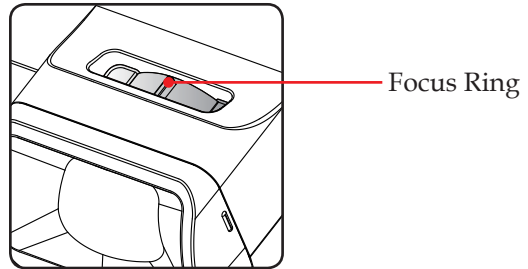

Adjusting Projection Image Size

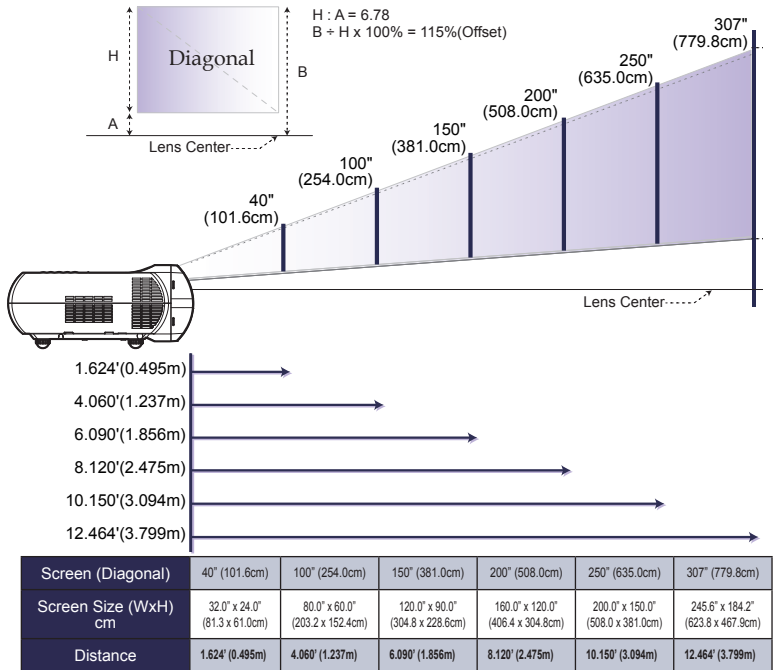

❖ This graph is for user's reference only.

On Screen Display

The Projector has a multilingual On Screen Display that allows you to make image adjustments and change a variety of settings. The projector will automatically detect the source.

How to operate

1. To open the OSD, press "MENU" on the Remote Control.
2. When OSD is displayed, use ◀ ▶ keys to select any item in the main menu. While making a selection on a particular page, press ▼ key to enter sub menu.
3. Use ▲ ▼ keys to select the desired item in the sub menu and adjust the settings by ◀ ▶ key.
4. If the setting has ↵ icon, you could press "ENTER" to enter another sub menu. Press "MENU" to close the sub menu after adjustment.
5. After adjusting the settings, press "MENU" go back to the main menu.
6. To exit, press "MENU" again. The OSD will be closed and the projector will automatically save the new settings.

Note

❖ If no button operation is made for 30 seconds, the OSD will be closed automatically.

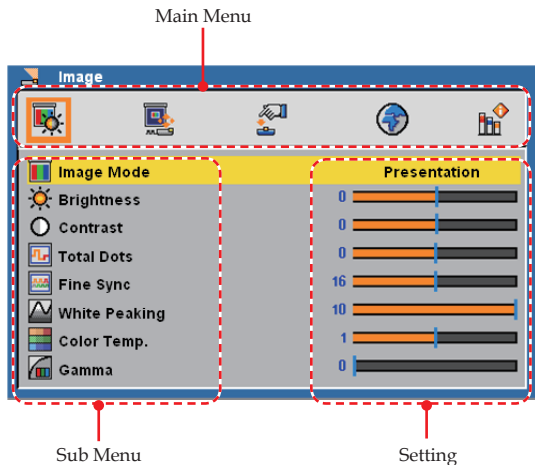

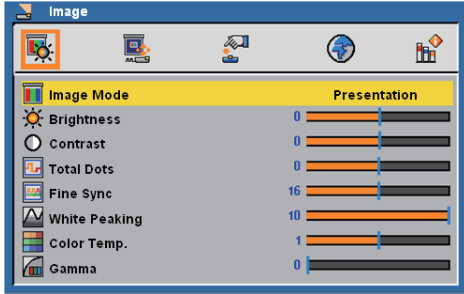

Image (PC Mode)

Image Mode

There are many factory presets optimized for various types of images. Use the ◀ or ▶ to select the item.

- ▶ Presentation: For computer or notebook.
- ▶ Movie: For home theater.
- ▶ sRGB: For standard color.
- ▶ Bright: For bright room.
- ▶ User: Memorize user's settings.

Note

❖ When no signal is detected, the "Image" menu cannot be selected.

❖ The image Mode will change into "User" by adjusting the items.

Brightness

Adjust the brightness of the image.

- ▶ Press the ◀ to darken image.
- ▶ Press the ▶ to lighten the image.

Contrast

The contrast controls the degree of difference between the lightest and darkest parts of the picture. Adjusting the contrast changes the amount of black and white in the image.

- ▶ Press the ◀ to decrease the contrast.
- ▶ Press the ▶ to increase the contrast.

Total Dots

Adjust the number of total dots in one horizontal period. Use the ◀ or ▶ to adjust number to match your PC image.

User Controls

Fine Sync

Eliminate flicker from the image displayed. Use the ◀ or ▶ to adjust the value.

White Peaking

Use the white peaking control to set the white peaking level of DMD chip. 0 stands for minimal peaking, and 10 stands for maximum peaking. If you prefer a stronger image, adjust towards the maximum setting. For a smooth and more natural image, adjust towards the minimum setting.

Color Temp.

Adjust the color temperature. At higher temperature, the screen looks colder; at lower temperature, the screen looks warmer.

Gamma

This allows you to choose a gamma table that has been fine-tuned to bring out the best image quality for the input.

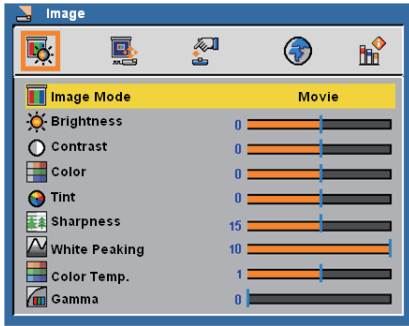

Image (Video Mode)

Image Mode

There are many factory presets optimized for various types of images. Use the ◀ or ▶ to select the item.

- ▶ Presentation: For computer or notebook.
- ▶ Movie: For home theater.
- ▶ sRGB: For standard color.
- ▶ Bright: For bright room.
- ▶ User: Memorize user's settings.

Brightness

Adjust the brightness of the image.

- ▶ Press the ◀ to darken image.
- ▶ Press the ▶ to lighten the image.

Contrast

The contrast controls the degree of difference between the lightest and darkest parts of the picture. Adjusting the contrast changes the amount of black and white in the image.

- ▶ Press the ◀ to decrease the contrast.
- ▶ Press the ▶ to increase the contrast.

Color

Adjust a video image from black and white to fully saturated color.

- ▶ Press the ◀ to decrease the amount of color in the image.
- ▶ Press the ▶ to increase the amount of color in the image.

Note

❖ When no signal is detected, the "Image" menu cannot be selected.

❖ The image Mode will change into "User" by adjusting the items.

User Controls

Tint

Adjust the color balance of red and green.

- ▶ Press the ◀ to increase the amount of green in the image.
- ▶ Press the ▶ to increase the amount of red in the image.

Sharpness

Adjust the sharpness of the image.

- ▶ Press the ◀ to decrease the sharpness.
- ▶ Press the ▶ to increase the sharpness.

White Peaking

Use the white peaking control to set the white peaking level of DMD chip. 0 stands for minimal peaking, and 10 stands for maximum peaking. If you prefer a stronger image, adjust towards the maximum setting. For a smooth and more natural image, adjust towards the minimum setting.

Color Temp.

Adjust the color temperature. At higher temperature, the screen looks colder; at lower temperature, the screen looks warmer.

Gamma

This allows you to choose a gamma table that has been fine-tuned to bring out the best image quality for the input.

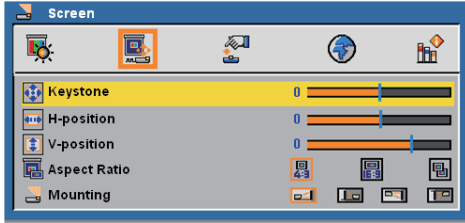

Screen

Keystone

Adjust image distortion caused by tilting projector.

H-position (Horizontal Position)



- ▶ Press the ◀ to move the image left.
- ▶ Press the ▶ to move the image right.

V-position (Vertical Position)

- ▶ Press the ◀ to move the image down.
- ▶ Press the ▶ to move the image up.

Aspect Ratio

Use this function to choose your desired aspect ratio.

- ▶  4:3
This format is for 4:3 input sources not enhanced for Wide-screen TV.
- ▶  16:9
This format is for 16:9 input sources, like HDTV and DVD enhanced for Widescreen TV.
- ▶  Native
This format displays the original image without any scaling.

Mounting

- ▶  Front-Desktop

The factory default setting.

- ▶  Rear-Desktop

When you select this function, the projector reverses the image so you can project behind a translucent screen.

- ▶  Front-Ceiling

When you select this function, the projector turns the image upside down for ceiling-mounted projection.

- ▶  Rear-Ceiling

When you select this function, the projector reverses and turns the image upside down at same time. You can project from behind a translucent screen with ceiling mounted projection.

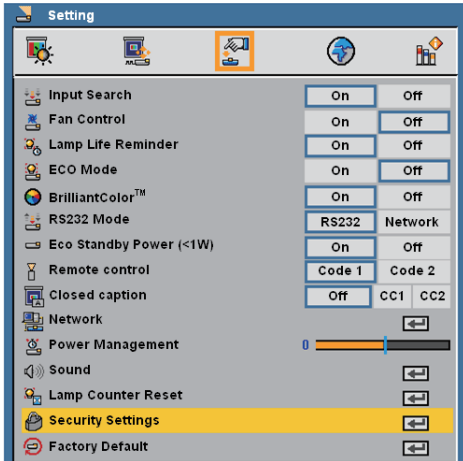

Setting

Input Search

When this function is turned “On”, the projector will search for other signals if the current input signal is lost. When this function is turned “Off”, it will only search a specified connection port.

Fan Control

Choose “On” to turn on Fan Control mode. Operate the fan at full speed continuously to allow for proper high altitude cooling of the projector.

Lamp Life Reminder

Choose this function to show or to hide the lamp end of life warning message.

ECO Mode

Choose “On” to dim the projector lamp which will lower power consumption and extend the lamp life. Choose “Off” to return to normal mode.

BrilliantColor™

Choose “On” to provide true, more vibrant colors.

RS232 Mode

- ▶ RS232: Allow RS232 control of an individual projector.
- ▶ Network: Allow network LAN via web browser (Internet Explorer) to control of projector.

User Controls

Note

❖ Please turn this function "Off", if you want to turn on "Power" by network during standby mode.

Note

❖ After keystone adjustment, maybe need to re-adjust screen again during display the closed caption.

Eco Standby Power (<1W)

This function is available when the projector is turned off and in Stand-by. It is recommended to use Eco under normal condition.

- ▶ On: lower power consumption than Normal mode in Stand-by condition.
- ▶ Off: normal power consumption in Stand-by condition.

Remote Control

This projector provides two different remote control codes: the factory-set initial code (Code 1) and the secondary code (Code 2). This switching function prevents remote control interference when operating several projectors or video equipment at the same time. When operating the projector in "Code 2", both the projector and the remote control must be switched to "Code 2".

- To change the code for the projector:
Select either "Code 1" or "Code 2" in this Setting Menu.
- To change the code for the remote control:
Press and hold both the MENU and IMAGE buttons together for 10 seconds or more. After changing the code, make sure the remote control operates properly.

Closed Caption

This function is a printed version of the program sound or other information displayed on the screen. If the input signal contains closed captions, you can turn on the feature and switch the channels. Use the ◀ or ▶ to select Off, CC1, CC2.

Power Management

Set the interval of power-off of the system, if there is no signal input. (minutes/unit)

Sound

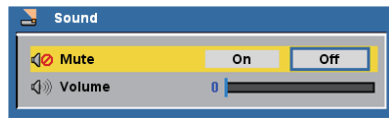

- ▶ Mute:
 - Choose "On" to mute the volume.
 - Choose "Off" to restore the volume.

User Controls

- ▶ Volume:
 - Press the ◀ to decrease the volume.
 - Press the ▶ to increase the volume.

Lamp Counter Reset

Reset the lamp life hour after replacing a new lamp.

Security Settings

- ▶ Security Settings:
 - On: Choose “On” to enable security verification when turning on the projector.
 - Off: Choose “Off” to be able to switch on the projector without password verification.
- ▶ Change Password:
 - First Time:
 1. Press “ENTER” to set the password.
 2. Use number buttons to enter default password and then press “ENTER” to confirm.
 3. Use number buttons on the remote to enter your new password and then press “ENTER” to confirm. (The password has to be 4 digits.)
 4. Enter new password again and press “ENTER” to confirm.
 - Change Password:
 1. Press “ENTER” to input old password.
 2. Use number buttons to enter current password and then press “ENTER” to confirm.
 3. Enter new password (4 digits in length) using the number buttons on the remote, then press “ENTER” to confirm.
 4. Enter new password again and press “ENTER” to confirm.



Note

❖ Password default value is “1234” (first time).

❖ If you input incorrect password 3 times, the projector will automatically shut itself down and enter into standby mode.

Factory Default

Return the adjustments and settings to the factory default values. (except for lamp counter, security setting and language)

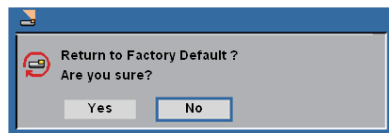

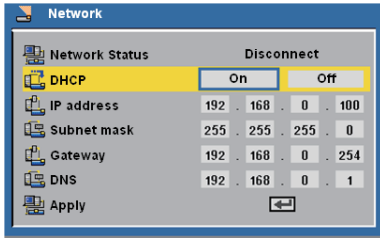

Setting/Network

Network Status

Display the network connection status.

DHCP

Display the network connection status.

- ▶ On: Assign an IP address to the projector from the DHCP server automatically.
- ▶ Off: Assign an IP address manually.

IP Address

Select an IP address.

Subnet Mask

Select subnet mask number.

Gateway

Select the default gateway of the network connected to the projector.

DNS

Select DNS number.

Apply

Press "ENTER" button to apply the selection.



Language

Language

Note

❖ In the first instance of powering on the projector, the language menu is displayed to select the default language. All subsequent operations assume the selected default language.

Choose the multilingual OSD. Press ▼ into the sub menu and then use the ▲ or ▼ or ◀ or ▶ key to select your preferred language. Press “ENTER” to finalize the selection.

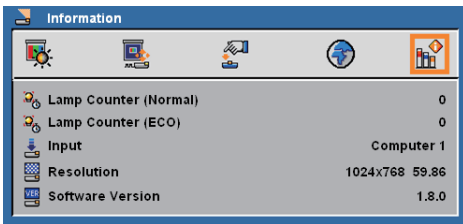

Information

Information

To display the projector information on the screen.

Controlling the Projector From Web

Configuring the Network Setting

1. Fill in a new IP, a subnet mask, a gateway and a DNS in the dialogue box.

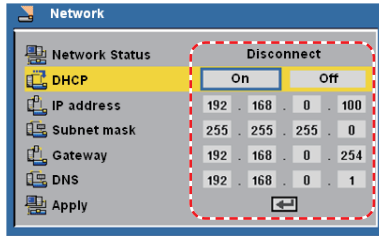

2. Then choose apply and press “ENTER” button to effectuate the configuration process.
3. Open your web browser and type in the IP address, it has entered LOGIN mode.

Note

- (1) User name:user / Password:user
- (2) User name: administrator / Password: admin

Remark: Only administrator could enter the Network setting and alert setting.

4. Input the user name and password then press “LOGIN” button on the screen, the web page will display as below:

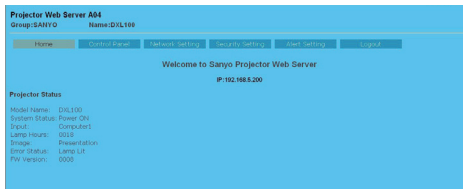

5. Open “Control Panel” to control your projector.

Note

When you used the projector IP address, you will can not link to your service server.



User Controls

For example: Use Microsoft Internet Explorer (IE) web browser to control the projector, the IP address is http://192.168.0.100.

Step 1: Find an IP Address (192.168.0.250) from LAN function of projector.

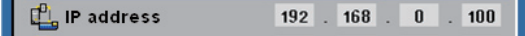

Step 2: Select apply and press “ENTER” button to submit function or press “MENU” key to exit.

Step 3: To open Network Connections, click **Start**, click **Control Panel**, click **Network and Internet Connections**, and then click **Network Connections**. Click the connection you want to configure, and then, under **Network Tasks**, click **Change settings of this connection**.

Step 4: On the General tab, under This connection uses the following items, click Internet Protocol (TCP/IP), and then click “Properties.”

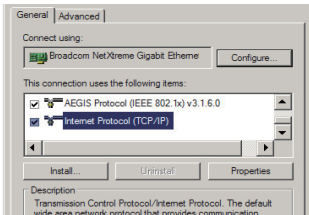

Step 5: Click **Use the following IP address**, and type in as below:

- 1) IP address: 192.168.0.250
- 2) Subnet mask: 255.255.255.0
- 3) Default gateway: 168.0.254.192

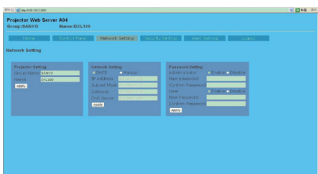

Step 6: To open Internet Options, click IE web browser, click Internet Options, click the **Connections** tab and click “LAN Settings...”

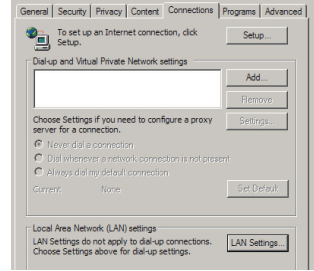

Step 7: The **Local Area Network (LAN) Setting** dialog box appears, In the **Proxy Server** area, cancel the **Use a proxy server for your LAN** check box., then click “OK” button twice.

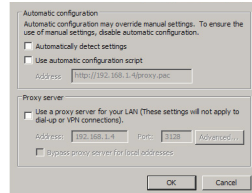

Step 8: Open your IE and type in the IP address of 192.168.0.250 in the URL then press “ENTER” key. It has entered LOGIN mode as below:

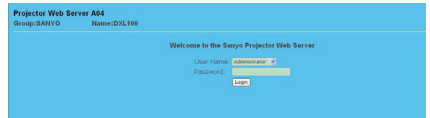

- 1) User name: user / Password: user
- 2) User name: administrator / Password: admin

Note Only administrator could enter the Network setting and alert setting.

User Controls

Step 9: The web page will display as below:



Step 10: Open "Control Panel" to control your projector.



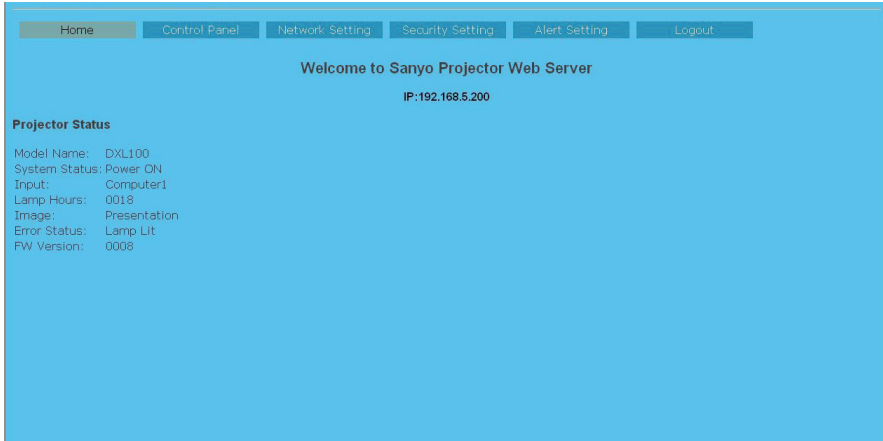

Home Page

Access the Projector Web Server by entering the projector's IP address at the web browser. The Home Page displays basic information about the projector.



❖ When Home page display error status, it indicates the lamp failed. Stop using the projector and disconnect the power cable from the electrical outlet, then contact your local dealer or our service center.

User Controls



Control Panel Page

This page allows you to manage the projector status using a Web browser.

How to operate Control Panel page

- ▶ Button setting: Action.



Note

The value in the text box indicates current value.

- ▶ Text box setting: Enter a number or text and then click "Set" button. Or Change a value with "-" or "+" button.

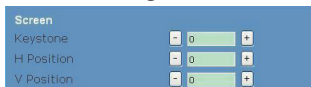

- ▶ Pull-down menu setting: Select an item with pull-down menu button and then click "Set" button.

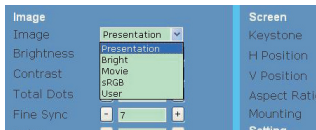

Note

Each item has a valid setting range. The setting value exceeding this becomes invalid. Some control items can not be used depending on the selecting input mode or functions of the projector you use. In this case, the values of those items are indicated with "---".

- ▶ Radio button setting: Select an item by selecting a radio button.



Home Control Panel **Network Setting** Security Setting Alert Setting Logout

Network Setting

Projector Setting
Group Name SANYO
Name DXL100
Apply

Network Setting
 DHCP Manual
IP Address 192.168.5.200
Subnet Mask 255.255.255.0
Gateway 192.168.5.254
DNS Server 192.168.1.167
Apply

Password Setting
Administrator Enable Disable
New password
Confirm Password
User Enable Disable
New Password
Confirm Password
Apply

Network Setting Page

This page allow you to enable or disable DHCP and set network related addresses and names.

Projector Setting

Allows you to define the group name and projector name of the projector. (Maximum characters: 12).

Network Setting

Choose DHCP to assign an IP address to the projector from a DHCP server automatically, or Manual to assign an IP address manually.

- ▶ Network function setting, Refer to the “Network” section on page 30 for more information.

Password Setting

This projector provides a security function that allows the administrator or user to manage usage for the projector. When enabling password for the first time, set the password before enabling it.

When the password function is enabled, the administrator or user password will be required for accessing the Web Server.

- ▶ New Password: Enter new password.
- ▶ Confirm Password: Enter password again and submit.

User Controls

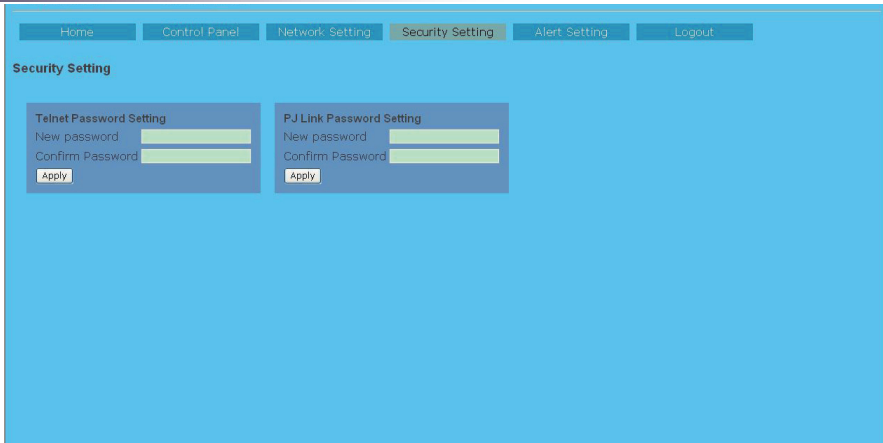

Security Setting Page

This page allow you control the projector by using the telnet or PJLink application installed on your computer.

- ▶ New Password: Enter new password.
- ▶ Confirm Password: Enter password again and submit.

Telnet Password Setting

- ▶ Only a four-digit number is valid for the telnet password.
- ▶ The default Telnet Password as [0000], which means no password is set.
- ▶ When you connect the projector to the network, it is recommended to set a new password.
- ▶ If the password has been set on this Security Setting Page, the authentication is required to use the Telnet.

PJLink Password Setting

- ▶ 1 to 32 alphanumeric characters can be used for the password.
- ▶ The default PJLink Password is vacant, which means no password is set.

Home Control Panel Network Setting Security Setting **Alert Setting** Logout

Alert Setting

Email Setting

To user@mailserver.com

Cc cc@mailserver.com

Subject Project alert

From alert@coretronic.com

SMTP Setting

Server mailserver.com

User Name

Password

Alert Condition

Thermal Switch Error

Fan Lock

Over Temperature

Lamp Hours Running Out

Lamp Fail

Submit Email Alert Test

Alert Setting Page

Email Setting

- ▶ E-mail Alert: You can set whether to be notified by email (Enable) or not (Disable).
- ▶ To/CC/From: You can enter email address of sender (From) and recipients (To/Cc) to receive notification when an abnormality or warning occurs.
- ▶ Subject: You can enter the subject line of the email.

Click the “Email Alert Test” button to test the e-mail alert settings.

SMTP Setting

SMTP server, User name and Password should be provided by your network administrator or MIS.

Alert Condition

You can select the abnormalities or warnings to be notified by email. Select items by ticking on check boxes. When any of the alert conditions occur, an email will be sent to the recipients (To/Cc).

Click the “Submit” button to apply the selection.

User Controls

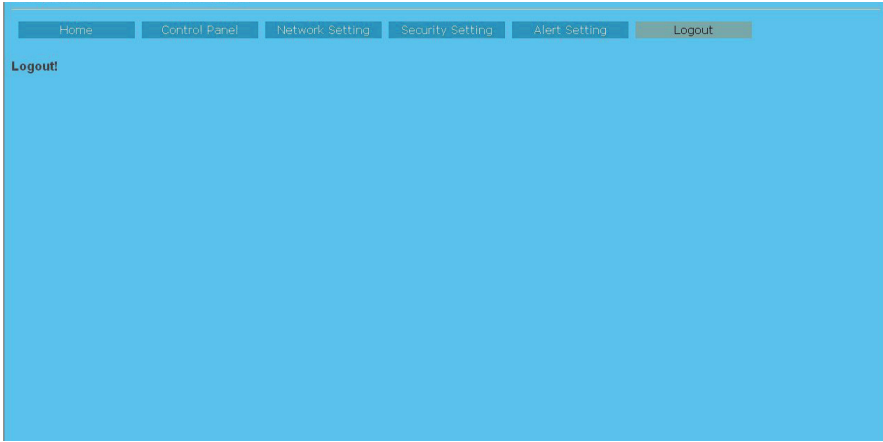

Logout Page

When you use this page, the projector system will go back Login mode.



Troubleshooting

If you experience trouble with the projector, refer to the following information. If the problem persists, please contact your local dealer or service center.

Problem: No image appears on screen

- ▶ Ensure all the cables and power connections are correctly and securely connected as described in the “Installation” section.
- ▶ Ensure the pins of connectors are not crooked or broken.
- ▶ Check if the projection lamp has been securely installed. Please refer to the “Replacing the lamp” section.
- ▶ Make sure you have removed the lens cap and the projector is switched on.
- ▶ Ensure that the “AV-MUTE” feature is not turned on.

Problem: Partial, scrolling or incorrectly displayed image

- ▶ Press “Auto Adj.” on the remote control.
- ▶ If you are using a PC:

For Windows 95, 98, 2000, XP:

1. From the “My Computer” icon, open the “Control Panel” folder, and double click the “Display” icon.
2. Select the “Settings” tab
3. Click on the “Advanced Properties”.

For Windows Vista:

1. From the “My Computer” icon, open the “Control Panel” folder, and double click the “Appearance and Personalization”
2. Select “Personalization”
3. Click “Adjust screen resolution” to display “Display Settings”. Click on the “Advanced Settings”.

If the projector is still not projecting the whole image, you will also need to change the monitor display you are using. Refer to the following steps.

Appendices

4. Verify the resolution setting is less than or equal to 1600 x 1200 resolution.
 5. Select the "Change" under the "Monitor" tab .
 6. Click on "Show all devices". Next, select "Standard monitor types" under the SP box; choose the resolution mode you need under the "Models" box.
- ▶ If you are using a Notebook:
1. First, follow the steps above to adjust resolution of the computer.
 2. Press the toggle output settings. example: [Fn]+[F4]

Compaq=>	[Fn]+[F4]	Hewlett	
Dell =>	[Fn]+[F8]	Packard =>	[Fn]+[F4]
Gateway=>	[Fn]+[F4]	NEC=>	[Fn]+[F3]
IBM=>	[Fn]+[F7]	Toshiba =>	[Fn]+[F5]

Macintosh Apple:
System Preference-->Display-->Arrangement-->Mirror display

- ▶ If you experience difficulty changing resolutions or your monitor freezes, restart all equipment including the projector.

Problem: The screen of the Notebook or PowerBook computer is not displaying a presentation

- ▶ If you are using a Notebook PC:

Some Notebook PCs may deactivate their own screens when a second display device is in use. Each has a different way to be reactivated. Refer to your computer's documentation for detailed information.

Problem: Image is unstable or flickering

- ▶ Adjust the "Fine sync" or "Total Dots" to correct it. Refer to the "Image" section for more information.
- ▶ Change the monitor color setting from your computer.

- ▶ Check and reconfigure the display mode of your graphic card to make it compatible with the product.

Problem: Image is out of focus

- ▶ Adjust the Focus Ring on the projector lens.
- ▶ Make sure the projection screen is between the required distance 1.62 to 12.46 feet (0.5 to 3.8 meters) from the projector (refer to page 19).

Problem: The image is stretched when displaying 16:9 DVD

The projector automatically detects 16:9 DVD and adjusts the aspect ratio by digitizing to full screen with 4:3 default setting.

If the image is still stretched, you will also need to adjust the aspect ratio by referring to the following:

- ▶ Please select 4:3 aspect ratio type on your DVD player if you are playing a 16:9 DVD.
- ▶ If you can't select 4:3 aspect ratio type on your DVD player, please select 4:3 aspect ratio in the on screen menu.

Problem: Image is reversed





















- ▶ Select "Setting-->Mounting" from the OSD and adjust the projection direction.

Problem: Lamp burns out or makes a popping sound

- ▶ When the lamp reaches its end of life, it will burn out and may make a loud popping sound. If this happens, the projector will not turn on until the lamp module has been replaced. To replace the lamp, follow the procedures in the "Replacing the Lamp".

Appendices

Problem: LED lighting message

Message	POWER-LED			TEMP-LED	LAMP-LED
	(Red)	(Green)	(Orange)	(Red)	(Red)
Standby (Input power cable)					
Normal (Power on)					
Powering up (Warming up)		Flashing			
Power off (Cooling-I: It can't accept any key at this status)		Flashing			
Power off (Cooling-II: It can accept power key to turn on the projector)			Flashing		
Error (Lamp failed)					
Error (Fan lock)				Flashing	
Error (Over temp.)					

Note

Steady light => 

No light => 

*=> When LED light on after 5 sec., go to standby mode.

Problem: Message Reminders

- ▶ Over temperature - the projector has exceeded its recommended operating temperature and must be allowed to cool down before it may be used.



- ▶ Replacing the lamp - the lamp is about to reach its maximum life-time. Prepare to replace it soon.



- ▶ Fan failed - the system fan is not working.



- ▶ Setting network



- ▶ Loading network



Replacing the lamp

The projector will detect the lamp life itself. It will show you a warning message



Warning: To avoid burns, allow the projector to cool for at least 60 minutes before you replace the lamp!



When you see this message, change the lamp as soon as possible. Make sure the projector has been cooled down for at least 60 minutes before changing the lamp.

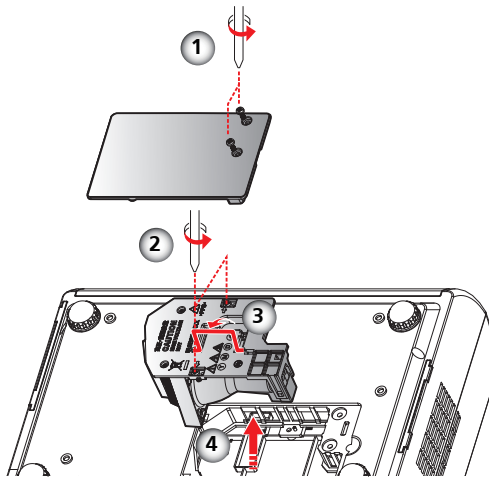

Warning: To reduce the risk of personal injury, do not drop the lamp module or touch the lamp bulb. The bulb may shatter and cause injury if it is dropped.

Warning: For continued safety replace with a lamp of the same type.

Lamp Replacing Procedure:

1. Switch off the power to the projector by pressing the "ON/STAND-BY".
2. Allow the projector to cool down at least 60 minutes.
3. Disconnect the power cable.
4. Use a screwdriver to remove the 2 screws from the cover. ❶
5. Push up and remove the cover.
6. Remove the 2 screws from the lamp module ❷ and pull up the lamp bar. ❸
7. Pull out the lamp module by force. ❹
8. Install the new lamp module by reversing the previous steps.
9. After replacing the lamp, turn on the power, and select the menu ->[Setting] ->[Lamp Counter Reset] to reset the lamp usage hours. See page 29.

ORDER REPLACEMENT LAMP

Replacement lamp can be ordered through your dealer. When ordering a projection lamp, give the following information to the dealer.

- Model No. of your projector : PDG-DXL100
- Replacement Lamp Type No. : POA-LMP138
(Service Parts No. 610 346 4633)



LAMP HANDLING PRECAUTIONS

This projector uses a high-pressure lamp which must be handled carefully and properly.

Improper handling may result in accidents, injury, or create a fire hazard.

- Lamp life may differ from lamp to lamp and according to the environment of use. There is no guarantee of the same life for each lamp. Some lamps may fail or terminate their life in a shorter period of time than other similar lamps.
- If the projector indicates that the lamp should be replaced, i.e., if the lamp life warning message appears, replace the lamp with a new one IMMEDIATELY after the projector has cooled down. (Follow carefully the instructions in the Lamp Replacement section of this manual.) Continuous use of the lamp with showing the lamp life warning message may increase the risk of lamp explosion.
- A Lamp may explode as a result of vibration, shock or degradation as a result of hours of use as its lifetime draws to an end. Risk of explosion may differ according to the environment or conditions in which the projector and lamp are being used.

IF A LAMP EXPLODES, THE FOLLOWING SAFETY PRECAUTIONS SHOULD BE TAKEN.

If a lamp explodes, disconnect the projector's AC plug from the AC outlet immediately. Contact an authorized service station for a checkup of the unit and replacement of the lamp. Additionally, check carefully to ensure that there are no broken shards or pieces of glass around the projector or coming out from the cooling air circulation holes. Any broken shards found should be cleaned up carefully. No one should check the inside of the projector except those who are authorized trained technicians and who are familiar with projector service. Inappropriate attempts to service the unit by anyone, especially those who are not appropriately trained to do so, may result in an accident or injury caused by pieces of broken glass.

Cleaning the Air Filters



Do not operate the projector with the air filters removed. Dust may accumulate on the optical elements degrading picture quality. Do not put anything into the air intake vent. It may result in malfunction of the projector.

Air filters prevent dust from accumulating on the optical elements inside the projector. Should the air filters become clogged with dust particles, it will reduce cooling fans' effectiveness and may result in internal heat build up and adversely affect the life of the projector. Clean the air filters following the steps below.

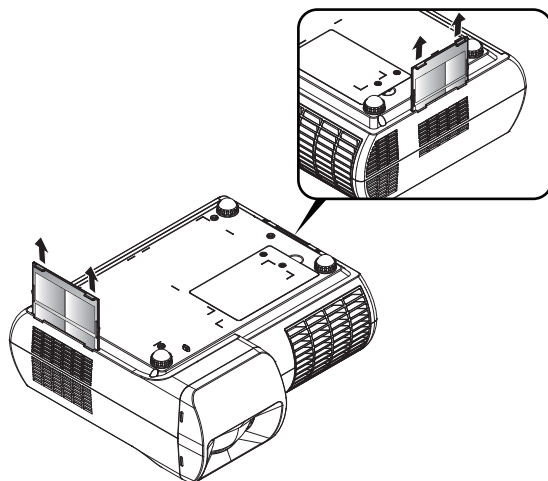

Air Filters Cleaning Procedure:

1. Turn off the projector, and disconnect the AC power cord from the AC outlet.
2. Remove the air filters by pulling the latch.
3. Clean the air filters with a brush or rinse them softly.
4. When cleaning the air filters by rinsing, dry them well. Replace the air filters properly. Make sure that the air filters is fully inserted.

RECOMMENDATION:

- We recommend avoiding dusty/smoky environments when operating the projector. Usage in these environments may cause a poor image quality.
- When using the projector under dusty or smoky conditions, dust may accumulate on a lens or optical elements inside the projector. This condition may degrade the quality of a projected image.
- When the symptoms above are noticed, contact your authorized dealer or service station for proper cleaning.

Specifications

Projection System	Single Chip DLP® Technology by Texas Instruments
Number of Pixels	XGA: 1024 pixels(H) X 768 lines(V), up to UXGA (1600 X 1200) with scaling technology
Lamp	225W (170W on ECO mode)
Projection Lens	F#2.6 f=6.97mm with manual focus
Projection Screen Size (Diag.)	40 to 307 inches (1.02 to 7.80 meters) Diagonal
Projection Distance	1.62 to 12.46 feet (0.5 to 3.8 meters)
Video Compatibility	- NTSC-M/NTSC-4.43/PAL-B, D, G, H, I/PAL-M/PAL-N/SECAM - Component: SDTV(480i/576i), EDTV(480p, 576p), HDTV(720p, 1080i/p)
H. Frequency	31.35kHz~79.98kHz horizontal scan
V. Frequency	50Hz~75Hz vertical refresh
Power Supply	Universal AC input 100-240V ; Input Frequency 50-60Hz
Power Consumption	Normal mode:320W Standby mode <1 Watt
Input Current	2.5-1.0A (100-240V AC)
I/O Connectors	- Power: AC power input socket - Computer Input: 2x 15-pin D-Sub VGA for analog/component and HDTV signal - RS232 Input: 1x Mini DIN 8-Pin for RS232 control input - HDMI Input: 1x 19-Pin HDMI(V1.3) for digital video input - RJ-45 Input: 1x RJ-45 for network management - Video Input: 1x Composite video RCA input 1x S-Video input - Audio Input: 1x Stereo Mini Jack - Computer Output: 1x 15-pin D-Sub VGA for monitor - Audio Output: 1x Stereo Mini Jack
Built-in Speaker	8W (monaural)
Weight	8.2lbs / 3.7kgs
Dimensions (W x D x H)	12.1 x 11.5 x 4.7 inches (306.5x 292.2 x 120.5 mm) (Including protrusions) 12.1 x 9.9 x 4.1 inches (306.5x 252.3 x 105.0 mm) (not including protrusions)
Environmental	- Operating Temperature: 41~95°F (5~ 35°C) Humidity: 80% maximum (Non-condensing) - Storage Temperature: -4~140°F (-20~60°C) Humidity: 80% maximum (Non-condensing)
Safety Regulation	Safety Regulation: UL/CUL EMC: CB Report, CE Class B, FCC Class B, C-Tick, KC, CCC
Optional Parts	- COMPONENT-VGA Cable : POA-CA-COMPVGA - Serial control cable : POA-MCSRL - VGA cable (10m) : KA-MC-DB10 - SCART-VGA Cable : POA-CA-SCART

Computer Compatibility (Analog)

(1) Signals from D-sub 15			
Modes	Resolution	V.Frequency (Hz)	H.Frequency (kHz)
VGA	640 × 480	60	31.50
	640 × 480	72	37.90
	640 × 480	75	37.50
	720 × 400	70	31.50
SVGA	800 × 600	56	35.20
	800 × 600	60	37.90
	800 × 600	72	48.10
	800 × 600	75	46.90
XGA	832 × 624	75	49.725
	1024 × 768	60	48.40
	1024 × 768	70	56.50
SXGA	1024 × 768	75	60.00
	*1280 × 1024	60	63.98
	*1280 × 1024	75	79.98
WXGA	*1280 × 720	60	45.00
	*1280 × 800	60	49.702
	*1440 × 900	60	55.935
QuadVGA	*1280 × 960	60	59.70
SXGA+	*1400 × 1050	60	63.98
UXGA	*1600 × 1200	60	75.00
Power Mac G4	640 × 480	66.6 (67)	34.93
	800 × 600	60	37.90
	1024 × 768	60	48.40
	*1152 × 870	75	68.68
PowerBook G4	640 × 480	60	31.35
	640 × 480	66.6 (67)	34.93
	800 × 600	60	37.90
	1024 × 768	60	48.40
i Mac DV (G3)	1152 × 870	75	68.68
	1024 × 768	75	60.00

Note

Note: "*" compressed computer image.

Note

Note: The projector only support a separate sync signal. Composite sync and sync on green are not supported.

Computer Compatibility (Digital-HDMI)

(1) PC digital signals with HDMI-DVI cable			
Modes	Resolution	V.Frequency (Hz)	H.Frequency (kHz)
VGA	640 x 480	60	31.50
	640 x 480	72	37.90
	640 x 480	75	37.50
	720 x 400	70	31.50
SVGA	800 x 600	56	35.20
	800 x 600	60	37.90
	800 x 600	72	48.10
	800 x 600	75	46.90
	832 x 624	75	49.725
XGA	1024 x 768	60	48.40
	1024 x 768	70	56.50
	1024 x 768	75	60.00
SXGA	*1280 x 1024	60	63.98
	*1280 x 1024	75	79.98
WXGA	*1280 x 720	60	45.00
	*1280 x 800	60	49.702
	*1440 x 900	60	55.935
QuadVGA	*1280 x 960	60	59.70
SXGA+	*1400 x 1050	60	63.98
UXGA	*1600 x 1200	60	75.00
Power Mac G4	640 x 480	66.6 (67)	34.93
	800 x 600	60	37.90
	1024 x 768	60	48.40
	*1152 x 870	75	68.68
PowerBook G4	640 x 480	60	31.35
	640 x 480	66.6 (67)	34.93
	800 x 600	60	37.90
	1024 x 768	60	48.40
	1152 x 870	75	68.68
i Mac DV (G3)	1024 x 768	75	60.00

Appendices

(2) AV digital signals with HDMI cable		
Modes	Resolution	V.Frequency (Hz)
480i	1440 x 480	60
480p (NTSC)	640 x 480	60
480p (NTSC)	720 x 480	60
576i (PAL)	1440 x 576	50
576p (PAL)	720 x 576	50
720p (NTSC)	1280 x 720	60
720p (PAL)	1280 x 720	50
1080i (NTSC)	1920 x 1080	60
1080i (PAL)	1920 x 1080	50
1080p (NTSC)	1920 x 1080	60
1080p (PAL)	1920 x 1080	50

Configurations of Terminals

Terminal : Analog RGB (Mini D-sub 15 pin)

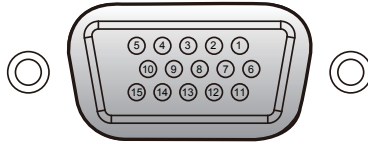

1	Red (R/Cr) Input/R Output	9	5V / ***
2	Green (G/Y) Input/G Output	10	Ground (Ver. sync.)
3	Blue (B/Cb) Input/B Output	11	ICP download
4	***	12	DDC data / ***
5	Ground (Horiz.sync.)	13	Horiz. sync. Input / Output (Composite H/V sync. Input)
6	Ground (Red)		
7	Ground (Green)	14	Vert. sync. Input / Output
8	Ground (Blue)	15	DDC clock / ***

Terminal : Mini DIN 8-pin

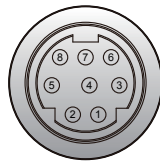

1	RXD
2	***
3	***
4	GND
5	***
6	TXD
7	***
8	***

Regulation & Safety Notices

This appendix lists the general notices of your Projector.

FCC notice

This device has been tested and found to comply with the limits for a Class B digital device pursuant to Part 15 of the FCC rules. These limits are designed to provide reasonable protection against harmful interference in a residential installation. This device generates, uses and can radiate radio frequency energy and, if not installed and used in accordance with the instructions, may cause harmful interference to radio communications.

However, there is no guarantee that interference will not occur in a particular installation. If this device does cause harmful interference to radio or television reception, which can be determined by turning the device off and on, the user is encouraged to try to correct the interference by one or more of the following measures:

- Reorient or relocate the receiving antenna.
- Increase the separation between the device and receiver.
- Connect the device into an outlet on a circuit different from that to which the receiver is connected.
- Consult the dealer or an experienced radio/television technician for help.

Notice: Shielded cables

All connections to other computing devices must be made using shielded cables to maintain compliance with FCC regulations.

Caution

Changes or modifications not expressly approved by the manufacturer could void the user's authority, which is granted by the Federal Communications Commission, to operate this projector.

Operation conditions

This device complies with Part 15 of the FCC Rules. Operation is subject to the following two conditions:

1. This device may not cause harmful interference and
2. This device must accept any interference received, including interference that may cause undesired operation.

Notice: Canadian users

This Class B digital apparatus complies with Canadian ICES-003.

Remarque à l'intention des utilisateurs canadiens

Cet appareil numérique de la classe B est conforme à la norme NMB-003 du Canada.

Declaration of Conformity for EU countries

- EMC Directive 2004/108/EC (including amendments)
- Low Voltage Directive 2006/95/EC
- R & TTE Directive 1999/5/EC (if product has RF function)

FOR EU USERS

The symbol mark and recycling systems described below apply to EU countries and do not apply to countries in other areas of the world.

Your product is designed and manufactured with high quality materials and components which can be recycled and/or reused.

The symbol mark means that electrical and electronic equipment, batteries and accumulators, at their end-of-life, should be disposed of separately from your household waste.

Note:

If a chemical symbol is printed beneath the symbol mark, this chemical symbol means that the battery or accumulator contains a heavy metal at a certain concentration. This will be indicated as follows: Hg: mercury, Cd: cadmium, Pb: lead
In the European Union there are separate collection systems for used electrical and electronic equipment, batteries and accumulators.

Please, dispose of them correctly at your local community waste collection/recycling centre.

Please, help us to conserve the environment we live in!



Serial Control Interface

This projector provides a function to control and monitor the projector's operations by using the RS-232C serial port.

Operation

1. Connect a RS-232C serial cross cable to SERVICE PORT on the projector and serial port on the PC.
2. Launch a communication software provided with PC and setup the communication condition as follows:
3. Type the command for controlling the projector and then enter the "Enter" key.

Example

When you want to change the input to Computer 2, Type 'C' '0' '6' 'Enter'.

Baud rate	: 9600 / 19200 bps
Parity check:	: none
Stop bit	: 1
Flow control	: none
Data bit	: 8

Note

- The default of the baud rate is set to 9600 bps. If an error occurs in the communication, change the serial port and the communication speed (baud rate).
- Enter with ASCII 64-byte capital characters and one-byte characters.

Functional Execution Command

Format

The command is sent from PC to the projector with the format below;

'C' [Command] 'CR'

Command: two characters (refer to the command table below.

- The projector decodes the command and returns the 'ACK' with the format below;

'ACK' 'CR'

- When the projector cannot decode the command, it returns with format below.

'?' 'CR' projector and serial port on the PC.

Command	Function	Command	Function
C00	POWER ON	C24	YPbPr 2
C01	POWER OFF (Immediate POWER OFF)	C25	---
		C26	Scart
C04	HDMI	C27	IMAGE(Toggle)
C05	Computer 1	C30	D.zoom +
C06	Computer 2	C31	D.zoom -
C09	Volume +	C33	Video
C0A	Volume -	C34	S-Video
C0B	SOUND MUTE ON	C35	YPbPr 1
C0C	SOUND MUTE OFF	C3A	POINTER RIGHT
C0D	VIDEO MUTE ON	C3B	POINTER LEFT
C0E	VIDEO MUTE OFF	C3C	POINTER UP
C0F	Aspect 4:3	C3D	POINTER DOWN
C10	Aspect 16:9	C3F	ENTER
C11	Image mode Presentation	C43	FREEZE ON
C12	Image mode Movie	C44	FREEZE OFF
C13	Image mode sRGB	C89	AUTO ADJ.
C14	Image mode Bright	C8E	KEYSTONE +
C15	Image mode User	C8F	KEYSTONE -
C1C	MENU ON		
C1D	MENU OFF		

Status Read Command

Format

The command is sent from PC to the projector with the format below;

'CR' [Command] 'CR'

Command: one character (refer to the command table below.

- The projector decodes the command and returns the 'Character string' with the format below;

Command	Function	Projector Return	Projector status
CR0	Status Read	00	Power ON
		80	Standby mode
		20	Cooling Down
		10	Power Failure
		28	Cooling Down due to Abnormal Temperature in process
		21	Cooling Down in process after Off due to lamp failure
		81	Standby after Cooling Down due to lamp failure
CR1	Input Mode Read		
CR3	Lamp Time Read		
CR4	Setting Read		
CR6	Temperature Read	S1	S1 = Temperature at Sensor 1 (°C) (ex.) S1 = 12.3°C --> The projector displays "12.3"
CR7	Lamp Mode Read		

Note

The tables on pages 56~58 show the typical command lists for controlling the projector. Please consult your local dealer for further information of other commands.

Use of Telnet

Note

❖ The telnet 10000 port is used to control the projector.

❖ Further instructions about the telnet application, please see the on-line guide on your computer.

You can control the projector by using the telnet application installed on your computer. Normally, the telnet application is available on your computer.

Control

(For example, in case of using the telnet application of Windows XP Professional.)

1. Select Run... submenu from Start menu on the computer. Type "telnet" onto the Open text area on the displayed window and press OK button.

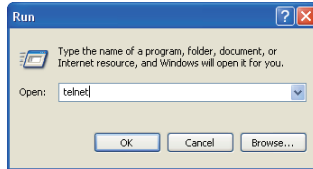

2. The telnet application will start and the following window will be displayed. Type as below to connect the projector.

> open 192.168.1.201 10000 [return]

* Use the IP address assigned to the projector.

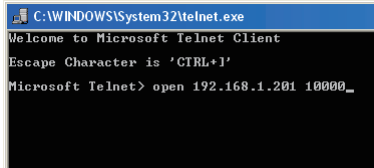

3. When communication is established correctly, the word "PASSWORD:" appears on the window. Type the login telnet password for the projector and then press "Enter" key on the keyboard. If you do not set up the telnet password, just press "Enter" key. When the word "Hello" is replied, login has been succeeded.

* The password "1234" is used for the example.

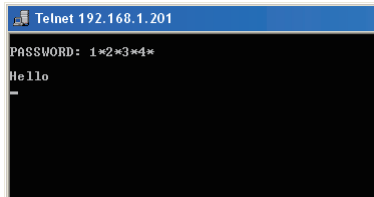

Appendices

Note

Enter with ASCII 64-byte capital characters and one-byte characters.

4. Type the commands, refer to right table, to control the projector and then press "Enter" key for termination. For example, type "C00" which is a command to turn on the projector, and press "Enter" key. Confirm the projector is turning on.

To disconnect the communication, press "Ctrl" key and "]" key at the same time, type "close" and then press "Enter" key on the Keyboard.

> close [return]

The table right shows the typical command lists for controlling this projector and please consult your local dealer for further information of another commands.

Command list table

Command	Function
C00	POWER ON
C01	POWER OFF (Immediate POWER OFF)
C09	Volume +
C0A	Volume -
C0B	SOUND MUTE ON
C0C	SOUND MUTE OFF
C0F	Aspect 4:3
C10	Aspect 16:9
C1C	MENU ON
C1D	MENU OFF

PJLink Notice

This projector is compliant with PJLink Standard Class 1 of JBMIA (Japan Business Machine and Information System Industries Association). This projector supports all commands defined by PJLink Class 1 and is verified conformance with PJLink Standard Class 1.

Projector	PJLink	
	Input	Parameter
Computer 1	RGB 1	11
YPbPr 1	RGB 2	12
SCART	RGB 3	13
Computer 2	RGB 4	14
YPbPr 2	RGB 5	15
Video	VIDEO 1	21
S-Video	VIDEO 2	22
HDMI	DIGITAL 1	31

PJLink™ PJLink is a registered trademark of JBMIA and pending trademark in some countries.

Dimensions

