

DLPTV  DLPTV



Samsung Electronics of America, Inc.
Service Division
400 Valley Road, Suite 201
Mt. Arlington, N.J. 07660
TEL: 1-800-SAMSUNG (1-800-726-7864)
www.samsungusa.com

I N S T R U C T I O N M A N U A L
HLM4365W/HLM5065W/HLM437W/HLM507W/HLM617W

Safety Instructions



Warning! Important Safety Instructions

CAUTION
RISK OF ELECTRIC SHOCK
DO NOT OPEN

CAUTION: TO REDUCE THE RISK OF ELECTRIC SHOCK, DO NOT REMOVE COVER (OR BACK). THERE ARE NO USER SERVICEABLE PARTS INSIDE. REFER ALL SERVICING TO QUALIFIED SERVICE PERSONNEL.

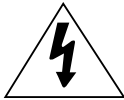

This symbol indicates high voltage is present. It is dangerous to make any kind of contact with any part inside this product.



This symbol alerts you that important literature concerning operation and maintenance has been included with this product.

CAUTION: FCC/CSA regulations state that any unauthorized changes or modifications to this equipment may void the user's authority to operate it.

CAUTION: To prevent electric shock, match the wide blade of plug to the wide slot, and fully insert the plug.

ATTENTION: Pour éviter les chocs électriques, introduire la lame la plus large de la fiche dans la borne correspondante de la prise et pousser jusqu'au fond.

Note to CATV system installer: This reminder is provided to call CATV system installer's attention to Article 820-40 of the National Electrical Code (Section 54 of Canadian Electrical Code, Part I), that provides guidelines for proper grounding and, in particular, specifies that the cable ground shall be connected to the grounding system of the building as close to the point of cable entry as possible.

Important: One Federal Court has held that unauthorized recording of copyrighted TV programs is an infringement of U.S. copyright laws. Certain Canadian programs may also be copyrighted and any unauthorized recording in whole or in part may be in violation of these laws.

To prevent damage which may result in fire or electric shock, do not expose this appliance to rain or moisture.

Thank You for Choosing Samsung

Thank you for choosing Samsung! Your new Samsung projection TV represents the latest in television technology. We designed it with easy-to-use on-screen menus and closed captioning capabilities, making it one of the best products in its class. We are proud to offer you a product that will provide convenient, dependable service and enjoyment for years to come.

Important Safety Information



Always be careful when using your TV. To reduce the risk of fire, electrical shock, and other injuries, keep these safety precautions in mind when installing, using, and maintaining your unit.

- Read all safety and operating instructions before operating your TV.
- Keep the safety and operating instructions for future reference.
- Heed all warnings on the TV and in the operating instructions.
- Unplug the TV from the wall outlet before cleaning. Use a damp cloth; do not use liquid or aerosol cleaners.
- Never add any attachments and/or equipment without approval of the manufacturer. Such additions can increase the risk of fire, electric shock, or other personal injury.
- Do not use the TV where contact with water is possible, such as near bath tubs, sinks, washing machines, swimming pools, etc.
- Do not place the TV on an unstable cart, stand, tripod, bracket, or table where it can fall. A falling TV can cause serious injury to a child or adult, and serious damage to the appliance. Use only with a cart, stand, tripod, bracket, or table recommended by the manufacturer or sold with the TV. Follow the manufacturer's instructions when mounting the unit, and use a mounting accessory recommended by the manufacturer. Move the TV and cart with care. Quick stops, excessive force, and uneven surfaces can make the unit and cart unsteady and more likely to overturn.
- The TV is designed with slots in the cabinet for ventilation to protect it from overheating. Do not block these openings with any object, and do not put the TV on a bed, sofa, rug, or other similar surface. Do not put the TV near a radiator or heat register. If you do put the TV on a rack or bookcase, make sure that there is adequate ventilation and that you've followed the manufacturer's instructions for mounting.
- Operate your TV only from the type of power source indicated on the marking label. If you are not sure of the type of power supplied to your home, consult your appliance dealer or local power company.
- Use only a grounded or polarized outlet. For your safety, this TV is equipped with a polarized alternating current line plug having one blade wider than the other. This plug will fit into the power outlet only one way. If you are unable to insert the plug fully into the outlet, try reversing the plug. If the plug still does not fit, contact an electrician to replace your outlet.



Safety Instructions

- Protect the power cord. Power supply cords should be routed so that they won't be walked on or pinched by objects placed on or against them. Pay particular attention to cords at plugs, convenience receptacles, and the point where they exit from the unit.
- Unplug the TV from the wall outlet and disconnect the antenna or cable system during a lightning storm or when left unattended and unused for long periods of time. This will prevent damage to the unit from lightning and power-line surges.
- Avoid overhead power lines. An outside antenna system should not be placed in the vicinity of overhead power lines or other electric light or power circuits, or where it can fall into such power lines or circuits. When installing an outside antenna system, be extremely careful to keep from touching the power lines or circuits. Contact with such lines can be fatal.
- Do not overload the wall outlet or extension cords. Overloading can result in fire or electric shock.
- Do not insert anything through the openings in the unit, where they can touch dangerous voltage points or damage parts. Never spill liquid of any kind on the TV.
- Ground outdoor antennas. If an outside antenna or cable system is connected to the TV, be sure the antenna or cable system is grounded so as to provide some protection against voltage surges and built-up static charges. Section 810 of the National Electrical Code, ANSI/NFPA No. 70-1984, provides information about proper grounding of the mast and supporting structure, grounding of the lead-in wire to an antenna discharge unit, size of grounding conductors, location of antenna discharge unit, connection to grounding electrodes, and requirements for the grounding electrode.
- Do not attempt to service the TV yourself. Refer all servicing to qualified service personnel. Unplug the unit from the wall outlet and refer servicing to qualified service personnel when:
 - The power-supply cord or plug is damaged
 - Liquid has been spilled on the unit or if objects have fallen into the unit
 - The TV has been exposed to rain or water
 - The TV does not operate normally by following the operating instructions
 - The TV has been dropped or the cabinet has been damaged
 - The TV exhibits a distinct degradation in performance
 - When the LAMP(BULB ONLY) replacement is needed
- If you make adjustments yourself, adjust only those controls that are covered by the operating instructions. Adjusting other controls may result in damage and will often require extensive work by a qualified technician to restore the TV to normal.
- When replacement parts are required, be sure the service technician uses replacement parts specified by the manufacturer or those that have the same characteristics as the original part. Unauthorized substitutions may result in additional damage to the unit.
- Upon completion of any service or repairs to this TV, ask the service technician to perform safety checks to determine that the TV is in a safe operating condition.

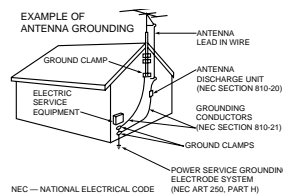

This device complies with part 15 of the FCC Rules. Operation is subject to the following two conditions:
(1) This device may not cause harmful interference, and
(2) This device must accept any interference that may cause undesired operation.

This television receiver provides display of television closed captioning in accordance with §15.119 of the FCC rules.

FCC Information

User Instructions

The Federal Communications Commission Radio Frequency Interference Statement includes the following warning:
NOTE: This equipment has been tested and found to comply with the limits for a Class B digital device, pursuant to Part 15 of the FCC Rules. These limits are designed to provide reasonable protection against harmful interference in a residential installation. This equipment generates, uses, and can radiate radio frequency energy and, if not installed and used in accordance with the instructions, may cause harmful interference to radio communications. However, there is no guarantee that interference will not occur in a particular installation.

If this equipment does cause harmful interference to radio or television receptions, which can be determined by turning the equipment off and on, the user is encouraged to try to correct the interference by one or more of the following measures:

- Reorient or relocate the receiving antenna.
- Increase the separation between the equipment and receiver.
- Connect the equipment into an outlet on a circuit different from that to which the receiver is connected.
- Consult the dealer or an experienced radio/TV technician for help.

User Information

Changes or modifications not expressly approved by the party responsible for compliance could void the user's authority to operate the equipment. If necessary, consult your dealer or an experienced radio/television technician for additional suggestions. You may find the booklet called How to Identify and Resolve Radio/TV Interference Problems helpful. This booklet was prepared by the Federal Communications Commission. It is available from the U.S. Government Printing Office, Washington, DC 20402, Stock Number 004-000-00345-4.

Warning

User must use shielded signal interface cables to maintain FCC compliance for the product. Declaration of conformity for products marked with FCC Logo. This device complies with Part 15 of the FCC Rules. Operation is subject to the following two conditions:
(1) this device may not cause harmful interference, and
(2) this device must accept any interference received, including interference that may cause undesired operation.

The party responsible for product compliance:
SAMSUNG ELECTRONICS CO., LTD
America QA Lab of Samsung
85 West Tasman Drive
San Jose, CA 95134 USA
Tel) 408-544-5124
Fax) 408-544-5191

Provided with this monitor is a detachable power supply cord with IEC320 style terminations. It may be suitable for connection to any UL Listed personal computer with similar configuration. Before making the connection, make sure the voltage rating of the computer convenience outlet is the same as the monitor and that the ampere rating of the computer convenience outlet is equal to or exceeds the monitor voltage rating. For 120 Volt applications, use only UL Listed detachable power cord with NEMA configuration 5-15P type (parallel blades) plug cap. For 240 Volt applications use only UL Listed Detachable power supply cord with NEMA configuration 6015P type (tandem blades) plug cap.

IC Compliance Notice

This Class B digital apparatus meets all requirements of the Canadian Interference-Causing Equipment Regulations of ICES-003.

Notice de Conformité IC

Cet appareil numérique de classe B respecte toutes les exigences du Règlement ICES-003 sur les équipements produisant des interférences au Canada.

Table of Contents

Your New Wide TV	10	Special Features	48
List of Features	10	Setting Up Your Remote Control	48
Checking Parts	10	Remote Control Codes	51
Side Panel Buttons : HLM437W/HLM507W/HLM617W	11	Fine Tuning Channels	52
Side Panel Jacks : HLM437W/HLM507W/HLM617W	11	Selecting the Color Tone	53
Side Panel Buttons : HLM4365W/HLM5065W	12	Setting the Film Mode	53
Side Panel Jacks HLM4365W/HLM5065W	12	DNIe™ (Digital Natural Image engine) 	54
Front Panel LED Indicators : HLM437W/HLM507W/HLM617W	13	Digital Noise Reduction	55
Front Panel LED Indicators : HLM4365W/HLM5065W	14	Setting the Blue Screen Mode	56
Rear Panel Jacks	15	Changing the Screen Size	57
Remote Control	16	Special Audio Options	59
Installing Batteries in the Remote Control	17	MTS Settings: Choosing a Soundtrack	59
Connections	20	Dolby Virtual	60
Connecting VHF and UHF Antennas	20	BBE	61
Antennas with 300-ohm Flat Twin Leads	20	Auto Volume	62
Antennas with 75-ohm Round Leads	20	Viewing Closed Caption Information	63
Separate VHF and UHF Antennas	21	Viewing Picture-in-Picture	64
Connecting Cable TV and VCR	22	Selecting a Screen	64
Cable without a Cable Box	22	Selecting an External Signal	65
Cable with a Cable Box that Descrambles All Channels	22	Selecting a Signal Source (Antenna or Cable) for PIP	66
Connecting a Cable Converter Box	23	Swapping the Contents of the PIP and Main image	67
Connecting a Cable Converter Box and a VCR	23	Changing the Size of the PIP image	68
Connecting a Camcorder	24	Changing the Picture-in-Picture Channel	69
Connecting a DVD Player	25	Selecting the Sound Source	70
Connecting a DTV Set Top Box	26	Changing the Location of the PIP image	70
Operation	30	Using the V-Chip	71
Turning the TV On and Off	30	PC Display	78
Viewing the Menus and Displays	30	Using Your TV as a Computer (PC) Display	78
Selecting the Menu Language	31	How to connect Your PC to the TV	78
Selecting the Antenna Input	31	How to Set up Your PC Software (Windows only)	79
Channel Memory	33	Display Modes	80
Changing Channels	34	How to Set up Your TV as a PC display	81
Selecting Your Favorite Channels	35	Picture Quality Adjustment	82
Labeling the Channels	36	Changing the Position of the Image (Moving left, right, up and down)	83
Setting The On/Off Melody	37	Changing the Screen Size (PC mode)	84
Picture Control	38	Appendix	88
Sound Control	40	Troubleshooting	88
Setting the Clock	42	Care and Maintenance	89
Setting the Timers	43	Using Your TV in Another Country	89
Viewing an External Signal Source	45	Specifications	89

Your New Wide TV

SAMSUNG

Your New Wide TV

List of Features

Your TV was designed and engineered using the latest technology. It is a full-featured, high-performance unit that exceeds industry standards. In addition, it has these special features:

- Easy-to-operate remote control
- Easy-to-use on-screen menu system you can access from the side panel or remote control
- Automatic timer to turn the TV on and off at any time you choose
- Adjustable picture and sound settings and the ability to memorize your favorite settings
- Automatic channel tuning for up to 181 channels
- A special filter to reduce or eliminate reception problems
- Fine tuning control for the sharpest picture possible
- A built-in multi-channel sound decoder for stereo and bilingual listening
- Built-in, dual channel speakers
- A special sleep timer
- Picture-in-Picture capability that lets you watch two channels at once
- Widescreen TV with adjustable image size

Checking Parts

Once you have unpacked your TV, check to make sure that you have all the parts shown here. If any piece is missing or broken, call your dealer.

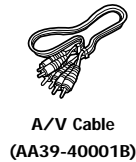
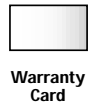
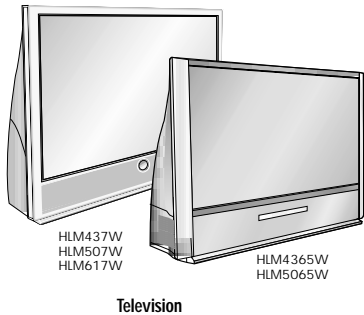

Side Panel Buttons : HLM437W/HLM507W/HLM617W

The buttons on the side panel control your TV's basic features, including the on-screen menu system. To use the more advanced features, you must use the remote control.

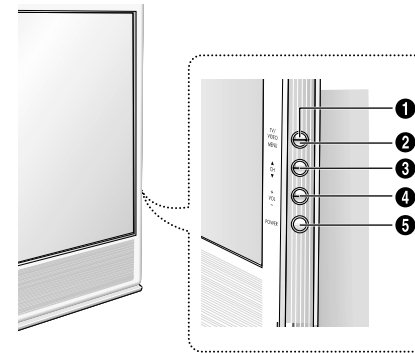

- 1 TV/VIDEO**
Press to switch between viewing TV programs and signals from connected components.
- 2 MENU**
Press to see the on-screen menu.
- 3 ▼ CHANNEL ▲**
Press to change channels and move between items on the on-screen menu.
- 4 VOLUME +, -**
Press to lower or raise the volume and to select items when using the on-screen menu.
- 5 POWER**
Press to turn the TV on and off.

Side Panel Jacks : HLM437W/HLM507W/HLM617W

Use the side panel jacks to connect a component that is used only occasionally (a camcorder or video game, for example).

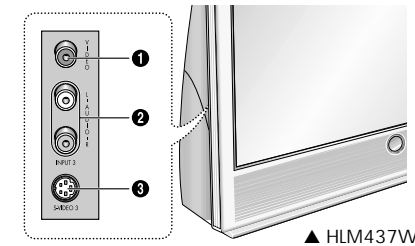

- 1 VIDEO Input jack**
Connect the video signal from a camcorder or video game.
- 2 AUDIO Input jacks**
Connect the audio signal from a camcorder or video game.
- 3 S-VIDEO Input jack**
Connect an S-video signal from a camcorder or video game.
(S-Video 3 jack and Audio L/R input 3 are used in conjunction.)

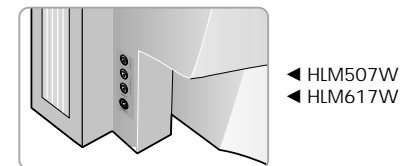

Your New Wide TV

Side Panel Buttons : HLM4365W/HLM5065W

The buttons on the side panel control your TV's basic features, including the on-screen menu system. To use the more advanced features, you must use the remote control.

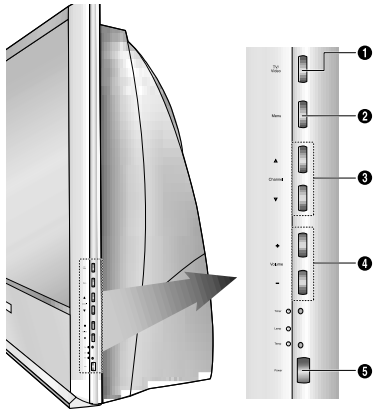

- 1 TV/VIDEO**
Press to switch between viewing TV programs and signals from connected components.
- 2 MENU**
Press to see the on-screen menu.
- 3 ▼ CHANNEL ▲**
Press to change channels and move between items on the on-screen menu.
- 4 VOLUME +, -**
Press to lower or raise the volume and to select items when using the on-screen menu.
- 5 POWER**
Press to turn the TV on and off.

Side Panel Jacks HLM4365W/HLM5065W

Use the side panel jacks to connect a component that is used only occasionally (a camcorder, video game or PC, for example).

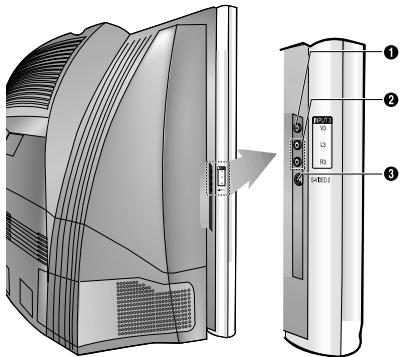

- 1 VIDEO Input jack**
Connect the video signal from a camcorder or video game.
- 2 AUDIO Input jacks**
Connect the audio signal from a camcorder or video game.
- 3 S-VIDEO Input jack**
Connect an S-video signal from a camcorder or video game.
(S-Video 3 jack and Audio L/R input 3 are used in conjunction)

Front Panel LED Indicators : HLM437W/HLM507W/HLM617W

The three lights on the front panel indicate the status of your TV.

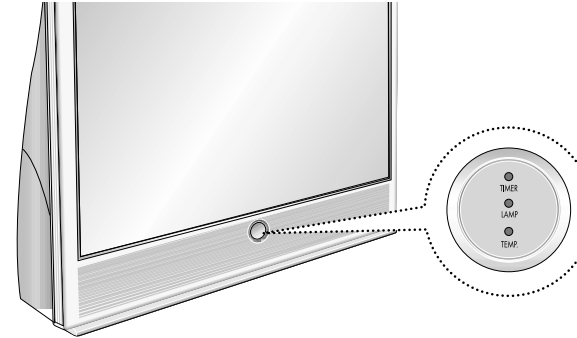

Indicator Light Key

- : Light is On
- ◐ : Light is Blinking
- : Light is Off

Timer	Lamp	Temp	Indication
●	○	○	Auto Timer ON/OFF has been set
○	●	○	The set is operating normally .
○	◐	○	Standby state. The picture will automatically appear in about 25 seconds.
●	●	○	Auto Timer ON/OFF has been set and the set is normally operating.
●	◐	○	Auto Timer ON/OFF has been set and the set will automatically be turned on in about 25 seconds.
◐	○	◐	A cooling fan inside the set is not operating normally.
○	◐	◐	Lamp cover on rear of the set is not properly shut.
○	○	◐	Check if the ventilation hole on the rear of the set is blocked, because if the inner temperature is too high, the power will shut off.
◐	◐	◐	Lamp doesn't light. It may have a fault or has burned out. Replace with a new lamp.

- It takes about 30 seconds for the TV to warm up, so normal brightness may not appear immediately.
- The TV has a fan to keep the inside lamp from overheating. You'll occasionally hear it working.

Your New Wide TV

Front Panel LED Indicators : HLM4365W/HLM5065W

The three lights on the front panel indicate the status of your TV.

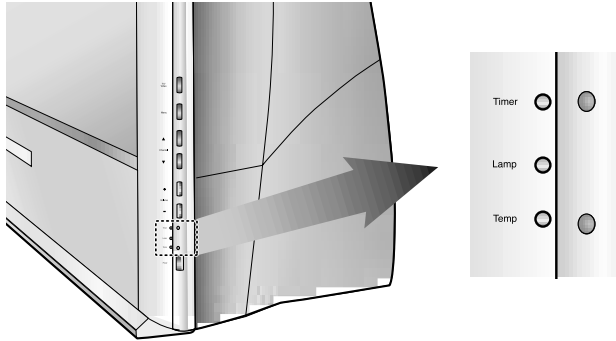

Indicator Light Key

- : Light is On
- ◐ : Light is Blinking
- : Light is Off

Timer	Lamp	Temp	Indication
●	○	○	Auto Timer ON/OFF has been set
○	●	○	The set is operating normally .
○	◐	○	Standby state. The picture will automatically appear in about 25 seconds.
●	●	○	Auto Timer ON/OFF has been set and the set is normally operating.
●	◐	○	Auto Timer ON/OFF has been set and the set will automatically be turned on in about 25 seconds.
◐	○	◐	A cooling fan inside the set is not operating normally.
○	◐	◐	Lamp cover on rear of the set is not properly shut.
○	○	◐	Check if the ventilation hole on the rear of the set is blocked, because if the inner temperature is too high, the power will shut off.
◐	◐	◐	Lamp doesn't light. It may have a fault or has burned out. Replace with a new lamp.

- It takes about 30 seconds for the TV to warm up, so normal brightness may not appear immediately.
- The TV has a fan to keep the inside lamp from overheating. You'll occasionally hear it working.

Rear Panel Jacks

Use the rear panel jacks to connect components such as a VCR. You can connect two different components such as two VCRs, Set-Top Box and a DVD player etc., because there are two sets of video input jacks and one set of component video input jacks on the rear panel of your TV. For more information, please see "Connections".

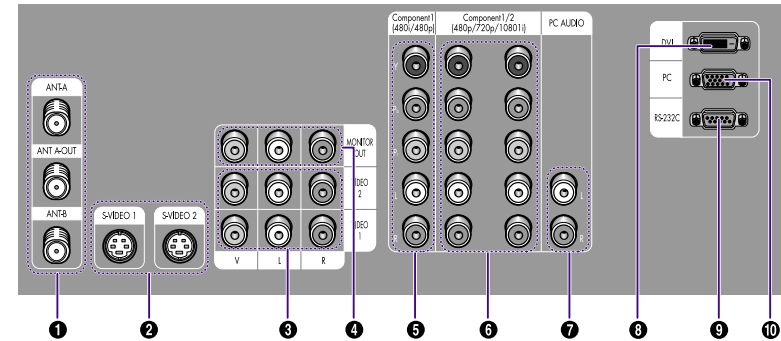

1 ANTENNA terminals

Two independent cables or antennas can be connected to these terminals. Use ANT-A and ANT-B terminals to receive a signal from VHF/UHF antennas or your cable system. Use the ANT A-OUT terminal to send the signal being received by the ANT-A terminal out to another component (such as a Cable Set Top Box). The PIP channel can be received only when a signal source is connected to ANT-A.

2 S-VIDEO INPUT jacks

Connects an S-Video signal from an S-VHS VCR or DVD player.

3 VIDEO/AUDIO INPUT jacks(VCR1, VCR2)

Connect video/audio signals from external sources, such as a VCR or DVD players.

4 VIDEO/AUDIO MONITOR OUTPUT jacks

Sends a video signal from the TV to an external source, such as a VCR.

Note: Monitor Out is available only in RF, Video and S-Video modes.

5 Component1 jacks (Y, Pb, Pr, L, R)

Use these jacks to connect the component video/audio signals from a DVD player when using the component video input jacks.

Note: Only 480i and 408p formats are supported.

6 Component 2, 3 jacks (Y, Pb, Pr, L, R)

Receives the DTV video/audio signals from a set top box.

Note: Only 480p, 720p and 1080i formats are supported.

7 PC AUDIO INPUT jacks

Connect these to the audio-output jacks on your PC.

8 DVI (Digital Video Interface) jack

Receives the digital signals from a set top box or PC etc.

9 RS-232C jack

10 PC VIDEO INPUT jack

Connect to the video output port on your PC.

Your New Wide TV

Remote Control

You can use the remote control up to a distance of about 23 feet from the TV. When using the remote, always point it directly at the TV. The remote control can also operate your VCR, cable box, and DVD player.

- 1. POWER**
Turns the TV on and off.
- 2. +100**
Press to select cable channels over 100 on TV.
- 3. Menu**
Displays the main on-screen menu.
- 4. CH(Channel) and VOL(Volume)**
Controls volume, channel selection.
- 5. Mute**
Press to mute the TV sound.
- 6. Display**
Press to display information on the TV screen.
- 7. Aspect**
Press to change the screen size.
- 8. Surround**
Press to hear the Dolby surround effect.
- 9. MTS(Multichannel Television Stereo)**
Press to choose stereo, mono or Separate Audio Program (SAP broadcast).
- 10. Mode**
Selects a target device to be controlled by the Samsung remote control (i.e., TV, VCR, Cable, or DVD).
- 11. Pre-ch**
Tunes to the previous channel.
- 12. TV/Video**
Press to display all of the available video sources (i.e., TV, VCR, DVD, DTV, PC).
- 13. Joystick**
Use to highlight on-screen menu items and change menu values.
- 14. DNle**
Activates DNle (Digital Natural Image engine).
- 15. PIP**
Activates picture in picture.
- 16. Still**
Press to stop the action during a particular scene. Press again to resume normal video.
- 17. Fav.CH (Favorite Channel)**
Press to switch between your favorite channels.
- 18. S.Mode**
Adjust the TV sound by selecting one of the preset factory settings (or select your personal, customized sound settings.)
- 19. P.Mode**
Adjust the TV picture by selecting one of the preset factory settings (or select your personal, customized picture settings.)
- 20. VCR controls**
Controls VCR tape functions: Rewind, Play, Fast Forward, Stop, Pause.
- 21. PIP controls**
Source : Press to select one of the available signal sources for the PIP window.
Scan: Press to scan the memorized channels.
Locate: Press to move the PIP window to any of the four corners of the TV screen.
Swap: Exchanges the video signal that is currently displayed on the main screen with the signal in the PIP window.
Size: Press to make the PIP window larger or smaller.
CH(PIP): Displays the available channels in sequence. (These buttons change channels in the PIP window only.)
- 22. V.chip**
Press to set up and activate the parental locks.
- 23. Set**
Used during set up of this remote control, so that it will work compatibly with other devices (VCR, cable box, DVD, etc.)
- 24. Sleep**
Press to select a preset time interval for automatic shutoff.
- 25. Add/Erase**
Press to add or erase channels in the TV's memory.
Use the Add/Erase button to memorize/erase the fine tuning after fine tuning channels.

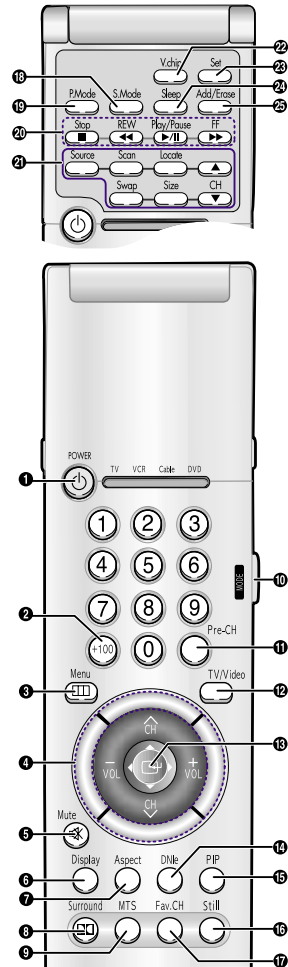

Installing Batteries in the Remote Control

With normal use, the batteries in the remote control should last about a year. If you notice a performance degradation while using the remote, the batteries may need to be replaced. Make sure you replace both batteries and do not mix old and new batteries in the remote control. If you won't be using the remote control for a long time, remove the batteries and store them in a cool dry place.

- 1** Slide the back cover all the way out to open the battery compartment of the remote control.

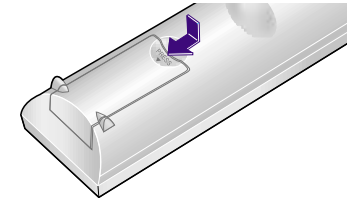

- 2** Install two AAA size batteries. Make sure to match the "+" and "-" ends of the batteries with the diagram inside the compartment.

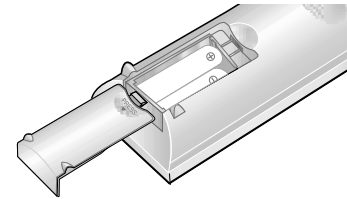

- 3** Slide the cover back into place.

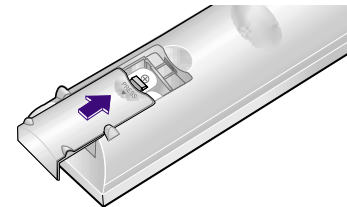

Connections

SAMSUNG

Connections

Connecting VHF and UHF Antennas

If you do not have a cable system, you will need to connect an antenna to your TV.

Antennas with 300-ohm Flat Twin Leads

If your antenna looks like this:  it has 300-ohm flat twin leads.

- 1 Place the wires from the twin leads under the screws on the 300-75 ohm adapter. Use a screwdriver to tighten the screws.

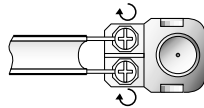

- 2 Plug the adapter into the ANT-A terminal on the back panel of the TV.

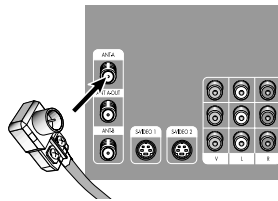

Antennas with 75-ohm Round Leads

If your antenna looks like this:  it is an antenna with 75-ohm round leads.

- 1 Plug the antenna lead into the ANT-A terminal on the back panel of the TV.

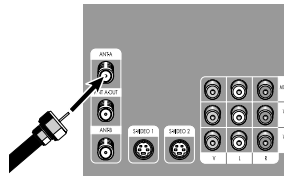

Separate VHF and UHF Antennas

If you have two separate antennas for your TV (one VHF and one UHF), you must combine the two antenna signals before connecting them to the TV. This requires a combiner attachment, which you can buy at an electronics store.

- 1 Connect both antenna leads to the combiner.

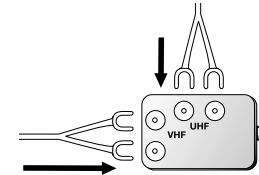

- 2 Plug the combiner into the ANT-A terminal on the back panel of the TV.

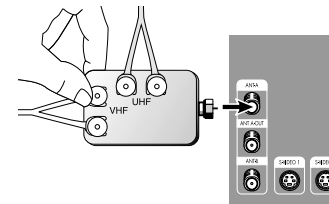

Connections

Connecting Cable TV and VCR

You can connect different cable systems to your TV, including cable without a cable box, and cable with a cable box that descrambles some or all channels.

Cable without a Cable Box

If you want to connect cable, and you do not need to use a cable box:

- 1 Plug the incoming cable into the ANT-A antenna terminal on the back of the TV.

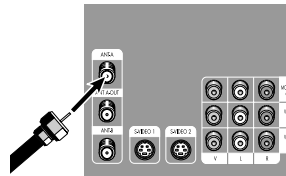

Cable with a Cable Box that Descrambles All Channels

- 1 Find the cable that is connected to the ANTENNA OUT terminal on your cable box. This terminal might be labeled "ANT OUT," "VHF OUT," or simply, "OUT."

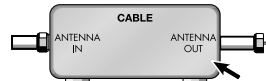

- 2 Connect the other end of this cable to the ANT A antenna terminal on the back of the TV.

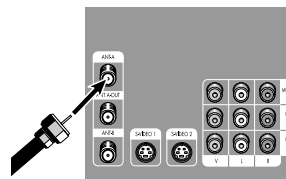

Connecting a Cable Converter Box

This connection allows you to watch cable and premium channels. You should keep your TV selected to ANT-A so that you can use the TV features. When viewing premium channels, select ANT-B and tune the TV to channel 3 or 4 (whichever channel is vacant in your area), then use the converter box to change channels. You will need two coaxial cables.

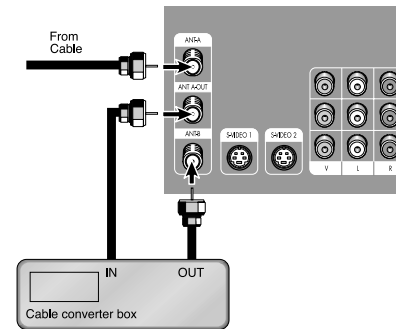

Note: When you use a converter box with your TV, there may be features that you can not program using the remote control, such as programming your favorite channels and blocking channels.

Connecting a Cable Converter Box and a VCR

This connection allows you to watch and record basic and premium cable channels, as well as watch videotapes. You should keep your TV selected to ANT-A so that you can use the TV's features. When viewing premium channels or recording with the VCR, select ANT-B (whichever channel is vacant in your area), then use the converter box to change channels.

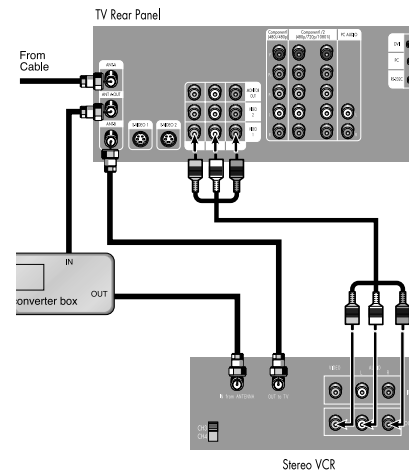

Caution: If you want to record one channel while watching another channel, a splitter (not included) must be added between the cable and ANT-A. One output of the splitter goes to ANT-A and the second output is connected to IN on the cable converter box.

If you have a mono VCR, connect L/Mono to VCR Audio OUT using only one audio cable.

If you have a S-VHS VCR, use the S-video connections and remove the video cable. Do not connect the video cable and the S-video cable to video1 simultaneously.

When you use a converter box with your TV there may be features that you can not program using the remote control, such as programming your favorite channels and blocking channels.

Connections

Connecting a Camcorder

The side panel jacks on your TV make it easy to connect a camcorder to your TV. You can use your camcorder to view tapes without using a VCR.

- 1 Locate the A/V output jacks on the camcorder. They are usually found on the side or back of the camcorder.

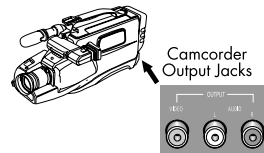

- 2 Connect an audio cable between the AUDIO OUTPUT jack on the camcorder and the AUDIO terminals on the side of the TV. If your camcorder is stereo, you must connect two separate cables. (The audio cables are usually included with the camcorder.)

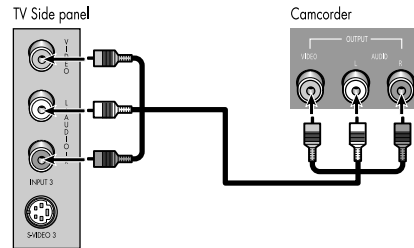

- 3 Connect a video cable between the VIDEO OUTPUT jack on the camcorder and the VIDEO terminal on the side of the TV. (A video cable is usually included with the camcorder.) To watch a tape, follow your camera's instructions and the section on "Viewing an External Signal Source" in this manual.

Connecting a DVD Player

The rear panel jacks on your TV make it easy to connect a DVD player to your TV.

Connecting to Y,Pb,Pr

- 1 Connect a set of audio cables between the Component1 AUDIO IN jacks on the TV and the AUDIO OUT jacks on the DVD player.

- 2 To enable Component video viewing, connect video cables between the Component1 (Y, Pb and Pr) jacks on the TV and Y, Pb and Pr (or Y, Cb, Cr) output jacks on the DVD player.

Note: For an explanation of Component video, see your DVD player's owner's manual.

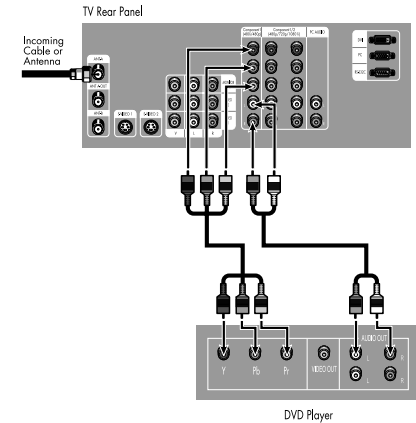

Connecting to audio and video jacks

- 1 Connect a set of audio cables between the AUDIO IN jacks on the TV and the AUDIO OUT jacks on the DVD player.

- 2 Connect video cables between the VIDEO OUT jack on the DVD player and the VIDEO IN jack on the TV.

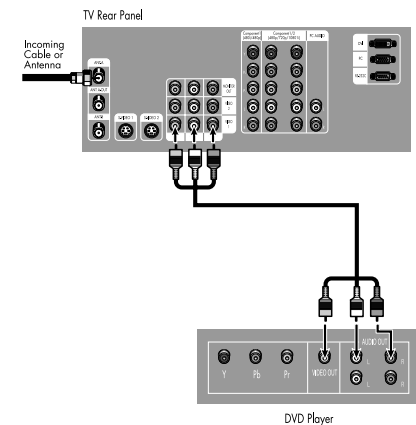

Connections

Connecting a DTV Set Top Box

Connecting to Y,Pb,Pr

- 1 Connect a set of audio cables between the Component2 or Component3 AUDIO IN jacks on the TV and the AUDIO OUT jacks on the Set Top Box.
- 2 Connect video cables between the Component2 or Component3 Y, Pb and Pr inputs on the TV and Y, Pb and Pr (or Y, Cb, Cr) outputs on the Set Top Box.
Note: For an explanation of Component video, see your Set Top Box owner's manual.

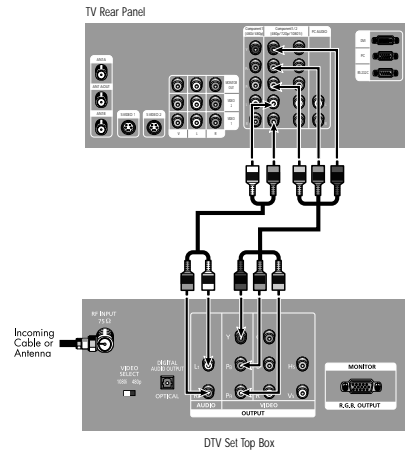

Connecting to R,G,B

- 1 Connect a set of audio cables between the PC AUDIO IN jacks on the TV and the AUDIO OUT jacks on the Set Top Box.
- 2 Connect video cables between the PC IN jack on the TV and the R.G.B OUT jack on the Set Top Box.

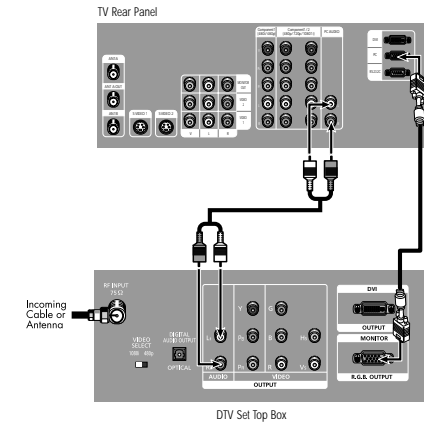

Connecting to DVI (Digital Visual Interface)

- 1 Connect a set of audio cables between the PC AUDIO IN jacks on the TV and the AUDIO OUT jacks on the Set Top Box.
- 2 Connect video cables between the DVI IN jack on the TV and the DVI OUT jack on the Set Top Box.

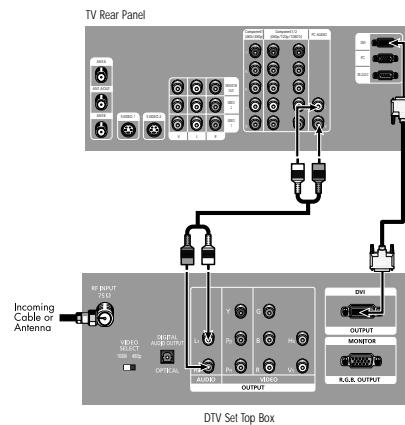



Operation



SAMSUNG

Operation

Turning the TV On and Off

Press the Power button on the remote control or on the side panel to turn your TV on and off.

Viewing the Menus and Displays

The on-screen menu system allows you to control the settings of your TV. Access the on-screen menu system by pressing the Menu button on the remote control. Once the on-screen menu appears, use the joystick button on your remote control to move between menu items, select menu items, and make adjustments. You can also view the on-screen menu system and make some adjustments using the TV's side panel buttons.



Displaying the Menus

- 1 With the power on, press the Menu button on the remote control. The main menu appears on the screen. The Video menu is selected.

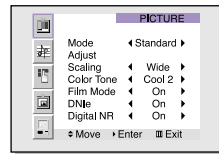

- 2 Use the joystick (up, down) or CH(▲, ▼) buttons to move to items in the menu. Use the joystick (right) or VOL(+) buttons to display, change, or use the selected items. Use the joystick (◀ or ▶) button to enter items in the menu.

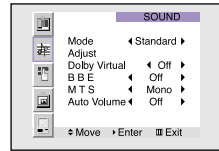

On-screen menus disappear from the screen automatically after about thirty seconds, or you can press the Menu button on your remote control to exit the menu.

Displaying Status Information

- 1 Press the Display button on the remote control. The TV will display the channel, current time, and the audio signal you are listening to.

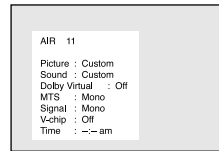

Selecting the Menu Language

Choose a language for the on-screen menus: English, Spanish or French.

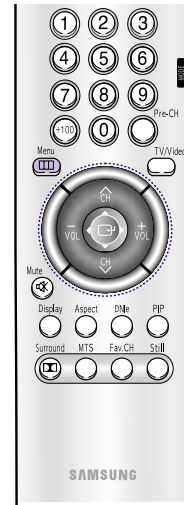

- 1 Press the Menu button. Move the joystick down to select SETUP, then press the joystick to enter.

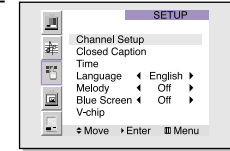

- 2 Move the joystick down to select "Language."

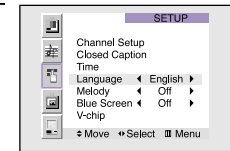

- 3 Move the joystick right or left to select the language. Press the Menu button on the remote control to exit the menu.

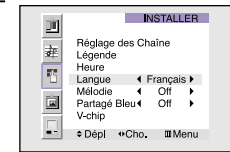

Selecting the Antenna Input

You can connect to two different signal sources by choosing the antenna input (ANT A or ANT B).

- 1 Press the Menu button. Move the joystick down to select SETUP, then press the joystick to enter.

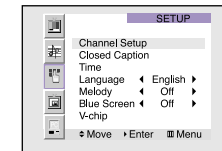

- 2 Press the joystick to enter. The channel setup menu will appear. The first line of the menu is selected.

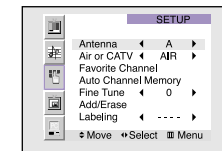

- 3 Move the joystick right or left to select "A" or "B". Press the Menu button on the remote control to exit the menu.

Operation

Channel Memory

Your TV can memorize and store all of the channels available. Once the channels are memorized, you can use the CH \wedge and CH \vee buttons to scan through the available channels.

Selecting the Broadcast Source

Before memorizing available channels, you must select what broadcast source your TV is connected to, either an antenna or a cable system.



- 1 Press the Menu button. Move the joystick down to select SETUP, then press the joystick to enter.

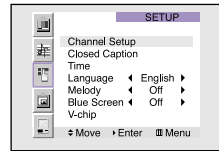

- 2 Press the joystick to enter. The channel setup menu will appear. Move the joystick down to select "Air or CATV".

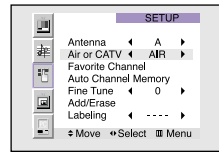

- 3 If you are connected to an antenna, leave "AIR" displayed. If you connected cable, press the joystick to the right to display the type of cable system: "STD," "HRC," or "IRC." (If you are not sure which type of cable system you have, contact your cable company.)

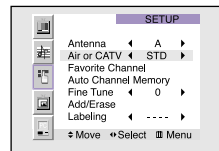

Storing Channels in Memory Automatically

- 1 First, select the broadcast source as described on the previous page. With the Channel Setup menu on screen, move the joystick down to select "Auto Channel Memory."

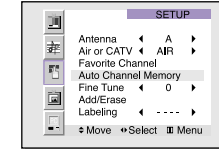

- 2 Press the joystick to enter. The TV will begin memorizing all of the available stations. Press the VOL+ button at any time to interrupt the memorization process.

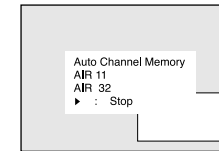

NOTE

- When the ANT B mode is selected, the auto programming runs on the main screen.

Adding and Erasing Channels

- 1 Use the number buttons to select the channel you want to add or erase.



- 2 To add a channel, select it and press the Add/Erase button on the remote control. The channel will be added to the TV's memory and the word "Channel added" will appear in the corner of the screen.

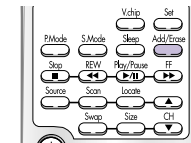

- 3 To erase a channel, select it and then press the Add/Erase button on the remote control. The word "Channel erased" will appear in the corner of the screen. You can still view a channel that has been erased from memory by using the number buttons on the remote control to select the channel directly.

Operation

Changing Channels

You can change channels on your TV by using the CH ^ and CH v buttons, or by direct selection using the number buttons. You can use the number buttons to tune to any channel (even one that has been erased or has not been memorized).



Using the Channel Buttons

Press the CH ^ or CH v buttons to change channels. The TV changes each channel in order, up or down, depending on which button you press. You will see all the channels that the TV has memorized. (The TV must have memorized at least three channels.) You will not see channels that were not memorized or have been erased.

Using the Number Buttons

To change to single-digit channels (0-9) faster, press "0" before the single digit.

Example: For channel 4, press "0," then "4."

To select a channel over 100, press the +100 button first.

Example: For channel 122, press "+100," then "2," then "2."

Using the Previous Channel

Press the Pre-ch button on the remote control. The TV changes to the last channel you were watching.

Scanning channels

You can automatically scan all of the channels in memory at the touch of just one button. Press the Scan button on the remote control. The TV will change the channels automatically, one by one. Scanning channels will be displayed in the PIP window. To stop channel scan, press the Scan button again.

NOTE

- When the ANT B mode is selected, the channel scan function doesn't work.

Selecting Your Favorite Channels

You can store up to ten of your favorite channels for each available input source (such as TV and CATV). Then, when you press the Fav.CH button on the remote control, the TV displays only the favorite channels you previously stored, allowing you to quickly and easily find frequently watched channels.



To Store Your Favorite Channels:

1 Press the Menu button. Move the joystick down to select SETUP, then press the joystick to enter.

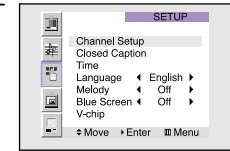

2 Press the joystick to enter. The channel setup menu will appear. Move the joystick down to select Air or CATV, then move the joystick to the right to display the type of cable system or Air.

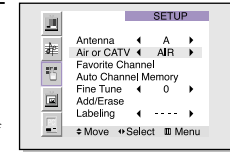

3 Move the joystick down to select "Favorite Channel", then press the joystick to enter.

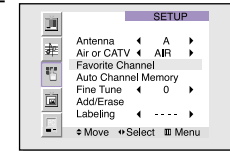

4 Move the joystick to the left or right to select channel. Note: Only memorized channels can be set as Favorite channels.

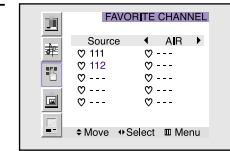

To View Your Favorite Channels:

Press the Fav.CH button repeatedly to jump from one favorite channel to another.

The favorite channels are selected in ascending sequence.

Operation

Labeling the Channels

Use this feature to assign an easy-to-remember label to any channel (i.e., "CBS", "ESPN", "PBS2", "CNN1", etc.) A label consists of four fields, where each field is a letter, a number, or a blank. When the DISPLAY button is pressed, the channel label will appear next to the channel number.



1 Press the CH \wedge or CH \vee button to tune to the channel that will be labeled.



2 Press the Menu button. Move the joystick down to select SETUP, then press the joystick to enter.

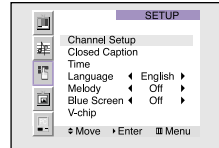

3 Press the joystick to enter. Move the joystick down to select Labeling.

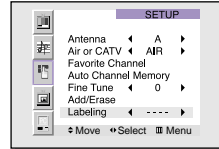

4 Move the joystick to the right to begin labeling. (Each label has four fields. See top paragraph.) Move the joystick up or down to select a letter, a number, or a blank. (Pressing the CH button results in this sequence: A,B,...Z, blank,0,1,...9).

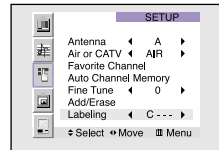

5 Move the joystick to the right to switch to the next field, which will be selected. Select a second letter or digit using joystick (up or down), as above. Repeat the process to select the last two digits. Press the Menu button to exit.

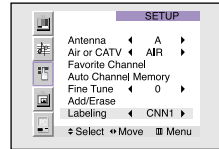

Setting The On/Off Melody

You can hear clear melody sound when the TV is powered On or Off.



1 Press the Menu button. Move the joystick down to select SETUP, then press the joystick to enter.

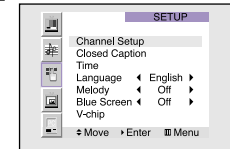

2 Move the joystick down to select Melody.

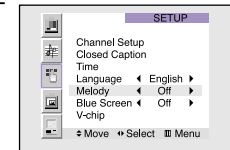

3 Move the joystick to the right or left to select "On".

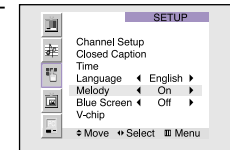

4 Press the Menu button to exit.

Operation

Picture Control

Using the remote, you can change the contrast, brightness, tint, color, and sharpness settings of the TV.



Customizing the Picture

- 1 Press the Menu button.
Press the joystick to enter.

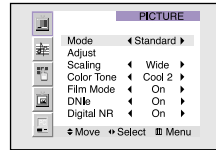

- 2 Move the joystick down to select Adjust, then press the joystick to enter. You will see the items "Contrast", "Brightness", "Sharpness", "Color" and "Tint".

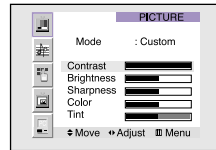

- 3 Move the joystick up or down to select the item you want to change.

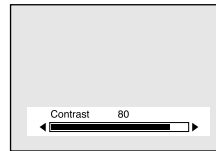

- 4 Move the joystick right or left to raise or lower the value of the item, using the on-screen gauge as your guide.

When you are finished adjusting an item, wait a moment. The level indicator will disappear and the Video menu will return. You can continue to make adjustments, or press the Menu button to exit.

Using Automatic ("Standard") Picture Settings

- 1 Press the P.Mode button on the remote control to change the picture settings.



- 2 Press P.Mode repeatedly to select the "Dynamic", "Standard", "Movie" or "Custom" picture setting.

Guide to Automatic Picture Settings

- Choose Standard to set the TV to operate at top performance according to your TV's specifications.
- Choose Dynamic for viewing the TV during the day or when there is bright light in the room.
- Choose Movie when viewing the movie.
- Choose Custom if you want to adjust the settings yourself.

Operation

Sound Control

You can control and customize the sound levels and settings of the TV with the remote control. Using the on-screen menus, you can change the TV's bass, treble, and balance settings.



Adjusting the Volume

Press VOL + to raise the volume or VOL - to lower the volume.

Using the Mute Button

Press the Mute button on the remote control to silence the volume. The word "Mute" will appear in the lower left corner of the screen.

To turn mute off, press the Mute button again, or raise or lower the volume with the VOL - and VOL + buttons.

Customizing the Sound

1 Press the Menu button. Move the joystick down to select SOUND, then press the joystick to enter.

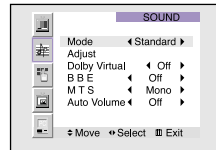

2 Move the joystick down to select Adjust, then press the joystick to enter. You will see the items "Bass", "Treble" or "Balance".

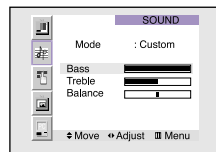

Continued...

3 Move the joystick up or down to select the item you want to change.

4 Move the joystick right or left to raise or lower the value of the item, using the on-screen gauge as your guide.

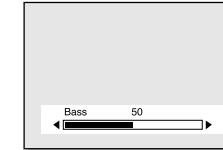

You can continue to make adjustments, or press the Menu button to exit.

Using Automatic(Standard) Sound Settings

1 Press the S.Mode button on the remote control to change the automatic sound setting.



2 Press the S.Mode button again to select the "Standard", "Music", "Movie", "Speech" or "Custom" sound setting.

Guide to Automatic Sound Settings

- Choose Standard for the "factory" settings (the best choice for most people).
- Choose Music when watching music videos or concerts.
- Choose Movie when watching a movie.
- Choose Speech when watching a show that is mostly dialogue, like a news show.
- Choose Custom if you want to adjust the settings yourself.

Operation

Setting the Clock

This TV has a built-in clock that will appear on screen when you press the Display button on the remote control. Setting this clock also allows you to use it to automatically turn the TV on or off.



1 Press the Menu button. Move the joystick down to select SETUP, then press the joystick to enter.

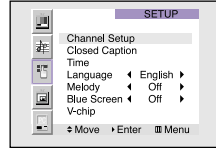

2 Move the joystick down to select Time, then press the joystick to enter.

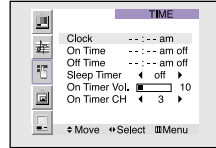

3 Move the joystick right to select the hour. Move the joystick up or down to select the correct hour.

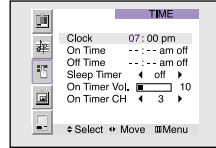

4 Move the joystick right to select the minute. Move the joystick up or down to select the correct minute. When selecting the hours, be sure to select the proper time of day (am or pm).

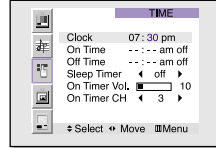

5 Press Menu to exit the menus.

Setting the Timers

This TV can be set to turn on or off automatically at specific times that you choose. Before using the timers, you must set the TV's clock, as described previously.

Setting the On/Off Timer

1 Press the Menu button. Move the joystick down to select SETUP, then press the joystick to enter.

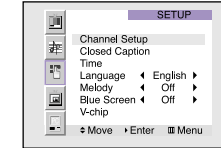

2 Move the joystick down to select Time, then press the joystick to enter.

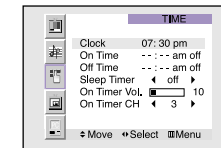

3 Move the joystick down to select the "On Time". Move the joystick right to select the hour, then Move the joystick up or down to adjust the hour for the TV to turn on. When selecting the hours, be sure to select the proper time of day (am or pm).

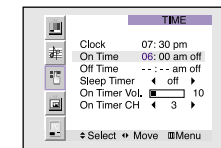

4 Move the joystick right to select the minute. Move the joystick up or down to adjust the minute.

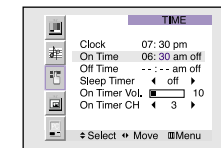

Continued...

Operation

- 5 Move the joystick right to select off, then move the joystick up or down to select "On".
When any of the timers are set, the "Timer" LED will illuminate (front or side panel of TV).

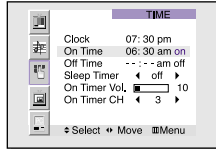

- 6 When you are finished, move the joystick right.

- 7 If you want to set the Off time, move the joystick down to select the "Off Time". Set the "Off Time" just as you set the "On Time".

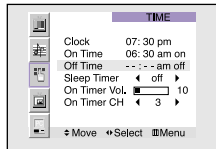

- 8 If you want to set the volume level or channel when the TV turns on, move the joystick down to select "On Timer Vol." or "On Timer CH". Move the joystick right to set the volume level or to select the channel you want when the TV turns on. Press the Menu button to return to normal viewing.

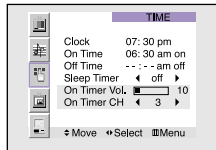

Setting the Sleep Timer

You can set your TV to automatically turn off after a preset interval.

- 1 Press the Sleep button on the remote control.



- 2 You'll see "Off" at the bottom of the screen. Press the Sleep button to select the time interval for the TV to stay on. The interval ranges from 10 to 360 minutes.

Viewing an External Signal Source

Selecting the Signal Source

Use the remote control to switch between viewing signals from connected equipment, such as VCRs, DVD, Set-Top box and the TV source (broadcast or cable).



- 1 Make sure that the remote control is controlling the TV set. Press the MODE button and make sure that the "TV" LED is illuminated.



- 2 Press TV/VIDEO on the remote control, and the following on-screen menu will appear.

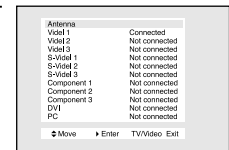

- 3 Move the joystick up or down to select a particular signal source, and then press the joystick to activate it.

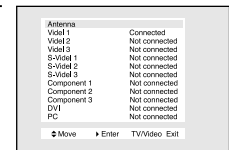

When you connect equipment to the TV, you can choose between the following sets of jacks: Video 1, Video 2, S-video 1, S-video 2, Component 1, Component 2, Component 3, DVI or PC on the TV's rear panel, and Video 3 or S-Video 3 on the TV's side panel.

Remote Control VCR/DVD Buttons

Flip the cover of the remote control up to access buttons that can control the tape functions of a connected VCR or DVD, including Rewind, Play, Fast Forward, Stop and Pause.

- 1 Flip the cover of your remote control unit for access to the tape function controls. Press the appropriate buttons to control your VCR or DVD.

SAMSUNG

Special Features

Special Features

Setting Up Your Remote Control

This TV's remote control can operate almost any VCR, cable box, or DVD. After it has been set up properly, your remote control can operate in four different modes: TV, VCR, Cable, or DVD. Pressing the corresponding button on the remote control allows you to switch between these modes, and control whichever piece of equipment you choose.

Note

The remote control might not be compatible with all DVD Players, VCRs and Cable boxes.



Setting Up the Remote to Operate Your VCR

- 1 Turn off your VCR.
- 2 Press the MODE button and make sure that the VCR LED is illuminated.
- 3 Press the Set button on your TV's remote control.
- 4 Using the number buttons on your remote control, enter three digits of the VCR code listed on page 47 of this manual for your brand of VCR. Make sure you enter three digits of the code, even if the first digit is a "0". (If more than one code is listed, try the first one.)
- 5 Press the Power button on the remote control. Your VCR should turn on if your remote is set up correctly.

If your VCR does not turn on after set up, repeat steps 2, 3, and 4, but try one of the other codes listed for your brand of VCR. If no other codes are listed, try each VCR code, 000 through 089.

Note on Using Remote Control Modes: VCR

- When your remote control is in "VCR" mode, the volume buttons still control your TV's volume.

Setting Up the Remote to Operate Your Cable Box



- 1 Turn off your cable box.
- 2 Press the MODE button and make sure that the Cable LED is illuminated.
- 3 Press the SET button on your TV's remote control.
- 4 Using the number buttons on your remote control, enter three digits of the cable box code listed on page 47 of this manual for your brand of cable box. Make sure you enter three digits of the code, even if the first digit is a "0." If there is more than one code listed, try the first one.
- 5 Press the Power button on the remote control. Your cable box should turn on if your remote is set up correctly.

If your cable box does not turn on after set up, repeat steps 2, 3, and 4, but try one of the other codes listed for your brand of cable box. If no other codes are listed, try each code, 000 through 077.

Note on Using Remote Control Modes: Cable Box

- When your remote control is in "Cable Box" mode, the volume buttons still control your TV's volume.

Special Features

Setting Up the Remote to Operate Your DVD



- 1 Turn off your DVD.
- 2 Press the MODE button and make sure that the DVD LED is illuminated.
- 3 Press the SET button on your TV's remote control.
- 4 Using the number buttons on your remote control, enter three digits of the DVD code listed on page 47 of this manual for your brand of DVD. Make sure you enter three digits of the code, even if the first digit is a "0." If there is more than one code listed, try the first one.
- 5 Press the Power button on the remote control. Your DVD should turn on if your remote is set up correctly.

If your DVD does not turn on after set up, repeat steps 2, 3, and 4, but try one of the other codes listed for your brand of DVD. If no other codes are listed, try each code, 000 through 008.

Note on Using Remote Control Modes: DVD

- When your remote control is in "DVD" mode, the volume buttons still control your TV's volume.

Remote Control Codes

VCR Codes

Admiral	006, 079	KLH	073	RCA	000, 005, 007, 008, 028, 035, 037, 054, 069
Aiwa	015	LG	009, 014, 046, 060	Samsung	007, 013, 022, 032, 042, 077
Akai	017, 022, 023, 027, 030	Lloyd	015	Sansui	016
Audio Dynamics	014, 016	Logik	031	Sanyo	002, 012
Bell & Howell	002	LXI	015	Scott	013, 041, 049, 068
Brokronic	010	Magnavox	008, 029, 053, 056	Sears	002, 005, 009, 012, 018, 019, 035, 043, 048
Candle	007, 009, 013, 045, 046, 052	Marantz	002, 008, 014, 016, 029, 030, 046, 061	Sharp	006, 027, 039, 045
Cannon	008, 053	MEI	008	Shintom	017, 026, 031, 055
Citizen	007, 009, 013, 045, 046, 052	Memorex	008, 009, 012, 015	Signature	015
Colortyme	014	MGA	027	Sony	017, 026, 038
Craig	007, 012	Midland	032	Sylvania	008, 015, 029, 053, 056
Curtis-Mathes	000, 007, 008, 014, 015, 046, 053, 064, 067	Minota	005, 035	Symphonic	015
Daewoo	013, 045, 076	Mitsubishi	005, 027, 035, 040	Tandy	002, 015
DBX	014, 016	Montgomery ward	006	Tashiko	009
Dimensia	000	MTC	007, 015	Tatung	030
Dynatech	015	Multitech	007, 015, 031, 032	Teac	015, 030, 069
Electrohome	027	NEC	002, 014, 016, 030, 046, 061, 064	Technics	008
Emerson	008, 009, 010, 013, 015, 020, 023, 027, 034, 041, 042, 047, 049, 057, 062, 065, 067, 068, 070	Optimus	006	Termin	008, 009, 015, 021
Fisher	002, 012, 018, 019, 043, 048, 058	Panasonic	008, 053, 075, 077	TMK	067
Funai	015	Pentax	005, 035	Toshiba	005, 013, 019, 048, 049
GE	000, 007, 008, 032, 053	Pentax Reserch+	046	Totevision	007, 009
Go Video	007	Philco	008, 029, 053, 056	Unitech	007
Harman Kardon	014	Philips	008, 029	Vector Research	014, 016
Hitachi	005, 015, 035, 036	Pioneer	005, 016, 033, 050	Victor	016
Instant Replay	008	Portland	044, 045, 052	Video Concepts	014, 016
JC Penney	002, 005, 007, 008, 014, 016, 030, 035, 051, 053	ProScan	000	Videosonic	007
JCL	008, 002, 014, 016, 030, 046	Quartz	002	Wards	005, 006, 007, 008, 009, 012, 013, 015, 027, 031, 035
JVC	002, 014, 088, 089	Quasar	008, 053	Yamaha	002, 014, 016, 030, 046
Kenwood	002, 014, 016, 030, 046	Radio Shack/Realistic	002, 006, 008, 009, 012, 015, 019, 027, 045, 053	Zenith	011, 017, 026, 079

Cable Box Codes

Anvision	007, 008	NSC	009	Signature	046
Cablestar	007, 008	Oak	016, 038	Sprucer	027
Eagle	007, 008	Osk Sigma	016	Starcom	046
Eastern Int.	002	Panasonic	003, 027, 039, 061, 073, 074	Stargate 2000	058
General Instrument	046	Philips	007, 008, 019, 021, 026, 028, 029, 032, 033, 040, 041	Sylvania	011, 059
GI	004, 005, 015, 023, 024, 025, 030, 036, 067, 068, 069	Pioneer	018, 020, 044, 074, 077	Texscan	031, 032, 041
Hamlin	003, 012, 013, 034, 048	Randtek	007, 008	Tocom	017, 021, 049, 050, 055, 073
Hitachi	037, 043, 046	RCA	000, 027, 066	Universal	051, 052
Jerrold	004, 005, 015, 023, 024, 025, 030, 036, 046, 062, 065	Regal	003, 012, 013	Viewster	007, 008, 019, 021, 026, 028, 029, 032, 033, 040, 041
Macom	037, 043	Regency	002, 033	Warner Amex	044
Magnavox	007, 008, 019, 021, 026, 028, 029, 032, 033, 040, 041	SA	070, 071, 072	Zenith	014, 042, 057, 061, 075, 076
		Samsung	044, 003, 022, 063, 064		

DVD Codes

Philips	001
Proscan	002
RCA	002
Toshiba	003
Panasonic	004
Sony	008
Samsung	000

Special Features

Fine Tuning Channels

Fine tuning lets you manually adjust the TV's tuner if you have difficulty tuning in a channel.



- Using the number buttons on the remote control, select the channel you want to fine tune.

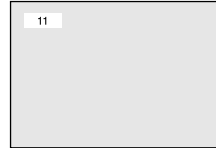

- Press the Menu button on the remote control. Move the joystick down to select SETUP, then press the joystick to enter.

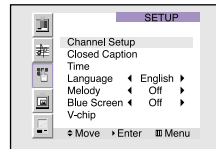

- Press the joystick to enter in the Channel setup menu.

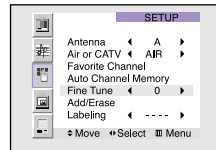

- Move the joystick down to select the Fine tune, then move the joystick right or left to adjust the fine tuning. To store the fine tuning setting in the TV's memory, move the joystick up. (A heart icon will appear.)

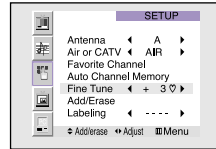

To reset the fine tuning to "0," move the joystick down .

- Press the Menu button to exit.

Selecting the Color Tone



- Press the Menu button. Press the joystick to enter.

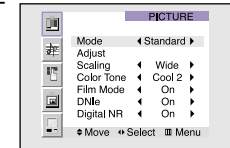

- Move the joystick down to select Color Tone, then move the joystick right repeatedly to select "Normal", "Warm1", "Warm2", "Cool2" or "Cool1".

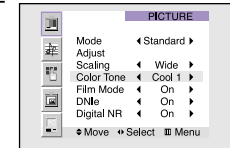

- Press the Menu button to exit.

Setting the Film Mode

On: Automatically senses and processes film signals from all sources and adjusts the picture for optimum quality.
Off: Switches off the Film mode.

- Press the Menu button. Press the joystick to enter.

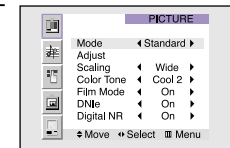

- Move the joystick down to select Film Mode, then move the joystick to the right or left to select "On" or "Off".

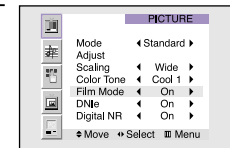

- Press the Menu button to exit. Note: Film mode is supported in 480i only.

Special Features

DNle™ (Digital Natural Image engine) **DNle™**

Samsung's New Technology enables an improved image with detail, contrast and white enhancement and 3D noise reduction.



- 1 Press the Menu button.
Press the joystick to enter.

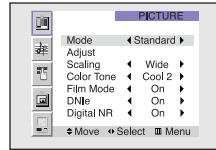

- 2 Move the joystick down to select DNle, then move the joystick to the right or left to select "On", "Demo" or "Off".
Quick way to access DNle: Just press the "DNle" button on the remote control to select "DNle On" or "DNle Demo".

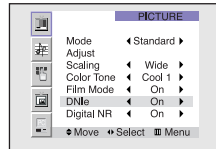

- 3 Press the Menu button to exit.

Guide to DNle Settings

- On: Switches on the DNle mode.
- Demo: The screen before applying DNle appears on the right and the screen after applying DNle appears on the left.

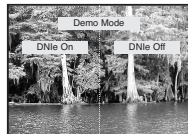

- Off: Switches off the DNle mode.

NOTE

- The DNle function doesn't operate in the PC and DVI modes.

Digital Noise Reduction

If the broadcast signal received by your TV is weak, you can activate the Digital Noise Reduction feature to help reduce any static and ghosting that may appear on the screen.



- 1 Press the Menu button.
Press the joystick to enter.

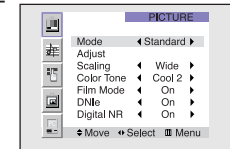

- 2 Move the joystick down to select Digital NR, then move the joystick to the right or left to select "On" or "Off".

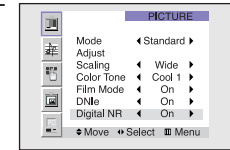

- 3 Press the Menu button to exit.

Special Features

Setting the Blue Screen Mode

If no signal is being received or the signal is very weak, a blue screen automatically replaces the noisy picture background. If you wish to continue viewing the poor picture, you must set the "Blue screen" mode to "Off".



- 1 Press the Menu button on the remote control. Move the joystick down to select SETUP, then press the joystick to enter.

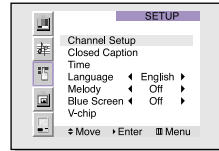

- 2 Move the joystick down to select Blue Screen.

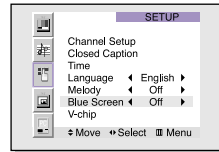

- 3 Move the joystick to the right or left to select "On" or "Off".

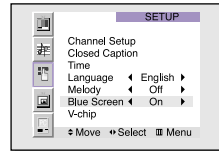

- 4 Press the Menu button to exit.

Changing the Screen Size

When you press the ASPECT button on the remote control, the TV's screen mode choices appear in sequence. The screen displays in this order: Wide, Panorama, Zoom1, Zoom2, Normal. The name of the screen mode will be displayed at the bottom of the TV screen.



Wide

Sets the picture to 16:9 wide mode.

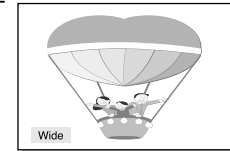

Panorama

Use this mode for the wide aspect ratio of a panoramic picture.

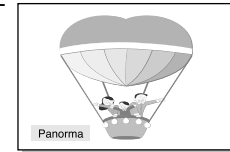

Zoom1

Magnifies the size of the picture on screen. You can also move the picture on screen using the "Scroll" function. Press the CH (^, v) buttons to scroll the picture.

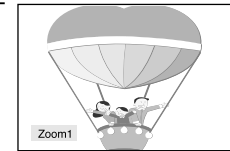

Zoom2

Magnifies the size of the picture more than Zoom1. You can also move the picture on screen using the "Scroll" function. Press the CH (^, v) buttons to scroll the picture.

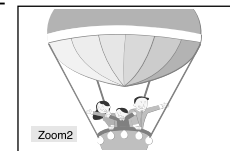

Normal

Sets the picture to 4:3 normal mode. This is a standard TV screen size. Note: If you watch the screen in the 4:3 aspect ratio format for a long time, images may be burned on to the screen.

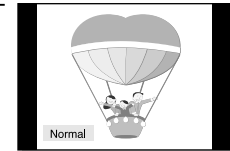

continued...

Special Features

NOTES

- You can select only Wide, Normal(4:3) screen size in the Component Mode.
- Screen size can't be changed in the DVI and PC (1080i) mode.
- You can select Wide(TV), Wide(PC) screen size in the DVI and PC (720p) Mode.
- You can select Wide(TV), Wide(PC), Normal(4:3) screen size in the DVI and PC (480p) Mode.
- If you set PIP ON in any mode (Normal, Panorama, Zoom1, Zoom2) except Wide, the mode will automatically change to Wide.

Special Audio Options

MTS Settings: Choosing a Soundtrack

Depending on the particular program being broadcast, you can listen to stereo, mono, or a Separate Audio Program. (SAP audio is usually a foreign-language translation. Sometimes SAP has unrelated information like news or weather.)



Guide to MTS Settings

- 1 Press the Menu button. Move the joystick down to select SOUND, then press the joystick to enter.

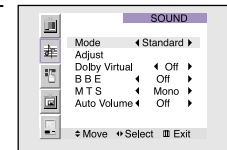

- 2 Move the joystick down to select MTS.

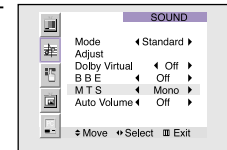

- 3 Move the joystick to the right repeatedly to select "Mono", "SAP" or "Stereo".

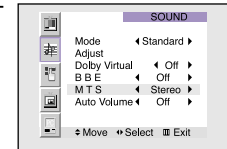

- 4 Press the Menu button to exit.

- Choose Stereo for channels that are broadcasting in stereo.
- Choose Mono for channels that are broadcasting in mono, or if you are having difficulty receiving a stereo signal.
- Choose SAP to listen to the Separate Audio Program, which is usually a foreign-language translation.

Special Features

Dolby Virtual

This feature allows the TV's L/R speakers to provide a home Theater-like Dolby effect. The center and surround sounds are mixed into the L/R speakers.



1 Press the Menu button. Move the joystick down to select SOUND, then press the joystick to enter.

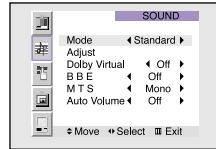

2 Move the joystick down to select Dolby Virtual.

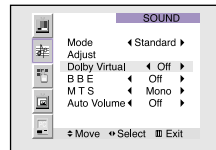

3 Move the joystick to the right or left to select "Virtual" or "Off".

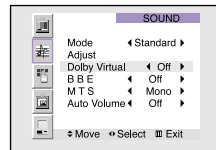

4 Press the Menu button to exit.

NOTE

- Dolby Virtual and BBE can't be set ON at the same time.

BBE

BBE is a built-in effect that adds clarity, punch and dynamics to the sound.



1 Press the Menu button. Move the joystick down to select SOUND, then press the joystick to enter.

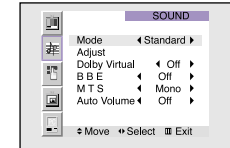

2 Move the joystick down to select BBE.

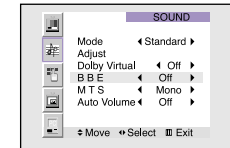

3 Move the joystick to the right or left to select "On" or "Off".

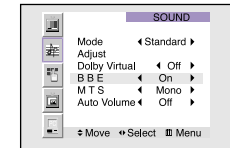

4 Press the Menu button to exit.

NOTE

- Dolby Virtual and BBE can't be set ON at the same time.

Special Features

Auto Volume

Each broadcasting station has its own signal conditions, and it is inconvenient to adjust the volume every time the channel is changed. "Auto volume" automatically adjusts the volume of the desired channel by lowering the sound output when the modulation signal is high or by raising the sound output when the modulation signal is low.



- 1 Press the Menu button. Move the joystick down to select SOUND, then press the joystick to enter.

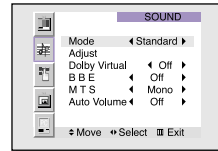

- 2 Move the joystick down to select Auto Volume.

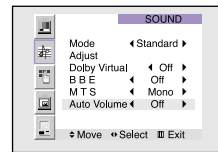

- 3 Move the joystick to the right or left to select "On" or "Off".

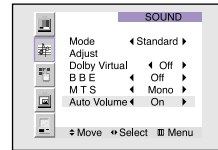

- 4 Press the Menu button to exit.

Viewing Closed Caption Information

Your TV decodes and displays the closed captions information that is broadcast along with some television shows. These captions are usually subtitles for the hearing impaired or translations into other languages. All VCRs record the closed caption signal from television programs, so pre-recorded video tapes can also deliver closed-caption information. Check for the closed caption symbol (CC) on the tape's package or your TV program-schedule.



Closed Captions

- 1 Press the Menu button. Move the joystick down to select SETUP, then press the joystick to enter.

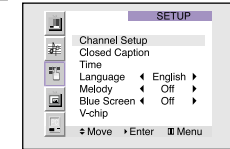

- 2 Move the joystick down to select Closed Caption, then press the joystick to enter.

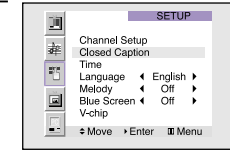

- 3 Move the joystick right or left to turn closed captioning on/off. Misspelling and unusual characters sometimes occur in closed caption transmissions, especially those of live events. There may be a small delay before captions appear when you change channels. (These do not indicate the TV is malfunctioning.) Move the joystick down to select the "Mode". Move the joystick right or left to choose "Caption" or "Text." In caption mode, captions appear at the bottom of the screen, and they usually cover only a small portion of the picture. In text mode, information unrelated to the program, such as news or weather, is displayed. Text often covers a large portion of the screen.

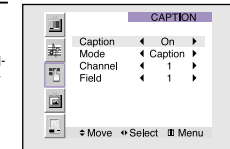

- 4 If you wish, use the joystick button to change the captioning channel or field. Then, press Menu to return to normal viewing. Different channels and fields display different information. For example, Channel 1 may have subtitles in English, while Channel 2 has subtitles in Spanish.

NOTE

- The Caption function doesn't operate in Zoom1, Zoom2.

Special Features

Viewing Picture-in-Picture

One of the most best features of your TV is the Picture-in-Picture (PIP) feature. The advanced PIP system allows you to watch two different pictures at once, even if you don't have a VCR connected to your TV.



Selecting a PIP Screen

1 Press the Menu button. Move the joystick down to select PIP, then press the joystick to enter. Quick way to access PIP: Just press "PIP" on the remote control.

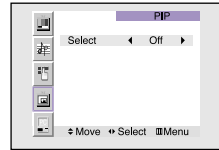

2 Move the joystick right to select PIP "On". The PIP image will appear in the corner of the screen.

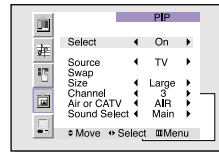

3 Press Menu to exit.

NOTES

- Picture-in-Picture doesn't function when the V-chip is active.
- If you turn the TV off while watching and turn it on again, then the mode will return to normal video.
- Screen size can't be changed in the PIP mode.

Selecting an External Signal

You can use PIP to view a signal from an external source, such as a VCR.



1 Press the Menu button. Move the joystick down to select PIP, then press the joystick to enter. Quick way to access PIP source: Just press "Source" on the remote control.

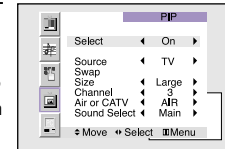

2 Move the joystick down to select "Source".

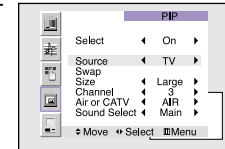

3 Move the joystick right or left to select an external signal. You can choose between "TV", "Video 1-3", or "S-Video 1-3".

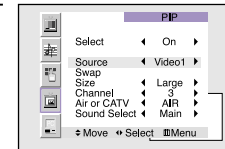

The signal from these inputs will not appear if you have not connected any equipment to the TV's input jacks. For more information about external signals, see "Viewing an External Signal Source" (See page 41). If you select "TV," the PIP image is the same as the main image.

4 Press Menu to exit.

NOTE

- The PIP subscreen doesn't support ANT-B, Component1, Component2, Component3, PC, and DVI.

Special Features

Selecting a Signal Source (Antenna or Cable) for PIP

If the PIP source is TV during PIP ON, you can select the broadcasting source of PIP picture separately from the main picture. (If the main picture is ANT-B and the broadcasting sources are different, making adjustments is necessary.)



- 1 Press the Menu button. Move the joystick down to select PIP, then press the joystick to enter.

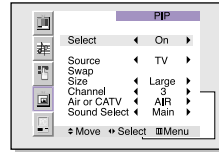

- 2 Move the joystick down to select "Air or CATV".

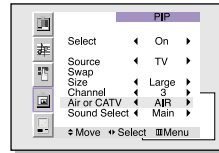

- 3 If an antenna is connected, the setting is "AIR." If a Cable TV system is providing the signal, move the joystick to the left or right until the appropriate type of cable system is displayed ("STD," "HRC," or "IRC").

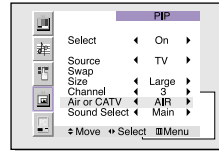

- 4 Press Menu to exit.

Swapping the Contents of the PIP and Main image



- 1 Press the Menu button. Move the joystick down to select PIP, then press the joystick to enter. Quick way to access PIP Swap: Just press "Swap" on the remote control.

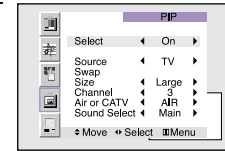

- 2 Move the joystick down to select "Swap".

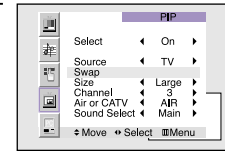

- 3 Move the joystick to the right or left. The channel in the PIP image will appear in the main image, and vice versa.

- 4 Press Menu to exit.

NOTE

- When ANT-B, Component mode, PC, or DVI is selected, the PIP Swap function doesn't work.

Special Features

Changing the Size of the PIP image



1 Press the Menu button. Move the joystick down to select PIP, then press the joystick to enter. Quick way to access PIP Size: Just press "Size" on the remote control.

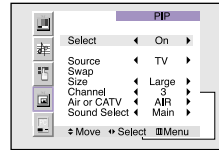

2 Move the joystick down to select "Size".

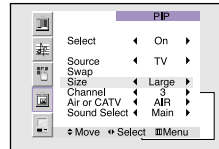

3 Move the joystick to the right or left to select "Large", "Double1", "Double2" or "Small".

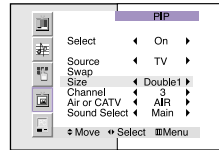

Note: Double function doesn't operate In the Component, PC, DVI mode.

4 Press Menu to exit.

Changing the Picture-in-Picture Channel

After you set the PIP signal source (antenna or cable), it is easy to change channels.



1 Press the Menu button. Move the joystick down to select PIP, then press the joystick to enter. Quick way to access PIP channel: Just press "PIP CH" (▲, ▼)" on the remote control.

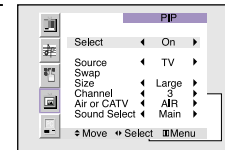

2 Move the joystick down to select "Channel".

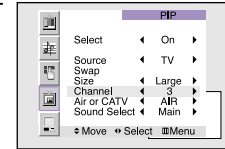

3 Move the joystick to the right or left to change the channel of the PIP image.

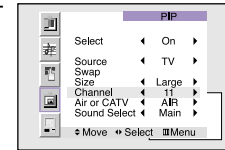

4 Press Menu to exit.

NOTE

- The PIP channels are not available when RF is set to ANT-B. (The PIP channels link to ANT-A).

Special Features

Selecting the Sound Source

You can use this feature to hear sound from the Main or PIP screen.



- 1 Press the Menu button. Move the joystick down to select PIP, then press the joystick to enter.

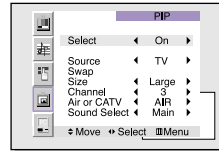

- 2 Move the joystick down to select "Sound Select".

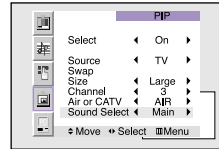

- 3 Move the joystick to the right or left to switch Main or Sub audio source. Main is for the main TV picture audio, and Sub is for the PIP picture audio.

- 4 Press Menu to exit.

Changing the Location of the PIP image

Press the Locate button repeatedly to move the PIP image from corner to corner on the screen.

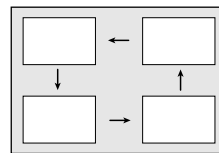

Using the V-Chip

The V-Chip feature automatically locks out programming that is deemed inappropriate for children.

The user must first enter a PIN (personal ID number) before any of the V-Chip restrictions can be set up or changed.

Note: The V-chip doesn't function when the Picture-in-Picture is active.

Setting Up Your Personal ID Number (PIN)



- 1 Press the Menu button. Move the joystick down to select SETUP, then press the joystick to enter. Quick way to access the V-chip: Just press "V-chip" on the remote control.

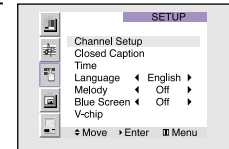

- 2 Move the joystick down to select V-chip, then press the joystick to enter.

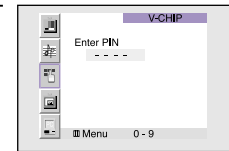

The "Enter PIN" screen will appear. Enter your 4-digit PIN number.

Note: The default PIN number for a new TV set is "0-0-0-0."

- 3 After entering a valid PIN number, the "V-chip" screen will appear. Move the joystick down to select "Change PIN", then press the joystick to enter. The Change pin screen will appear. Choose any 4-digits for your PIN and enter them. As soon as the 4 digits are entered, the "Confirm new PIN" screen appears. Press MENU to exit.

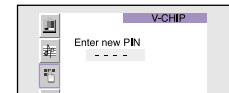
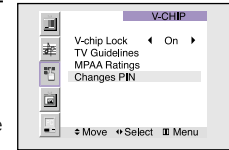

NOTE

- If you forget the PIN, press the remote-control keys in the following PIN sequence, which resets the pin to 0-0-0-0: POWER OFF → Mute → 8 → 2 → 4 → POWER ON.

Special Features

How to Enable/Disable the V-Chip



- 1 Press the Menu button. Move the joystick down to select SETUP, then press the joystick to enter.

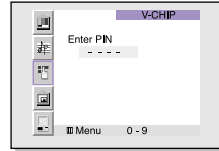

Move the joystick down to select V-chip, then press the joystick to enter. The "Enter PIN" screen will appear. Enter your 4-digit PIN number.

- 2 The "V-Chip" screen will appear, and "V-Chip Lock" will be selected. To enable the V-Chip feature, move the joystick right so that the "V-Chip Lock" field is On. (Moving the joystick to the right or left will alternate between On and Off.)

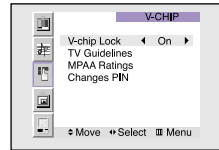

How to Set up Restrictions Using the "TV guidelines"

First, set up a personal identification number (PIN), and enable the V-Chip. (See previous section.) Parental restrictions can be set up using either of two methods: The TV guidelines or the MPAA rating.

- 1 Press the Menu button. Move the joystick down to select SETUP, then press the joystick to enter.

Move the joystick down to select V-chip, then press the joystick to enter. The "Enter PIN" screen will appear. Enter your 4-digit PIN number.

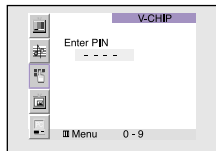

- 2 The "V-Chip mode" screen will appear. Move the joystick down to select "TV guidelines", then press the joystick to enter.

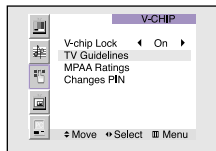

- 3 The "TV guidelines" screen will appear. Move the joystick up or down to highlight one of the six age-based categories:

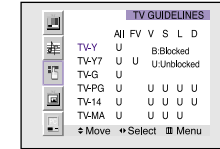

TV-Y	Young children
TV-Y7	Children 7 and over
TV-G	General audience
TV-PG	Parental guidance
TV-14	Viewers 14 and over
TV-MA	Mature audience

Note: These categories consist of two separate groups: TV-Y and TV-Y7 (young children through age 7), and TV-G through TV-MA (everybody else). The restrictions for these two groups work independently: If a household includes very young children as well as young adults, the TV guidelines must be set up separately for each age group. (See next step.)

- 4 At this point, one of the TV-Ratings is selected. Move the joystick right: Depending on your existing setup, a letter "U" or "B" will be selected. (U: Unblocked, B: Blocked).

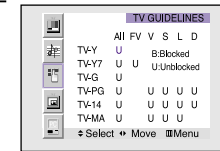

Move the joystick down or up to block or unblock the category. Move the joystick to the right. To select a different TV-Rating, move the joystick down or up and then repeat the process.

Note 1: TV-Y7, TV-PG, TV-14 and TV-MA have additional options. See the next step to change any of the following sub-ratings:
FV:Fantasy violence, D:Dialog, L:Language, S:Sexual situation, V:Violence .

Note 2: The V-Chip will automatically block certain categories that are "more restrictive." For example, if you block "TV-Y" category, then TV-Y7 will automatically be blocked. Similarly, if you block the TV-G category, then all the categories in the "young adult" group will be blocked (TV-G, TV-PG, TV-14 and TV-MA). The sub-ratings (D, L, S, V) work together similarly. (See next section.)

Continued...

Special Features

- 5 How to set the FV, D, L, S and V sub-ratings: First, select one of these TV-Ratings: TV-Y7, TV-PG, TV-14 or TV-MA (See Step 4, on previous page.) Next, while the TV-Rating is selected, repeatedly move the joystick right. This will cycle through the available sub-ratings (FV, L, S, D or V). A letter (“U” or “B”) will be displayed for each sub-rating. While the “U” or “B” is selected, move the joystick down or up to change the sub-rating.

Note: The V-chip will automatically block certain categories that are “More restrictive”. For example, if you block “L” sub-rating in TV-PG, then the “L” sub-ratings in TV-14 and TV-MA will automatically be blocked.

- 6 Press the Menu button to clear all the screens. (Or proceed to the next section, and set up additional restrictions based on the MPAA codes).

How to Set up Restrictions Using the MPAA Ratings: G, PG, PG-13, R, NC-17, X

The MPAA rating system uses the Motion Picture Association of America (MPAA) system, and its main application is for movies. (Eventually, movie videocassettes will be encoded with MPAA ratings.) When the V-Chip lock is on, the TV will automatically block any programs that are coded with objectionable ratings (either MPAA or TV-Ratings).



- 1 Press the Menu button. Move the joystick down to select SETUP, then press the joystick to enter. Move the joystick down to select the V-chip, then press the joystick to enter. The “Enter PIN” screen will appear. Enter your 4-digit PIN number.

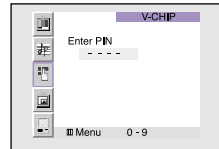

- 2 The “V-Chip” screen will appear. Move the joystick down to select “MPAA rating”, then press the joystick to enter.

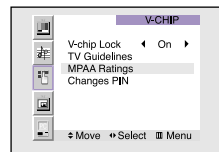

- 3 The “MPAA Ratings” screen will appear.

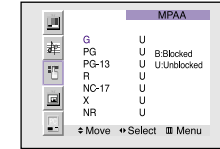

- 4 Repeatedly move the joystick down to highlight a particular MPAA category. The MPAA categories are as follows.

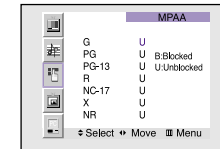

G	General audience (no restrictions).
PG	Parental guidance suggested.
PG-13	PG-13 (Parents strongly cautioned).
R	R (Restricted. Children under 17 should be accompanied by an adult).
NC-17	No children under age 17.
X	X (Adults only).
NR	Not rated.

While a particular category is highlighted, move the joystick to the right to activate it. A letter (“U” or “B”) will be displayed. Move the joystick down or up to select “U” or “B”. Press Menu button to save the settings and to clear all screens.

Note: The V-Chip will automatically block any category that is “more restrictive.” For example, if you block the “PG-13” category, then “R”, “NC-17”, and “X” will automatically be blocked also.

How to Reset the TV after the V-Chip Blocks a Channel (“Emergency Escape”)

If the TV is tuned to a restricted channel, the V-Chip will block it. The screen will go blank and the following message will appear: “Excessive rating.”

To resume normal viewing, tune to a different channel using the number buttons. Under certain conditions (depending on the rating of the local TV programs) the V-Chip might lock out all the channels. In this case, use the V-Chip button for an “emergency escape”:

Press the Menu button. Move the joystick down to select “SETUP”, then press the joystick to enter. Move the joystick down to select “V-chip”, then press the joystick to enter. Enter your PIN number, and move the joystick right to temporarily disable the V-Chip Lock.

PC Display

SAMSUNG

PC Display

Using Your TV as a Computer (PC) Display

How to connect Your PC to the TV

Note: This figure shows the Standard Connector-jack panel. The actual configuration on your TV may be different, depending on the model.

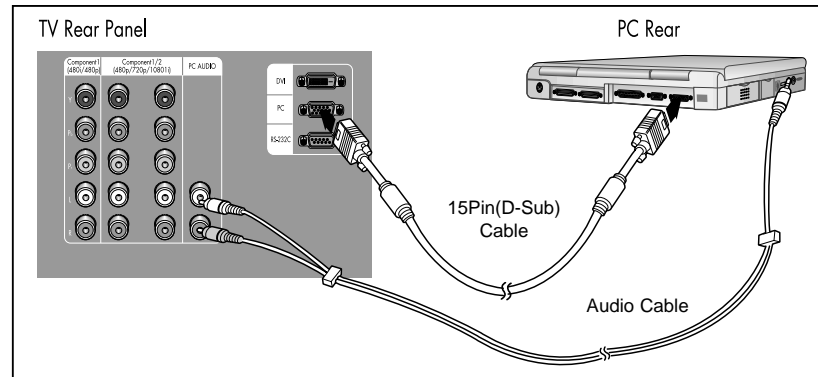

How to Set up Your PC Software (Windows only)

The Windows display-settings for a typical computer are shown below. The actual screens on your PC will probably be different, depending upon your particular version of Windows and your particular video card. However, even if your actual screens look different, the same basic setup information will apply in almost all cases. (If not, contact your computer manufacturer or Samsung Dealer.)



First, click on "Settings" on the Windows start menu.

While "Settings" is highlighted, move the cursor so that "control panel" is highlighted.

When the control panel screen appears, click on "Display" and a display dialog-box will appear.

Navigate to the "Settings" tab on the display dialog-box.



The two key variables that apply to the TV-PC interface are "resolution" and "color." The correct settings for these two variables are:

* Screen area (sometimes called "resolution"): 1024 x 768 pixels

* Color: "24-bit" color (might also be expressed as "16 million colors"). Shown at left is a typical screen for "Display" dialog box.

If a vertical-frequency option exists on your display settings dialog box, the correct value is "60" or "60 Hz." Otherwise, just click "OK" and exit the dialog box.

continued...

PC Display

Display Modes

Mode	Resolution	Total	Hor. Freq	Polarity	Ver. Freq	Polarity	Pixel Clock	Sep	Com	SOG
VGA	640x350	800x449	31.47 kHz	P	70.00 Hz	N	25.175 MHz	0	0	x
	720x400	900x449	31.47 kHz	N	70.00 Hz		28.322 MHz	0	0	x
	720x400	936x446	37.93 kHz	N	85.00 Hz	P	35.5 MHz	0	0	x
	640x480	800x525	31.47 kHz	N	60.00 Hz	P	25.175 MHz	0	0	x
	640x480	864x525	35.00 kHz	N	66.70 Hz	N	30.24 MHz	0	0	x
	640x480	832x520	37.86 kHz	N	72.80 Hz	N	31.5 MHz	0	0	x
	640x480	840x500	37.50 kHz	N	75.00 Hz	N	31.5 MHz	0	0	x
SVGA	640x480	832x509	43.27 kHz	N	85.00 Hz	N	36 MHz	0	0	x
	800x600	1024x625	35.16 kHz	N/P	56.30 Hz	N	36 MHz	0	0	x
	800x600	1056x628	37.88 kHz	P	60.30 Hz	N/P	40 MHz	0	0	x
	800x600	1040x666	48.08 kHz	P	72.20 Hz	P	50 MHz	0	0	x
	800x600	1056x625	46.87 kHz	P	75.00 Hz	P	49.5 MHz	0	0	x
	800x600	1048x6321	53.67 kHz	P	85.10 Hz	P	56.25 MHz	0	0	x
XGA	832x624	1152x667	49.73 kHz	N	74.60 Hz	P	57.284 MHz	0	0	x
	1024x768	1344x806	48.36 kHz	N	60.00 Hz	N	65 MHz	0	0	x
	1024x768	1328x806	56.40 kHz	N	70.10 Hz	N	75 MHz	0	0	x
DTV	1024x768	1312x800	60.02 kHz	P	75.00 Hz	N	78.75 MHz	0	0	x
	1920x1080i	2200x1125	33.75 kHz	X	60.00 Hz	P	74.25 MHz	0	x	x
	1280x720p	1650x750	45.00 kHz	X	60.00 Hz	X	74.25 MHz	0	x	x
	720x483p	858x525	31.47 kHz	X	60.00 Hz	X	27 MHz	0	x	x

NOTE

Both screen position and size will vary, depending on the type of PC monitor and its resolution. The table above shows all of the display modes that are supported:

- * The interlace mode is not supported.
- * The TV will operate abnormally if a non-standard video format is selected.

NOTES

- When this TV is used as a PC display, 32-bit color is supported (over 16 million colors).
- Your PC display screen might appear different, depending on the manufacturer (and depending on your particular version of Windows). Check your PC instruction book for information about connecting your PC to a TV display-monitor.
- Same modes as PC are supported for the signal input to the DVI jack. Only a separate sync signal is supported.

How to Set up Your TV as a PC display

“Auto Adjust” allows the TV to self-adjust to the incoming video signal. The values of fine, coarse and position are adjusted automatically.



- 1 Press TV/VIDEO on the remote control. Move the joystick up or down to select PC, then press the joystick to enter.

- 2 Press the Menu button. Move the joystick down to select “PC”, then press the joystick to enter.

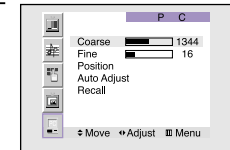

- 2 Move the joystick down to select “Auto Adjust”.

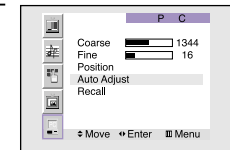

- 3 Press the joystick to enter.

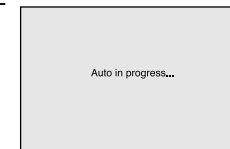

PC Display

Picture Quality Adjustment

The purpose of picture quality adjustment is to remove or reduce picture noise. If the noise is not removed by fine tuning alone, then do the frequency adjustments to the utmost and fine tune again. After the noise has been reduced, re-adjust the picture so that it is aligned on the center of screen.



Frequency Adjustment

1 Press TV/VIDEO on the remote control. Move the joystick up or down to select PC, then press the joystick to enter.

2 Press the Menu button. Move the joystick down to select "PC", then press the joystick to enter.

3 Move the joystick down to select "Coarse". Remove picture noise (vertical stripes) on the screen by moving the joystick right or left. (If frequency is not set properly, then vertical stripes will appear on the screen).

Fine tuning

4 Move the joystick down to select "Fine". Remove picture noise (vertical stripes) on the screen by moving the joystick right or left. (If phase is not set properly, the picture may be blurry.)

Press the Menu to exit.

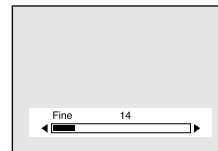
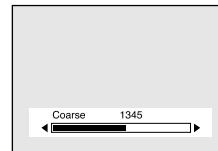
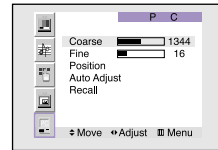

Changing the Position of the Image (Moving left, right, up and down)

After connecting the TV to your PC, adjust the position of screen if it is not well-aligned.



1 Press TV/VIDEO on the remote control. Move the joystick up or down to select PC, then press the joystick to enter.

2 Press the Menu button. Move the joystick down to select "PC", then press the joystick to enter.

3 Move the joystick down to select "Position", then press the joystick to enter.

Adjust the position of screen by using the joystick button.

Press the Menu to exit.

NOTE

- If a PC signal is input to DVI, you can't adjust the quality and position of picture.

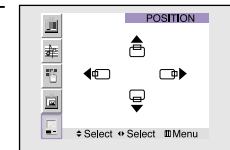
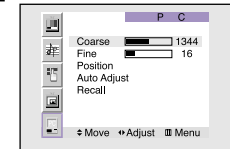

To Initialize the Screen Position and Picture Quality Adjustment

After steps 1~2 above are completed, move the joystick down to select Recall. Press the joystick to initialize the screen position and picture quality.

NOTE

- When 'Recall' is active, the TV screen will become black and return to the original view about five seconds later. (This is a normal operation.)

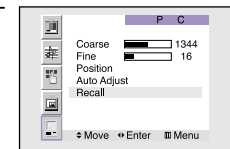

PC Display

Changing the Screen Size (PC mode)

When you press the ASPECT button on the remote control, the TV's screen mode choices appear in sequence. The screen displays in this order: Wide(TV), Wide(PC), Expand, Normal. The name of the screen mode will be displayed at the bottom of the TV screen.



Wide (TV)

Scales the picture to the size of the TV screen regardless of the aspect ratio of the input source.

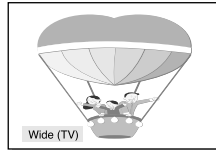

Wide (PC)

Scales the picture to 92% of the screen regardless of the aspect ratio of the input source.

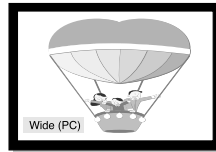

Expand

Scales the picture to the aspect ratio of the input source.

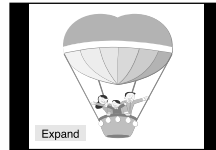

Normal

Displays the picture as it is without changing the aspect ratio of input source.

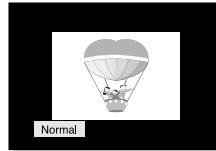

Aspect Supported settings

Source (PC/DVI)	Aspect
1920 x 1080i	Wide(TV)
1280 x 720	Wide(TV) → Wide(PC)
1024 x 768	Wide(TV) → Wide(PC) → Expand
720 x 483 (480p)	Wide(TV) → Wide(PC) → Normal
Others	Wide(TV) → Wide(PC) → Expand → Normal

NOTES

- In VGA (640x480) and SVGA (800x600) modes, the Wide(TV), Wide (PC), Expand and Normal screen modes are available.
- In XGA (1024x768) mode, the Wide (TV), Wide (PC) and Expand screen modes are available.

Appendix

SAMSUNG

Appendix

Troubleshooting

Before you call a service technician, please scan this list of problems and possible solutions. It may save you time and money.

Problem	Possible Solution
Poor picture quality.	Try another channel. Adjust the antenna. Check all wire connections.
Poor sound quality or no sound.	Try another channel. Adjust the antenna. Make sure the "Mute" button is off.
No picture or sound.	Try another channel. Press the TV/Video button. Make sure the TV is plugged in. Check the antenna connections.
No color or wrong colors.	Make sure the program is broadcasted in color. Adjust the picture settings.
Picture rolls vertically.	Adjust the antenna. Check all wire connections. If you are using a VCR, check the tracking.
Erratic operation, or intermittent failure.	Unplug the TV for 30 seconds, then try again.
Remote control failure.	Press the "Mode" button to put your remote control into "TV" mode. Make sure the remote has batteries.
TV won't switch on.	Make sure the wall outlet is working. Make sure the remote has batteries.

- The display panel used for the DLP Projection TV is composed of many tiny pixels. These, pixels may occasionally appear on the screen.

Care and Maintenance

With proper care, your TV will give you many years of service. Please follow these guidelines to get the maximum performance from your TV.

Placement

- Do not put the TV near extremely hot, cold, humid or dusty places.
- Do not put the TV near appliances that create magnetic fields.
- Keep the ventilation openings clear.
- Do not place the TV on a rough and slanted surface, such as cloth or paper.
(The screen top might be cut off or the screen center might be tilted.)

Liquids

- Do not handle liquids near or on the TV.

Cabinet

- Never open the cabinet or touch the parts inside.
- Wipe your TV with a clean, dry cloth. Never use water, cleaning fluids, wax, or chemicals.
- Do not put heavy objects on top of the cabinet.
- This DLP Projection TV projects the image onto a large screen by applying an optical system. If you place the TV set face down, it might cause a problem because dirt, or some other contaminant may become attached to the inside of the TV set.

Temperature

- If your TV is suddenly moved from a cold to a warm place, unplug the power cord for at least two hours so that moisture that may have formed inside the unit can dry completely.

Using the TV in Another Country

If you plan to take your TV to a foreign country, please be aware of the different television systems that are in use around the world. A TV designed for one system may not work properly with another system due to differences in the TV channel frequencies.

Specifications

Model	HLM4365W	HLM5065W	HLM437W	HLM507W	HLM617W
Voltage	AC 120V	AC 120V	AC 120V	AC 120V	AC 120V
Frequency of Operation	60Hz	60Hz	60Hz	60Hz	60Hz
Power Consumption	200 watts	200 watts	200 watts	200 watts	200 watts
Dimension (W x D x H)	1075 x 399 x 755 mm 42.3 x 15.7 x 29.7 inches	1230 x 444 x 859 mm 48.4 x 17.5 x 33.8 inches	1029 x 400 x 755 mm 40.5 x 15.7 x 29.7 inches	1184 x 447 x 859 mm 46.6 x 17.6 x 33.8 inches	1436 x 1021 x 489 mm 56.5 x 40.2 x 19.3 inches
Weight	31.5 Kg / 69.4 lbs	37 Kg / 81.6 lbs	30 Kg / 66.1 lbs	35.2 Kg / 77.6 lbs	49 Kg / 108.0 lbs

Memo