

myprojectorlamps.com

**The most trusted, dependable name
in projector lamp sales.**



<http://www.myprojectorlamps.com>



<http://www.myprojectorlamps.ca>



<http://www.myprojectorlamps.eu>

The following projector manual has not been modified or altered in any way.



Contact SAMSUNG WORLD-WIDE

If you have any questions or comments relating to Samsung products, please contact the SAMSUNG customer care center.

Country	Customer Care Center ☎	Web Site	Address
CANADA	1-800-SAMSUNG (7267864)	www.samsung.com/ca	Samsung Electronics Canada Inc., Customer Service 55 Standish Court Mississauga, Ontario L5R 4B2 Canada
			Samsung Electronique Canada Inc., Service à la Clientèle 55 Standish Court Mississauga, Ontario L5R 4B2 Canada
U.S.A	1-800-SAMSUNG (7267864)	www.samsung.com	Samsung Electronics America, Inc. 105 Challenger Road Ridgefield Park, NJ 07660-0511



HL-S5686C

DLP TV

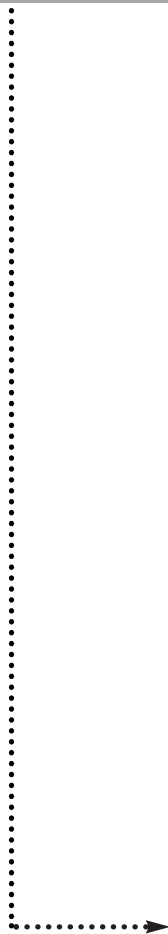

Owner's Instructions

Register your product at
www.samsung.com/global/register

A Guide to Digital TV

- **What is Digital Television?**

Digital television (DTV) is a new way of transmitting high quality video and audio to your TV set. Using DTV, broadcasters can transmit high definition TV (HDTV) images, Dolby digital surround audio, and new services such as multicasting (transmitting more than one program on the same TV channel) and datacasting. Several of these services can be combined into a single digital broadcast.

Digital Television Services

- **Digital Picture Quality**

DTV programs are transmitted in two different formats. The first is Standard Definition Television (SDTV) and the second is High Definition Television (HDTV).

- **SDTV** program formats include 480-line interlaced (480i) and 480-line progressive (480p) video. 480i programs are essentially a digital version of our current analog TV programs, while the 480p format offers improved image detail over 480i. Some 480p programs are broadcast in widescreen and are comparable to progressive-scan DVD movies in image quality.
- **HDTV** program formats include 1080-line interlaced (1080i) and 720-line progressive (720p). Both HDTV formats are always broadcast in widescreen, and offer much higher picture quality than SDTV.
- **Dolby Surround Sound**
With DTV, you can listen to a variety of Dolby digital audio formats from Dolby Surround 2.0 to Dolby Digital 5.1 surround, using your home audio system. Many HDTV programs are now broadcast with DD 5.1 soundtracks.

U.S.A Only

The product unit accompanying this user manual is licensed under certain intellectual property rights of certain third parties. In particular, this product is licensed under the following US patents: 5,991,715, 5,740,317, 4,972,484, 5,214,678, 5,323,396, 5,539,829, 5,606,618, 5,530,655, 5,777,992, 6,289,308, 5,610,985, 5,481,643, 5,544,247, 5,960,037, 6,023,490, 5,878,080, and under US Published Patent Application No. 2001-44713-A1.

This license is limited to private non-commercial use by end-user consumers for licensed contents. No rights are granted for commercial use. The license does not cover any product unit other than this product unit and the license does not extend to any unlicensed product unit or process conforming to ISO/IEC 11172-3 or ISO/IEC 13818-3 used or sold in combination with this product unit. The license only covers the use of this product unit to encode and/or decode audio files conforming to the ISO/IEC 11172-3 or ISO/IEC 13818-3. No rights are granted under this license for product features or functions that do not conform to the ISO/IEC 11172-3 or ISO/IEC 13818-3.

Other countries

The product unit accompanying this user manual is licensed under certain intellectual property rights of certain third parties. This license is limited to private non-commercial use by end-user consumers for licensed contents. No rights are granted for commercial use. The license does not cover any product unit other than this product unit and the license does not extend to any unlicensed product unit or process conforming to ISO/IEC 11172-3 or ISO/IEC 13818-3 used or sold in combination with this product unit. The license only covers the use of this product unit to encode and/or decode audio files conforming to the ISO/IEC 11172-3 or ISO/IEC 13818-3. No rights are granted under this license for product features or functions that do not conform to the ISO/IEC 11172-3 or ISO/IEC 13818-3.

CableCARD and Digital Cable Ready TVs

CableCARD and Digital Cable Ready TVs are the products of a new digital cable standard. This new standard is called OpenCable and it is a concerted effort to standardize the digital cable service network interface in North America. For more information, please refer to www.cablelabs.com.

Digital Cable Ready TVs are equipped with a proper digital cable tuner to receive digital cable signals from your local cable service provider. They are also designed to work with digital cable card modules (PCMCIA card modules called CableCARDS). These PCMCIA card modules or CableCARDS will be provided by your local cable service provider after a proper subscription process.

The provided CableCARD from your local cable service provider needs to be inserted into the CableCARD slot of a Digital Cable Ready TV. Please refer to page 78 for how to insert the CableCARD.

A digital set-top box which used to be provided by the cable service provider is no longer needed with Digital Cable Ready TVs and CableCARDS.

When CableCARD is inserted into the slot, the TV screen will show the message that CableCARD is inserted and tries to download necessary data such as channel information or subscription information from your digital cable service provider. When you insert CableCARD for the first time, this process may take a few minutes depending on the amount of data your cable provider needs to send.

During this process the digital cable service provider or CableCARD may display messages on the TV screen to help or give you further information.

Please contact your local cable provider for more information on service availability and how to acquire a CableCARD.

- This television receiver supports the copy protection system regulated by DTLA (Digital Transmission Licensing Administrator). It should be noted that copy protected content may not be viewable depending on your particular connections.

1. Is the antenna I use for existing TV reception good enough for DTV?

Over-the-air (OTA) digital TV broadcasting uses the same channels as analog TV and works well with many existing TV antennas. However, DTV broadcast channel assignments are different than analog channels. You should find out whether your local DTV broadcasts are on VHF (channels 2-13) or UHF (channels 14-69) to see if you need a different antenna.

If your DTV channels are on UHF and you already get good UHF reception, your present antenna may work fine. The same holds true for VHF DTV reception. Note that in some markets, both VHF and UHF channels are used for DTV broadcasts.

You can find out the latest DTV channel assignments for your area by browsing selected Internet web sites such as www.titantv.com, www.10000watts.com, and www.fcc.gov.

2. How difficult is it to receive DTV signals indoors?

This depends on whether your local DTV stations are running full power or not and how close your location is to the transmission tower. DTV receivers do not require as much signal as analog TV receivers to produce high-quality images and sound.

Once the DTV signal level exceeds a certain threshold at the receiver, the digital video and audio data is decoded at the same quality it was originally encoded for broadcast.

This is a big advantage for DTV over analog TV - there is no noise, ghosting, static, or scratchy audio.

3. How can I connect an antenna in my townhouse, cooperative apartment, condominium, or apartment?

The Federal Communications Commission's OTARD Rule (part of the Telecommunications Act of 1996) allows residents of condominiums, townhouse, or members of neighborhood associations to put up outside antennas for reception of broadcast TV signals as long as those antennas are not located in common areas and are no more than 12' in height.

Residents of rental units (apartments, etc.) are not covered by the OTARD rules and will have to use indoor antennas to receive DTV broadcasts. It is possible that the landlord of an apartment complex can provide broadcast DTV signals via a master TV antenna system to each apartment.

4. Can I connect my DTV set top receiver to my cable TV service?

Cable TV systems use a different method for transmitting digital TV programs that is currently incompatible with broadcast DTV set-top receivers. So you will still need to use an outdoor or indoor antenna to receive OTA broadcast DTV programs.

The good news is that you won't have to pay a monthly or per-program charge to watch OTA DTV and HDTV programs. They're free, unlike subscription satellite TV or premium cable TV. All you need is an antenna and a DTV set-top receiver to enjoy clear, sharp widescreen images and high-quality audio.

Contents

GENERAL INFORMATION

- Viewing Position..... 7
- List of Features..... 8
- Accessories..... 8
- Viewing the Control Panel..... 9
- Viewing the Connection Panel..... 10
- Remote Control..... 11
- Installing Batteries in the Remote Control..... 12

CONNECTIONS

- Connecting VHF and UHF Antennas..... 12
- Connecting Cable TV..... 13
- Connecting a VCR..... 14
- Connecting an S-VHS VCR..... 14
- Connecting a Camcorder..... 15
- Connecting a DVD Player/Set-Top Box..... 15
- Connecting a DVD Player/Set-Top Box via DVI..... 16
- Connecting a DVD Player/Set-Top Box via HDMI..... 16
- Connecting a Digital Audio System..... 17
- Connecting an Amplifier/DVD Home Theater..... 17

OPERATION

- Turning the TV On and Off..... 18
- Plug & Play Feature..... 18
- Dynamic Menus and On-Screen Displays..... 20
- Navigating Menus by Using the Menu Map..... 21
- Selecting a Menu Language..... 22
- Memorizing Channels..... 23
- Changing Channels..... 25
- Setting Up Your Remote Control..... 26
- Remote Control Codes..... 28
- Setting the Clock..... 31
- Setting the On/Off Timer..... 33
- Setting the Sleep Timer..... 34
- Viewing an External Signal Source..... 35
- Assigning Names to External Input Mode..... 36

CHANNEL CONTROL

- Selecting Your Favorite Channels..... 37
- Viewing the Channel Lists..... 38
- Adding and Erasing Channels..... 39
- Labeling the Channels..... 40
- Fine Tuning Analog Channels [Analog]..... 41
- Checking the Digital-Signal Strength [Digital]..... 42
- LNA (Low Noise Amplifier)..... 42

PICTURE CONTROL

- Picture Control..... 43
- Customizing the Picture Settings..... 44
- Changing the Picture Size..... 46
- Setting the My Color Control Mode..... 47
- Using the Color Weakness Enhancement Feature..... 49
- Digital Noise Reduction..... 50
- DNle (Digital Natural Image engine)..... 51
- Setting the Film Mode..... 52
- Freezing the Picture..... 53
- Setting the Blue Screen Mode..... 53

SOUND CONTROL

- Sound Control..... 54
- Customizing the Sound..... 55
- Setting up DNSe (Digital Natural Sound engine)..... 56
- Auto Volume..... 57
- Choosing a Multi-Channel Sound (MTS) track [Digital]..... 58
- Choosing a Multi-Channel Sound (MTS) track [Analog]..... 59
- Selecting the Internal Mute..... 60
- Setting the On/Off Melody..... 61

SPECIAL FEATURES

- Setting the Function Help..... 62
- Setting the Data Service..... 63
- Menu Transparency Level..... 64
- Using Game Mode..... 65
- Using the V-Chip..... 66
- How to Enable/Disable the Rating Controls..... 67
- How to Set up Restrictions Using "TV Parental Guidelines"..... 68
- How to Set up Restrictions Using "MPAA Rating"..... 69
- Important Notes About Parental Locks..... 70
- How to Set up Restrictions Using Canadian English.. 71
- How to Set up Restrictions Using Canadian French... 72
- Using the V-Chip for Digital channels..... 73
- Viewing Closed Captions (On-Screen Text Messages) [Analog]..... 74
- Viewing Closed Captions (On-Screen Text Messages) [Digital]..... 75
- License Information..... 77



Contents

USING THE OCAP (OPENCABLE APPLICATION PLATFORM) DATA SERVICE

■ Connecting CableCARD.....	78
■ Using the CableCARD.....	79
■ Using the CableCARD Setup Function	79
■ Channel List Reorganization	80
■ Using the Data Service	81

USING D-NET

■ What's D-Net?.....	82
■ When Connecting D-Net (IEEE1394) Compatible devices ..	83
■ Connection Options	84
■ 4-Pin and 6-Pin Connectors	85
■ Selecting a D-Net device	86
■ The Direct Device-To-Device Option	87
■ The D-Net control panel	88
■ Control Panel Images for Each Device	90
■ Operating Tips	91
■ Recording Tips	93
■ Tips on stopping recording	94
■ File List	95
■ Troubleshooting (D-Net)	97

APPENDIX

■ Replacing the Lamp	101
■ Identifying Problems	103
■ Cleaning and Maintaining Your TV.....	104
■ Using Your TV in Another Country	104
■ Specifications	105

Symbol



Press

Note

General Information

Viewing Position

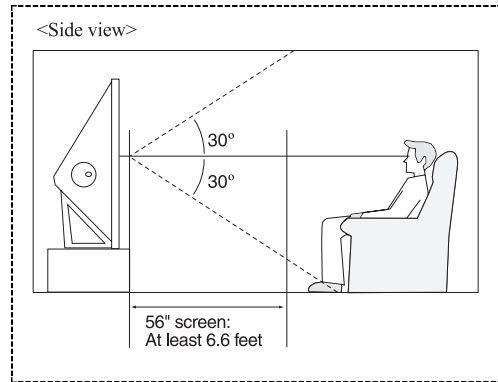
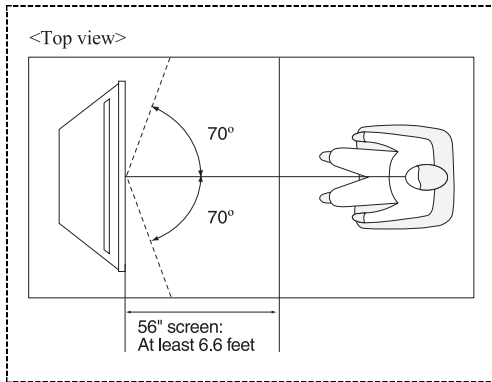
To optimize your viewing comfort, please follow the guidelines below for viewing distance. If viewing for an extended period of time, sit as far back from the screen as possible.



When installing the product, make sure to keep it away from the wall (more than 10 cm/4 inches) for ventilation purposes.

- Poor ventilation may cause an increase in the internal temperature of the product, resulting in a shortened component life and degraded performance.

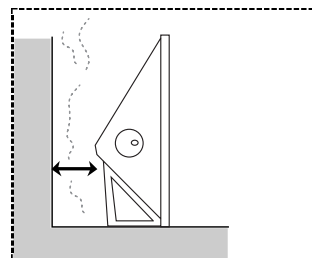

List of Features

- Easy-to-operate remote control
- Dynamic, easy to navigate menus
- Easy-to-use on-screen menu system you can access from the front/right side panel, or remote control
- Automatic timer to turn the TV on and off at any time you choose
- Adjustable picture and sound settings and the ability to memorize your favorite settings
- Automatic channel tuning for up to 181 channels
- A special filter to reduce or eliminate reception problems
- Fine tuning control for the sharpest picture possible
- A built-in multi-channel sound decoder for stereo and bilingual listening
- Built-in, dual channel speakers
- A special sleep timer
- Widescreen TV with adjustable image size
- Life-like clear images provided by DNIe technology
- My Color Control mode to correspond with your color preference
- Color Weakness Enhancement Feature
- Digital Input jack
- Digital Audio Output (OPTICAL) jack
- CableCARD slot
- D-Net (IEEE1394)
- Game mode
- Easy-to-use channel manager menu.

Accessories

Please make sure the following items are included with your TV.
If any items are missing, contact your dealer.

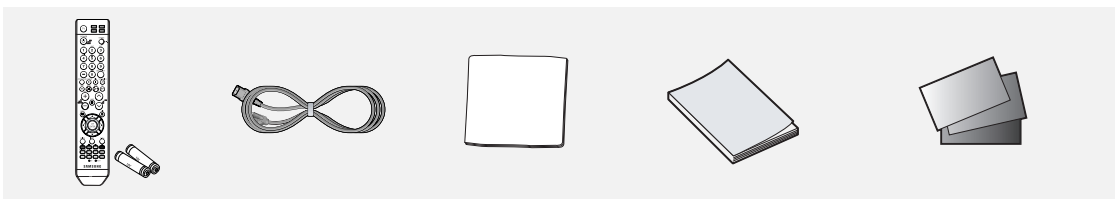

Remote Control &
Batteries (AAA x 2)
(BP59-00121A)

Power Cord
(3903-000144)

Cleaning Cloth

Owner's Instructions

Warranty Card /
Registration Card /
Safety Guide Manual /
Quick Guide Manual

Viewing the Control Panel

Buttons on the Lower-Right Part of the Panel

The buttons on the lower-right panel control your TV's basic features, including the on-screen menu. To use the more advanced features, you must use the remote control.

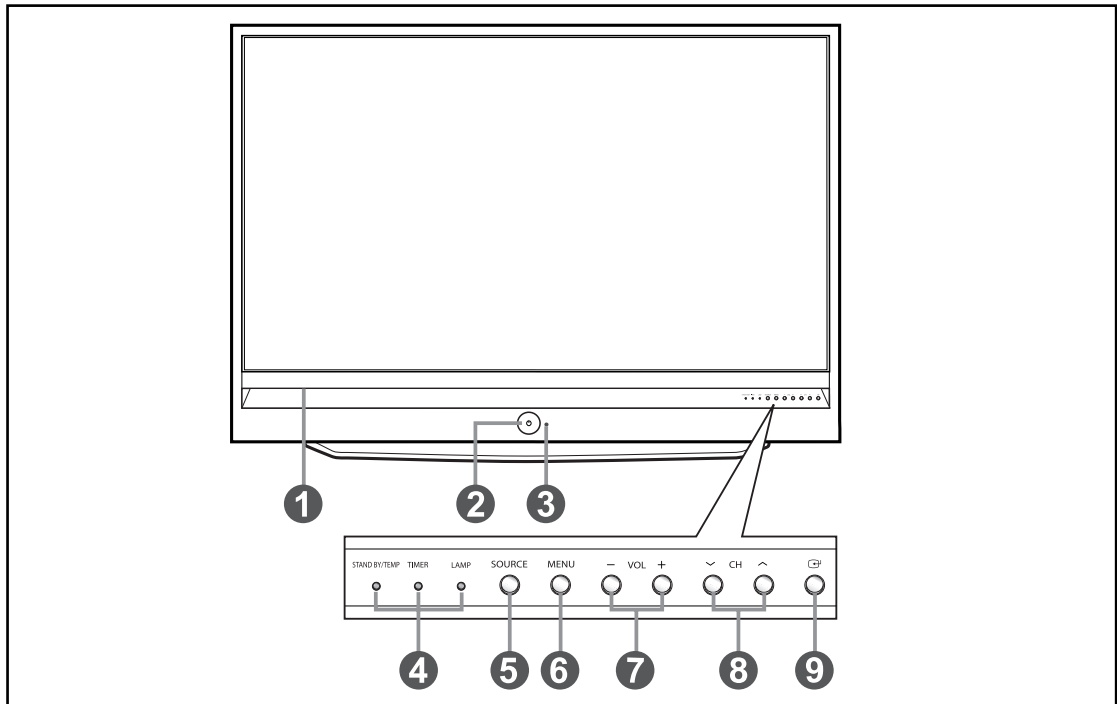

1 SPEAKERS

2 ⏻ (POWER)

Press to turn the TV on and off.

3 REMOTE CONTROL SENSOR

Aim the remote control towards this spot on the TV.

4 INDICATOR LIGHTS

5 SOURCE

Toggles between all the available input sources (TV, AV1, AV2, AV3, S-Video1, S-Video2, S-Video3, Component1, Component2, HDMI1, HDMI2).

6 MENU

Press to see an on-screen menu of your TV's features.

7 - VOL +

Press to increase or decrease the volume.

In the on-screen menu, use the - VOL + buttons as you would use the ◀ and ▶ buttons on the remote control.

8 ∇ CH ▲

Press to change channels.

In the on-screen menu, use the ∇ CH ▲ buttons as you would use the ▼ and ▲ buttons on the remote control.

9 ⏏ (ENTER)

Press to confirm a selection.

● : Light is On / ◐ : Light is Blinking / ○ : Light is Off

STAND BY/TEMP	TIMER	LAMP	Indication
●	○	○	Standby state.
○	○	◐	The picture will automatically appear in about 15 seconds.
○	●	◐	Auto Timer ON/OFF has been set and the set will automatically be turned on in about 15 seconds.
◐	◐	○	A cooling fan inside the set is not operating normally.
◐	○	◐	Lamp cover on the rear of the set is not properly shut.
◐	○	○	Check if the ventilation hole on the rear of the set is blocked, because if the inner temperature is too high, the power will shut off.
◐	◐	◐	Lamp may be defective. Please contact a certified technician.

- It takes about 30 seconds for the TV to warm up, so normal brightness may not appear immediately.
- The TV has a fan to keep the inside lamp from overheating. You'll occasionally hear it working.

Viewing the Connection Panel

Rear Panel Jacks

Use the rear panel jacks to connect A/V components that will be connected continuously, such as VCR or DVD players. For more information on connecting equipment, see pages 12-17. The product color and shape may vary depending on the model.

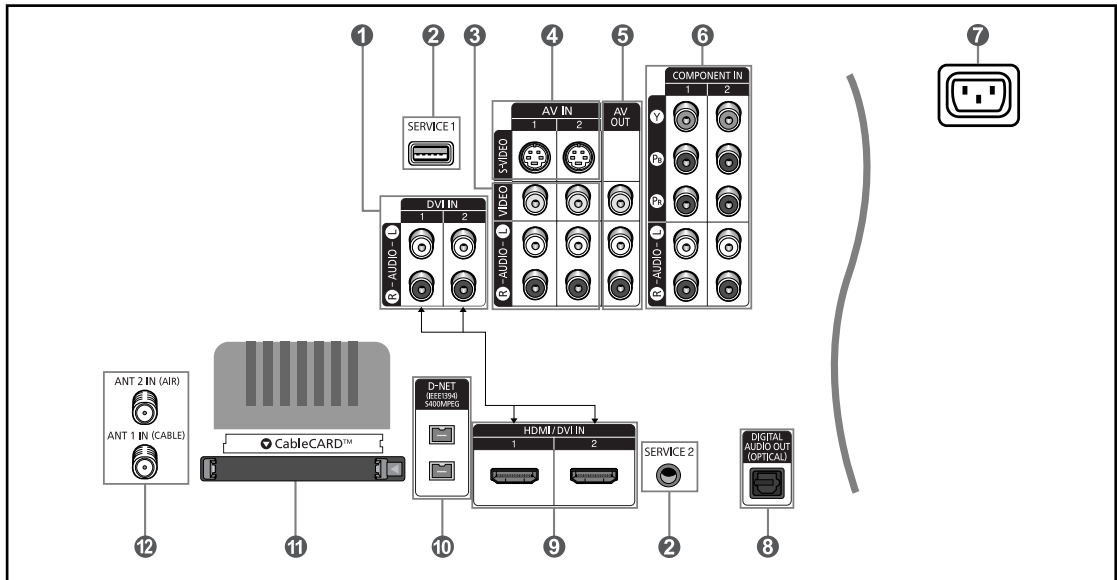

- 1 DVI IN 1, 2 (AUDIO-R/L)**
Connect to the DVI audio output jack of an external device.
- 2 SERVICE 1, SERVICE 2**
Connectors for service only.
- 3 AUDIO-R/L / VIDEO (AV IN 1, 2)**
Video and audio inputs for external devices, such as a camcorder or VCR.
- 4 S-VIDEO (AV IN 1, 2)**
Video input for external devices with an S-Video output, such as a camcorder or VCR.
- 5 AV OUT**
Connect to the audio input jacks on your Amplifier/ Home theater.
- 6 COMPONENT IN 1, 2**
Connect Component video/audio.
- 7 POWER INPUT**
Connect the supplied power cord.
- 8 DIGITAL AUDIO OUT (OPTICAL)**
Connect to a Digital Audio component.
- 9 HDMI/DVI IN 1, 2**
Connect to the HDMI jack of a device with HDMI output. This input can also be used as a DVI connection with separate analog audio inputs. An optional HDMI/DVI cable will be necessary to make this connection. When using an optional HDMI/DVI adapter, the DVI analog audio inputs on your TV allow you to receive left and right audio from your DVI device.
- 10 D-NET (IEEE1394) S400MPEG**
Connect to external IEEE1394 digital products such as digital VCRs and camcorders. Two jacks are provided for this purpose, which allow for a high degree of flexibility for connecting your D-Net controlled system. (Refer to pages 82~100)
- 11 CableCARD™**
Insert a CableCARD into the slot. (Refer to page 78)
- 12 ANT 2 IN (AIR)/ANT 1 IN (CABLE)**
Connect to an antenna or cable TV system.

Side Panel Jacks

Use the right side panel jacks to connect a component that is used only occasionally, such as a camcorder or video game. (See page 15) The product color and shape may vary depending on the model.

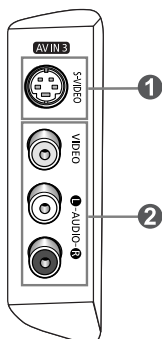

- 1 S-VIDEO (AV IN 3)**
S-Video input for external devices with an S-Video output.
- 2 AUDIO-R/L / VIDEO (AV IN 3)**
Video and audio inputs for external devices.

Remote Control

You can use the remote control up to a distance of about 23 feet from the TV. When using the remote, always point it directly at the TV. You can also use your remote control to operate your VCR, Cable box, DVD player, or Set-Top Box.

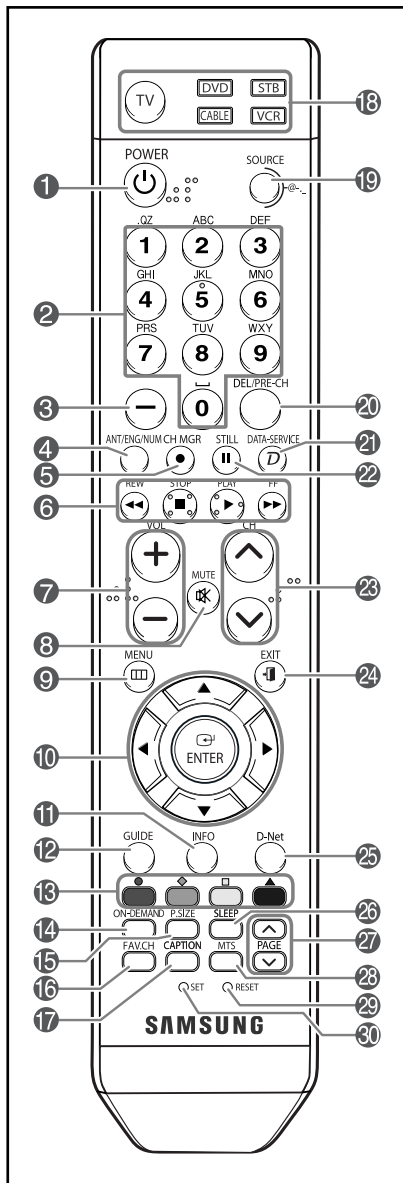

- The Color buttons are used for the channel list function. (Refer to pages 37~40)
- This is a special remote control for the visually impaired, and has Braille points on the POWER, VOL +/-, CH ^/∨, STOP, and PLAY/PAUSE buttons.
- The performance of the remote control may be affected by bright light.

- 1 POWER**
Turns the TV on and off.
- 2 NUMERIC BUTTONS**
Press to directly select a channel.
- 3 -**
Press to select additional channels being broadcast by the same station. For example, to select channel "54-3", press "54", then press "-" and "3".
- 4 ANT/ENG/NUM**
Press to select "AIR" or "CABLE".
While executing a Data Application downloaded, press to change the character mode. In other cases, it operates to change the current antenna.
- 5 CH MGR**
Used to display Channel Lists on the screen.
- 6 VCR/DVD Controls**
- Rewind
- Stop
- Play
- Fast/Forward
- 7 + VOL -**
Press to increase or decrease the volume.
- 8 MUTE**
Press to temporarily cut off the sound.
- 9 MENU**
Displays the main on-screen menu.
- 10 UP ▲ / DOWN ▼ / LEFT ◀ / RIGHT ▶ / ENTER**
Use to select on-screen menu items and change menu values.
- 11 INFO**
Press to display information on the TV screen.
- 12 GUIDE**
Press to display the TV Guide menu when the guide is provided from the downloaded application. When no TV Guide is available in the downloaded application, the EPG is not displayed with the sign "No Available Banner".
- 13 Color buttons**
Press to perform wanted operations by selecting the color or shape as displayed on the downloaded application.
- 14 ON-DEMAND**
Press to display the MOD menu when the downloaded application provides the Movie on Demand (MOD) function.
- 15 P.SIZE**
Picture size selection.
- 16 FAV.CH**
Press to switch to your favorite channels.
- 17 CAPTION**
Controls the caption decoder.
- 18 TV, DVD, STB, CABLE, VCR**
Press to operate your TV, DVD, STB, CABLE (box), or VCR.
- 19 SOURCE**
Press to display all of the available video sources.
While executing a Data Application downloaded, press to use the special character set on your remote control in the event that an IME opens after entering the character input mode. In other cases, it operates to switch the source.
- 20 DEL/PRE-CH**
Tunes to the previous channel.
While executing a Data Application downloaded, press to delete characters in the data input menu in the event that an IME opens after entering the character input mode. In other cases, it switches to the previous channel.
- 21 DATA-SERVICE**
Press to display the executable Data Application list. You can execute an application by selecting from the list.
- 22 STILL**
Press to stop the action during a particular scene. Press again to resume normal video.
Press to pause the screen when watching the movie on demand (MOD) or pay per view (PPV) programs using the downloaded application.
- 23 ^ CH ∨**
Press to change channels.
- 24 EXIT**
Press to exit the menu.
- 25 D-Net**
Runs the D-Net view function. (Refer to pages 82~100)
- 26 SLEEP**
Press to select a preset time interval for automatic shut off.
- 27 ^ PAGE ∨**
Use to scroll the screen or text in the Data Application downloaded.
- 28 MTS**
Press to choose stereo, mono or Separate Audio Program (SAP broadcast).
- 29 RESET**
When your remote does not work, change the batteries and press the RESET button for 2-3 seconds before use.
- 30 SET**
Sets the remote to control your TV, VCR, Cable, DVD, or Set-Top Box.

Installing Batteries in the Remote Control

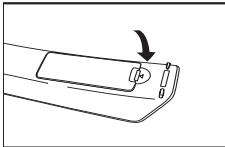
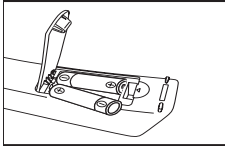
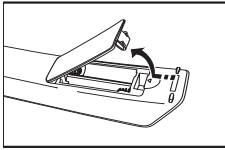

1. Lift the cover at the back of the remote control upward as shown in the figure.
 2. Install two AAA size batteries.
 - > Make sure to match the "+" and "-" ends of the batteries with the diagram inside the compartment.
 3. Replace the cover.
 - > Remove the batteries and store them in a cool and dry place if you won't be using the remote control for a long time.
 - The remote control can be used up to about 23 feet from the TV.
 - (Assuming typical TV usage, the batteries last for about one year.)
- > **If the remote control doesn't work, check the following:**
1. Is the TV power on?
 2. Are the plus and minus ends of the batteries reversed?
 3. Are the batteries drained?
 4. Is there a power outage, or is the power cord unplugged?
 5. Is there a special fluorescent light or neon sign nearby?

Connections

Connecting VHF and UHF Antennas

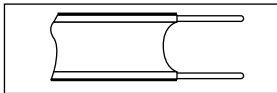

If your antenna has a set of leads that look like this, see "Antennas with 300 Ω Flat Twin Leads" below.

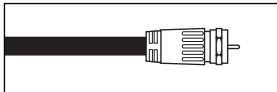

If your antenna has one lead that looks like this, see "Antennas with 75 Ω Round Leads".
If you have two antennas, see "Separate VHF and UHF Antennas".

Antennas with 300 Ω Flat Twin Leads

If you are using an off-air antenna (such as a roof antenna or "rabbit ears") that has 300 Ω twin flat leads, follow the directions below.

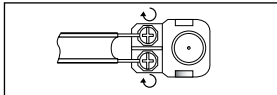

1. Place the wires from the twin leads under the screws on a 300-75 Ω adapter (not supplied).
Use a screwdriver to tighten the screws.

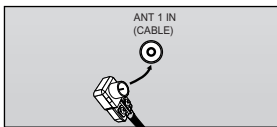

2. Plug the adaptor into the ANT 2 IN(AIR) or ANT 1 IN(CABLE) terminal on the back of the TV.

Antennas with 75 Ω Round Leads

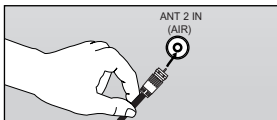

1. Plug the antenna lead into the ANT 2 IN(AIR) or ANT 1 IN(CABLE) terminal on the back of the TV.

Separate VHF and UHF Antennas

If you have two separate antennas for your TV (one VHF and one UHF), you must combine the two antenna signals before connecting the antennas to the TV. This procedure requires an optional combiner-adaptor (available at most electronics shops).

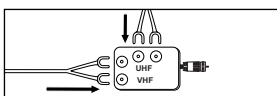

1. Connect both antenna leads to the combiner.

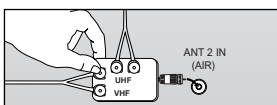

2. Plug the combiner into the ANT 2 IN(AIR) or ANT 1 IN(CABLE) terminal on the bottom of the back panel.

Connecting Cable TV

To connect to a cable TV system, follow the instructions below.

Cable without a Cable Box

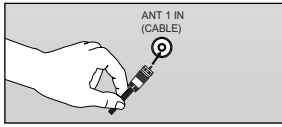

1. Plug the incoming cable into the ANT 1 IN (CABLE) terminal on the back of the TV.
 - > Because this TV is cable-ready, you do not need a cable box to view unscrambled cable channels.

Connecting to a Cable Box that Descrambles All Channels

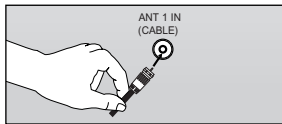
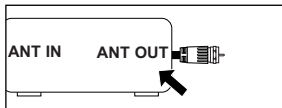

1. Find the cable that is connected to the ANT OUT terminal on your cable box.
 - > This terminal might be labeled "ANT OUT", "VHF OUT" or simply, "OUT".
2. Connect the other end of this cable to the ANT 1 IN (CABLE) terminal on the back of the TV.

Connecting to a Cable Box that Descrambles Some Channels

If your cable box descrambles only some channels (such as premium channels), follow the instructions below. You will need a two-way splitter, an RF (A/B) switch, and four lengths of RF cable. (These items are available at most electronics stores.)

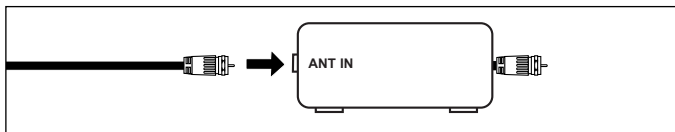

1. Find and disconnect the cable that is connected to the ANT IN terminal on your cable box.
 - > This terminal might be labeled "ANT IN", "VHF IN" or simply, "IN".

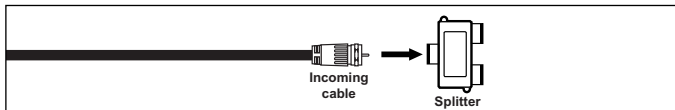

2. Connect this cable to a two-way splitter.

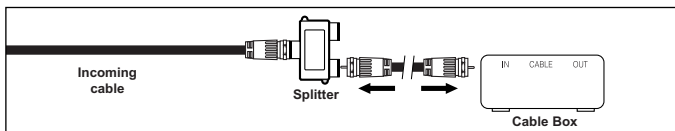

3. Connect an Antenna cable between an OUTPUT terminal on the splitter and the IN terminal on the cable box.

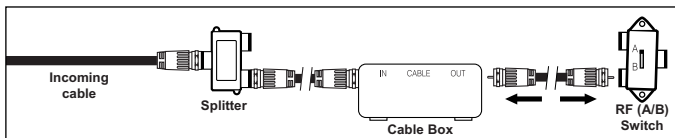

4. Connect an RF cable between the ANT OUT terminal on the cable box and the B-IN terminal on the RF (A/B) Switch.

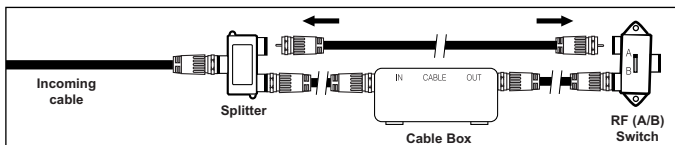

5. Connect another cable between the other OUT terminal on the splitter and the A-IN terminal on the RF (A/B) Switch.

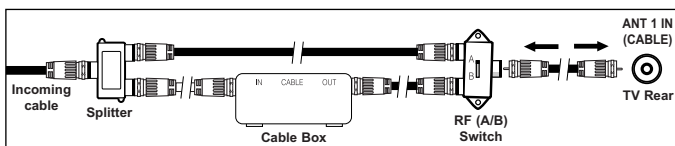

6. Connect the last RF cable between the OUT terminal on the RF (A/B) switch and the ANT 1 IN (CABLE) terminal on the rear of the TV.

After you have made this connection, set the A/B Switch to the "A" position for normal viewing. Set the A/B switch to the "B" position to view scrambled channels. (When you set the A/B Switch to "B", you will need to tune your TV to the cable box's output channel, which is usually channel 3 or 4.)

Connecting a VCR

These instructions assume that you have already connected your TV to an antenna or a cable TV system (according to the instructions on pages 12-13). Skip step 1 if you have not yet connected to an antenna or a cable system.

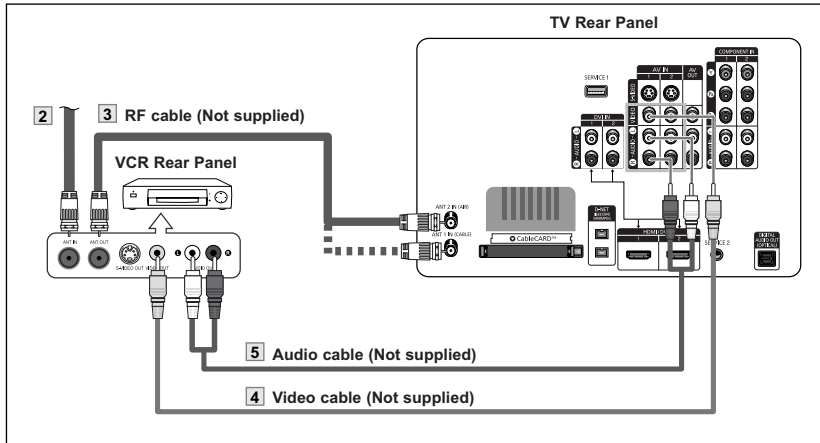
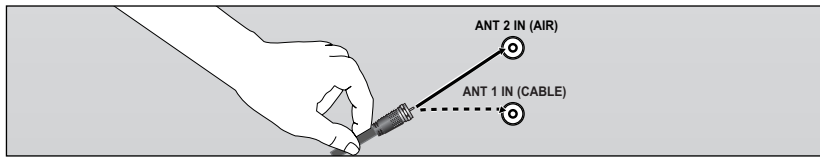

- Each VCR has a different back panel configuration.
- When connecting a VCR, match the color of the connection terminal to the cable.
- Also, you can connect to "AV IN 3" on the side panel of TV.

1. Unplug the cable or antenna from the back of the TV.
2. Connect the cable or antenna to the ANT IN terminal on the back of the VCR.
3. Connect an RF cable between the ANT OUT terminal on the VCR and the ANT 2 IN (AIR) or ANT 1 IN (CABLE) terminal on the TV.
4. Connect a Video cable between the VIDEO OUT jack on the VCR and the AV IN 1 (or AV IN 2) [VIDEO] jack on the TV.
5. Connect Audio cables between the AUDIO OUT jacks on the VCR and the AV IN 1 (or AV IN 2) [R-AUDIO-L] jacks on the TV.

- If you have a "mono" (non-stereo) VCR, use a Y-connector (not supplied) to hook up to the right and left audio input jacks of the TV. If your VCR is stereo, you must connect two cables.

Connecting an S-VHS VCR

Your Samsung TV can be connected to an S-Video signal from an S-VHS VCR. (This connection delivers a better picture as compared to a standard VHS VCR.)

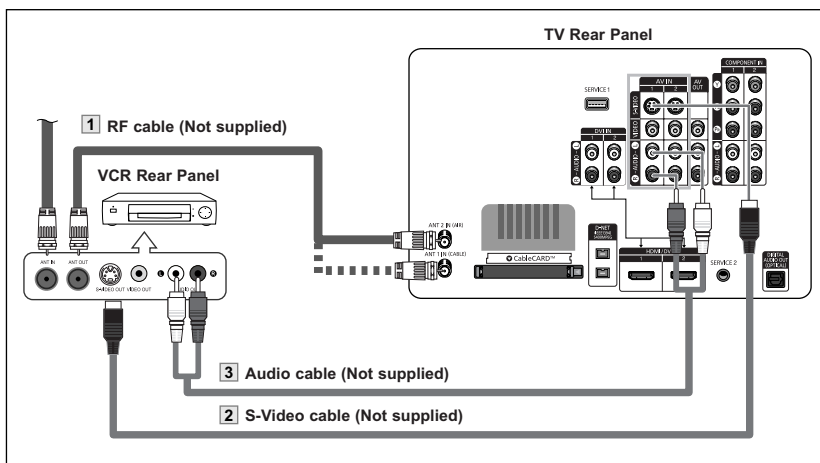

An S-video cable is usually included with an S-VHS VCR. (If not, check your local electronics store.)

- Each S-VHS VCR has a different back panel configuration.
- When connecting an S-VHS VCR, match the color of the connection terminal to the cable.

1. To begin, follow steps 1–3 in the previous section to connect the antenna or cable to your VCR and your TV.
2. Connect an S-Video cable between the S-VIDEO OUT jack on the VCR and the AV IN 1 (or AV IN 2) [S-VIDEO] jack on the TV.
3. Connect Audio cables between the AUDIO OUT jacks on the VCR and the AV IN 1 (or AV IN 2) [R-AUDIO-L] jacks on the TV.

Connecting a Camcorder

The side panel jacks on your TV make it easy to connect a camcorder to your TV. They allow you to view the camcorder tapes without using a VCR.

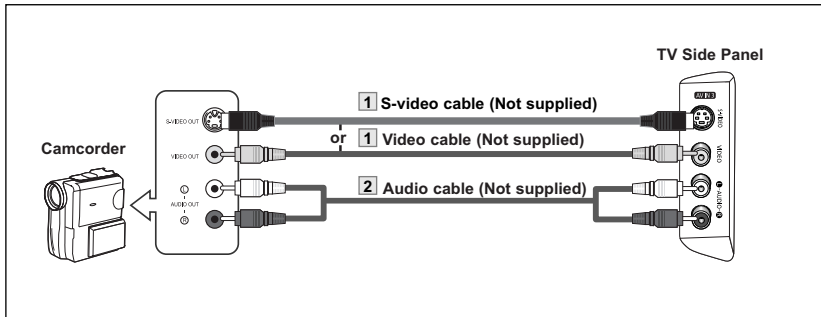

1. Connect a Video Cable (or S-video cable) between the AV IN 3 [VIDEO] (or S-VIDEO) jack on the TV and the VIDEO OUT jack on the camcorder.
2. Connect Audio cables between the AV IN 3 [R-AUDIO-L] jacks on the TV and the AUDIO OUT jacks on the camcorder.

- Each Camcorder has a different back panel configuration.
- When connecting a Camcorder, match the color of the connection terminal to the cable.

Connecting a DVD Player/Set-Top Box

The rear panel jacks on your TV make it easy to connect a DVD player to your TV.

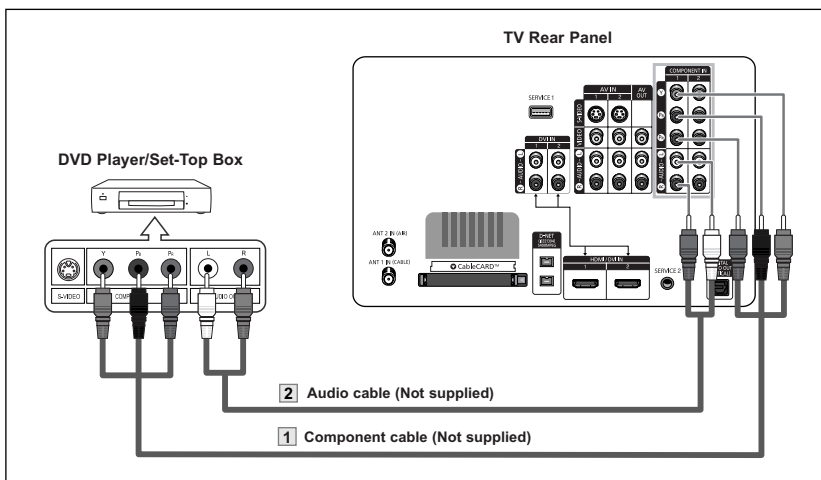

1. Connect a Component cables between the COMPONENT IN 1 or 2 [Y, P_B, P_R] jacks on the TV and the COMPONENT [Y, P_B, P_R] jacks on the DVD player.
2. Connect Audio cables between the COMPONENT IN 1 or 2 [R-AUDIO-L] jacks on the TV and the AUDIO OUT jacks on the DVD player.

- Component video separates the video into Y (Luminance (brightness)), Pb (Blue) and Pr (Red) for enhanced video quality. Be sure to match the component video and audio connections. For example, if connecting the video cable to COMPONENT IN 1, connect the audio cable to COMPONENT IN 1 also.
- Each DVD player/STB has a different back panel configuration.
- When connecting a DVD player/STB, match the color of the connection terminal to the cable.

Connecting a DVD Player/Set-Top Box via DVI

This connection can only be made if there is a DVI Output connector on the external device.

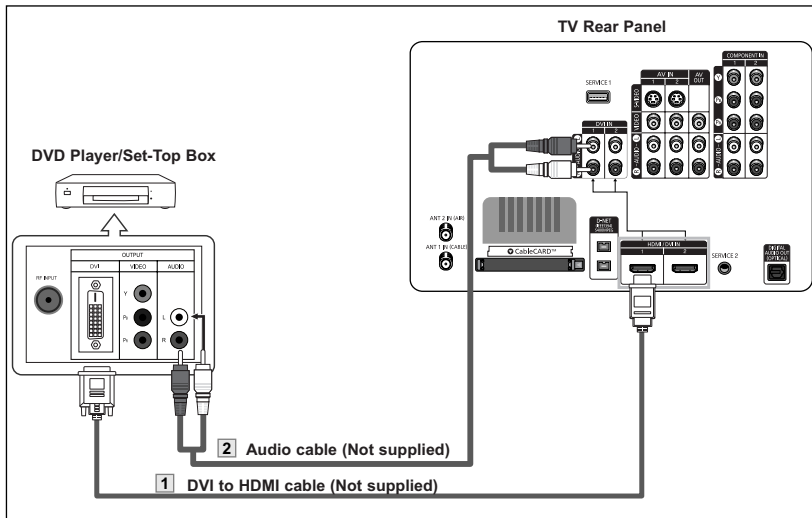

1. Connect a DVI to HDMI cable or DVI-HDMI Adapter between the HDMI/DVI IN 1 or HDMI/DVI IN 2 connector on the TV and the DVI connector on the DVD player/Set-Top Box.
2. Connect Audio cables between the DVI IN 1 (or DVI IN 2) [R-AUDIO-L] jack on the TV and the AUDIO OUT jacks on the DVD player/Set-Top Box.

- Each DVD player/STB has a different back panel configuration.
- When connecting a DVD player/STB, match the color of the connection terminal to the cable.

Connecting a DVD Player/Set-Top Box via HDMI

This connection can only be made if there is an HDMI Output connector on the external device.

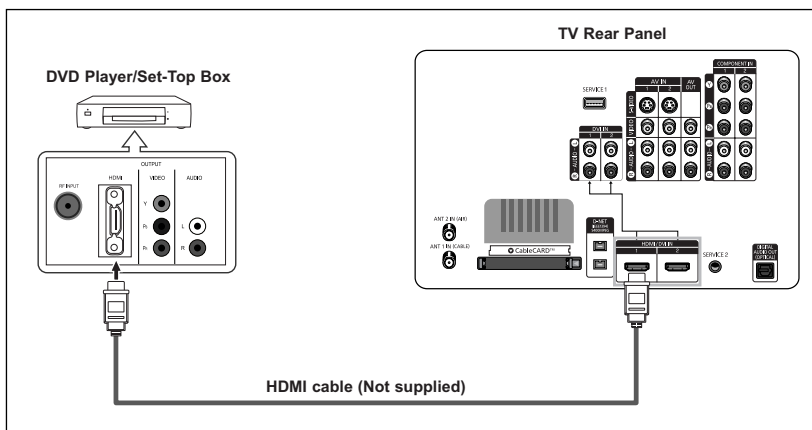

1. Connect an HDMI cable between the HDMI/DVI IN 1 or HDMI/DVI IN 2 connector on the TV and the HDMI connector on the DVD player/Set-Top Box.

What is HDMI?

- HDMI, or high-definition multimedia interface, is a next-generation interface that enables the transmission of the digital audio and video signals using a single cable without compression.
 - "Multimedia interface" is a more accurate name for it especially because it allows multiple channels of digital audio (5.1 channels).
The difference between HDMI and DVI is that the HDMI device is smaller in size, has the HDCP (High Bandwidth Digital Copy Protection) coding feature installed, and supports multi-channel digital audio.
- Each DVD player/Set-top box has a different back panel configuration.
 - When connecting a DVD player/Set-top box, match the color of the connection terminal to the cable.

Connecting a Digital Audio System

The rear panel jacks on your TV make it easy to connect a Digital Audio System to your TV.

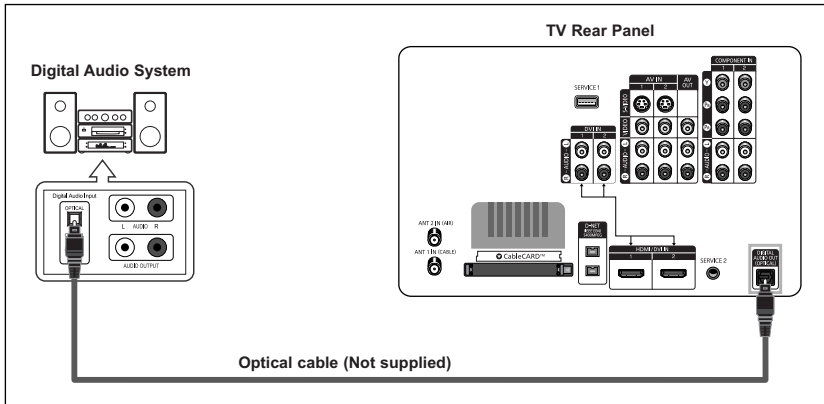

1. Connect an Optical cable between the DIGITAL AUDIO OUT (OPTICAL) jacks on the TV and the Digital Audio Input jacks on the Digital Audio System.

When a Digital Audio System is connected to the DIGITAL AUDIO OUT (OPTICAL) terminal: Decrease the gain (volume) of the TV, and adjust the volume level with the system's volume control.

What is OPTICAL?

- Converts the electric signal into an optical light signal, and transmits it through glass fibers. S/PDIF is a transmission system of digital audio in the form of a light wave that uses a glass conductor.
- 5.1CH audio is possible when the TV is connected to an external device supporting 5.1CH.

Connecting an Amplifier/DVD Home Theater

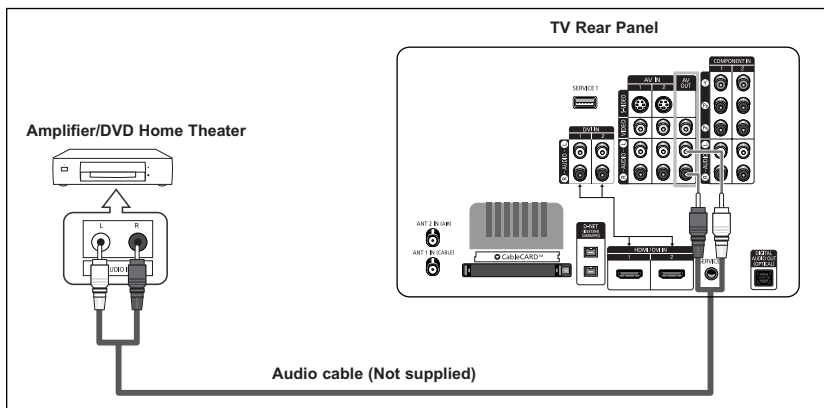

1. Connect Audio cables between the AV OUT [R-AUDIO-L] on the TV and AUDIO IN [R-AUDIO-L] on the Amplifier/DVD Home Theater.

When an audio amplifier is connected to the AV OUT [R-AUDIO-L] terminals: Decrease the gain (volume) of the TV, and adjust the volume level with the Amplifier's volume control.

- Each external input source device has a different back panel configuration.
- When connecting an external device, match the color of the connection terminal to the cable.

	Internal Speakers			Audio Out (Optical L/R)			Video Out		
	RF	AV, S-Video	Component, HDMI	RF	AV, S-Video	Component, HDMI	RF	AV, S-Video	Component, HDMI
Internal Mute Off	Speaker Out	Speaker Out	Speaker Out	Sound Output	Sound Output	Sound Output	Video Out	Video Out	Video Out
Internal Mute On	Mute	Mute	Mute	Sound Output	Sound Output	Sound Output	Video Out	Video Out	Video Out

- When "Internal mute" is set to "On", Sound menus except "Multi-Track Options" cannot be adjusted.

Operation

Turning the TV On and Off

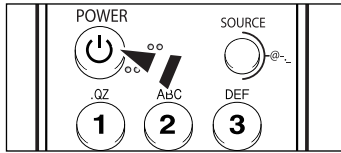

Press the **POWER** button on the remote control.
You can also use the **⏻ (Power)** button on the front of the panel.

Plug & Play Feature

When the TV is initially powered on, two basic settings proceed automatically and subsequently:

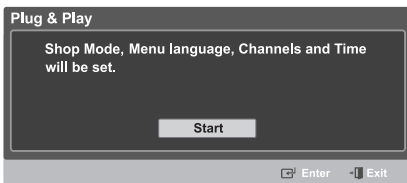

- 1 Press the **POWER** button on the remote control.
The message "Menu language, Channels and Time will be set." is displayed.
Press the **ENTER** button, then "Select the language of the OSD" menu is automatically displayed.

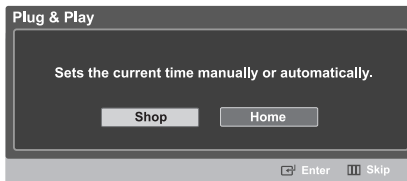

- 2 Press the **◀** or **▶** buttons to select "Shop" or "Home", then the **ENTER** button.

- We recommend setting the TV to Home mode for the best picture in your home environment.
- Shop mode is only intended for use in retail environments.
- If the unit is accidentally set to Shop Mode, press and hold the **MENU** button on the side panel of the TV for five seconds to return to Dynamic (Home) mode.

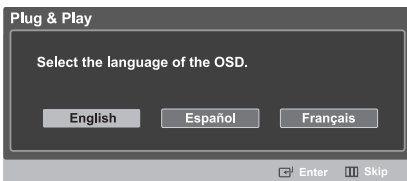

- 3 Press the **ENTER** button to enter the language.
Press the **◀** or **▶** button to select language, then the **ENTER** button.
"Select the antennas to memorize" menu is automatically displayed.



- 4 Press the **◀** or **▶** button to memorize the channels of the selected connection.
Press the **ENTER** button to select "Start".

- If the antenna is connected to ANT 2 IN (AIR), select "Air" and if it is connected to ANT 1 IN (CABLE), select "Cable".
- If both ANT 2 IN (AIR) and ANT 1 IN (CABLE) are connected, select "Air + Cable".
- In Cable mode, you can select the correct signal source among STD, HRC, and IRC by pressing the **◀** or **▶** button, then press the **ENTER** button.
Contact your local cable company to identify the type of cable system that exists in your particular area.

continued...

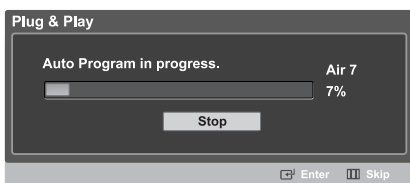

5 The TV will begin memorizing all of the available channels. After all the available channels are stored, the Auto program menu reappears. Press the **ENTER** button when channel memorization is completed.

- To stop the search before it has finished, press the **ENTER** button with stop selected.

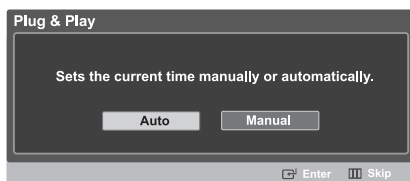
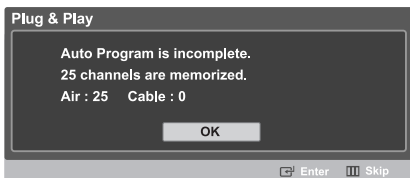

6 Press the **ENTER** button. Press the ◀ or ▶ buttons to select “Auto” or “Manual”, then the **ENTER** button. Switches the Daylight Saving Time function on or off.

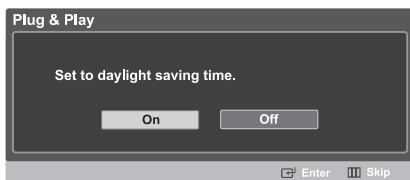

7 Press the **ENTER** button. Press the ◀ or ▶ buttons to select “On” or “Off”, then the **ENTER** button. “Select the time zone where you are located.” menu is automatically displayed.

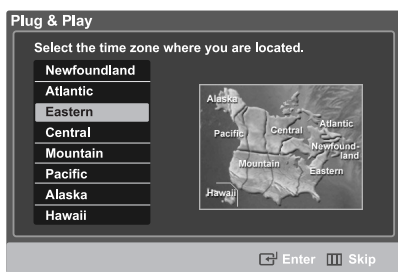

8 Press the ▲ or ▼ buttons to highlight the time zone for your local area (and to move the highlight to the appropriate time zone on the map of the United States). Press the **ENTER** button. If you have received a digital signal, the time will be set automatically. If not, see page 32 to set the clock.

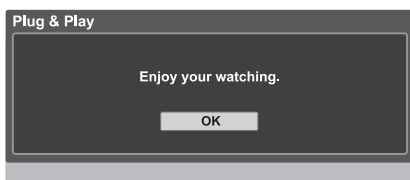

9 The message “Enjoy your watching.” is displayed. When you have finished, press the **ENTER** button.

- The basic Plug & Play setting is available only once when the TV is initially powered on. If the Plug and Play is stopped while it is in progress, you must set the functions manually by using the OSD menu.
- For the Language setting, see page 22.
- For the Auto Program setting, see page 23–24.
- For the Time setting, see page 31.

Dynamic Menus and On-Screen Displays

The on-screen menu system allows you to control the settings of your TV. Access the on-screen menu system by pressing the MENU button on the remote control. Once the on-screen menu appears, use the ▲/▼/◀/▶ / ENTER buttons on your remote control to select menu items and make adjustments. You can also view the on-screen menu system and make some adjustments using the TV's front panel buttons.

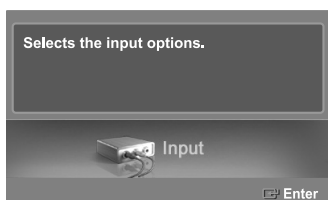

Viewing the Menu

- 1 Press the **MENU** button.
The main menu will appear at the bottom of the screen.
There are Seven menu groups: "Input", "Picture", "Sound", "Channel", "Setup", "Application" and "Menu Map".



- 2 Press the ◀ or ▶ button, then press the **ENTER** button to select an item you want in the menu.
Press the ▲/▼/◀/▶ / **ENTER** buttons to display, change, or use the selected items. Select "Return" by pressing the ▲ or ▼ button, then press the **ENTER** button to return to the previous menu.
Press the **EXIT** button to exit.

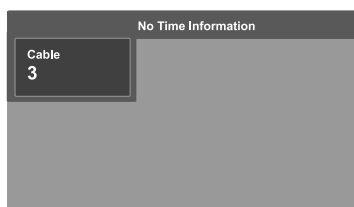

Viewing the Display

Press the **INFO** button on the remote control.
The TV displays the current channel, the status of certain picture, sound settings and the current time.
The information displayed varies according to the selected source.

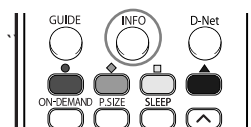

Navigating Menus by Using the Menu Map

Using the Menu Map of the main menu enables you to select a function quickly.

1 Press the **MENU** button. The main menu will appear at the bottom of the screen.

2 Press the ◀ or ▶ button to select "Menu Map", then press the **ENTER** button.
The menu map will appear.

3 Press the ▲/▼/◀/▶ buttons to select a menu, then press the **ENTER** button.
The selected menu will appear.

4 Press the ▲/▼/◀/▶/ **ENTER** buttons to display, change, or use the selected items.

- Red button: Displays menus in alphabetical order.
- Yellow button: Moves to the next page.
- Green button: Moves to the previous page.
- ENTER button: Moves to the selected menu.

Press the **EXIT** button to exit.

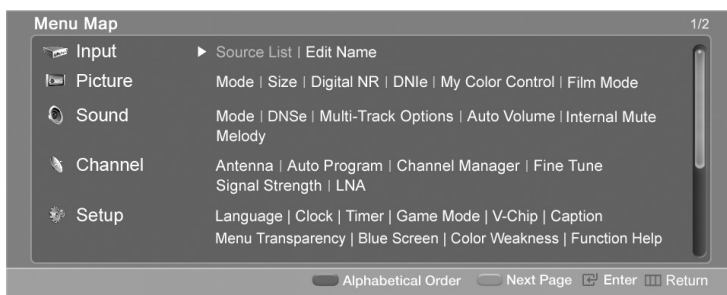

Selecting a Menu Language

When you start using your television for the first time, you must select the language which will be used for displaying menus and indications.



1 Press the **MENU** button. Press the ◀ or ▶ button to select “Setup”, then press the **ENTER** button.

2 Press the ▲ or ▼ to select “Language”, then press the **ENTER** button.

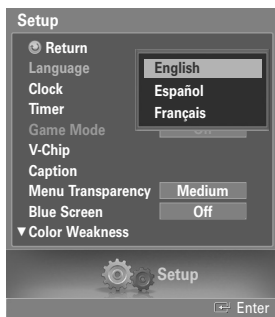

3 Press the ▲ or ▼ button to select “English”, “Español” or “Français”, then press the **ENTER** button.

Select “Return” by pressing the ▲ or ▼ button, then press the **ENTER** button to return to the previous menu. Press the **EXIT** button to exit.

Memorizing Channels

Your TV can memorize and store all of the available channels for both “off-air” (antenna) and cable channels. After the available channels are memorized, use the CH \wedge and CH \vee buttons to scan through the channels. This eliminates the need to change channels by entering the channel digits. There are three steps for memorizing channels: selecting a broadcast source, memorizing the channels (automatic) and adding and deleting channels (channel manager).

Selecting the Video Signal Source

Before your television can begin memorizing the available channels, you must specify the type of signal source that is connected to the TV (i.e., an air or cable system).



1 Press the **MENU** button. Press the \blacktriangleleft or \blacktriangleright button to select “Channel”, then press the **ENTER** button.

2 Press the \blacktriangleup or \blacktriangledown button to select “Antenna”, then press the **ENTER** button. Press the \blacktriangleup or \blacktriangledown button to select “Air” or “Cable”, then press the **ENTER** button.



3 Press the \blacktriangleup or \blacktriangledown button to select “Auto Program”, then press the **ENTER** button.

continued...



4 Press the ◀ or ▶ button to select the Antenna connection, then press the **ENTER** button.

- Air : "Air" antenna signal
- Cable : "Cable" antenna signal
- Air+Cable : "Air" and "Cable" antenna signals

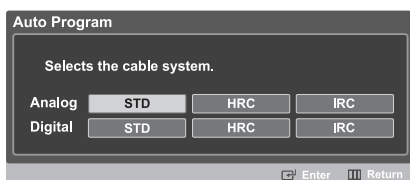

When selecting Cable TV system:
Press the **ENTER** button to start the auto program.
By default, the cable TV system is set to "STD".

If you want to select another type of cable system, press the ◀ or ▶ button to select "STD", "HRC" or "IRC".

- If you have Digital cable, select the signal source for both Analog and Digital.
- STD, HRC and IRC identify various types of cable TV systems. Contact your local cable company to identify the type of cable system that exists in your particular area.
At this point the signal source has been selected.

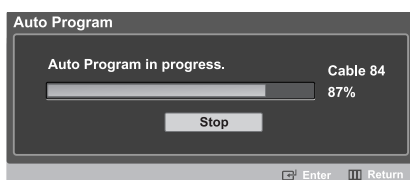

5 Press the **ENTER** button to start the auto program. The TV begins memorizing all available stations. Press the **ENTER** button at any time to interrupt the memorization process.

Select "Return" by pressing the ▲ or ▼ button, then press the **ENTER** button to return to the previous menu. Press the **EXIT** button to exit.

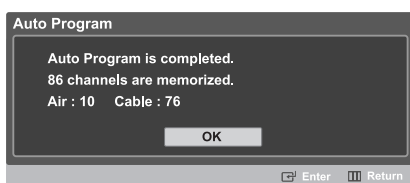

- The TV must be connected to air/cable in order to receive digital TV signals. Even if a particular channel is deleted from the memory, you can always tune to that channel directly by using the number buttons on the remote control.
- When connecting Digital Cable to a Set-Top Box, Channel Memorization is done on the STB.
To view the STB on your TV, select the Input jack the STB is connected to with the **SOURCE** button on the remote control. (see page 35)

➤ All available DTV and analog channels are automatically stored in memory.

Changing Channels

Using the Channel Buttons

Press the CH \wedge or CH \vee button to change channels.

When you press the CH \wedge or CH \vee button, the TV changes channels in sequence.

You will see all the channels that the TV has memorized.

(The TV must have memorized at least three channels.)

You will not see channels that were either erased or not memorized.

Using the Number Buttons

Use the number buttons to quickly switch to any channel.

Press the number buttons to go directly to a channel. For example, to select channel 27, press "2," then "7." The TV will change channels when you press the second number.

Using the "-" Button

The "-" button is used to select stations that broadcast a digital signal.



➤ HD indicates the TV is receiving a Digital High Definition signal.

SD indicates the TV is receiving a Analog standard definition signal.

For example, for channel 7-1, press "7", then "-", then "1".



Using the Previous Channel

Press the DEL/PRE-CH button.

The TV changes to the last channel you were watching.

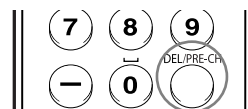

Setting Up Your Remote Control

After it has been set up properly, your remote control can operate in five different modes: TV, VCR, Cable, DVD, or Set-Top Box. Pressing the corresponding button on the remote control allows you to switch between these modes, and control whichever piece of equipment you choose.

➤ The remote control might not be compatible with all DVD Players, VCRs, Cable boxes, and Set-Top Boxes.

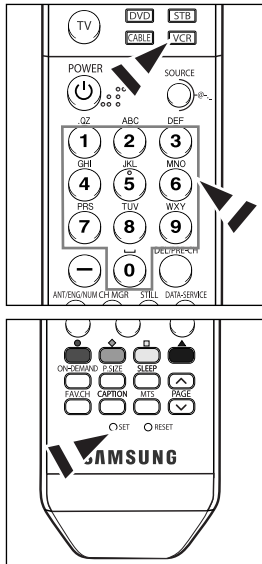

Setting Up the Remote to Operate Your VCR

1. Turn off your VCR.
2. Press the **VCR** button on your TV's remote control.
3. Press the **SET** button on your TV's remote control.
4. Using the number buttons on your remote control, enter three digits of the VCR code listed on page 28 of this manual for your brand of VCR. Make sure you enter three digits of the code, even if the first digit is a "0". (If more than one code is listed, try the first one.)
5. Press the **POWER** button on the remote control. Your VCR should turn on if your remote is set up correctly.

If your VCR does not turn on after set-up, repeat steps 2, 3 and 4, but try one of the other codes listed for your brand of VCR. If no other codes are listed, try each VCR code, 000 through 080.

Note on Using Remote Control Modes: VCR

When your remote control is in "VCR" mode, the volume buttons still control your TV's volume.

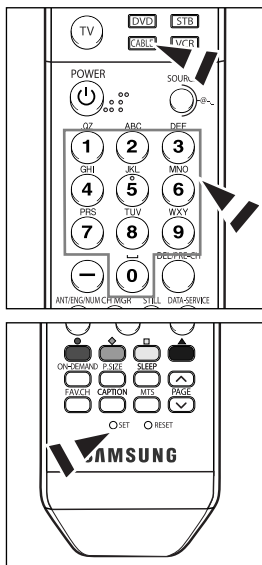

Setting Up the Remote to Operate Your Cable Box

1. Turn off your cable box.
2. Press the **CABLE** button on your TV's remote control.
3. Press the **SET** button on your TV's remote control.
4. Using the number buttons on your remote control, enter three digits of the cable box code listed on page 29 of this manual for your brand of cable box. Make sure you enter three digits of the code, even if the first digit is a "0". (If more than one code is listed, try the first one.)
5. Press the **POWER** button on the remote control. Your cable box should turn on if your remote is set up correctly.

If your cable box does not turn on after set-up, repeat steps 2, 3 and 4, but try one of the other codes listed for your brand of cable box. If no other codes are listed, try each code, 000 through 046.

Note on Using Remote Control Modes: Cable Box

When your remote control is in "CABLE" mode, the volume buttons still control your TV's volume.

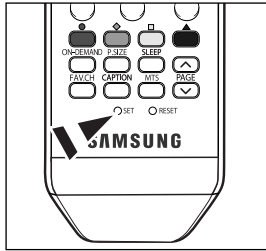
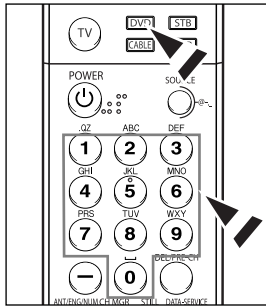

Setting Up the Remote to Operate Your DVD

1. Turn off your DVD.
2. Press the **DVD** button on your TV's remote control.
3. Press the **SET** button on your TV's remote control.
4. Using the number buttons on your remote control, enter three digits of the DVD code listed on pages 29~30 of this manual for your brand of DVD. Make sure you enter three digits of the code, even if the first digit is a "0". (If more than one code is listed, try the first one.)
5. Press the **POWER** button on the remote control.

Your DVD should turn on if your remote is set up correctly.
 If your DVD does not turn on after set-up, repeat steps 2, 3 and 4, but try one of the other codes listed for your brand of DVD. If no other codes are listed, try each code, 000 through 141.

Note on Using Remote Control Modes: DVD

When your remote control is in "DVD" mode, the volume buttons still control your TV's volume.

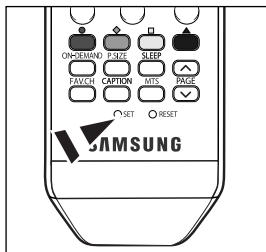
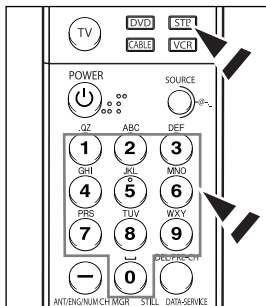

Setting Up the Remote to Operate Your Set Top Box

1. Turn off your STB.
2. Press the **STB** button on your TV's remote control.
3. Press the **SET** button on your TV's remote control.
4. Using the number buttons on your remote control, enter three digits of the STB code listed on page 30 of this manual for your brand of STB. Make sure you enter three digits of the code, even if the first digit is a "0". (If more than one code is listed, try the first one.)
5. Press the **POWER** button on the remote control.

Your STB should turn on if your remote is set up correctly.
 If your STB does not turn on after set-up, repeat steps 2, 3 and 4, but try one of the other codes listed for your brand of STB. If no other codes are listed, try each code, 000 through 074.

Note on Using Remote Control Modes: STB

When your remote control is in "STB" mode, the volume buttons still control your TV's volume.

Remote Control Codes

VCR

Brand	Code
SAMSUNG	000 001 002 003 004 005 077 078 079
ADMIRAL	020
AIWA	025
AKAI	004 027 032
AUDIO DYNAMICS	007 026
BELL&HOWELL	018
BROKSONIC	022
CANDLE	002 003 006 008 015 055
CANON	021 056
CITIZEN	002 003 006 008 015 055
COLORTYME	007
CRAIG	002 024
CURTIS MATHES	002 007 008 017 021 025 056 064 066
DAEWOO	003 010 011 012 013 014 015 016
DB	007 026
DIMENSIA	017
DYNATECH	025
ELECTROHOME	034
EMERSON	001 003 006 021 022 025 030 032 034 040 047 050 052 060 063 065 066 067 069 073
FISHER	018 024 028 029 048 051 061
FUNAI	025
GENERAL ELECTRIC	002 005 017 021 056
GO VIDEO	002
HARMAN KARDON	007
HITACHI	019 025 041 042 074
INSTANT REPLAY	021
JC PENNEY	002 007 018 019 021 026 037 041 054 056
JCL	007 008 018 021 026 037
JVC	081 082 083
KENWOOD	007 008 018 021 026 037
KLH	070
KONIA	036
LG(Goldstar)	006 007 008 009 010
LLOYD	025
LOGIK	038
LXI	025
MAGNAVOX	021 056 059
MARANTZ	007 008 018 021 026 037 062
MARTA	006
MEI	021
MEMOREX	006 021 024 025
MGA	034
MIDLAND	005
MINOLTA	019 041 075
MITSUBISHI	019 034 041 046

Brand	Code
MONTGOMERY WARD	020
MTC	002 025
MULTITECH	002 005 025 038
NEC	007 008 018 026 037 062 064
OPTIMUS	020
ORION	073 074 075 076
PANASONIC	021 056 071 072
PENTAX	019 041 075
PENTEX RESEARCH+	008
PHILCO	021 056 059
PHILIPS	021 080
PIONEER	019 026 039 053
PORTLAND	015 049 055
PROSCAN	017
QUARTZ	018
QUASAR	021 056
RADIO SHACK/REALISTIC	006 018 020 021 024 025 029 034 048 056
RCA	002 017 019 021 035 041 043 057 068 076
SANSUI	026
SANYO	018 024
SCOTT	003 047 052 067
SEARS	006 018 019 024 028 029 041 048 051
SHARP	020 034 045 015
SHIMTOM	027 033 038 058
SIGNATURE	025
SONY	027 033 044
SYLVANIA	021 025 056 059
SYMPHONIC	025
TANDY	018 025
TASHIKA	006
TATUNG	037
TEAC	025 037 068
TECHNICS	021
TEKNIKA	006 021 025 031
TMK	066
TOSHIBA	003 019 029 051 052
TOTEVISION	002 006
UNITECH	002
VECTOR RESEARCH	007 026
VICTOR	026
VIDEO CONCEPTS	007 026
VIDEOSONIC	002
WARDS	002 003 006 019 020 021 024 025 034 038 041
YAMAHA	007 008 018 026 037
ZENITH	023 027 033

CABLE BOX

Brand	Code
SAMSUNG	000 001 002 003 004 005 006 007
GI	041
HAMLIN	003 024 031
HITACHI	025 030
JERROLD	038 039
MACOM	025 030
MAGNAVOX	019 023 028
OAK	026
PANASONIC	003 022 027 037 044
PHILIPS	019 021 023 028
PIONEER	004 018 020 044
RCA	014 022 040
REGAL	003

Brand	Code
REGENCY	015 023
SA	042 043
SCIENTIFIC ATLAN	042 043
SPRUCER	022
STARGATE 2000	036
SYLVANIA	016
TEXSCAN	016
TOCOM	032
UNIVERSAL	033 034
VIEWSTAR	019 021 023 028
WARNER AMEX	046
ZENITH	017 029 035 037 045

SAMSUNG DVD

Product	Code
DVD	000 001 002
DVDR	003 004
BD Record	005 006
VCR COMBO	007 008 009 010 011
VCR Record	012
DHR COMBO	013

Product	Code
Home Theater VCR COMBO	014 015 016
HDD Recorder COMBO	017
TWIN TRAY COMBO	018
STB DVD COMBO	019
DVD Receiver	020
AV Receiver	021

DVD

Brand	Code
ANAM	030
AUDIOVOX	075
AUDIOLOGIC	085
ANABA	072
APEX DIGITAL	070 071 074 086 083 084 088 111 112
AIWA	114
BROKSONIC	062
BLAUPUNKT	074
B&K	122 123
CURTIS MATHES	027
CYBER HOME	077 078 079 082
CLARION	080 125
CIRRUS	081
CYBER HOME	065
CINEVISION	095
DAEWOO	066
DENON	146
FARENHEIT	067 068
FISHER	090
GPX	060
GO VIDEO	061 089 133 135
GE	069 074
GREENHILL	074
HITACHI	064 113
HITEKER	071
HOYO	073
HARMAN / KARDON	091 110
IRT	089

Brand	Code
INTEGRA	092
JBL	091
JVC	022 033 115 116
JATON	073
KENWOOD	051 108 109
KISS	073
KONKA	059 100 106 107
KLH	074 075
LG(Goldstar)	025 031
LOEWE	057
LASONIC	058
MOBILE AUTHORITY	054
MEMOREX	055
MALATA	056
MAGNAVOX	076 093
MINTEK	074 094
MONYKA	073
NORCENT	048 049 050
NEXT BASE	052
NEC	053
NANTAUS	144
NESA	074
OPTOMEDIAELECTRONICS	105
OPTIVIEW	072
ONKYO	076 092 119
PHILCO	044 045
PRINCETON	046 047
PROSCAN	023

DVD

Brand	Code
PANASONIC	024 034 124 134 136 137 138
PHILIPS	036 076
ROTEL	117 118
RIO	120
RCA	023 035 074 075 131 132
RAITE	073
ROWA	038
SAMPO	104
SONY	026 029 126 127 128 129 130 141
SHERWOOD	039 041
SVA	042
SYLVANIA	043 093
SHARP	140
SANSUI	062
SANYO	062 090
SHINSONIC	094

Brand	Code
THOMSON	145
TOSHIBA	028 062 076
TECHNICS	139
TVIEW	072
TOKAI	073
TEAC	096
TECHWOOD	097
TREDEX	098 099 101
URBAN CONCEPTS	076
VENTURER	075
VOCOPRO	102
YAMAHA	032 063
YAMAKAWA	040 073
XWAVE	103
ZENITH	076 121

SAMSUNG SET-TOP BOX

Product	Code
Ground wave STB	001 002
Satellite STB	003
CABLE STB	004
STB DVD COMBO	008
Satellite STB HDD COMBO Standard	009

Product	Code
Satellite STB HDD COMBO Premium	010
CABLE STB HDD COMBO Standard	011
CABLE STB HDD COMBO Premium	012
Ground wave STB HDD COMBO Standard	013
Ground wave STB HDD COMBO Premium	014

SET-TOP BOX

Brand	Code
ALPHASTAR	023
ANAM	043
CHANNEL MASTER	018 034
CROSSDIGITAL	019
CHAPARRAL	035
DIRECT TV	015 016 017 019 022 045 060 061 062 065 066 067 068
DAEWOO	074
DISH NETWORK SYSTEM	069 070
DISHPRO	069
DRAKE	018 024 032
DX ANTENNA	027
EHOSTAR	025 069 070 071
EXPRESSVU	069
GOI	069
GE	065
GENERAL INSTRUMENT	046 047 048 063 064
HTS	069
HOME CABLE	056
HITACHI	022
HUGHES NETWORK	015 017
IQ	020
IQ PRISM	020
JANEIL	059
JERROID	063
JVC	069 070
LG(Goldstar)	044 073

Brand	Code
MAGNAVOX	016 021 036 038 039 040 041 042
MEMOREX	016
MOTOROLA	064
MACOM	018
MITSUBISHI	015
NEXT LEVEL	047 048 064
PHILIPS	015 016 017 021 033 036 038 039 040 041 042 067
PRIMESTAR	046 049 050 063
PANASONIC	058 059 061 062
PAYSAT	016
PROSCAN	065 066
RCA	051 052 053 065 066
RADIOSHACK	064
REALISTIC	057
STAR TRAK	026
STS	020 027
SKY	031
SKY LIFE	005 006 007
SHACK	064
STAR CHOICE	064
SONY	054 060
TOSHIBA	015 017 028 029 030 072
ULTIMATE TV	060 066
UNIDEN	016 021 037 055 056 057
ZENITH	024 031 068

Setting the Clock

Setting the clock is necessary in order to use the various timer features of the TV.

Also, you can check the time while watching the TV. (Just press the **INFO** button.)

Option 1: Setting the Clock Manually



1 Press the **MENU** button. Press the ◀ or ▶ button to select "Setup", then press the **ENTER** button.

2 Press the ▲ or ▼ button to select "Clock", then press the **ENTER** button.

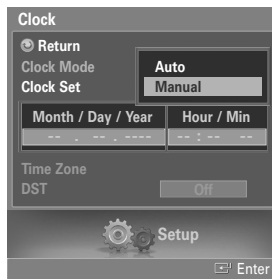

3 Press the ▲ or ▼ button to select "Clock Mode", then press the **ENTER** button. Press the ▲ or ▼ button to select "Manual", then press the **ENTER** button.

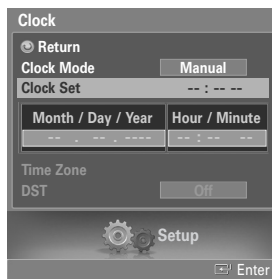

4 Press the ▲ or ▼ button to select "Clock Set", then press the **ENTER** button.

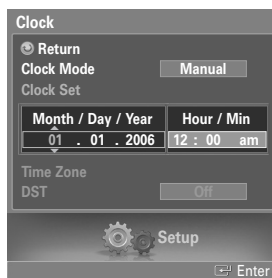

5 Press the ◀ or ▶ button to move to "Month", "Day", "Year", "Hour", "Min", or "am/pm". Set the time you want by pressing the ▲ or ▼ button, then press the **ENTER** button. The time set in the Clock Set will appear.

- You can set the month, day, year, hour and minute directly by pressing the number buttons on the remote control.

Select "Return" by pressing the ▲ or ▼ button, then press the **ENTER** button to return to the previous menu. Press the **EXIT** button to exit.

➤ The current time will appear every time you press the **INFO** button.



Option 2: Setting the Clock Automatically

The Clock can be set automatically if you are receiving a digital signal.



1 Press the **MENU** button. Press the ◀ or ▶ button to select “Setup”, then press the **ENTER** button.

2 Press the ▲ or ▼ button to select “Clock”, then press the **ENTER** button.

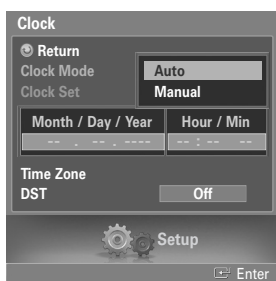

3 Press the ▲ or ▼ button to select “Clock Mode”, then press the **ENTER** button. Press the ▲ or ▼ button to select “Auto”, then press the **ENTER** button.

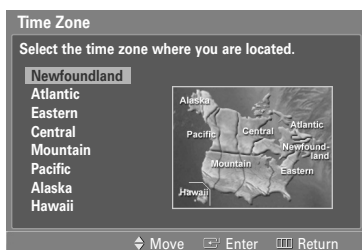

4 Press the ▲ or ▼ button to select “Time Zone”, then press the **ENTER** button. Press the ▲ or ▼ button to highlight the time zone for your local area (and to move the highlight to the appropriate time zone on the map of the United States), then press the **ENTER** button.

- When you set up Auto Time, the set time may not be correct depending on the broadcasting station and signal. If there is a difference between the real time and set time, please set the time manually.

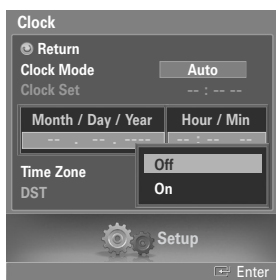

5 Press the ▲ or ▼ button to select “DST”(Daylight Saving Time), then press the **ENTER** button. Press the ▲ or ▼ button to select “On” or “Off”, then press the **ENTER** button.

Select “Return” by pressing the ▲ or ▼ button, then press the **ENTER** button to return to the previous menu. Press the **EXIT** button to exit.

Setting the On/Off Timer



- 1 Press the **MENU** button. Press the ◀ or ▶ button to select "Setup", then press the **ENTER** button.



- 2 Press the ▲ or ▼ button to select "Timer", then press the **ENTER** button.

Press the ▲ or ▼ button to select "On Timer", then press the **ENTER** button. Press the ▲ or ▼ button to adjust "Hour/Min", then press the ▶ button to move to the next step.

Set other items using the same method as above.

To activate On Timer with the setting entered, set Activation to "Off", "Mon~Fri", "Daily", or "Once" by pressing ▲ or ▼ button.

Press the **ENTER** button.

- You can set the hour, minute, and channel directly by pressing the number buttons on the remote control.

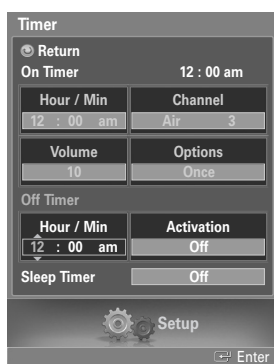

- 3 Press the ▲ or ▼ button to select "Off Timer", then press the **ENTER** button. Press the ▲ or ▼ button to adjust "Hour/Min", then press the ▶ button to move to the next step. Set other items using the same method as above.

To activate Off Timer with the setting entered, set Activation to "Off", "Mon~Sat", "Mon~Fri", "Daily", or "Once" by pressing ▲ or ▼ button. Press the **ENTER** button.

When finished, select "Return" by pressing ▲ or ▼ button and **ENTER** button to return to the previous menu. Press the **EXIT** button to exit.

- You can set the hour, minute, and channel directly by pressing the number buttons on the remote control.

➤ Auto Power Off

When you set the timer "On", the television will eventually turn off, if no controls are operated for 3 hours after the TV was turned on by the timer.

This function is only available in timer "On" mode and prevents overheating, which may occur if a TV is on for too long time.

Setting the Sleep Timer

The sleep timer automatically shuts off the TV after a preset time (from 30 to 180 minutes).

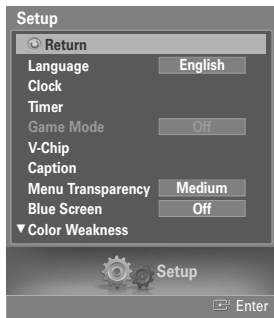

1 Press the **MENU** button. Press the ◀ or ▶ button to select “Setup”, then press the **ENTER** button.

2 Press the ▲ or ▼ button to select “Timer”, then press the **ENTER** button. Press the ▲ or ▼ button to select “Sleep Timer”, then press the **ENTER** button.

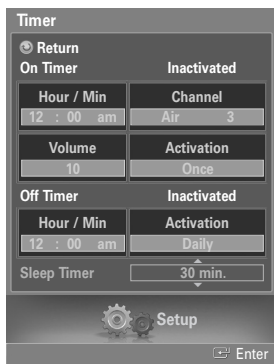

3 Press the ▲ or ▼ button to set sleep timer to “30 min.”, “60 min.”, “90 min.”, “120 min.”, “150 min.”, “180 min.”, or “Off”, then press the **ENTER** button. Select “Return” by pressing the ▲ or ▼ button, then press the **ENTER** button to return to the previous menu. Press the **EXIT** button to exit.

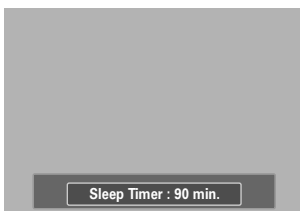

Alternate method

Press the **SLEEP** button on the remote control repeatedly until the appropriate interval appears (any of the preset values from “Off” to “180 min.”).

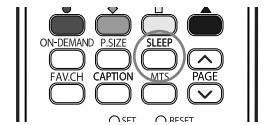

Viewing an External Signal Source

Use the remote control to switch between viewing signals from connected equipment, such as a VCR, DVD, Set-Top Box or the TV source (air or cable).

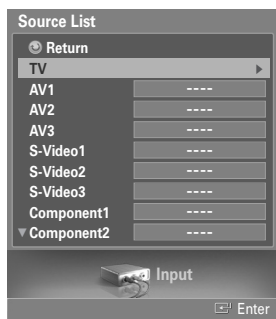

Setting the Signal Source

- 1 Press the **MENU** button.
Press the **ENTER** button to select "Input".

- 2 Press the **▲** or **▼** button to select "Source List", then press the **ENTER** button.
Press the **▲** or **▼** button to select a signal source, then press the **ENTER** button.

- When you connect equipment to the TV, you can choose between the following sets of jacks: "AV1", "AV2", "S-Video1", "S-Video2", "Component1", "Component2", "HDMI1", or "HDMI2" on the TV's rear panel, and "AV3", or "S-Video3" on the TV's side panel.

Alternate method

Press the **SOURCE** button on the remote control repeatedly to select an external signal source.

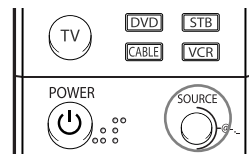

- Only connected devices can be selected.
- Before selecting an input source, make sure the corresponding external device is connected first.
- HDMI input can be selected only when the external device is turned on and connected to the TV.

Assigning Names to External Input Mode

This feature enables you to name the input source you have connected.



1 Press the **MENU** button. Press the **ENTER** button to select "Input".

2 Press the **▲** or **▼** button to select "Edit Name", then press the **ENTER** button.

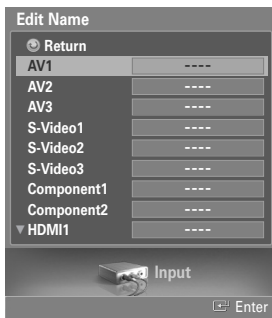

3 Press the **▲** or **▼** button to select a signal source to edit, then press the **ENTER** button.



4 Press the **▲** or **▼** button to select the external device : VCR, DVD, D-VHS, Cable STB, HD STB, Satellite STB, PVR STB, AV Receiver, DVD Receiver, Game, Camcorder, DVD Combo, DVD HDD Recorder, Internet TV Recv., Interactive TV Recv., VOD (Video On Demand) STB, TV.

Press the **ENTER** button.

Set other signal sources (AV1, AV2, AV3, S-Video1, S-Video2, S-Video3, Component1, Component2, HDMI1, HDMI2) using the same method as listed above.

Select "Return" by pressing the **▲** or **▼** button, then press the **ENTER** button to return to the previous menu.

Press the **EXIT** button to exit.

Channel Control

Selecting Your Favorite Channels

You can store your favorite channels for each available input source (such as TV and CATV).

Preset : To use the Channel Manager function, first run Auto Program (see pages 23~24).

To Store Your Favorite Channels:



- 1 Press the **MENU** button. Press the ◀ or ▶ button to select "Channel", then press the **ENTER** button.

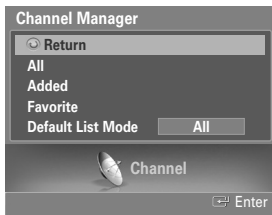

- 2 Press the ▲ or ▼ button to select "Channel Manager", then press the **ENTER** button. Press the ▲ or ▼ button to select "All", then press the **ENTER** button.



- 3 Press the ▲/▼/◀/▶ buttons to select a channel, then press the **ENTER** button and option window will appear.

Press the ▲ or ▼ button to select "Favorite", then press the **ENTER** button and a ♥ mark, designating the channel as a Favorite Channel will appear. Press the **ENTER** button again to deselect the selected channel and the ♥ mark will disappear.

- Red button (List Mode) : If you press the Red button repeatedly, the All Channel List, the Added Channel List or the Favorite Channel List is selected sequentially.

Select "Return" by pressing the ▲ or ▼ button, then press the **ENTER** button to return to the previous menu. Press the **EXIT** button to exit.

➤ Only memorized channels can be set as Favorite channels.

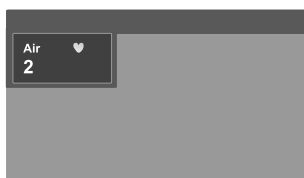

Alternate method

Select Channel menu → Channel Manager → Favorite
Press the **FAV.CH** button repeatedly to jump from one favorite channel to another.

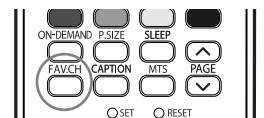

Viewing the Channel Lists

You can display a list of all channels, added channels, or your favorite channels.

Preset : To use the Channel Manager function, first run Auto Program (see pages 23~24).



- 1 Press the **MENU** button. Press the ◀ or ▶ button to select “Channel”, then press the **ENTER** button.

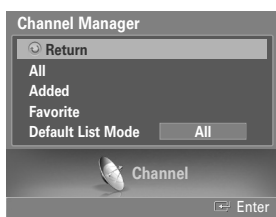

- 2 Press the ▲ or ▼ button to select “Channel Manager”, then press the **ENTER** button. Press the ▲ or ▼ button to select “All”, then press the **ENTER** button.

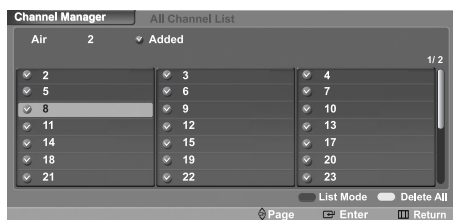

- 3 If you want to watch the channel, press the ▲/▼/◀/▶ buttons to select a channel, then press the **ENTER** button and the option window will appear.



- 4 Press the **ENTER** button to select “Watch”, then press the **ENTER** button again. The selected channel broadcasting window will appear.

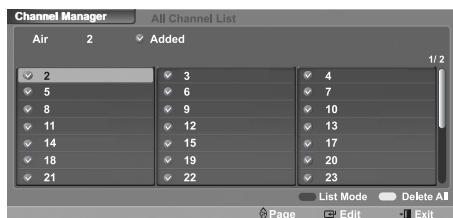

Alternate method

Press the **CH MGR** button on the remote control to display a list of channels.

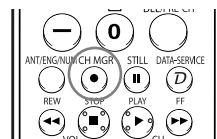

Adding and Erasing Channels

Preset : To use the Channel Manager function, first run Auto Program (See pages 23~24).



- 1 Press the **MENU** button. Press the ◀ or ▶ button to select “Channel”, then press the **ENTER** button.

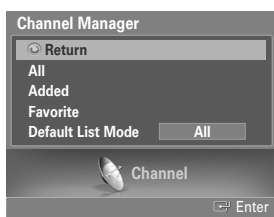

- 2 Press the ▲ or ▼ button to select “Channel Manager”, then press the **ENTER** button. Press the ▲ or ▼ button to select “Added” then press the **ENTER** button.



- 3 Press the ▲/▼/◀/▶ buttons to select a channel, then press the **ENTER** button and option window will appear. Press the ▲ or ▼ button to select “Add”, then press the **ENTER** button; the ● mark will appear and the channel will be added.

To deselect the selected channel, press the ▲ or ▼ button to select “Delete”, then press the **ENTER** button.

The ● mark will disappear.

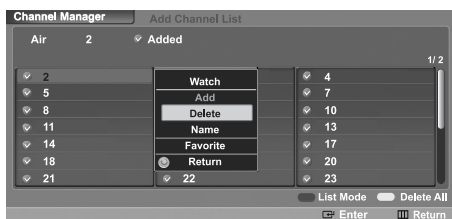

- Red button (List Mode) : If you press the Red button repeatedly, the All Channel List, the Added Channel List or the Favorite Channel List is selected sequentially.
- Green button (Add All) : Press to add all channels of the channel list.
- Yellow button (Delete All) : Press to delete all channels of the channel list.

Select “Return” by pressing the ▲ or ▼ button, then press the **ENTER** button to return to the previous menu.

Press the **EXIT** button to exit.

Labeling the Channels

Use this feature to assign an easy-to-remember label to analog channels (i.e., "CBS", "ESPN", "PBS2", "CNN02", and etc.) A label consists of five fields, where each field is a letter, a number or a blank. When the **INFO** button is pressed, the channel label will appear.



- 1 Press the **MENU** button. Press the ◀ or ▶ button to select "Channel", then press the **ENTER** button.

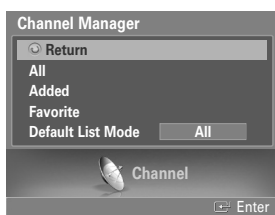

- 2 Press the ▲ or ▼ button to select "Channel Manager", then press the **ENTER** button. Press the ▲ or ▼ button to select "All", then press the **ENTER** button.

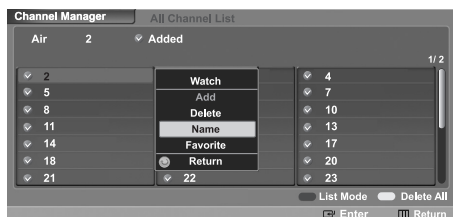

- 3 Press the ▲/▼/◀/▶ button to select a channel, then press the **ENTER** button and option window will appear. Press the ▲ or ▼ button to select "Name", then press the **ENTER** button.

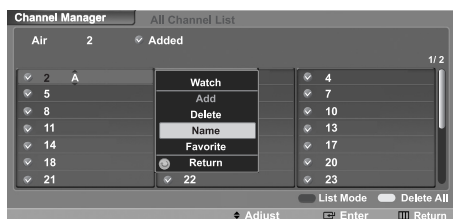

- 4 Press the ▲ or ▼ button to select a letter, a number or a blank. (Results in this sequence: A...Z, 0...9, +, -, *, /, blank).

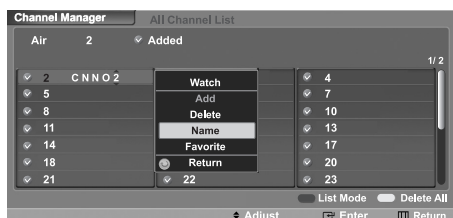

- 5 Press the ◀ or ▶ button to switch to the next field, which will be selected. Select a second letter or digit by pressing ▲ or ▼ button, as above.

Repeat the process to select the last three digits. To erase the assigned new name, press and hold the ▲ or ▼ button until a blank appears.

When you have finished, press the **MENU** button.

Select "Return" by pressing the ▲ or ▼ button, then press the **ENTER** button to return to the previous menu.

Press the **EXIT** button to exit.

- If you add or delete a TV channel, the labeled channels will also be added or deleted.

Fine Tuning Analog Channels **Analog**

Use fine tuning to manually adjust a particular channel for optimal reception.



1 Press the **MENU** button. Press the ◀ or ▶ button to select "Channel", then press the **ENTER** button.

2 Press the ▲ or ▼ button to select "Fine Tune", then press the **ENTER** button.



3 Press the ▼ button. Press the ◀ or ▶ button to adjust the fine tuning. To store the fine tuning setting in the TV's memory, press the **ENTER** button.



4 Press the ▲ or ▼ button to select "OK" or "Cancel". To reset the fine tuning setting, press the ▲ or ▼ button to select "OK", then press the **ENTER** button.

Select "Return" by pressing the ▲ or ▼ button, then press the **ENTER** button return to the previous menu. Press the **EXIT** button to exit.

- Only analog TV channels can be fine tuned.
- " * " will appear next to the name of fine-tuned channels.

Checking the Digital-Signal Strength Digital

Unlike analog channels, which can vary in reception quality from “snowy” to clear, digital (HDTV) channels have either perfect reception quality or you will not receive them at all. So, unlike analog channels, you cannot fine tune a digital channel. You can, however, adjust your antenna to improve the reception of available digital channels.

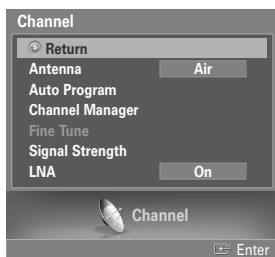

1 Press the **MENU** button. Press the ◀ or ▶ button to select “Channel”, then press the **ENTER** button.

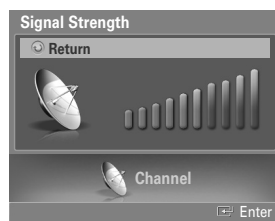

2 Press the ▲ or ▼ button to select “Signal Strength”, then press the **ENTER** button.

If the signal strength meter indicates that the signal is weak, physically adjust your antenna to increase the signal strength. Continue to adjust the antenna until you find the best position with the strongest signal.

Select “Return” by pressing the ▲ or ▼ button, then press the **ENTER** button to return to the previous menu. Press the **EXIT** button to exit.

LNA (Low Noise Amplifier)

If the TV is operating in a weak-signal area, sometimes the LNA function can improve the reception (a low-noise preamplifier boosts the incoming signal).

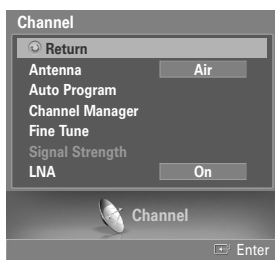

1 Press the **MENU** button. Press the ◀ or ▶ button to select “Channel”, then press the **ENTER** button.

2 Press the ▲ or ▼ button to select “LNA”, then press the **ENTER** button.



3 Press the ▲ or ▼ button to select “Off” or “On”, then press the **ENTER** button.

Select “Return” by pressing the ▲ or ▼ button, then press the **ENTER** button to return to the previous menu. Press the **EXIT** button to exit.

- The LNA setting must be made separately for each channel.
- If the picture is noisy with the LNA set to On, select Off.

Picture Control

Picture Control

You can select the type of picture which best corresponds to your viewing requirements.

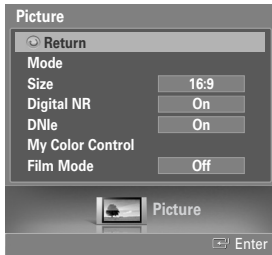

Changing the Picture Standard

1 Press the **MENU** button. Press the ◀ or ▶ button to select "Picture", then press the **ENTER** button.

2 Press the ▲ or ▼ button to select "Mode", then press the **ENTER** button. Press the ▲ or ▼ button again to select "Mode", then press the **ENTER** button.

3 Press the ▲ or ▼ button to select the desired picture mode (Dynamic, Standard, Movie, or Custom), then press the **ENTER** button.

Select "Return" by pressing the ▲ or ▼ button, then press the **ENTER** button to return to the previous menu. Press the **EXIT** button to exit.

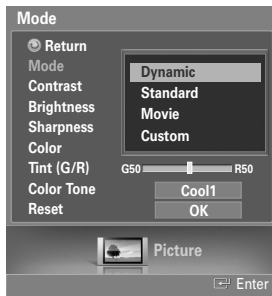

- Choose "Dynamic" for viewing the TV during the day or when there is a bright light in the room.
- Choose "Standard" for the standard factory settings.
- Choose "Movie" when viewing the movie.
- Choose "Custom" if you want to adjust the settings according to personal preference (see "Customizing the Picture Settings", page 44).

Customizing the Picture Settings

You can use the on-screen menus to change the “Contrast”, “Brightness”, “Sharpness”, “Color”, “Tint”, and “Color Tone” according to personal preference. You can select “Standard” which automatically recalls your personalized picture settings.



1 Press the **MENU** button. Press the ◀ or ▶ button to select “Picture”, then press the **ENTER** button.



2 Press the ▲ or ▼ button to select “Mode”, then press the **ENTER** button. Press the ▲ or ▼ button again to select “Mode”, then press the **ENTER** button.

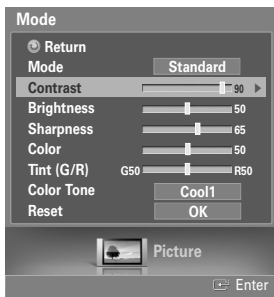

3 Press the ▲ or ▼ button to select the desired picture mode (Dynamic, Standard, Movie, or Custom), then press the **ENTER** button.

4 Press the ▲ or ▼ button to select a particular option (Contrast, Brightness, Sharpness, Color, or Tint (G/R)), then press the **ENTER** button.

Press the ◀ or ▶ button to decrease or increase the value of a particular item.



- While adjusting a picture option, you can also select another option (Contrast, Brightness, Sharpness, Color, or Tint (G/R)) by pressing the ▲ or ▼ button.

continued...

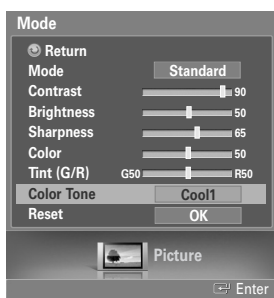

- 5 Press the **ENTER** button to return to “Mode”.
 Press the ▲ or ▼ button to select “Color Tone”, then press the **ENTER** button.



- 6 Press the ▲ or ▼ button to select a particular option (Cool2, Cool1, Normal, Warm1, or Warm2), then press the **ENTER** button.

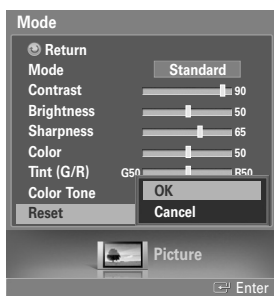

Resetting the Picture Settings to the Factory Defaults

- 7 To return the factory defaults, select “Reset” by pressing the ▲ or ▼ button.
 Press the **ENTER** button.
 Press the ▲ or ▼ button to select “OK” or “Cancel”, then press the **ENTER** button.

Select “Return” by pressing the ▲ or ▼ button, then press the **ENTER** button to return to the previous menu. Press the **EXIT** button to exit.

- If you set “Reset” to “OK”, the previously adjusted settings will be reset to the factory defaults.

➤ The reset function must be set separately for each mode (Dynamic, Standard, Movie, or Custom).

Changing the Picture Size

You can select the picture size which best corresponds to your viewing requirements.



- 1 Press the **MENU** button. Press the ◀ or ▶ button to select "Picture", then press the **ENTER** button.
Press the ▲ or ▼ button to select "Size", then press the **ENTER** button.

- 2 Press the ▲ or ▼ buttons to select the screen format you want, then press the **ENTER** button.

Select "Return" by pressing the ▲ or ▼ button, then press the **ENTER** button to return to the previous menu.
Press the **EXIT** button to exit.

- 16:9 : Sets the picture to 16:9 wide mode.
- Zoom1 : Magnifies the size of the picture on screen.
- Zoom2 : Magnifies the size of the picture more than "Zoom1".
- Wide Fit : Enlarges the aspect ratio of the picture to fit the entire screen.
- 4:3 : Sets the picture to 4:3 normal mode.

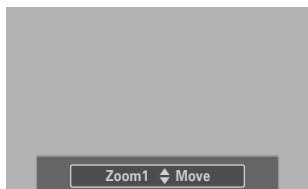

Alternate method

Press the **P.SIZE** button on the remote control repeatedly to select one of the picture size settings.

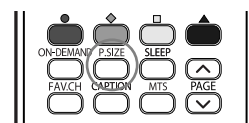

- You can select only the 16:9, 4:3 and Wide Fit screen sizes in the DTV Component (720p, 1080i) or HDMI (720p, 1080i) mode.
- For Zoom1, Zoom2, and Wide Fit (DTV's HD signal only), you can adjust the vertical position using the ▲ or ▼ button after pressing the P.SIZE button on the remote control.
- When watching a DTV's HD signal, you can use Wide Fit. Horizontal zoom (Wide Fit) sets the optical picture format by expanding it both horizontally and vertically. For example, you can reset the picture in 4:3 format to 16:9. Wide Fit does not support all external devices.
- To maintain scale in the Wide Fit mode, portions of the picture on the top and bottom will be cropped.

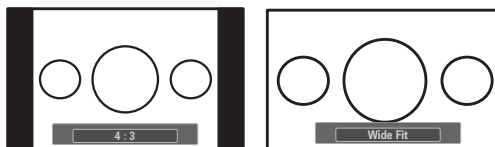

Setting the My Color Control Mode

My Color Control allows you to adjust colors according to your preference, by adjusting skin, sky, and grass tones using the predefined settings (Blue, Green, Pink, Standard, and Custom) without affecting other colors on the screen.



Using the My Color Control Function in the Easy Control Menu

Skin, sky and grass tones are easily adjustable to suit your preferences.

1 Press the **MENU** button. Press the ◀ or ▶ button to select "Picture", then press the **ENTER** button.

2 Press the ▲ or ▼ button to select "My Color Control", then press the **ENTER** button.

3 Press the ▲ or ▼ button to select "Easy Control", then press the **ENTER** button.

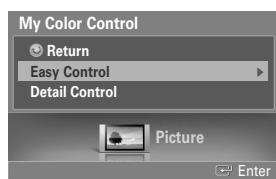

4 Press the ▲ or ▼ button to select from the various picture settings. The original picture (before adjustment) is shown on the left side, while the selected mode is shown on the right side.

- There are seven My Color Control modes: Blue, Green, Pink, Standard, and Custom.



Select "Return" by pressing the ▲ or ▼ button, then press the **ENTER** button to return to the previous menu.

Press the **EXIT** button to exit.

- Changing the settings in the "Detail Control" menu (see page 48) will automatically set the My Color Control mode to "Custom".
- Pressing the **ENTER** button on the remote control for 3 seconds when there is no OSD on the screen will display the My Color Control menu.

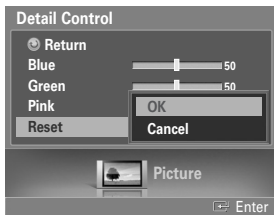
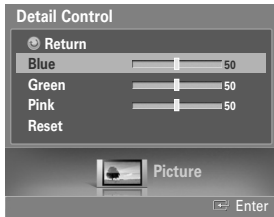
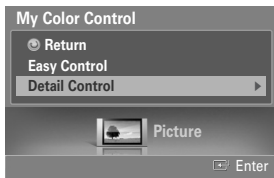

Using the My Color Control Function in the Easy Control Menu

Users can adjust the 3 My Color Control colors (Blue, Green, and Pink).

- 1 Press the **MENU** button. Press the ◀ or ▶ button to select "Picture", then press the **ENTER** button.
- 2 Press the ▲ or ▼ button to select "My Color Control", then press the **ENTER** button.
- 3 Press the ▲ or ▼ button to select "Detail Control", then press the **ENTER** button.
- 4 Press the ▲ or ▼ button to select the desired color and then press the **ENTER** or ▶ button.
 - The original picture (before adjustment) is shown on the left side, while the picture after adjustment is shown on the right side, and an adjustment bar is shown on the bottom of the screen.
- 5 Press the ◀ or ▶ button to adjust the settings. Press the ▲ or ▼ button to choose other colors.
- 6 Press the **ENTER** or **MENU** button to confirm the changes and return to the previous menu.

Resetting the My Color Control Colors to the Factory Defaults

You can return to the factory default settings for My Color Control colors.

- 7 Press the ▲ or ▼ button to select "Reset", then press the **ENTER** button. Press the ▲ or ▼ button to select "OK" or "Cancel", then press the **ENTER** button. The previously adjusted My Color Control colors will be reset to the factory defaults.

Select "Return" by pressing the ▲ or ▼ button, then press the **ENTER** button to return to the previous menu. Press the **EXIT** button to exit.

Using the Color Weakness Enhancement Feature

This feature adjusts the Red, Green or Blue color to compensate for the user's particular color weakness.

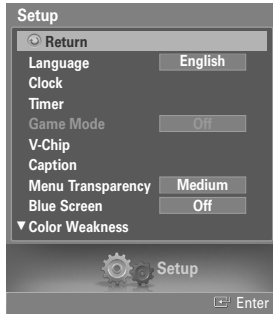

- 1 Press the **MENU** button. Press the ◀ or ▶ button to select "Setup", then press the **ENTER** button.

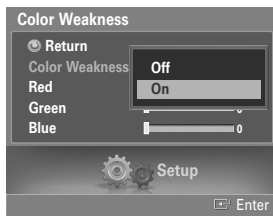

- 2 Press the ▲ or ▼ button to select "Color Weakness", then press the **ENTER** button. Press the ▲ or ▼ button to select "On", then press the **ENTER** button.

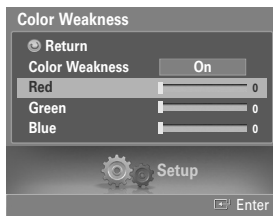

- 4 Press the ▲ or ▼ button to select a color to be adjusted, then press the **ENTER** button.

Press the ◀ or ▶ button to adjust the value of a color selected.



- You can also select these options (Red, Green, or Blue) by pressing the ▲ or ▼ button.

Select "Return" by pressing the ▲ or ▼ button, then press the **ENTER** button to return to the previous menu.
Press the **EXIT** button to exit.

Digital Noise Reduction

If the broadcast signal received by your TV is weak, you can activate the Digital Noise Reduction feature to help reduce any static and ghosting that may appear on the screen.



1 Press the **MENU** button. Press the ◀ or ▶ button to select "Picture", then press the **ENTER** button.

2 Press the ▲ or ▼ button to select "Digital NR", then press the **ENTER** button.

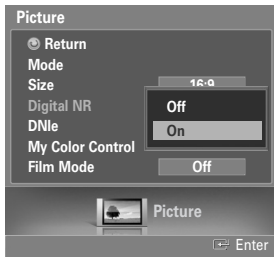

3 Press the ▲ or ▼ button to select "Off" or "On", then press the **ENTER** button.

Select "Return" by pressing the ▲ or ▼ button, then press the **ENTER** button to return to the previous menu.
Press the **EXIT** button to exit.

DNIe (Digital Natural Image engine)

This TV includes the DNIe function to provide high visual quality. If you set DNIe to on, you can view the screen with the DNIe feature activated. If you set the DNIe to Demo, you can view the applied DNIe and normal pictures on the screen, for demonstration purposes. Using this function, you can view the difference in the visual quality.



1 Press the **MENU** button. Press the ◀ or ▶ button to select "Picture", then press the **ENTER** button.

2 Press the ▲ or ▼ button to select "DNIe", then press the **ENTER** button.



3 Press the ▲ or ▼ button to select "Off", "Demo", or "On" then press the **ENTER** button.

- Off : Switches off the DNIe mode.
- Demo : The screen before applying DNIe appears on the left and the screen after applying DNIe appears on the right.
- On : Switches on the DNIe mode.

Select "Return" by pressing the ▲ or ▼ button, then press the **ENTER** button to return to the previous menu.

Press the **EXIT** button to exit.

➤ DNIe™ (Digital Natural Image engine) **DNIe™**

This feature brings you a more detailed image with 3D noise reduction and detail, contrast and white enhancement.

➤ The DNIe function is not supported in the Movie mode. (It is inactivated.)

Setting the Film Mode

You can automatically sense and process film signals from all sources and adjust the picture for optimum quality.



1 Press the **MENU** button. Press the ◀ or ▶ button to select "Picture", then press the **ENTER** button.

2 Press the ▲ or ▼ button to select "Film Mode", then press the **ENTER** button.



3 Press the ▲ or ▼ button to select "Off" or "On", then press the **ENTER** button.

Select "Return" by pressing the ▲ or ▼ button, then press the **ENTER** button to return to the previous menu.
Press the **EXIT** button to exit.

- The Film Mode can only be set when viewing an analog signal in AV modes (AV or S-Video) that support SD (Standard Definition) signals (480i).

Freezing the Picture

Press the **STILL** button to freeze a moving picture. (Normal sound will still be heard.)

To cancel this function, press the **STILL** button again or press any button on the remote control.

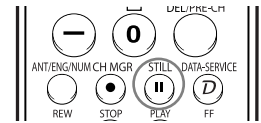

Setting the Blue Screen Mode

If no signal is being received or the signal is very weak, a blue screen automatically replaces the noisy picture background.

If you wish to continue viewing the poor picture, you must set the “Blue Screen” mode to “Off”.

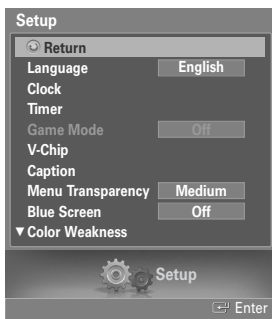

- 1 Press the **MENU** button. Press the ◀ or ▶ button to select “Setup”, then press the **ENTER** button.

- 2 Press the ▲ or ▼ button to select “Blue Screen”, then press the **ENTER** button.

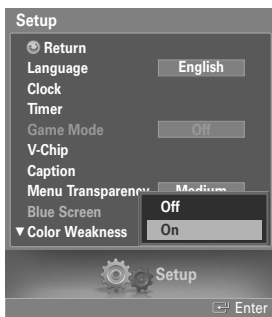

- 3 Press the ▲ or ▼ button to select “Off” or “On”, then press the **ENTER** button.

Select “Return” by pressing the ▲ or ▼ button, then press the **ENTER** button to return to the previous menu.

Press the **EXIT** button to exit.

Sound Control

Sound Control

You can control and customize the sound levels and settings of the TV with the remote control.

Adjusting the Volume

Press the **VOL+** or **VOL-** button to increase or decrease the volume.

Using the MUTE Button

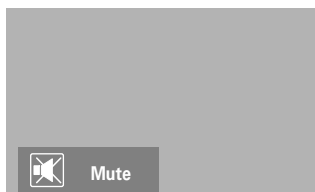

At any time, you can temporarily cut off the sound. Press the **MUTE** button on the remote control. The message "Mute" is displayed and the sound cuts off. To turn mute off, press the **MUTE** button again or press either the **VOL+** or **VOL-** button.

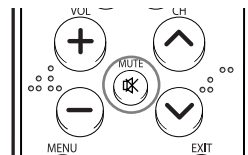

Using Automatic Sound Settings

Your TV has automatic sound settings ("Standard", "Music", "Movie", and "Speech") that are preset at the factory. You can select "Custom", which automatically recalls your personalized sound settings.

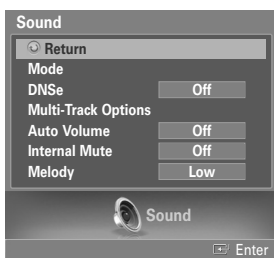

1 Press the **MENU** button. Press the ◀ or ▶ button to select "Sound", then press the **ENTER** button.

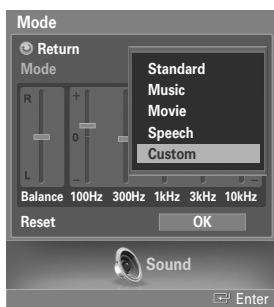

2 Press the ▲ or ▼ button to select "Mode", then press the **ENTER** button. Press the ▲ or ▼ button again to select "Mode", then press the **ENTER** button. Press the ▲ or ▼ button to select a particular item (Standard, Music, Movie, Speech, or Custom), then press the **ENTER** button.

Select "Return" by pressing the ▲ or ▼ button, then press the **ENTER** button to return to the previous menu. Press the **EXIT** button to exit.

- Choose "Standard" for the standard factory settings.
- Choose "Music" when watching music videos or concerts.
- Choose "Movie" when watching movies.
- Choose "Speech" when watching a show that is mostly dialog (i.e., news).
- Choose "Custom" to recall your personalized settings (see "Customizing the Sound", page 55).

➤ The **VOL+**, **VOL-** and **MUTE** buttons do not operate when the Internal Mute is set to on.

Customizing the Sound

The sound settings can be adjusted to suit your personal preference. (Alternatively, you can use one of the “automatic” settings.)

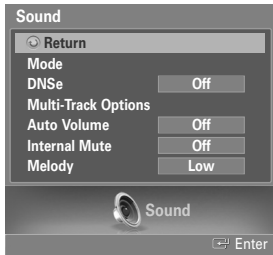

- 1 Press the **MENU** button. Press the ◀ or ▶ button to select “Sound”, then press the **ENTER** button.

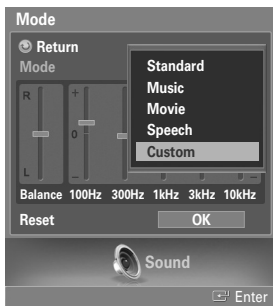

- 2 Press the ▲ or ▼ button to select “Mode”, then press the **ENTER** button. Press the ▲ or ▼ button again to select “Mode”, then press the **ENTER** button. Press the ▲ or ▼ button to select a particular item (Standard, Music, Movie, Speech, or Custom), then press the **ENTER** button.

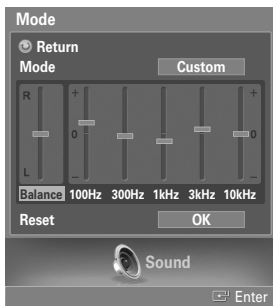

- 3 Press the ▼ button. Press the ◀ or ▶ button to select a particular item (Balance, 100Hz, 300Hz, 1kHz, 3kHz, 10kHz) to be changed, then press the **ENTER** button. Press the ▲ or ▼ button to increase or decrease the selected frequency. Press the **ENTER** button.

- The equalizer function is set for each mode (Standard, Music, Movie, Speech, or Custom).

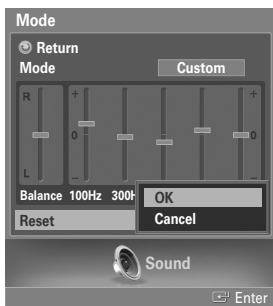

- 4 To return the factory defaults, select “Reset” by pressing the ▲ or ▼ button. Press the **ENTER** button. Press the ▲ or ▼ button to select “OK” or “Cancel”, then press the **ENTER** button.

Select “Return” by pressing the ▲ or ▼ button, then press the **ENTER** button to return to the previous menu. Press the **EXIT** button to exit.

- **L/R Sound Balance Adjustment**
To adjust the sound balance of the L/R speakers.
- **Bandwidth Adjustment (100Hz, 300Hz, 1kHz, 3kHz, 10kHz)**
To adjust the level of different bandwidth frequencies.

Setting up DNSe (Digital Natural Sound engine)

DNSe enhances the sound quality, automatically controls output, and prevents sound distortion.

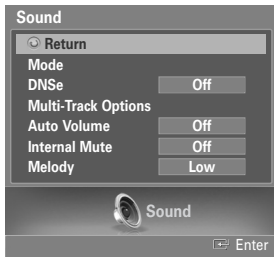

1 Press the **MENU** button. Press the ◀ or ▶ button to select "Sound", then press the **ENTER** button.

2 Press the ▲ or ▼ button to select "DNSe", then press the **ENTER** button.



3 Press the ▲ or ▼ button to select "Off" or "On", then press the **ENTER** button.

Select "Return" by pressing the ▲ or ▼ button, then press the **ENTER** button to return to the previous menu.
Press the **EXIT** button to exit.

Auto Volume

Each broadcasting station has its own signal conditions, and it is inconvenient to adjust the volume every time the channel is changed. “Auto Volume” automatically adjusts the volume of the desired channel by lowering the sound output when the modulation signal is high or by raising the sound output when the modulation signal is low.

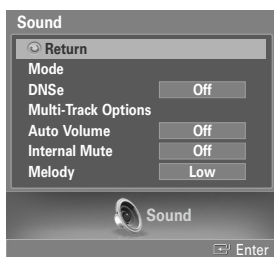

1 Press the **MENU** button. Press the ◀ or ▶ button to select “Sound”, then press the **ENTER** button.

2 Press the ▲ or ▼ button to select “Auto Volume”, then press the **ENTER** button.



3 Press the ▲ or ▼ button to select “Off” or “On”, then press the **ENTER** button.

Select “Return” by pressing the ▲ or ▼ button, then press the **ENTER** button to return to the previous menu.
Press the **EXIT** button to exit.

Choosing a Multi-Channel Sound (MTS) track Digital

The digital-TV transmission system is capable of simultaneous transmission of many audio tracks (for example, simultaneous translations of the program into foreign languages).

The availability of these additional “multitracks” depends upon the program.

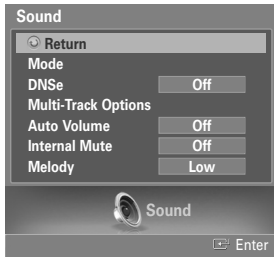

1 Press the **MENU** button. Press the ◀ or ▶ button to select “Sound”, then press the **ENTER** button.



2 Press the ▲ or ▼ button to select “Multi-Track Options”, then press the **ENTER** button.

3 Press the ▲ or ▼ button to select “Preferred Language”, then press the **ENTER** button.

Press the ▲ or ▼ button to choose the language (English, Spanish, or French) you want, then press the **ENTER** button.

Select “Return” by pressing the ▲ or ▼ button, then press the **ENTER** button to return to the previous menu.

Press the **EXIT** button to exit.



Alternate method

Press the **MTS** button on the remote control. You can listen in a language other than the favorite language by pressing the **MTS** button.

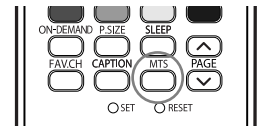

Choosing a Multi-Channel Sound (MTS) track Analog

Depending on the particular program being broadcast, you can listen to Stereo, SAP, or Mono.

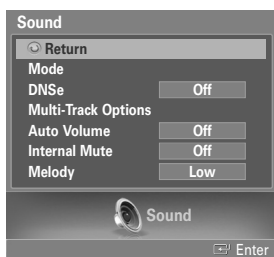

1 Press the **MENU** button. Press the ◀ or ▶ button to select “Sound”, then press the **ENTER** button.

2 Press the ▲ or ▼ button to select “Multi-Track Options”, then press the **ENTER** button.



3 Press the ▲ or ▼ button to select “Multi-Track Sound”, then press the **ENTER** button. Press the ▲ or ▼ button to select a setting you want, then press the **ENTER** button.

Select “Return” by pressing the ▲ or ▼ button, then press the **ENTER** button to return to the previous menu. Press the **EXIT** button to exit.

- Choose “Stereo” for channels that are broadcasting in stereo.
- Choose “SAP” to listen to the Separate Audio Program, which is usually a foreign-language translation.
- Choose “Mono” for channels that are broadcasting in mono, or if you are having difficulty receiving a stereo signal.



Alternate method

Press the **MTS** button on the remote control repeatedly to select “Mono”, “Stereo”, or “SAP”.

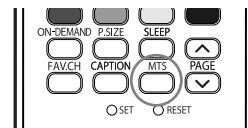

Selecting the Internal Mute

When using a device such as a Home Theater or Amplifier with external speakers, you can set Internal Mute to On to cut off sound from the TV's internal speakers.

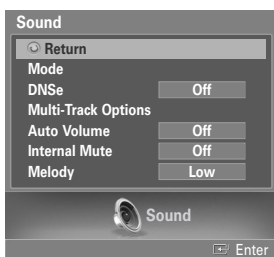

1 Press the **MENU** button. Press the ◀ or ▶ button to select "Sound", then press the **ENTER** button.

2 Press the ▲ or ▼ button to select "Internal Mute", then press the **ENTER** button.

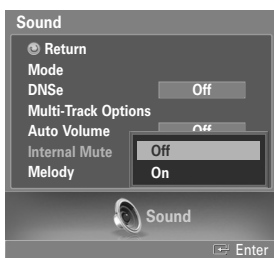

3 Press the ▲ or ▼ button to select "On", then press the **ENTER** button. Pressing the ▲ or ▼ button will alternate between "Off" and "On".

Select "Return" by pressing the ▲ or ▼ button, then press the **ENTER** button to return to the previous menu. Press the **EXIT** button to exit.

- The **VOL +**, **VOL -** and **MUTE** buttons do not operate when the Internal Mute is set to On.
- When Internal Mute is on, only the "Multi-Track Options" menu is available in the Sound menu.
- To watch TV with an external speaker system such as a home theater system, set Internal Mute to On. To watch TV with the internal speaker or to record video with a VCR through AV OUT of the TV, set Internal Mute to Off.

Setting the On/Off Melody

A melody sound can be set to come on when the TV is powered On or Off.

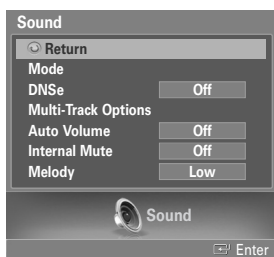

- 1 Press the **MENU** button. Press the ◀ or ▶ button to select "Sound", then press the **ENTER** button.

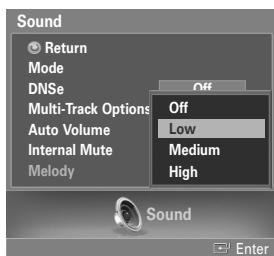

- 2 Press the ▲ or ▼ button to select "Melody", then press the **ENTER** button. Press the ▲ or ▼ button to select a value you want, then press the **ENTER** button.

Select "Return" by pressing the ▲ or ▼ button, then press the **ENTER** button to return to the previous menu. Press the **EXIT** button to exit.

Special Features

Setting the Function Help

Displays Help on the menu functions. The Help appears at the top of the screen.



- 1 Press the **MENU** button. Press the ◀ or ▶ button to select "Setup", then press the **ENTER** button.



- 2 Press the ▲ or ▼ button to select "Function Help", then press the **ENTER** button.

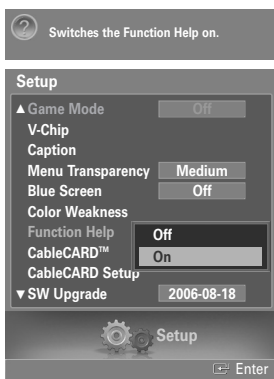

- 3 Press the ▲ or ▼ button to select "Off" or "On", then press the **ENTER** button.
Select "Return" by pressing the ▲ or ▼ button, then press the **ENTER** button to return to the previous menu.
Press the **EXIT** button to exit.

➤ The Function Help default setting is On.

Setting the Data Service

It is used to decide whether or not to use the Data Service. When it is set to "Off", all the functions relating to Data Application are disabled.



- 1 Press the **MENU** button. Press the ◀ or ▶ button to select "Setup", then press the **ENTER** button.

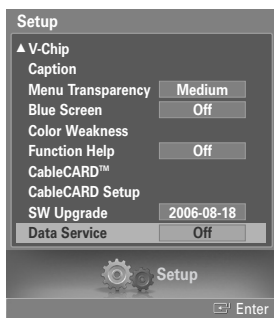

- 2 Press the ▲ or ▼ button to select "Data Service", then press the **ENTER** button.

- When the current antenna setting is "AIR", you cannot select "Data Service" because it is disabled.

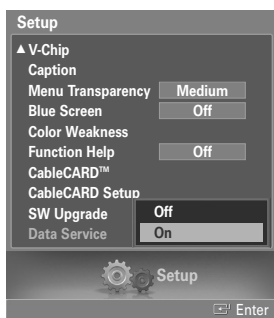

- 3 Press the ▲ or ▼ button to select "Off" or "On", then press the **ENTER** button.

- When the data service setting is changed from "On" to "Off", all the running Data Applications are closed so you cannot perform any operation relating to data services.

Select "Return" by pressing the ▲ or ▼ button, then press the **ENTER** button to return to the previous menu.

Press the **EXIT** button to exit.

- When the current antenna mode is "AIR", the data service is set to "Off". When the mode is changed to "CABLE", the data service is activated.
- When the current antenna mode is "CABLE", the data service is set to "On".

Menu Transparency Level

Adjusts the transparency of the menu screen.



- 1 Press the **MENU** button. Press the ◀ or ▶ button to select "Setup", then press the **ENTER** button.

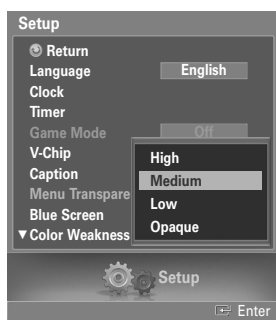

- 2 Press the ▲ or ▼ button to select "Menu Transparency", then press the **ENTER** button.
Press the ▲ or ▼ button to select level, then press the **ENTER** button.

Select "Return" by pressing the ▲ or ▼ button, then press the **ENTER** button to return to the previous menu.

Press the **EXIT** button to exit.

Using Game Mode

When connecting to a game console such as PlayStation™ or Xbox™, you can enjoy a more realistic gaming experience by setting the Game Mode to on.



1 Press the **MENU** button. Press the ◀ or ▶ button to select “Setup”, then press the **ENTER** button.

2 Press the ▲ or ▼ button to select “Game Mode”, then press the **ENTER** button.

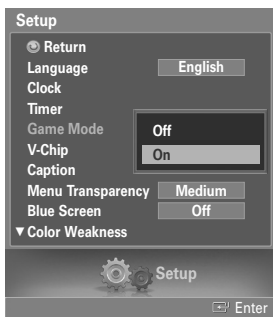

3 Press the ▲ or ▼ button to select “Off” or “On”, then press the **ENTER** button.

Select “Return” by pressing the ▲ or ▼ button, then press the **ENTER** button to return to the previous menu.
Press the **EXIT** button to exit.



Restrictions on Game Mode (Caution)

- To disconnect the game console and connect another external device, set Game to Off in the setup menu.
- If you display the TV menu in Game Mode, the screen shakes slightly.
- The mark (🎮) appears on the screen which means that Game Mode is on with the selected source.

- Game Mode is not available in TV mode.
- If the picture is poor when an external device (DVD, VCR etc.) is connected to the TV, check if the Game Mode is On. The Game Mode should be set to Off.

If Game Mode is On

- Picture and Sound Modes are automatically changed to Custom.
You cannot select other modes.
- Sound Mode in the Sound menu is deactivated. Adjust the sound using the equalizer.
- The Reset Sound function is activated. Selecting the Reset function after setting the equalizer resets it to the factory defaults.
- If the picture is poor when external device is connected to TV, check if Game Mode is On. Set Game Mode to Off and connect external devices.

Using the V-Chip

Access to channels and programs is controlled by a password (i.e., a 4-digit secret code that is defined by the user). The on-screen menu will instruct you to assign a password (you can change it later, if necessary).

How to Change Your Password



1 Press the **MENU** button. Press the ◀ or ▶ button to select “Setup”, then press the **ENTER** button.
Press the ▲ or ▼ button to select “V-Chip”, then press the **ENTER** button.

2 Press the ▼ button. Press the number buttons to enter your current 4-digit PIN. (The default PIN for a new TV set is “0000”.)
The “V-Chip” menu is displayed.



3 Press the ▲ or ▼ button to select “Change PIN”, then press the **ENTER** button.

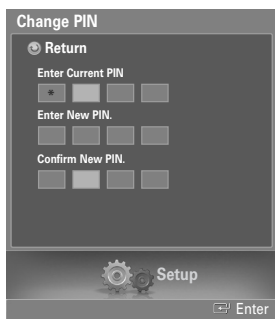

4 Press the ▼ button. Press the number buttons to enter your new 4-digit PIN. Re-enter your new PIN to confirm.

The message will automatically disappear, and return to the previous menu after a few seconds, even if the **ENTER** button is not pressed.

Select “Return” by pressing the ▲ or ▼ button, then press the **ENTER** button to return to the previous menu.
Press the **EXIT** button to exit.

- The PIP doesn't function when the V-Chip is active.
- If you forget the pin, press the remote control buttons in the following sequence, which resets the pin to 0-0-0-0: POWER (Off) → MUTE → 8 → 2 → 4 → POWER (On).
- The V-Chip function only works in TV, AV mode and S-Video mode.

U.S.A Only

This product is covered by the following U.S. patents : US4,930,158 US4,930,160

How to Enable/Disable the Rating Controls



1 Press the **MENU** button. Press the ◀ or ▶ button to select "Setup", then press the **ENTER** button.

Press the ▲ or ▼ button to select "V-Chip", then press the **ENTER** button.



2 Press the ▼ button. Press the number buttons to enter your current 4-digit PIN. (The default PIN for a new TV set is "0000".) The "V-Chip" menu is displayed.

3 The "V-Chip" screen will appear. Press the ▲ or ▼ button to select "V-Chip Lock". To enable the V-Chip feature, press the **ENTER** button so that the "V-Chip Lock" field is "On". (Pressing the ▲ or ▼ button will alternate between "On" and "Off".) Press the **ENTER** button.

Select "Return" by pressing the ▲ or ▼ button, then press the **ENTER** button to return to the previous menu. Press the **EXIT** button to exit.

How to Set up Restrictions Using “TV Parental Guidelines”

The parental restrictions can be set up using either of two methods: The “TV Parental Guidelines” or “MPAA Rating”.



- 1 Press the **MENU** button. Press the ◀ or ▶ button to select “Setup”, then press the **ENTER** button.

Press the ▲ or ▼ button to select “V-Chip”, then press the **ENTER** button.



- 2 Press the ▼ button. Press the number buttons to enter your current 4-digit PIN. (The default PIN for a new TV set is “0000”.) The “V-Chip” menu is displayed.

- 3 Press the ▲ or ▼ button to select “TV Parental Guidelines”, then press the **ENTER** button.

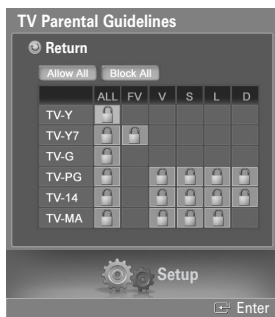

- 4 You can independently lock the TV ratings. The locked TV (FCC) ratings are indicated by the symbol “🔒”. Press the ▲/▼/◀/▶ buttons and the **ENTER** button to activate the appropriate restrictions for TV (FCC) rating system. To unlock items that are locked, press the **ENTER** button again.

TV-Y : Young children
 TV-Y7 : Children 7 and over
 TV-G : General audience
 TV-PG : Parent guidance
 TV-14 : Viewers 14 and over
 TV-MA : Mature audience

- Allow All : Press to unlock all TV ratings.
- Block All : Press to lock all TV ratings.

Select “Return” by pressing the ▲ or ▼ button, then press the **ENTER** button to return to the previous menu. Press the **EXIT** button to exit.

- These categories consist of two separate groups: “TV-Y” and “TV-Y7” (young children through age 7), and “TV-G” through “TV-MA” (everybody else).
- The restrictions for these two groups work independently: If a household includes very young children as well as young adults, the TV parental guidelines must be set up separately for each age group. (See page 70)

How to Set up Restrictions Using “MPAA Rating”

The Movie rating system uses the “MPAA” (Motion Picture Association of America) system, and its main application is for movies. When the rating control is on, the TV will automatically block any programs that are coded with objectionable ratings (either “MPAA Rating” or “TV Parental Guidelines”).

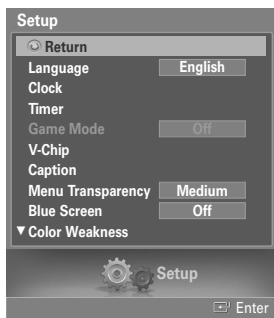

- 1 Press the **MENU** button. Press the ◀ or ▶ button to select “Setup”, then press the **ENTER** button.
Press the ▲ or ▼ button to select “V-Chip”, then press the **ENTER** button.



- 2 Press the ▼ button. Press the number buttons to enter your current 4-digit PIN. (The default PIN for a new TV set is “0000”.)
The “V-Chip” menu is displayed.

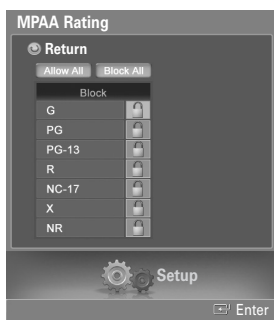

- 3 Press the ▲ or ▼ button to select “MPAA Rating”, then press the **ENTER** button.

- 4 Press the ▲ or ▼ button to select a appropriate restriction.
Press the **ENTER** button to activate the restriction selected.
The “🔒” symbol is indicated.
To unlock items that are locked, press the **ENTER** button again.

Select “Return” by pressing the ▲ or ▼ button, then press the **ENTER** button to return to the previous menu.
Press the **EXIT** button to exit.

- Allow All : Press to unlock all TV ratings.
- Block All : Press to lock all TV ratings.

Important Notes About Parental Locks

Explanation of the MPAA and TV (FCC) Rating Systems:

TV (FCC) Age-Based Ratings

TV-Y

All children. The themes and elements in this program are specifically designed for a very young audience, including children from ages two to six.

TV-Y7

Directed to older children. The Themes and elements in this program may include mild physical or comedic violence, or may frighten children under the age of seven.

TV-G

General audience. It contains little or no violence, no strong language, and little or no sexual dialog or situations.

TV-PG

Parental guidance suggested. This program may contain infrequent coarse language, limited violence, some suggestive sexual dialog and situations.

TV-14

Parents strongly cautioned. This program may contain sophisticated themes, sexual content, strong language and more intense violence.

TV-MA

Mature audiences only. This program may contain mature themes, profane language, graphic violence and explicit sexual content.

TV (FCC) Content Category

FV	Fantasy violence.
D	Sexually suggestive dialog.
L	Adult language.
S	Sexual situation.
V	Violence.

MPAA Rating System (Movies)

G	General audience (no restriction).
PG	Parental guidance suggested.
PG-13	Parents strongly cautioned.
R	Restricted. Children under 17 should be accompanied by an adult.
NC-17	No children under age 17.
X	Adults only.
NR	Not rated.

- TV (FCC) ratings : The particular rating that you have selected will be locked (and indicated as a red "L" on a blue background). Also, all of the age-based ratings will be locked within the particular group (i.e., "group 1" or "group 2"). Suppose that the TV-G rating and all of its contents (V, S, L, and D) are locked. In that case, more restrictive ratings (TV-PG, TV-14, and TV-MA) and all of their contents (V, S, L, and D) are automatically locked as well.
- MPAA ratings : The particular rating that you have selected will be locked. In addition, more restrictive ratings will be locked as well.
- Neither TV (FCC) ratings nor MPAA ratings apply to news programs.

How to Set up Restrictions Using Canadian English



- 1 Press the **MENU** button. Press the ◀ or ▶ button to select "Setup", then press the **ENTER** button.
Press the ▲ or ▼ button to select "V-Chip", then press the **ENTER** button.

- 2 Press the ▼ button. Press the number buttons to enter your current 4-digit PIN. (The default PIN for a new TV set is "0000".)
The "V-Chip" menu is displayed.



- 3 Press the ▲ or ▼ button to select "Canadian English", then press the **ENTER** button.

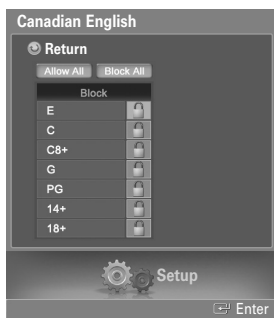

- 4 Press the ▲ or ▼ button to select a appropriate restriction.
Press the **ENTER** button to activate the restriction selected.
The "🔒" symbol is indicated.
To unlock items that are locked, press the **ENTER** button again.

Select "Return" by pressing the ▲ or ▼ button, then press the **ENTER** button to return to the previous menu.
Press the **EXIT** button to exit.

➤ **Allow All** : Press to unlock all TV ratings.

Block All : Press to lock all TV ratings.

- E** Exempt programming includes...news, sports, documentaries and other information programming, talk shows, music videos, and variety programming.
- C** Programming intended for children under age 8.
- C8+** Programming generally considered acceptable for children 8 years and over to watch on their own.
- G** General programming, suitable for all audiences.
- PG** Parental guidance.
- 14+** Programming contains themes or content which may not be suitable for viewers under the age of 14.
- 18+** Adult programming.

How to Set up Restrictions Using Canadian French



- 1 Press the **MENU** button. Press the ◀ or ▶ button to select “Setup”, then press the **ENTER** button.
Press the ▲ or ▼ button to select “V-Chip”, then press the **ENTER** button.



- 2 Press the ▼ button. Press the number buttons to enter your current 4-digit PIN. (The default PIN for a new TV set is “0000”.)
The “V-Chip” menu is displayed.



- 3 Press the ▲ or ▼ button to select “Canadian French”, then press the **ENTER** button.

- 4 Press the ▲ or ▼ button to select a appropriate restriction.
Press the **ENTER** button to activate the restriction selected.
The “🔒” symbol is indicated.
To unlock items that are locked, press the **ENTER** button again.

Select “Return” by pressing the ▲ or ▼ button, then press the **ENTER** button to return to the previous menu.
Press the **EXIT** button to exit.

- Allow All : Press to unlock all TV ratings.
- Block All : Press to lock all TV ratings.

- | | |
|----------------|---|
| E | Exempt programming includes...news, sports, documentaries and other information programming, talk shows, music videos, and variety programming. |
| G | General. |
| 8 ans+ | Not recommended for young children. |
| 13 ans+ | Programming may not be suitable for children under the age of 13. |
| 16 ans+ | Programming is not suitable for children under the age of 16. |
| 18 ans+ | Programming restricted to adults. |

Using the V-Chip for Digital channels

Parental restriction information can be used while watching DTV channels.



- 1 Press the **MENU** button. Press the ◀ or ▶ button to select "Setup", then press the **ENTER** button.
Press the ▲ or ▼ button to select "V-Chip", then press the **ENTER** button.



- 2 Press the ▼ button. Press the number buttons to enter your current 4-digit PIN. (The default PIN for a new TV set is "0000".)
The "V-Chip" menu is displayed.

- 3 Press the ▲ or ▼ button to select "Downloadable U.S. Rating", then press the **ENTER** button.

- If information is not downloaded from the broadcasting station, the "Downloadable U.S. Rating" menu is deactivated.
- Parental restriction information is automatically downloaded while watching DTV channels. It may take several seconds.
- The "Downloadable U.S. Rating" menu is available for use after information is downloaded from the broadcasting station. However, depending on the information from the broadcasting station, it may not be available for use.

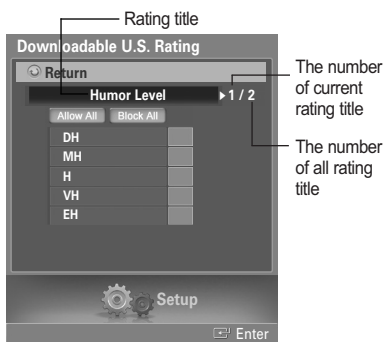

- 4 You can independently lock the TV ratings. The locked TV ratings are indicated by the symbol "🔒". To unlock a locked channel, press the **ENTER** button again.
Press the ▲/▼/◀/▶ buttons and the **ENTER** button to activate the appropriate restrictions for TV rating system.

Select "Return" by pressing the ▲ or ▼ button, then press the **ENTER** button to return to the previous menu.
Press the **EXIT** button to exit.

- Allow all: Press to unlock all TV ratings. / Block all: Press to lock all TV ratings.
- Parental restriction levels differ depending on the broadcasting station.
- The default menu name and downloadable US rating changes depending on the downloaded information.
- Even if you set the on-screen display to your desired language, the "Downloadable U.S. Rating" menu will appear in English only.
- The rating will automatically block certain categories that are more restrictive.
- The rating titles (for example : Violence Level..etc) and TV ratings (for example : NV, MV, V..etc) may differ depending on the broadcasting station.

Viewing Closed Captions (On-Screen Text Messages) Analog

The Analog Caption function operates in either analog TV channel mode or external source mode.
(Depending on the broadcasting signal, the Analog Caption function may operate on digital channels.)



1 Press the **MENU** button. Press the ◀ or ▶ button to select "Setup", then press the **ENTER** button.

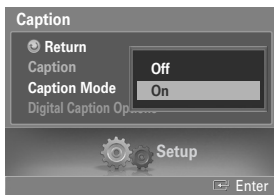

2 Press the ▲ or ▼ button to select "Caption", then press the **ENTER** button.



3 Press the ▲ or ▼ button to select "Caption", then press the **ENTER** button.
Press the ▲ or ▼ button to select "On", then press the **ENTER** button.

4 Press the ▲ or ▼ button to select "Caption Mode", then press the **ENTER** button.
Press the ▲ or ▼ button to select submenu (Default, CC1~CC4, or Text1~Text4) you want, then press the **ENTER** button.

Select "Return" by pressing the ▲ or ▼ button, then press the **ENTER** button to return to the previous menu.
Press the **EXIT** button to exit.

➤ The default is "Default".

CC1 : The Primary Synchronous Caption Service. These are captions in the primary language that must be in sync with the sound, preferably matched to a specific frame.

CC2 : The Special NonSynchronous Use Captions. This channel carries data that is intended to augment information carried in the program.

CC3 : Secondary Synchronous Caption Service. Alternate program-related caption data, typically second language captions.

CC4 : Special Non-Synchronous Use Captions. Similar to CC2.

Text1 : First Text Service. This may be various non-program related data.

Text2 : Second Text Service. Additional data, usually not program related.

Text3/Text4 : Third and Fourth Text Services. These data channels are used only if Text1 and Text2 data bandwidth is not sufficient.

➤ The Caption feature only works in TV, AV and S-Video mode.

➤ The availability of captions depends on the program being broadcast.

Viewing Closed Captions (On-Screen Text Messages) Digital

The Digital Captions function operates on digital channels.

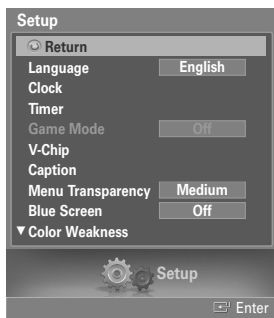

1 Press the **MENU** button. Press the ◀ or ▶ button to select “Setup”, then press the **ENTER** button.

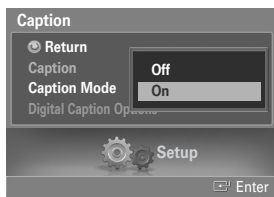

2 Press the ▲ or ▼ button to select “Caption”, then press the **ENTER** button.

3 Press the ▲ or ▼ button to select “Caption”, then press the **ENTER** button.
Press the ▲ or ▼ button to select “On”, then press the **ENTER** button.

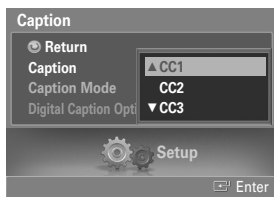

4 Press the ▲ or ▼ button to select “Caption Mode”, then press the **ENTER** button.
Press the ▲ or ▼ button to select submenu (Default, Service1~Service6, CC1 ~ CC4, or Text1 ~ Text4) you want, then press the **ENTER** button.

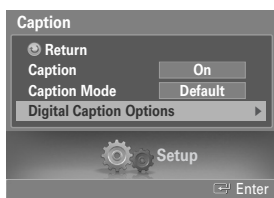

5 Press the ▲ or ▼ button to select “Digital Caption Options”, then press the **ENTER** button.

continued...

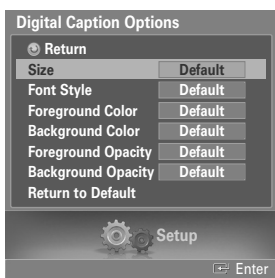

- 6 Press the ▲ or ▼ button to select “Size”, then press the **ENTER** button. Press the ▲ or ▼ button to select the desired item in the Size menu, then press the **ENTER** button. Set other listed options below using the same method as above. Select “Return” by pressing the ▲ or ▼ button, then press the **ENTER** button to return to the previous menu. Press the **EXIT** button to exit.

- The availability of captions depends on the program being broadcast.
- “Default” means to return to the original caption options set by the broadcaster.

Size

This option consists of “Default”, “Small”, “Standard”, and “Large”. The default is “Default”.

Font Style

This option consists of “Default”, “Style0 ~ Style 7”. You can change the font you want. The default is “Default”.

Foreground Color

This option consists of “Default”, “White”, “Black”, “Red”, “Green”, “Blue”, “Yellow”, “Magenta”, and “Cyan”. You can change the color of the letter. The default is “Default”.

Background Color

This option consists of “Default”, “White”, “Black”, “Red”, “Green”, “Blue”, “Yellow”, “Magenta”, and “Cyan”. You can change the background color of the caption. The default is “Default”.

Foreground Opacity

This option consists of “Default”, “Solid”, “Flashing”, “Translucent”, and “Transparent”. You can change the opacity of the letter. The default is “Default”.

Background Opacity

This option consists of “Default”, “Solid”, “Flashing”, “Translucent”, and “Transparent”. You can change the background opacity of the caption. The default is “Default”.

Return to Default

This option sets each of “Size”, “Font Style”, “Foreground Color”, “Background Color”, “Foreground Opacity”, and “Background Opacity” Color to its default.



Alternate method

Press the **CAPTION** button on the remote control repeatedly to select “On” or “Off”.

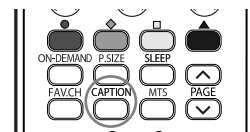

License Information

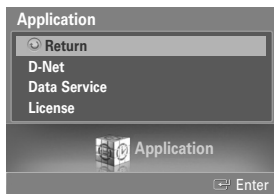

1 Press the **MENU** button.
Press the ◀ or ▶ button to select "Application", then press the **ENTER** button.

2 Press the ▲ or ▼ button to select "License", then press the **ENTER** button.

- It displays the information about the Software Platform License of the TV.
-

3 Press the **EXIT** button to close the License application.

Using the OCAP (OpenCable Application Platform) Data Service

Connecting CableCARD

You must obtain a CableCARD from a local cable service provider.

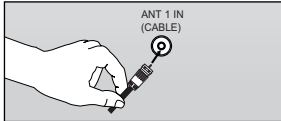

1. Plug the incoming cable into the ANT 1 IN (CABLE) terminal on the back of the TV.
 - The CableCARD recognizes input signals from ANT 1 IN (CABLE).

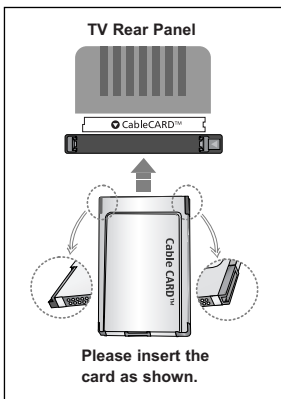

2. Insert the CableCARD into the "CableCARD" slot and the message "CableCARD™, Inserted" is displayed.

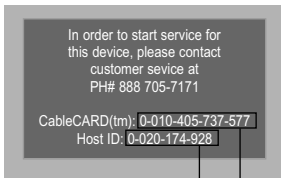

3. Within a few minutes after step 2, the message is displayed with a phone number to call for activating the CableCARD. This message contains the CableCARD ID and Host ID numbers of your TV, which records these numbers in preparation for activation.

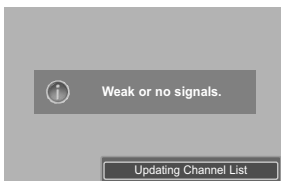

4. After activation, the cable provider will send activation messages to the CableCARD. During this operation, the message "Updating Channel List" is displayed. When the "Updating Channel List" process is completed, the message "Updating Completed" is displayed and your TV will switch to an active channel.

5. Within a few minutes after step 4, the message "Receiving Data Service Signal" is displayed and disappears.

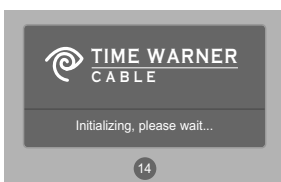

6. The TWC ODN loading screen is displayed. (Loading screen number start from 14 to 1.)

Using the CableCARD

This menu works with a CableCARD provided by a local cable service provider.

Prior to accessing this menu, a CableCARD should be connected to the rear panel of the TV.

For detailed connection instructions, refer to the “Connecting a CableCARD” section on page 78 of this manual.

Displaying CableCARD related information

To access information on Status, Pairing, Network Setup of the CableCARD provided by the service provider in CableCARD menu.



- 1 Press the **MENU** button. Press the ◀ or ▶ button to select “Setup”, then press the **ENTER** button.

- 2 Press the ▲ or ▼ button to select “CableCARD™”, then press the **ENTER** button.

Select “Return” by pressing the ▲ or ▼ button, then press the **ENTER** button to return to the previous menu.

Press the **EXIT** button to exit.

Using the CableCARD Setup Function

Sets up relevant CableCARD options.

CableCARD Reset

Resets CableCARD when the channels provided by CableCARD are not available.



- 1 Press the **MENU** button. Press the ◀ or ▶ button to select “Setup”, then press the **ENTER** button.

- 2 Press the ▲ or ▼ button to select “CableCARD Setup”, then press the **ENTER** button.

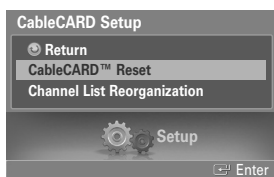

- 3 Press the ▲ or ▼ button to select “CableCARD™ Reset”, then press the **ENTER** button.

Channel List Reorganization

Deletes and reorganizes the channel list provided by CableCARD.

This feature should be used if you change or upgrade your CableCARD service.



1 Press the **MENU** button. Press the ◀ or ▶ button to select "Setup", then press the **ENTER** button.

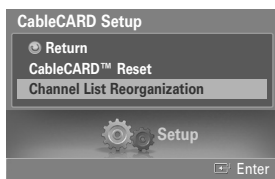

2 Press the ▲ or ▼ button to select "CableCARD Setup", then press the **ENTER** button.

3 Press the ▲ or ▼ button to select "Channel List Reorganization", then press the **ENTER** button.

Using the Data Service

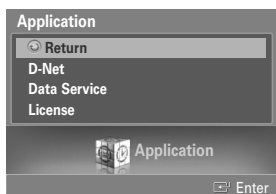

- 1 Press the **MENU** button.
Press the ◀ or ▶ button to select "Application", then press the **ENTER** button.

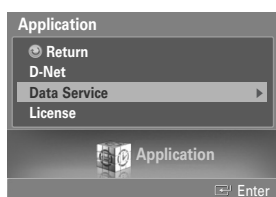

- 2 Press the ▲ or ▼ button to select "Data Service", then press the **ENTER** button.

- Executable Data Applications display in the Application List program.
- The **DATA-SERVICE** button on your remote control performs the same function as shown above.
- When the data service is set to "Off" in the Setup menu, the item cannot be selected because it is disabled.



- 3 Press the ▲ or ▼ button to select a Data Application to run.

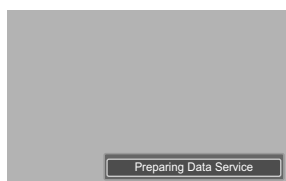

What's D-Net?

D-Net refers to a home network consisting of devices supporting D-Net (IEEE1394) connection (such as digital VCRs and Set-Top Boxes).

D-Net (IEEE1394) interface is capable of supporting various high-end digital A/V applications, such as A/V device control and signal routing, Digital Video (DV) editing, home networking.

How to connect compatible IEEE1394 Devices

Connecting compatible IEEE1394 devices is simple using this TV.

A secure digital interface is provided to other digital home entertainment units, such as a DTV, a Set-Top Box, an AV-HDD, a digital VCR, a MPEG Camcorder.

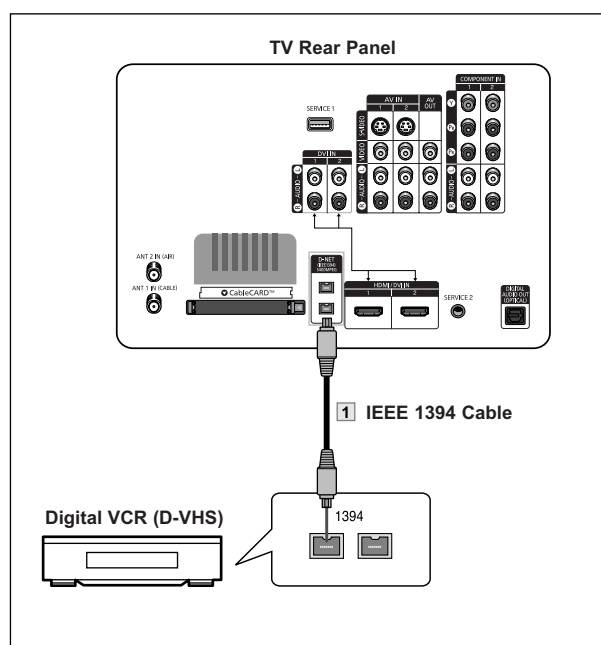

- 1 Connect the IEEE1394 Cable from the jack of the component with IEEE1394 capability, such as a Set-Top Box or a Digital VCR to the D-NET (IEEE1394) S400MPEG jack on the TV.
- 2 Press the **D-Net** button on the Remote Control.
- 3 Select the D-Net (IEEE1394) Compatible device.

- To access D-Net (IEEE1394) in the menu, see page 87.
- The IEEE1394 interface is equipped with a copy protection standard called Digital Transmission Content Protection (DTCP).
- The name of 1394 Jack on the external device may be different according to the manufacturer (i.e., DTV LINK or i.LINK).
- The supported video format is MPEG-2 Digital video. Other digital video formats (e.g. DV format...) are not supported. For audio, Dolby Digital and MPEG Digital Audio are supported, other digital audio formats (e.g. MP3, DTS) are not supported.
- Because IEEE1394 is an evolving technology, it is possible that some or all of the features of a device you connect to the TV through the IEEE1394 port may not operate.
- There may be a single IEEE1394 jack depending on the specifications of the external device.

When Connecting D-Net (IEEE1394) Compatible devices

The last device in the chain should not be looped back to the TV as the TV may not be able to work with the other devices.

To connect two or more D-Net (IEEE1394) Compatible devices, follow the diagram below.

A maximum 10 D-Net (IEEE1394) Compatible devices can be connected.

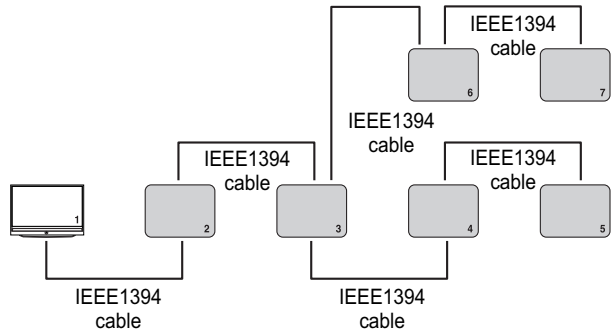
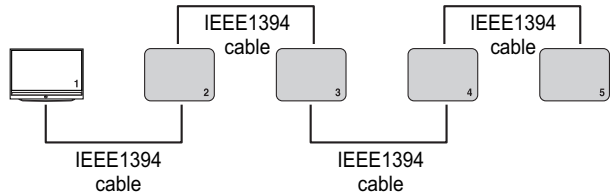

Do not connect D-Net (IEEE1394) Compatible devices in a way that creates a loop.

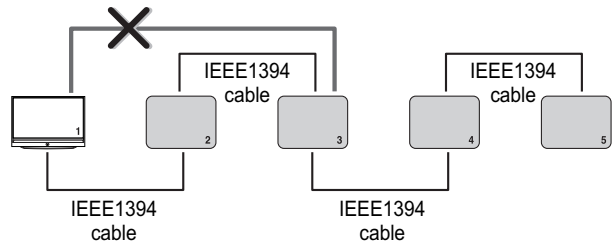

➤ IEEE1394 cables longer than 14.76 feet (177.16 inches) should not be used between devices.

Connection Options

There are two different connection options for connecting D-Net (IEEE1394) compatible devices. Select the most suitable option according to your network of audio/video products.

The Direct Device-To-Device Option

D-Net (IEEE1394) permits the chaining of devices, unlike analog audio and video connections where each device needs to be individually connected to the TV. This allows you to connect your D-VHS to your 1394 Set-Top Box only, then connect the Set-Top Box to the TV. More IEEE1394 devices can be added to the chain as needed. Each video device can be viewed on the TV's D-Net and information can be sent from any IEEE1394 device to other compatible devices.

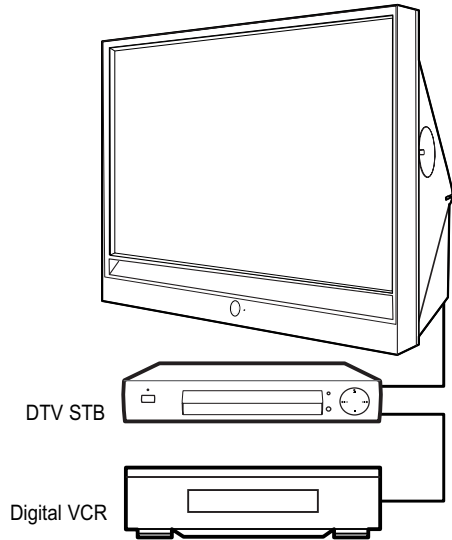

The Hub Connection Option

D-Net (IEEE1394) also permits connecting devices using the TV as a hub. Each device is capable of sending information, which may include audio and video, to any other device on the network.

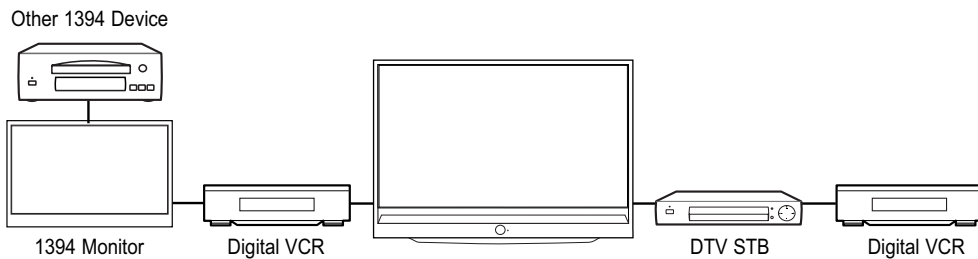

4-Pin and 6-Pin Connectors

Two different types of connectors are used for IEEE1394 terminals and cables, a 4-pin and a 6-pin.

The 4-pin connector sends digital audio, digital video and digital control signals to and from devices. The TV has two available 4-pin connection jacks, of which two are at the back.

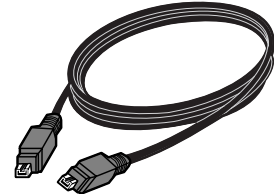

The 6-pin connector also sends digital audio, video and control signals, but in addition, sends low voltage electrical power. There are no 6 pin connectors on this TV.

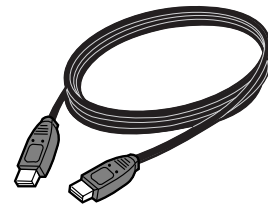

It is not possible to directly connect a 6-pin connector to a 4-pin jack, and vice versa. In order to connect a 6-pin device to a 4-pin device, an adaptor or adaptor cable is required, easily purchased from an electronics or computer store.

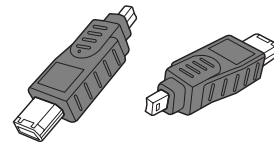

Connecting a 6-pin device (such as a camcorder) via an adaptor to the TV, (if it is designed to receive electrical power from another 6-pin device) will require that the camcorder be directly connected to the AC supply, or that the camcorder's battery power be used.

Selecting a D-Net device

Prior to viewing an IEEE1394 device, it first needs to be selected in the D-Net Device List.

- 1 Connect the relevant D-Net (IEEE1394) Compatible device in the list.
(See "How to connect compatible IEEE1394 Devices" on page 82)



- 2 Press the **D-Net** button on the remote control.
 - The TV and all other devices connected on the D-Net (IEEE1394) chain appear in the D-Net device list.
 - If "UNKNOWN" is listed in the device list, the device is not supported by the TV, and cannot be controlled with the TV remote control or the D-Net control panel on the screen.

- The device list is in the order of DTV, STB, AV-HDD, D-VHS, Camcorder and UNKNOWN.
If there are multiple devices of the same type, the devices will be listed in ascending order of the manufacturer name with Samsung first as the exception. If there are multiple devices of the same type and they are manufactured by the same company, they will be listed in the order of their serial number.

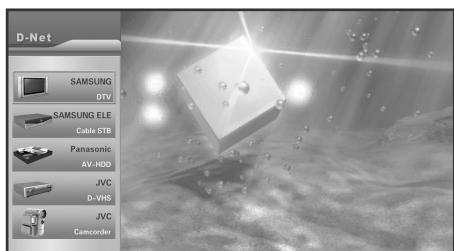

- 3 Select a connected D-Net device by pressing the **▲** or **▼** button.
 - It is possible to connect a D-Net device to another device and to the TV while the TV is ON.
The D-Net device list automatically adds the newly-connected device to the list.
See "How to connect compatible IEEE1394 Devices", page 82 for connecting D-Net (IEEE1394) Compatible devices.



- 4 To select a device, press the **ENTER** or **▶** button.
Then display the D-Net device control panel and operate the selected device.
 - At this time, the screen changes to the picture from the selected device.

The Direct Device-To-Device Option

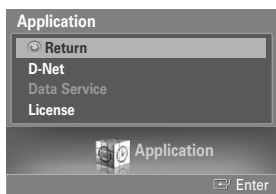

1 Press the **MENU** button.
Press the ◀ or ▶ button to select "Application", then press the **ENTER** button.

2 Press the ▲ or ▼ button to select "D-Net", then press the **ENTER** button.

- The TV and all other devices, connected on the D-Net (IEEE1394) chain, appear in the D-Net device list.
 - This is also available using the **D-NET** button on the remote control.
-

3 Press the ▲ or ▼ button to select a D-Net (IEEE1394) connected device.

The D-Net control panel

Select an IEEE1394 device from the D-Net device list. The TV will then display the D-Net control panel. This panel allows you to use the TV remote control to control the selected IEEE1394 device.

- 1 Press the **D-Net** button on the remote control.

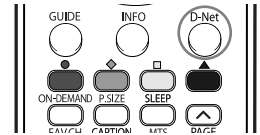

- 2 Press the **▲** or **▼** button to select a D-Net (IEEE1394) connected device. Press the **ENTER** or **▶** button.
 - The D-Net control panel appears on the bottom of the screen.

- 3 Use the **◀** or **▶** button on the remote control to move through the options (see next page) available in the D-Net control panel.

- 4 Press the **ENTER** to select an option.













- 5 To view the IEEE1394 device in **FULL SCREEN**, press the **EXIT** button or **D-Net** button on the remote control.
 - Press the **D-Net** button once to display the D-Net menu. Press the **D-Net** button again to hide the menu.

➤ For information about how to use the icons, refer to the following page.

➤ What is D-Net Mode?

D-Net Mode refers to selecting a device from the D-Net device list except for DTV itself (it also refers to selecting another DTV connected with an IEEE 1394 cable.) In this mode, the DTV displays video from the connected device. Although the D-Net OSD has disappeared, and video is playing from another device and not from the DTV, the DTV is in D-Net Mode.

Control Panel ()

Button	Name	To do this
	Return	Move to the D-Net device list.
	Target	Shows a list of recording devices.
	File List	Display the AV-HDD file list.
	Play	Play the digital stream from the selected digital device.
	Stop	Stop the digital stream from the selected digital device.
	Rewind	Fast rewind a digital stream from the selected digital device.
	Forward	Fast forward a digital stream from the selected digital device.
	Device menu	Display the EIA-775 OSD received from the EIA-775 standard support among 1394 devices connected. Display only in the control panel of the devices which support EIA-775 menu,
	Power	Turn the Power of the selected device ON/OFF.
	Go to recording position	When in time shift mode on AV-HDD, this moves to the recording position.
	Recording	Run the camcorder's Record function. Record video by capturing pictures displayed through the camcorder viewfinder and saving them to the built-in storage of the camcorder.
	Pause	Pause Play.
	Recording stop	Stop a recording. This only appears when it is in AV-HDD Time-Shift Mode.

- Press the ◀ or ▶ button on the remote control to select a control panel button and press the **ENTER**  button on the remote control.
 - Depending on the device being controlled, not all options on the D-Net control panel may be available.
 - Not all functions are supported for all IEEE1394 devices.
 - It is possible to use direct buttons on the remote control (rewind, stop, play/pause, fast forward) to control external devices.
 - * **What is EIA-775?** : EIA-775 is an OSD standard that enables the control of external 1394 devices using functions such as Play, Stop, etc.
 - * **What is CEA-931?** : This is a standard for controlling external IEEE1394 devices with the TV remote control and not the remote control of the external device.
- For example, to play D-VHS, you press the Play button of the TV instead of the Play button of the D-VHS, the Play command is transmitted to the DVHA through the IEEE1394 connection.
- * **What is Time-Shift Mode?** : This refers to a function that plays the file currently being recorded on the selected AV-HDD. At this time, the recording time appears at the top right of the screen and the playing time is displayed at the bottom left of the screen. For example: If you are currently 45 minutes into a one hour recording, you can backtrack and view the first 45 minutes without affecting the recording. In the Time-Shift Control Panel, the Move to Recording Position and Recording stop buttons are added to the basic AV-HDD Control Panel.

Control Panel Images for Each Device

The Control Panel is different depending on the device.
For example, for an AV-HDD, the Control Panel buttons for Play and Recording are different.

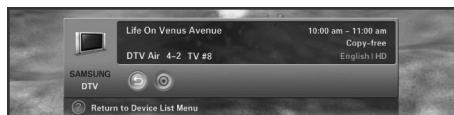

DTV Control Panel Image

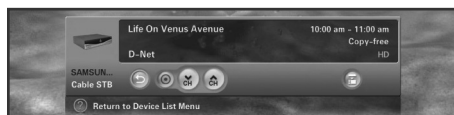

Cable STB Control Panel Image



AV-HDD Control Panel Image

When the Power is off.



AV-HDD Control Panel Image

When the Power changes.



AV-HDD Control Panel Image

When Playing.

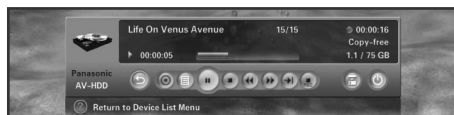

AV-HDD Control Panel Image

When Recording.



Camcorder Control Panel Image

When in CAMERA Mode.



Camcorder Control Panel Image

When recording in CAMERA Mode.



Camcorder Control Panel Image

When in VCR Mode.



Camcorder Control Panel Image

When playing in VCR Mode.

Operating Tips

- 1) When the screen is switched to the TV program.
 - When you select the first button, the DTV button, in the Device List, it switches to the TV program.
 - Although you have selected another device from the Device List, if detecting a video signal from the device fails, the "Connection failed" message appears and the screen automatically switches to the TV program.
 - When the 1394 connection to the selected device is disconnected, the screen automatically switches to the TV program. If you reconnect the device, the reconnected device is automatically selected.
- 2) When connected to a AV-HDD
 - When a AV-HDD disc is rotating, there may be a time delay.
 - Some AV-HDDs may provide two playbacks or recordings simultaneously. In this case, there may be two Play icons in the File List and 2 AV-HDD buttons in the Target List.
 - If you copy a file from the File List, the selected AV-HDD file is played on the TV screen and recorded using the device selected from the Target List.
 - If the file reaches its end, the recording device will stop automatically.
 - Some AV-HDDs may display the wrong file information after recording, depending on the situation.
 - If AV-HDD is recording, the file is automatically played which is currently being recorded, when it is selected from the Device List. (PVR function - Refer to What is Time-Shift Mode? on page 89)
 - For the "Go to recording position" button operation, the recording and playing time are displayed and the difference between them must be longer than 30 seconds.
- 3) When connected to D-VHS
 - Some devices support an automatic connect function (I-mode). These devices may cause a malfunction when multiple devices are connected.
 - Some D-VHS devices may not record properly when multiple devices are connected and the mode is I-mode.
 - When selecting a D-VHS being used for a recording from the device list, you can only switch to D-VHS screen mode after the recording is stopped.
- 4) When connected to a camcorder
 - Depending on if the camcorder is in Tape or Camera Mode, the control panel changes.
 - If the camcorder turns off the power (power saving mode), the camcorder may disappear from the Device List.
- 5) AV-HDD, D-VHS and camcorders automatically stop when you select another device.
- 6) Some devices may be displayed in the Device List as 'UNKNOWN'.
 - This may happen when the device does not contain the proper information or it cannot be read.
- 7) Some devices may not be recognized and may be disconnected from the 1394 connection when they are turned off.
- 8) Through D-Net, you can connect another IEEE1394 compatible TV. If the TV is connected, the TV is listed in the D-Net Devices. At this point, the screen that appears when the TV is selected is determined by the specifications of the connected TV. That is, the screen of the connected TV or another connected IEEE1394 device may be displayed.
- * **What is Digital TS ?** : DTV packages digital data (video, audio and data) into 188 byte units using the MPEG-2 algorithm and transmits the data unit. It is called Digital Transport Stream or Digital TS.
 - When a SAMSUNG DTV which supports D-Net is connected to each other, it only transmits Radio Frequency (RF) of the selected DTV.
- 9) When connecting more than one STB, some STBs may not be displayed in the Device List due to STB specifications or defects when multiple devices are connected.
 - Even if the device is displayed in the Device List, the connection may fail.
 - STB problems may also stop the video stream while recording, or the recording may fail.
 - In this case, you have to discover which device is defective by removing them one by one.

- 10) When multiple devices are connected, some devices may appear and then disappear periodically in the Device List. Because some devices malfunction when multiple devices are connected.

If this occurs, you have to discover and remove the defective device from the connection by removing the devices one by one.

- 11) When multiple devices are connected, the response time may be relatively long when selecting a device. This may happen when there is a device that malfunctions and degrades the 1394 connection speed. At this time, some of the functions of AV-HDD or D-VHS may not work, and the stream connection may fail. If this occurs, you have to discover and remove the defective device from the connection by removing the devices one by one.
- 12) When AV-HDD or D-VHS is being played, and you press the Pause button, some products may show the "Weak or no signals" message on the TV screen instead of a still picture as there is no video stream from the product.
- 13) If the number of connected IEEE 1394 devices exceeds 10, it may cause abnormal operation.
 -Yes and Play may not operate smoothly, if you play after recording.
 -Yes and the Play, Record and Copy functions do not work properly.
 -Disconnect the malfunctioning device and then try again.

14) Copy Protection

- You can record a Copy-free, or Copy-one-generation screen.
- Although you cannot record a No-more-copies, or Copy-never screen, you can view it through another device.
- If you change the channel to a 'Copy-never' channel while recording a 'Copy-free' channel, the recording is automatically stopped in some devices. Even if the program was recorded, you will not be able to view the recorded 'Copy-never' channel. At this time, therefore, the user has to manually stop the recording.

Copy information

Message	Descriptions
Copy-free	Able to copy.
No-more-copies	Unable to copy anymore.
Copy-one-generation	Able to copy once.
Copy-never	Unable to copy.

- 15) When multiple devices are connected, and a device malfunctions while playing D-VHS or AV-HDD, the user may experience interrupted screen play.
- 16) When playing and recording a file simultaneously using AV-HDD and the file is copy protected, the file may not play depending on whether the AV-HDD device supports simultaneous copy protection.

Recording Tips

- 1 Recording using the Target List while also watching the screen being recorded.
 - Check that the AV-HDD and D-VHS devices are connected.
 - Select a source device to be recorded and press the Target button in the menu.
(Target button : The Target button is used for making a recording. When pressing this button, a menu appears where you can select a device that will be used to make a recording of the current screen of the current device. At this point, the menu shows only D-VHS and AV-HDD which are recordable among D-Net devices.)
 - Select a device to be recorded from the Target List.



- 2 Recording a file in the File List of AV-HDD using another device.
 - Select an AV-HDD file to be recorded from the File List and press Target.
 - A source device appears on the left, and the recording device list appears on the right.
 - In this case, the selected file is automatically played and displayed on the TV screen and the target device automatically starts recording.
 - Controlling a device with another device's remote control or through manual operation, may cause a malfunction when controlling a device through the TV. When copying a file, the recording will stop automatically when the file reaches its end.
 - Although you can make a recording to connected devices regardless of copy protection, you may not be able to watch the copy-protected recording as the playback picture may be distorted.
 - When recording an HD program on cable TV or from satellite, programs on some channels may not be recorded if the program exceeds the limit of the allowable range of recording devices such as D-VHS.
 - If a recording is in process and another command is issued while the "Recording..." D-Net Notice is displayed on the screen, the recording may fail.
- 3 Press the ▲ or ▼ button to move to a recording device and press the **ENTER** or ► button to start recording.
 - When selecting a stopped device, a recording is started. When selecting a recording or playing device, you will be prompted to stop that device.
- 4 Press the ◀ button or move to "Previous Menu" at the top and press the **ENTER** or ► button to hide the recording device list and to return to the Control Panel.

Tips on stopping recording



- 1 In general, you can instantly evaluate the current recording device through the Target List. If you select a device that you wish to stop, a message appears asking if you really want to stop recording.

- 2 For D-VHS. If you select a recording D-VHS from the Device List, a message appears asking if you really want to stop recording. When the "OK" button is selected, the recording is stopped and the D-VHS screen appears. When the "Cancel" button is selected, the recording continues and the D-Net device list appears.

- 3 For AV-HDD, if the file currently being recorded is selected, you can stop the recording using the Recording stop button. After the recording is stopped, the Control panel for Normal Mode appears.

File List

- 1 Press the **D-Net** button on the remote control.

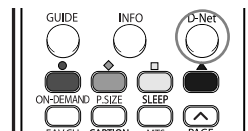

- 2 From the device list, move to AV-HDD by pressing the **▲** or **▼** button and then press the **ENTER** or **▶** button.

- 3 Press the **◀** or **▶** button to move to the File List button and then press the **ENTER** or **▶** button.
The Control Panel disappears and the file list appears which allows you to identify a current recording or playing device. However, when playing a file that is currently being recorded in Time-Shift Mode, only the Record icon appears.

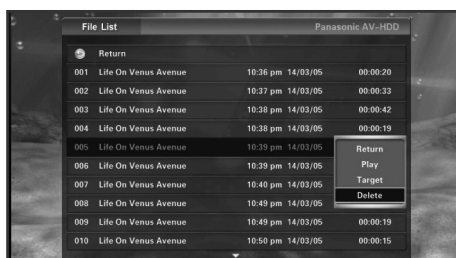

- 4 Press the **▲** or **▼** button to move to a file and then press the **ENTER** or **▶** button.
The sub-menu appears allowing you to play, copy or delete as shown in the figure.
Press the **▲** or **▼** button to move to a menu and then press the **ENTER** or **▶** button.

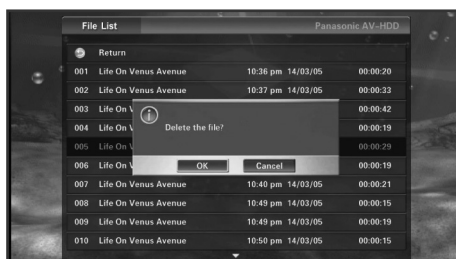

- 5 When selecting Play, and the file is played, the file list disappears and the Control Panel appears.
When selecting Copy, the file list disappears and the recording device list appears allowing you to record.
When selecting Delete, a deletion confirmation message appears. When selecting OK, the selected file is deleted. However, you cannot delete a file currently being played or recorded.

6 To move to the list on the next page, move the cursor to the file at the bottom and press the ▼ button; to move to the previous page, move the cursor to the Previous Menu and press the ▲ button. When pressing the ▲ button while the first file on the first page is selected, the cursor moves to the last file on the last page. When pressing the ▼ button while the last file on the last page is selected, the cursor moves to the first file on the first page. To move to the previous page, press the CH ▲ button. To move to the next page, press the CH ▼ button.

7 To return to the file list from the sub-menu, press the ◀ button or press the ENTER or ▶ button in "Previous Menu". To return to the Control Panel from the file list, press the ◀ button or press the ENTER or ▶ button in "Previous Menu".

8 However, if no sub-menu appears when selecting a file that is currently being played from the list, delete the file list and move to the Control Panel. (At this time, a file that is currently being played cannot be deleted. To record, use the recording device list button of the Control Panel.) When selecting a file that is currently being recorded from the list, only the Play sub-menu is activated. (You cannot copy or delete a file being recorded.)

Troubleshooting (D-Net)

Problem	Possible Solution
The device is displayed as being "UNKNOWN".	<p>Only DTVs, STBs, AV-HDDs, D-VHSs and MPEG camcorder IEEE 1394 devices are controllable.</p> <p>Other devices will display "UNKNOWN" in the device list.</p> <p>Some supported devices may display as "UNKNOWN" due to an initialization error.</p> <p>→ If a device is supported but is displayed as "UNKNOWN", reconnect the 1394 cable.</p> <p>If this does not work, because the information about the device is unreadable due to an internal error.</p>
A connected device is not displayed in the device list.	<p>A device, which has experienced an error during initialization, may malfunction and affect the operation of other connected devices. Other devices may not be displayed in the list.</p> <p>→ Disconnect and reconnect the 1394 cable.</p> <p>→ Remove a device which does not guarantee compatibility when multiple devices are connected.</p> <p>→ The repeater and hub are not displayed in the device list.</p>
"Check the connection with IEEE 1394 cable." message appears.	<p>This message appears when there is a problem with the connected device or the 1394 cable.</p> <p>Initialization might fail when multiple devices are connected due to limitations of some connected devices.</p> <p>→ Check that the 1394 cable is making a loop and reconnect the 1394 cable.</p> <p>Check that cables are correctly connected to all connected devices.</p> <p>This message may appear due to an operating error of the 1394 port of a particular device.</p>
"Connection is failed. Exceeds the limit of 1394 network connection." message appears.	<p>IEEE 1394 supports a limited number of screen connections. This message appears when the limit has been exceeded.</p> <p>→ Stop unnecessary operations such as playing, recording, etc. and try it again.</p> <p>Turn the auto screen connection function (I-mode) of D-VHS devices OFF, and retry.</p> <p>If a camcorder is connected and it is not currently being used, turn it off or disconnect it from the 1394 network.</p>

Problem

"Connection is failed.
1394 network speed is not compatible."
message appears.

Possible Solution

This message appears when the connection speed of the connected device and the device selected from the Target List are different when copying data.

→ Connect a low speed device between the two devices.
(See figure)

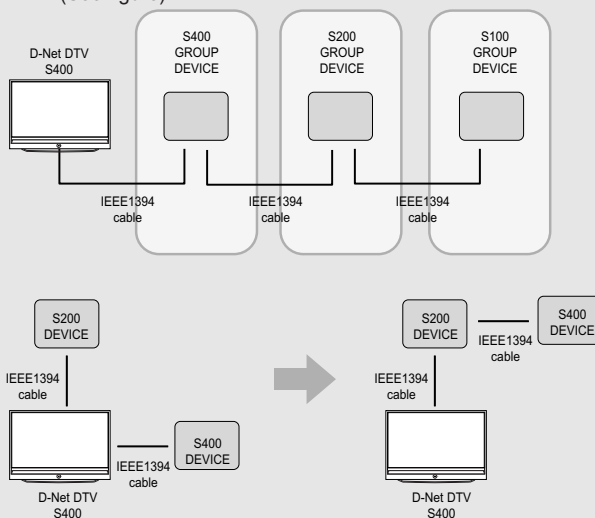

* A 1394 device has a maximum connection speed which will be marked near the IEEE 1394 connector with an "S" number (i.e., S100,S200,S400). The higher the number, the faster the maximum connection speed.

This TV has a maximum connection speed of S400.

"This device is occupied by another device." message appears.

This message appears when you try to record a device, which is currently being recorded manually or by another device, through the TV.

→ Stop the recording device and retry.

"Authentication is failed" message appears.

Check that the connected device supports DTCP.

"Recording is prohibited." message appears.

This message appears when trying to copy protected content. This message appears when trying to copy No-more-copies or Copy-never content.

Although DV Camcorder is in the device list, no picture is displayed on the screen when the DV camcorder is selected.

Although a camcorder which supports the DV format appears in the device list, you cannot watch video from the camcorder even if you select the camcorder as an input source, because the TV supports the MPEG format only.

Problem	Possible Solution
No picture on the screen after selecting a device	Check if the current mode for DTV and STB is set to analog by mistake. For AV-HDD, check if the played content has reached the end. (Select the item from the content list again.) For D-VHS, check if a D-VHS tape is being used. If the camcorder supports the DV format, no picture will be displayed on the screen.
"Initializing D-Net" message appears.	This message appears when the D-Net function is being initialized. Retry after a short wait to use the D-Net function.
"Exceeds the limit of device numbers." message appears.	This message appears when the number of currently connected D-Net devices exceeds 10. Retry after disconnecting unnecessary devices.
"Recordable device is not connected" message appears.	This message appears when the recordable device is not on the network when you try to make a recording using a D-Net device. Retry after connecting a recordable device (D-VHS, AV-HDD).
"Not available while recording" message appears	The message appears informing you that you cannot change the channels or change the input source using the remote control because a recording is in progress through D-Net. Retry after stopping the current recording through D-Net.
"The connected device is unavailable to perform this function for temporary problems." message appears.	This message appears when the selected function is not supported by the relevant device or the relevant device cannot execute the selected function. Most STBs, DTVs and camcorders do not support the power on/off command. This message may appear when you issue the power command for these devices. This message also appears when the command is supported but the relevant device cannot follow the command. Retry after checking the current mode of the relevant device.
D-Net cannot record video from analog channels from connected external equipment.	This message appears when the user presses the RECORD button in analog mode. D-Net only supports recording for digital.
"Not available format is selected." message appears.	This message appears when the selected device does not support the MPEG format. At present, D-Net supports MPEG TS only.
"D-Net cannot record the picture of analog channels or peripheral equipments for the input source, except TV." message appears.	This message appears when trying to record analog video or video from a device connected to the External IN port. D-Net transmits Digital TS only.
"The Disc is Empty." message appears.	This message appears when trying to record the contents of AV-HDD using another device when there is no content saved on the AV-HDD. Before make a recording from an AV-HDD to another device, first check if there is any saved content on the AV-HDD.

Problem	Possible Solution
This device is unavailable for D-Net.	This message appears if you have connected a 1394 device or equipment other than a supported device (D-VHS, DTV, STB, AV-HDD, Camcorder), or if the connected device does not support the AVC defined in the 1394 specifications, even if the device is a supported device, when you have selected the device to use it.
Connection failed. Check if the 1394 cable is connected.	This message appears if there is a connection problem when trying to use a D-Net device.
Initializing...	This message appears if the AV-HDD is booting when trying to use the AV-HDD.
Please wait. A recordable device is on standby.	This message appears if the recording device is turned off when trying to record using the D-Net device. Please wait a moment until it is turned on.
Connection failed. The device is not responding.	This message appears if there is a connection problem when trying to use a D-Net device. This message appears when the response of the component device malfunctions or is incorrect.
No space left on disc.	This message appears if the AV-HDD has no space to record.
The D-NET ERROR message appears on the screen.	Although you have connected external devices according to the procedures described in the manual to use the D-Net function, the D-NET ERROR message may appear on the screen. In this case, check to see if the jacks are damaged.

Replacing the Lamp

- **Why do I need to replace the lamp?**

The lamp used in a DLP TV has a limited lifespan. For the best screen quality it needs to be replaced periodically. After replacing the lamp, the screen quality will be bright and clear as new.

- **When do I need to replace it?**

It should be replaced when the screen becomes darker, less clear or when all three LEDs on the front (Stand by/temp, Timer, and Lamp) are flashing.

- **Check before lamp replacement**

1. The lamp must be the same code number and type.
2. The lamp type is indicated on the back of the TV. It is also indicated on the lamp case.
3. After checking the code number for the lamp, give the code number to the store where you purchased the TV or to a Samsung Service center.

- **Caution**

1. Replace with the correct code numbered lamp to avoid damage to the TV.
2. Turn the power off and wait for 30 minutes before replacing the lamp as it will be hot.
3. Do not touch the glass part of the lamp with your bare hands and do not insert any foreign object inside the cover as it may cause poor screen quality, electric shock or fire.
4. Do not place the old lamp near flammable objects or within the reach of children.
5. Be sure to connect this TV directly to an AC wall outlet. If the TV's AC plug is connected to a cable box or other source, it will not allow for proper cool down time.

- For replacement, you will need a 5.91-Inch screwdriver and a pair of gloves.



1 Unplug TV, then use a screwdriver to remove the screws.



2 Remove the Lamp cover.

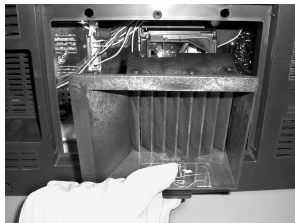

3 Remove the Lamp cover duct holding the tab and pulling it out.

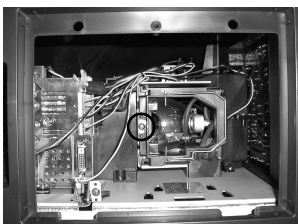

4 Remove the screw securing the Lamp by using a screwdriver.

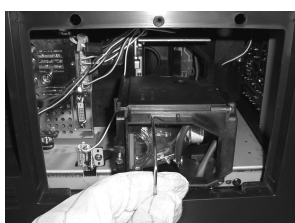
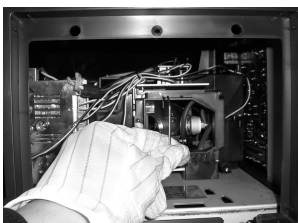

5 Separate the Lamp from the engine by holding the handle and pulling it out.

- Be sure the replacement Lamp is the same type.
- After replacing the lamp, align the lamp cover with the groove and secure the screws.
- The TV will not turn on if the lamp cover is not correctly closed (as this will activate the protective circuit).

Identifying Problems

If the TV seems to have a problem, first try this list of possible problems and solutions.
If none of these troubleshooting tips apply, call your nearest Samsung service center.

Problem	Possible Solution
Poor picture quality.	Try another channel. Adjust the antenna. Check all wire connections.
Poor sound quality.	Try another channel. Adjust the antenna.
No picture or sound.	Try another channel. Press the SOURCE button. Make sure the TV is plugged in. Check the antenna connections. Check that the Mute feature is off.
No color, wrong color or tint.	Make sure the program is broadcast in color. Adjust the picture settings.
Picture rolls vertically.	Adjust the antenna. Check all connections. If you are using a VCR, check the tracking.
The TV operates erratically.	Unplug the TV for 30 seconds, then try operating it again.
Your remote control does not operate your TV.	Press the TV button to put your remote control into TV mode. Make sure the remote has batteries.
The TV won't switch on.	Make sure the wall outlet is working. Make sure the TV is plugged in. Make sure the remote has batteries.
Digital broadcasting screen problem.	Please check the digital signal strength and input antenna.
The visual qualities of digital channels vary.	The visual qualities of digital channels may vary depending on the original production method (analog or digital). → If the original production method is digital: High visual quality program. → If the original production method is analog: The digital program displayed on the screen is originally an analog program which has been converted. The visual quality is of an SD grade.
Although the TV caption shows HD, the visual quality is not satisfactory.	The HD caption that appears when switching channels or when pressing the Information button on the remote control means the selected channel is simply a digital channel. If the broadcasting station converts an analog signal into digital and transmits the signal, the visual quality may not be perfect.

- The display panel used for the DLP TV is composed of many tiny pixels.
These pixels may occasionally appear on the screen.

Cleaning and Maintaining Your TV

Please follow these guidelines to get the maximum performance from your TV.

Placement

- Do not put the TV near extremely hot, cold, humid or dusty places.
- Do not place the TV near appliances with electric motors that create magnetic fields, such as vacuum cleaners.
- Keep the ventilation openings clear; do not place the TV on a soft surface, such as cloth or paper.
- Place the TV in a vertical position only.

Liquids

- Do not handle liquids near or on the TV. Liquids that spill into it can cause serious damage.

Cabinet

- Never open the cabinet or touch the parts inside.
- Wipe your TV with a clean and dry cloth. Never use water, cleaning fluids, wax, or chemicals.
- Do not put heavy objects on top of the cabinet.
- This DLP TV projects the image onto a large screen by applying an optical system. If you place the TV set face down, it might cause a problem because dirt, or some other contaminant may become attached to the inside of the TV set.

Temperature

- If your TV is suddenly moved from a cold to a warm place, unplug the power cord, and allow at least two hours for moisture that may have formed inside the unit to dry completely.

Using Your TV in Another Country

If you plan to take your TV with you to a foreign country, please be aware of the different television systems that are in use around the world. A TV designed for one system may not work properly with another system due to differences in the TV channel frequencies.

Specifications

Model Name	HL-S5686C	
Dimensions (WxDxH)	50.87 x 16.34 x 35.67 inches 1292 x 415 x 906 mm	
Weight	33.3 Kg / 73.41 lbs	
TV System	TBD American TV Standard ATSC compliant 8VSB	
Channel	Terrestrial (analog) Terrestrial (digital) Cable (analog)	2-69 p2-69 1-135
Component Video IN	2 (Y Pb Pr)	480i, 480p, 720p, 1080i, 1080p
HDMI IN	2 total	Video : 480i,480p,720p,1080i,1080p (EIA/CEA-861-B compliant) Audio : Two channel linear PCM 32, 44.1 and 48kHz
Speaker Output	10W(L), 10W(R)	
Voltage	AC110-120V	
Frequency of Operation	60Hz	
Power Consumption	230W In Use, Less than 1W In Standby	

➤ Design and specifications are subject to change without prior notice.

***This page is intentionally
left blank.***

***This page is intentionally
left blank.***