

myprojectorlamps.com

**The most trusted, dependable name
in projector lamp sales.**



<http://www.myprojectorlamps.com>



<http://www.myprojectorlamps.ca>



<http://www.myprojectorlamps.eu>

The following projector manual has not been modified or altered in any way.

SAMSUNG

SAMSUNG

DLP TV

Owner's Instructions

HL-S5087W

HL-S5687W

HL-S6187W



Register your product at www.samsung.com/global/register

A Guide to Digital TV

- **What is Digital Television?**

Digital television (DTV) is a new way of transmitting high quality video and audio to your TV set. Using DTV, broadcasters can transmit high definition TV (HDTV) images, Dolby digital surround audio, and new services such as multicasting (transmitting more than one program on the same TV channel) and datacasting. Several of these services can be combined into a single digital broadcast.

Digital Television Services

- **Digital Picture Quality**

DTV programs are transmitted in two different formats. The first is Standard Definition Television (SDTV) and the second is High Definition Television (HDTV).

- **SDTV** program formats include 480-line interlaced (480i) and 480-line progressive (480p) video. 480i programs are essentially a digital version of our current analog TV programs, while the 480p format offers improved image detail over 480i. Some 480p programs are broadcast in widescreen and are comparable to progressive-scan DVD movies in image quality.

- **HDTV** program formats include 1080-line interlaced (1080i) and 720-line progressive (720p). Both HDTV formats are always broadcast in widescreen, and offer much higher picture quality than SDTV.

- **Dolby Surround Sound**

With DTV, you can listen to a variety of Dolby digital audio formats from Dolby Surround 2.0 to Dolby Digital 5.1 surround, using your home audio system. Many HDTV programs are now broadcast with DD 5.1 soundtracks.

U.S.A Only

The product unit accompanying this user manual is licensed under certain intellectual property rights of certain third parties. In particular, this product is licensed under the following US patents: 5,991,715, 5,740,317, 4,972,484, 5,214,678, 5,323,396, 5,539,829, 5,606,618, 5,530,655, 5,777,992, 6,289,308, 5,610,985, 5,481,643, 5,544,247, 5,960,037, 6,023,490, 5,878,080, and under US Published Patent Application No. 2001-44713-A1.

This license is limited to private non-commercial use by end-user consumers for licensed contents. No rights are granted for commercial use. The license does not cover any product unit other than this product unit and the license does not extend to any unlicensed product unit or process conforming to ISO/IEC 11172-3 or ISO/IEC 13818-3 used or sold in combination with this product unit. The license only covers the use of this product unit to encode and/or decode audio files conforming to the ISO/IEC 11172-3 or ISO/IEC 13818-3. No rights are granted under this license for product features or functions that do not conform to the ISO/IEC 11172-3 or ISO/IEC 13818-3.

Other countries

The product unit accompanying this user manual is licensed under certain intellectual property rights of certain third parties. This license is limited to private non-commercial use by end-user consumers for licensed contents. No rights are granted for commercial use. The license does not cover any product unit other than this product unit and the license does not extend to any unlicensed product unit or process conforming to ISO/IEC 11172-3 or ISO/IEC 13818-3 used or sold in combination with this product unit. The license only covers the use of this product unit to encode and/or decode audio files conforming to the ISO/IEC 11172-3 or ISO/IEC 13818-3. No rights are granted under this license for product features or functions that do not conform to the ISO/IEC 11172-3 or ISO/IEC 13818-3.

Q&A

1. Is the antenna I use for existing TV reception good enough for DTV?

Over-the-air (OTA) digital TV broadcasting uses the same channels as analog TV and works well with many existing TV antennas. However, DTV broadcast channel assignments are different than analog channels. You should find out whether your local DTV broadcasts are on VHF (channels 2-13) or UHF (channels 14-69) to see if you need a different antenna.

If your DTV channels are on UHF and you already get good UHF reception, your present antenna may work fine. The same holds true for VHF DTV reception. Note that in some markets, both VHF and UHF channels are used for DTV broadcasts.

You can find out the latest DTV channel assignments for your area by browsing selected Internet web sites such as www.titantv.com, www.10000watts.com, and www.fcc.gov.

2. How difficult is it to receive DTV signals indoors?

This depends on whether your local DTV stations are running full power or not and how close your location is to the transmission tower. DTV receivers do not require as much signal as analog TV receivers to produce high-quality images and sound.

Once the DTV signal level exceeds a certain threshold at the receiver, the digital video and audio data is decoded at the same quality it was originally encoded for broadcast.

This is a big advantage for DTV over analog TV - there is no noise, ghosting, static, or scratchy audio.

3. How can I connect an antenna in my townhouse, co-operative apartment, condominium, or apartment?

The Federal Communications Commission's OTARD Rule (part of the Telecommunications Act of 1996) allows residents of condominiums, townhouse, or members of neighborhood associations to put up outside antennas for reception of broadcast TV signals as long as those antennas are not located in common areas and are no more than 12' in height.

Residents of rental units (apartments, etc.) are not covered by the OTARD rules and will have to use indoor antennas to receive DTV broadcasts. It is possible that the landlord of an apartment complex can provide broadcast DTV signals via a master TV antenna system to each apartment.

4. Can I connect my DTV set-top receiver to my cable TV service?

Cable TV systems use a different method for transmitting digital TV programs that is currently incompatible with broadcast DTV set-top receivers. So you will still need to use an outdoor or indoor antenna to receive OTA broadcast DTV programs.

The good news is that you won't have to pay a monthly or per-program charge to watch OTA DTV and HDTV programs. They're free, unlike subscription satellite TV or premium cable TV. All you need is an antenna and a DTV set-top receiver to enjoy clear, sharp widescreen images and high-quality audio.

Table of Contents

| | |
|---|----|
| Your New Wide TV | 8 |
| Viewing Position | 8 |
| List of Features | 9 |
| Accessories | 9 |
| Front Panel LED Indicators | 10 |
| Front side buttons | 11 |
| Side Panel Jacks | 11 |
| Rear Panel Jacks | 12 |
| Remote Control | 13 |
| Connections | 16 |
| Connecting VHF and UHF Antennas | 16 |
| Antennas with 75-ohm Round Leads | 16 |
| Connecting Cable TV | 17 |
| Cable without a Cable Box | 17 |
| Cable with a Cable Box that Descrambles All Channels | 17 |
| Cable with a Cable Box that Descrambles Some (But Not All) Channels | 18 |
| Connecting a VCR | 19 |
| Connecting a VCR to the Video or S-Video/Audio jack | 19 |
| Connecting a Camcorder | 20 |
| Connecting a DVD Player | 21 |
| Connecting to HDMI (High Definition Multimedia Interface) | 21 |
| Connecting to Y, PB, PR | 21 |
| Connecting to Audio and Video Jacks | 22 |
| Connecting a DTV Set-Top Box | 23 |
| Connecting to Y, PB, PR | 23 |
| Connecting to DVI (Digital Visual Interface) | 23 |
| Connecting a VCR and DTV Set-Top Box | 24 |
| Connecting to HDMI (High Definition Multimedia Interface) | 24 |
| Connecting a Digital Audio System | 25 |
| Connecting to an Analog Amplifier | 26 |
| Operation | 28 |
| Turning the TV On and Off | 28 |
| Dynamic Menus and On-Screen Displays | 28 |
| Navigating Menus by Using the Menu Map | 29 |
| Selecting a Menu Language | 30 |
| Memorizing Channels | 31 |
| Changing Channels | 33 |
| Customizing Your Remote Control | 34 |
| Remote Control Codes | 38 |
| Setting the Clock | 41 |
| Setting the On/Off Timer | 43 |
| Setting the Sleep Timer | 44 |
| Viewing an External Signal Source | 45 |
| Assigning Names to External Input Mode | 46 |
| Channel Control | 48 |
| Selecting Your Favorite Channels | 48 |
| Viewing the Channel Lists | 49 |
| Adding and Erasing Channels Analog | 50 |
| Labeling the Channels Digital | 51 |
| Fine Tuning Analog Channels | 52 |
| Checking the Digital-Signal Strength | 53 |
| LNA (Low Noise Amplifier) | 54 |

| | |
|--|-----|
| Picture Control..... | 56 |
| Picture Control..... | 56 |
| Changing the Picture Size..... | 59 |
| Digital Noise Reduction..... | 60 |
| DNle (Digital Natural Image engine)..... | 61 |
| Setting the My Color Control Mode..... | 62 |
| Using the Color Weakness Enhancement Feature..... | 64 |
| Setting the Film Mode..... | 65 |
| Freezing the Picture..... | 66 |
| Setting the Blue Screen Mode..... | 67 |
| Sound Control..... | 70 |
| Sound Control..... | 70 |
| Setting the SRS TSXT..... | 72 |
| Auto Volume..... | 73 |
| Choosing a Multi-Channel Sound (MTS) track Digital | 74 |
| Choosing a Multi-Channel Sound (MTS) track Analog | 75 |
| Selecting the Internal Mute..... | 76 |
| Setting the On/Off Melody..... | 77 |
| Special Features..... | 80 |
| Setting the Function Help..... | 80 |
| Menu Transparency Level..... | 81 |
| Using Game Mode..... | 82 |
| Using the V-Chip..... | 83 |
| Using the V-Chip for Digital channels..... | 93 |
| Viewing Closed Captions (On-Screen Text Messages) Analog | 95 |
| Viewing Closed Captions (On-Screen Text Messages) Digital | 97 |
| PC Display..... | 100 |
| Using Your TV as a Computer (PC) Display..... | 100 |
| Adjusting the Picture Quality..... | 103 |
| Changing the Picture Position..... | 104 |
| Adjusting the Picture Quality and Position Automatically..... | 105 |
| Changing the Picture Size (PC Mode)..... | 106 |
| Viewing the Current Resolution..... | 107 |
| Initializing the Picture Settings..... | 108 |
| WISELINK..... | 110 |
| Using the WISELINK Function..... | 110 |
| Using the WISELINK Menu..... | 111 |
| Using the PHOTO (JPEG) List..... | 112 |
| Using the MP3 List..... | 119 |
| Using the Setup Menu..... | 121 |
| Appendix..... | 124 |
| Replacing the Lamp..... | 124 |
| Troubleshooting..... | 126 |
| Cleaning and Maintaining Your TV..... | 128 |
| Using Your TV in Another Country..... | 128 |
| Specifications..... | 129 |

SAMSUNG



Your New Wide TV



Your New Wide TV

Viewing Position

To optimize your viewing comfort, please follow the guidelines below for viewing distance. If viewing for an extended period of time, sit as far back from the screen as possible.

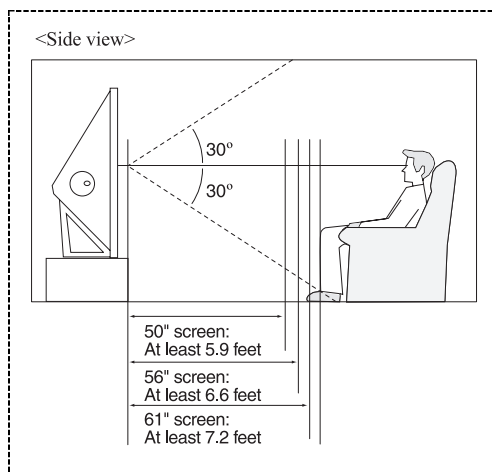
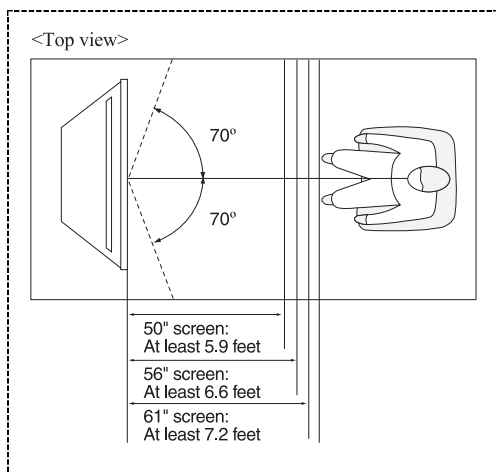

When installing the product, make sure to keep it away from the wall (more than 10cm/4 inches) for ventilation purposes.

- Poor ventilation may cause an increase in the internal temperature of the product, resulting in a shortened component life and degraded performance.

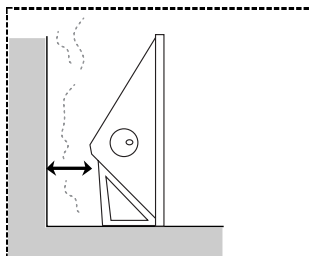

List of Features

Your TV is designed and engineered using the latest technology. It is a full-featured, high-performance unit that exceeds industry standards. In addition, it has these special features:

- Easy-to-operate remote control
- Dynamic menus and Navigating menus by using the menu map
- Easy-to-use on-screen menu system you can access from the front panel or remote control
- Automatic timer to turn the TV on and off at any time you choose
- Adjustable picture and sound settings and the ability to memorize your favorite settings
- Automatic channel tuning for up to 181 channels
- A special filter to reduce or eliminate reception problems
- Fine tuning control for the sharpest picture possible
- A built-in multi-channel sound decoder for stereo and bilingual listening
- Built-in, dual channel speakers
- A special sleep timer
- Widescreen TV with adjustable image size
- Life-like clear images provided by DNle technology
- My Color Control mode to correspond with your color preference
- Color Weakness mode
- Digital Input jack
- Digital Audio Output (OPTICAL) jack
- Game mode
- Easy-to-use channel manager menu.
- WISELINK enables you to view and play photo (JPEG) and audio files (MP3) through the TV's WISELINK jack.

Accessories

Once you have unpacked your TV, check to make sure that you have all the parts shown here. If any piece is missing or broken, call your dealer.



**Remote Control
(BP59-00107A)/
AAA Batteries**



**Warranty Card/
Registration Card/
Safety Guide Manual/
Quick Guide Manual/**



Owner's Instructions



**Power Cord
(3903-000144)**



Cloth-Clean

Your New Wide TV

Front Panel LED Indicators

The three lights on the front panel indicate the status of your TV. The product color and shape may vary depending on the model.

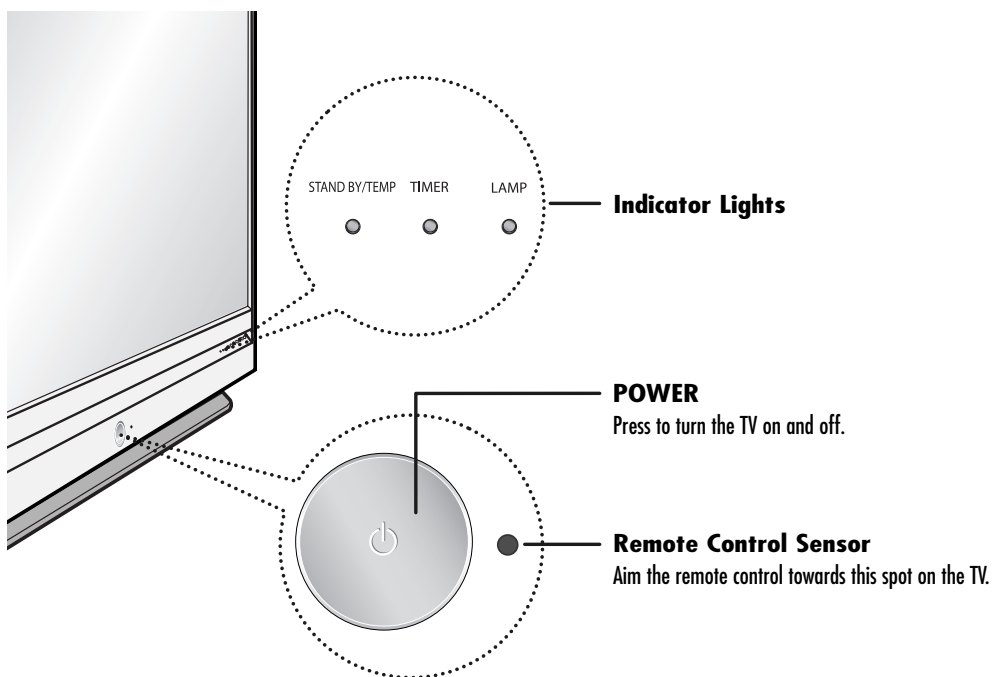

Indicator Light Key

- : Light is On
- ◐ : Light is Blinking
- : Light is Off

| STAND BY/TEMP | TIMER | LAMP | Indication |
|---------------|-------|------|---|
| ● | ○ | ○ | Standby state. |
| ○ | ○ | ◐ | The picture will automatically appear in about 15 seconds. |
| ○ | ● | ◐ | Auto Timer ON/OFF has been set and the set will automatically be turned on in about 15 seconds. |
| ◐ | ◐ | ○ | A cooling fan inside the set is not operating normally. |
| ◐ | ○ | ◐ | Lamp cover on the rear of the set is not properly shut. |
| ◐ | ○ | ○ | Check if the ventilation hole on the rear of the set is blocked, because if the inner temperature is too high, the power will shut off. |
| ◐ | ◐ | ◐ | Lamp may be defective. Please contact a certified technician. |

- It takes about 30 seconds for the TV to warm up, so normal brightness may not appear immediately.
- The TV has a fan to keep the inside lamp from overheating. You'll occasionally hear it working.

Front side buttons

The buttons on the front panel control your TV's basic features, including the on-screen menu system. To use the more advanced features, you must use the remote control. The product color and shape may vary depending on the model.

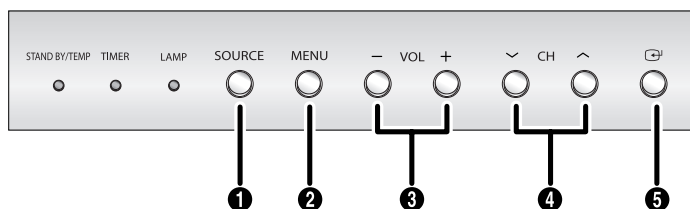

- 1 Press to switch between viewing TV programs and signals from connected components.
- 2 Press to see the on-screen menu.
- 3 Press to raise or lower the volume and to select items when using the on-screen menu.
- 4 Press to change channels and move between items on the on-screen menu.
- 5 Press to activate (or change) a particular item.

Side Panel Jacks

Use the right side panel jacks to connect a component that is used only occasionally (a camcorder or video game, for example). The product color and shape may vary depending on the model.

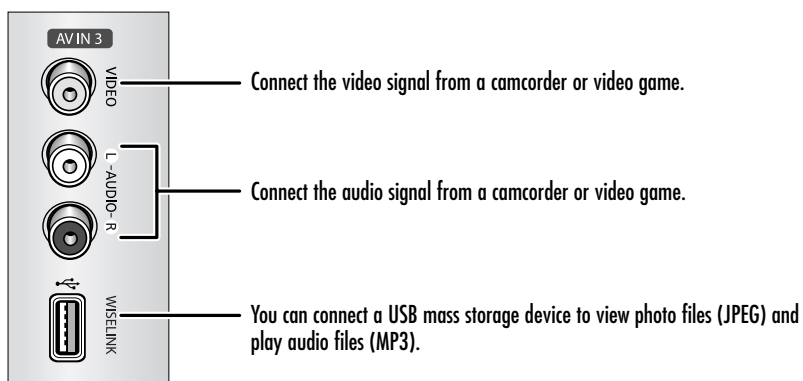

Your New Wide TV

Rear Panel Jacks

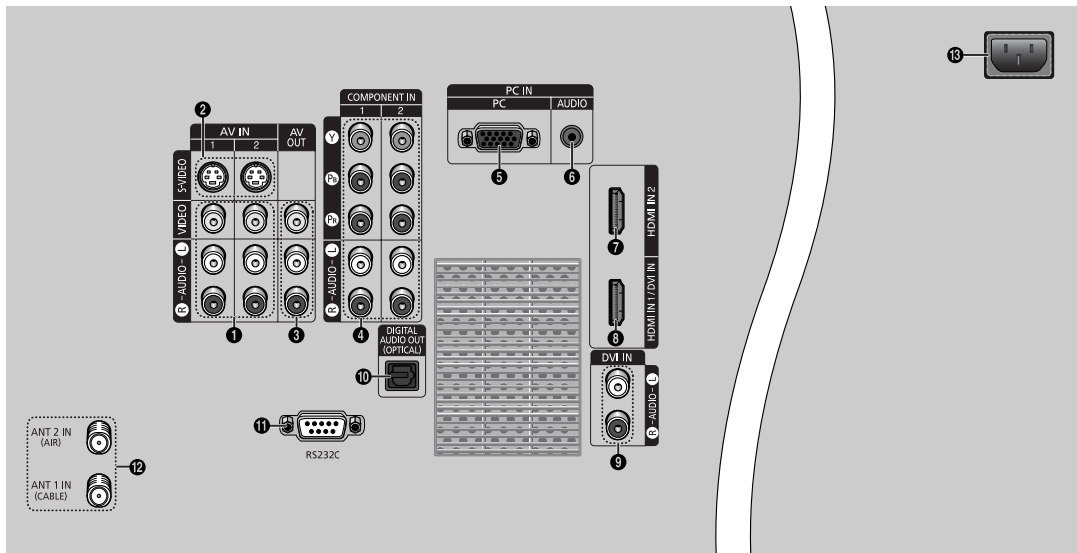

- 1 VIDEO/AUDIO INPUT jacks**
Connect video/audio signals from external sources, such as VCR or DVD players. (Refer to pages 19, 20, and 24)
- 2 S-VIDEO INPUT jacks**
Connects an S-Video signal from an S-VHS VCR or DVD player. (Refer to pages 19, 20, and 24)
- 3 VIDEO/AUDIO OUTPUT jacks**
Sends video/audio signals from the TV to an external source, such as a VCR. These jacks are available only in TV, Video and S-Video modes. (Refer to page 24)
- 4 COMPONENT IN 1, 2 jacks (Y, Pb, Pr, AUDIO L/R)**
Use these jacks to connect the component video/audio signals from a DVD player or a Set-Top Box. (Refer to pages 21 and 23)
- 5 PC VIDEO INPUT jack**
Connect these to the video output jack on your PC.
- 6 PC AUDIO INPUT jack**
Connect these to the audio output jack on your PC. (Refer to page 100)
- 7 HDMI (High Definition Multimedia Interface) INPUT jacks (HDMI IN 2)**
Connect to the HDMI jack of a device with HDMI output.
- 8 HDMI (High Definition Multimedia Interface)/ DVI INPUT jack (HDMI IN 1/DVI IN)**
Connect to the HDMI jack of a device with HDMI output. This input can also be used as a DVI connection with separate analog audio inputs. An optional HDMI/DVI cable will be necessary to make this connection. When using the optional HDMI/DVI adapter, the DVI analog audio inputs on your TV allow you to receive left and right audio from your DVI device. (Not compatible with PC) (Refer to pages 21 and 23)
- 9 DVI AUDIO (L/R) IN**
Connect to the DVI audio output jack of an external device. (Refer to page 23)
- 10 DIGITAL AUDIO OUT (OPTICAL) jack**
Connect to a Digital Audio Component. (Refer to page 25)
- 11 RS232C**
For service only.
- 12 ANTENNA terminals**
Two independent cables or antennas can be connected to these terminals. Use "ANT 1 IN (CABLE)" and "ANT 2 IN (AIR)" terminals to receive a signal from VHF/UHF antennas or your cable system. (Refer to pages 16~17)
- 13 POWER IN**
Connect the supplied power cord.

Remote Control

You can use the remote control up to about 23 feet from the TV. When using the remote control, always point it directly at the TV. You can also use your remote control to operate your VCR, Cable box, DVD player and Set-top box. See pages 34~40 for details.

- 1. POWER**
Turns the TV on and off.
- 2. Channel Number**
Press to directly tune to a particular channel.
- 3. -**
Press to select additional channels (digital and analog) being broadcast by the same station. For example, to select channel "54-3", press "54", then press "-" and "3".
- 4. ANTENNA**
Press to select "AIR" or "CABLE".
- 5. CH MGR**
Displays Channel Lists on the screen.
- 6. VCR/DVD Controls**
Controls VCR or DVD functions: Rewind, Stop, Play/Pause, Fast Forward.
- 7. VOL +, VOL -**
Press to increase or decrease the volume.
- 8. MUTE**
Press to mute the TV sound.
- 9. MENU**
Displays the main on-screen menu.
- 10. ▲, ▼, ◀, ▶, ENTER**
Press to move highlight up, down, left, or right. While using the on-screen menus, press ENTER to activate (or change) a particular item.
- 11. INFO**
Press to display information on the TV screen.
- 12. CAPTION**
Controls the caption decoder.
- 13. P.MODE**
Adjust the TV picture by selecting one of the preset factory settings (or select your personal, customized picture settings.) (Refer to page 56)
- 14. S.MODE**
Select Sound effect. (Refer to page 71)
- 15. MTS (Multichannel Television Stereo)**
Press to choose Stereo, Mono or SAP (Secondary Audio Program).
- 16. SRS**
Activates TruSurround. (Refer to page 72)

- 17. Mode (TV/DVD/STB/CABLE/VCR)**
Selects a target device to be controlled by the Samsung remote control (i.e., TV, DVD, STB, CABLE, or VCR).
- 18. SOURCE**
Press to display all of the available video sources (TV, AV1, AV2, AV3, S-Video1, S-Video2, Component1, Component2, PC, HDMI1, and HDMI2).
- 19. PRE-CH**
Tunes to the previous channel.
- 20. WISELINK**
This function enables you to view and play photo (JPEG) and audio files (MP3) from an external device. (Refer to page 110)
- 21. FAV.CH (Favorite Channel)**
Press to switch between your favorite channels.
- 22. CH ▲/▼**
Press to change channels.
- 23. EXIT**
Press to exit the menu.
- 24. SLEEP**
Press to select a preset time interval for automatic shut off. (Refer to page 44)
- 25. P.SIZE**
Press to change the screen size. (Refer to page 59)
- 26. STILL**
Press to pause the current screen. (Refer to page 66)
- 27. RESET**
If your remote control is not functioning properly, take out the batteries and press the reset button for about 2~3 seconds. Re-insert the batteries and try using the remote control again.
- 28. SET**
Used during set up of this remote control, so that it will work compatibly with other devices (Set-top box, VCR, Cable box, DVD, etc.)

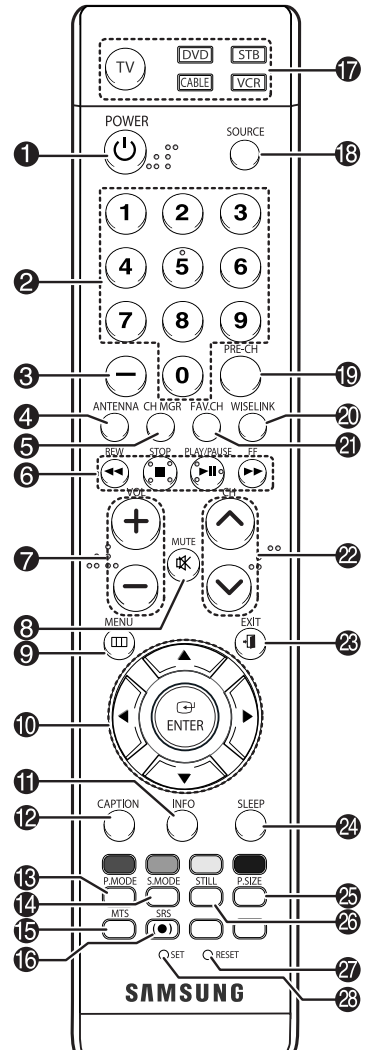

NOTES

- The Color buttons are used for the channel list function. (Refer to pages 48~51)
- This is a special remote control for the visually impaired, and has Braille points on the POWER, VOL +, VOL -, CH ▲/▼, STOP, and PLAY/PAUSE buttons.

Your New Wide TV

Installing Batteries in the Remote Control

With normal use, the batteries in the remote control should last about a year. If you notice a performance degradation while using the remote, the batteries may need to be replaced. Make sure you replace both batteries and do not mix old and new batteries in the remote control. If you won't be using the remote control for a long time, remove the batteries and store them in a cool, dry place.

- 1 Lift the cover at the back of the remote control upward as shown in the figure.

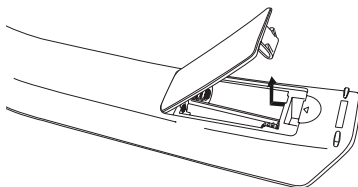

- 2 Install two AAA size batteries. Make sure to match the "+" and "-" ends of the batteries with the diagram inside the compartment.

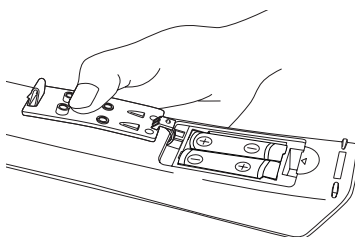

- 3 Close the cover as shown in the figure.

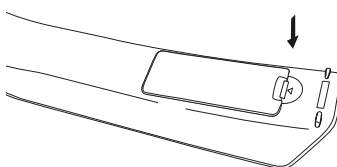

NOTE

- Do not mix battery types, i.e, alkaline and manganese.



Connections



Connections

Connecting VHF and UHF Antennas

If you do not have a cable system, you will need to connect an antenna to your TV.

Antennas with 75-ohm Round Leads

If your antenna looks like this:  it has 75-ohm round leads.

- 1 Plug the antenna lead into the ANT 2 IN (AIR) on the rear panel of your TV.

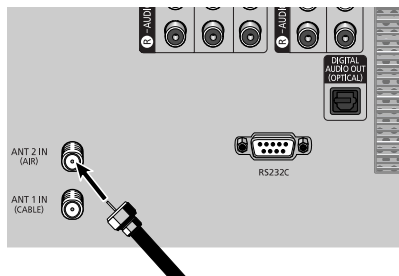

Connecting Cable TV

You can connect different cable systems to your TV, including cable without a Cable box, and cable with a Cable box that descrambles some or all channels.

Cable without a Cable Box

- 1 Plug the incoming cable into the ANT 1 IN (CABLE) on the rear panel of your TV.

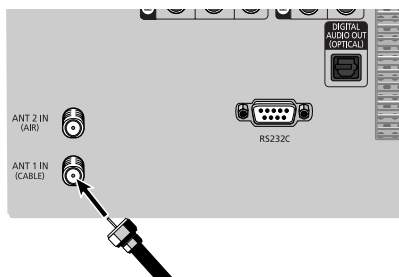

Cable with a Cable Box that Descrambles All Channels

- 1 Find the cable connected to the ANTENNA OUT terminal on your Cable box. This terminal might be labeled "ANT OUT", "VHF OUT" or simply "OUT".

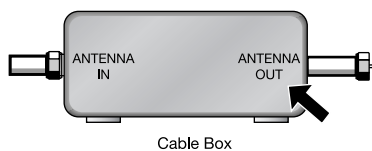

- 2 Connect the other end of the cable to the "ANT 1 IN (CABLE)" terminal on the rear panel of your TV.

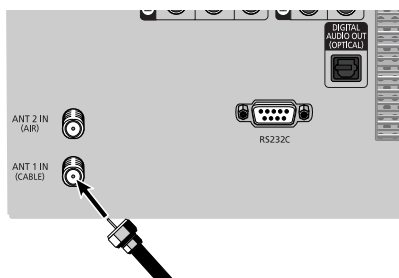

Connections

Cable with a Cable Box that Descrambles Some (But Not All) Channels

To complete this connection you will need a two-way splitter, an RF (A/B) switch, and four coaxial cables (which you can buy from your Samsung dealer or any electronics store).

- 1 Find and disconnect the cable that is connected to the ANTENNA IN terminal of your Splitter. This terminal might be labeled "ANT IN", "VHF IN" or simply, "IN". Connect this cable to a two-way splitter.

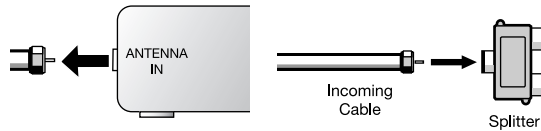

- 2 Connect a coaxial cable between an OUT terminal of the splitter and the IN terminal of the Cable box.

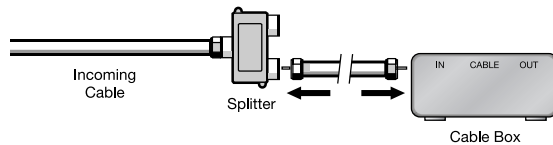

- 3 Connect a coaxial cable between the ANTENNA OUT terminal of the Cable box and the B-IN terminal of the RF (A/B) switch.

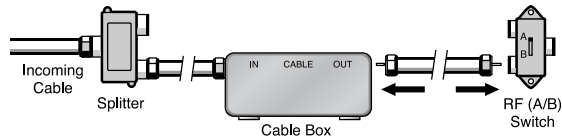

- 4 Connect another cable between the other OUT terminal on the splitter and the A-IN terminal on the RF (A/B) switch.

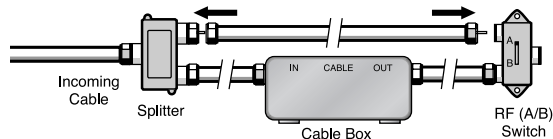

- 5 Connect the last coaxial cable between the OUT terminal of the RF (A/B) switch and the ANT 1 IN (CABLE) on the TV.

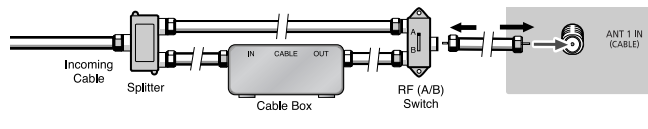

After you've made this connection, set the A/B switch to the "A" position for normal viewing. Set the A/B switch to the "B" position to view scrambled channels. (When you set the A/B switch to "B", you will need to tune your Set-Top Box to the Cable box's output channel, which is usually channel 3 or 4.)

Connecting a VCR

Connecting a VCR to the Video or S-Video/Audio jack

- 1 Connect a video cable between the VIDEO IN (1 or 2) (or S-VIDEO IN 1 or 2) jack on the TV and the VIDEO (or S-VIDEO) output jack on the VCR.
- 2 Connect a set of audio cables between the AUDIO IN (1 or 2) jacks on the TV and the AUDIO output jacks on the VCR.
- 3 Connect a video cable between the VIDEO OUT jack on the TV and the VIDEO input jack on the VCR.
- 4 Connect a set of audio cables between the AUDIO OUT jacks on the TV and the AUDIO input jacks on the VCR.

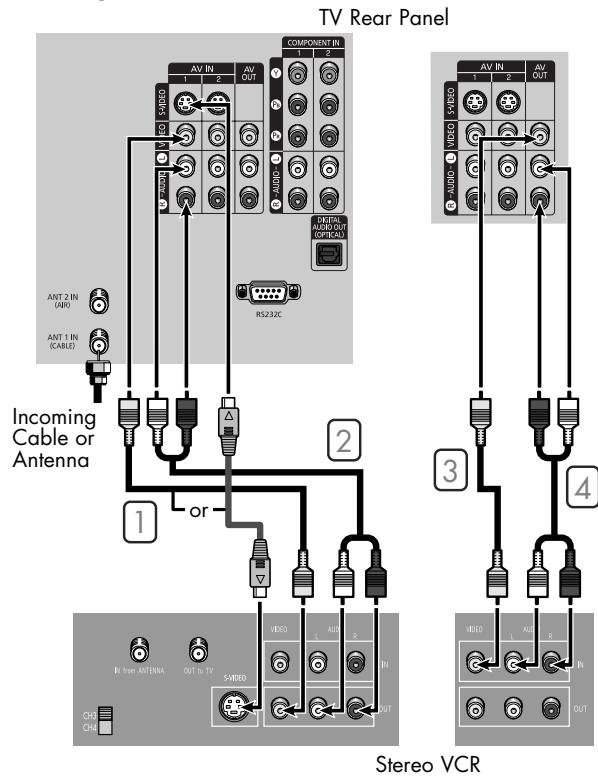

NOTES

- For better video, use an S-Video cable.
- Please be sure to match the color coded input terminals and cable jacks.
- Connecting Video/Audio cables from the Video and Audio Out jacks on the TV to the A/V In jacks on your VCR enables you to record from the TV onto the VCR.

Connections

Connecting a Camcorder

The side panel jacks on your TV make it easy to connect a Camcorder to your TV. You can use your camcorder to view tapes without using a VCR.

1 Locate the A/V output jacks on the camcorder. They are usually found on the side or back of the camcorder.

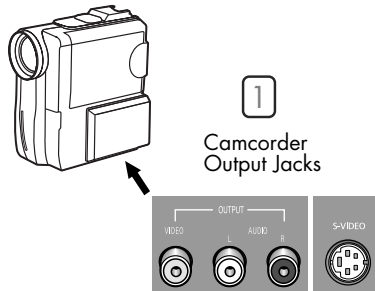

2 Connect a video or S-Video cable between the VIDEO IN (or S-VIDEO IN) jack on the TV and the VIDEO (or S-VIDEO) output jack on the Camcorder. The audio-video cables shown here are usually included with a Camcorder. (If not, check your local electronics store.) If your Camcorder is stereo, you need to connect a set of two cables.

TV Rear and right side

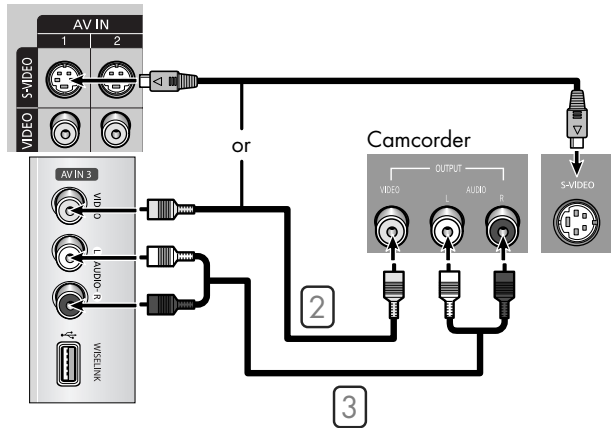

3 Connect a set of audio cables between the AUDIO IN jacks on the TV and the AUDIO output jacks on the camcorder. If you have a mono Camcorder, connect L(mono) to the Camcorder audio out using only one audio cable.

Connecting a DVD Player

The rear panel jacks on your TV make it easy to connect a DVD player to your TV.

Connecting to HDMI (High Definition Multimedia Interface)

- 1 Connect an HDMI cable between the HDMI IN 2 (or HDMI IN 1/DVI IN) jack on the TV and the HDMI OUT jack on the Set-Top Box.

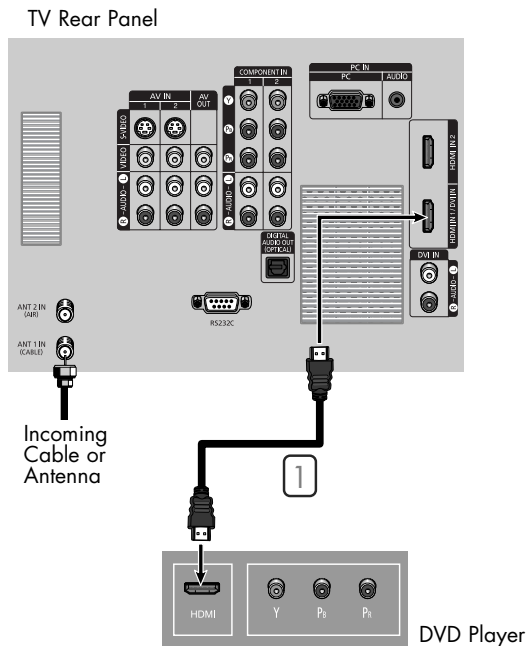

Connecting to Y, Pb, Pr

- 1 To enable Component video viewing, connect a set of Component video cables between the COMPONENT (1 or 2) VIDEO (Y, Pb, Pr) IN jacks on the TV and the COMPONENT (Y/Pb/Pr or Y/Cb/Cr) OUT jacks on the DVD player.
- 2 Connect a set of audio cables between the COMPONENT (1 or 2) AUDIO (L, R) IN jacks on the TV and the AUDIO OUT jacks on the DVD player.

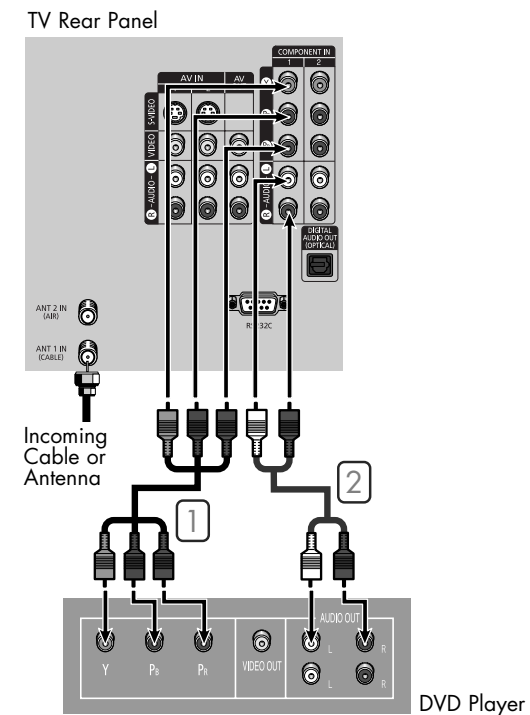

Connections

Connecting to Audio and Video Jacks

1 Connect a video cable between the VIDEO IN (1 or 2) jack on the TV and the VIDEO OUT jack on the DVD player.

2 Connect a set of audio cables between the AUDIO IN (1 or 2) jacks on the TV and the AUDIO OUT jacks on the DVD player.

NOTES

- Component Video separates the video into Y (Luminance (Brightness)), P_B (Blue) and P_R (Red) for enhanced video quality.
- Please be sure to match the color coded input terminals and cable jacks.

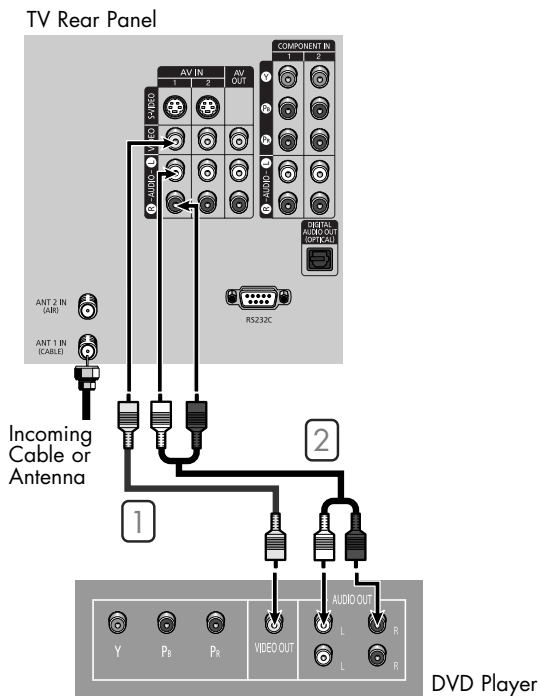

Connecting a DTV Set-Top Box

Connecting to Y, Pb, Pr

- 1 Connect a set of Component cables between the COMPONENT (1 or 2) VIDEO (Y, Pb, Pr) IN jacks on the TV and VIDEO (Y/Pb/Pr or Y/Cb/Cr) OUT jacks on the Set-Top Box.
- 2 Connect a set of audio cables between the COMPONENT (1 or 2) AUDIO (L, R) IN jacks on the TV and the AUDIO OUT jacks on the Set-Top Box.

NOTE

- Please be sure to match the color coded input terminals and cable jacks.

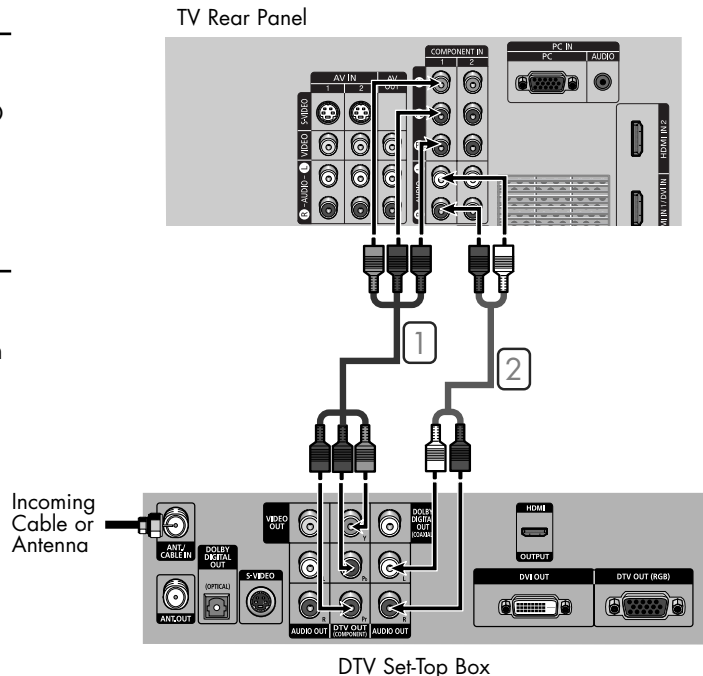

Connecting to DVI (Digital Visual Interface)

- 1 Connect an HDMI/DVI cable between the HDMI IN 1/DVI IN jack on the TV and the DVI OUT jack on the Set-Top Box.
- 2 Connect a set of audio cables between the DVI AUDIO (L, R) IN jacks on the TV and the AUDIO OUT jacks on the Set-Top Box.

NOTES

- Requires a Cable Converter.
- Make sure the HDMI/DVI source's power is on, or you will be unable to select it in the TV menu's source list.
- The HDMI IN 1/DVI IN jack is not compatible with PC.

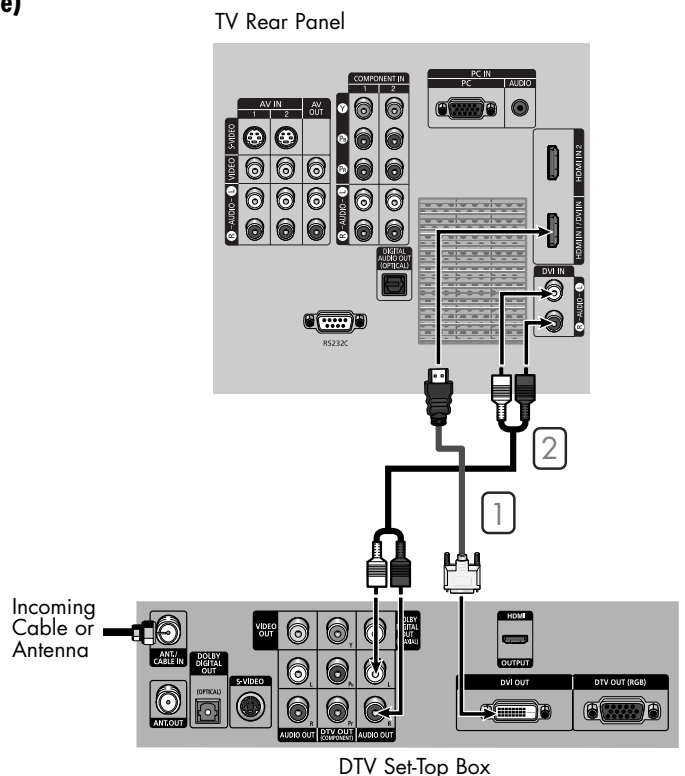

Connections

Connecting a VCR and DTV Set-Top Box

- 1 Connect the Video or S-Video/Audio cables between the VIDEO or S-VIDEO/AUDIO input jacks on the TV and VIDEO or S-VIDEO/AUDIO output jacks on the VCR.
- 2 Connect the Video/Audio cables between the VIDEO or S-VIDEO/AUDIO input jacks on the TV and VIDEO or S-VIDEO/AUDIO output jacks on the Set-Top Box.
- 3 Connect a video cable between the VIDEO OUT jack on the TV and the VIDEO input jack on the VCR.
- 4 Connect a set of audio cables between the AUDIO OUT jacks on the TV and the AUDIO input jacks on the VCR.
- 5 Use the coaxial cable to connect between the splitter and the ANT 1 IN (CABLE) on the TV and between the splitter and the ANT IN on the Set-Top Box.

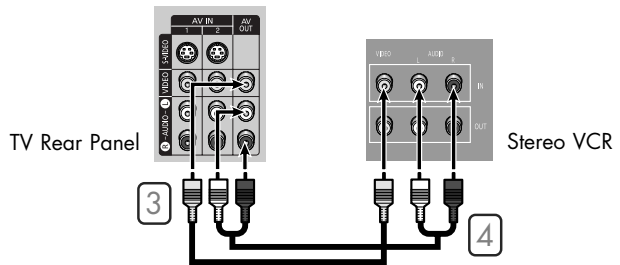
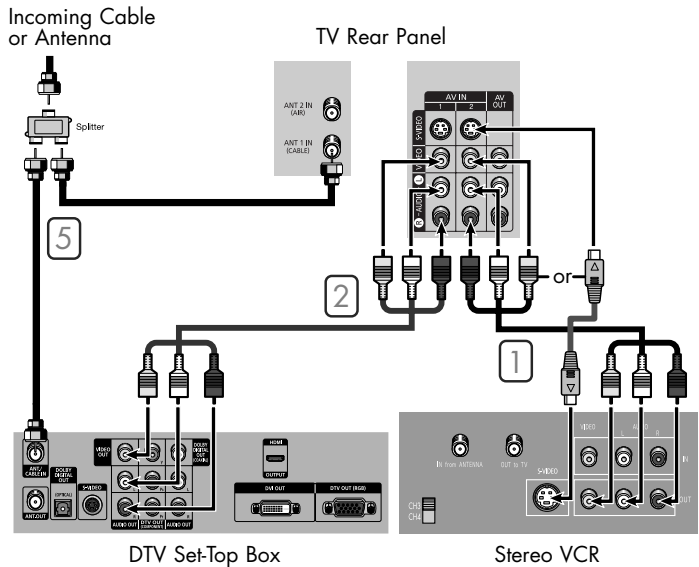

Connecting to HDMI (High Definition Multimedia Interface)

- 1 Connect an HDMI cable between the HDMI IN 2 (or HDMI IN 1/DVI IN) jack on the TV and the HDMI OUT jack on the Set-Top Box.

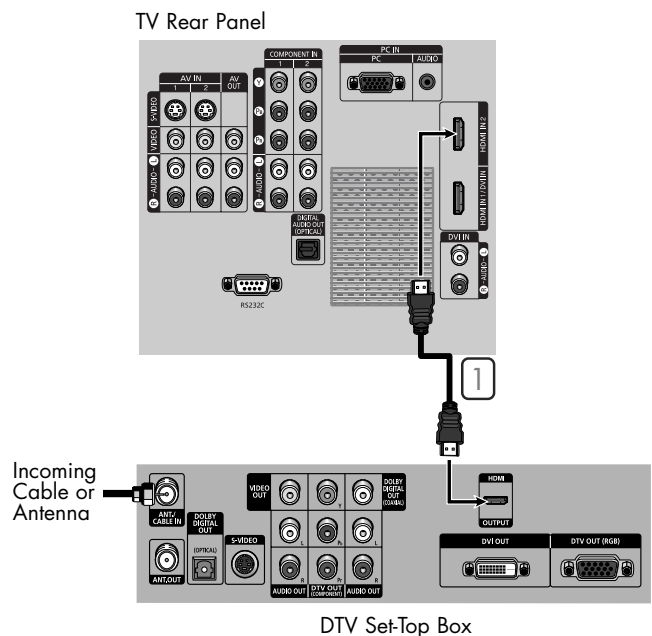

Connecting a Digital Audio System

There are many types of digital audio systems on the market today.

A simplified illustration of an audio system is shown below. For more information, see your audio system owner's manual.

1 If your audio system has an optical digital audio input, connect to the "DIGITAL AUDIO OUT(OPTICAL)" jack on the TV.

NOTE

- **OPTICAL:** converts the electric signal into an optical light signal, and transmits it through glass fibers.
- When a Digital audio system is connected to the Digital Audio Out (Optical) terminal: Decrease the gain (volume) of the TV, and adjust the volume level with the audio system's volume control.

TV Rear Panel

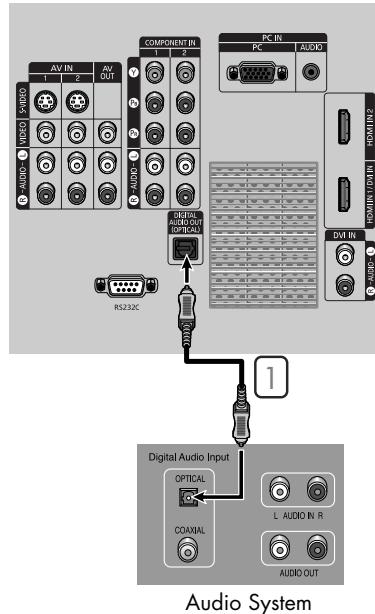

| | Internal Speakers | | Audio Out (Optical, L/R Out) | | Video Output |
|----------------------------------|-------------------|------------------|------------------------------|------------------|--------------|
| | Internal Mute Off | Internal Mute On | Internal Mute Off | Internal Mute On | |
| RF AV S-Video | Active | Inactive | Active | Active | Active |
| Component PC HDMI | Active | Inactive | Active | Active | Inactive |

When "Internal mute" is set to "On", Sound menus except "Multi-Track Options" cannot be adjusted.

Connections

Connecting to an Analog Amplifier

1 The "AV OUT (AUDIO L/R)" terminals cannot be used for external speakers. You must hook them up to an amplifier.

When an audio amplifier is connected to the "AV OUT (AUDIO L/R)" terminals: Decrease the gain (volume) of the TV, and adjust the volume level with the volume control on your audio amplifier.

NOTE

- If using the HDMI/DVI, PC, or Component input on the TV, the audio output signal is available only when the TV's Internal Mute is set to on. (Refer to page 76)

TV Rear Panel

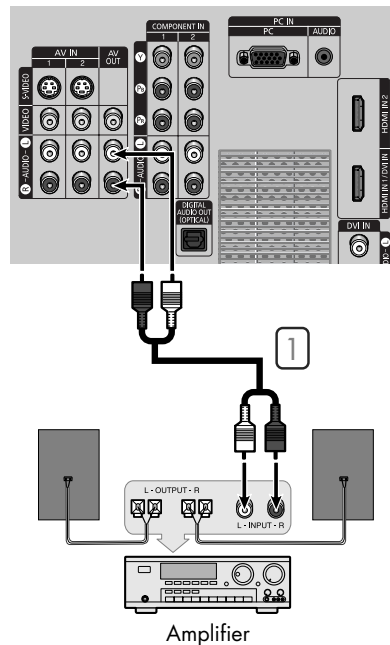



Operation

Operation

Turning the TV On and Off

Press the POWER button on the remote control.
You can also use the POWER button on the front panel.

Dynamic Menus and On-Screen Displays

The on-screen menu system allows you to control the settings of your TV. Access the on-screen menu system by pressing the MENU button on the remote control. Once the on-screen menu appears, use the ▲/▼/◀/▶/ENTER buttons on your remote control to select menu items and make adjustments. You can also view the on-screen menu system and make some adjustments using the TV's front panel buttons.

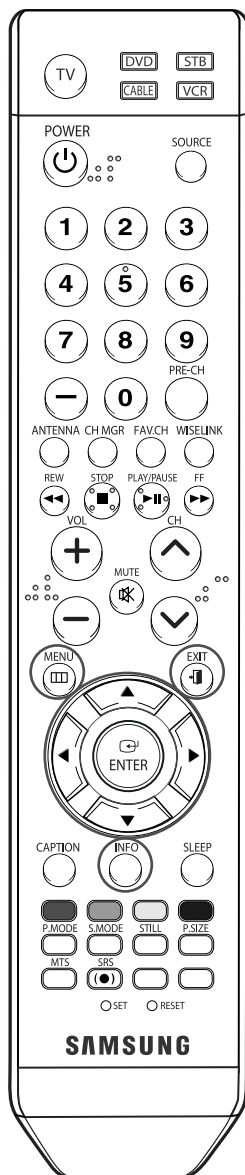

Viewing the Menus

- 1 Press the MENU button.
The main menu will appear at the bottom of the screen. There are seven menu groups: "Input", "Picture", "Sound", "Channel", "Setup", "Application", and "Menu Map".

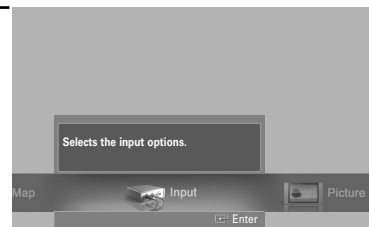

- 2 Press the ◀ or ▶ button, then press the ENTER button to select an item you want in the menu. Press the ▲/▼/◀/▶/ENTER button to display, change, or use the selected items.



Select "Return" by pressing the ▲ or ▼ button, then press the ENTER button to return to the previous menu. Press the EXIT button to exit.

Viewing the Display

Press the INFO button on the remote control.
The TV displays the current channel, the status of certain picture, sound settings and the current time.
The information displayed varies according to the selected source.

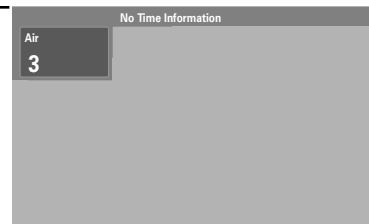

Navigating Menus by Using the Menu Map

Using the Menu Map of the main menu enables you to view all menus and select a function quickly. You can select any menu by using the menu map.

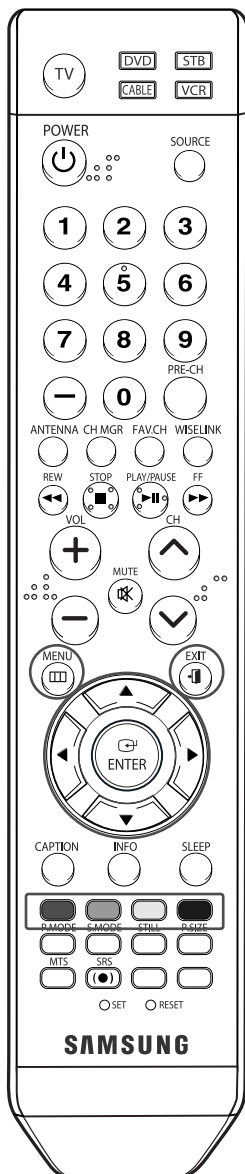

- 1 Press the MENU button.
The main menu will appear at the bottom of the screen.
- 2 Press the ◀ or ▶ button to select "Menu Map", then press the ENTER button. The menu map will appear.
- 3 Press the ▲ or ▼ button to select a menu, then press the ENTER button. The selected menu will appear.
- 4 Press the ▲/▼/◀/▶/ENTER buttons to display, change, or use the selected items.
 - Red button: Displays menus in alphabetical order.
 - Green button: Moves to the previous page.
 - Yellow button: Moves to the next page.
 - Blue button: Exits from the menu.
 - ENTER button: Moves to the selected menu.

Press the EXIT button to exit.



Operation

Selecting a Menu Language

When you start using your television for the first time, you must select the language which will be used for displaying menus and indications.

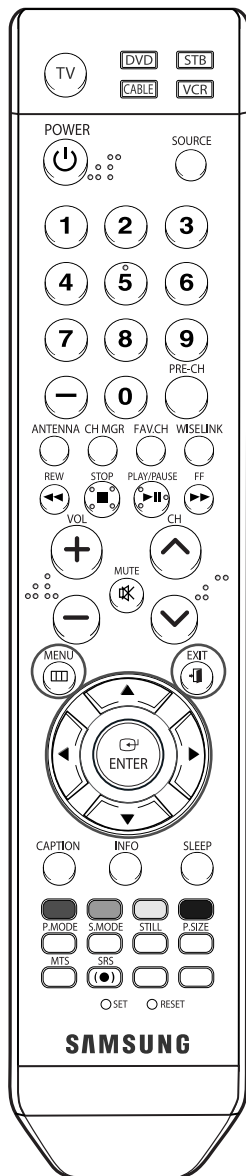

- 1 Press the MENU button.
Press the ◀ or ▶ button to select "Setup", then press the ENTER button.

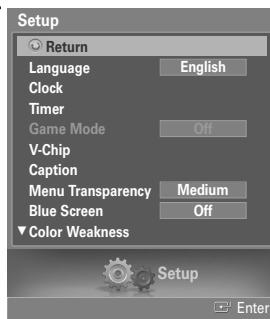

- 2 Press the ▲ or ▼ button to select "Language", then press the ENTER button.

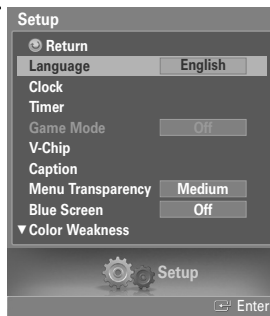

- 3 Press the ▲ or ▼ button to select "English", "Español" or "Français", then press the ENTER button.

Select "Return" by pressing the ▲ or ▼ button, then press the ENTER button to return to the previous menu. Press the EXIT button to exit.

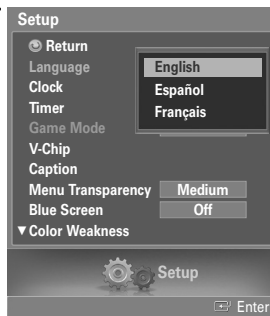

Memorizing Channels

Your TV can memorize and store all of the available channels for both “off-air” (antenna) and cable channels. After the available channels are memorized, use the CH \wedge and CH \vee buttons to scan through the channels. This eliminates the need to change channels by entering the channel digits. There are three steps for memorizing channels: selecting a broadcast source, memorizing the channels (automatic).

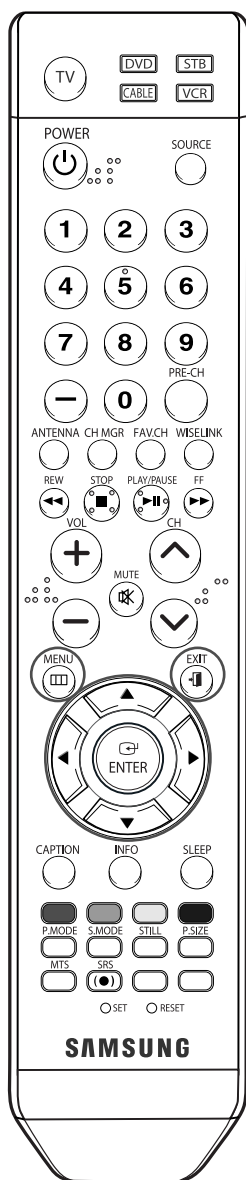

Selecting the Video Signal Source

Before your television can begin memorizing the available channels, you must specify the type of signal source that is connected to the TV (i.e., an antenna or cable system).

- 1 Press the MENU button.
Press the \blacktriangleleft or \blacktriangleright button to select “Channel”, then press the ENTER button.



- 2 Press the \blacktriangle or \blacktriangledown button to select “Antenna”, then press the ENTER button.
Press the \blacktriangle or \blacktriangledown button to select “Air” or “Cable”, then press the ENTER button.

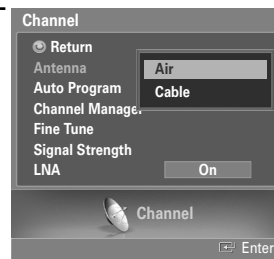

- 3 Press the \blacktriangle or \blacktriangledown button to select “Auto Program”, then press the ENTER button.



Continued...

Operation

4 Press the ◀ or ▶ button to select the Antenna connection, then press the ENTER button.

- Air : "Air" antenna signal
Cable : "Cable" antenna signal
Air+Cable : "Air" and "Cable" antenna signals

When selecting Cable TV system:

Press the ENTER button to start the auto program.

By default, the cable TV system is set to "STD".

If you want to select another type of cable system, press the

◀ or ▶ button to select "STD", "HRC" or "IRC".

- STD, HRC and IRC identify various types of cable TV systems.
Contact your local cable company to identify the type of cable system that exists in your particular area.
At this point the signal source has been selected.

5 Press the ENTER to start the auto program.
The TV begins memorizing all available stations.
Press the ENTER button at any time to interrupt the memorization process.

Select "Return" by pressing the ▲ or ▼ button, then press the ENTER button to return to the previous menu.

Press the EXIT button to exit.

- The TV must be connected to an antenna in order to receive digital TV signals. Even if a particular channel is deleted from the memory, you can always tune to that channel directly by using the number buttons on the remote control.
- When connecting Digital Cable to a Set-Top Box, Channel Memorization is done on the STB. To view the STB on your TV, select the Input jack the STB is connected to with the SOURCE button on the remote control. (see page 45)

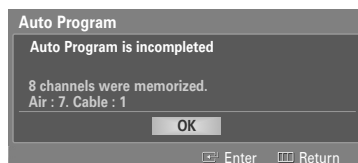
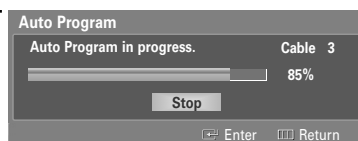
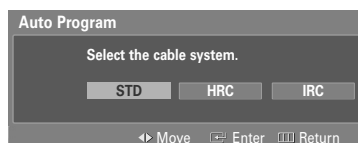
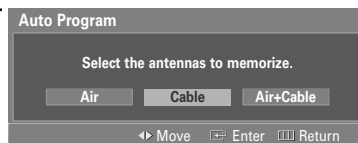

NOTE

- All available DTV and analog channels are automatically stored in memory.

Changing Channels

Using the Channel Buttons

Press the CH \wedge or CH \vee button to change channels.

When you press the CH \wedge or CH \vee button, the TV changes channels in sequence. You will see all the channels that the TV has memorized. (The TV must have memorized at least three channels.) You will not see channels that were either erased or not memorized.

Using the Number Buttons

Use the number buttons to quickly switch to any channel.

Press the number buttons to go directly to a channel. For example, to select channel 27, press "2," then "7." The TV will change channels when you press the second number.

Using the "-" Button

The "-" button is used to select stations that broadcast both a digital and analog signal.

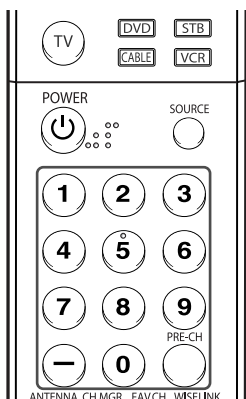

For example, for channel 7-1 (digital), press "7", then "-", then "1".



NOTE

- *HD indicates the TV is receiving a Digital High Definition signal.*
SD indicates the TV is receiving a Analog standard definition signal.

Using the Previous Channel

Press the PRE-CH button.
The TV changes to the last channel you were watching.

Operation

Customizing Your Remote Control

After it has been set up properly, your remote control can operate in five different modes: TV, VCR, Cable, DVD, or Set-Top Box. Pressing the corresponding button on the remote control allows you to switch between these modes, and control whichever piece of equipment you choose.

NOTE

- The remote control might not be compatible with all DVD Players, VCRs, Cable boxes, and Set-Top Boxes.

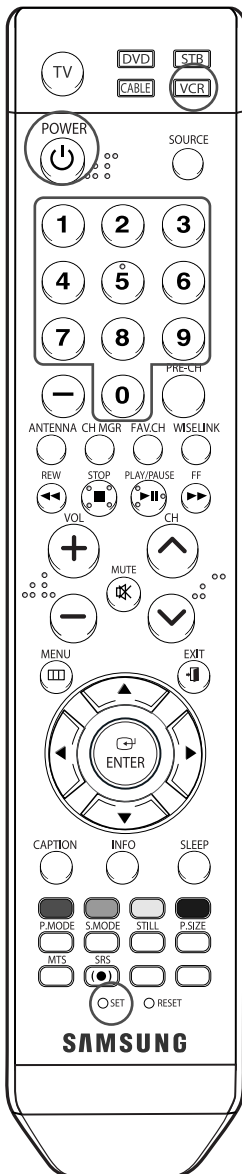

Setting Up the Remote to Operate Your VCR

- 1 Turn off your VCR.
- 2 Press the VCR button on your TV's remote control.
- 3 Press the SET button on your TV's remote control.
- 4 Using the number buttons on your remote control, enter three digits of the VCR code listed on page 38 of this manual for your brand of VCR. Make sure you enter three digits of the code, even if the first digit is a "0". (If more than one code is listed, try the first one.)
- 5 Press the POWER button on the remote control. Your VCR should turn on if your remote is set up correctly.

If your VCR does not turn on after set-up, repeat steps 2, 3 and 4, but try one of the other codes listed for your brand of VCR. If no other codes are listed, try each VCR code, 000 through 080.

Note on Using Remote Control Modes: VCR

When your remote control is in "VCR" mode, the volume buttons still control your TV's volume.

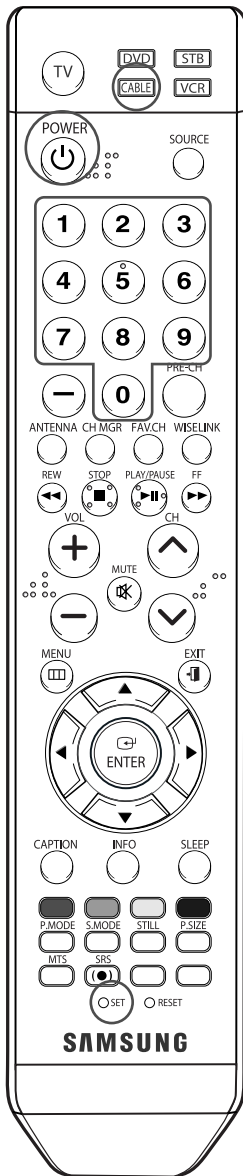

Setting Up the Remote to Operate Your Cable Box

- 1 Turn off your cable box.
- 2 Press the CABLE button on your TV's remote control.
- 3 Press the SET button on your TV's remote control.
- 4 Using the number buttons on your remote control, enter three digits of the cable box code listed on page 39 of this manual for your brand of cable box. Make sure you enter three digits of the code, even if the first digit is a "0".
(If more than one code is listed, try the first one.)
- 5 Press the POWER button on the remote control.
Your cable box should turn on if your remote is set up correctly.

If your cable box does not turn on after set-up, repeat steps 2, 3 and 4, but try one of the other codes listed for your brand of cable box. If no other codes are listed, try each code, 000 through 046.

Note on Using Remote Control Modes: Cable Box

When your remote control is in "CATV" mode, the volume buttons still control your TV's volume.

Operation

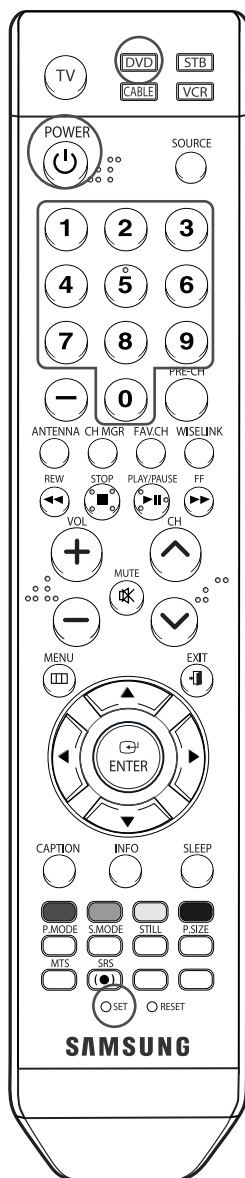

Setting Up the Remote to Operate Your DVD

- 1 Turn off your DVD.
- 2 Press the DVD button on your TV's remote control.
- 3 Press the SET button on your TV's remote control.
- 4 Using the number buttons on your remote control, enter three digits of the DVD code listed on page 40 of this manual for your brand of DVD. Make sure you enter three digits of the code, even if the first digit is a "0". (If more than one code is listed, try the first one.)
- 5 Press the POWER button on the remote control.
Your DVD should turn on if your remote is set up correctly.

If your DVD does not turn on after set-up, repeat steps 2, 3 and 4, but try one of the other codes listed for your brand of DVD. If no other codes are listed, try each code, 000 through 141.

Note on Using Remote Control Modes: DVD

When your remote control is in "DVD" mode, the volume buttons still control your TV's volume.

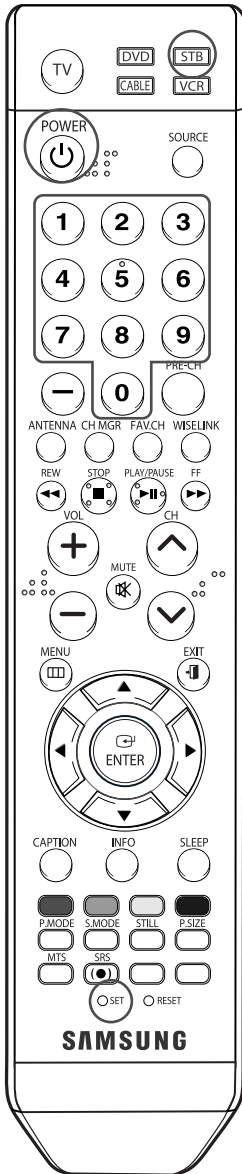

Setting Up the Remote to Operate Your Set Top Box

- 1 Turn off your STB.
- 2 Press the STB button on your TV's remote control.
- 3 Press the SET button on your TV's remote control.
- 4 Using the number buttons on your remote control, enter three digits of the STB code listed on page 39 of this manual for your brand of STB. Make sure you enter three digits of the code, even if the first digit is a "0". (If more than one code is listed, try the first one.)
- 5 Press the POWER button on the remote control.
Your STB should turn on if your remote is set up correctly.

If your STB does not turn on after set-up, repeat steps 2, 3 and 4, but try one of the other codes listed for your brand of STB. If no other codes are listed, try each code, 000 through 074.

Note on Using Remote Control Modes: STB

When your remote control is in "STB" mode, the volume buttons still control your TV's volume

Operation

Remote Control Codes

VCR

| Brand | Code |
|------------------|--|
| SAMSUNG | 000 001 002 003 004 005 077 078 079 |
| ADMIRAL | 020 |
| AIWA | 025 |
| AKAI | 004 027 032 |
| AUDIO DYNAMICS | 007 026 |
| BELL&HOWELL | 018 |
| BROKSONIC | 022 |
| CANDLE | 002 003 006 008 015 055 |
| CANON | 021 056 |
| CITIZEN | 002 003 006 008 015 055 |
| COLORTYME | 007 |
| CRAIG | 002 024 |
| CURTIS MATHES | 002 007 008 017 021 025 056 064 066 |
| DAEWOO | 003 010 011 012 013 014 015 016 |
| DB | 007 026 |
| DIMENSIA | 017 |
| DYNATECH | 025 |
| ELECTROHOME | 034 |
| EMERSON | 001 003 006 021 022 025 030 032 034 040 047 050 052 060 063 065 066 067 069 073 |
| FISHER | 018 024 028 029 048 051 061 |
| FUNAI | 025 |
| GENERAL ELECTRIC | 002 005 017 021 056 |
| GO VIDEO | 002 |
| LG(Goldstar) | 006 007 008 009 010 |
| HARMAN KARDON | 007 |
| HITACHI | 019 025 041 042 074 |
| INSTANT REPLAY | 021 |
| JC PENNEY | 002 007 018 019 021 026 037 041 054 056 |
| JCL | 007 008 018 021 026 037 |
| KENWOOD | 007 008 018 026 037 |
| KLH | 070 |
| LLOYD | 025 |
| LOGIK | 038 |
| LXI | 025 |
| JVC | 081 082 083 |
| MAGNAVOX | 021 056 059 |
| MARANTZ | 007 008 018 021 026 037 062 |
| MARTA | 006 |
| KONIA | 036 |
| ORION | 073 074 075 076 |
| MEI | 021 |
| MEMOREX | 006 021 024 025 |
| MGA | 034 |
| MIDLAND | 005 |
| MINOLTA | 019 041 075 |

| Brand | Code |
|-----------------------|---|
| mitsubishi | 019 034 041 046 |
| MONTGOMERY WARD | 020 |
| MTC | 002 025 |
| MULTITECH | 002 005 025 038 |
| NEC | 007 008 018 026 037 062 064 |
| OPTIMUS | 020 |
| PANASONIC | 021 056 071 072 |
| PENTAX | 019 041 075 |
| PENTEX RESEARCH+ | 008 |
| PHILCO | 021 056 059 |
| PHILIPS | 021 080 |
| PIONEER | 019 026 039 053 |
| PORTLAND | 015 049 055 |
| PROSCAN | 017 |
| QUARTZ | 018 |
| QUASAR | 021 056 |
| RADIO SHACK/REALISTIC | 006 018 020 021 024 025 029 034 048 056 |
| RCA | 002 017 019 021 035 041 043 057 068 076 |
| SANSUI | 026 |
| SANYO | 018 024 |
| SCOTT | 003 047 052 067 |
| SEARS | 006 018 019 024 028 029 041 048 051 |
| SHARP | 020 034 045 015 |
| SHIMTOM | 027 033 038 058 |
| SIGNATURE | 025 |
| SONY | 027 033 044 |
| SYLVANIA | 021 025 056 059 |
| SYMPHONIC | 025 |
| TANDY | 018 025 |
| TASHIKA | 006 |
| TATUNG | 037 |
| TEAC | 025 037 068 |
| TECHNICS | 021 |
| TEKNIKA | 006 021 025 031 |
| TMK | 066 |
| TOSHIBA | 003 019 029 051 052 |
| TOTEVISION | 002 006 |
| UNITECH | 002 |
| VECTOR RESEARCH | 007 026 |
| VICTOR | 026 |
| VIDEO CONCEPTS | 007 026 |
| VIDEOSONIC | 002 |
| WARDS | 002 003 006 019 020 021 024 025 034 038 041 |
| YAMAHA | 007 008 018 026 037 |
| ZENITH | 023 027 033 |

continued...

CABLE BOX

| Brand | Code |
|-----------|---------------------------------|
| SAMSUNG | 000 001 002 003 004 005 006 007 |
| GI | 041 |
| HAMLIN | 003 024 031 |
| HITACHI | 025 030 |
| JERROLD | 038 039 |
| MACOM | 025 030 |
| MAGNAVOX | 019 023 028 |
| OAK | 026 |
| PANASONIC | 003 022 027 037 044 |
| PHILIPS | 019 021 023 028 |
| PIONEER | 004 018 020 044 |
| RCA | 014 022 040 |
| REGAL | 003 |

SAMSUNG SET-TOP BOX

| Product | Code |
|----------------------------------|---------|
| Ground wave STB | 001 002 |
| Satellite STB | 003 |
| CABLE STB | 004 |
| STB DVD COMBO | 008 |
| Satellite STB HDD COMBO Standard | 009 |

SET-TOP BOX

| Brand | Code |
|---------------------|--|
| ALPHASTAR | 023 |
| ANAM | 043 |
| CHANNEL MASTER | 018 034 |
| CROSSDIGITAL | 019 |
| CHAPARRAL | 035 |
| DIRECT TV | 015 016 017 019 022 045 060 061 062 065 066 067 068 |
| DAEWOO | 074 |
| DISH NETWORK SYSTEM | 069 070 |
| DISHPRO | 069 |
| DRAKE | 018 024 032 |
| DX ANTENNA | 027 |
| ECHOSTAR | 025 069 070 071 |
| EXPRESSVU | 069 |
| GDI | 069 |
| GE | 065 |
| GENERAL INSTRUMENT | 046 047 048 063 064 |
| HTS | 069 |
| HOME CABLE | 056 |
| HITACHI | 022 |
| HUGHES NETWORK | 015 017 |
| IQ | 020 |
| IQ PRISM | 020 |
| JANEIL | 059 |
| JERROLD | 063 |
| JVC | 069 070 |

| Brand | Code |
|------------------|---------------------|
| REGENCY | 015 023 |
| SA | 042 043 |
| SCIENTIFIC ATLAN | 042 043 |
| SPRUCER | 022 |
| STARGATE 2000 | 036 |
| SYLVANIA | 016 |
| TEXSCAN | 016 |
| TOCOM | 032 |
| UNIVERSAL | 033 034 |
| VIEWSTAR | 019 021 023 028 |
| WAMER AMEX | 046 |
| ZENITH | 017 029 035 037 045 |

| Product | Code |
|------------------------------------|------|
| Satellite STB HDD COMBO Premium | 010 |
| CABLE STB HDD COMBO Standard | 011 |
| CABLE STB HDD COMBO Premium | 012 |
| Ground wave STB HDD COMBO Standard | 013 |
| Ground wave STB HDD COMBO Premium | 014 |

| Brand | Code |
|--------------|---|
| LG(Goldstar) | 044 073 |
| MAGNAVOX | 016 021 036 038 039 040 041 042 |
| MEMOREX | 016 |
| MOTOROLA | 064 |
| MACOM | 018 |
| MITSUBISHI | 015 |
| NEXT LEVEL | 047 048 064 |
| PHILIPS | 015 016 017 021 033 036 038 039 040 041 042 067 |
| PRIMESTAR | 046 049 050 063 |
| PANASONIC | 058 059 061 062 |
| PAYSAT | 016 |
| PROSCAN | 065 066 |
| RCA | 051 052 053 065 066 |
| RADIOSHACK | 064 |
| REALISTIC | 057 |
| STS | 020 027 |
| STAR TRAK | 026 |
| SKY | 031 |
| SKY LIFE | 005 006 007 |
| SHACK | 064 |
| STAR CHOICE | 064 |
| SONY | 054 060 |
| TOSHIBA | 015 017 028 029 030 072 |
| ULTIMATE TV | 060 066 |
| UNIDEN | 016 021 037 055 056 057 |
| ZENITH | 024 031 068 |

continued...

Operation

SAMSUNG DVD

| Product | Code |
|------------|---------------------|
| DVD | 000 001 002 |
| DVDR | 003 004 |
| BD Record | 005 006 |
| VCR COMBO | 007 008 009 010 011 |
| VCR Record | 012 |
| DHR COMBO | 013 |

DVD

| Brand | Code |
|------------------|-------------------------------------|
| ANAM | 030 |
| AUDIOVOX | 075 |
| AUDIOLOGIC | 085 |
| ANABA | 072 |
| APEX DIGITAL | 070 071 074 086 083 084 088 111 112 |
| AIWA | 114 |
| BROKSONIC | 062 |
| BLAUPUNKT | 074 |
| B&K | 122 123 |
| CURTIS MATHES | 027 |
| CYBER HOME | 065 077 078 079 082 |
| CLARION | 080 125 |
| CIRRUS | 081 |
| CINEVISION | 095 |
| DAEWOO | 066 |
| DENON | 146 |
| FARENHEIT | 067 068 |
| FISHER | 090 |
| GPX | 060 |
| GO VIDEO | 061 089 133 135 |
| GE | 069 074 |
| GREENHILL | 074 |
| HITACHI | 064 113 |
| HITEKER | 071 |
| HOYO | 073 |
| HARMAN / KARDON | 091 110 |
| IRT | 089 |
| INTEGRA | 092 |
| JBL | 091 |
| JVC | 022 033 115 116 |
| JATON | 073 |
| KENWOOD | 051 108 109 |
| KISS | 073 |
| KONKA | 059 100 106 107 |
| KLH | 074 075 |
| LG(Goldstar) | 025 031 |
| LOEWE | 057 |
| LASONIC | 058 |
| MOBILE AUTHORITY | 054 |
| MEMOREX | 055 |
| MALATA | 056 |
| MAGNAVOX | 076 093 |
| MINTEK | 074 094 |
| MONYKA | 073 |

| Product | Code |
|------------------------|-------------|
| Home Theater VCR COMBO | 014 015 016 |
| HDD Record COMBO | 017 |
| TWIN TRAY COMBO | 018 |
| STB DVD COMBO | 019 |
| DVD Receiver | 020 |
| AV Receiver | 021 |

| Brand | Code |
|-----------------------|---------------------------------|
| NORCENT | 048 049 050 |
| NEXT BASE | 052 |
| NEC | 053 |
| NANTAUS | 144 |
| NESA | 074 |
| OPTOMEDIA ELECTRONICS | 105 |
| OPTIVIEW | 072 |
| ONKYO | 076 092 119 |
| PHILCO | 044 045 |
| PRINCETON | 046 047 |
| PROSCAN | 023 |
| PANASONIC | 024 034 124 134 136 137 138 |
| PHILIPS | 036 076 |
| ROTEL | 117 118 |
| RIO | 120 |
| RCA | 023 035 074 075 131 132 |
| RAITE | 073 |
| ROWA | 038 |
| SAMPO | 104 |
| SONY | 026 029 126 127 128 129 130 141 |
| SHERWOOD | 039 041 |
| SVA | 042 |
| SYLVANIA | 043 093 |
| SHARP | 140 |
| SANSUI | 062 |
| SANYO | 062 |
| SHINSONIC | 094 |
| SANYO | 090 |
| THOMSON | 145 |
| TOSHIBA | 028 062 076 |
| TECHNICS | 139 |
| TVIEW | 072 |
| TOKAI | 073 |
| TEAC | 096 |
| TECHWOOD | 097 |
| TREDEX | 098 099 101 |
| URBAN CONCEPTS | 076 |
| VENTURER | 075 |
| VOCOPRO | 102 |
| YAMAHA | 032 063 |
| YAMAKAWA | 040 073 |
| XWAVE | 103 |
| ZENITH | 076 121 |

Setting the Clock

Setting the clock is necessary in order to use the various timer features of the TV. Also, you can check the time while watching the TV. (Just press the INFO button.)

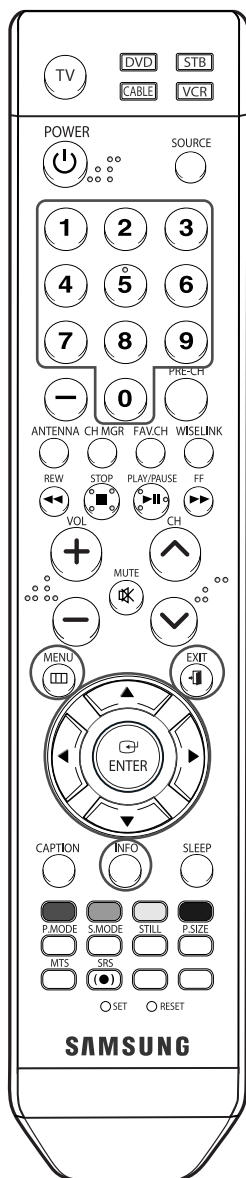

NOTE

- The current time will appear every time you press the INFO button.

Option 1: Setting the Clock Manually

- Press the MENU button. Press the ◀ or ▶ button to select "Setup", then press the ENTER button.
- Press the ▲ or ▼ button to select "Clock", then press the ENTER button.
- Press the ▲ or ▼ to select "Clock Mode", then press the ENTER button. Press ▲ or ▼ to select "Manual", then press the ENTER button.
- Press the ▲ or ▼ button to select "Clock Set", then press the ENTER button.
- Press the ◀ or ▶ button to move to "Month", "Day", "Year", "Hour", "Minute", or "am/pm". Set the time you want by pressing the ▲ or ▼ button, then press the ENTER button. The time set in the Clock Set will appear.

- You can set the month, day, year, hour and minute directly by pressing the number buttons on the remote control.

Select "Return" by pressing the ▲ or ▼ button, then press the ENTER button to return to the previous menu. Press the EXIT button to exit.

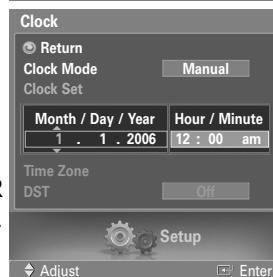
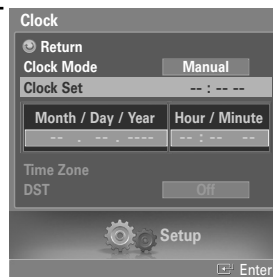
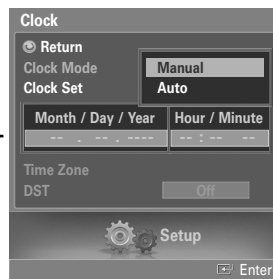
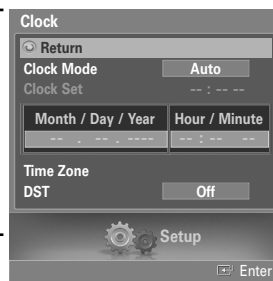

Operation

Option 2: Setting the Clock Automatically

The Clock can be set automatically if you are receiving a digital signal.

1 Press the MENU button.
Press the ◀ or ▶ button to select "Setup", then press the ENTER button.



2 Press the ▲ or ▼ button to select "Clock", then press the ENTER button.

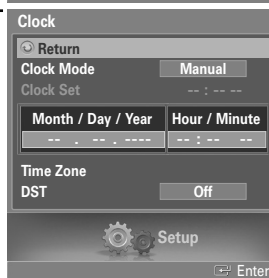

3 Press the ▲ or ▼ button to select "Clock Mode", then press the ENTER button.
Press the ▲ or ▼ button to select "Auto", then press the ENTER button.

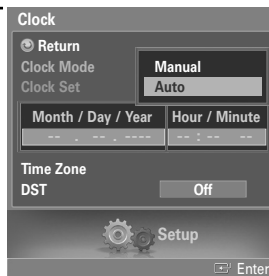

4 Press the ▲ or ▼ button to select "Time Zone", then press the ENTER button.
Press the ▲ or ▼ button to highlight the time zone for your local area (and to move the highlight to the appropriate time zone on the map of the United States), then press the ENTER button.

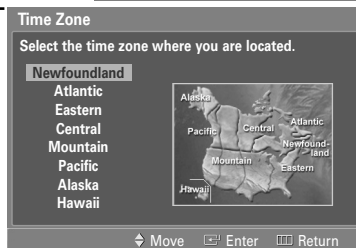

- When you set up Auto Time, the set time may not be correct depending on the broadcasting station and signal. If there is a difference between the real time and set time, please set the time manually.

5 Press the ▲ or ▼ button to select "DST"(Daylight Saving Time), then press the ENTER button.
Press the ▲ or ▼ button to select "Off" or "On", then press the ENTER button.

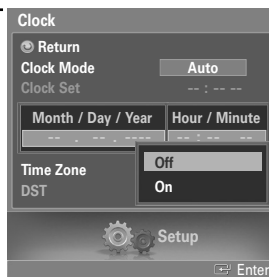

Select "Return" by pressing the ▲ or ▼ button, then press the ENTER button to return to the previous menu.
Press the EXIT button to exit.

Setting the On/Off Timer

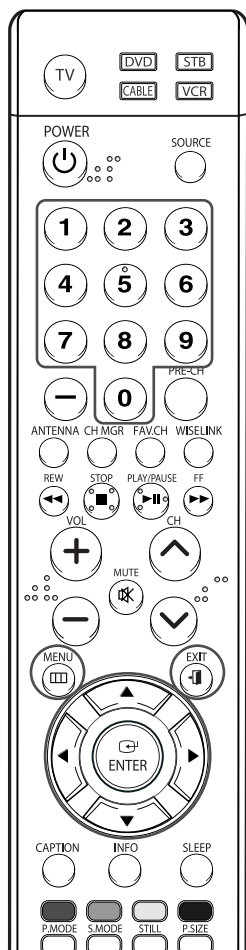

NOTE

• Auto Power Off

When you set the timer "On", the television will eventually turn off, if no controls are operated for 3 hours after the TV was turned on by the timer. This function is only available in timer "On" mode and prevents overheating, which may occur if a TV is on for too long (when you are on vacation, for example).

1 Press the MENU button. Press the ◀ or ▶ button to select "Setup", then press the ENTER button.

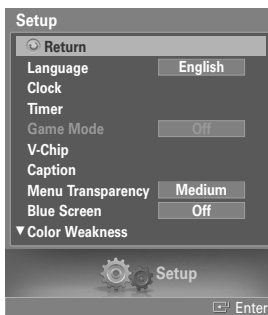

2 Press the ▲ or ▼ button to select "Timer", then press the ENTER button. Press the ▲ or ▼ button to select "On Timer", then press the ENTER button.

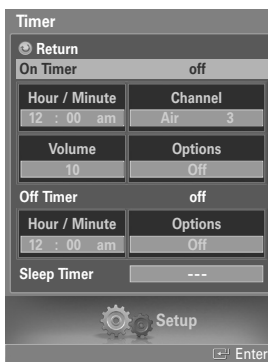

Press the ▲ or ▼ button to adjust "Hour/Minute", then press the ▶ button to move to the next step. Set other items using the same method as above.

To activate On Timer with the setting entered, set Options to "Once, Daily, Mon~Fri, or Mon~Sat" by pressing ▲ or ▼ button. Press the ENTER button.

- You can set the hour, minute, and channel directly by pressing the number buttons on the remote control.

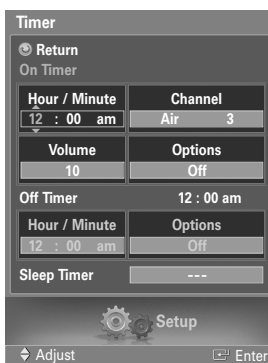

3 Press the ▲ or ▼ button to select "Off Timer", then press the ENTER button. Press the ▲ or ▼ button to adjust "Hour/Minute", then press the ▶ button to move to the next step. Set other items using the same method as above.

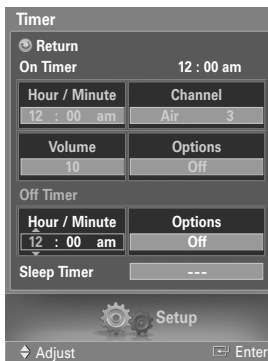

To activate Off Timer with the setting entered, set Options to "Once, Daily, Mon~Fri, or Mon~Sat" by pressing ▲ or ▼ button. Press the ENTER button.

When finished, select "Return" by pressing ▲ or ▼ button and ENTER button to return to the previous menu. Press the EXIT button to exit.

Operation

Setting the Sleep Timer

The sleep timer automatically shuts off the TV after a preset time (from 30 to 180 minutes).

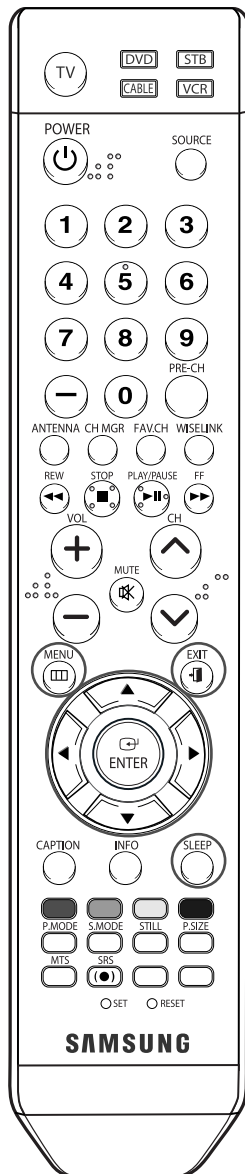

- 1 Press the MENU button.
Press the ◀ or ▶ button to select "Setup", then press the ENTER button.



- 2 Press the ▲ or ▼ button to select "Timer", then press the ENTER button.
Press the ▲ or ▼ button to select "Sleep Timer", then press the ENTER button.

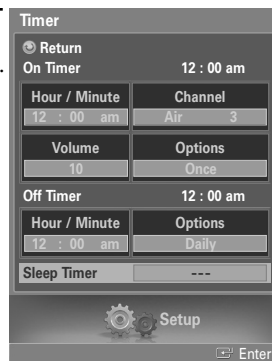

- 3 Press the ▲ or ▼ button to set sleep timer to "--(off), 30 min, 60 min, 90 min, 120 min, 150 min, or 180 min", then press the ENTER button.

Select "Return" by pressing the ▲ or ▼ button, then press the ENTER button to return to the previous menu. Press the EXIT button to exit.

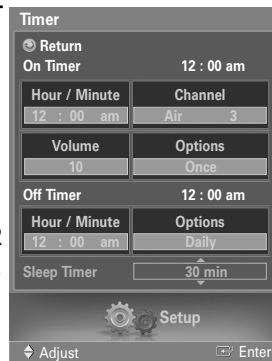

Alternate method

Press the SLEEP button on the remote control repeatedly until the appropriate time interval appears (any of the preset values from "30 min" to "180 min").

Sleep Timer : 90 min

Viewing an External Signal Source

Use the remote control to switch between viewing signals from connected equipment, such as a VCR, DVD, Set-Top Box or the TV source (broadcast or cable).

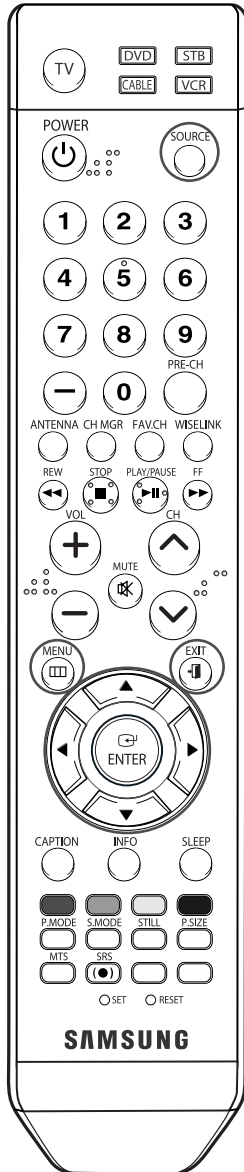

Setting the Signal Source

- 1 Press the MENU button.
Press the ENTER button to select "Input".



- 2 Press the ▲ or ▼ button to select "Source List", then press the ENTER button.
Press the ▲ or ▼ button to select a signal source, then press the ENTER button.

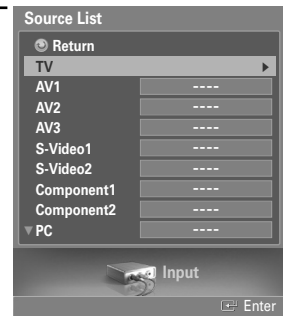

- When you connect equipment to the TV, you can choose between the following sets of jacks: "AV1", "AV2", "S-VIDEO1", "S-VIDEO2", "COMPONENT1", "COMPONENT2", "PC", "HDMI1", or "HDMI2" on the TV's rear panel and "AV3" on the TV's side panel.

Alternate method

Press the SOURCE button on the remote control repeatedly to select an external signal source.



NOTES

- Only connected devices can be selected.
- Before selecting an input source, make sure the corresponding external device is connected first.
- HDMI input can be selected only when the external device is turned on and connected to the TV.

Operation

Assigning Names to External Input Mode

This feature enables you to name the input source you have connected.

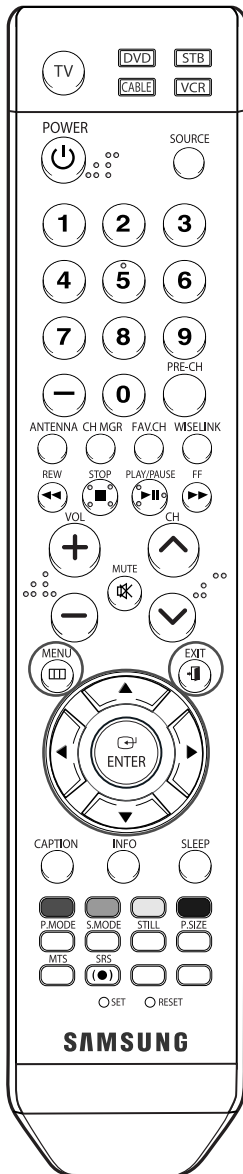

- 1 Press the MENU button.
Press the ENTER button to select "Input".



- 2 Press the ▲ or ▼ button to select "Edit Name", then press the ENTER button.



- 3 Press the ▲ or ▼ button to select a signal source to edit, then press the ENTER button.



- 4 Press the ▲ or ▼ button to select the external device : VCR, DVD, D-VHS, Cable STB, HD STB, Satellite STB, PVR STB, AV Receiver, DVD Receiver, Game, Camcorder, DVD Combo, DVD HDD Recorder, PC, Internet TV Recv., Interactive TV Recv., VOD (Video On Demand) STB, TV.

Press the ENTER button.

Set other signal sources (AV2, AV3, S-Video1, S-Video2, Component1, Component2, PC, HDMI1, HDMI2) using the same method as listed above.

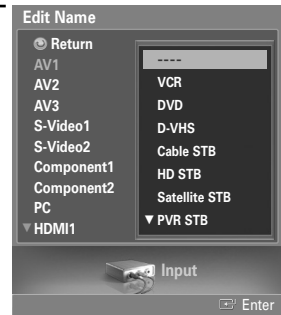

Select "Return" by pressing the ▲ or ▼ button, then press the ENTER button to return to the previous menu.
Press the EXIT button to exit.



Channel Control

Channel Control

Selecting Your Favorite Channels

You can store your favorite channels for each available input source (such as TV and CATV). This allows you to quickly and easily find frequently watched channels by pressing the FAV.CH button on the remote control.

Preset : To use the Channel Manager function, first run Auto Program (see pages 31~32).

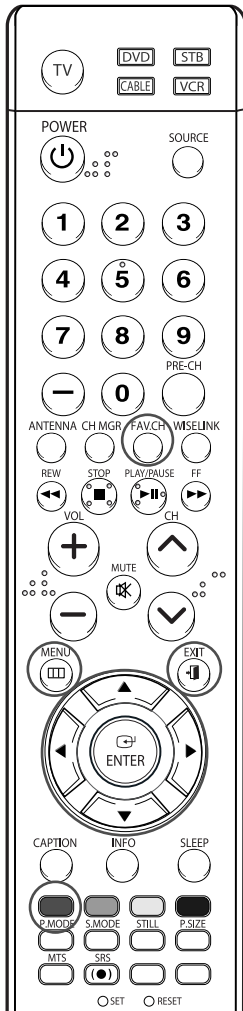

NOTE

- Only memorized channels can be set as Favorite channels.

To Store Your Favorite Channels:

1 Press the MENU button.
Press the ◀ or ▶ button to select "Channel", then press the ENTER button.



2 Press the ▲ or ▼ button to select "Channel Manager", then press the ENTER button.
Press the ▲ or ▼ button to select "All", then press the ENTER button.

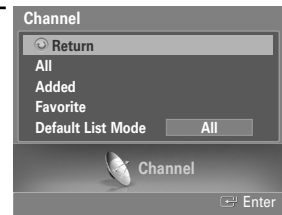

3 Press the ▲/▼/◀/▶ button to select a channel, then press the ENTER button and option window will appear. Press the ▲ or ▼ button to select "Favorite", then press the ENTER button and a ♥ mark, designating the channel as a Favorite Channel will appear. Press the ENTER button again to deselect the selected channel and the ♥ mark will disappear.

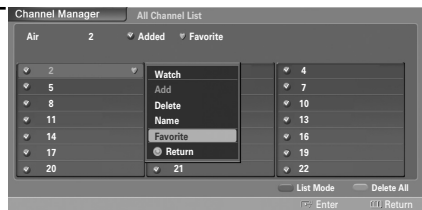

- Red button (List Mode) : If you press the Red button repeatedly, the All Channel List, the Added Channel List or the Favorite Channel List is selected sequentially.

Select "Return" by pressing the ▲ or ▼ button, then press the ENTER button to return to the previous menu.
Press the EXIT button to exit.

To View Your Favorite Channels:

Select Channel menu → Channel Manager → Favorite

Press the FAV.CH button repeatedly to jump from one favorite channel to another.

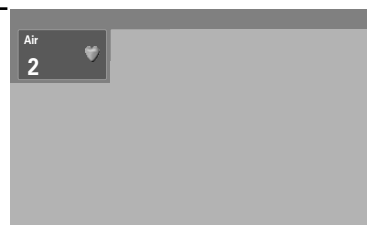

Viewing the Channel Lists

You can display a list of all channels, added channels, or your favorite channels.

Preset : To use the Channel Manager function, first run Auto Program (see pages 31~32).

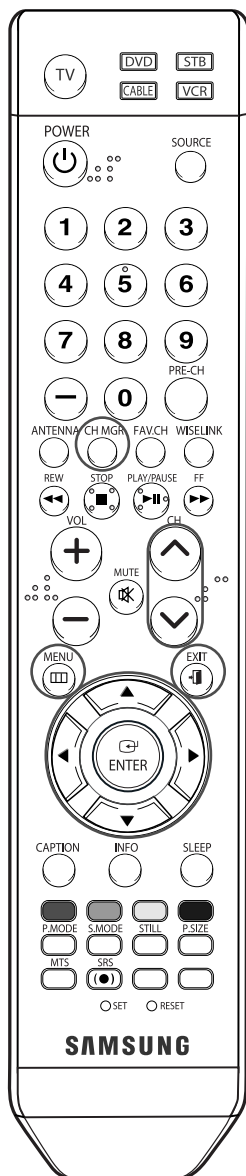

1 Press the MENU button.
Press the ◀ or ▶ button to select "Channel", then press the ENTER button.

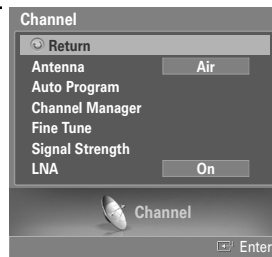

2 Press the ▲ or ▼ button to select "Channel Manager", then press the ENTER button.
Press the ▲ or ▼ button to select "All", then press the ENTER button.

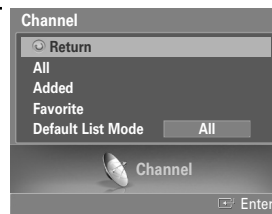

3 If you want to watch the channel, press the ▲/▼/◀/▶ buttons to select a channel, then press the ENTER button and the option window will appear.



4 Press the ENTER button to select "Watch", then press the ENTER button again.
The selected channel broadcasting window will appear.

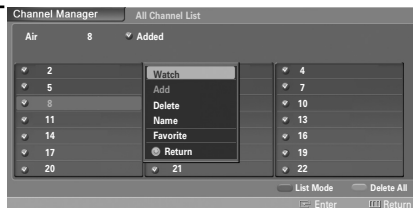

Alternate method

Press the CH MGR button on the remote control to display a list of channels.

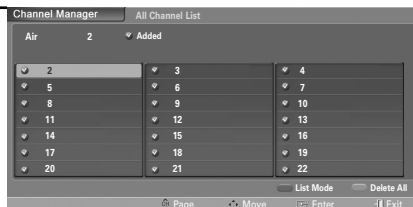

Channel Control

Adding and Erasing Channels

Preset : To use the Channel Manager function, first run Auto Program (See pages 31~32).

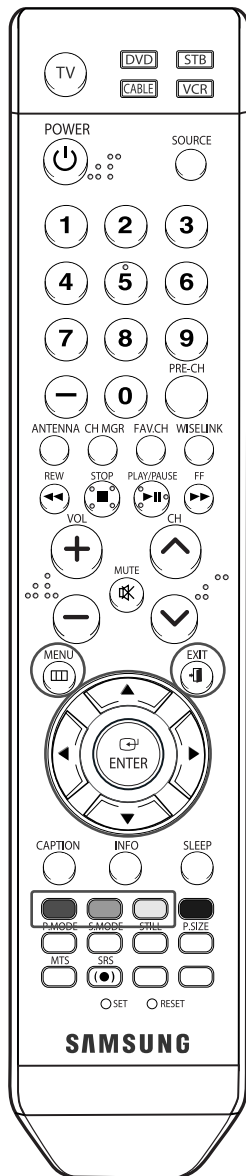

- 1 Press the MENU button.
Press the ◀ or ▶ button to select "Channel", then press the ENTER button.



- 2 Press the ▲ or ▼ button to select "Channel Manager", then press the ENTER button.
Press the ▲ or ▼ button to select "Added", then press the ENTER button.

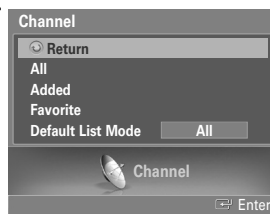

- 3 Press the ▲/▼/◀/▶ button to select a channel, then press the ENTER button and option window will appear.
Press the ▲ or ▼ button to select "Add", then press the ENTER button; the ● mark will appear and the channel will be added.
To deselect the selected channel, select "Delete" by pressing the ▲ or ▼ button. The ● mark will disappear.

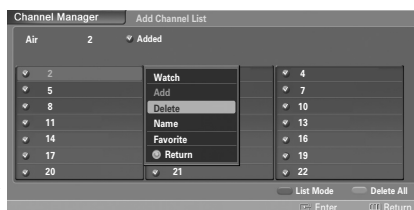
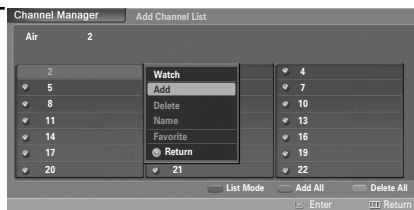

- Red button (List Mode) : If you press the Red button repeatedly, the All Channel List, the Added Channel List or the Favorite Channel List is selected sequentially.
- Green button (Add All) : Press to add all channels of the channel list.
- Yellow button (Delete All) : Press to delete all channels of the channel list.

Select "Return" by pressing the ▲ or ▼ button, then press the ENTER button to return to the previous menu.
Press the EXIT button to exit.

Labeling the Channels

Use this feature to assign an easy-to-remember label to analog channels (i.e., "CBS", "ESPN", "PBS2", "CNN02", etc.) A label consists of five fields, where each field is a letter, a number or a blank. When the INFO button is pressed, the channel label will appear.

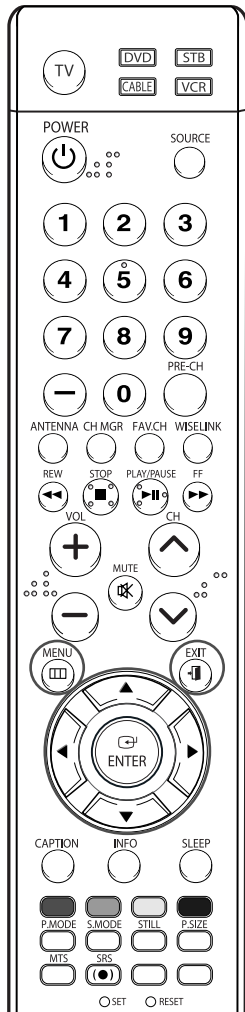

NOTE

- If you add or delete a TV channel, the channel label (if set) will also be added or deleted.

1 Press the MENU button. Press the ◀ or ▶ button to select "Channel", then press the ENTER button.



2 Press the ▲ or ▼ button to select "Channel Manager", then press the ENTER button. Press the ▲ or ▼ button to select "All", then press the ENTER button.



3 Press the ▲/▼/◀/▶ button to select a channel, then press the ENTER button and option window will appear. Press the ▲ or ▼ button to select "Name", then press the ENTER button.

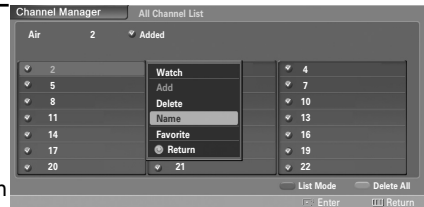

4 Press the ▲ or ▼ button to select a letter, a number or a blank. (Results in this sequence: A...Z, 0...9, +, -, *, /, blank).

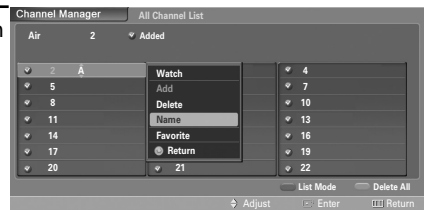

5 Press the ◀ or ▶ button to switch to the next field, which will be selected. Select a second letter or digit by pressing ▲ or ▼ button, as above.

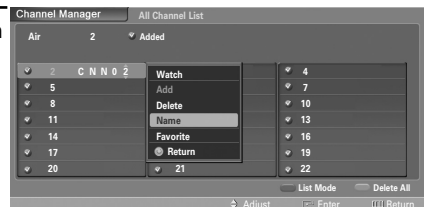

Repeat the process to select the last three digits. To erase the assigned new name, press and hold the ▲ or ▼ button until a blank appears.

When you have finished, press the MENU button. Select "Return" by pressing the ▲ or ▼ button, then press the ENTER button to return to the previous menu. Press the EXIT button to exit.

Channel Control

Fine Tuning Analog Channels **Analog**

Use fine tuning to manually adjust a particular channel for optimal reception.

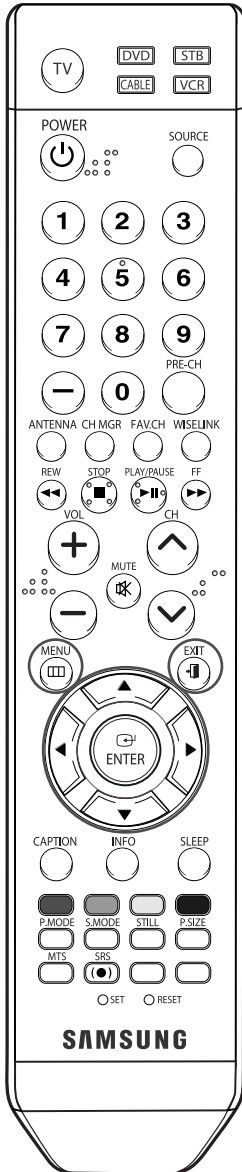

- 1 Press the MENU button. Press the ◀ or ▶ button to select "Channel", then press the ENTER button.



- 2 Press the ▲ or ▼ button to select "Fine Tune", then press the ENTER button.

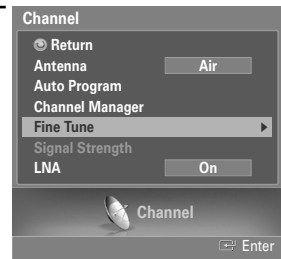

- 3 Press the ▼ button. Press the ◀ or ▶ button to adjust the fine tuning. To store the fine tuning setting in the TV's memory, press the ENTER button.



- 4 To reset the fine tuning setting, press the ▼ button to select "Reset", then press the ENTER button.

Select "Return" by pressing the ▲ or ▼ button, then press the ENTER button to return to the previous menu. Press the EXIT button to exit.



NOTES

- Only analog TV channels can be fine tuned.
- "*" will appear next to the name of fine-tuned channels.

Checking the Digital-Signal Strength Digital

Unlike analog channels, which can vary in reception quality from “snowy” to clear, digital (HDTV) channels have either perfect reception quality or you will not receive them at all. So, unlike analog channels, you cannot fine tune a digital channel.

You can, however, adjust your antenna to improve the reception of available digital channels.

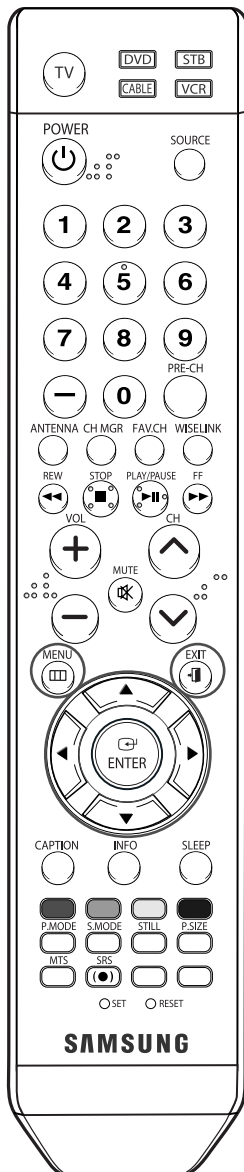

- 1 Press the MENU button.
Press the ◀ or ▶ button to select “Channel”, then press the ENTER button.



- 2 Press the ▲ or ▼ button to select “Signal Strength”, then press the ENTER button.

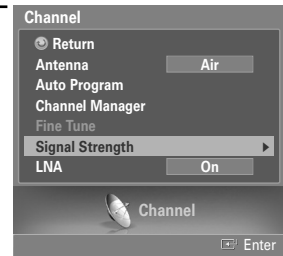

If the signal strength meter indicates that the signal is weak, physically adjust your antenna to increase the signal strength. Continue to adjust the antenna until you find the best position with the strongest signal.

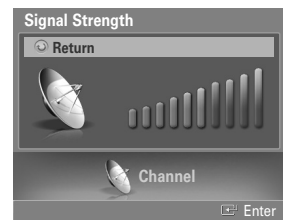

Select “Return” by pressing the ENTER button to return to the previous menu. Press the EXIT button to exit.

Channel Control

LNA (Low Noise Amplifier)

If the TV is operating in a weak-signal area, sometimes the LNA function can improve the reception (a low-noise preamplifier boosts the incoming signal).

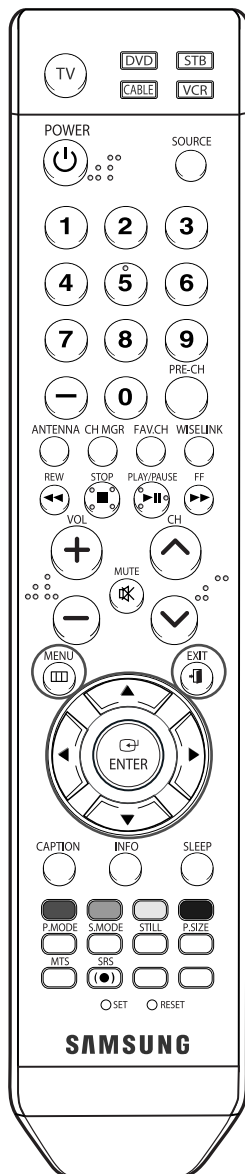

- 1 Press the MENU button.
Press the ◀ or ▶ button to select "Channel", then press the ENTER button.



- 2 Press the ▲ or ▼ button to select "LNA", then press the ENTER button.



- 3 Press the ▲ or ▼ button to select "Off" or "On", then press the ENTER button.

Select "Return" by pressing the ▲ or ▼ button, then press the ENTER button to return to the previous menu. Press the EXIT button to exit.



NOTES

- LNA functions only when antenna is set to Air.
The LNA setting must be made separately for each channel.
- If the picture is noisy with the LNA set to On, select Off.



Picture Control



Picture Control

Picture Control

You can select the type of picture which best corresponds to your viewing requirements.

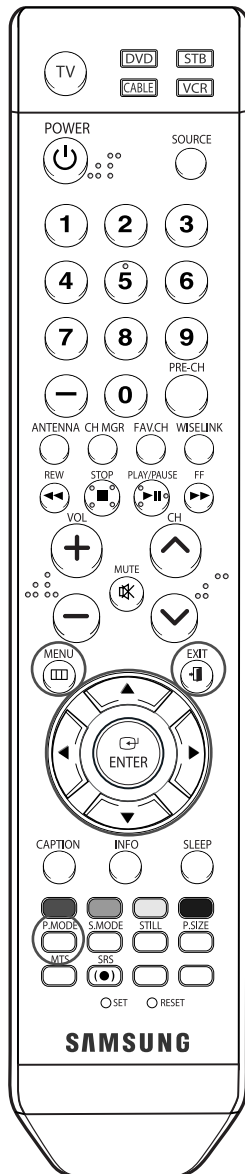

Changing the Picture Standard

1 Press the MENU button.
Press the ◀ or ▶ button to select "Picture", then press the ENTER button.



2 Press the ▲ or ▼ button to select "Mode", then press the ENTER button.
Press the ▲ or ▼ button again to select "Mode", then press the ENTER button.



3 Press the ▲ or ▼ button to select the desired picture mode (Dynamic, Standard, Movie, or Custom), then press the ENTER button.

Select "Return" by pressing the ▲ or ▼ button, then press the ENTER button to return to the previous menu. Press the EXIT button to exit.

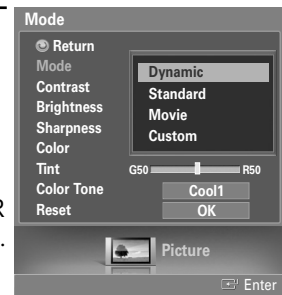

Alternate method

Press the P.MODE button on the remote control repeatedly to select the desired picture mode.

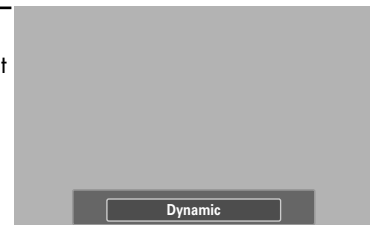

- Choose "Dynamic" for viewing the TV during the day or when there is a bright light in the room.
- Choose "Standard" for general TV watching mode.
- Choose "Movie" when viewing the movie.
- Choose "Custom" if you want to adjust the settings according to personal preference (see "Customizing the Picture Settings", page 57).

Customizing the Picture Settings

You can use the on-screen menus to change the "Contrast", "Brightness", "Sharpness", "Color", "Tint", and "Color Tone" according to personal preference. You can select "Standard" which automatically recalls your personalized picture settings.

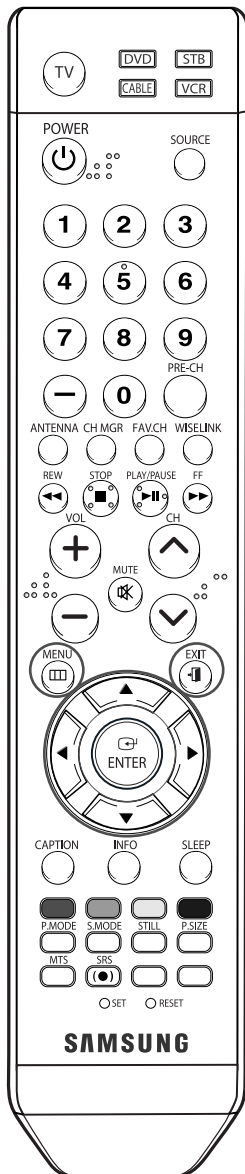

NOTE

- In PC mode, the Contrast and Brightness can be selected.

1 Press the MENU button.
Press the ◀ or ▶ button to select "Picture", then press the ENTER button.



2 Press the ▲ or ▼ button to select "Mode", then press the ENTER button.
Press the ▲ or ▼ button again to select "Mode", then press the ENTER button.

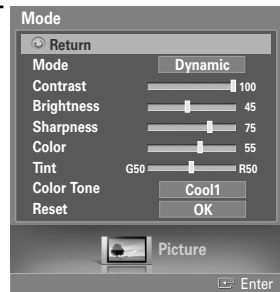

3 Press the ▲ or ▼ button to select the desired picture mode (Dynamic, Standard, Movie, or Custom), then press the ENTER button.

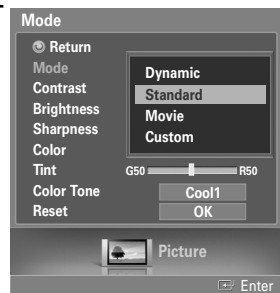

4 Press the ▲ or ▼ button to select a particular option (Contrast, Brightness, Sharpness, Color, or Tint), then press the ENTER button.

Press the ◀ or ▶ button to decrease or increase the value of a particular item.

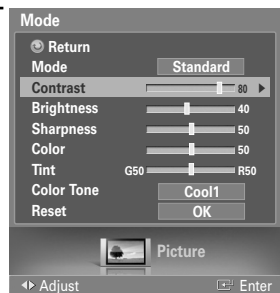

- While adjusting a picture option, you can also select another option (Contrast, Brightness, Sharpness, Color, or Tint) by pressing the ▲ or ▼ button.



Continued...

Picture Control

- 5 Press the ENTER button to return to "Mode".
Press the ▲ or ▼ button to select "Color Tone", then press the ENTER button.

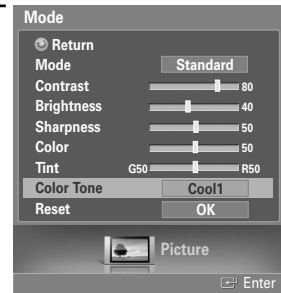

- 6 Press the ▲ or ▼ button to select a particular item (Cool2, Cool1, Normal, Warm1, or Warm2), then press the ENTER button.

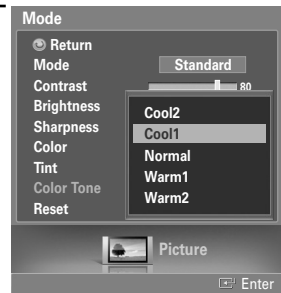

Resetting the Picture Settings to the Factory Defaults

- 7 To return the factory defaults, select "Reset" by pressing the ▲ or ▼ button. Press the ENTER button.
Press the ▲ or ▼ button to select "OK" or "Cancel", then press the ENTER button.

Select "Return" by pressing the ▲ or ▼ button, then press the ENTER button to return to the previous menu.
Press the EXIT button to exit.

- If you set "Reset" to "OK", the previously adjusted settings will be reset to the factory defaults.



NOTE

- The reset function must be set separately for each mode (Dynamic, Standard, Movie, or Custom).

Changing the Picture Size

You can select the picture size which best corresponds to your viewing requirements.

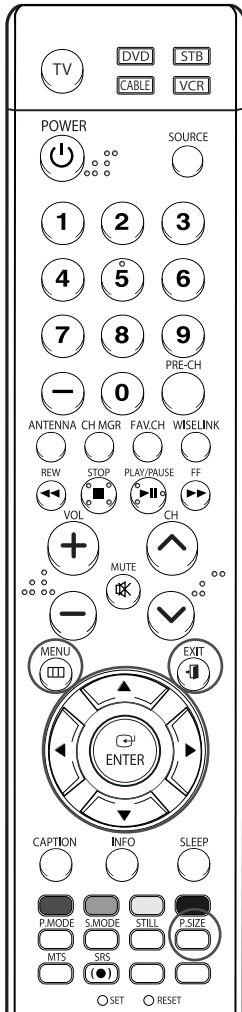

1 Press the MENU button.
Press the ◀ or ▶ button to select "Picture", then press the ENTER button.
Press the ▲ or ▼ button to select "Size", then press the ENTER button.

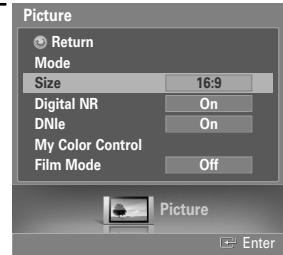

2 Press the ▲ or ▼ button to select the screen format you want, then press the ENTER button.

Select "Return" by pressing the ▲ or ▼ button, then press the ENTER button to return to the previous menu. Press the EXIT button to exit.



Alternate method

Press the P.SIZE button on the remote control repeatedly to select one of the picture size settings.

- "16:9": Sets the picture to 16:9 wide mode.
- "Zoom1": Magnifies the size of the picture on screen. Press the ▲ or ▼ button to move the picture.
- "Zoom2": Magnifies the size of the picture more than "Zoom1".
- "Wide Fit": Enlarges the aspect ratio of the picture to fit the entire screen.
- "4:3": Sets the picture to 4:3 normal mode.



NOTES

- You can select the 16:9, 4:3 and Wide Fit screen sizes in the DTV, Component (720p, 1080i) or HDMI (720p, 1080i) mode.
- For Zoom1, Zoom2, and Wide Fit (DTV's HD signal only), you can adjust the vertical position using the ▲ or ▼ button after pressing the P.SIZE button on the remote control.
- When watching a DTV's HD signal, you can use Wide Fit.

Horizontal zoom(Wide Fit) sets the optical picture format by expanding it both horizontally and vertically.

For example, you can reset the picture in 4:3 format to 16:9.

Wide Fit does not support all external devices.

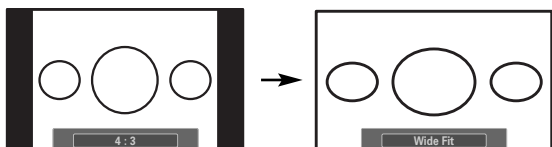

Picture Control

Digital Noise Reduction

If the broadcast signal received by your TV is weak, you can activate the Digital Noise Reduction feature to help reduce any static and ghosting that may appear on the screen.

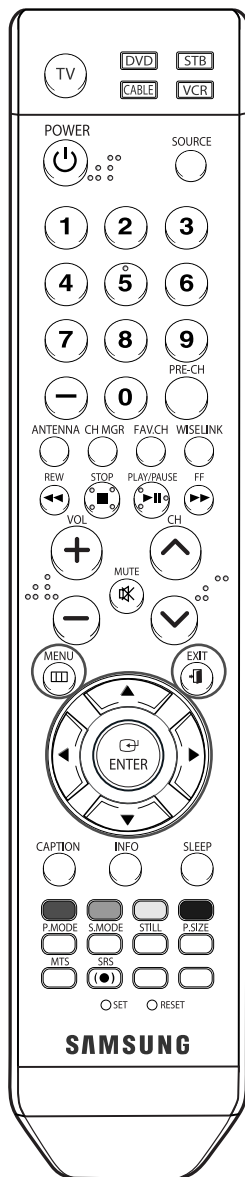

1 Press the MENU button.
Press the ◀ or ▶ button to select "Picture", then press the ENTER button.

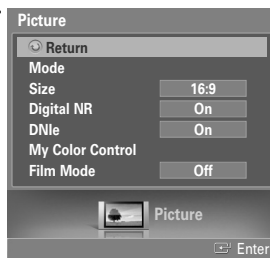

2 Press the ▲ or ▼ button to select "Digital NR", then press the ENTER button.



3 Press the ▲ or ▼ button to select "Off" or "On", then press the ENTER button.

Select "Return" by pressing the ▲ or ▼ button, then press the ENTER button to return to the previous menu. Press the EXIT button to exit.

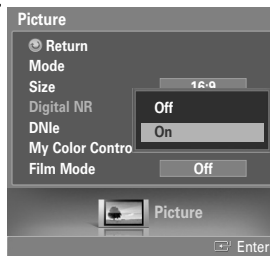

DNle (Digital Natural Image engine)

This TV includes the DNle function so as to provide a high visual quality. If you set DNle to on, you can view the screen with the DNle feature activated. If you set the DNle to Demo, you can view the applied DNle and normal pictures on the screen, for demonstration purposes. Using this function, you can view the difference in the visual quality.

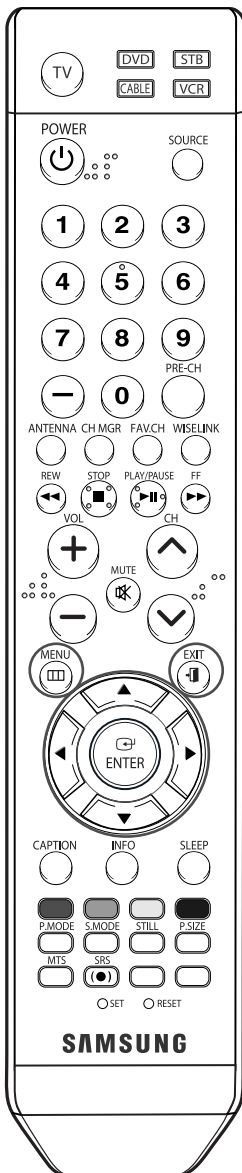

1 Press the MENU button.
Press the ◀ or ▶ button to select "Picture", then press the ENTER button.



2 Press the ▲ or ▼ button to select "DNle", then press the ENTER button.

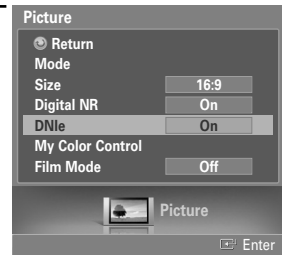

3 Press the ▲ or ▼ button to select "Off", "Demo" or "On", then press the ENTER button.

- Off : Switches off the DNle mode.
- Demo : The screen before applying DNle appears on the left and the screen after applying DNle appears on the right.
- On : Switches on the DNle mode.

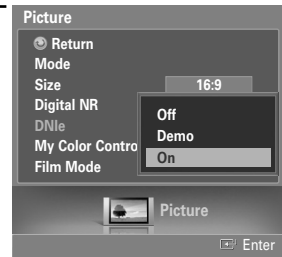

Select "Return" by pressing the ▲ or ▼ button, then press the ENTER button to return to the previous menu. Press the EXIT button to exit.

NOTES

- DNle™ (Digital Natural Image engine) **DNle™**
This feature brings you a more detailed image with 3D noise reduction and detail, contrast and white enhancement.

Picture Control

Setting the My Color Control Mode

My Color Control allows you to adjust colors according to your preference, by adjusting skin, sky, and grass tones using the predefined settings (Red, Green, Blue, Yellow, Pink, Standard, and Custom) without affecting other colors on the screen.

Using the My Color Control Function in the Easy Control Menu

Skin, sky and grass tones are easily adjustable to suit your preferences.

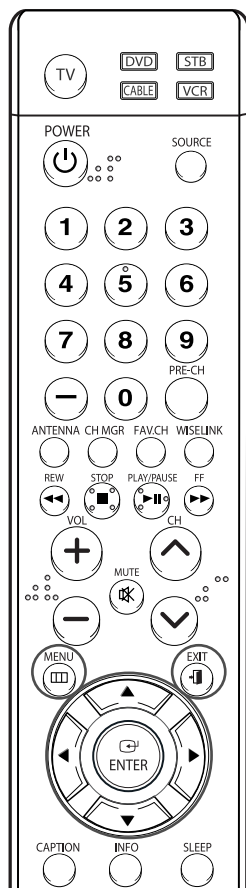

NOTES

- Changing the settings in the "Detail Control" menu (see page 63) will automatically set the My Color Control mode to "Custom".
- Pressing the ENTER button on the remote control for 3 seconds when there is no OSD on the screen will display the My Color Control menu.

1 Press the MENU button.
Press the ◀ or ▶ button to select "Picture", then press the ENTER button.



2 Press the ▲ or ▼ button to select "My Color Control", then press the ENTER button.



3 Press the ▲ or ▼ button to select "Easy Control", then press the ENTER button.

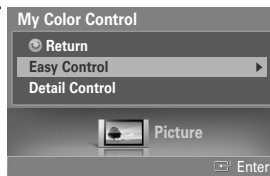

4 Press the ◀ or ▶ button to select the setting among the various picture settings. The original picture (before adjustment) is shown on the left side, while the selected mode is shown on the right side.

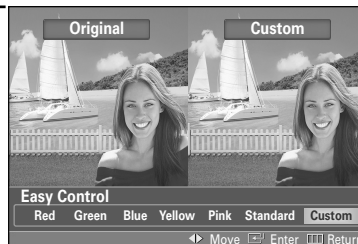

- There are seven My Color Control modes: Red, Green, Blue, Yellow, Pink, Standard, and Custom.

Select "Return" by pressing the ▲ or ▼ button, then press the ENTER button to return to the previous menu. Press the EXIT button to exit.

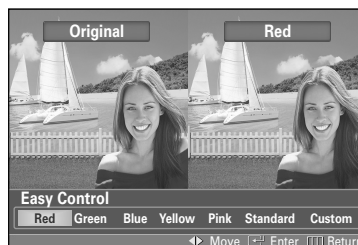

My Color Control Custom Settings

Users can adjust the 5 My Color Control colors (Red, Green, Blue, Yellow, and Pink).

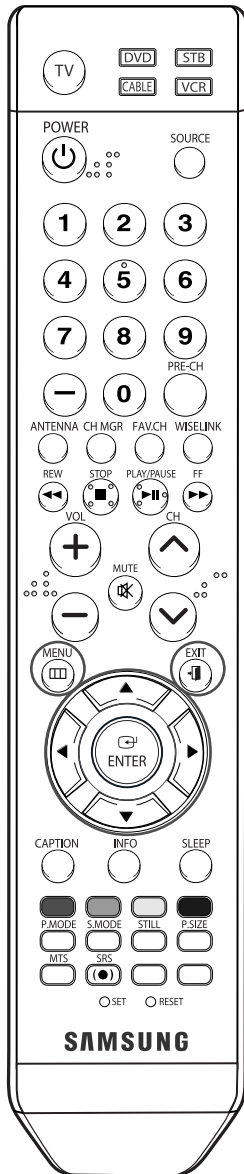

1 Press the MENU button.
Press the ◀ or ▶ button to select "Picture", then press the ENTER button.



2 Press the ▲ or ▼ button to select "My Color Control", then press the ENTER button.



3 Press the ▲ or ▼ button to select "Detail Control", then press the ENTER button.

4 Press the ▲ or ▼ button to select the desired color and then press the ENTER or ▶ button.

- The original picture (before adjustment) is shown on the left side, while the picture after adjustment is shown on the right side, and an adjustment bar is shown on the bottom of the screen.

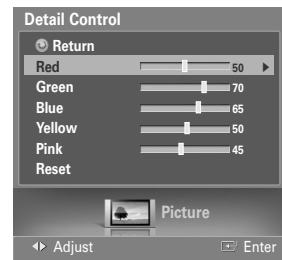

5 Press the ◀ or ▶ button to adjust the settings.
Press the ▲ or ▼ button to choose other colors.



6 Press the ENTER or MENU button to confirm the changes and return to the previous menu.

Resetting the My Color Control Colors to the Factory Defaults

You can return to the factory default settings for My Color Control colors.

7 Press the ▲ or ▼ button to select "Reset", then press the ENTER button.

The previously adjusted My Color Control colors will be reset to the factory defaults.

Select Return by pressing the ▲ or ▼ button then press the ENTER button to return to previous menu.
Press the EXIT button to exit.

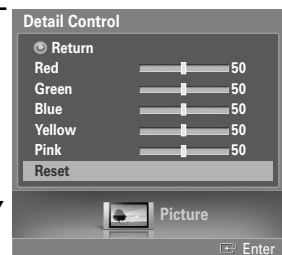

Picture Control

Using the Color Weakness Enhancement Feature

This feature adjusts the Red, Green or Blue color to compensate for the user's particular color weakness.

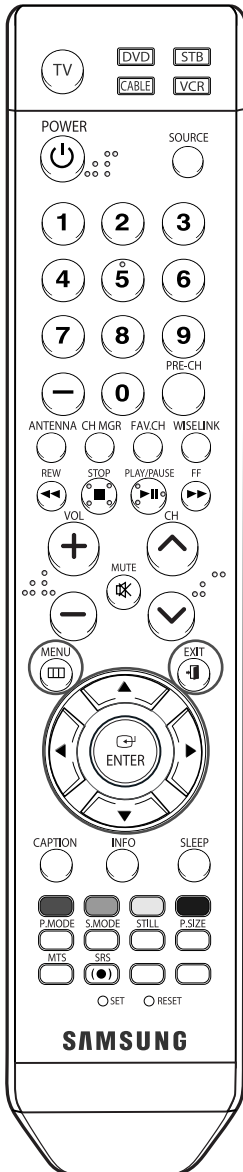

1 Press the MENU button.
Press the ◀ or ▶ button to select "Setup", then press the ENTER button.

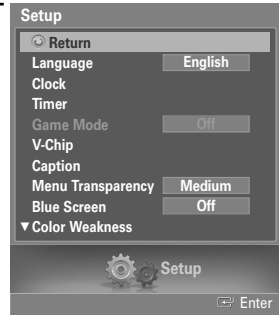

2 Press the ▲ or ▼ button to select "Color Weakness", then press the ENTER button.



3 Press the ▲ or ▼ button to select "Color Weakness", then press the ENTER button.
Press the ▲ or ▼ button to select "On", then press the ENTER button.



4 Press the ▲ or ▼ button to select a color to be adjusted, then press the ENTER button.

Press the ◀ or ▶ button to adjust the value of the color selected.

- You can also select these options (Red, Green or Blue) by pressing the ▲ or ▼ button.



Select "Return" by pressing the ▲ or ▼ button, then press the ENTER button to return to the previous menu.
Press the EXIT button to exit.

Setting the Film Mode

You can automatically sense and process film signals and adjust the picture for optimum quality.

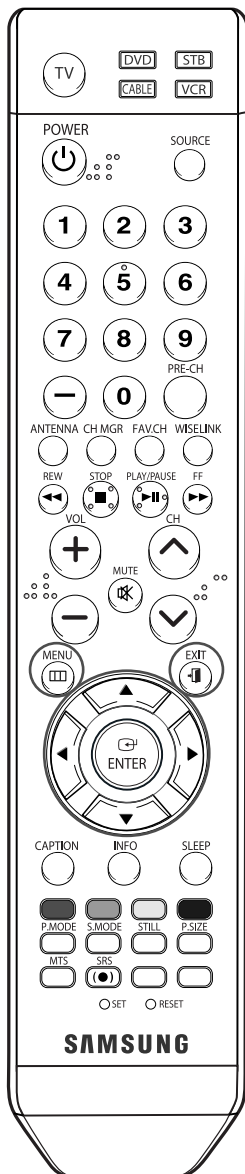

1 Press the MENU button.
Press the ◀ or ▶ button to select "Picture", then press the ENTER button.



2 Press the ▲ or ▼ button to select "Film Mode", then press the ENTER button.

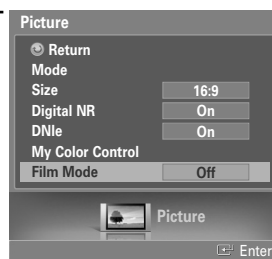

3 Press the ▲ or ▼ button to select "Off" or "On", then press the ENTER button.

Select "Return" by pressing the ▲ or ▼ button, then press the ENTER button to return to the previous menu. Press the EXIT button to exit.

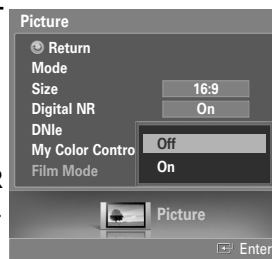

NOTE

- The Film Mode can only be set in AV modes (AV, S-Video, or Component) that support SD (Standard Definition) signals (480i) in analog TV mode.

Picture Control

Freezing the Picture

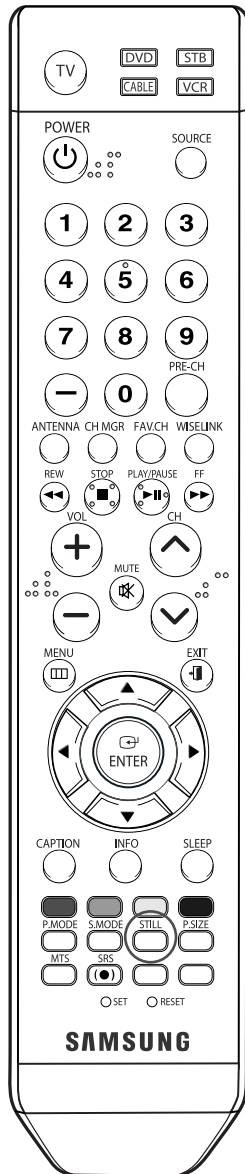

Press the STILL button to freeze a moving picture. (Normal sound will still be heard.)

To cancel this function, press the STILL button again or press any button on the remote control.

Setting the Blue Screen Mode

If no signal is being received or the signal is very weak, a blue screen automatically replaces the noisy picture background. If you wish to continue viewing the poor picture, you must set the "Blue Screen" mode to "Off".

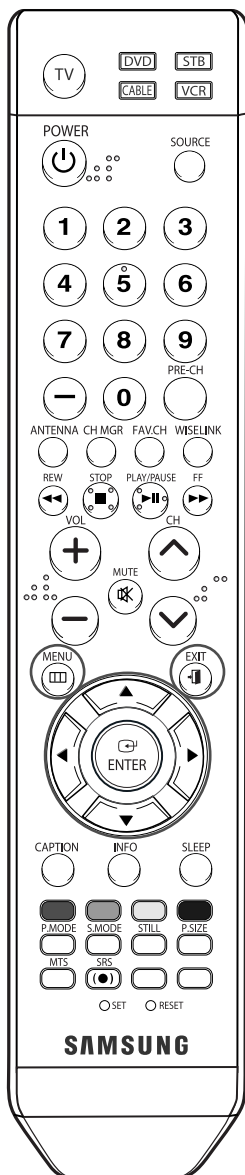

1 Press the MENU button.
Press the ◀ or ▶ button to select "Setup", then press the ENTER button.



2 Press the ▲ or ▼ button to select "Blue Screen", then press the ENTER button.



3 Press the ▲ or ▼ button to select "Off" or "On", then press the ENTER button.

Select "Return" by pressing the ▲ or ▼ button, then press the ENTER button to return to the previous menu. Press the EXIT button to exit.

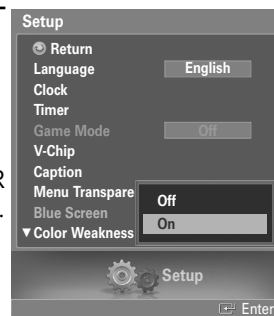

SAMSUNG



Sound Control



Sound Control

Sound Control

You can control and customize the sound levels and settings of the TV with the remote control.

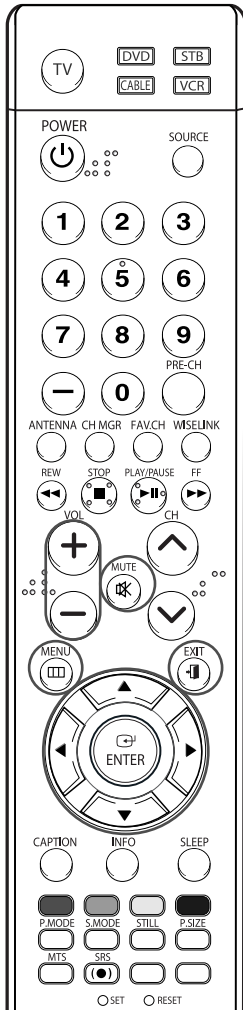

NOTE

- The VOL+, VOL– and MUTE buttons do not operate when the Internal Mute is set to on.

Adjusting the Volume

Press the VOL+ or VOL– button to increase or decrease the volume.

Using the MUTE Button

At any time, you can temporarily cut off the sound. Press the MUTE button on the remote control. The message “Mute” is displayed and the sound cuts off.

To turn mute off, press the MUTE button again or press either the VOL+ or VOL– button.

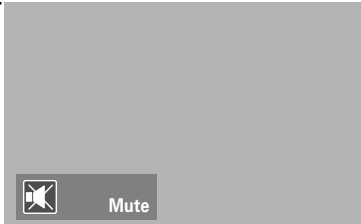

Using Automatic Sound Settings

Your TV has automatic sound settings (“Standard”, “Music”, “Movie”, and “Speech”) that are preset at the factory. You can select “Custom”, which automatically recalls your personalized sound settings.

1 Press the MENU button. Press the ◀ or ▶ button to select “Sound”, then press the ENTER button.



2 Press the ▲ or ▼ button to select “Mode”, then press the ENTER button.

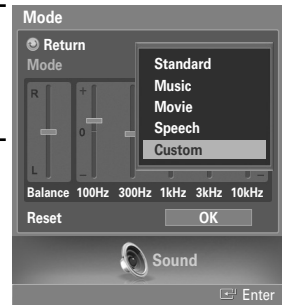

3 Press the ▲ or ▼ button to select a particular item (Standard, Music, Movie, Speech, Custom), then press the ENTER button.

Select “Return” by pressing the ▲ or ▼ button, then press the ENTER button to return to the previous menu. Press the EXIT button to exit.

- Choose “Standard” for the standard factory settings.
- Choose “Music” when watching music videos or concerts.
- Choose “Movie” when watching movies.
- Choose “Speech” when watching a show that is mostly dialog (i.e., news).
- Choose “Custom” to recall your personalized settings (see “Customizing the Sound”, page 71).

Customizing the Sound

The sound settings can be adjusted to suit your personal preference. (Alternatively, you can use one of the automatic settings. See next page.)

- 1 Press the MENU button.
Press the ◀ or ▶ button to select "Sound", then press the ENTER button.



- 2 Press the ▲ or ▼ button to select "Mode", then press the ENTER button. Press the ▲ or ▼ button to select a particular item (Standard, Music, Movie, Speech, Custom), then press the ENTER button.

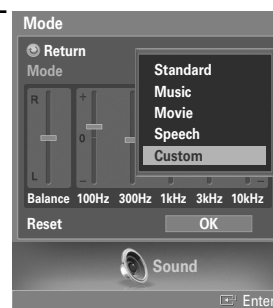

- 3 Press the ▼ button. Press the ◀ or ▶ button to select a particular item (Balance, 100Hz, 300Hz, 1kHz, 3kHz, 10kHz) to be changed, then press the ENTER button.
Press the ▲ or ▼ button to increase or decrease the selected frequency. Press the ENTER button.

- The equalizer function is set for each mode (Standard, Music, Movie, Speech, or Custom).

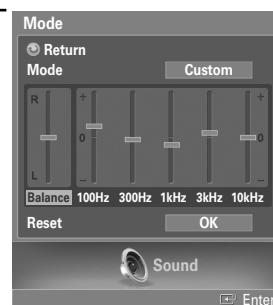

- 4 To return the factory defaults, select "Reset" by pressing the ▲ or ▼ button. Press the ENTER button.
Press the ▲ or ▼ button to select "OK" or "Cancel", then press the ENTER button.

Select "Return" by pressing the ▲ or ▼ button, then press the ENTER button to return to the previous menu.
Press the EXIT button to exit.

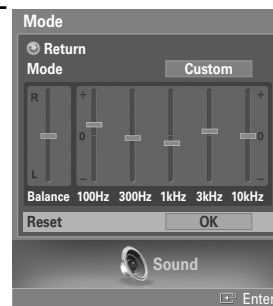

Alternate method

Press the S.MODE button on the remote control repeatedly to select one of the standard sound settings.

NOTES

- **L/R Sound Balance Adjustment**
To adjust the sound balance of the L/R speakers.
- **Bandwidth Adjustment (100Hz, 300Hz, 1kHz, 3kHz, 10kHz)**
To adjust the level of different bandwidth frequencies.

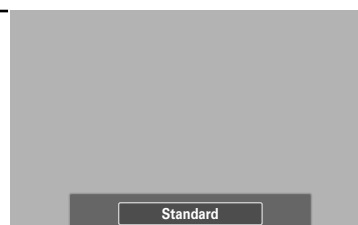

Sound Control

Setting the SRS TSXT

TruSurround XT is a patented SRS technology that solves the problem of playing 5.1 multichannel content over two speakers. Trusurround delivers a compelling, virtual surround sound experience through any two-speaker playback system, including internal television speakers. It is fully compatible with all multichannel formats.

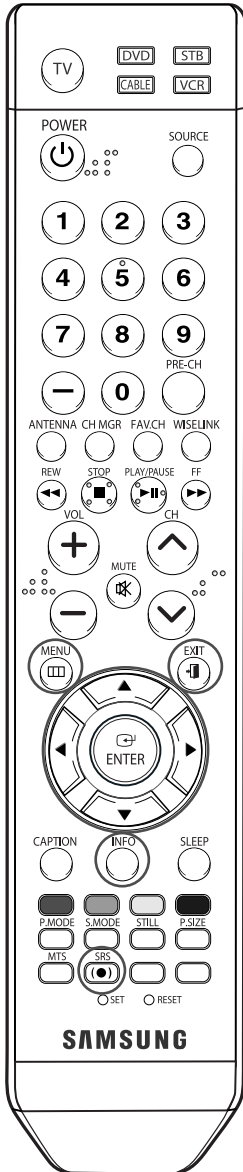

- 1 Press the MENU button.
Press the ◀ or ▶ button to select "Sound", then press the ENTER button.



- 2 Press the ▲ or ▼ button to select "SRS TSXT", then press the ENTER button.



- 3 Press the ▲ or ▼ button to select "Off" or "On", then press the ENTER button.

Select "Return" by pressing the ▲ or ▼ button, then press the ENTER button to return to the previous menu. Press the EXIT button to exit.

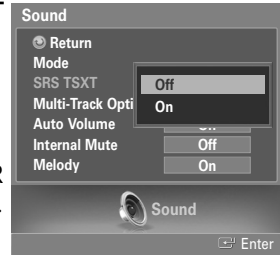

Alternate method

Press the SRS button on the remote control repeatedly to select "Off" or "On".

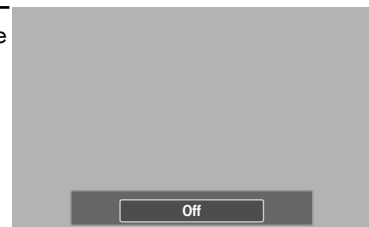

Auto Volume

Each broadcasting station has its own signal conditions, and it is inconvenient to adjust the volume every time the channel is changed. "Auto Volume" automatically adjusts the volume of the desired channel by lowering the sound output when the volume is high or by raising the sound output when the volume is low.

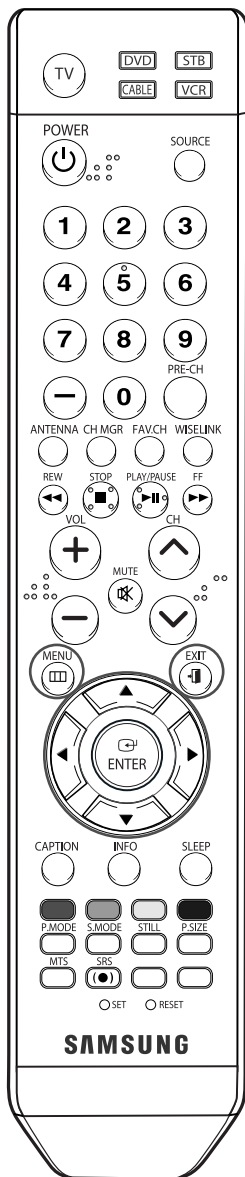

1 Press the MENU button.
Press the ◀ or ▶ button to select "Sound", then press the ENTER button.



2 Press the ▲ or ▼ button to select "Auto Volume", then press the ENTER button.



3 Press the ▲ or ▼ button to select "Off" or "On", then press the ENTER button.

Select "Return" by pressing the ▲ or ▼ button, then press the ENTER button to return to the previous menu. Press the EXIT button to exit.



Sound Control

Choosing a Multi-Channel Sound (MTS) track Digital

The digital-TV transmission system is capable of simultaneous transmission of many audio tracks (for example, simultaneous translations of the program into foreign languages). The availability of these additional "multitracks" depends upon the program.

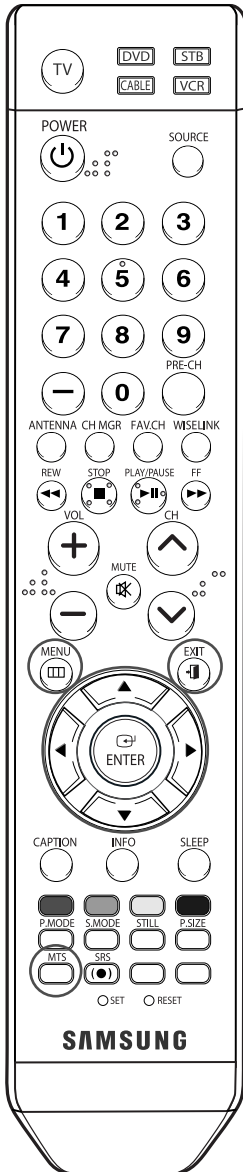

- 1 Press the MENU button.
Press the ◀ or ▶ button to select "Sound", then press the ENTER button.



- 2 Press the ▲ or ▼ button to select "Multi-Track Options", then press the ENTER button.

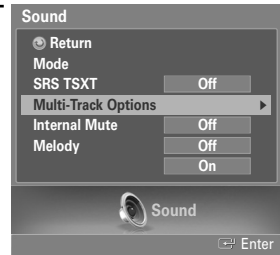

- 3 Press the ▲ or ▼ button to select "Preferred Language", then press the ENTER button.
Press the ▲ or ▼ button to select the language (English, Spanish or French) you want, then press the ENTER button.



Select "Return" by pressing the ▲ or ▼ button, then press the ENTER button to return to the previous menu.
Press the EXIT button to exit.

Alternate method

Press the MTS button on the remote control.
You can listen in a language other than the favorite language by pressing the MTS button.



Choosing a Multi-Channel Sound (MTS) track **Analog**

Depending on the particular program being broadcast, you can listen to Mono, Stereo or SAP.

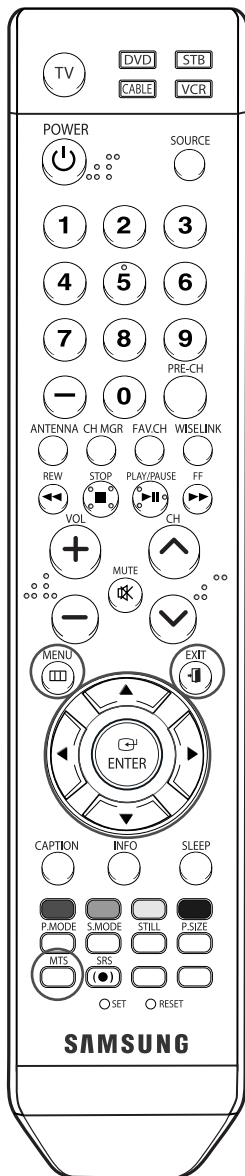

- 1 Press the MENU button.
Press the ◀ or ▶ button to select "Sound", then press the ENTER button.

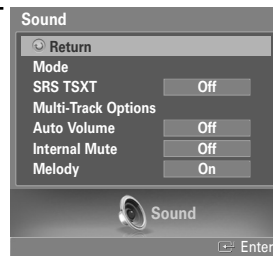

- 2 Press the ▲ or ▼ button to select "Multi-Track Options", then press the ENTER button.

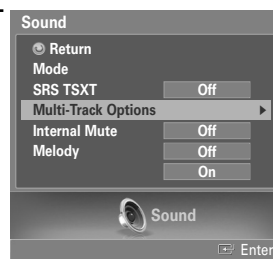

- 3 Press the ▲ or ▼ button to select "Multi-Track Sound", then press the ENTER button.
Press the ▲ or ▼ button to select a setting you want, then press the ENTER button.



Select "Return" by pressing the ▲ or ▼ button, then press the ENTER button to return to the previous menu.
Press the EXIT button to exit.

Alternate method

Press the MTS button on the remote control repeatedly to select a Multi-Channel Sound track.



NOTES

- Choose "Mono" for channels that are broadcasting in mono, or if you are having difficulty receiving a stereo signal.
- Choose "Stereo" for channels that are broadcasting in stereo.
- Choose "SAP" to listen to the Separate Audio Program, which is usually a foreign-language translation.

Sound Control

Selecting the Internal Mute

When using a device such as a Home Theater or Amplifier with external speakers, you can set Internal Mute to On to cut off sound from the TV's internal speakers.

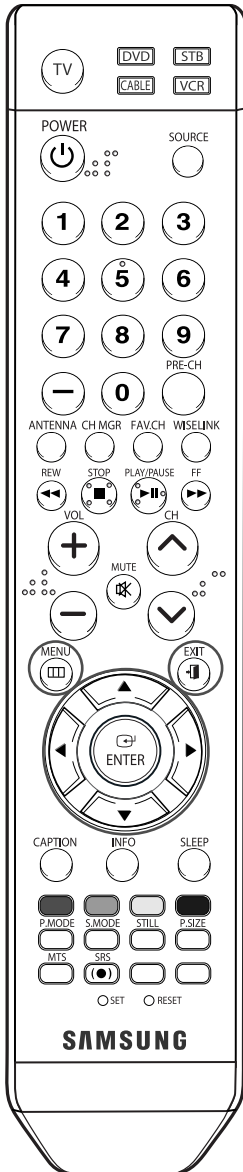

- 1 Press the MENU button.
Press the ◀ or ▶ button to select "Sound", then press the ENTER button.



- 2 Press the ▲ or ▼ button to select "Internal Mute", then press the ENTER button.



- 3 Press the ▲ or ▼ button to select "On", then press the ENTER button. Pressing the ▲ or ▼ button will alternate between "Off" and "On".

Select "Return" by pressing the ▲ or ▼ button, then press the ENTER button to return to the previous menu. Press the EXIT button to exit.



NOTES

- The VOL +, VOL - and MUTE buttons do not operate when the Internal Mute is set to On.
- When Internal Mute is on, only the Multi-Track Options menu is available in the Sound menu.
- To watch TV with an external speaker system such as a home theater system, set Internal Mute to On. To watch TV with the internal speaker or to record video with a VCR through AV OUT of the TV, set Internal Mute to Off.

Setting the On/Off Melody

A melody sound can be set to come on when the TV is powered On or Off.

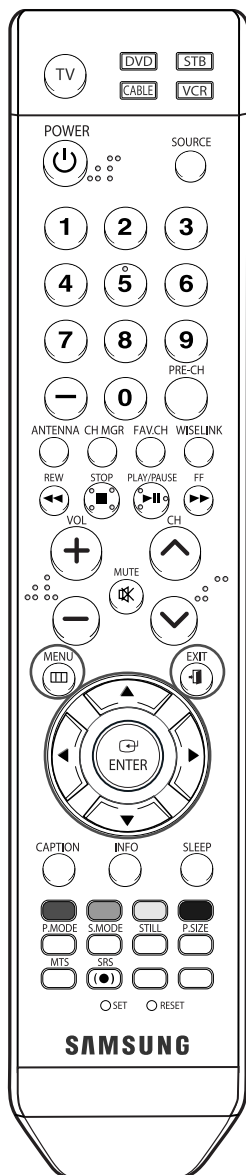

1 Press the MENU button.
Press the ◀ or ▶ button to select "Sound", then press the ENTER button.



2 Press the ▲ or ▼ button to select "Melody", then press the ENTER button.
Press the ▲ or ▼ button to select "Off" or "On", then press the ENTER button.



Select "Return" by pressing the ▲ or ▼ button, then press the ENTER button to return to the previous menu.
Press the EXIT button to exit.

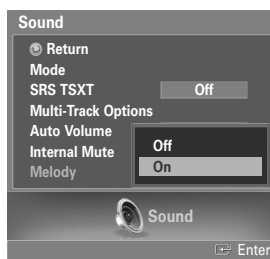

SAMSUNG



Special Features



Special Features

Setting the Function Help

Displays Help on the menu functions.
The Help appears at the top of the screen.

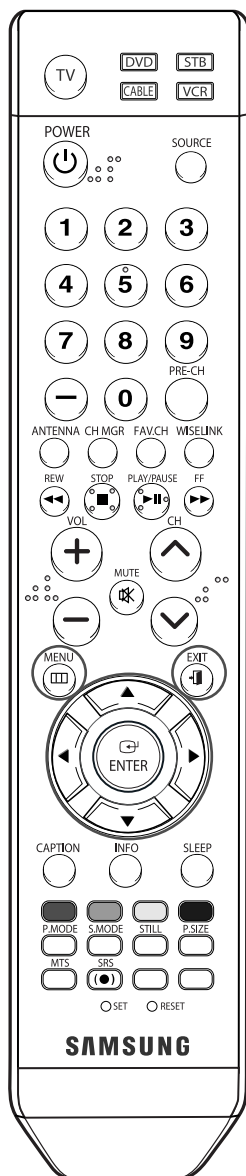

- 1 Press the MENU button.
Press the ◀ or ▶ button to select "Setup", then press the ENTER button.

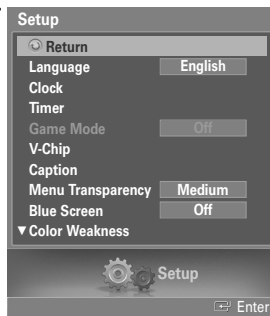

- 2 Press the ▲ or ▼ button to select "Function Help", then press the ENTER button.

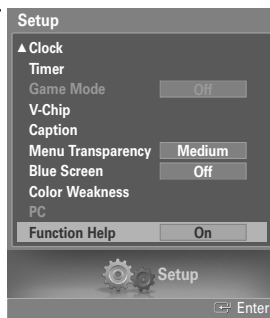

- 3 Press the ▲ or ▼ button to select "Off" or "On", then press the ENTER button.

Select "Return" by pressing the ▲ or ▼ button, then press the ENTER button to return to the previous menu.
Press the EXIT button to exit.

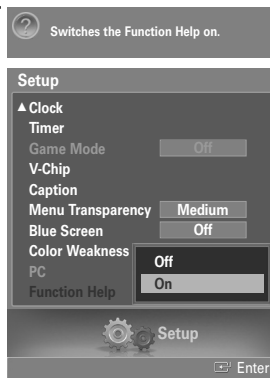

NOTE

- The Function Help default setting is On.

Menu Transparency Level

Adjusts the transparency of the menu screen.

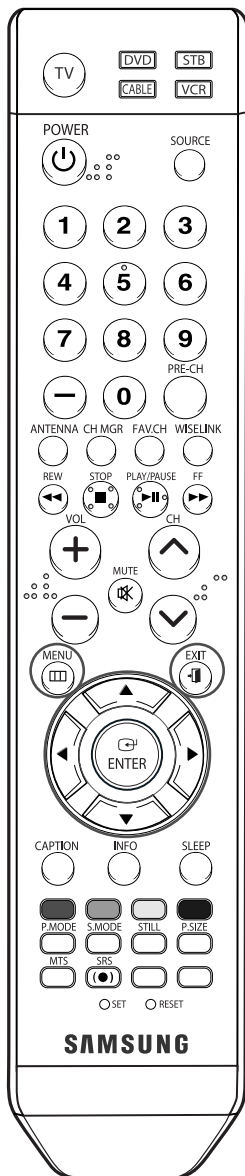

1 Press the MENU button.
Press the ◀ or ▶ button to select "Setup", then press the ENTER button.

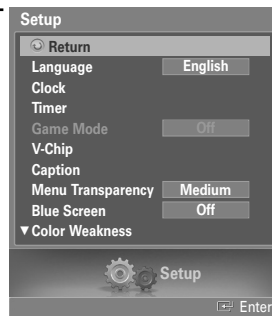

2 Press the ▲ or ▼ button to select "Menu Transparency", then press the ENTER button.
Press the ▲ or ▼ button to select level, then press the ENTER button.

Select "Return" by pressing the ▲ or ▼ button, then press the ENTER button to return to the previous menu.
Press the EXIT button to exit.

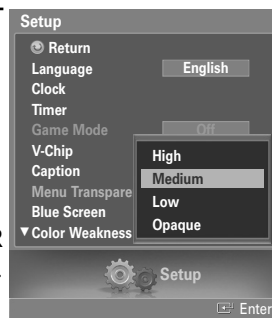

Special Features

Using Game Mode

When connecting to a game console such as PlayStation™ or Xbox™, you can enjoy a more realistic gaming experience by setting the game mode to on.

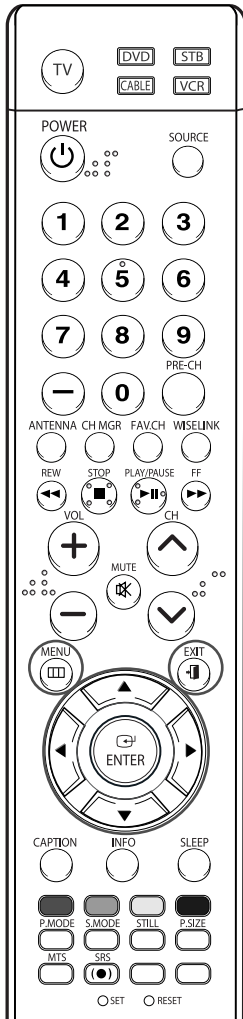

1 Press the MENU button.
Press the ◀ or ▶ button to select "Setup", then press the ENTER button.



2 Press the ▲ or ▼ button to select "Game Mode", then press the ENTER button.



3 Press the ▲ or ▼ button to select "Off" or "On", then press the ENTER button.

Select "Return" by pressing the ▲ or ▼ button, then press the ENTER button to return to the previous menu. Press the EXIT button to exit.

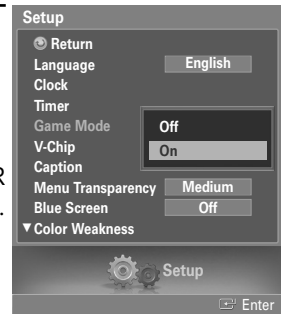

NOTES

- Game Mode is not available in TV mode.
- If the picture is poor when external device is connected to TV, check if Game Mode is On. Set Game Mode to Off and connect external devices.

Restrictions on Game Mode (Caution)

- To disconnect the game console and connect another external device, set Game to Off in the setup menu.
- If you display the TV menu in Game Mode, the screen shakes slightly.

If Game Mode is On

- Picture Mode is automatically changed to Custom and users cannot change the mode.
- Sound Mode in the Sound menu is deactivated. Adjust the sound using the equalizer.
- The Reset Sound function is activated. Selecting the Reset function after setting the equalizer resets the equalizer setting to the factory defaults.

Using the V-Chip

Access to channels and programs is controlled by a password (i.e., a 4-digit secret code that is defined by the user). The on-screen menu will instruct you to assign a password (you can change it later, if necessary).

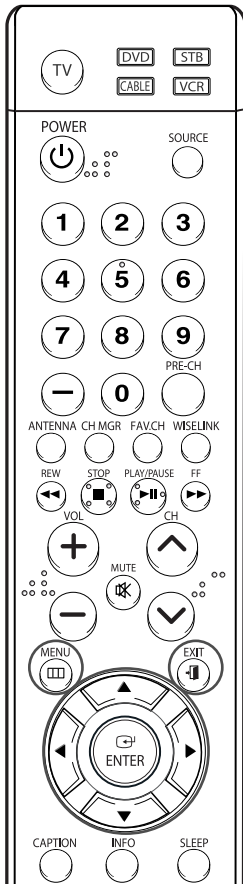

NOTES

- If you forget the pin number, press the remote control buttons in the following sequence, which resets the pin to 0-0-0-0: POWER (Off) → MUTE → 8 → 2 → 4 → POWER (On).
- The V-Chip function only works in TV, AV mode and S-Video mode.

U.S.A Only

This product is covered by the following U.S. patents : US4,930,158 US4,930,160

How to Change Your Password

- 1 Press the MENU button. Press the ◀ or ▶ button to select "Setup", then press the ENTER button. Press the ▲ or ▼ button to select "V-Chip", then press the ENTER button.
- 2 Press the ▼ button. Press the number buttons to enter your current 4-digit PIN. (The default PIN for a new TV set is "0000".) The "V-Chip" menu is displayed.
- 3 Press the ▲ or ▼ button to select "Change PIN", then press the ENTER button.

- 4 Press the ▼ button. Press the number buttons to enter your new 4-digit PIN. Re-enter your new PIN to confirm.

The message will automatically disappear, and return to the previous menu after a few seconds, even if the ENTER button is not pressed.

Select "Return" by pressing the ▲ or ▼ button, then press the ENTER button to return to the previous menu. Press the EXIT button to exit.



Special Features

How to Enable/Disable the Rating Controls

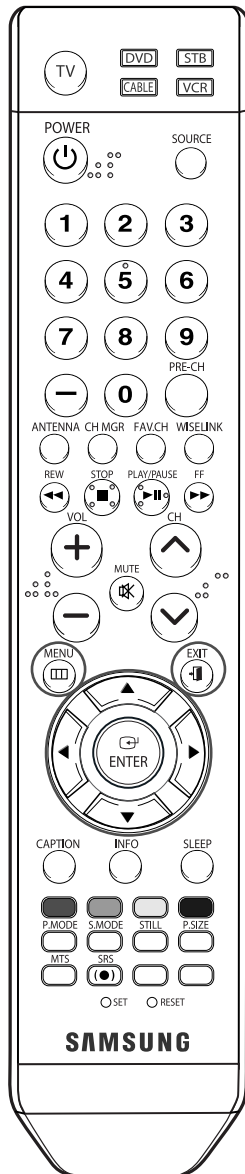

- 1 Press the MENU button.
Press the ◀ or ▶ button to select "Setup", then press the ENTER button.
Press the ▲ or ▼ button to select "V-Chip", then press the ENTER button.



- 2 Press the ▼ button.
Press the number buttons to enter your current 4-digit PIN.
(The default PIN for a new TV set is "0000".)
The "V-Chip" menu is displayed.



- 3 The "V-Chip" screen will appear.
Press the ▲ or ▼ button to select "V-Chip Lock".
To enable the V-Chip feature, press the ENTER button so that the "V-Chip Lock" field is "On".
(Pressing the ▲ or ▼ button will alternate between "On" and "Off".)
Press the ENTER button.



Select "Return" by pressing the ▲ or ▼ button, then press the ENTER button to return to the previous menu.
Press the EXIT button to exit.

How to Set up Restrictions Using “TV Parental Guidelines”

The parental restrictions can be set up using either of two methods: The “TV Parental Guidelines” or “MPAA Rating”.

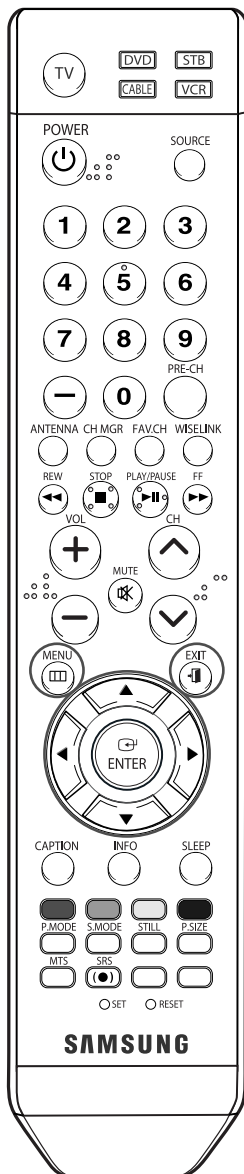

- 1 Press the MENU button.
Press the ◀ or ▶ button to select “Setup”, then press the ENTER button.
Press the ▲ or ▼ button to select “V-Chip”, then press the ENTER button.



- 2 Press the ▼ button.
Press the number buttons to enter your current 4-digit PIN.
(The default PIN for a new TV set is “0000”.)
The “V-Chip” menu is displayed.



- 3 Press the ▲ or ▼ button to select “TV Parental Guidelines”, then press the ENTER button.



Continued...

Special Features

- 4 You can independently lock the TV ratings.
The locked TV (FCC) ratings are indicated by the symbol “”.
Press the ▲/▼/◀/▶ buttons and the ENTER button to activate the appropriate restrictions for TV (FCC) rating system.
To unlock items that are locked, press the Enter button again.

TV-Y : Young children
TV-Y7 : Children 7 and over
TV-G : General audience
TV-PG : Parent Guidance
TV-14 : Viewers 14 and over
TV-MA : Mature Audience

Select “Return” by pressing the ▲ or ▼ button, then press the ENTER button to return to the previous menu.
Press the EXIT button to exit.

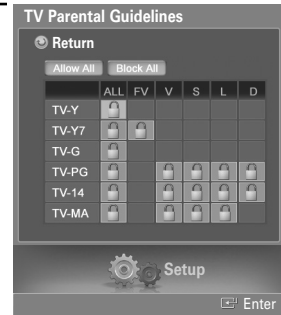

NOTES

- *Allow All* : Press to unlock all TV ratings.
- *Block All* : Press to lock all TV ratings.

NOTES

- *These categories consist of two separate groups: “TV-Y” and “TV-Y7” (young children through age 7), and “TV-G” through “TV-MA” (everybody else).*
- *The restrictions for these two groups work independently: If a household includes very young children as well as young adults, the TV parental guidelines must be set up separately for each age group. (See page 88.)*

How to Set up Restrictions Using “MPAA Rating”

The Movie rating system uses the “MPAA” (Motion Picture Association of America) system, and its main application is for movies.

When the rating control is on, the TV will automatically block any programs that are coded with objectionable ratings (either “MPAA Rating” or “TV Parental Guidelines”).

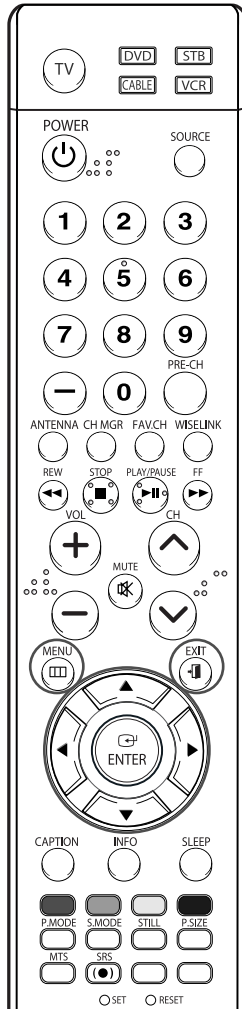

NOTES

- **Allow All** : Press to unlock all movie ratings.
- **Block All** : Press to lock all movie ratings.

- 1 Press the MENU button.
Press the ◀ or ▶ button to select “Setup”, then press the ENTER button.
Press the ▲ or ▼ button to select “V-Chip”, then press the ENTER button.



- 2 Press the ▼ button.
Press the number buttons to enter your current 4-digit PIN.
(The default PIN for a new TV set is “0000”.)
The “V-Chip” menu is displayed.



- 3 Press the ▲ or ▼ button to select “MPAA Rating”, then press the ENTER button.



- 4 You can independently lock the movie ratings. The locked movie ratings are indicated by the symbol “🔒”.
Press the ▲/▼/ENTER buttons to activate the appropriate restrictions for movie rating system.
To unlock items that are locked, press the Enter button again.

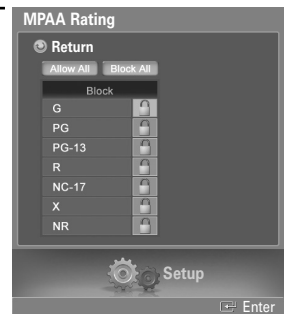

Select “Return” by pressing the ▲ or ▼ button, then press the ENTER button to return to the previous menu.
Press the EXIT button to exit.

Special Features

Important Notes About Parental Locks

Explanation of the MPAA and TV (FCC) Rating Systems:

TV (FCC) Age-Based Ratings

TV-MA

Mature audiences only. This program may contain mature themes, profane language, graphic violence and explicit sexual content.

TV-14

Parents strongly cautioned. This program may contain sophisticated themes, sexual content, strong language and more intense violence.

TV-PG

Parental guidance suggested. The program may contain infrequent coarse language, limited violence, some suggestive sexual dialog and situations.

TV-G

General audience. It contains little or no violence, no strong language, and little or no sexual dialog or situations.

TV-Y7

Directed to older children. Themes and elements in this program may include mild physical or comedic violence, or may frighten children under the age of seven.

TV-Y

All children. The themes and elements in this program are specifically designed for a very young audience, including children from ages two – six.

TV (FCC) Content Category

| | |
|-----------|------------------------------|
| V | Violence. |
| S | Sexual content. |
| L | Offensive language. |
| D | Dialog sexual innuendo. |
| FV | Fantasy or cartoon violence. |

MPAA Rating System (Movies)

| | |
|--------------|---|
| G | General audience. No restriction. |
| PG | Children under 13 should be accompanied by an adult. |
| PG-13 | Parental guidance suggested. Children under 13 should be accompanied by an adult. |
| R | Restricted. Viewers should be 17 or older. |
| NC-17 | Not classified. Viewers should be 17 or older. |
| X | Adults only. |
| NR | Not rated. |

- TV (FCC) ratings : The particular rating that you have selected will be locked (and indicated as a red "L" on a blue background). Also, all of the age-based ratings will be locked within the particular group (i.e., "group 1" or "group 2"). Suppose that the TV-G rating and all of its contents (V, S, L, and D) are locked. In that case, more restrictive ratings (TV-PG, TV-14, and TV-MA) and all of their contents (V, S, L, and D) are automatically locked as well.
- MPAA ratings : The particular rating that you have selected will be locked. In addition, more restrictive ratings will be locked as well.
- Neither TV (FCC) ratings nor MPAA ratings apply to news programs.

How to Set up Restrictions Using Canadian English

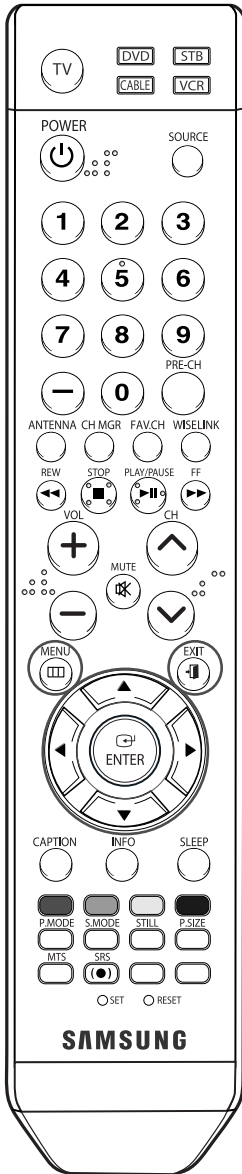

- 1 Press the MENU button.
Press the ◀ or ▶ button to select "Setup", then press the ENTER button.
Press the ▲ or ▼ button to select "V-Chip", then press the ENTER button.



- 2 Press the ▼ button.
Press the number buttons to enter your current 4-digit PIN.
(The default PIN for a new TV set is "0000".)
The "V-Chip" menu is displayed.



- 3 Press the ▲ or ▼ button to select "Canadian English", then press the ENTER button.



Continued...

Special Features

4 Press the ▲ or ▼ button to select a appropriate restriction.

Press the ENTER button to activate the restriction selected.

The “” symbol is indicated.

To unlock items that are locked, press the Enter button again.

Select “Return” by pressing the ▲ or ▼ button, then press the ENTER button to return to the previous menu.

Press the EXIT button to exit.

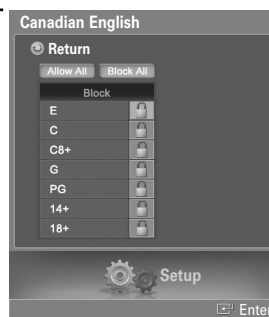

NOTES

- *Allow All* : Press to unlock all TV ratings.
- *Block All* : Press to lock all TV ratings.

| | |
|------------|---|
| E | Exempt programming includes...news, sports, documentaries and other information programming, talk shows, music videos, and variety programming. |
| C | Programming intended for children under age 8. |
| C8+ | Programming generally considered acceptable for children 8 years and over to watch on their own. |
| G | General programming, suitable for all audiences. |
| PG | Parental Guidance. |
| 14+ | Programming contains themes or content which may not be suitable for viewers under the age of 14. |
| 18+ | Adult programming. |

How to Set up Restrictions Using Canadian French

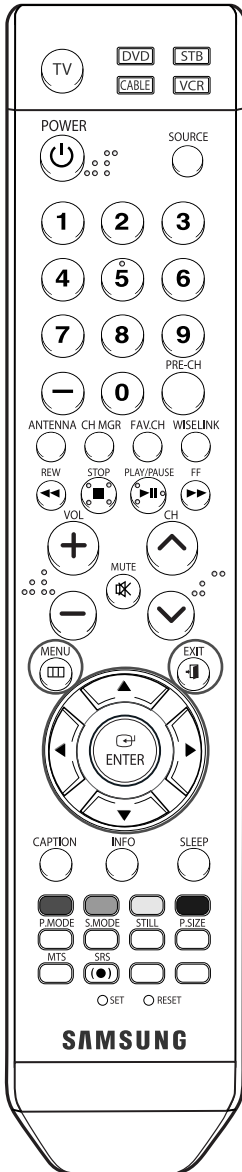

- 1 Press the MENU button.
Press the ◀ or ▶ button to select "Setup", then press the ENTER button.
Press the ▲ or ▼ button to select "V-Chip", then press the ENTER button.



- 2 Press the ▼ button.
Press the number buttons to enter your current 4-digit PIN.
(The default PIN for a new TV set is "0000".)
The "V-Chip" menu is displayed.



- 3 Press the ▲ or ▼ button to select "Canadian French", then press the ENTER button.



Continued...

Special Features

4 Press the ▲ or ▼ button to select a appropriate restriction.

Press the ENTER button to activate the restriction selected. The “🔒” symbol is indicated.

To unlock items that are locked, press the Enter button again.

Select “Return” by pressing the ▲ or ▼ button, then press the ENTER button to return to the previous menu. Press the EXIT button to exit.

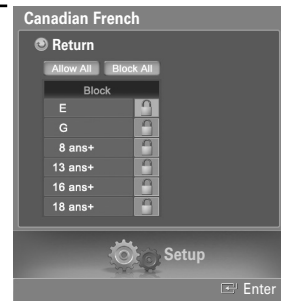

NOTES

- *Allow All* : Press to unlock all TV ratings.
- *Block All* : Press to lock all TV ratings.

- E** Exempt programming includes...news, sports, documentaries and other information programming, talk shows, music videos, and variety programming.
- G** General.
- 8 ans+** Not recommended for young children.
- 13 ans+** Programming may not be suitable for children under the age of 13.
- 16 ans+** Programming is not suitable for children under the age of 16.
- 18 ans+** Programming restricted to adults.

Using the V-Chip for Digital channels

Parental restriction information can be used while watching DTV channels.

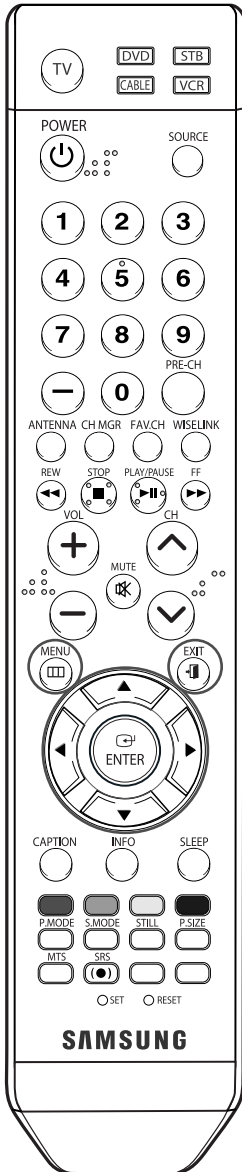

- 1 Press the MENU button.
Press the ◀ or ▶ button to select "Setup", then press the ENTER button.
Press the ▲ or ▼ button to select "V-Chip", then press the ENTER button.



- 2 Press the ▼ button.
Press the number buttons to enter your current 4-digit PIN.
(The default PIN for a new TV set is "0000".)
The "V-Chip" menu is displayed.



- 3 Press the ▲ or ▼ button to select "Downloadable U.S. Rating", then press the ENTER button.



NOTES

- If information is not downloaded from the broadcasting station, the Downloadable U.S. Rating menu is deactivated.
- Parental restriction information is automatically downloaded while watching DTV channels. It may take several seconds.
- The downloadable U.S. Rating menu is available for use after information is downloaded from the broadcasting station. However, depending on the information from the broadcasting station, it may not be available for use.

Continued...

Special Features

- 4 You can independently lock the TV ratings. The locked TV ratings are indicated by the symbol "🔒". To unlock a locked channel, press the ENTER button again. Press the ▲/▼/◀/▶ buttons and the ENTER button to activate the appropriate restrictions for TV rating system.

Select "Return" by pressing the ▲ or ▼ button, then press the ENTER button to return to the previous menu. Press the EXIT button to exit.

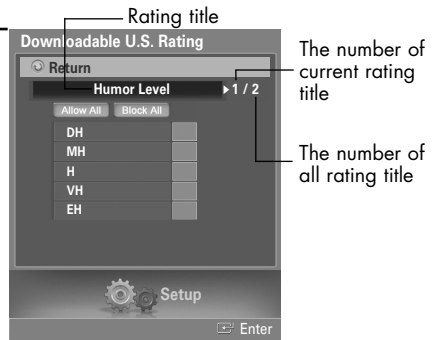

NOTES

- Allow all: Press to unlock all TV ratings. / Block all: Press to lock all TV ratings.
- Parental restriction levels differ depending on the broadcasting station.
- The default menu name and Downloadable U.S. Rating changes depending on the downloaded information.
- Even if you set the On-screen display to your desired language, the "Downloadable U.S. Rating" menu will appear in English only.
- The rating will automatically block certain categories that are more restrictive.
- The rating titles (For example : Humor Level..etc) and TV ratings (For example : DH, MH, H..etc) may differ depending on the broadcasting station.

Viewing Closed Captions (On-Screen Text Messages) **Analog**

The Analog Caption function operates in either analog TV channel mode or external source mode. (Depending on the broadcasting signal, the Analog Caption function may operate on digital channels.)

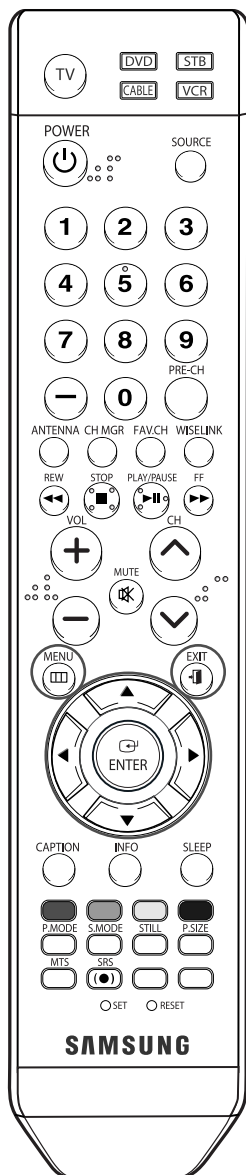

- 1 Press the MENU button.
Press the ◀ or ▶ button to select "Setup", then press the ENTER button.



- 2 Press the ▲ or ▼ button to select "Caption", then press the ENTER button.

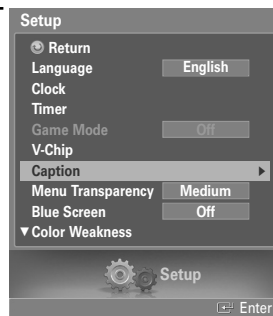

- 3 Press the ▲ or ▼ button to select "Caption", then press the ENTER button.

Press the ▲ or ▼ button to select "On", then press the ENTER button.



Continued...

Special Features

- 4 Press the ▲ or ▼ button to select “Mode”, then press the ENTER button.
Press the ▲ or ▼ button to select submenu (CC1~CC4 or Text1~Text4) you want, then press the ENTER button.

Select “Return” by pressing the ▲ or ▼ button, then press the ENTER button to return to the previous menu.
Press the EXIT button to exit.

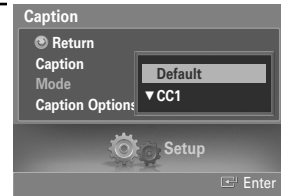

NOTES

- The default is “Default”.
- CC1 : The Primary Synchronous Caption Service. These are captions in the primary language that must be in sync with the sound, preferably matched to a specific frame.
- CC2 : The Special NonSynchronous Use Captions. This channel carries data that is intended to augment information carried in the program.
- CC3 : Secondary Synchronous Caption Service. Alternate program-related caption data, typically second language captions.
- CC4 : Special Non-Synchronous Use Captions. Similar to CC2.
- Text1 : First Text Service. This may be various non-program related data.
- Text2 : Second Text Service. Additional data, usually not program related.
- Text3/Text4 : Third and Fourth Text Services. These data channels are used only if Text1 and Text2 data bandwidths not sufficient.
- The Caption feature only works in TV, AV and S-Video mode.
- The availability of captions depends on the program being broadcast.

Viewing Closed Captions (On-Screen Text Messages) Digital

The Digital Captions function operates on digital channels.

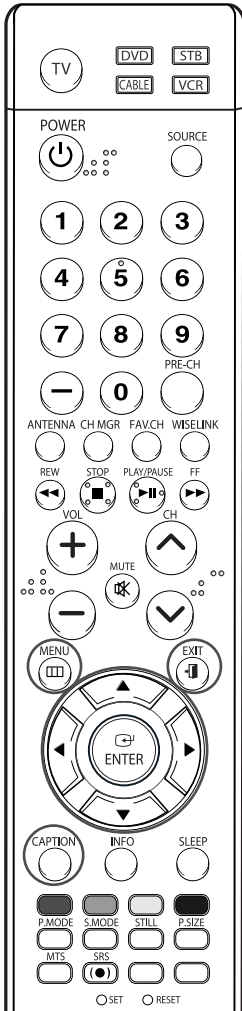

NOTE

- "Caption Options" are available only when "Service 1~Service 6" can be selected in "Mode".

1 Press the MENU button.
Press the ◀ or ▶ button to select "Setup", then press the ENTER button.



2 Press the ▲ or ▼ button to select "Caption", then press the ENTER button.



3 Press the ▲ or ▼ button to select "Caption", then press the ENTER button.

Press the ▲ or ▼ button to select "On", then press the ENTER button.

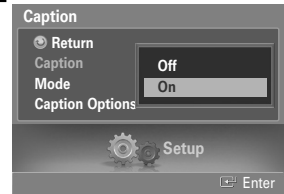

4 Press the ▲ or ▼ button to select "Mode", then press the ENTER button.
Press the ▲ or ▼ button to select submenu (Service 1~Service 6, CC1~CC4 or Text1~Text4) you want, then press the ENTER button.

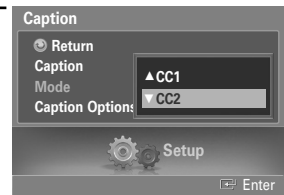

5 Press the ▲ or ▼ button to select "Caption Options", then press the ENTER button.

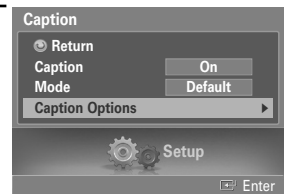

Continued...

Special Features

- 6 Press the ▲ or ▼ button to select "Size", then press the ENTER button.
Press the ▲ or ▼ button to select the desired item in the Size menu, then press the ENTER button.
Set other listed options below using the same method as above.
Select "Return" by pressing the ▲ or ▼ button, then press the ENTER button to return to the previous menu.
Press the EXIT button to exit.

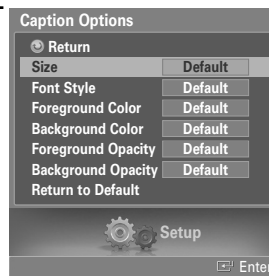

NOTES

- The availability of captions depends on the program being broadcast.
- "Default" means to return to the original caption options set by the broadcaster.

Size

This option consists of "Default", "Small", "Standard", and "Large".
The default is "Default".

Font Style

This option consists of "Default", "Style0 ~ Style 7".
You can change the font you want. The default is "Default".

Foreground Color

This option consists of "Default", "White", "Black", "Red", "Green", "Blue", "Yellow", "Magenta", and "Cyan".
You can change the color of the letter. The default is "Default".

Background Color

This option consists of "Default", "White", "Black", "Red", "Green", "Blue", "Yellow", "Magenta", and "Cyan". You can change the background color of the caption.
The default is "Default".

Foreground Opacity

This option consists of "Default", "Transparent", "Translucent", "Solid", and "Flashing".
You can change the opacity of the letter. The default is "Default".

Background Opacity

This option consists of "Default", "Transparent", "Translucent", "Solid", and "Flashing".
You can change the background opacity of the caption. The default is "Default".

Return to Default

This option sets each of "Size", "Font Style", "Foreground Color", "Background Color", "Foreground Opacity", and "Background Opacity" Color to its default.

Alternate method

Press the CAPTION button on the remote control repeatedly to select "On" or "Off".

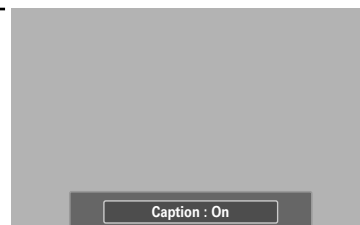



PC Display



PC Display

Using Your TV as a Computer (PC) Display

How to Connect Your PC to the TV

This figure shows the Standard Connector-jack panel. The actual configuration on your TV may be different, depending on the model.

Connecting a PC (15p D-SUB) to the TV

- 1 Connect a PC cable between the PC Output jack on the PC and the RGB input jack (PC IN) on the TV.
- 2 Connect a Audio cable between the Audio jack on the PC and the Audio input jack (PC AUDIO IN) on the TV.

NOTE

- You cannot connect this TV to a PC via HDMI/DVI.

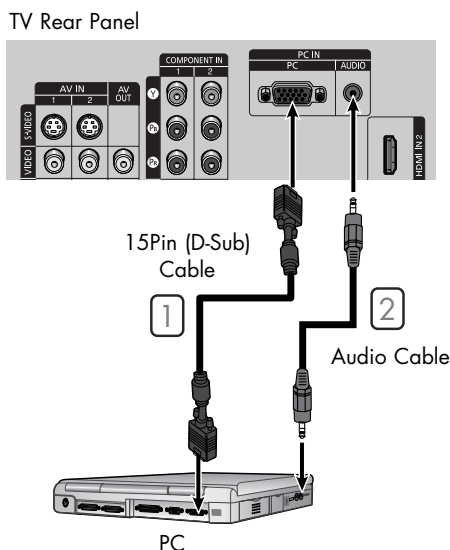

Setting up Your PC Software (Based on Windows XP)

The Windows display-settings for a typical computer are shown below. But the actual screens on your PC will probably be different, depending upon your particular version of Windows and your particular video card. But even if your actual screens look different, the same, basic set-up information will apply in almost all cases. (If not, contact your computer manufacturer or Samsung Dealer.)

1. Right click the mouse on the Windows Desktop, then click on Properties. The Display Dialog-Box will be displayed.
2. Click on Settings, then set the Display Mode with reference to the Display Modes Table. You do not need to change the Colors settings.
3. Click on Advanced. A new settings dialog box will be displayed.
4. Click on the Monitor tab, then set the Screen Refresh Rate with reference to the Display Modes Table. Set the Vertical Frequency and Horizontal Frequency individually if you can do so, instead of setting the Screen Refresh Rate.
5. Press the OK button, close the window, then press the OK button on the Display Registration Information window. Automatic re-booting may commence at this moment.
6. Shutdown the PC, and connect it to your TV.
 - * The actual screens on your PC may look different, depending on your particular version of Windows and the type of your PC.
 - * When you use your TV as a PC monitor, it supports Colors up to 32 bits.
 - * In this case, the display on the TV may look different depending on your particular version of Windows or the PC manufacturer.
 - * When connecting a PC, you must set it to the display settings that are supported by the TV. Otherwise, the message "Out of input range" will be displayed.

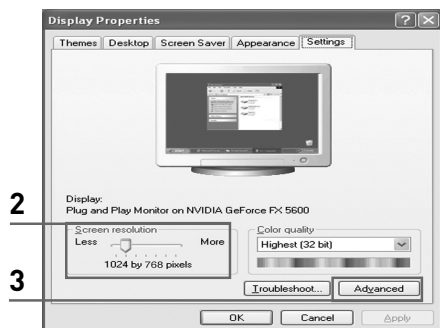

continued...

PC Display

Checklist Before Connecting to a PC

- Adjust the PC Display Setup to the resolution and frequency values that are supported by the TV.
- Please read the user's manual provided with the PC (Graphic Card & Sound Card).
- Do not supply power to either device until all connections are complete.
Supplying power in the middle of connecting may cause damage to the product.
- Check the terminal types for the PC's graphic card.

Setting the Display Modes to be Compatible with Your TV

| Mode | Resolution | Vertical Frequency [Hz] | Horizontal Frequency [KHz] | Vertical Polarity | Horizontal Polarity |
|------|---------------|-------------------------|----------------------------|-------------------|---------------------|
| IBM | 640 x 350 | 70.086 | 31.469 | N | P |
| | 640 x 480 | 59.94 | 31.469 | N | N |
| VESA | 640 x 480 | 72.809 | 37.861 | N | N |
| | | 75 | 37.5 | N | N |
| | 800 x 600 | 60.317 | 37.879 | P | P |
| | | 72.188 | 48.077 | P | P |
| | | 75 | 46.875 | P | P |
| | 1024 x 768 | 60.004 | 48.363 | N | N |
| | | 70.069 | 56.476 | N | N |
| | | 75.029 | 60.023 | P | P |
| | 1152 x 864 | 75 | 67.5 | P | P |
| | 1280 x 960 | 60 | 60 | P | P |
| | 1280 x 1024 | 60.02 | 63.981 | P | P |
| | | 75.025 | 79.976 | P | P |
| | 1600 x 1200 | 60 | 75 | P | P |
| | 1920 x 1200RB | 59.885 | 74.556 | P | N |

NOTES

- The Modes Table conforms to the regulations of IBM/VESA and is prepared based on analog input standards.
- Resolutions other than the resolutions above are not supported in PC mode.

Adjusting the Picture Quality

The purpose of picture quality adjustment is to remove or reduce picture noise. If the noise is not removed by fine tuning alone, then do the frequency adjustments to the utmost and fine tune again. After the noise has been reduced, re-adjust the picture so that it is aligned to the center of screen.

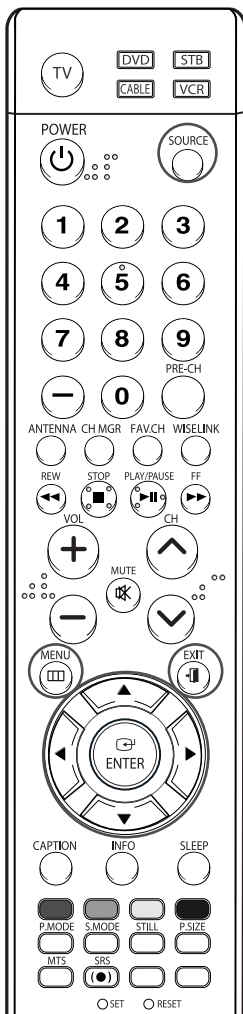

NOTE

- This feature may change the width of the image. If necessary, adjust the position to center.

1 Press the SOURCE button to select "PC".

2 Press the MENU button. Press the ◀ or ▶ button to select "Setup", then press the ENTER button.

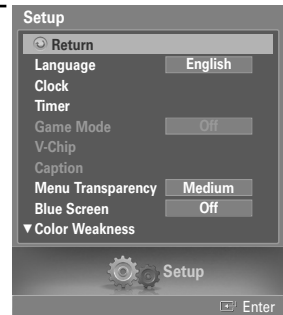

3 Press the ▲ or ▼ button to select "Image Lock", then press the ENTER button.

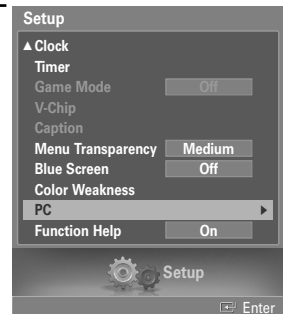

4 Press the ▲ or ▼ button to select "Image Lock", then press the ENTER button.

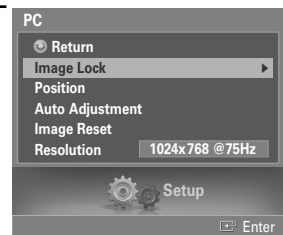

5 Press the ▲ or ▼ button to select "Coarse" or "Fine", then press the ENTER button.



6 Press the ◀ or ▶ button to remove the picture noise.

Select "Return" by pressing the ▲ or ▼ button, then press the ENTER button to return to the previous menu. Press the EXIT button to exit.

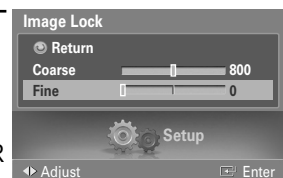

Changing the Picture Position

After connecting the TV to your PC, adjust the position of the picture if it is not well-aligned.

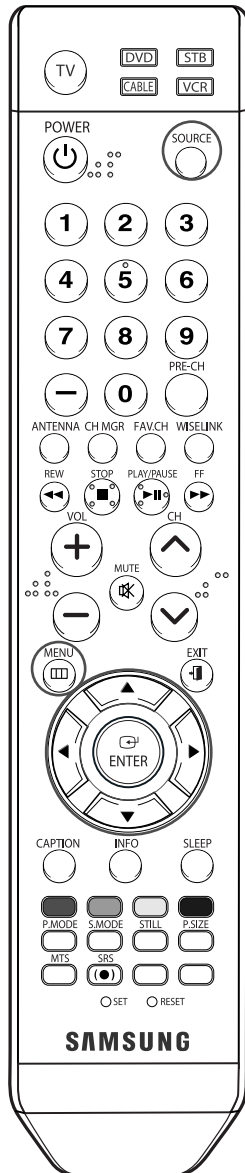

1 Press the SOURCE button to select "PC".

2 Press the MENU button.
Press the ◀ or ▶ button to select "Setup", then press the ENTER button.



3 Press the ▲ or ▼ button to select "PC", then press the ENTER button.

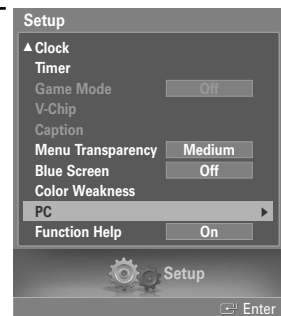

4 Press the ▲ or ▼ button to select "Position", then press the ENTER button.

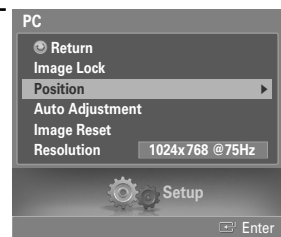

5 Adjust the position of picture by pressing the ▲/▼/◀/▶ button.
Press the ENTER button.

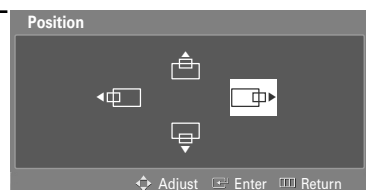

Select "Return" by pressing the ▲ or ▼ button, then press the ENTER button to return to the previous menu. Press the EXIT button to exit.

Adjusting the Picture Quality and Position Automatically

This feature allows the TV to self-adjust to the incoming video signal. The values of fine, coarse and position are adjusted automatically.

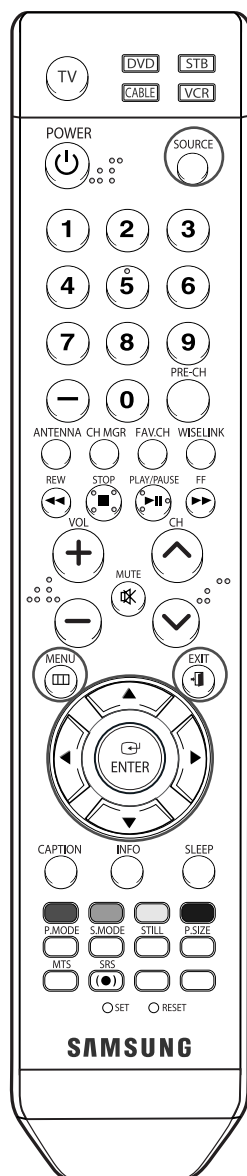

1 Press the SOURCE button to select "PC".

2 Press the MENU button.
Press the ◀ or ▶ button to select "Setup", then press the ENTER button.



3 Press the ▲ or ▼ button to select "PC", then press the ENTER button.

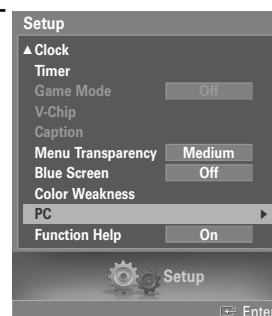

4 Press the ▲ or ▼ button to select "Auto Adjustment", then press the ENTER button.
The picture quality and position are automatically adjusted, and the picture returns to original view a few seconds later.

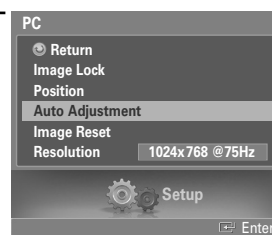

Select "Return" by pressing the ▲ or ▼ button, then press the ENTER button to return to the previous menu. Press the EXIT button to exit.

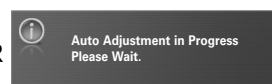

Changing the Picture Size (PC Mode)

You can select the picture size which best corresponds to your viewing requirements.

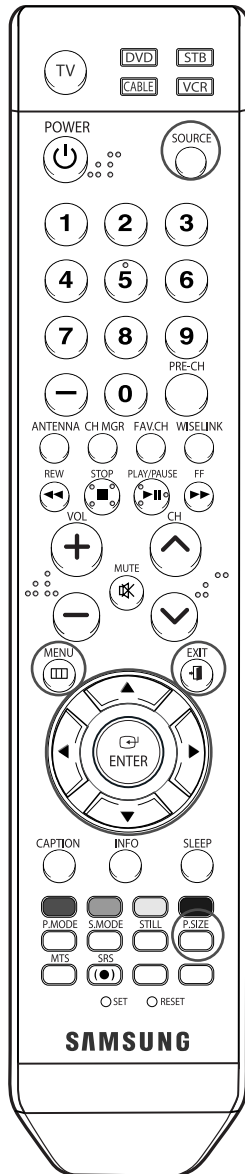

1 Press the SOURCE button to select "PC".

2 Press the MENU button.
Press the ◀ or ▶ button to select "Picture", then press the ENTER button.
Press the ▲ or ▼ button to select "Size", then press the ENTER button.

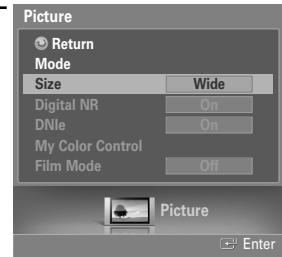

3 Press the ▲ or ▼ button to select the screen format you want, then press the ENTER button.

- "Wide": Scales the picture to 92% of the TV screen, regardless of the aspect ratio of the input source.
- "4:3": Displays the picture as it is without changing the aspect ratio of input source.

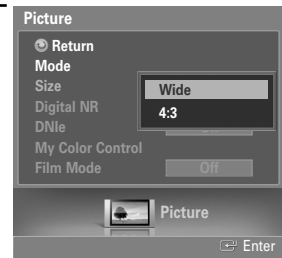

Select "Return" by pressing the ▲ or ▼ button, then press the ENTER button to return to the previous menu.
Press the EXIT button to exit.

Alternate method

Press the P.SIZE button on the remote control repeatedly to change the picture Size.

- "Wide": The picture position (◻, ◻) and size (⊞) adjustment are available by pressing the ▲/▼/◀/▶ button.



Viewing the Current Resolution

You can get the resolution information of your PC.

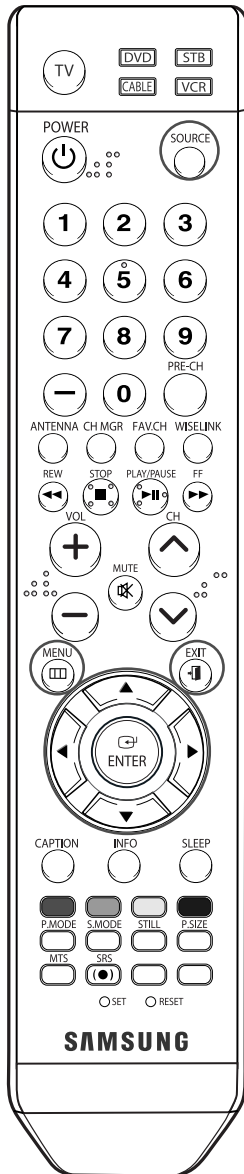

1 Press the SOURCE button to select "PC".

2 Press the MENU button.
Press the ◀ or ▶ button to select "Setup", then press the ENTER button.



3 Press the ▲ or ▼ button to select "PC", then press the ENTER button.

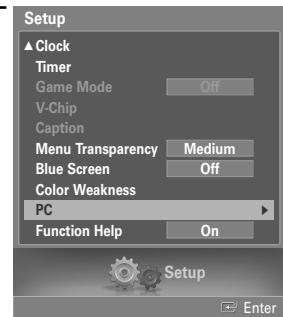

The resolution information is displayed on the screen.

Select "Return" by pressing the ▲ or ▼ button, then press the ENTER button to return to the previous menu. Press the EXIT button to exit.

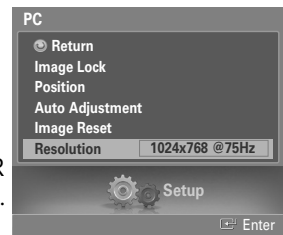

NOTE

- To change the resolution, see pages 101~102.

PC Display

Initializing the Picture Settings

You can replace all picture settings with the factory default values.

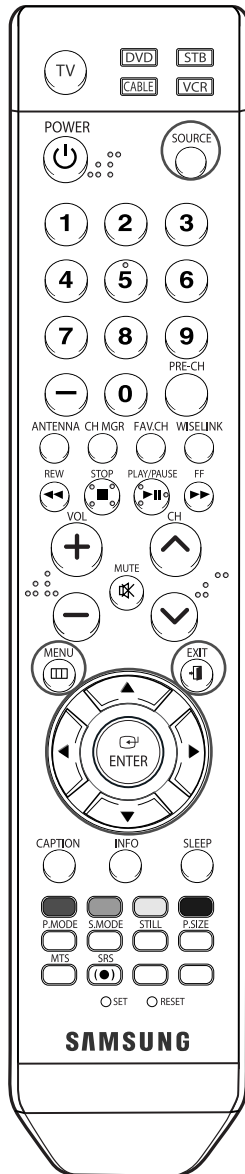

1 Press the SOURCE button to select "PC".

2 Press the MENU button.
Press the ◀ or ▶ button to select "Setup", then press the ENTER button.

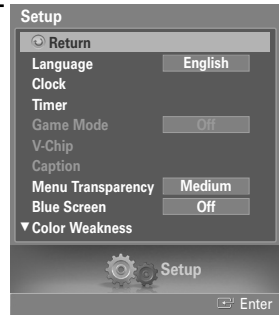

3 Press the ▲ or ▼ button to select "PC", then press the ENTER button.

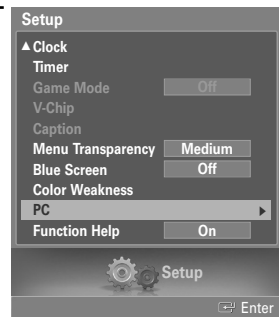

4 Press the ▲ or ▼ button to select "Image Reset", then press the ENTER button.

The picture settings are replaced with the factory default values.

Select "Return" by pressing the ▲ or ▼ button, then press the ENTER button to return to the previous menu. Press the EXIT button to exit.





WISELINK



WISELINK

Using the WISELINK Function

This function enables you to view and listen to photo (JPEG) and audio files (MP3) saved on a USB Mass Storage Class (MSC) device.

Press the power button on the remote control or front panel.

Connect a USB device containing JPEG and/or MP3 files to the WISELINK jack (USB jack) on the side of the TV first.

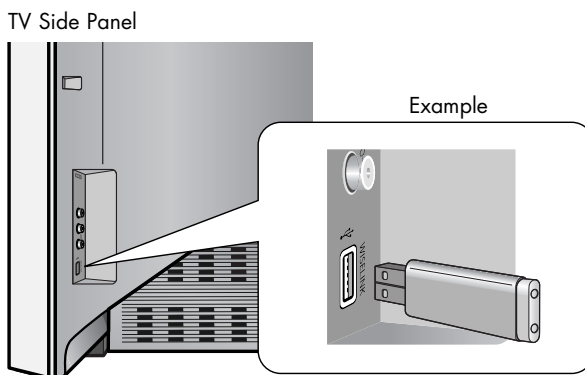

NOTES

- If you enter the WISELINK mode with no USB device connected. "There is no device connected" message will appear. In this case, insert the USB device, exit the screen by pressing the WISELINK button on the remote control and enter the WISELINK screen again.
- Photo and audio files must be named in English, French, or Spanish. If not, the files can not be played. Change the file names to English, French, or Spanish if necessary.
- Folder or file names can not exceed 128 characters. If exceeded, they won't function.
- The file system only supports the FAT16/32.
- **Certain types of USB Digital camera and audio devices may not be compatible with this TV.**
- Wiselink only supports the USB Mass Storage Class device (MSC). MSC is a Mass Storage Class Bulk-Only Transport device. Examples of MSC are Thumb drives and Flash Card Readers.
- Before connecting your device to the TV, please back up your files to prevent them from damage or loss of data. SAMSUNG is not responsible to any data file damage or data loss.

Using the Remote Control Button in WISELINK Menu

| Button | Operations |
|--------|---|
| | Move the cursor and select an item |
| | Select the currently selected item. |
| | Play or pause the Slide Show or MP3 file. |
| | Stop the current function and return to the previous high-level menu. |
| | Run various functions from the Photo and Music menus. |
| | Stop the current slide show or MP3 file. |
| | Page Up or Down (file list item) |

Using the WISELINK Menu

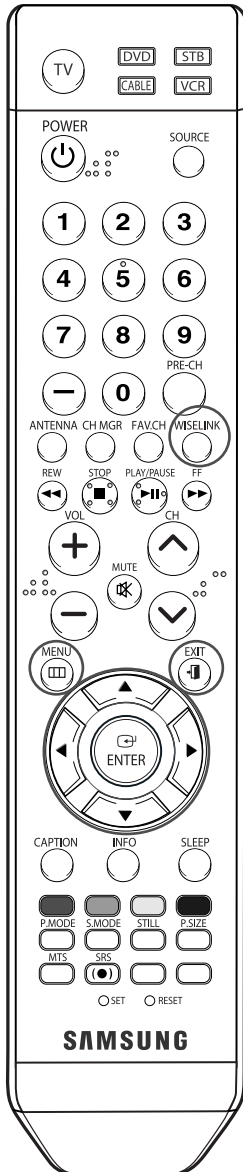

1 Press the MENU button. Press the ◀ or ▶ button to select "Application", then press the ENTER button.

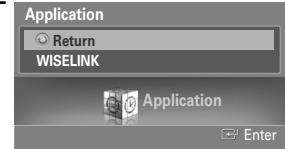

2 Press the ▲ or ▼ button to select "WISELINK", then press the ENTER button.

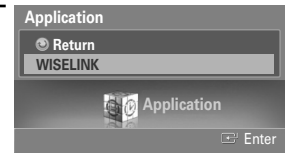

3 Press the ▲ or ▼ button to select the corresponding MSC Memory Device, then press the ENTER button.

A menu for selecting the format of the files saved on the selected MSC Memory Device will be displayed.



4 Press the ◀ or ▶ button to move to an icon, then press the ENTER button.

To exit WISELINK mode, press the WISELINK button on the remote control.

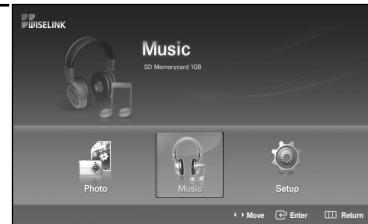

Alternate method

Press the WISELINK button on the remote control to display a WISELINK menu.



Using the PHOTO (JPEG) List

This menu shows JPEG files and folders saved on an MSC memory device.

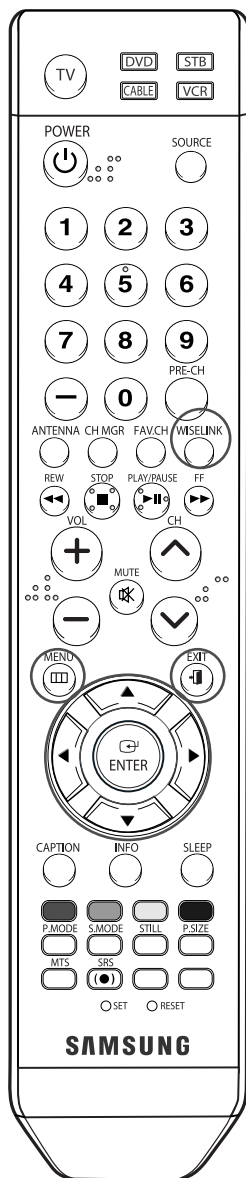

1 Complete Steps 1 to 4 of Using the WISELINK Menu. (Refer to page 111)



2 Press the ◀ or ▶ button to move to "Photo", then press the ENTER button. The saved file information is displayed as a folder or file.



3 Press the ▲, ▼, ◀ and ▶ buttons to select a file, then press the ENTER button.

- Pressing the button over a photo icon shows the currently selected photo in full screen.
- Pressing the button over a folder icon shows the JPEG files included in the folder.



-  : folder icon
-  : photo icon
-  : Move to the previous folder stage icon

To exit WISELINK mode, press the WISELINK button on the remote control.

NOTES

- Moving to a photo may take a few seconds to load the file. At this point, the  Loading icon will appear at the top left of the screen.
- This menu only shows files whose file extension is jpg. Files of other formats such as bmp or tiff will not be displayed.
- The files are displayed on a page. 15 thumbnail photos are displayed per page.
- The thumbnails are numbered from left to right and from top to bottom, from 1 to 15.
- Folders are displayed first and they are followed by all JPEG files in the current folder. The folders and JPEG files are sorted in alphabetical order.
- If the photo is displayed in full screen, you can zoom in and out or rotate the photo on the screen. (Refer to pages 116~118)
- It takes time to show JPEG files as Thumbnail images.

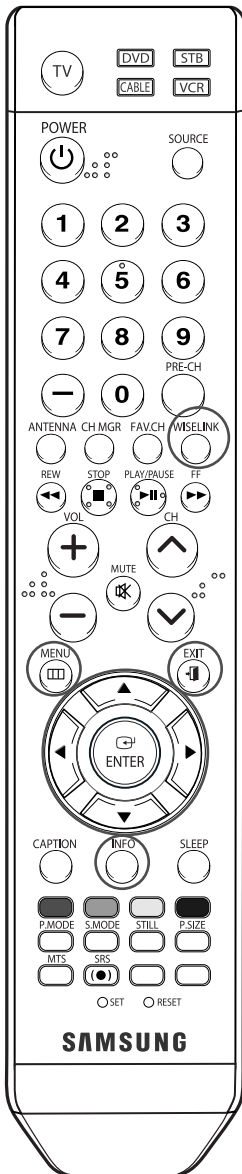

Selecting a Photo and Slide Show

1 Complete Steps 1 to 4 of Using the WISELINK Menu.
(Refer to page 111)

2 Press the ◀ or ▶ button to move to "Photo", then press the ENTER button.
The saved file information is displayed as a folder or file.



3 Press the INFO button to display "View" or "Slide Show".



4 Press the ▲ or ▼ button to select "Slide Show", then press the ENTER button.



NOTES

- Slideshow all files in the selected folder at a predetermined interval.
- During the slide show, files are displayed in order from the currently shown file.
Press the INFO button to run Slide Show.
- **MP3 files can be automatically played during the Slide Show if the Default Background Music is set to On. To enable this function, MP3 files and other photo files must be located in the same folder on the MSC Memory Device.**

continued...

- 5 Press the INFO button during "Slide Show" to set the option (Slide Show Speed, Background Music On/Off, Background Music Setting, List).

Press the ▲ or ▼ button to select the option, then press the ENTER button.



- 6 To change the sub option, press the INFO button again to open the options window and select option you want to change, then press the ENTER button. Whenever you do this, the sub option on the screen is changed.



Using the Menu during a Slide Show

Slide Show Speed:

Select to control the slide show speed. You can select Slow, Normal, or Fast.



Background Music On/Off:

Select to choose whether you want to play MP3 file during a slide show. You can select Music On or Music Off.



Background Music Setting:

The saved file information is displayed as folder or MP3 file.

- Select the Background Music Settings and press the ENTER button. Select a folder for the background music by using the ▲ or ▼ buttons and press the ENTER button. The selected folder will be highlighted.
- Press the MENU button again to return to the SlideShow screen. The selected background music is played.



NOTE

- If you turn Off the Background Music, even if the Background Music Settings have been set up, the background music will not be played.

continued...

List:

The saved file information is displayed as folder or JPEG file.

To exit WISELINK mode, press the WISELINK button on the remote control.



Slideshow function information icon (Displayed at the top left of the screen).

| Icon | Current OSD | Function |
|------|--------------------------|---|
| | (Photo) SlideShow | Photo SlideShow is in progress. |
| | Photo Pause | When the SlideShow and music is paused by the PLAY/PAUSE button on the remote control during a SlideShow. To resume the SlideShow, press the PLAY/PAUSE button on the remote control again. |
| | Volume Up Volume Down | When pressing the VOL +, - buttons on the remote control to adjust the music volume. |
| | Move to Next Photo | When pressing the (right) direction button on the remote control to move to the next photo. |
| | Move to Previous Photo | When pressing the (left) direction button on the remote control to move to the previous photo. |

NOTE

- When selecting a photo file, the photo file information is displayed on the left in the TV screen, such as the resolution, the date modified and the order of the file in the current directory (e.g. 10th out of 15).

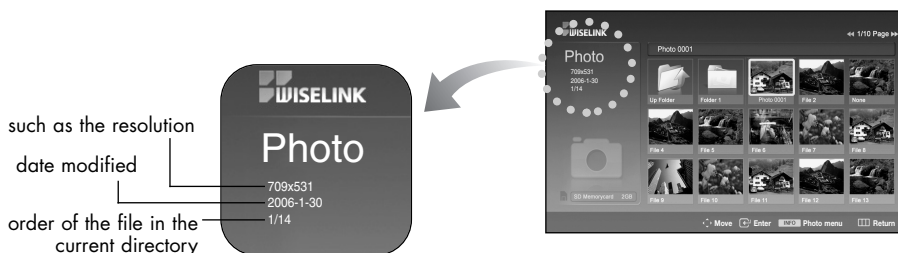

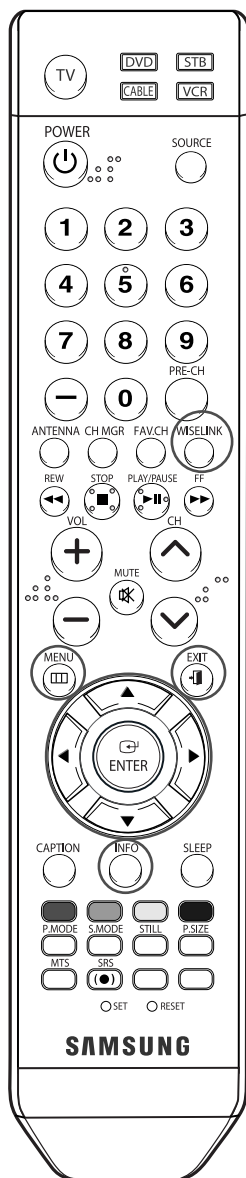

Rotating

1 Complete Steps 1 to 4 of Using the WISELINK Menu.
(Refer to page 111)

2 Press the ◀ or ▶ button to move to "Photo", then press the ENTER button.
The saved file information is displayed as a folder or file.



3 Press the ▲, ▼, ◀ and ▶ buttons to select a file, then press the ENTER button.
Pressing the button over a photo thumbnail displays the photo in full screen.



4 Press the INFO button to display the option(Slide Show, Rotate, Zoom).

Press the ▲ or ▼ button to select "Rotate", then press the ENTER button.



- The INFO button, the Rotate option and Enter must be pressed each time you want to rotate the picture.
For example, from 90° to 180° degrees.

To rotate a photo, press the INFO button to open the options window, select the "Rotate" option and press the ENTER button. Whenever you do this, the photo on the screen is rotated. (90°, 180°, 270°, 0°)

To exit WISELINK mode, press the WISELINK button on the remote control.

NOTES

- The rotated file is not saved.
- Zoom/Slide Show option is disabled when the Rotate option is selected.

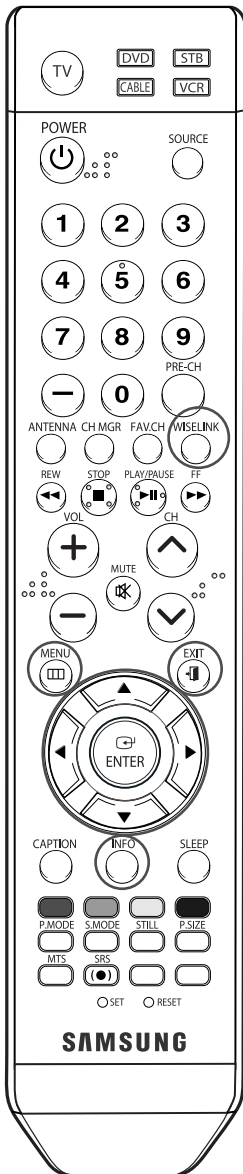

Zooming-in

1 Complete Steps 1 to 4 of Using the WISELINK Menu.
(Refer to page 111)

2 Press the ◀ or ▶ button to move to "Photo", then press the ENTER button.
The saved file information is displayed as a folder or file.



3 Press the ▲, ▼, ◀ and ▶ buttons to select a file, then press the ENTER button.
Pressing the button over a photo thumbnail displays the photo in full screen.



4 Press the INFO button to display the option(Slide Show, Rotate, Zoom).

Press the ▲ or ▼ button to select "Zoom", then press the ENTER button.
The enlarged photo image appears on the screen.



To enlarge a displayed photo, press the INFO button to open the Options window, select the "Zoom" option and press the ENTER button.
Whenever you do this, the following zoom options are applied in sequence.



- The INFO button, the Rotate option and Enter must be pressed each time you want to Zoom the picture.
For example, from x2 to x4.



continued...

- Zoom(x 2): Zoom-in to the photo x2.
- Zoom(x 4): Zoom-in to the photo x4.
- Zoom(x 1): Restore the photo to its original size.





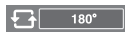





To move to pan up/down/left/right, press the ▲, ▼, ◀ and ▶ buttons.

To exit WISELINK mode, press the WISELINK button on the remote control.

The Rotating function information icon (Displayed at the top left of the screen).

| Icon | Current OSD | Function |
|---|-----------------|----------------------------------|
|  | Rotating (90°) | To rotate a photo by 90 degrees |
|  | Rotating (180°) | To rotate a photo by 180 degrees |
|  | Rotating (270°) | To rotate a photo by 270 degrees |
|  | Rotating (0°) | To rotate a photo by original |

Zoom function information icon (Displayed at the top left of the screen).

| Icon | Current OSD | Function |
|---|-----------------|--|
|  | Zoom (x 2) | Zoom-in to a photo x2. |
|  | Zoom (x 4) | Zoom-in to a photo x4. |
|  | Zoom (x 1) | Restore a photo to its original size. |
|  | Pan Down | Pan down to view the lower part of a zoomed-in photo. |
|  | Pan Up | Pan up to view the upper part of a zoomed-in photo. |
|  | Pan Right | Pan right to view the right side of a zoomed-in photo. |
|  | Pan Left | Pan left to view the left side of a zoomed-in photo. |
|  | Pan Down (END) | Pan to the bottom of a zoomed-in photo. |
|  | Pan Up (END) | Pan to the top of a zoomed-in photo. |
|  | Pan Right (END) | Pan to the right-most part of a zoomed-in photo. |
|  | Pan Left (END) | Pan to the left-most part of a zoomed-in photo. |

NOTE

- Rotate/Slide show option is disabled when the Zoom option is selected.

Using the MP3 List

This menu shows MP3 files from among the files saved on an MSC memory device.

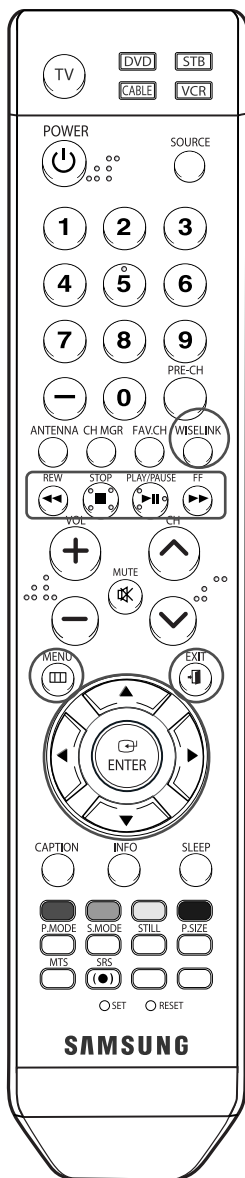

1 Complete Steps 1 to 4 of Using the WISELINK Menu. (Refer to page 111)

2 Press the ◀ or ▶ button to move to "Music", then press the ENTER button. The saved file information is displayed as a folder or file.

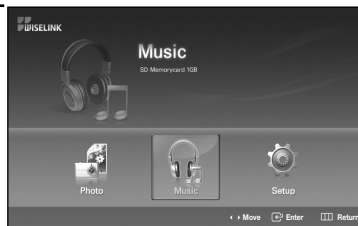

3 Press the ▲ or ▼ button to select a file, then press the ENTER button.

To select all files or a file, press the INFO button to display the Music menus. Press the ENTER button to select "Play All Files" or "Play".

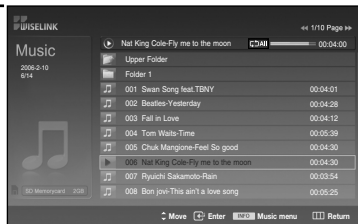

 : folder icon

 : musical note icon

- Pressing the button over a musical note icon immediately plays the music file.
- Pressing the button over a folder icon shows the music files included in the folder.

To select a file on the next page, press the REW or FF button to move to the next page.

continued...

- 4 Press the PLAY/PAUSE button while playing an MP3 file to pause the file. Press the STOP button to exit Play mode.

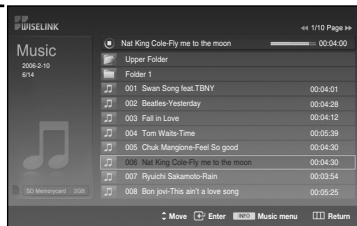





To exit WISELINK mode, press the WISELINK button on the remote control.

NOTES

- This menu only shows files with the mp3 file extension. Files with other file extensions are not displayed, even if they are saved on the same memory card.
- The selected file is displayed on the top with its playing time.
- To adjust the music volume, press the VOL+ or VOL- button on the remote control. To mute the sound, press the MUTE button on the remote control.
- FF/Rew Key does not function during the play.

Music function information icon (Displayed at the top left of the screen).

| Icon | Current OSD | Function |
|---|--------------------|---|
|  | (Music) All | When all music files are being played. |
|  | (Music) One | When a music file is being played. |
|  | (Music) Play/Pause | When pressing the PLAY/PAUSE button on the remote control while music is playing. The music stops and the 'Play' text appears at the top of the screen. |
|  | (Music) Stop | When pressing the STOP button on the remote control when music is stopped. The music resumes and the 'Stop' text appears at the top of the screen. |

Using the Setup Menu

Setup displays the user settings of the WISELINK menu.

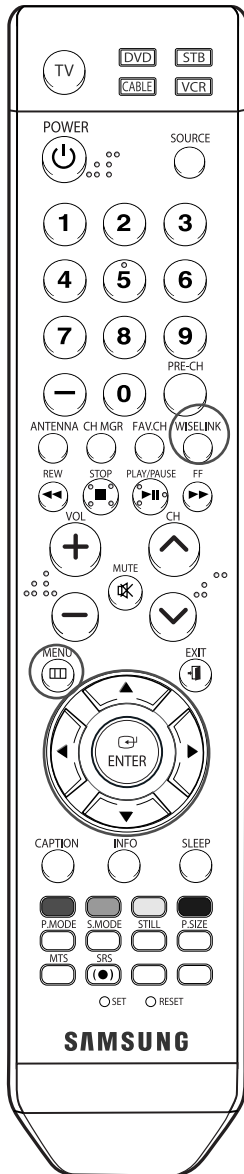

1 Complete Steps 1 to 4 of Using the WISELINK Menu.
(Refer to page 111)

2 Press the ◀ or ▶ button to move to "Setup", then press the ENTER button.



3 Press the ▲ or ▼ button to select an item you want, then press the ENTER button.

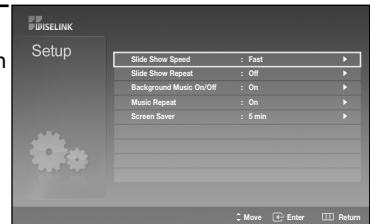

4 Press the ▲ or ▼ button to select the option, then press the ENTER button.



continued...

Slide Show Speed:

Select to control the slide show speed. You can select Slow, Normal or Fast.



Slide Show Repeat:

- On: Repeats the slide show from the beginning when all the files in the folder have been displayed.
- Off: Exit a slide show. To return to the Photo menu when all the files in the folder have been displayed.



Background Music:

Select to determine whether to play an MP3 file during a slide show. You can select Music On or Music Off.

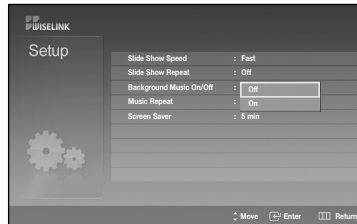

Music Repeat:

Select to determine whether to repeat playing the music when all MP3 files in the current folder have been played. You can select On or Off.

- On: **[C]All** (Music) All, **[C]1** (Music) One
- Off: **[C]All** (Music) All, **[C]1** (Music) One

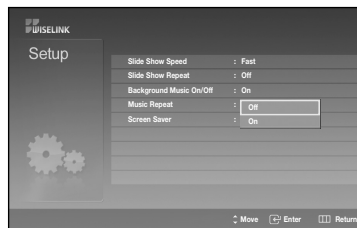

Screen Saver:

Select to set the waiting time before the screen saver is run when no button is pressed. You can select from Off(Do Not Use), 5min(minute) or 10min(minute).

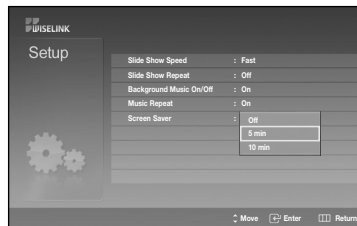

A graphic element consisting of a horizontal line at the top left, a vertical line extending down from it, and a horizontal bar below the vertical line. The bar is divided into a white section on the left and a grey section on the right. The word "Appendix" is centered in the white section.

Appendix

Replacing the Lamp

- **Why do I need to replace the lamp?**

The lamp used in a DLP TV has a limited lifespan. For the best screen quality it needs to be replaced periodically. After replacing the lamp, the screen quality will be bright and clear as new.

- **When do I need to replace it?**

It should be replaced when the screen becomes darker, less clear or when all three LEDs on the front (TIMER, LAMP, & STAND BY/TEMP) are flashing.

- **Check before lamp replacement**

1. The lamp must be the same code number and type.
2. The lamp type is indicated on the side of the TV. It is also indicated on the lamp case.
3. After checking the code number for the lamp, give the code number to the store where you purchased the TV or to a Samsung Service center.

- **Caution**

1. Replace with the correct code numbered lamp to avoid damage to the TV.
2. Turn the power off and wait for 30 minutes before replacing the lamp as it will be hot.
3. Do not touch the glass part of the lamp with your bare hands and do not insert any foreign object inside the cover as it may cause poor screen quality, electric shock or fire.
4. Do not place the old lamp near flammable objects or within the reach of children.
5. Be sure to connect this TV directly to an AC wall outlet. If the TV's AC plug is connected to a cable box or other source, it will not allow for proper cool down time.

- For replacement, you will need a 5.91-Inch screwdriver and a pair of gloves.

1 Unplug TV, then use a screwdriver to remove the screws.



2 Remove the Lamp cover.



3 Remove the Lamp cover duct holding the tab and pulling it out.

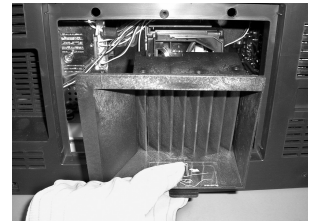

4 Remove the screw securing the Lamp by using a screwdriver.

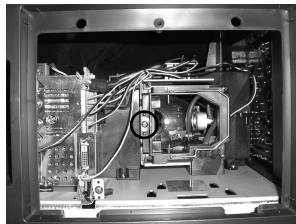

5 Separate the Lamp from the engine by holding the handle and pulling it out.

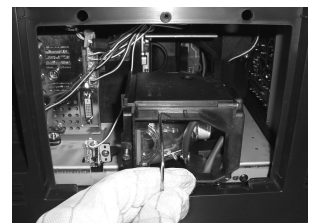
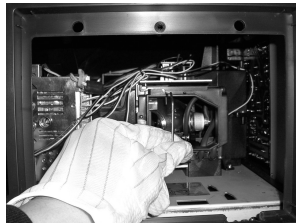

NOTES

- Be sure the replacement Lamp is the same type.
- After replacing the lamp, align the lamp cover with the groove and secure the screws.
- The TV will not turn on if the lamp cover is not correctly closed (as this will activate the protective circuit).

Appendix

Troubleshooting

If the TV seems to have a problem, first try this list of possible problems and solutions. If none of these troubleshooting tips apply, then call your nearest Samsung authorized service center.

| Problem | Possible Solution |
|---|---|
| Poor picture quality. | Try another channel. Adjust the antenna. Check all wire connections. |
| Poor sound quality. | Try another channel. Adjust the antenna. |
| No picture or sound. | Try another channel. Press the SOURCE button. Make sure the TV is plugged in. Check the antenna connections. Check that the Mute feature is off. |
| No color, wrong colors or tints. | Make sure the program is broadcast in color. Adjust the picture settings. |
| Picture rolls vertically. | Adjust the antenna. Check all wire connections. If you are using a VCR, check the tracking. |
| The TV operates erratically. | Unplug the TV for 30 seconds, then try operating it again. |
| Your remote control does not operate your TV. | Press the "TV" button to put your remote control into TV mode. Make sure the remote has batteries. |
| The TV won't switch on. | Make sure the wall outlet is working. Make sure the TV is plugged in. Make sure the remote has batteries. |
| Digital broadcasting screen problem. | Please check the digital signal strength and input antenna. |

Continued...

| Problem | Possible Solution |
|---|---|
| I want to view the clearest picture on in 1080p resolution. | <p>The best visual quality is obtained with 1080p input signal.</p> <p>→ To view TV in the best 1080p visual quality, connect to a PC whose graphic output is 1920 x 1080.</p> |
| The visual qualities of digital channels vary. | <p>The visual qualities of digital channels may vary depending on the original production method (analog or digital).</p> <p>→ If the original production method is digital: High visual quality program.</p> <p>→ If the original production method is analog: The digital program displayed on the screen is originally an analog program which has been converted. The visual quality is of an SD grade.</p> |
| Although the TV caption shows HD, the visual quality is not satisfactory. | <p>The HD caption that appears when switching channels or when pressing the Information button on the remote control means the selected channel is simply a digital channel. If the broadcasting station converts an analog signal into digital and transmits the signal, the visual quality may not be perfect.</p> <p>(Applied to Set Top Box built-in model only.)</p> |

- The display panel used for the DLP TV is composed of many tiny pixels. These pixels may occasionally appear on the screen.

Cleaning and Maintaining Your TV

Please follow these guidelines to get the maximum performance from your TV.

Placement

- Do not put the TV near extremely hot, cold, humid or dusty places.
- Do not place the TV near appliances with electric motors that create magnetic fields, such as vacuum cleaners.
- Keep the ventilation openings clear; do not place the TV on a soft surface, such as cloth or paper.
- Place the TV in a vertical position only.

Liquids

- Do not handle liquids near or on the TV. Liquids that spill into it can cause serious damage.

Cabinet

- Never open the cabinet or touch the parts inside.
- Wipe your TV with a clean, dry cloth. Never use water, cleaning fluids, wax, or chemicals.
- Do not put heavy objects on top of the cabinet.
- This DLP TV projects the image onto a large screen by applying an optical system. If you place the TV set face down, it might cause a problem because dirt, or some other contaminant may become attached to the inside of the TV set.

Temperature

- If your TV is suddenly moved from a cold to a warm place, unplug the power cord, and allow at least two hours for moisture that may have formed inside the unit to dry completely.

Using Your TV in Another Country

If you plan to take your TV with you to a foreign country, please be aware of the different television systems that are in use around the world. A TV designed for one system may not work properly with another system due to differences in the TV channel frequencies.

Specifications

| Model | HLS5087W | HL-S5687W | HL-S6187W |
|---------------------------|---|---|---|
| Dimensions (W x D x H) | 45.43 x 15.63 x 32.30 inches 1154 x 397 x 820.5 mm | 50.87 x 16.34 x 35.67 inches 1292 x 415 x 906 mm | 55.31 x 17.64 x 38.62 inches 1405 x 448 x 981 mm |
| Weight | 30.3 Kg / 66.8 lbs | 33.3 Kg / 73.41 lbs | 36 Kg / 79.37 lbs |
| TV System | NTSC ATSC (8VSB terrestrial) | American TV Standard ATSC compliant 8VSB | |
| Channel | Terrestrial (analog) Terrestrial (digital) Cable (analog) | 2-69 2-69 1-135 | |
| Component Video IN | 2 (Y Pb Pr) | 480i, 480p, 720p, 1080i, 1080p | |
| HDMI IN | 2 total | Video : 480i,480p,720p,1080i,1080p (EIA/CEA-861-B compliant) Audio : Two channel linear PCM 32, 44.1 and 48kHz | |
| PC IN | D-sub 15-pin, analog RGB | VESA (Refer to page 102 for detail) | |
| Speaker Output | 10W(L), 10W(R) | | |
| Voltage | AC110-120V | | |
| Frequency of Operation | 60Hz | | |
| Power Consumption | 230W In Use, Less than 1W In Standby | | |

NOTES

- Design and specifications are subject to change without prior notice.
- This device is a Class B digital apparatus.

***This page is intentionally
left blank.***

***This page is intentionally
left blank.***



Contact SAMSUNG WORLD-WIDE

If you have any questions or comments relating to Samsung products, please contact the SAMSUNG customer care center.

| Country | Customer Care Center ☎ | Web Site | Address |
|---------|-------------------------|--------------------|--|
| CANADA | 1-800-SAMSUNG (7267864) | www.samsung.com/ca | Samsung Electronics Canada Inc., Customer Service 55 Standish Court Mississauga, Ontario L5R 4B2 Canada |
| | | | Samsung Electronique Canada Inc., Service à la Clientèle 55 Standish Court Mississauga, Ontario L5R 4B2 Canada |
| U.S.A | 1-800-SAMSUNG (7267864) | www.samsung.com | Samsung Electronics America, Inc. 105 Challenger Road Ridgefield Park, NJ 07660-0511 |