

***myprojectorlamps.com***

**The most trusted, dependable name  
in projector lamp sales.**



<http://www.myprojectorlamps.com>



<http://www.myprojectorlamps.ca>



<http://www.myprojectorlamps.eu>

The following projector manual has not been modified or altered in any way.



DLPTV



**I N S T R U C T I O N M A N U A L**  
HL-P4667W/HL-P5067W/HL-P5667W/HL-P6167W



## A Guide to Digital TV

- **What is Digital Television?**

Digital television (DTV) is a new way of transmitting high quality video and audio to your TV set. Using DTV, broadcasters can transmit high definition TV (HDTV) images, Dolby digital surround audio, and new services such as multicasting (transmitting more than one program on the same TV channel) and datacasting. Several of these services can be combined into a single digital broadcast.

## Digital Television Services

- **Digital Picture Quality**

DTV programs are transmitted in two different formats. The first is Standard Definition Television (SDTV) and the second is High Definition Television (HDTV).

- **SDTV** program formats include 480-line interlaced (480i) and 480-line progressive (480p) video. 480i programs are essentially a digital version of our current analog TV programs, while the 480p format offers improved image detail over 480i. Some 480p programs are broadcast in widescreen and are comparable to progressive-scan DVD movies in image quality.
- **HDTV** program formats include 1080-line interlaced (1080i) and 720-line progressive (720p). Both HDTV formats are always broadcast in widescreen, and offer much higher picture quality than SDTV.
- **Dolby Surround Sound**  
With DTV, you can listen to a variety of Dolby digital audio formats from Dolby Surround 2.0 to Dolby Digital 5.1 surround, using your home audio system. Many HDTV programs are now broadcast with DD 5.1 soundtracks.

## CableCARD and Digital Cable Ready TVs

CableCARD and Digital Cable Ready TVs are the products of a new digital cable standard. This new standard is called OpenCable and it is a concerted effort to standardize the digital cable service network interface in North America. For more information, please refer to [www.cablelabs.com](http://www.cablelabs.com).

Digital Cable Ready TVs are equipped with a proper digital cable tuner to receive digital cable signals from your local cable service provider. They are also designed to work with digital cable card modules (PCMCIA card modules called CableCARDs). These PCMCIA card modules or CableCARDs will be provided by your local cable service provider after a proper subscription process.

The provided CableCARD from your local cable service provider needs to be inserted into the CableCARD slot of a Digital Cable Ready TV. Please refer to page 24 for how to insert the CableCARD.

A digital set-top box which used to be provided by the cable service provider is no longer needed with Digital Cable Ready TVs and CableCARDs.

When CableCARD is inserted into the slot, the TV screen will show the message that CableCARD is inserted and tries to download necessary data such as channel information or subscription information from your digital cable service provider. When you insert CableCARD for the first time, this process could take few minutes depending on the amount of data your cable provider needs to send. During this process the digital cable service provider or CableCARD may display messages on the TV screen to help or give you further information.

Please contact your local cable provider for more information on service availability and how to acquire a CableCARD.

### **NOTE**

- *This television receiver supports the copy protection system regulated by DTLA (Digital Transmission Licensing Administrator). It should be noted that copy protected content may not be viewable depending on your particular connections.*

## Q&A

### **1. Is the antenna I use for existing TV reception good enough for DTV?**

Over-the-air (OTA) digital TV broadcasting uses the same channels as analog TV and works well with many existing TV antennas. However, DTV broadcast channel assignments are different than analog channels. You should find out whether your local DTV broadcasts are on VHF (channels 2-13) or UHF (channels 14-69) to see if you need a different antenna.

If your DTV channels are on UHF and you already get good UHF reception, your present antenna may work fine. The same holds true for VHF DTV reception. Note that in some markets, both VHF and UHF channels are used for DTV broadcasts.

You can find out the latest DTV channel assignments for your area by browsing selected Internet web sites such as [www.titantv.com](http://www.titantv.com) and [www.fcc.gov](http://www.fcc.gov).

### **2. How difficult is it to receive DTV signals indoors?**

This depends on whether your local DTV stations are running full power or not and how close your location is to the transmission tower. DTV receivers do not require as much signal as analog TV receivers to produce high-quality images and sound.

Once the DTV signal level exceeds a certain threshold at the receiver, the digital video and audio data is decoded at the same quality it was originally encoded for broadcast.

This is a big advantage for DTV over analog TV - there is no noise, ghosting, static, or scratchy audio.

### **3. How can I connect an antenna in my townhouse, co-operative apartment, condominium, or apartment?**

The Federal Communications Commission's OTARD Rule (part of the Telecommunications Act of 1996) allows residents of condominiums, townhouse, or members of neighborhood associations to put up outside antennas for reception of broadcast TV signals as long as those antennas are not located in common areas and are no more than 12' in height.

Residents of rental units (apartments, etc.) are not covered by the OTARD rules and will have to use indoor antennas to receive DTV broadcasts. It is possible that the landlord of an apartment complex can provide broadcast DTV signals via a master TV antenna system to each apartment.

### **4. Can I connect my DTV set-top receiver to my cable TV service?**

Cable TV systems use a different method for transmitting digital TV programs that is currently incompatible with broadcast DTV set-top receivers. So you will still need to use an outdoor or indoor antenna to receive OTA broadcast DTV programs.

The good news is that you won't have to pay a monthly or per-program charge to watch OTA DTV and HDTV programs. They're free, unlike subscription satellite TV or premium cable TV. All you need is an antenna and a DTV set-top receiver to enjoy clear, sharp widescreen images and high-quality audio.

# Table of Contents

Your New Wide TV .....	10
Replacing the Lamp .....	10
List of Features .....	12
Accessories .....	12
Front Panel LED Indicators .....	13
Right side buttons .....	14
Side Panel Jacks .....	14
Rear Panel Jacks .....	15
Remote Control .....	16
Connections .....	20
Connecting VHF and UHF Antennas .....	20
Antennas with 300-ohm Flat Twin Leads .....	20
Antennas with 75-ohm Round Leads .....	20
Separate VHF and UHF Antennas .....	21
Connecting Cable TV and VCR .....	22
Cable without a Cable Box .....	22
Cable with a Cable Box that Descrambles All Channels .....	22
Connecting a Analog Cable Converter Box .....	23
Connecting a Analog Cable Converter Box and a VCR .....	23
Connecting CableCARD .....	24
Connecting a Camcorder .....	25
Connecting a DVD Player .....	26
Connecting to Y,PB,PR .....	26
Connecting to Audio and Video Jacks .....	26
Connecting a DTV Set-Top Box .....	27
Connecting to Y,PB,PR .....	27
Connecting to DVI (Digital Visual Interface) .....	27
Connecting to HDMI (High Definition Multimedia Interface) .....	28
Connecting a Digital Audio System .....	29
Connecting to an Analog Amplifier .....	29
Operation .....	32
Turning the TV On and Off .....	32
Viewing the Menus and On-Screen Displays .....	32
Selecting a Menu Language .....	33
Memorizing the Channels .....	34
Adding and Erasing Channels .....	36
Changing Channels .....	37
Customizing Your Remote Control .....	38
Remote Control Codes .....	39
Setting the Clock .....	40
Setting the Sleep Timer .....	42
Viewing an External Signal Source .....	43
Assigning Names to External Input Mode .....	44

Channel Control .....	46
Selecting Your Favorite Channels .....	46
Labeling the Channels .....	47
Fine Tuning Analog Channels <b>Analog</b> .....	48
Checking the Digital-Signal Strength <b>Digital</b> .....	49
LNA (Low Noise Amplifier).....	50
Picture Control.....	52
Picture Control.....	52
Selecting the Color Tone .....	54
Changing the Picture Size.....	55
Digital Noise Reduction .....	56
DNle™ (Digital Natural Image engine) <b>DNle™</b> .....	57
Setting the My Color Control Mode.....	58
Using the Color Weakness Enhancement Feature .....	60
Setting the Film Mode.....	61
Viewing Picture-In-Picture.....	62
Selecting the Sound Source .....	68
Freezing the Picture .....	69
Setting the Blue Screen Mode.....	70
Sound Control .....	72
Sound Control .....	72
Setting the SRS TSXT.....	74
Auto Volume.....	75
Choosing a Multi-Channel Sound (MTS) track <b>Digital</b> .....	76
Choosing a Multi-Channel Sound (MTS) track <b>Analog</b> .....	77
Choosing a Digital Sound Format <b>Digital</b> .....	78
Selecting the Internal Mute .....	79
Setting the On/Off Melody .....	80
Special Features .....	82
Setting the Function Help .....	82
Menu Transparency Level .....	83
Using the V-Chip .....	84
Viewing Closed Captions (On-Screen Text Messages) <b>Analog</b> .....	90
Viewing Closed Captions (On-Screen Text Messages) <b>Digital</b> .....	92
Using the CableCARD .....	94
Using the CableCARD Reset Function .....	95
Using the Guide.....	97
Appendix.....	100
Troubleshooting .....	100
Cleaning and Maintaining Your TV .....	101
Using Your TV in Another Country.....	101
Specifications .....	101



---

S  
A  
M  
S  
U  
N  
G



# **Your New Wide TV**



# Your New Wide TV

## Replacing the Lamp

- **Why do I need to replace the lamp?**

The lamp used in a DLP TV has a limited lifespan. For the best screen quality it needs to be replaced periodically. After replacing the lamp, the screen quality will be bright and clear as new.

- **When do I need to replace it?**

It should be replaced when the screen becomes darker, less clear or when all three LEDs on the front (Timer, Lamp, & Temp.) are flashing.

- **Check before lamp replacement**

1. The lamp must be the same code number and type.
2. The lamp type is indicated on the right side of the TV. It is also indicated on the lamp case.
3. After checking the code number for the lamp, give the code number to the store where you purchased the TV or to a Samsung Service center.

- **Caution**

1. Replace with the correct code numbered lamp to avoid damage to the TV.
2. Turn the power off and wait for 30 minutes before replacing the lamp as it will be hot.
3. Do not touch the glass part of the lamp with your bare hands nor insert any foreign object inside the cover as it may cause poor screen quality, electric shock or fire.
4. Do not place the old lamp near flammable objects or within the reach of children.

- For replacement, you will need a 5.91-Inch screwdriver and a pair of gloves.

1 Unplug TV, then use a screwdriver to remove the screw.



2 Remove the Lamp cover.



3 Remove the screw securing the Lamp by using a screwdriver.

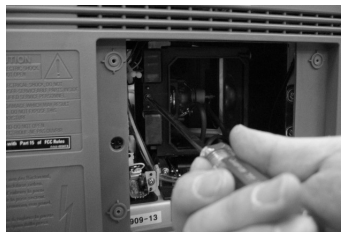

4 Separate the Lamp from the engine by holding the handle and pulling it out.

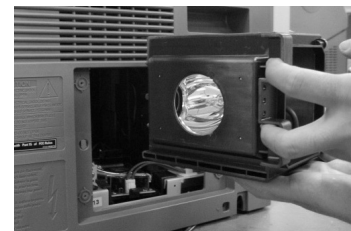

5 To reinstall the Lamp, follow these steps in reverse order.

## NOTES

- Be sure the replacement Lamp is the same type.
- After replacing the lamp, align the lamp cover with the groove and secure the screws.
- The TV will not turn on if the lamp cover is not correctly closed (as this will activate the protective circuit).

# Your New Wide TV

## List of Features

Your TV was designed and engineered using the latest technology. It is a full-featured, high-performance unit that exceeds industry standards. In addition, it has these special features:

- Easy-to-operate remote control
- Easy-to-use on-screen menu system you can access from the side panel or remote control
- Automatic timer to turn the TV on and off at any time you choose
- Adjustable picture and sound settings and the ability to memorize your favorite settings
- Automatic channel tuning for up to 181 channels
- A special filter to reduce or eliminate reception problems
- Fine tuning control for the sharpest picture possible
- A built-in multi-channel sound decoder for stereo and bilingual listening
- Built-in, dual channel speakers
- A special sleep timer
- Picture-in-Picture capability that let you watch two channels at once
- Widescreen TV with adjustable image size
- Life-like clear images provided by DNle technology
- My Color Control Mode for corresponding with your color style
- Color weakness Mode
- Digital Input (Digital Visual Interface) jack
- Digital Audio Output (OPTICAL) jack
- AV network system (Anynet) that enables you to easily control Samsung audio-video(AV) devices from this TV.
- CableCARD slot

## Accessories

Once you have unpacked your TV, check to make sure that you have all the parts shown here. If any piece is missing or broken, call your dealer.

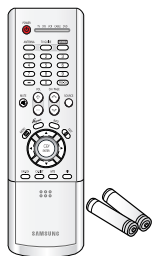

**Remote Control  
(BP59-00076A)/  
AAA Batteries**

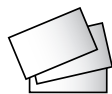

**Warranty Cards (2)/  
Registration Card (1)**



**Instruction Manual/  
Safety Guide/  
Quick Guide/  
Anynet Manual**



**Anynet Cable**

## Front Panel LED Indicators

The three lights on the front panel indicate the status of your TV.

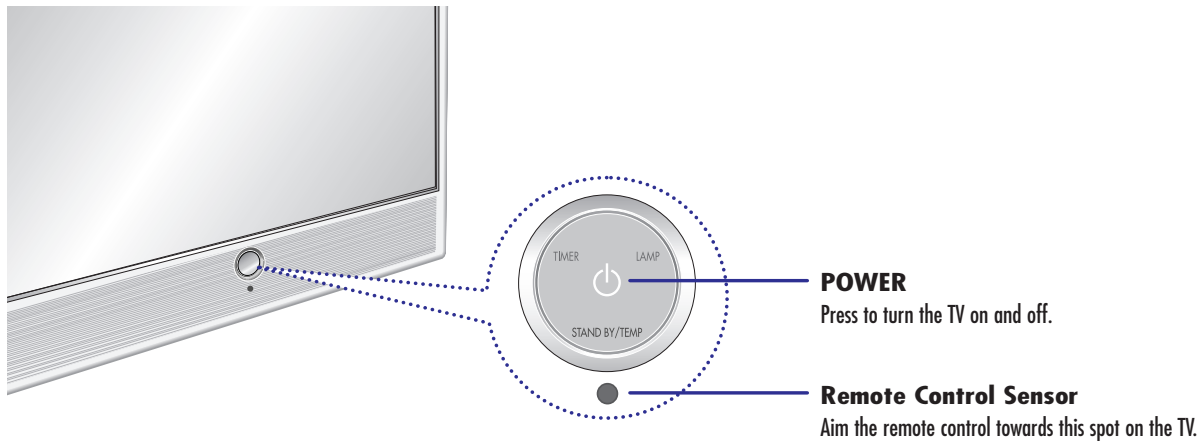

- : Light is On
- ◐ : Light is Blinking
- : Light is Off

TIMER	LAMP	STAND BY/TEMP	Indication
○	○	●	Standby state.
○	◐	○	The picture will automatically appear in about 15 seconds.
●	◐	○	Auto Timer ON/OFF has been set and the unit will automatically be turned on in about 25 seconds.
◐	○	◐	A cooling fan inside the set is not operating normally.
○	◐	◐	Lamp cover on rear of the set is not properly shut.
○	○	◐	Check if the ventilation hole on the rear of the set is blocked, because if the inner temperature is too high, the power will shut off.
◐	◐	◐	Lamp may be defective. Please contact a certified technician.

- It takes about 30 seconds for the TV to warm up, so normal brightness may not appear immediately.
- The TV has a fan to keep the inside lamp from overheating. You'll occasionally hear it working.

# Your New Wide TV

## Right side buttons

The buttons on the right side panel control your TV's basic features, including the on-screen menu system. To use the more advanced features, you must use the remote control.

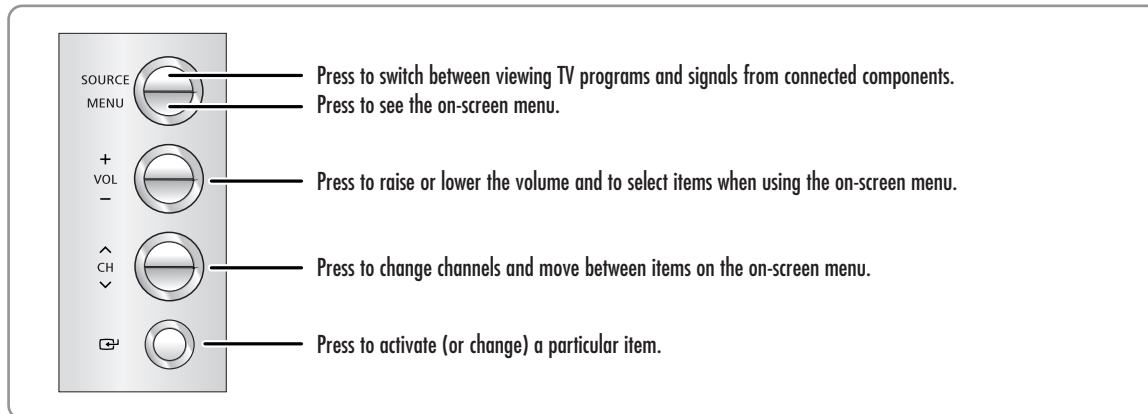

## Side Panel Jacks

Use the rear of right side panel jacks to connect a component that is used only occasionally (a camcorder or video game, for example).

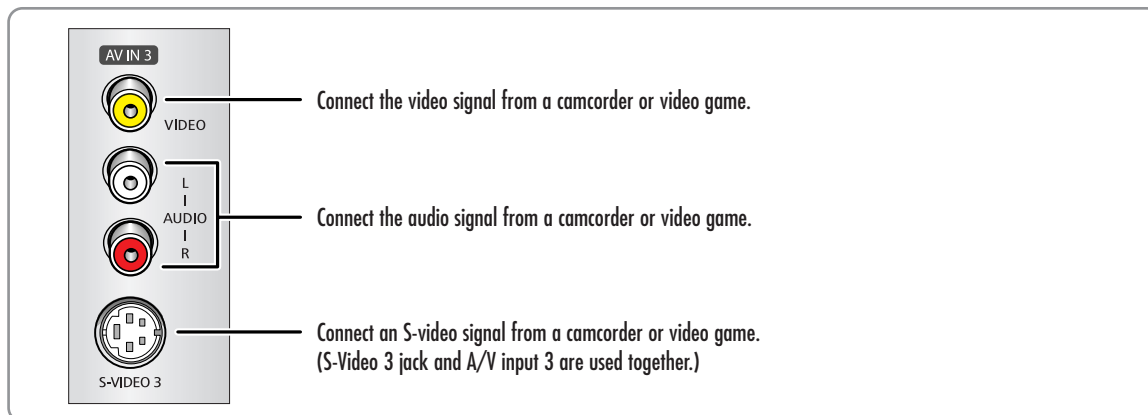

## Rear Panel Jacks

Use the rear panel jacks to connect components such as a VCR. You can connect different components such as VCRs, Set-Top Box and a DVD player etc., because there are two sets of video input jacks and two sets of component video input jacks on the rear panel of your TV. For more information, please see "Connections".

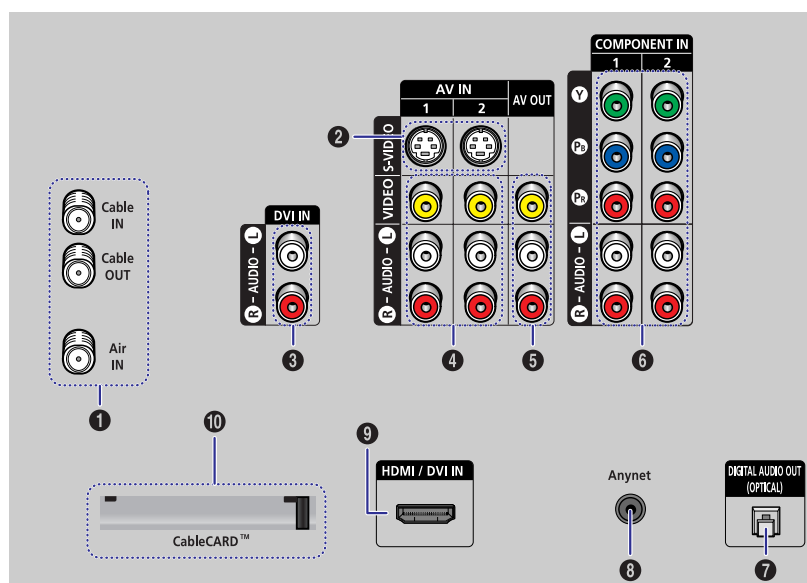

- 1 ANTENNA terminals**  
Two independent cables or antennas can be connected to these terminals. Use "Cable IN" and "Air IN" terminals to receive a signal from VHF/UHF antennas or your cable system. Use the "Cable OUT" terminal to send the signal being received by the "Cable IN" terminal out to another component (such as a Cable Set-Top Box). (Refer to page 20)
- 2 S-VIDEO INPUT jacks**  
Connects an S-Video signal from an S-VHS VCR or DVD player. (Refer to page 25)
- 3 DVI (Digital Video Interface) AUDIO INPUT jacks**  
Connect to the digital audio output jacks of a device with DVI output. (Refer to page 27)
- 4 VIDEO/AUDIO INPUT jacks**  
Connect video/audio signals from external sources, such as VCR or DVD players. (Refer to page 26)
- 5 VIDEO/AUDIO OUTPUT jacks**  
Sends a video signal from the TV to an external source, such as a VCR. Note: It is available only in RF, Video and S-Video modes.
- 6 Component 1, 2 jacks (Y, PB, PR, L, R)**  
Use these jacks to connect the component video/audio signals from a DVD player or a set-top box. (Refer to page 26~27)
- 7 DIGITAL AUDIO OUT(OPTICAL) jack**  
Connect to a Digital Audio Component. (Refer to page 29)
- 8 Anynet**  
Please refer to the Anynet Owner's Instruction. This jack is for repair and software upgrades.
- 9 HDMI (High Definition Multimedia Interface)/ DVI INPUT jack**  
Connect to the HDMI jack of a device with HDMI output. Connect to the digital video output jack for device with DVI output. (Refer to page 27~28)
- 10 CableCARD™**  
Insert the CableCARD into the slot. (Refer to page 24)



# Your New Wide TV

## Remote Control

You can use the remote control up to about 23 feet from the TV. When using the remote control, always point it directly at the TV. You can also use your remote control to operate your VCR, Cable box, DVD player or Samsung Set-Top Box. See pages 38~39 for details.

### 1. POWER

Turns the TV on and off.

### 2. P.MODE

Adjust the TV picture by selecting one of the preset factory settings (or select your personal, customized picture settings.)

### 3. ANTENNA

Press to select "AIR" or "CABLE".

### 4. CHANNEL NUMBER

Press to directly tune to a particular channel.

### 5. -

Press to select additional channels (digital and analog) being broadcast by the same station. For example, to select channel "54-3", press "54", then press "-" and "3".

### 6. VOL +, VOL -

Press to increase or decrease the volume.

### 7. MUTE

Press to mute the TV sound.

### 8. ANYNET

Runs the Anynet view functions and sets up Anynet devices.

### 9. MENU

Displays the main on-screen menu.

### 10. CH.LIST

Displays the channel list.

### 11. FAV.CH (Favorite Channel)

Press to switch between your favorite channels.

### 12. MODE

Selects a target device to be controlled by the Samsung remote control (i.e., TV, STB, VCR, CABLE, or DVD).

### 13. PRE-CH

Tunes to the previous channel.

### 14. SOURCE

Press to display all of the available video sources (i.e., TV, Set-Top box, VCR, DVD, DTV).

### 15. CH ^/∨

Press to change channels.

Moves from one set of screen information to the next in TV Guide menu.

### 16. INFO

Press to display information on the TV screen.

### 17. EXIT

Press to exit the menu.

### 18. ▲, ▼, ◀, ▶, ENTER

Press to select highlight up, down, left, or right. While using the on-screen menus, press the ENTER to activate (or change) a particular item.

### 19. MTS (Multichannel Television Stereo)

Press to choose Stereo, Mono or SAP (Secondary Audio Program).

### 20. PIP (Picture In Picture)

Displays the available channels in sequence. (These buttons change channels in the PIP window only.)

### 21. STILL

Press to pause the current screen.

### 22. ASPECT

Press to change the screen size.

### 23. SRS

Activates TruSurround.

### 24. DNIe (Digital Natural Image engine)

Activates DNIe.

### 25. SET

Used during set up of this remote control, so that it will work compatibly with other devices (Set-Top box, VCR, Cable box, DVD, etc.)

### 26. SLEEP

Press to select a preset time interval for automatic shut off.

### 27. PIP Controls

CH ^/∨; Press to display the available channels in sequence. (These buttons change channels in the PIP window only.)

### 28. CAPTION

Controls the caption decoder.

### 29. VCR/DVD Controls

Controls VCR or DVD functions: Rewind, Stop, Play/Pause, Fast Forward.

### 30. RESET

If your remote control is not functioning properly, take out the batteries and press the reset button for about 2~3 seconds. Re-insert the batteries and try using the remote control again.

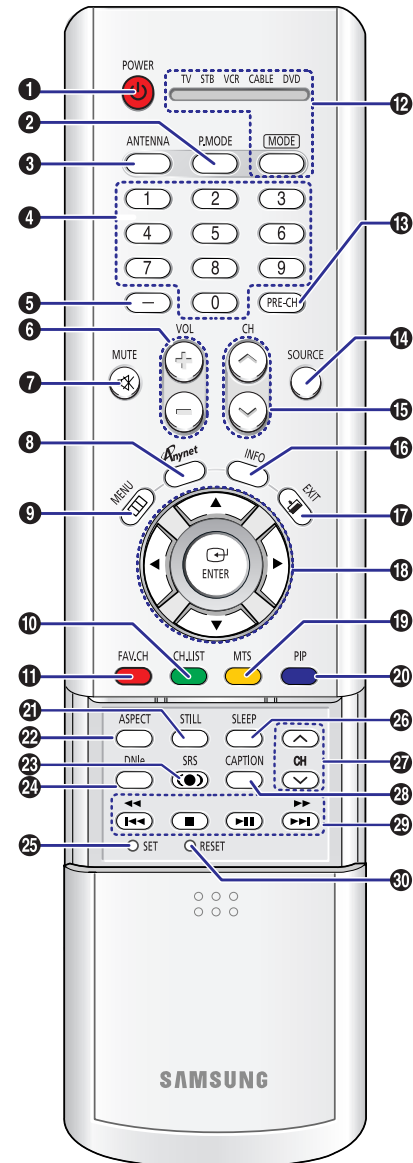

## Installing Batteries in the Remote Control

With normal use, the batteries in the remote control should last about a year. If you notice a performance degradation while using the remote, the batteries may need to be replaced. Make sure you replace both batteries and do not mix old and new batteries in the remote control. If you won't be using the remote control for a long time, remove the batteries and store them in a cool dry place.

- 1 Slide the back cover all the way out to open the battery compartment of the remote control.

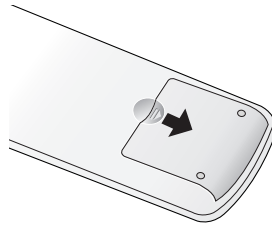

- 2 Install two AAA size batteries. Make sure to match the "+" and "-" ends of the batteries with the diagram inside the compartment.

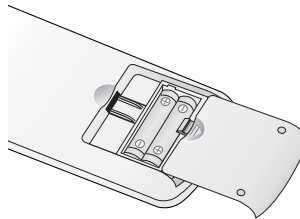

- 3 Slide the cover back into place.

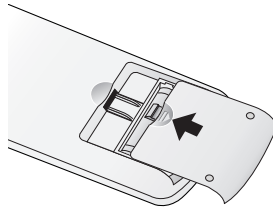

### NOTE

- Do not mix battery types, i.e., alkaline and manganese.

S  
A  
M  
S  
U  
N  
G



# Connections

# Connections

## Connecting VHF and UHF Antennas

If you do not have a cable system, you will need to connect an antenna to your TV.

### Antennas with 300-ohm Flat Twin Leads

If your antenna looks like this:  it has 300-ohm flat twin leads.

- 1 Place the wires from the twin leads under the screws on the 300-75 ohm adaptor (not supplied). Use a screwdriver to tighten the screws.

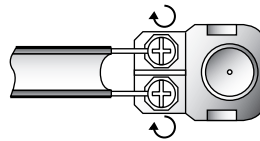

- 2 Plug the adaptor into the "Air IN" terminal on the rear panel.

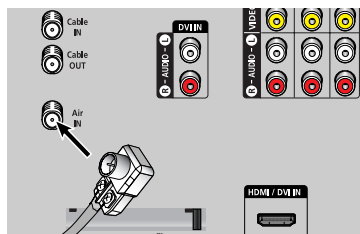

### Antennas with 75-ohm Round Leads

If your antenna looks like this:  it is an antenna with 75-ohm round leads.

- 1 Plug the antenna lead into the "Air IN" terminal on the rear panel.

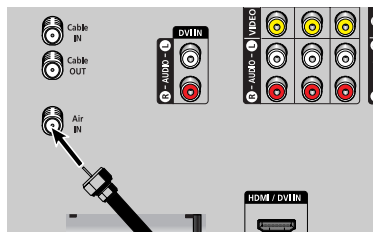

## Separate VHF and UHF Antennas

If you have two separate antennas for your TV (one VHF and one UHF), you must combine the two antenna signals before connecting the antennas to the TV. This procedure requires an optional combiner-adaptor (available at most electronics shops).

- 1 Connect both antenna leads to the combiner.

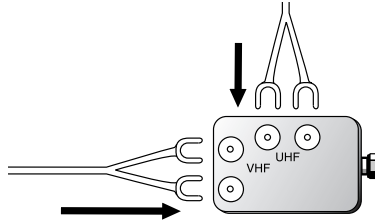

- 2 Plug the combiner into the "Cable IN" terminal on the rear panel.

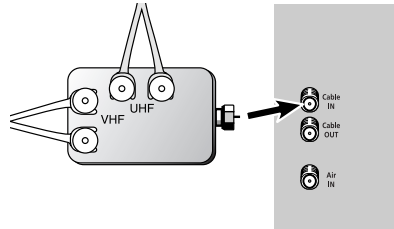

# Connections

## Connecting Cable TV and VCR

You can connect different cable systems to your TV, including cable without a cable box, and cable with a cable box that descrambles some or all channels.

### Cable without a Cable Box

If you want to connect cable, and you do not need to use a cable box:

- 1 Plug the incoming cable into the "Cable IN" terminal on the rear panel.

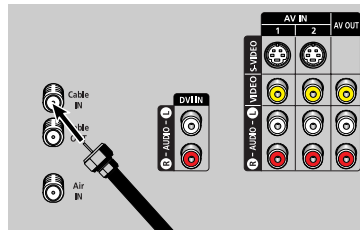

### Cable with a Cable Box that Descrambles All Channels

- 1 Find the cable that is connected to the ANTENNA OUT terminal on your cable box. This terminal might be labeled "ANT OUT", "VHF OUT" or simply, "OUT".

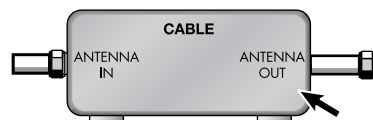

- 2 Connect the other end of this cable to the "Cable IN" terminal on the rear panel.

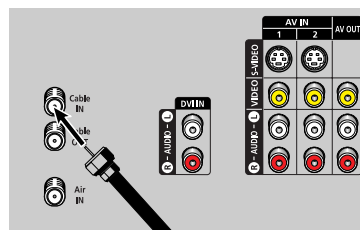

## Connecting an Analog Cable Converter Box

This connection allows you to watch cable and premium channels. You should keep your TV selected to "Cable IN" so that you can use the TV features. When viewing premium channels, select "Air IN" and tune the TV to channel 3 or 4 (whichever channel is vacant in your area), then use the converter box to change channels. You will need two coaxial cables.

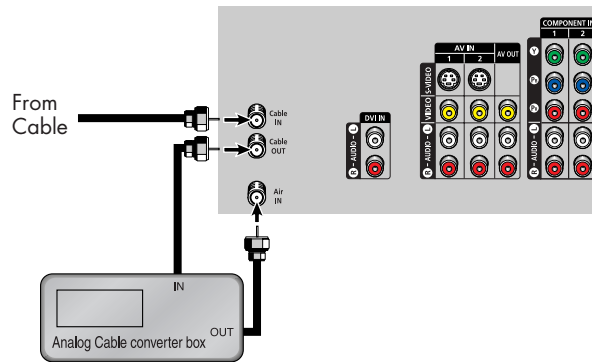

### NOTES

- When you use a converter box with your TV, there may be features that you can not program using the remote control, such as programming your favorite channels and blocking channels.
- The output from "Cable OUT" is available when "Air IN" is selected in the "Antenna" channel menu.

## Connecting an Analog Cable Converter Box and a VCR

This connection allows you to watch and record basic and premium cable channels, as well as watch videotapes. You should keep your TV selected to "Cable IN" so that you can use the TV's features. When viewing premium channels or recording with the VCR, select "Air IN" (whichever channel is vacant in your area), then use the converter box to change channels.

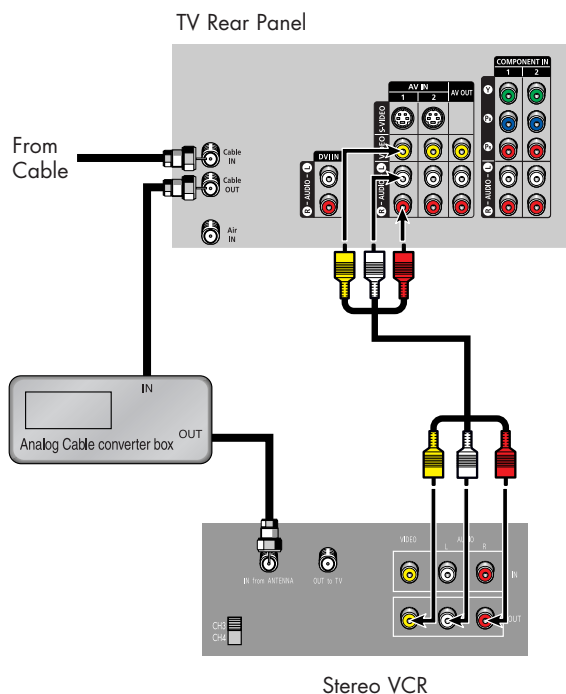

Caution: If you want to record one channel while watching another channel, a splitter (not included) must be added between the cable and "Cable IN". One output of the splitter goes to "Cable OUT" and the second output is connected to IN on the cable converter box.

If you have a mono VCR, connect L/Mono to VCR Audio OUT using only one audio cable.

If you have an S-VHS VCR, use the S-Video connections and remove the video cable. Do not connect the video cable and the S-Video cable to video1 simultaneously.

When you use a converter box with your TV there may be features that you can not program using the remote control, such as programming your favorite channels and blocking channels.



# Connections

## Connecting CableCARD

You must obtain a CableCARD from a local cable service provider.

- 1 Insert the CableCARD into the "CableCARD" slot and the message "CableCARD Inserted" is displayed on the screen. If the channel information does not already exist, the message "Updating Channel List" is displayed during channel information configuration.
- 2 The pairing information containing a telephone number, CableCARD ID, Host ID and other information will be displayed in about 2~3 minutes. If an error message is displayed, please contact your Service Provider.
- 3 When channel information configuration is finished, the message "Updating Completed" is displayed. It indicates that the channel list is now updated.

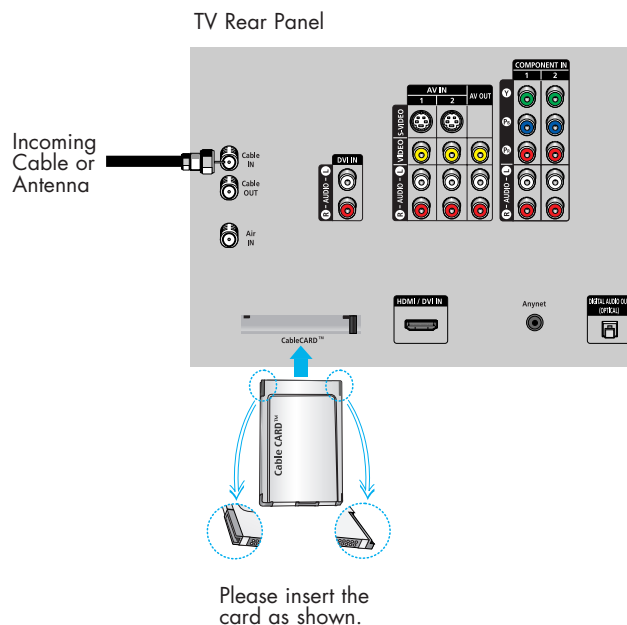

## Connecting a Camcorder

The side panel jacks on your TV make it easy to connect a Camcorder to your TV. You can use your camcorder to view tapes without using a VCR.

**1** Locate the A/V output jacks on the camcorder. They are usually found on the side or back of the camcorder.

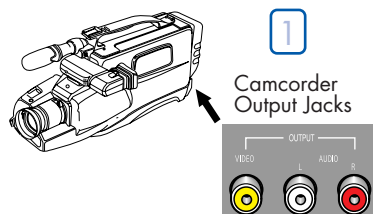

**2** Connect a set of audio cables between the AUDIO IN jacks on the TV and the AUDIO OUT jacks on the camcorder. If you have a mono Camcorder, connect L(mono) to the Camcorder audio out using only one audio cable.

**3** Connect a video cable between the VIDEO IN (or S-VIDEO IN) jack on the TV and the VIDEO OUT jack on the Camcorder. The audio-video cables shown here are usually included with a Camcorder. (If not, check your local electronics store.) If your Camcorder is stereo, you need to connect a set of two cables.

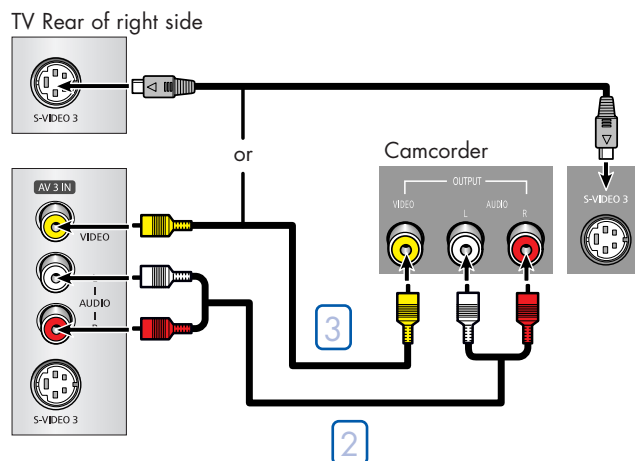

# Connections

## Connecting a DVD Player

The rear panel jacks on your TV make it easy to connect a DVD player to your TV.

### Connecting to Y,PB,PR

1 Connect a set of audio cables between the COMPONENT (1 or 2) AUDIO (L,R) IN jacks on the TV and the AUDIO OUT jacks on the DVD player.

2 To enable Component video viewing, connect a set of video cables between the COMPONENT (1 or 2) VIDEO (Y, PB, PR) IN jacks on the TV and VIDEO (Y/PB/PR or Y/CB/CR) OUT jacks on the DVD player.

Note: For an explanation of Component video, see your DVD player's owner's manual.

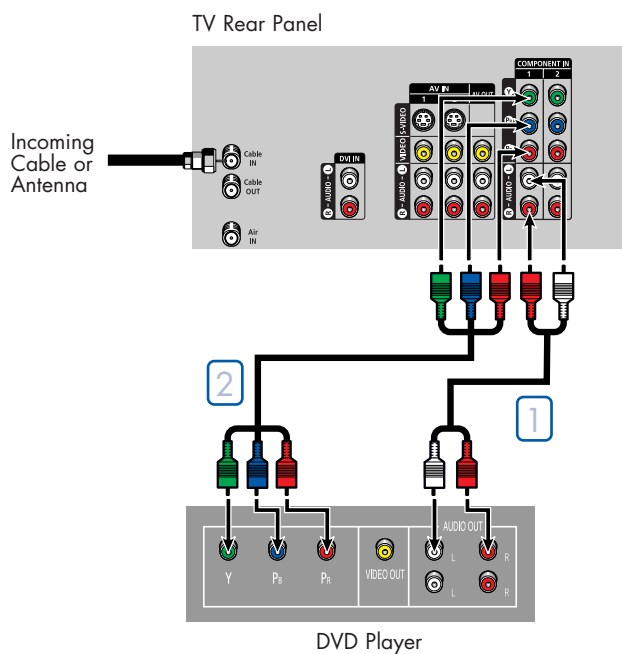

### Connecting to Audio and Video Jacks

1 Connect a set of audio cables between the AUDIO IN (1 or 2) jacks on the TV and the AUDIO OUT jacks on the DVD player.

2 Connect a video cable between the VIDEO IN (1 or 2) jack on the TV and the VIDEO OUT jack on the DVD player.

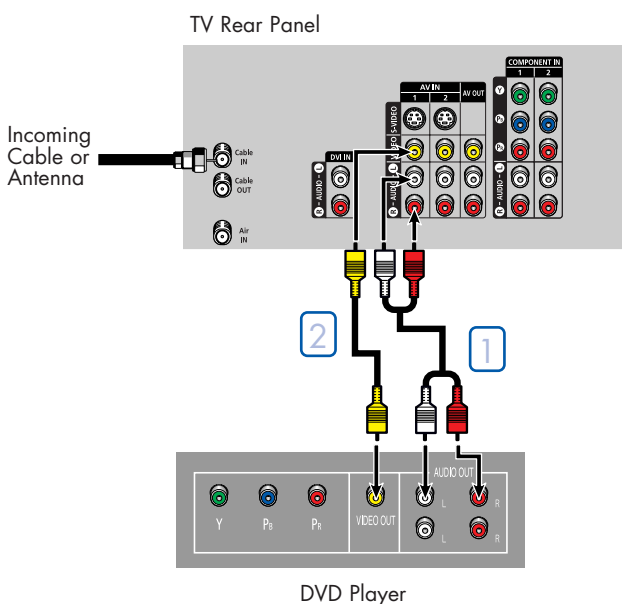

## Connecting a DTV Set-Top Box

### Connecting to Y,Pb,Pr

- 1 Connect a set of audio cables between the COMPONENT (1 or 2) AUDIO (L,R) IN jacks on the TV and the AUDIO OUT jacks on the Set-Top Box.
- 2 Connect a set of video cables between the COMPONENT (1 or 2) VIDEO (Y, Pb, Pr) IN jacks on the TV and VIDEO (Y/Pb/Pr or Y/Cb/CR) OUT jacks on the Set-Top Box. Note: For an explanation of Component video, see your Set-Top Box owner's manual.

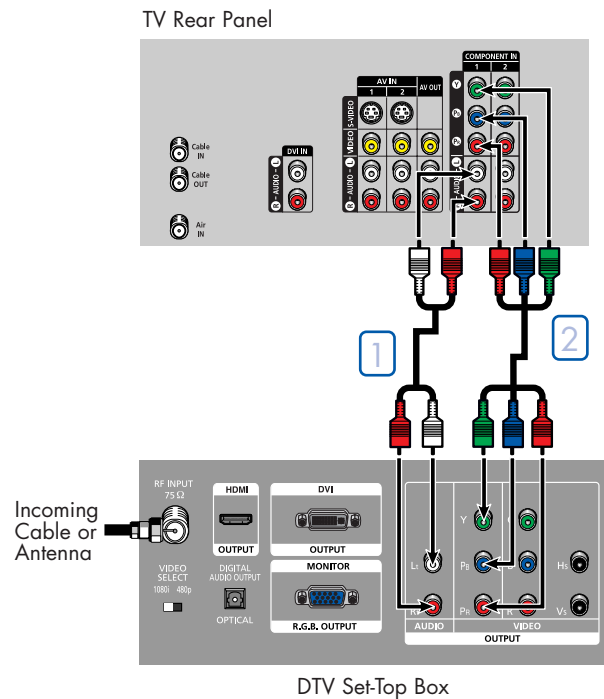

### Connecting to DVI (Digital Visual Interface)

- 1 Connect a set of audio cables between the DVI AUDIO (L,R) IN jacks on the TV and the AUDIO OUT jacks on the Set-Top Box.
- 2 Connect an HDMI/DVI video cable between the HDMI/DVI IN jack on the TV and the DVI OUT jack on the Set-Top Box.

#### NOTE

- Requires a Cable Converter.

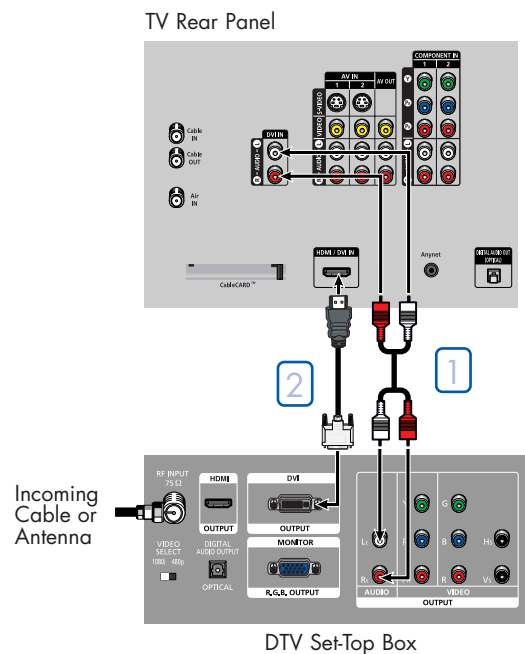

# Connections

## Connecting to HDMI (High Definition Multimedia Interface)

- 1 Connect an HDMI cable between the HDMI/DVI IN jack on the TV and the HDMI OUT jack on the Set-Top Box.

### NOTE

- Make sure the HDMI/DVI source's power is on, or you will be unable to select it in the menu's source list.

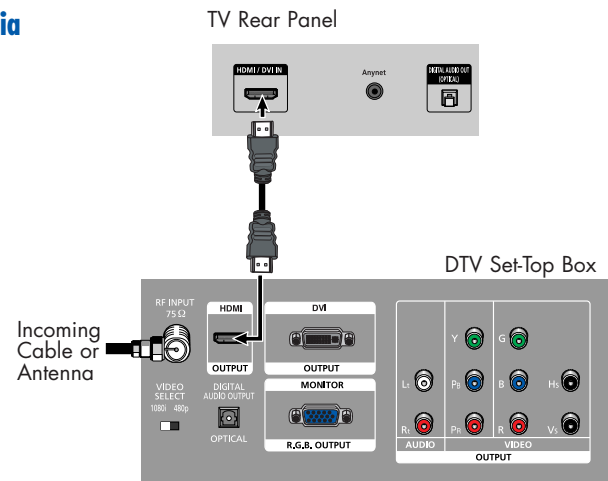

## Connecting a Digital Audio System

There are many types of digital audio systems on the market today. A simplified illustration of an audio system is shown below. For more information, see your audio system owner's manual.

- 1 If your audio system has a optical digital audio input, connect to the "DIGITAL AUDIO OUT(OPTICAL)" jack on the TV. Be certain to remove the black cover from the optical output before inserting the cable.

### NOTE

- *OPTICAL: converts the electric signal into an optical light signal, and transmits it through glass fibers. A transmission system of digital audio in the form of a light wave, S/PDIF format using a glass conductor. See page 78 to set the digital output format (Dolby Digital or PCM) appropriate to you digital audio component.*

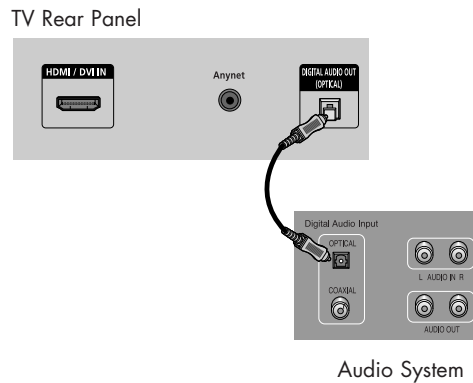

## Connecting to an Analog Amplifier

- 1 The "AUDIO OUT" terminals cannot be used for external speakers. You must hook them up to an amplifier. When an audio amplifier is connected to the "AUDIO OUT" terminals: Decrease the gain (volume) of the audio amplifier, and adjust the volume level with the volume control on the TV.

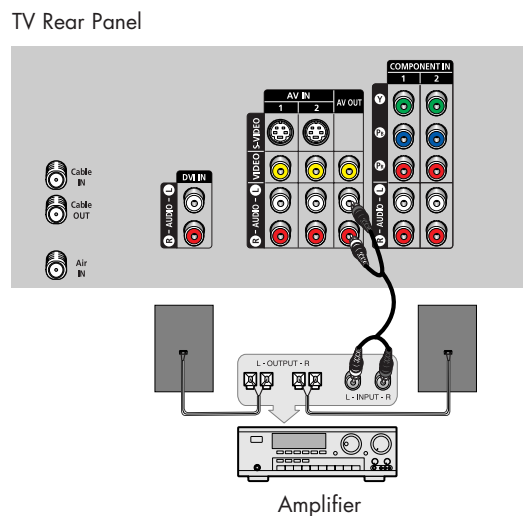

S  
A  
M  
S  
U  
N  
G



**Operation**



# Operation

## Turning the TV On and Off

Press the POWER button on the remote control.  
You can also use the POWER button on the front panel.

## Viewing the Menus and On-Screen Displays

The on-screen menu system allows you to control the settings of your TV. Access the on-screen menu system by pressing the MENU button on the remote control. Once the on-screen menu appears, use the ▲/▼/◀/▶/ENTER buttons on your remote control to select menu items and make adjustments. You can also view the on-screen menu system and make some adjustments using the TV's side panel buttons.



### Viewing the Menus

- 1 Press the MENU button.  
The main menu is displayed.  
There are six menu groups: "Input", "Picture", "Sound", "Channel", "Setup", and "Guide".

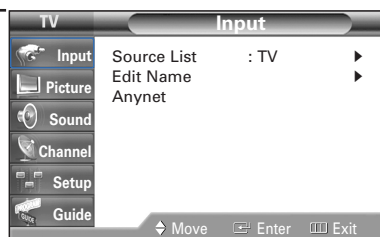

- 2 Press the ▲ or ▼ button to select an item you want in the menu.  
Press the ◀, ▶ or ENTER button to display, change, or use the selected items.  
Use the ENTER button to enter items in the menu.

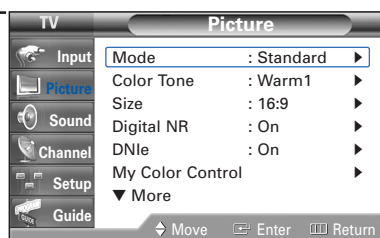

- 3 Press the EXIT button to exit.

### Viewing the Display

Press the INFO button on the remote control.  
The TV displays the current channel, the status of certain picture and sound settings and the current time.  
The information displayed varies according to the selected source.

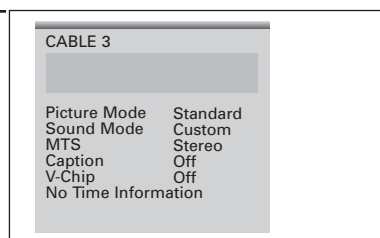

## Selecting a Menu Language



- 1 Press the MENU button.  
Press the ▲ or ▼ button to select "Setup", then press the ENTER button.

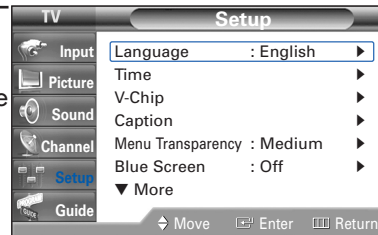

- 2 Press the ENTER button to select "Language".  
Press the ▲ or ▼ button to select "English", "Español" or "Français", then press the ENTER button.

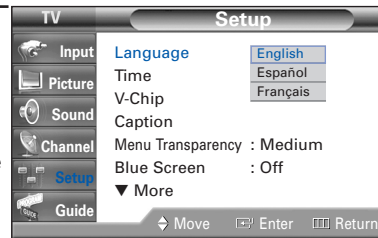

Press the EXIT button to exit.

# Operation

## Memorizing the Channels

Your TV can memorize and store all of the available channels for both “off-air” (antenna) and cable channels. After the available channels are memorized, use the CH  $\wedge$  and CH  $\vee$  buttons to scan through the channels. This eliminates the need to change channels by entering the channel digits. There are three steps for memorizing channels: selecting a broadcast source, memorizing the channels (automatic) and adding and deleting channels (manual).

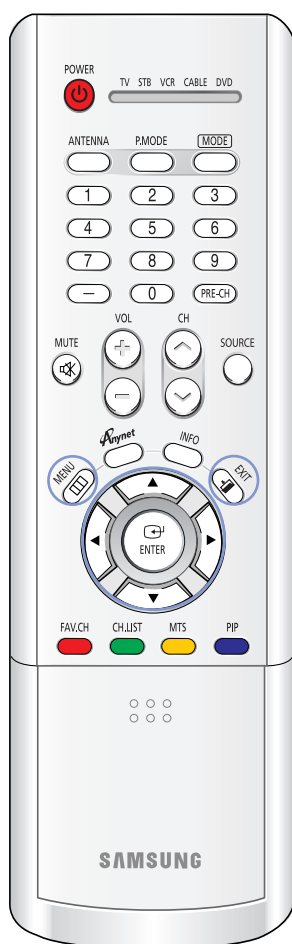

### Selecting the Video Signal Source

Before your television can begin memorizing the available channels, you must specify the type of signal source that is connected to the TV (i.e., an antenna or cable system).

- 1 Press the MENU button. Press the  $\blacktriangle$  or  $\blacktriangledown$  button to select “Channel”, then press the ENTER button.

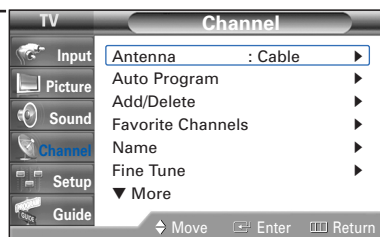

- 2 Press the ENTER button to select “Antenna”. Press the  $\blacktriangle$  or  $\blacktriangledown$  button to select “Air” or “Cable”, then press the ENTER button.

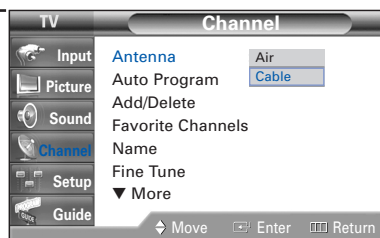

- 3 Press the  $\blacktriangle$  or  $\blacktriangledown$  button to select “Auto Program”, then press the ENTER button.

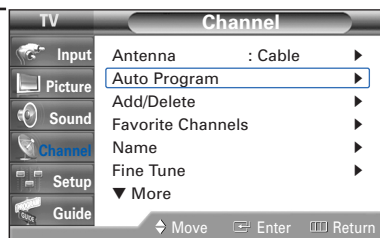

### NOTE

- All available DTV and analog channels are automatically stored in memory.

4 Press the ▲ or ▼ button to select the Antenna connection, then press the ENTER button.

- Air : "Air" antenna signal  
Cable : "Cable" antenna signal  
Air+Cable : "Air" and "Cable" antenna signals
- If the CableCARD is inserted into the "CableCARD" slot on the rear panel, "Cable" and "Air+Cable" are not available.

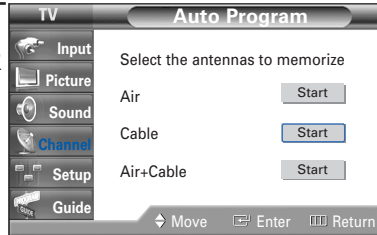

When selecting Cable TV system:  
Press the ▲ or ▼ button to select "Cable", then press the ENTER button.  
Press the ▲ or ▼ button to select "STD", "HRC" or "IRC" then press the ENTER button.

- STD, HRC and IRC identify various types of cable TV systems.  
Contact your local cable company to identify the type of cable system that exists in your particular area.  
At this point the signal source has been selected. Proceed to "Storing Channels in Memory".

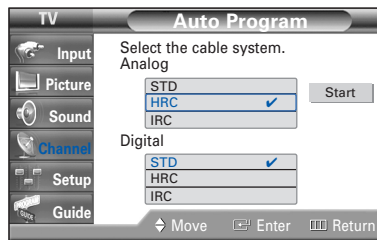

5 Press the ► button to select "Start" button, then press the ENTER button to start the auto program. The TV begins memorizing all available stations. Press the ENTER button at any time to interrupt the memorization process.

Press the EXIT button to exit.

- The TV MUST be connected to an antenna in order to receive digital TV signals. Even if a particular channel is deleted from the memory, you can always tune to that channel directly by using the number buttons on the remote control.

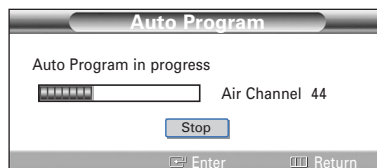
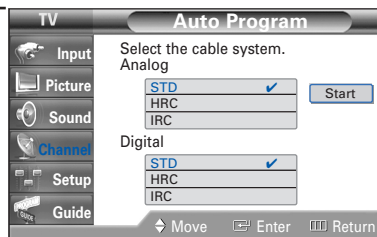

# Operation

## Adding and Erasing Channels

You can add channels that were not memorized (or delete unwanted channels from memory).

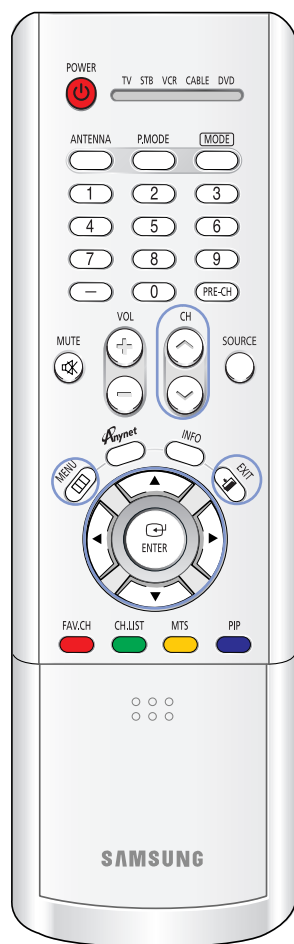

- 1 Press the MENU button.  
Press the ▲ or ▼ button to select "Channel", then press the ENTER button.

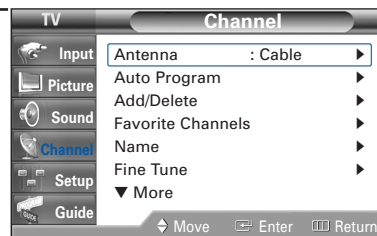

- 2 Press the ▲ or ▼ button to select "Add/Delete", then press the ENTER button.

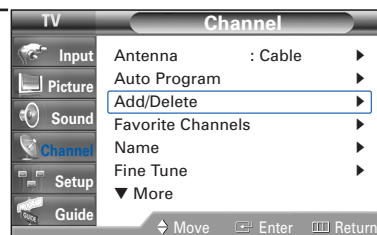

- 3 Repeatedly pressing the ENTER button will alternate between add channel and delete channel.  
Press the CH ▲ or CH ▼ button to switch to the appropriate channel, then repeat above.

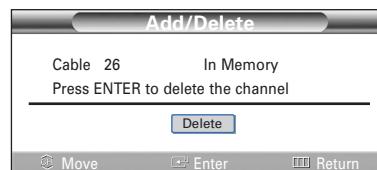

Press the EXIT button to exit.

## Changing Channels

### Using the Channel Buttons

Press the CH  $\wedge$  or CH  $\vee$  button to change channels.

When you press the CH  $\wedge$  or CH  $\vee$  button, the TV changes channels in sequence. You will see all the channels that the TV has memorized. (The TV must have memorized at least three channels.) You will not see channels that were either erased or not memorized.

### Using the Number Buttons

Use the number buttons to quickly switch to any channel.

Press the number buttons to go directly to a channel. For example, to select channel 27, press "2," then "7." The TV will change channels when you press the second number.

### Using the "-" Button

The "-" button is used to select stations that broadcast both a digital and analog signal.

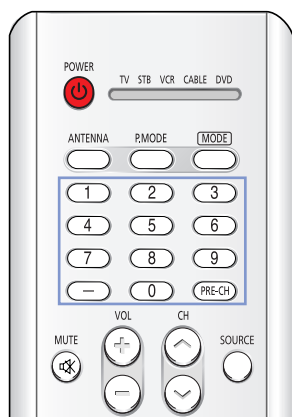

#### NOTE

- HD indicates the TV is receiving a Digital High Definition signal.
- SD indicates the TV is receiving a Analog standard definition signal.

For example, for channel 7-1 (digital), press "7", then "-", then "1".

DTV Air 7-1	
English	
Picture Mode	Standard
Sound Mode	Standard
MTS	English
Caption	On
V-Chip	Off
5:21 am	

For channel 7-2 (analog), press "7", then "-", then "2".

AIR 7-2	
Mono	
Picture Mode	Standard
Sound Mode	Standard
MTS	Stereo
Caption	On
V-Chip	Off
5:21 am	

### Using the Previous Channel

Press the PRE-CH button. The TV changes to the last channel you were watching.

# Operation

## Customizing Your Remote Control

Your TV comes equipped with a universal remote control. In addition to controlling the TV, the universal remote control can also operate a VCR, Cable box, DVD, and Samsung Set-Top Box (even if your VCR, Cable box and DVD are made by manufacturers other than Samsung).

### NOTE

- The remote control might not be compatible with all VCRs, DVD players and Cable boxes.

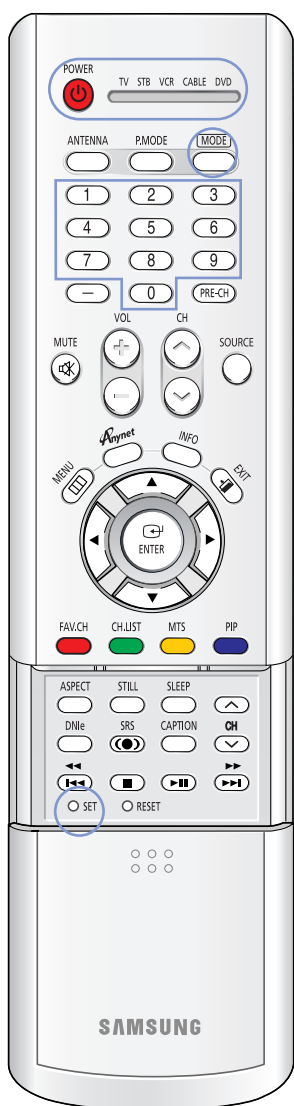

### Setting Up Your Remote Control to Operate Your VCR (Cable box or DVD player)

- 1 Turn off your VCR (Cable box or DVD player).
- 2 Press the MODE button to switch the remote control to the VCR (CABLE or DVD) mode.  
The remote control has five modes: TV, STB, VCR, CABLE, and DVD.
- 3 On your Samsung remote control, press the SET button.
- 4 Enter 3 digits of the VCR (Cable box or DVD player) code listed on next page for your brand of VCR (Cable box or DVD player).  
Make sure you enter 3 digits of the code, even if the first digit is a "0". (If more than one code listed, try the first one.)
- 5 Press the POWER button. Your VCR (Cable box or DVD player) should turn on. If your VCR (Cable box or DVD player) turns on, your remote control is now set correctly.  
If your VCR (Cable box or DVD player) does not turn on, repeat steps 2, 3, and 4, but try one of the other codes listed for the brand of your particular VCR (Cable box or DVD player).
- 6 Once your remote control is set up, press the MODE button any time you want to use the remote to operate your VCR (Cable box or DVD player).

### NOTES

- When your remote is in the TV mode, the VCR (or DVD player) control buttons (REW, STOP, PLAY/PAUSE, and FF) will still operate your VCR (or DVD player).
- When your remote control is in the STB, VCR, CABLE, or DVD mode, the volume buttons still control your TV's volume.

## Remote Control Codes

### VCR Codes

Admiral	015,088	Hitachi	014,024,044,045	Quasar	017,053
Aiwa	024	Instant Replay	017	Radio Shack	011,015,017,018,021,024,028,036,052,062
Akai	026,031,032	JC Penny	011,014,016,017,023,025,039,044,060,062	RCA	009,014,016,017,037,044,046,063,078
Audio Dynamics	022,025	JCL	011,017,023,025,039,055	Realistic	011,015,017,018,021,024,028,036,052,062
Bell & Howell	011	Kenwood	011,023,025,039,055	Samsung	000,016,022,031,041,051
Broksonic	019	KLH	082	Sansui	025
Candle	016,018,022,054,055,061	LG(Goldstar)	001,002,007,018,023,055,069	Sanyo	011,021
Canon	017,062	Lloyd	024	Scott	022,050,058,077
Ciitizen	016,018,022,054,055,061	Logik	040	Sears	011,014,018,021,027,028,044,052,057
Colorlyme	023	LXI	024	Sharp	015,036,048,054
Craig	016,021	Magnavox	017,038,062,065	Shintom	026,035,040,064
Curtis Mathes	009,016,017,023,024,055,062,073,076	Marantz	011,017,023,025,038,039,055,070	Signature	024
Daewoo	003,004,005,006,007,008,022,054,085	MTC	016,024	Sony	026,035,047
DB	023,025	Multitech	016,024,040,041	Sylvania	017,024,038,062,065
Dimensia	009	NEC	011,023,025,039,055,070,073	Symphonic	024
Dynatech	024	Optimus	015	Tandy	011,024
Electrohome	036	Panasonic	017,062,084,086	Tatung	039
Emerson	017,018,019,022,024,029,032,036,043,050,051,056,058,066,071,074,076,077,079	Pentax	014,044	Teac	024,039,078
Fisher	011,021,027,028,052,057,067	Penlex Research+	055	Technics	017
Funai	024	Philco	017,038,062,065	Teknika	017,018,024,030
General Electric	009,016,017,041,062	Phillips	017,038	TMK	076
Go Video	016	Pioneer	014,025,042,059	Toshiba	014,022,028,057,058
Harman Kardon	023	Portland	053,054,061	Toshiko	018
		PROSCAN	009	Totevision	016,018
		Quartz	011		

### Cable Box Codes

Anvision	015,016	Magnavox	015,016,027,029,034,036,037,040,041,048,049	Signature	054
Cable Star	015,016	Nawoo	001	Sprucer	035
Daehan	005	NSC	017	Starcom	054
DeaRyung	003	Oak	024,046	Stargate2000	066
DongKuk	004	Osk Sigma	024	Sylvania	019,067
Eagle	015,016	Panasonic	011,035,047,069	TaePyungYang	002
Eastern International	020	Phillips	015,016,027,029,034,036,037,040,041,048,049	Texscan	019,067
General Instrument	054	Pioneer	026,028,052	Tocom	025,029,057,058,063
GI	012,013,023,031,032,033,038,044,075,076,077	Randtek	015,016	Unika	039,040,049
Hamlin	011,012,020,021,042,056	RCA	008,035,074	Universal	059,060
Hitachi	045,051,054	Regal	011,020,021	Viewstar	015,016,027,029,034,036,037,040,041,048,049
Jerrold	012,013,023,031,032,033,038,044,054,070,073	Regency	010,041	Warner Amex	052
LG(Goldstar)	006	Saewoo	007	Zenith	022,050,065,069
Macom	045,051	Samsung	000,011,030,052,071,072		

### DVD Codes

Curtis Mathes	009	Phillips	007	Sharp	005
JVC	003	PROSCAN	008	Sony	004
LG(Goldstar)	001	RCA	008	Toshiba	002
Panasonic	006	Samsung	000		



# Operation

## Setting the Clock

Setting the clock is necessary in order to use the various timer features of the TV. Also, you can check the time while watching the TV. (Just press the INFO button.)

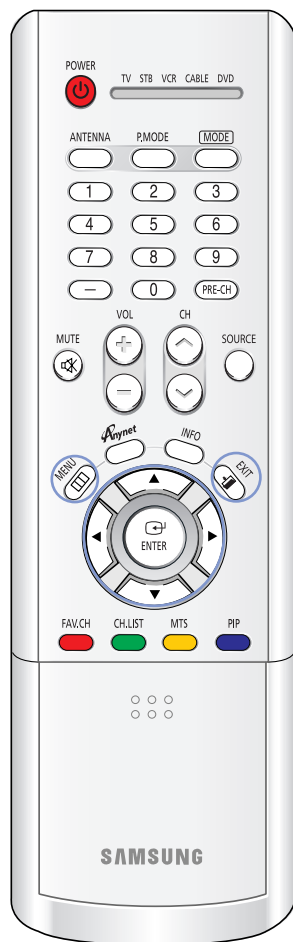

### Option 1: Setting the Clock Manually

1 Press the MENU button. Press the ▲ or ▼ button to select "Setup", then press the ENTER button.

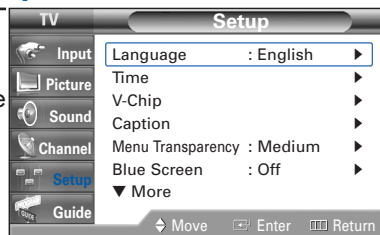

2 Press the ▲ or ▼ button to select "Time", then press the ENTER button. Press the ▲ or ▼ button to select "Clock", then press the ENTER button.

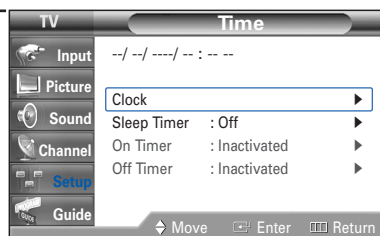

3 Press the ENTER button to select "Clock Mode". Press the ▲ or ▼ button to select "Manual", then press the ENTER button.

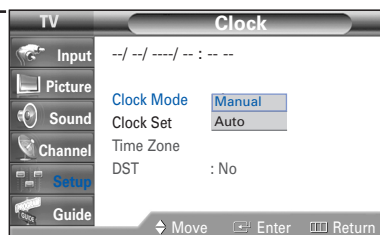

4 Press the ▲ or ▼ button to select "Clock Set", then press the ENTER button.

- The current time will appear every time you press the INFO button.
- You can set the hour and minute directly by pressing the number buttons on the remote control.

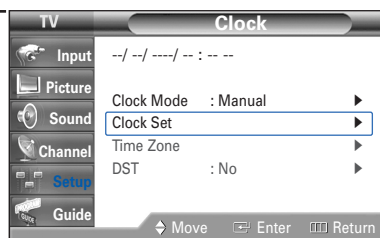

5 Press the ◀ or ▶ button to move to "Month", "Day", "Year", "Hour", "Minute", or "am/pm". Set the clock you want by pressing the ▲ or ▼ button, then press the ENTER button.

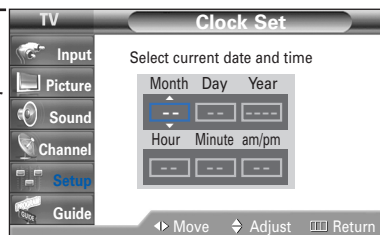

Press the EXIT button to exit.

## Option 2: Setting the Clock Automatically

The Clock can be set automatically if you are receiving a digital signal.

- 1 Press the MENU button.  
Press the ▲ or ▼ button to select "Setup", then press the ENTER button.

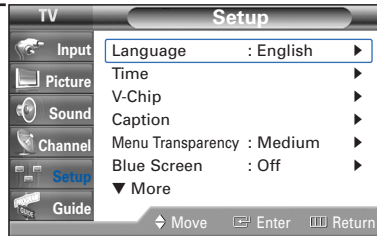

- 2 Press the ▲ or ▼ button to select "Time", then press the ENTER button.  
Press the ENTER button to select "Clock".

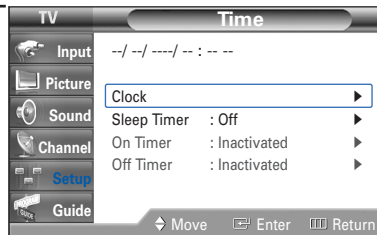

- 3 Press the ENTER button to select "Clock Mode".  
Press the ▲ or ▼ button to select "Auto", then press the ENTER button.

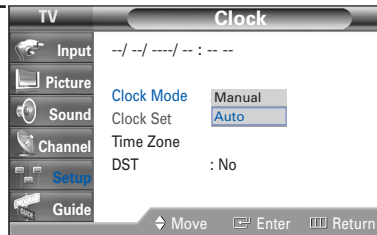

- 4 Press the ▲ or ▼ button to select "Time Zone", then press the ENTER button.

Press the ▲ or ▼ button to highlight the time zone for your local area (and to move the highlight to the appropriate time zone on the map of the United States), then press the ENTER button.

- When you set up Auto Time, the set time may not be correct depending on the broadcasting station and signal. If there is a difference between the real time and set time, please set the time manually.

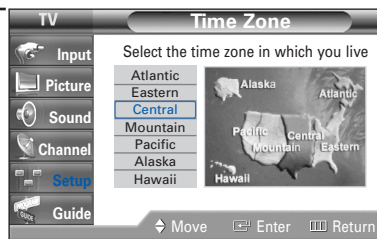

- 5 Press the ▲ or ▼ button to select "DST" (Daylight Saving Time), then press the ENTER button.  
Press the ▲ or ▼ button to select "Yes" or "No", then press the ENTER button.

Press the EXIT button to exit.

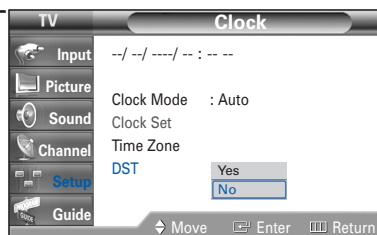

# Operation

## Setting the Sleep Timer

The sleep timer automatically shuts off the TV after a preset time (from 30 to 180 minutes).

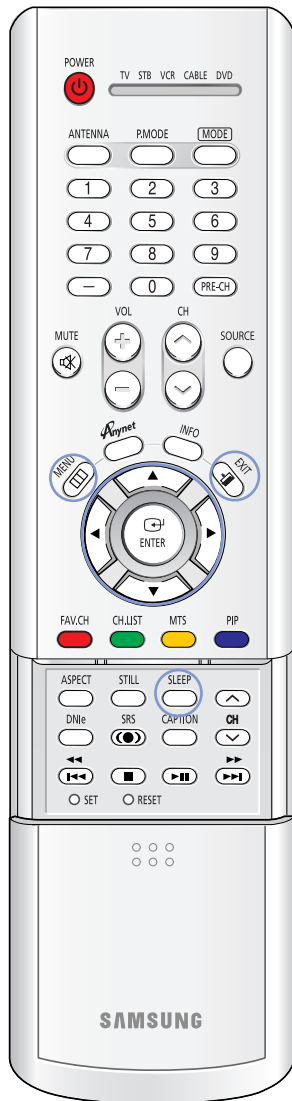

1 Press the MENU button. Press the ▲ or ▼ button to select "Setup", then press the ENTER button.

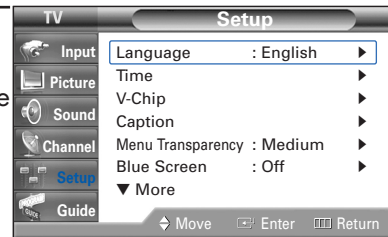

2 Press the ▲ or ▼ button to select "Time", then press the ENTER button. Press the ▲ or ▼ button to select "Sleep Timer", then press the ENTER button.

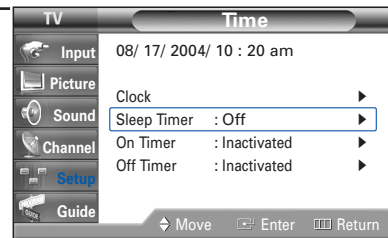

3 Press the ▲ or ▼ button to adjust "Minute".

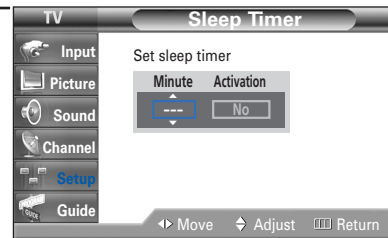

4 Setting the Timer sets the Activation to 'Yes' automatically.

Press the EXIT button to exit.

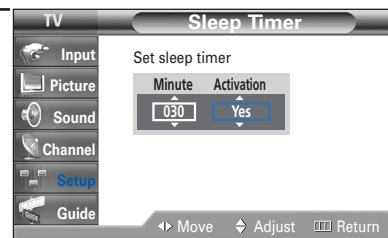

### Alternate method

Press the SLEEP button on the remote control repeatedly until the appropriate time interval appears (any of the preset values from "30 min" to "180 min").

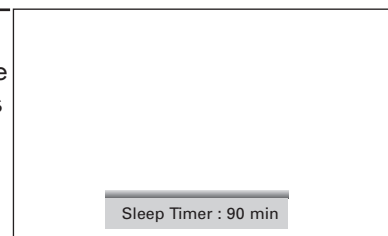

## Viewing an External Signal Source

Use the remote control to switch between viewing signals from connected equipment, such as a VCR, DVD, Set-Top box or the TV source (broadcast or cable).



### Setting the Signal Source

- 1 Press the MENU button. Press the ENTER button to select "Input".

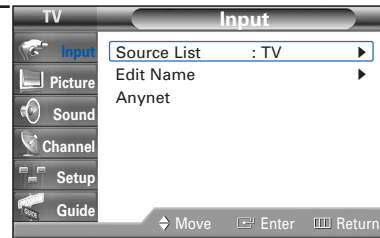

- 2 Press the ENTER button to select "Source List". Press the ▲ or ▼ button to select a signal source, then press the ENTER button.

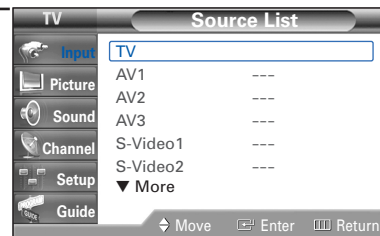

- When you connect equipment to the TV, you can choose between the following sets of jacks: "AV1", "AV2", "S-Video1", "S-Video2", "Component1", "Component2" or "HDMI" on the TV's rear panel and "AV3" or "S-Video3" on the TV's side panel.
- HDMI input can be selected only when the external device is turned on and the connector for it is linked.

### Alternate method

Press the SOURCE button on the remote control repeatedly to select an external signal source.

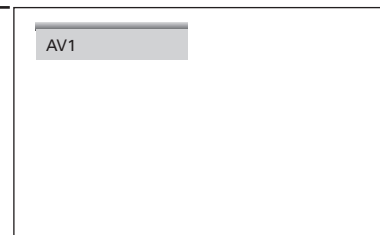

# Operation

## Assigning Names to External Input Mode

This feature enables you to name the input source you have connected.

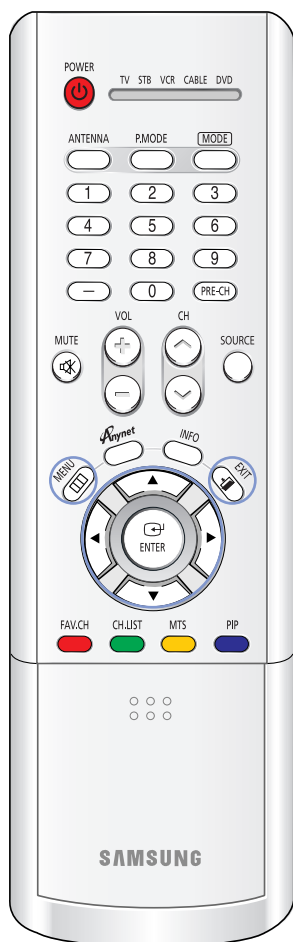

- 1 Press the MENU button.  
Press the ENTER button to select "Input".

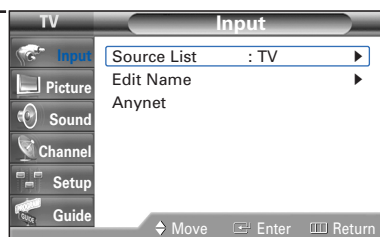

- 2 Press the ▲ or ▼ button to select "Edit Name", then press the ENTER button.

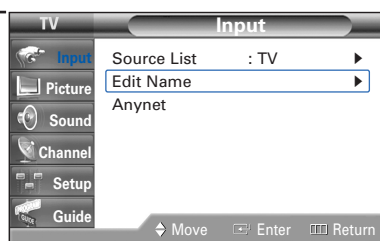

- 3 Press the ▲ or ▼ button to select a signal source to edit, then press the ENTER button.

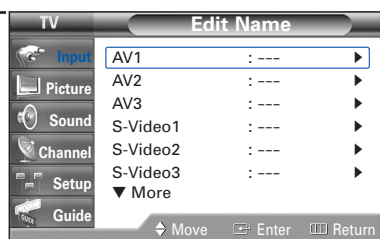

- 4 Press the ▲ or ▼ button to select the external device : VCR, DVD, D-VHS, Cable STB, HD STB, Satellite STB, PVR STB, AV Receiver, DVD Receiver, GAME, Camcorder, DVD Combo, DVD HDD Recorder, Internet TV Recv., Interactive TV Recv, VOD (Video On Demand) STB, TV.

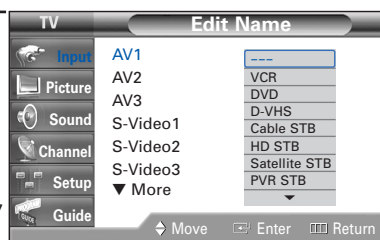

Press the ENTER button.  
Set other signal sources (AV2, AV3, S-Video1, S-Video2, S-Video3, Component1, Component2, HDMI) using the same method as listed above.

Press the EXIT button to exit.



# Channel Control

# Channel Control

## Selecting Your Favorite Channels

You can store your favorite channels for each available input source (such as TV and CATV). This allows you to quickly and easily find frequently watched channels by pressing the FAV.CH button on the remote control.



### To Store Your Favorite Channels:

- 1 Press the MENU button. Press the ▲ or ▼ button to select "Channel", then press the ENTER button.

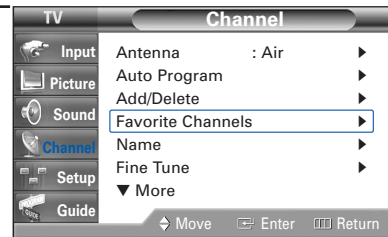

- 2 Press the ▲ or ▼ button to select "Favorite Channels", then press the ENTER button. Press the ▲ or ▼ button to select a channel, then press the ENTER button. Press the ENTER button again to deselect the selected channel.

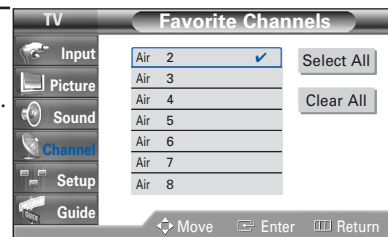

Press the EXIT button to exit.

### NOTES

- Only memorized channels can be set as Favorite channels.
- Select All : Press to select all channels.
- Clear All : Press to clear all channels.

### To View Your Favorite Channels:

Press the FAV.CH button repeatedly to jump from one favorite channel to another.

## Labeling the Channels

Use this feature to assign an easy-to-remember label to analog channel (i.e., "CBS", "ESPN", "PBS2", CNN02", etc.) A label consists of five fields, where each field is a letter, a number or a blank. When the INFO button is pressed, the channel label will appear next to the channel number.

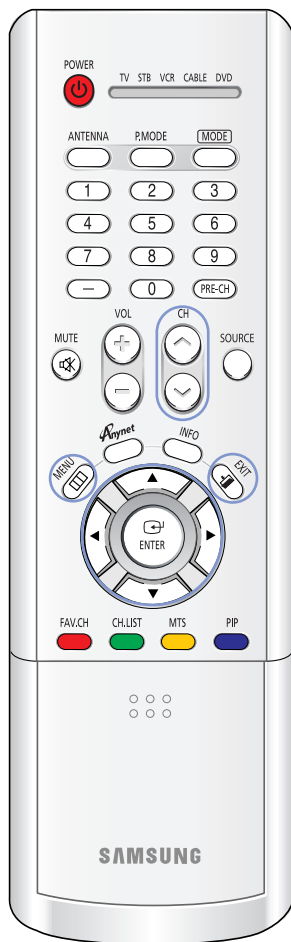

### NOTE

- If you add or delete a TV channel, the labeled channels will also be added or deleted.

1 Press the CH  $\wedge$  or CH  $\vee$  button to tune to the channel that will be labeled.

2 Press the MENU button. Press the  $\blacktriangle$  or  $\blacktriangledown$  button to select "Channel", then press the ENTER button. Press the  $\blacktriangle$  or  $\blacktriangledown$  button to select "Name", then press the ENTER button.

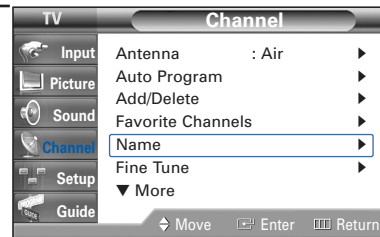

3 Press the  $\blacktriangle$ / $\blacktriangledown$ / $\blacktriangleleft$ / $\blacktriangleright$  button to move to the channel to be assigned to a new name, then press the ENTER button. Press the  $\blacktriangle$  or  $\blacktriangledown$  button to select a letter, a number or a blank. (Results in this sequence: A...Z, 0...9, +, -, \*, /, blank).

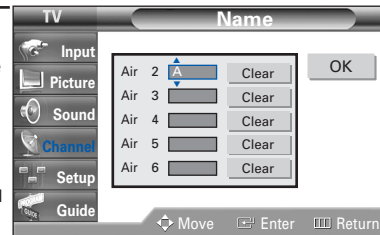

4 Press the  $\blacktriangleright$  button to switch to the next field, which will be selected. Select a second letter or digit pressing  $\blacktriangle$  or  $\blacktriangledown$  button, as above. Repeat the process to select the last three digits. When you have finished, press the ENTER button. To erase the assigned new name, select "Clear" by pressing the  $\blacktriangle$ / $\blacktriangledown$ / $\blacktriangleleft$ / $\blacktriangleright$  button, then press the ENTER button.

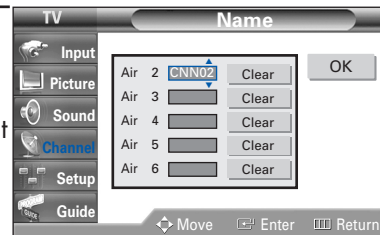

Press the EXIT button to exit.



# Channel Control

## Fine Tuning Analog Channels **Analog**

Use fine tuning to manually adjust a particular channel for optimal reception.



### NOTE

- Only analog TV channels can be fine tuned.

- 1 Press the MENU button. Press the ▲ or ▼ button to select "Channel", then press the ENTER button.

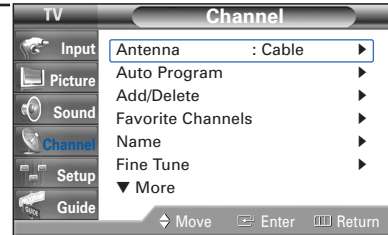

- 2 Press the ▲ or ▼ button to select "Fine Tune", then press the ENTER button.

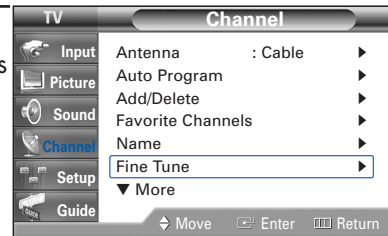

- 3 Press the ◀ or ▶ button to adjust the fine tuning.

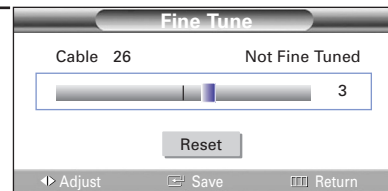

- 4 To store the fine tuning setting in the TV's memory, press the ENTER button. To reset the fine tuning setting, press the ▼ button to select "Reset", then press the ENTER button.

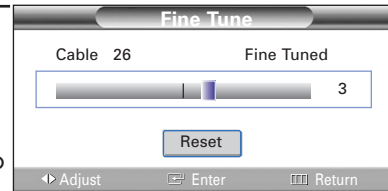

- 5 Press the EXIT button to exit.

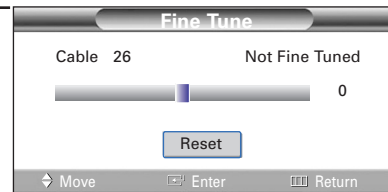

## Checking the Digital-Signal Strength Digital

Unlike analog channels, which can vary in reception quality from “snowy” to clear, digital (HDTV) channels have either perfect reception quality or you will not receive them at all. So, unlike analog channels, you cannot fine tune a digital channel.

You can, however, adjust your antenna to improve the reception of available digital channels.

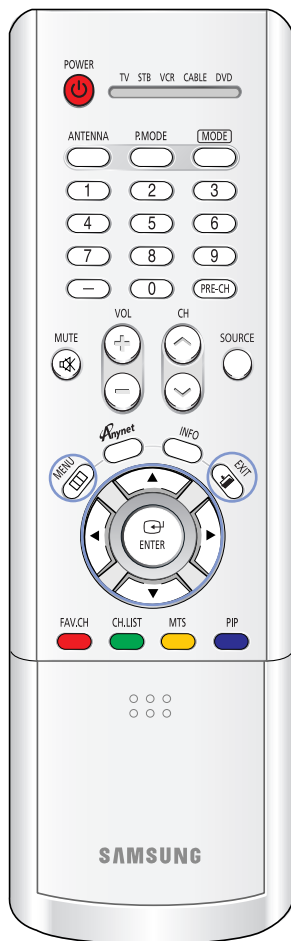

- 1 Press the MENU button. Press the ▲ or ▼ button to select “Channel”, then press the ENTER button.

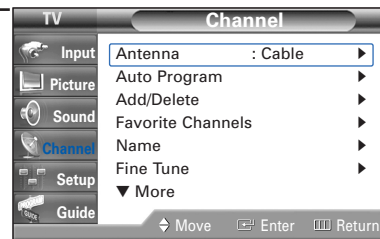

- 2 Press the ▲ or ▼ button to select “Signal Strength”, then press the ENTER button.

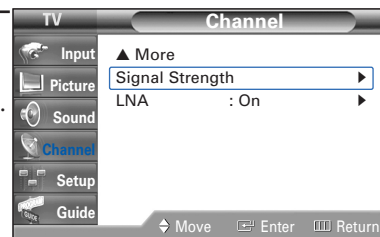

If the signal strength meter indicates that the signal is weak, physically adjust your antenna to increase the signal strength. Continue to adjust the antenna until you find the best position with the strongest signal.

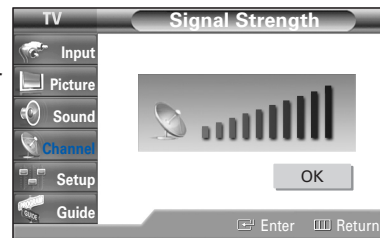

Press the EXIT button to exit.

# Channel Control

## LNA (Low Noise Amplifier)

If the TV is operating in a weak-signal area, sometimes the LNA function can improve the reception (a low-noise preamplifier boosts the incoming signal).



1 Press the MENU button. Press the ▲ or ▼ button to select "Channel", then press the ENTER button.

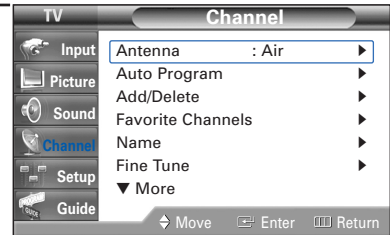

2 Press the ▲ or ▼ button to select "LNA", then press the ENTER button.

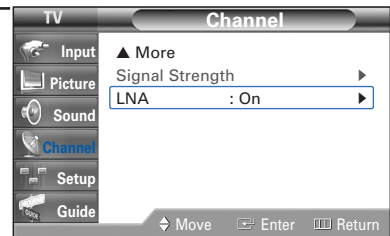

3 Press the ▲ or ▼ button to select "ON", then press the ENTER button.

Pressing the ▲ or ▼ button will alternate between "On" and "Off".

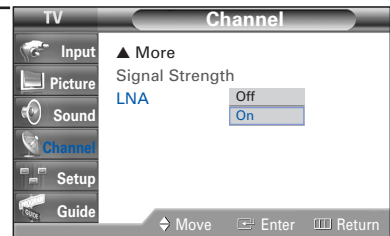

4 Press the EXIT button to exit.

### NOTE

- LNA functions only when antenna is set to AIR. The settings will be stored separately in each channel.



# Picture Control



# Picture Control

## Picture Control

You can use the on-screen menus to change the "Contrast", "Brightness", "Sharpness", "Color" and "Tint" according to personal preference. (Alternatively, you can use one of the automatic settings. See next page.)



### NOTE

- "Tint" doesn't operate in HDMI/DVI or 480p-Component or higher modes.

### Customizing the Picture

- 1 Press the MENU button. Press the ▲ or ▼ button to select "Picture", then press the ENTER button.

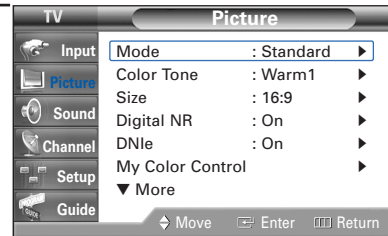

- 2 Press the ENTER button to select "Mode".

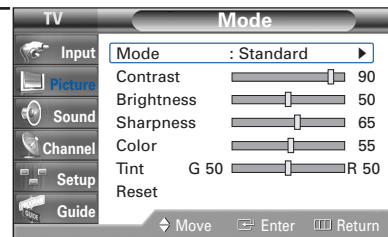

- 3 Press the ▲ or ▼ button to select a particular item, then press the ENTER button.

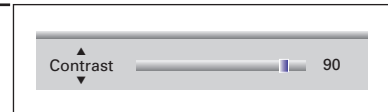

Press the ◀ or ▶ button to decrease or increase the value of a particular item.

### Resetting the Picture Settings to the Factory Defaults

You can return to the factory default picture settings.

- 4 Press the MENU button to display the "Mode" menu. Press the ▲ or ▼ button to select "Reset", then press the ENTER button. The previously adjusted picture settings will be reset to the factory defaults.

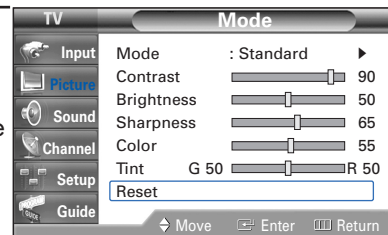

## Using Automatic Picture Settings

Your TV has automatic picture settings ("Dynamic", "Standard" and "Cinema") that are preset at the factory. You can select "Standard" which automatically recalls your personalized picture settings.

- 1 Press the MENU button.  
Press the ▲ or ▼ button to select "Picture", then press the ENTER button.

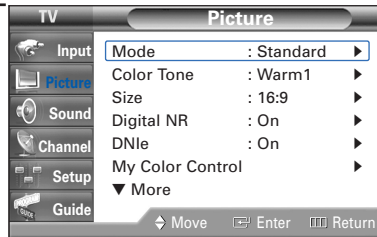

- 2 Press the ENTER button to select "Mode".

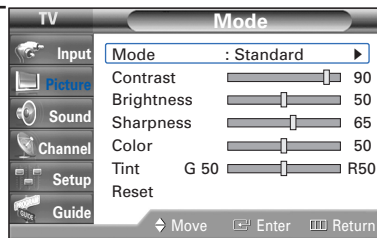

- 3 Press the ENTER button again to select "Mode".  
Press the ▲ or ▼ button to select a particular item, then press the ENTER button.

Press the EXIT button to exit.

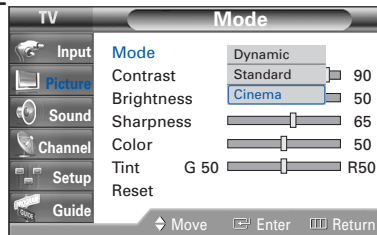

- Choose "Dynamic" for viewing the TV during the day or when there is a bright light in the room.
- Choose "Standard" for the standard factory settings.
- Choose "Cinema" when viewing a movie.

# Picture Control

## Selecting the Color Tone



- 1 Press the MENU button. Press the ▲ or ▼ button to select "Picture", then press the ENTER button.

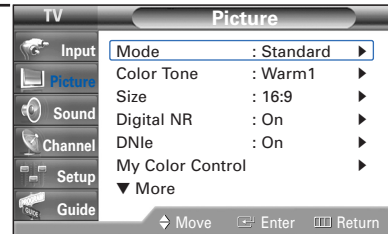

- 2 Press the ▲ or ▼ button to select "Color Tone", then press the ENTER button.

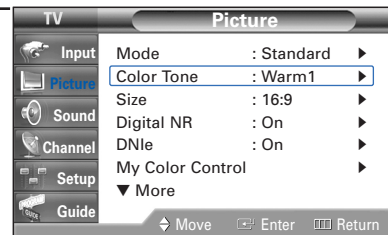

- 3 Press the ▲ or ▼ button to select "Cool2", "Cool1", "Normal", "Warm1", or "Warm2", then press the ENTER button.

Press the EXIT button to exit.

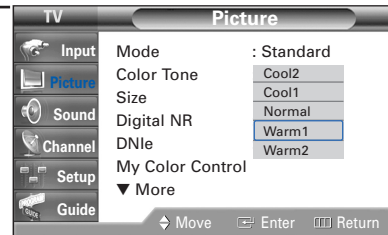

### NOTE

- Color tone is not available in the "Cinema" picture mode.

## Changing the Picture Size

You can select the picture size which best corresponds to your viewing requirements.

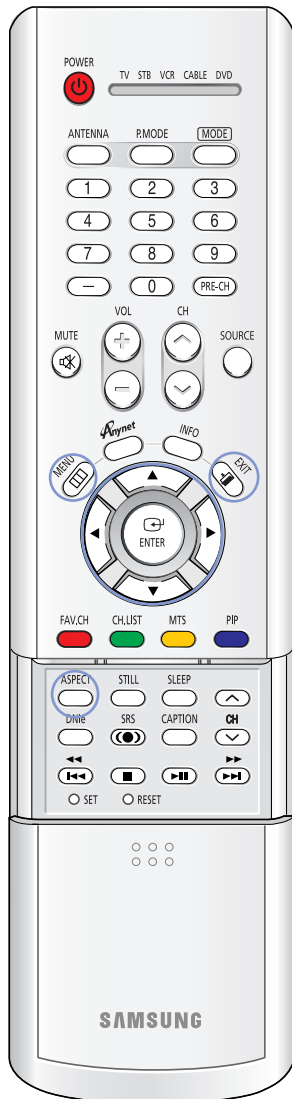

- 1 Press the MENU button.  
Press the ▲ or ▼ button to select "Picture", then press the ENTER button.  
Press the ▲ or ▼ button to select "Size", then press the ENTER button.

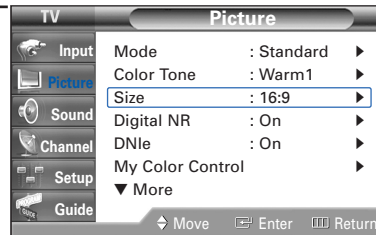

- 2 Press the ◀ or ▶ button to select the screen format you want, then press the ENTER button.

Press the EXIT button to exit.

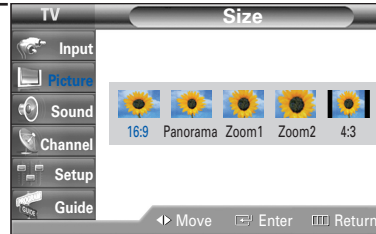

### Alternate method

Press the ASPECT button on the remote control repeatedly to select one of the picture size settings.

- "16:9": Sets the picture to 16:9 wide mode.
- "Panorama": Use this mode for the wide aspect ratio of a panoramic picture.
- "Zoom1": Magnifies the size of the picture on screen. You can also move the picture on screen using the scroll function. Press the ▲ or ▼ button to scroll the picture.
- "Zoom2": Magnifies the size of the picture more than "Zoom1". You can also move the picture on screen using the scroll function. Press the ▲ or ▼ button to scroll the picture.
- "4:3": Sets the picture to 4:3 normal mode. This is a standard TV screen size.

### NOTES

- You can select only 16:9, 4:3 screen size in the Component(480p, 720p, 1080i) Mode.
- With PIP On, the screen automatically becomes wide in the Antenna, AV (1~3), S-Video (1~3) or Component (480i) mode. With PIP Off, it returns to original screen size.



# Picture Control

## Digital Noise Reduction

If the broadcast signal received by your TV is weak, you can activate the Digital Noise Reduction feature to help reduce any static and ghosting that may appear on the screen.



1 Press the MENU button. Press the ▲ or ▼ button to select "Picture", then press the ENTER button.

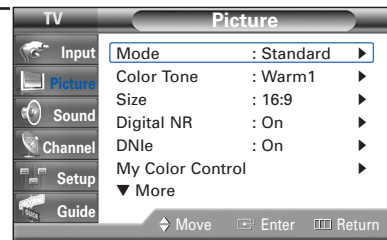

2 Press the ▲ or ▼ button to select "Digital NR", then press the ENTER button.

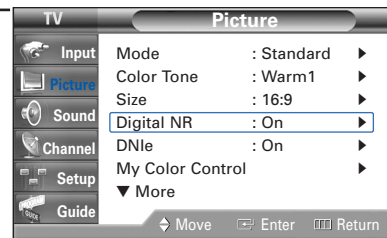

3 Press the ▲ or ▼ button to select "Off" or "On", then press the ENTER button. Press the EXIT button to exit.

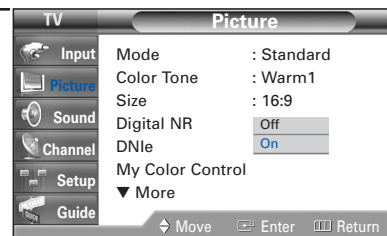

## DNle™ (Digital Natural Image engine) **DNle™**

This feature brings you more detailed image with 3D noise reduction, detail enhancement, contrast enhancement and white enhancement.

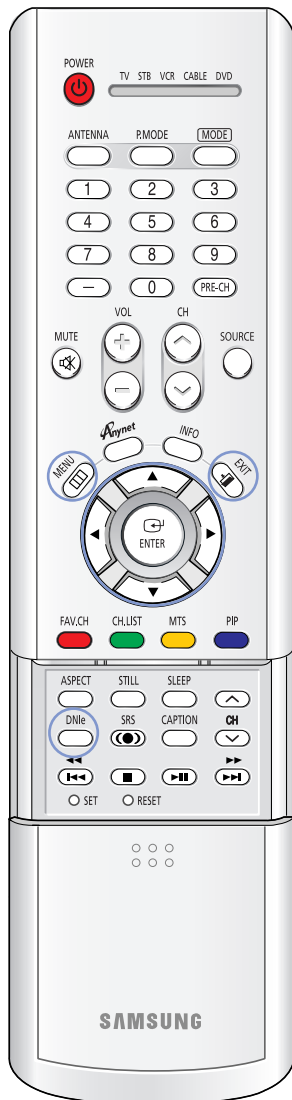

- 1 Press the MENU button.  
Press the ▲ or ▼ button to select "Picture", then press the ENTER button.

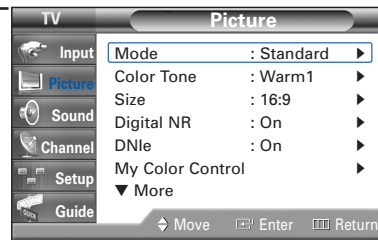

- 2 Press the ▲ or ▼ button to select "DNle", then press the ENTER button.

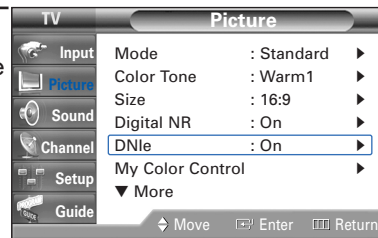

- 3 Press the ▲ or ▼ button to select "Off", "Demo" or "On", then press the ENTER button.

Press the EXIT button to exit.

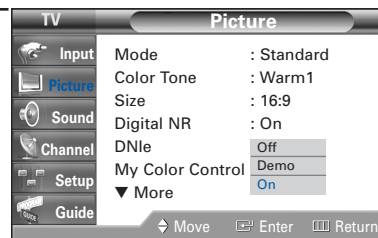

### Alternate method

Press the DNle button on the remote control repeatedly to select one of the settings.

- On: Switches on the DNle mode.
- Off: Switches off the DNle mode.
- Demo: The screen before applying DNle appears on the right and the screen after applying DNle appears on the left.

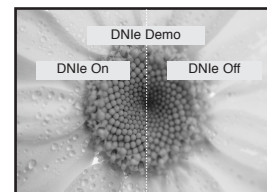

# Operation

## Setting the My Color Control Mode

My Color Control allows users to adjust colors according to their preferences, by adjusting skin, sky, and grass tones using the predefined settings ("Blue", "Green", "Pink", "Standard", and "Custom") without affecting other colors on the screen.



### NOTES

- Changing the settings in the "Detail Control" menu (see next page) will automatically set the My Color Control mode to "Custom".
- The My Color Control feature operates only when "DNLe" is set to "On" mode.

### Using the Easy Control Menu

1 Press the MENU button. Press the ▲ or ▼ button to select "Picture", then press the ENTER button.

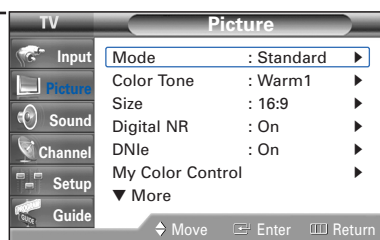

2 Press the ▲ or ▼ button to select "My Color Control", then press the ENTER button.

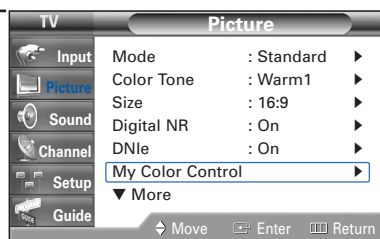

3 Press the ENTER button to select "Easy Control". Press the ◀ or ▶ button to select one of the picture settings you want. The original picture (before adjustment) is shown on the left side, while the selected mode is shown on the right side.

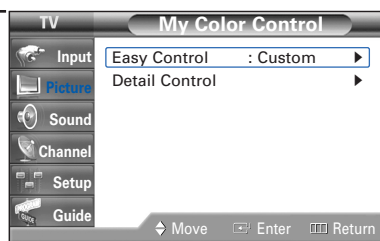

Press the ENTER button to accept the selected mode.

Press the EXIT button to exit.

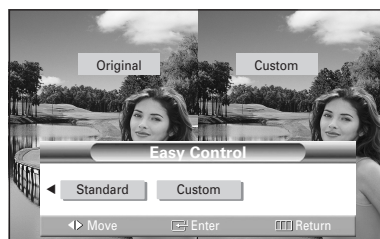

- "Blue": Emphasizes Clear Blues.
- "Green": Emphasizes Mild Greens.
- "Pink": Emphasizes Warm Skin Colors.
- "Standard": Standard Picture.

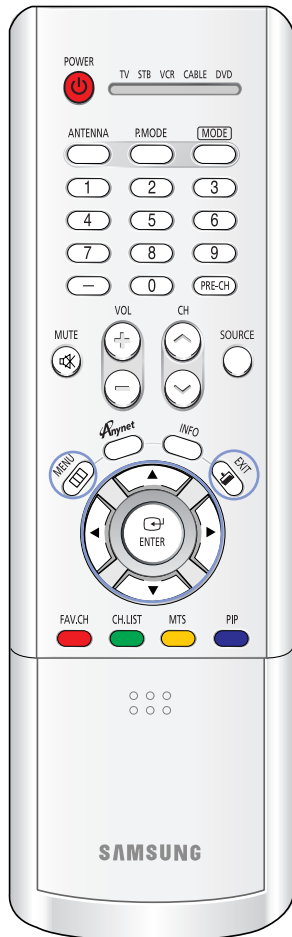

## Custom Settings

- 1 Press the MENU button. Press the ▲ or ▼ button to select "Picture", then press the ENTER button. Press the ▲ or ▼ button to select "My Color Control", then press the ENTER button.

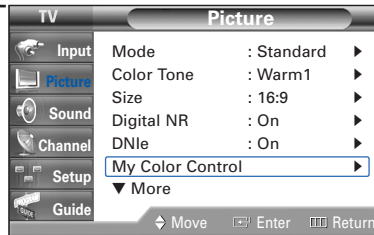

- 2 Press the ▲ or ▼ button to select "Detail Control", then press the ENTER button.

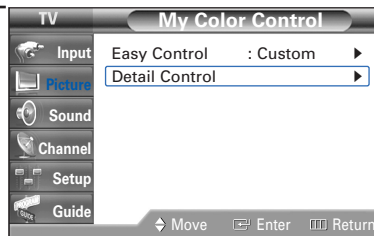

- 3 Press the ▲ or ▼ button to select the desired My Color Control, then press the ENTER button. There are three colors: "Pink", "Green" and "Blue".

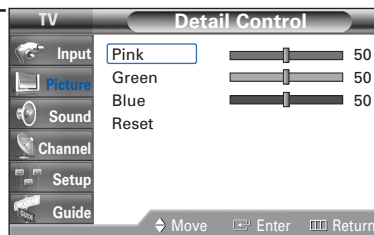

Press the ◀ or ▶ button to adjust the value of a color selected. Changing the adjustment value will refresh the adjusted screen.

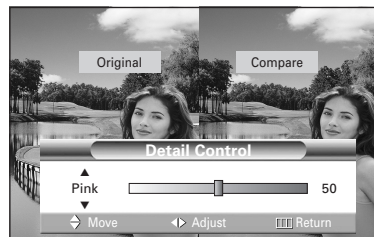

## Resetting the My Color Control Colors to the Factory Defaults

You can return to the factory default settings for My Color Control colors.

- 4 Press the MENU button to display the "Detail Control" menu. Press the ▲ or ▼ button to select "Reset", then press the ENTER button. The previously adjusted My Color Control Colors will be reset to the factory defaults.

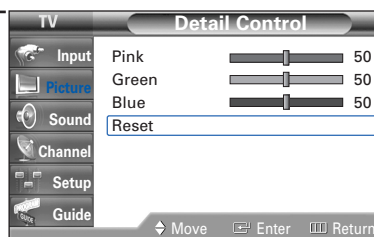

# Picture Control

## Using the Color Weakness Enhancement Feature

This feature adjusts the Red, Blue or Green color to enhance the picture according to the user's particular color weakness.



- 1 Press the MENU button. Press the ▲ or ▼ button to select "Setup", then press the ENTER button.

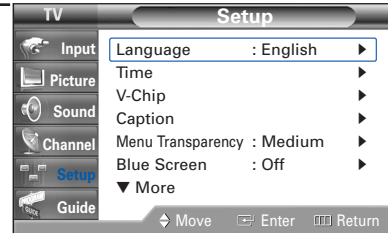

- 2 Press the ▲ or ▼ button to select "Color Weakness", then press the ENTER button.

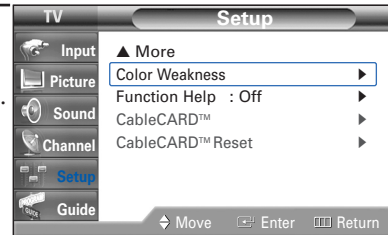

- 3 Press the ENTER button to select "Color Weakness". Press the ▲ or ▼ button to select "On", then press the ENTER button.

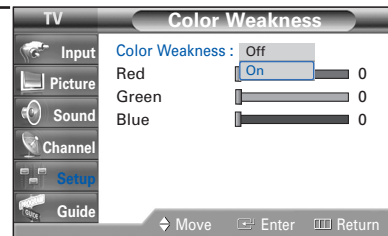

- 4 Press the ▲ or ▼ button to select a color to be adjusted, then press the ENTER button.

Press the ◀ or ▶ button to adjust the value of a color selected.

Press the EXIT button to exit.

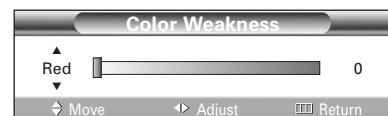
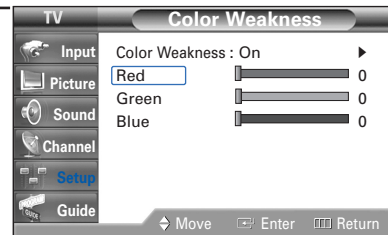

## Setting the Film Mode

You can automatically sense and process film signals from all sources and adjust the picture for optimum quality.

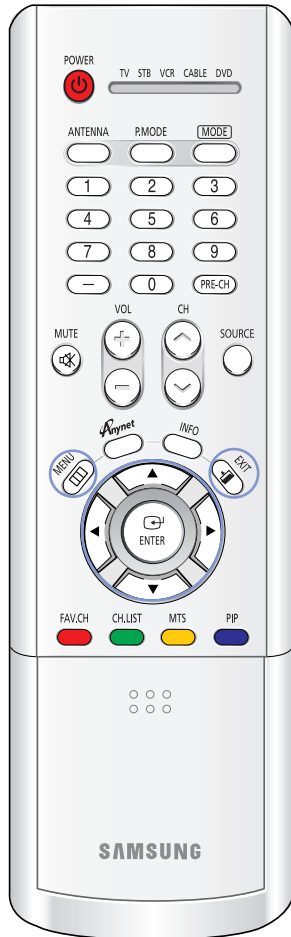

- 1 Press the MENU button.  
Press the ▲ or ▼ button to select "Picture", then press the ENTER button.

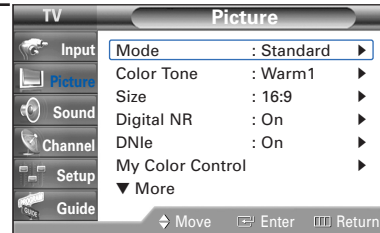

- 2 Press the ▲ or ▼ button to select "Film Mode", then press the ENTER button.

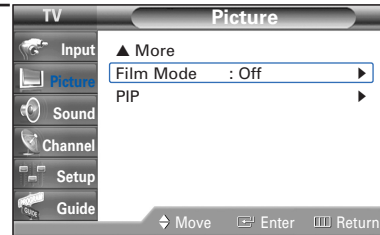

- 3 Press the ▲ or ▼ button to select "Off" or "On", then press the ENTER button.

Press the EXIT button to exit.

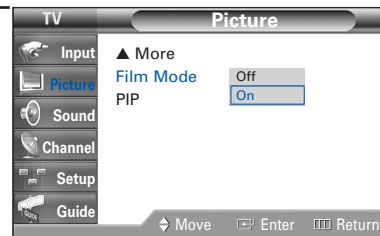

### NOTE

- Film mode is supported in 480i only.

# Picture Control

## Viewing Picture-In-Picture

One of the most best features of your TV is the Picture-In-Picture (PIP) feature. The advanced PIP system allows you to watch two different pictures at once, even if you don't have a VCR or DVD connected to your TV.

### Activating the PIP

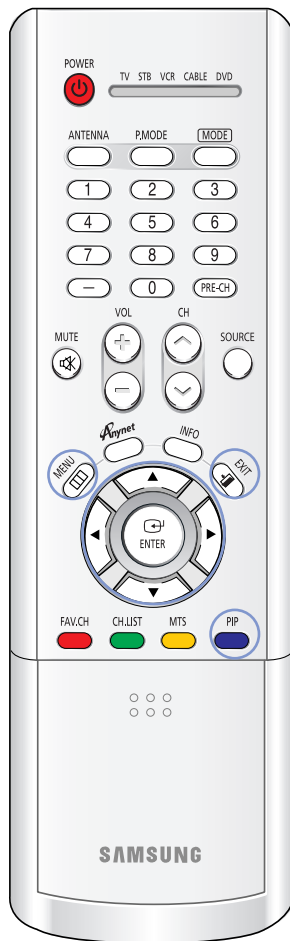

1 Press the MENU button. Press the ▲ or ▼ button to select "Picture", then press the ENTER button.

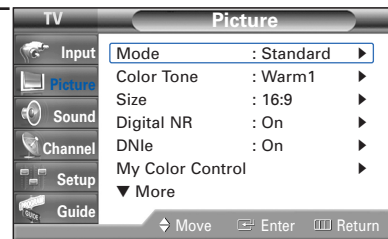

2 Press the ▲ or ▼ button to select "PIP", then press the ENTER button.

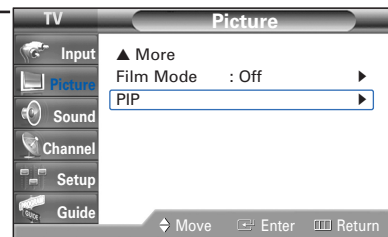

3 Press the ENTER button to select "PIP". Press the ▲ or ▼ button to select "On", then press the ENTER button. The sub picture appears in the corner of the screen.

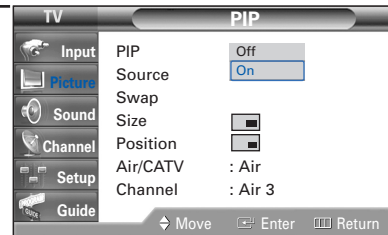

Press the EXIT button to exit.

### Alternate method

Press the PIP button on the remote control repeatedly to activate or deactivate the PIP.

### NOTES

- This feature doesn't function when the "V-Chip" is active.
- If you turn the TV off while watching and turn it on again, then the mode will return to normal video.
- Digital broadcasting is not available in PIP.

## Selecting an External Source

You can use PIP to view a signal from an external source, such as a VCR.



- 1 Press the MENU button. Press the ▲ or ▼ button to select "Picture", then press the ENTER button.

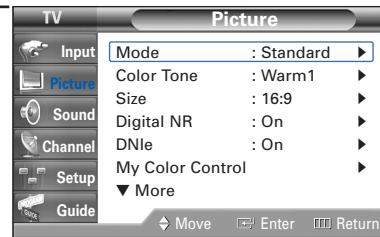

- 2 Press the ▲ or ▼ button to select "PIP", then press the ENTER button.

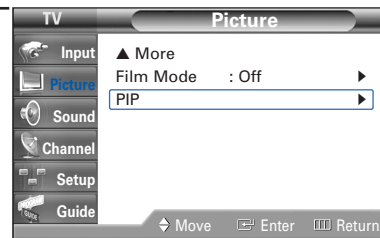

- 3 Press the ▲ or ▼ button to select "Source", then press the ENTER button. If you have not connected any equipment to the TV's input jacks, the signal from these inputs will not appear.

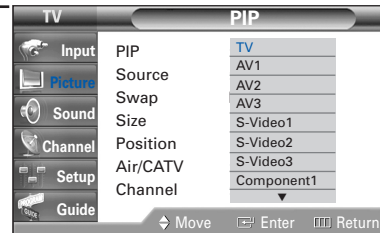

Press the ▲ or ▼ button to select an external signal, then press the ENTER button.

Press the EXIT button to exit.

### NOTE

- For more information about external signals, see "Viewing an External Signal Source" (See page 43). If you select "TV", the sub picture will be the same as the main picture.



# Picture Control

## Swapping the Sub Picture and Main Picture



- 1 Press the MENU button.  
Press the ▲ or ▼ button to select "Picture", then press the ENTER button.

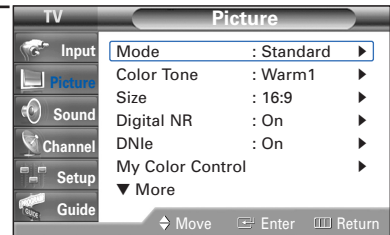

- 2 Press the ▲ or ▼ button to select "PIP", then press the ENTER button.

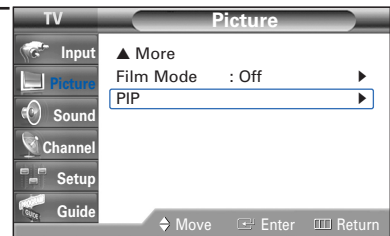

- 3 Press the ▲ or ▼ button to select "Swap", then press the ENTER button.  
The sub picture appears in the main picture, and vice versa.

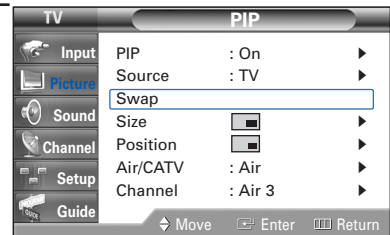

Press the EXIT button to exit.

### NOTE

- SWAP is not available when Main picture is Digital broadcasting.

## Changing the Size of the Sub Picture

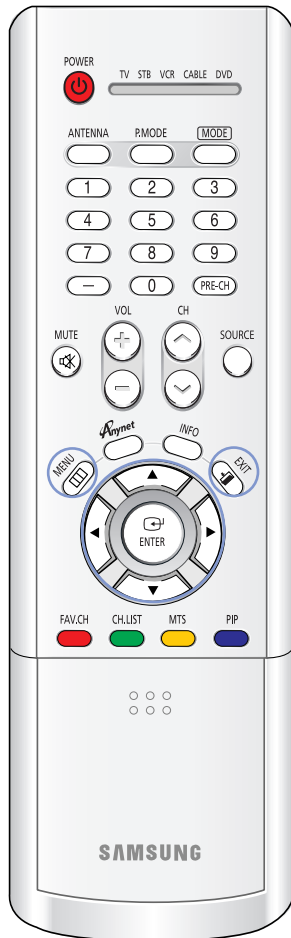

- 1 Press the MENU button.  
Press the ▲ or ▼ button to select "Picture", then press the ENTER button.

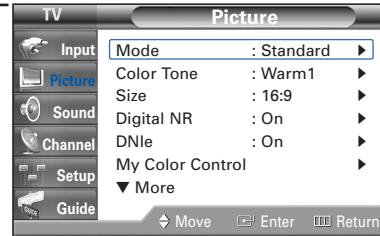

- 2 Press the ▲ or ▼ button to select "PIP", then press the ENTER button.

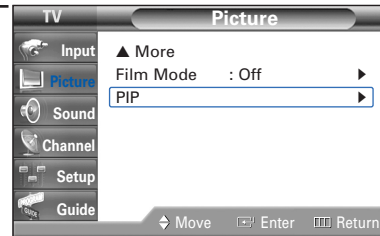

- 3 Press the ▲ or ▼ button to select "Size", then press the ENTER button.

Press the ▲ or ▼ button to select a size you want, then press the ENTER button.

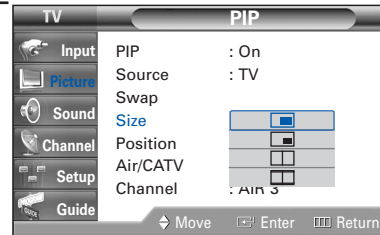

Press the EXIT button to exit.

# Picture Control

## Changing the Location of the Sub Picture



1 Press the MENU button.  
Press the ▲ or ▼ button to select "Picture", then press the ENTER button.

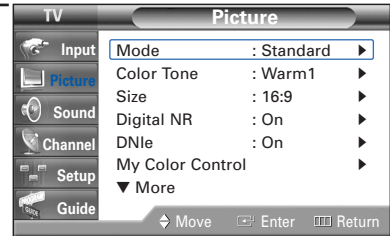

2 Press the ▲ or ▼ button to select "PIP", then press the ENTER button.

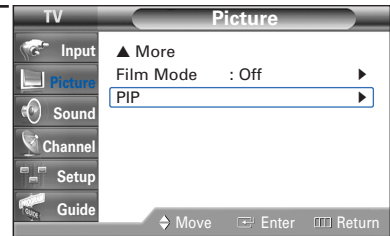

3 Press the ▲ or ▼ button to select "Position", then press the ENTER button.

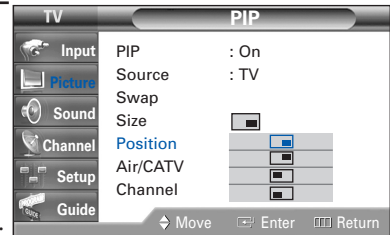

Press the ▲ or ▼ button to select a position you want, then press the ENTER button.

Press the EXIT button to exit.

### NOTE

- The Double (  ) mode cannot be selected in Position.

## Changing the Channel of the Sub Picture

After you set the signal source (antenna or cable) of the sub picture, it is easy to change channels.

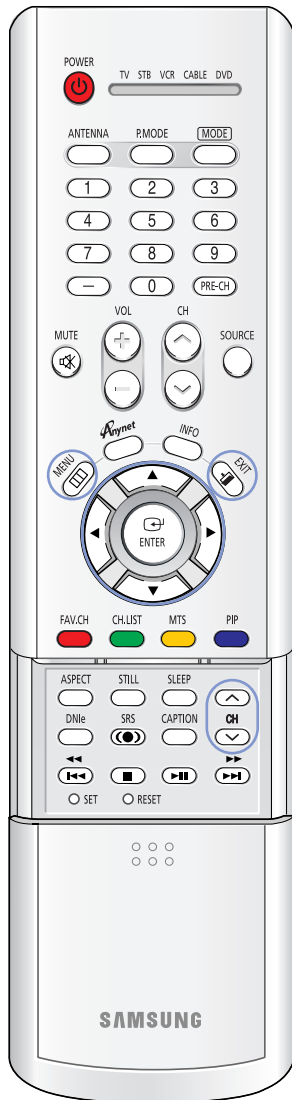

- 1 Press the MENU button.  
Press the ▲ or ▼ button to select "Picture", then press the ENTER button.

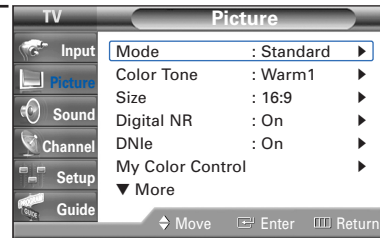

- 2 Press the ▲ or ▼ button to select "PIP", then press the ENTER button.

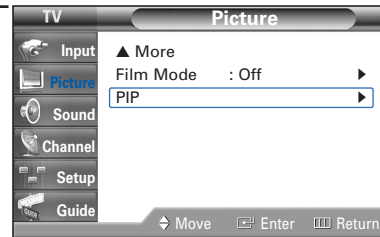

- 3 Press the ▲ or ▼ button to select "Channel", then press the ENTER button.

Press the ▲ or ▼ button to select a channel you want, then press the ENTER button.

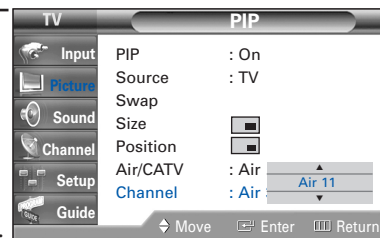

Press the EXIT button to exit.

- Air : "Air" antenna signal  
Cable : "Cable" antenna signal

### Alternate method

Press the CH ▲ or CH ▼ button under the cover of the remote control to change the sub picture channels while PIP is on.

# Picture Control

## Selecting the Sound Source

You can use this feature to hear sound from the main or sub (PIP) picture.



- 1 Press the MENU button. Press the ▲ or ▼ button to select "Sound", then press the ENTER button.

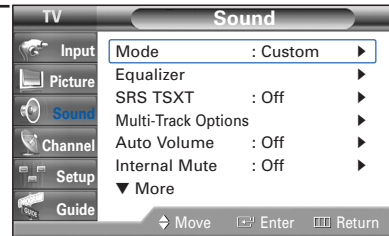

- 2 Press the ▲ or ▼ button to select "Select Sound", then press the ENTER button. Press the ▲ or ▼ button to select "Main" or "Sub", then press the ENTER button.

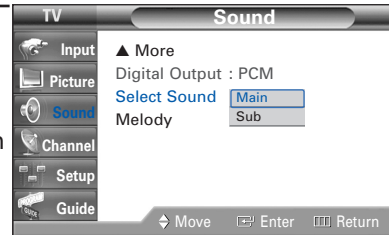

Press the EXIT button to exit.

## Freezing the Picture

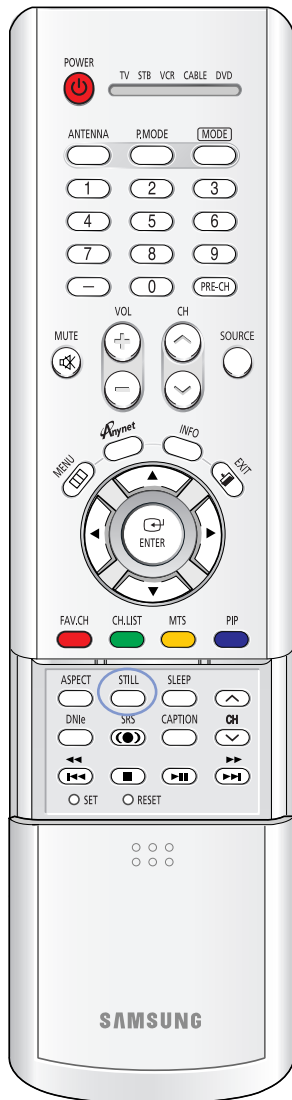

Press the STILL button to freeze a moving picture. (Normal sound will still be heard.)

Press again to cancel.

### NOTE

- In the PIP mode, the main and sub pictures are stilled at the same time.

# Picture Control

## Setting the Blue Screen Mode

If no signal is being received or the signal is very weak, a blue screen automatically replaces the noisy picture background. If you wish to continue viewing the poor picture, you must set the "Blue Screen" mode to "Off".



- 1 Press the MENU button.  
Press the ▲ or ▼ button to select "Setup", then press the ENTER button.

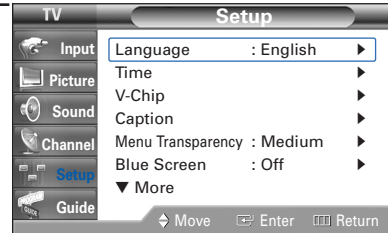

- 2 Press the ▲ or ▼ button to select "Blue Screen", then press the ENTER button.

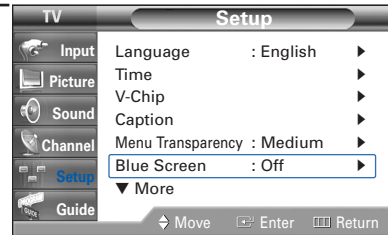

- 3 Press the ▲ or ▼ button to select "On" or "Off", then press the ENTER button.  
Press the EXIT button to exit.

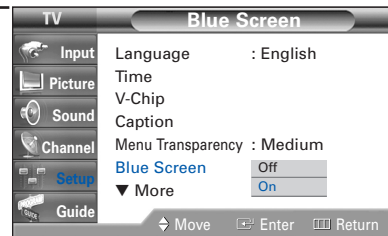



# Sound Control



# Sound Control

## Sound Control

You can control and customize the sound levels and settings of the TV with the remote control.



### Adjusting the Volume

Press the VOL+ or VOL- buttons to increase or decrease the volume.

### Using the MUTE Button

At any time, you can temporarily cut off the sound. Press the MUTE button on the remote control. The message "Mute" is displayed and the sound cuts off.

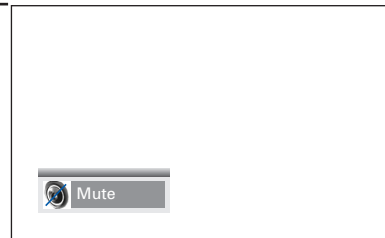

To turn mute off, press the MUTE button again or press either the VOL+ or VOL- button.

### Customizing the Sound

The sound settings can be adjusted to suit your personal preference. (Alternatively, you can use one of the automatic settings. See next page.)

- 1 Press the MENU button. Press the ▲ or ▼ button to select "Sound", then press the ENTER button.

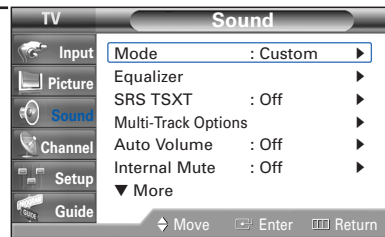

- 2 Press the ▲ or ▼ button to select "Equalizer", then press the ENTER button.

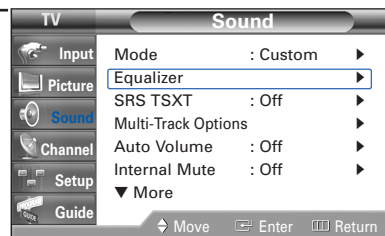

Continued...

- 3 Press the ◀ or ▶ button to select a particular item to be changed. Press the ▲ or ▼ button to increase or decrease the selected frequency.

Press the EXIT button to exit.

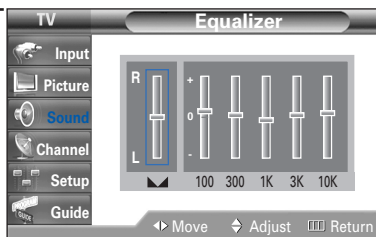

### Using Automatic Sound Settings

Your TV has automatic sound settings ("Standard", "Music", "Movie", and "Speech") that are preset at the factory. You can select "Custom", which automatically recalls your personalized sound settings.

- 1 Press the MENU button. Press the ▲ or ▼ button to select "Sound", then press the ENTER button.

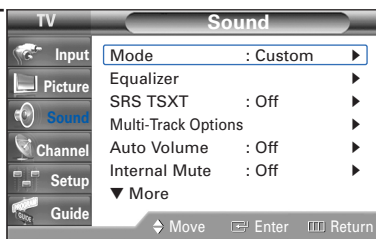

- 2 Press the ENTER button to select "Mode". Press the ▲ or ▼ button to select a particular item, then press the ENTER button.

Press the EXIT button to exit.

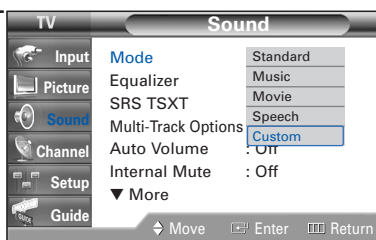

- Choose "Standard" for the standard factory settings.
- Choose "Music" when watching music videos or concerts.
- Choose "Movie" when watching movies.
- Choose "Speech" when watching a show that is mostly dialog (i.e., news).
- Choose "Custom" to recall your personalized settings.

# Sound Control

## Setting the SRS TSXT

TruSurround XT is a patented SRS technology that solves the problem of playing 5.1 multichannel content over two speakers. Trusurround delivers a compelling, virtual surround sound experience through any two-speaker playback system, including internal television speakers. It is fully compatible with all multichannel formats.



- 1 Press the MENU button. Press the ▲ or ▼ button to select "Sound", then press the ENTER button.

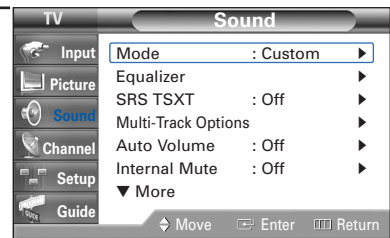

- 2 Press the ▲ or ▼ button to select "SRS TSXT", then press the ENTER button.

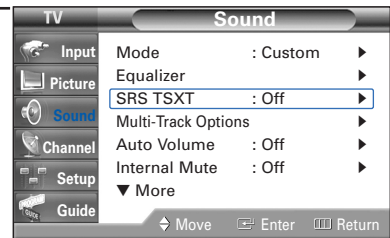

- 3 Press the ▲ or ▼ button to select "Off", "3D Mono" or "Stereo", then press the ENTER button.

Press the EXIT button to exit.

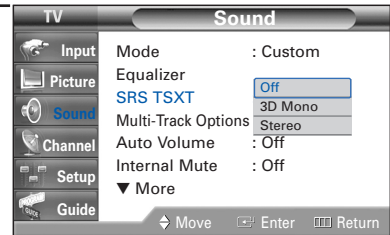

## Auto Volume

Each broadcasting station has its own signal conditions, and it is inconvenient to adjust the volume every time the channel is changed. "Auto Volume" automatically adjusts the volume of the desired channel by lowering the sound output when the modulation signal is high or by raising the sound output when the modulation signal is low.



- 1 Press the MENU button.  
Press the ▲ or ▼ button to select "Sound", then press the ENTER button.

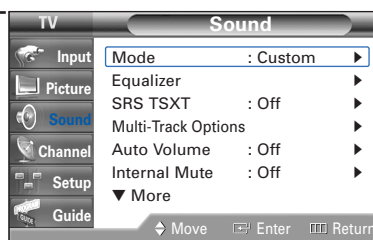

- 2 Press the ▲ or ▼ button to select "Auto Volume", then press the ENTER button.

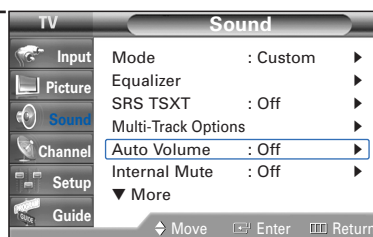

- 3 Press the ▲ or ▼ button to select "Off" or "On", then press the ENTER button.  
  
Press the EXIT button to exit.

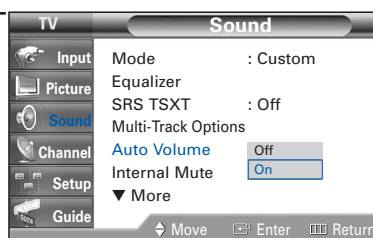

# Sound Control

## Choosing a Multi-Channel Sound (MTS) track Digital

The digital-TV transmission system is capable of simultaneous transmission of many audio tracks (for example, simultaneous translations of the program into foreign languages). The availability of these additional "multitracks" depends upon the program.



- 1 Press the MENU button. Press the ▲ or ▼ button to select "Sound", then press the ENTER button.
  - Quick way to access the MTS menu: Just press the "MTS" button on the remote control. You can listen in a language other than the favorite language by pressing the MTS button.

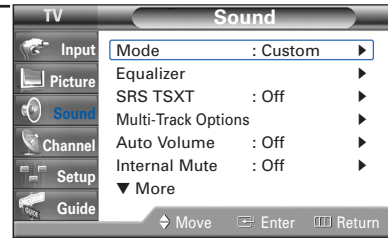

- 2 Press the ▲ or ▼ button to select "Multi-Track Options", then press the ENTER button.
  - The text at the bottom of the menu tells you if the incoming audio is Spanish, French or English.

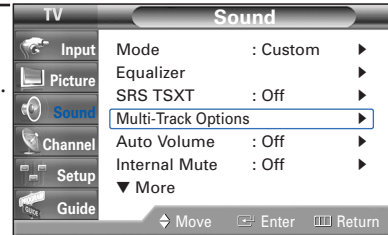

- 3 Press the ENTER button to select "Preferred Language". Press the ▲ or ▼ button to choose the language (English, Español or Français) you want, then press the ENTER button.

Press the EXIT button to exit.

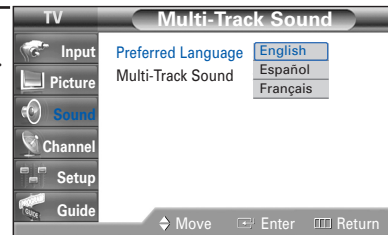

## Choosing a Multi-Channel Sound (MTS) track Analog

Depending on the particular program being broadcast, you can listen to Mono, Stereo or SAP.



- 1 Press the MENU button. Press the ▲ or ▼ button to select "Sound", then press the ENTER button.

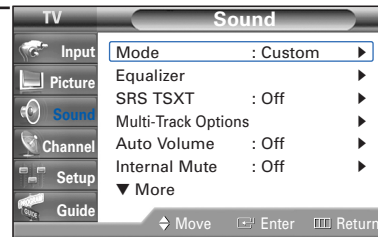

- 2 Press the ▲ or ▼ button to select "Multi-Track Options", then press the ENTER button.

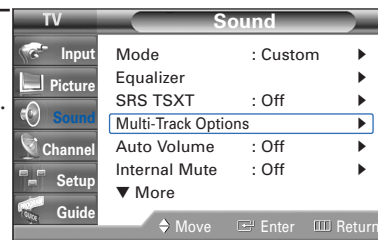

- 3 Press the ▲ or ▼ button to select "Multi-Track Sound", then press the ENTER button. Press the ▲ or ▼ button to select a setting you want, then press the ENTER button.

Press the EXIT button to exit.

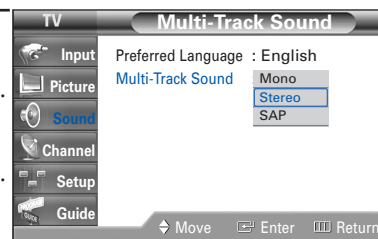

### Alternate method

Press the MTS button on the remote control repeatedly to select an external signal source.

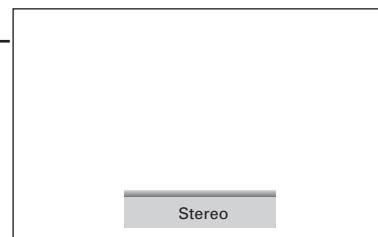

### NOTES

- Choose "Mono" for channels that are broadcasting in mono, or if you are having difficulty receiving a stereo signal.
- Choose "Stereo" for channels that are broadcasting in stereo.
- Choose "SAP" to listen to the Separate Audio Program, which is usually a foreign-language translation.

# Sound Control

## Choosing a Digital Sound Format Digital

Digital sound can be output from the rear-panel connector on your TV. The digital sound output is optical connector labeled "Optical Out". After connecting an optical digital-audio component, you must specify the transmission format (Dolby or PCM, as appropriate to your digital audio component). See the owner's manual of your Digital Audio component for further information.



- 1 Press the MENU button. Press the ▲ or ▼ button to select "Sound", then press the ENTER button.

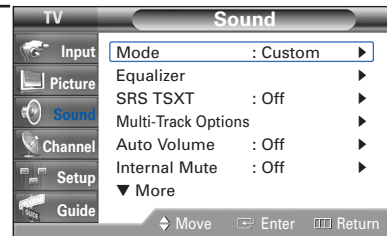

- 2 Press the ▲ or ▼ button to select "Digital Output", then press the ENTER button. Press the ▲ or ▼ button to select "Dolby Digital" or "PCM", then press the ENTER button.

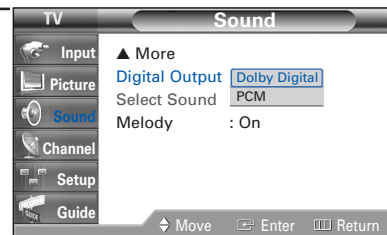

Press the EXIT button to exit.

Manufactured under license from Dolby Laboratories.  
"Dolby" and the double D-symbol are trademarks of Dolby Laboratories.

## Selecting the Internal Mute

When using a device such as a Home Theater or Amplifier with external speakers, you can set Internal Mute to On to cut off sound from the TV's internal speakers



1 Press the MENU button. Press the ▲ or ▼ button to select "Sound", then press the ENTER button.

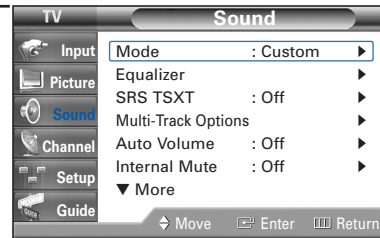

2 Press the ▲ or ▼ button to select "Internal Mute", then press the ENTER button.

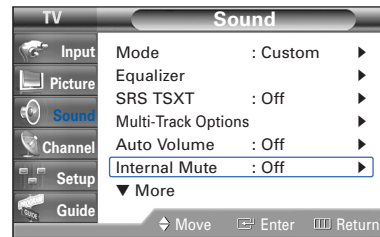

3 Press the ▲ or ▼ button to select "On", then press the ENTER button. Pressing the ▲ or ▼ button will alternate between "On" and "Off".

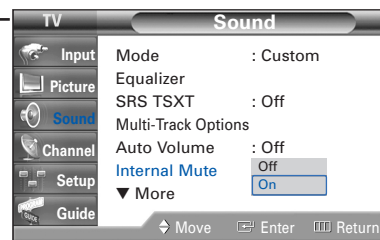

Press the EXIT button to exit.

### NOTES

- The VOL +, VOL - and Mute buttons do not operate when the Internal Mute is set to On.
- When Internal Mute is on, only Multi-Track Options and Melody menu are available.



# Sound Control

## Setting the On/Off Melody

A melody sound can be set to come on when the TV is powered On or Off.



- 1 Press the MENU button. Press the ▲ or ▼ button to select "Sound", then press the ENTER button.

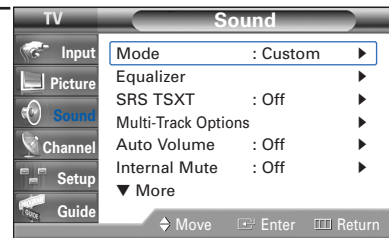

- 2 Press the ▲ or ▼ button to select "Melody", then press the ENTER button. Press the ▲ or ▼ button to select "On" or "Off", then press the ENTER button.

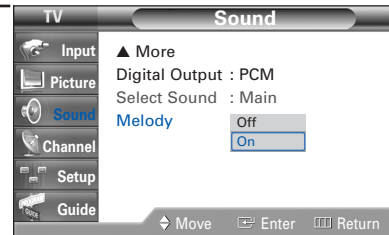

Press the EXIT button to exit.



# Special Features



# Special Features

## Setting the Function Help

Displays Help on the menu functions.

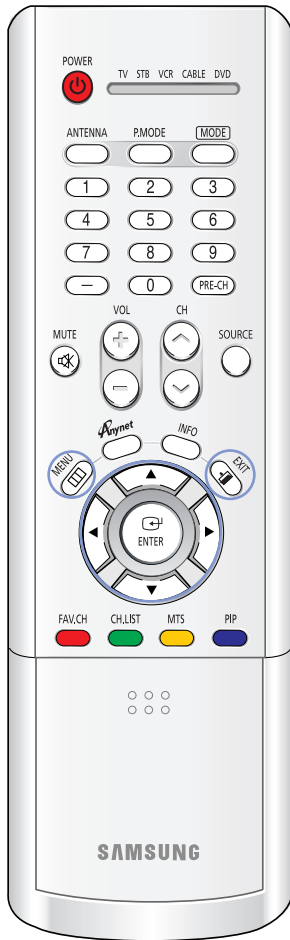

- 1 Press the MENU button. Press the ▲ or ▼ button to select "Setup", then press the ENTER button.

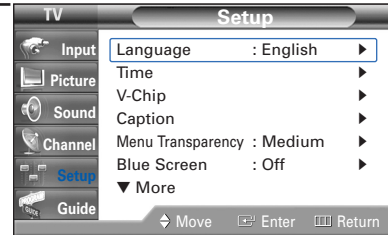

- 2 Press the ▲ or ▼ button to select "Function Help", then press the ENTER button.

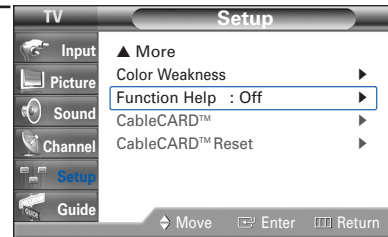

- 3 Press the ▲ or ▼ button to select "On", then press the ENTER button.  
Press the EXIT button to exit.

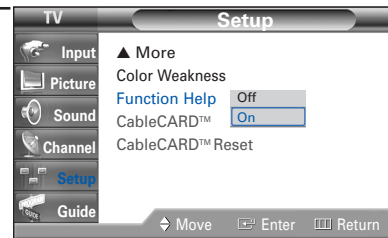

Activates Function Help. Provides references for each menu item.

## Menu Transparency Level

Adjusts the transparency of the menu screen.



- 1 Press the MENU button. Press the ▲ or ▼ button to select "Setup", then press the ENTER button.

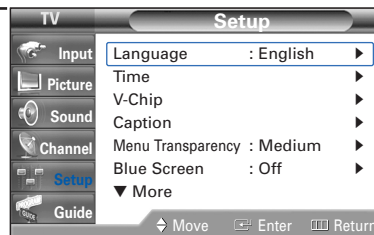

- 2 Press the ▲ or ▼ button to select "Menu Transparency", then press the ENTER button. Press the ▲ or ▼ button to select level, then press the ENTER button.

Press the EXIT button to exit.

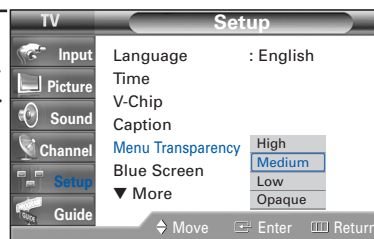

# Special Features

## Using the V-Chip

Access to channels and programs is controlled by a password (i.e., a 4-digit secret code that is defined by the user). The on-screen menu will instruct you to assign a password (you can change it later, if necessary).



### How to Change Your Password

1 Press the MENU button. Press the ▲ or ▼ button to select "Setup", then press the ENTER button. Press the ▲ or ▼ button to select "V-Chip", then press the ENTER button.

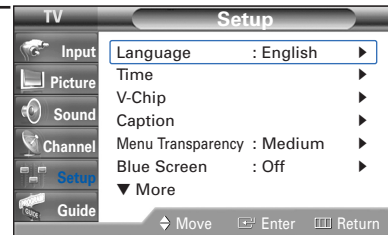

2 Press the number buttons to enter your current 4-digit pin number. (The default pin number for a new TV set is "0000".) The "V-Chip" menu is displayed.

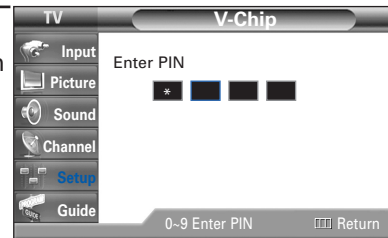

3 Press the ▲ or ▼ button to select "Change PIN", then press the ENTER button.

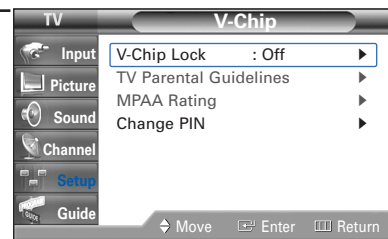

4 Press the number buttons to enter your new 4-digit pin number. Re-enter your new pin number to confirm.

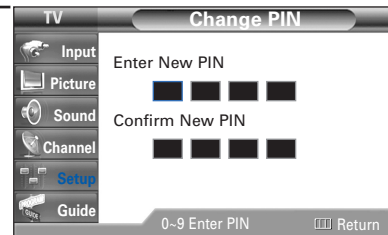

Press the EXIT button to exit.

### NOTES

- The V-Chip doesn't function when the PIP is active.
- If you forget the pin number, press the remote control buttons in the following sequence, which resets the pin to 0-0-0-0: POWER (Off), MUTE, 8, 2, 4, POWER (On).
- The V-Chip function only works in RF ,AV mode and S-Video mode.

## How to Enable/Disable the Rating Controls



- 1 Press the MENU button.  
Press the ▲ or ▼ button to select "Setup", then press the ENTER button.  
Press the ▲ or ▼ button to select "V-Chip", then press the ENTER button.

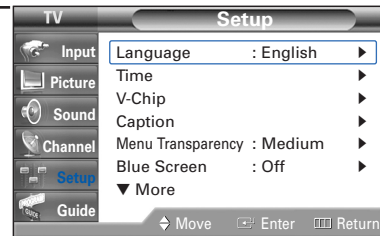

- 2 Press the number buttons to enter your current 4-digit pin number.  
(The default pin number for a new TV set is "0000".)  
The "V-Chip" menu is displayed.

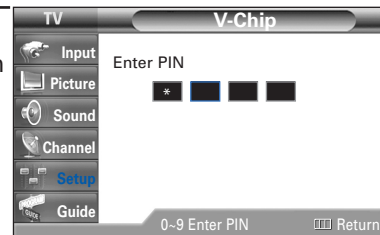

- 3 Press the ENTER button to select "V-Chip Lock".  
Press the ▲ or ▼ button to select "On", then press the ENTER button.

Press the EXIT button to exit.

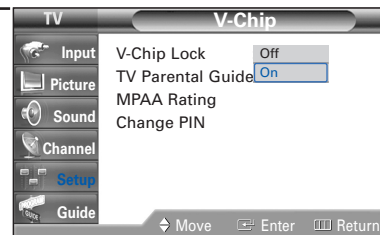

# Special Features

## How to Set up Restrictions Using the "TV Parental Guidelines"

The parental restrictions can be set up using either of two methods: The "TV Parental Guidelines" or "MPAA Rating".

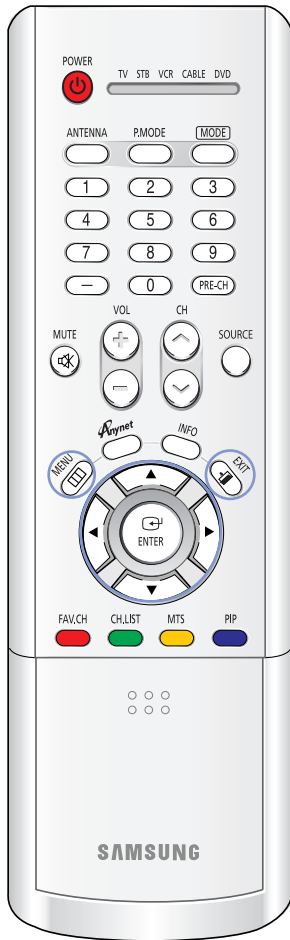

- 1 Press the MENU button. Press the ▲ or ▼ button to select "Setup", then press the ENTER button. Press the ▲ or ▼ button to select "V-Chip", then press the ENTER button.

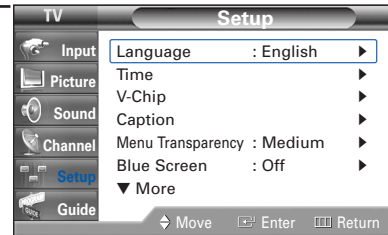



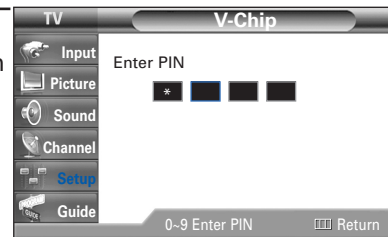

- 2 Press the number buttons to enter your current 4-digit pin number. (The default pin number for a new TV set is "0000".) The "V-Chip" menu is displayed.

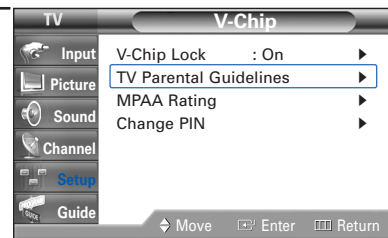

- 3 Press the ▲ or ▼ button to select "TV Parental Guidelines", then press the ENTER button.



4 You can independently lock the TV ratings. The locked TV (FCC) ratings are indicated by the symbol “”. Press the /// buttons and the ENTER button to activate the appropriate restrictions for TV (FCC) rating system.

TV-Y : Young children  
TV-Y7 : Children 7 and over  
TV-G : General audience  
TV-PG : Parent Guidance  
TV-14 : Viewers 14 and over  
TV-MA : Mature Audience

Press the EXIT button to exit.

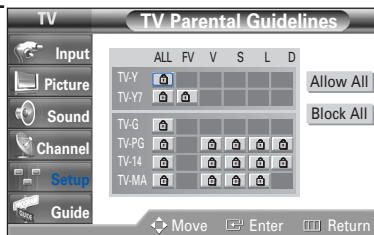

#### NOTE

- *Allow All* : Press to unlock all TV ratings.
- *Block All* : Press to lock all TV ratings.

#### NOTES

- *These categories consist of two separate groups: “TV-Y” and “TV-Y7” (young children through age 7), and “TV-G” through “TV-MA” (everybody else).*
- *The restrictions for these two groups work independently: If a household includes very young children as well as young adults, the TV parental guidelines must be set up separately for each age group. (See page 89.)*



# Special Features

## How to Set up Restrictions Using the "MPAA Rating"

The Movie rating system uses the "MPAA" (Motion Picture Association of America) system, and its main application is for movies.

When the rating control is on, the TV will automatically block any programs that are coded with objectionable ratings (either "MPAA Rating" or "TV Parental Guidelines").



- 1 Press the MENU button. Press the ▲ or ▼ button to select "Setup", then press the ENTER button. Press the ▲ or ▼ button to select "V-Chip", then press the ENTER button.

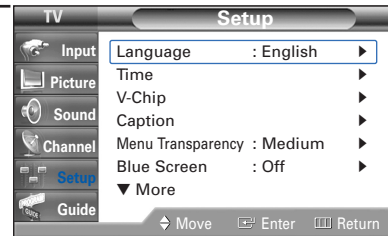

- 2 Press the number buttons to enter your current 4-digit pin number. (The default pin number for a new TV set is "0000".) The "V-Chip" menu is displayed.

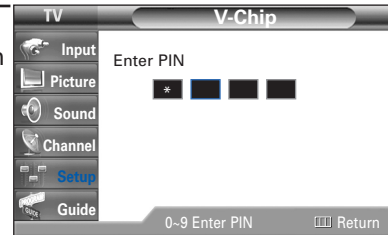

- 3 Press the ▲ or ▼ button to select "MPAA Rating", then press the ENTER button.

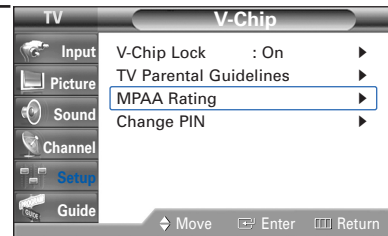

- 4 You can independently lock the movie ratings. The locked movie ratings are indicated by the symbol "🔒". Press the ▲/▼/ENTER buttons to activate the appropriate restrictions for movie rating system.

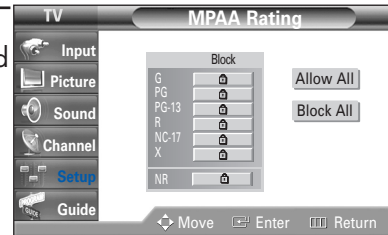

Press the EXIT button.

### NOTE

- Allow All : Press to unlock all movie ratings.
- Block All : Press to lock all movie ratings.

## Important Notes About Parental Locks

Explanation of the MPAA and TV (FCC) Rating Systems:

### TV (FCC) Age-Based Ratings

#### TV-MA

Mature audiences only. This program may contain mature themes, profane language, graphic violence and explicit sexual content.

#### TV-14

Parents strongly cautioned. This program may contain sophisticated themes, sexual content, strong language and more intense violence.

#### TV-PG

Parental guidance suggested. The program may contain infrequent coarse language, limited violence, some suggestive sexual dialog and situations.

#### TV-G

General audience. It contains little or no violence, no strong language, and little or no sexual dialog or situations.

#### TV-Y7

Directed to older children. Themes and elements in this program may include mild physical or comedic violence, or may frighten children under the age of seven.

#### TV-Y

All children. The themes and elements in this program are specifically designed for a very young audience, including children from ages two – six.

### TV (FCC) Content Category

<b>V</b>	Violence.
<b>S</b>	Sexual content.
<b>L</b>	Offensive language.
<b>D</b>	Dialog sexual innuendo.
<b>FV</b>	Fantasy or cartoon violence.

### MPAA Rating System (Movies)

<b>G</b>	General audience. No restriction.
<b>PG</b>	Children under 13 should be accompanied by an adult.
<b>PG-13</b>	Parental guidance suggested. Children under 13 should be accompanied by an adult.
<b>R</b>	Restricted. Viewers should be 17 or older.
<b>NC-17</b>	Not classified. Viewers should be 17 or older.
<b>X</b>	Adults only.
<b>NR</b>	Not rated.

- TV (FCC) ratings : The particular rating that you have selected will be locked (and indicated as a red "L" on a blue background). Also, all of the age-based ratings will be locked within the particular group (i.e., "group 1" or "group 2"). Suppose that the TV-G rating and all of its contents (V, S, L, and D) are locked. In that case, more restrictive ratings (TV-PG, TV-14, and TV-MA) and all of their contents (V, S, L, and D) are automatically locked as well.
- MPAA ratings : The particular rating that you have selected will be locked. In addition, more restrictive ratings will be locked as well.
- Neither TV (FCC) ratings nor MPAA ratings apply to news programs.

# Special Features

## Viewing Closed Captions (On-Screen Text Messages) **Analog**

The Analog Caption function operates in either analog RF channel mode or external signal mode. (Depending on the broadcasting signal, the Analog Caption function may operate on digital channels.)



1 Press the MENU button. Press the ▲ or ▼ button to select "Setup", then press the ENTER button.

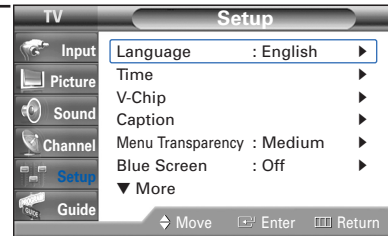

2 Press the ▲ or ▼ button to select "Caption", then press the ENTER button.

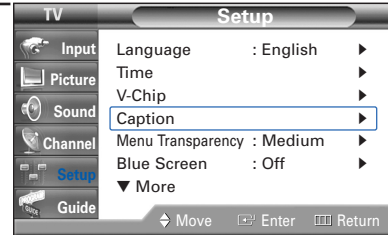

3 Press the ENTER button to select "Caption".

Press the ▲ or ▼ button to select "On", then press the ENTER button.

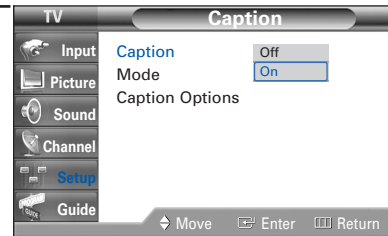

- 4 Press the ▲ or ▼ button to select “Mode”, then press the ENTER button. Press the ▲ or ▼ button to select submenu (CC1~CC4 or Text1~Text4) you want, then press the ENTER button.

Press the EXIT button to exit.

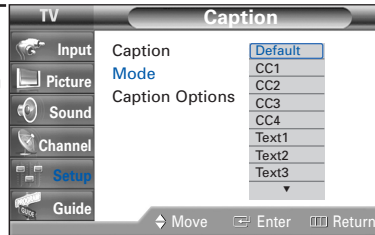

## NOTES

- The default is “CC1”.
- *CC1 : The Primary Synchronous Caption Service. These are captions in the primary language that must be in sync with the sound, preferably matched to a specific frame.*
- *CC2 : The Special NonSynchronous Use Captions. This channel carries data that is intended to augment information carried in the program.*
- *CC3 : Secondary Synchronous Caption Service. Alternate program-related caption data, typically second language captions.*
- *CC4 : Special Non-Synchronous Use Captions. Similar to CC2.*
- *Text1 : First Text Service. This may be various non-program related data.*
- *Text2 : Second Text Service. Additional data, usually not program related.*
- *Text3/Text4 : Third and Fourth Text Services. These data channels should be used only if Text1 and Text2.*
- The Caption feature only works in RF, AV and S-Video mode.
- The availability of captions depends on the program being broadcast.

# Special Features

## Viewing Closed Captions (On-Screen Text Messages) Digital

The Digital Captions function operates on digital channels.

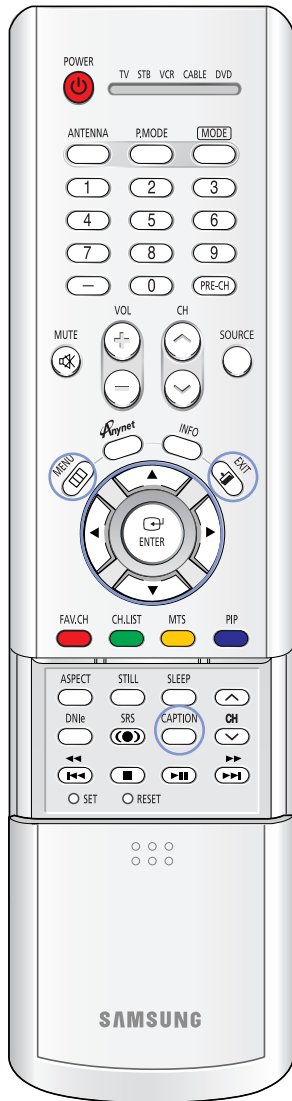

### NOTE

- "Caption Option" are available only when "Service1 ~ Service6" can be selected in "Mode".

1 Press the MENU button. Press the ▲ or ▼ button to select "Setup", then press the ENTER button.

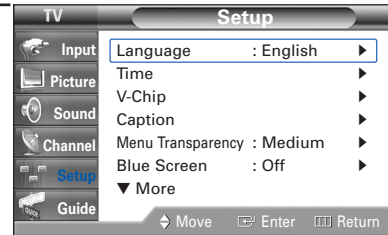

2 Press the ▲ or ▼ button to select "Caption", then press the ENTER button.

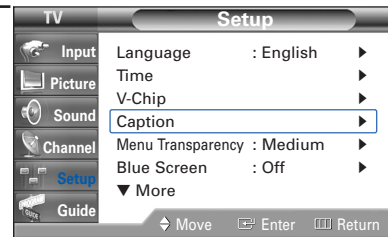

3 Press the ENTER button to select "Caption".

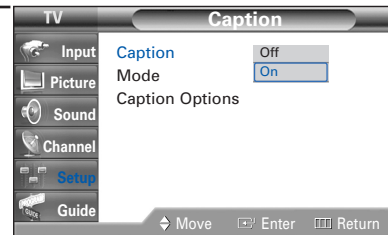

Press the ▲ or ▼ button to select "On", then press the ENTER button.

4 Press the ▲ or ▼ button to select "Mode", then press the ENTER button. Press the ▲ or ▼ button to select submenu (Service1 ~ Service6, CC1 ~ CC4 or Text1 ~ Text4) you want, then press the ENTER button.

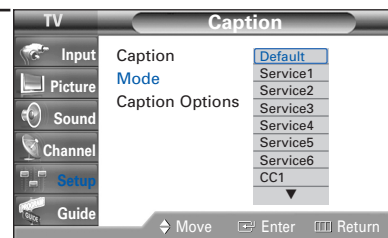

5 Press the ▲ or ▼ button to select "Caption Options", then press the ENTER button.

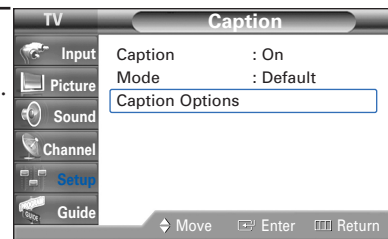

- 6 Press the ▲ or ▼ button to select "Size", then press the ENTER button. Press the ▲ or ▼ button to select one you want, then press the ENTER button. Set other listed options below using the same method as above. Press the EXIT button to exit.

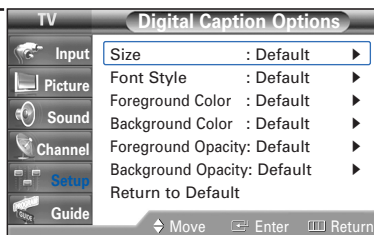

## NOTES

- The availability of captions depends on the program being broadcast.
- The "default" means to follow the rule of broadcasting.

### Size

This option consists of "Default", "Small", "Standard", and "Large". The default is "Standard".

### Font Style

This option consists of "Default", "Style0 ~ Style 7". You can change the font you want. The default is "Style 0".

### Foreground Color

This option consists of "Default", "White", "Black", "Red", "Green", "Blue", "Yellow", "Magenta", and "Cyan". You can change the color of the letter. The default is "White".

### Background Color

This option consists of "Default", "White", "Black", "Red", "Green", "Blue", "Yellow", "Magenta", and "Cyan". You can change the background color of the caption. The default is "Black".

### Foreground Opacity

This option consists of "Default", "Transparent", "Translucent", "Solid", and "Flashing". You can change the opacity of the letter.

### Background Opacity

This option consists of "Default", "Transparent", "Translucent", "Solid", and "Flashing". You can change the background opacity of the caption.

### Return to Default

This option sets each of "Size", "Font Style", "Foreground Color", "Background Color", "Foreground Opacity", and "Background Opacity" Color to its default.

## Alternate method

Press the CAPTION button on the remote control repeatedly to select "On" or "Off".

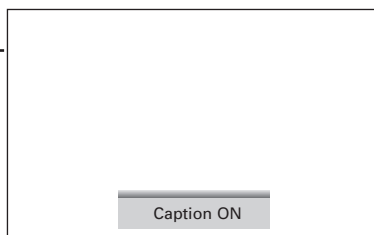

# Special Features

## Using the CableCARD

This menu works with a CableCARD provided by a local cable service provider. Prior to accessing this menu, a CableCARD should be connected to the rear panel of the TV. For detailed connection instructions refer to the "Connecting CableCARD" section on page 24 of this manual.

### Displaying CableCARD related information

To access information on Status, Pairing, Network Setup of the CableCARD provided by the service provider in CableCARD menu.

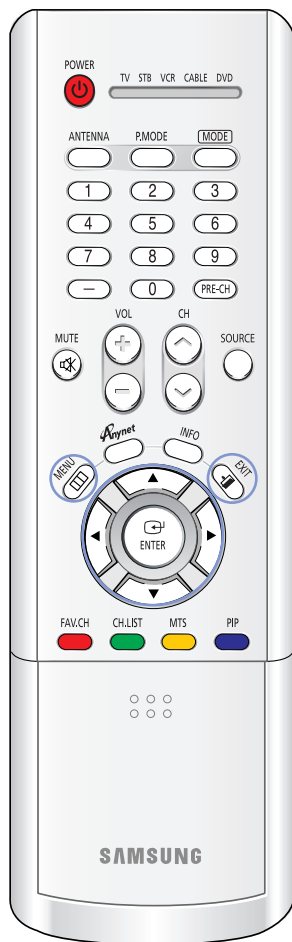

- 1 Press the MENU button. Press the ▲ or ▼ button to select "Setup", then press the ENTER button.

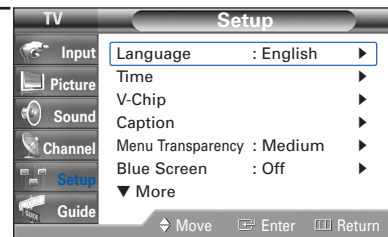

- 2 Press the ▲ or ▼ button to select "CableCARD™", then press the ENTER button.

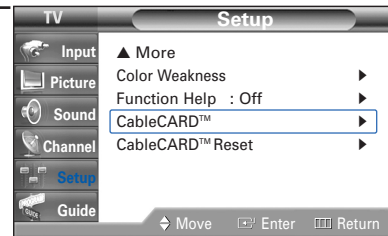

- 3 Press the EXIT button to exit.

## Using the CableCARD Reset Function

Sets up relevant CableCARD options.

### CableCARD Reset

Resets CableCARD when the channels provided by CableCARD are not available.

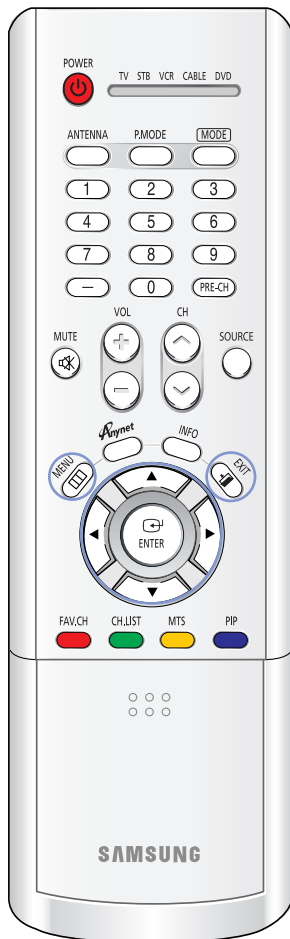

- 1 Press the MENU button. Press the ▲ or ▼ button to select "Setup", then press the ENTER button.

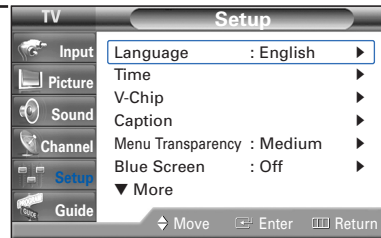

- 2 Press the ▲ or ▼ button to select "CableCARD™ Reset", then press the ENTER button.

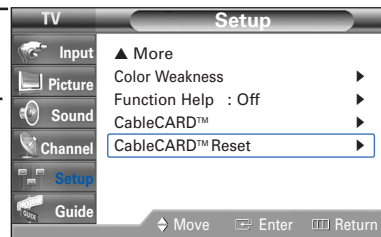

- 3 Press the ENTER button to select "Card Reset".

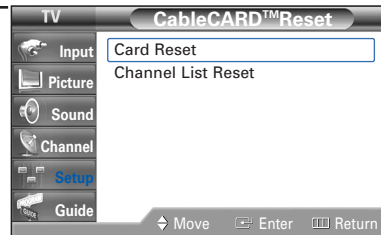



# Special Features

## Channel List Reset

Deletes and reorganizes the channel list provided by CableCARD.

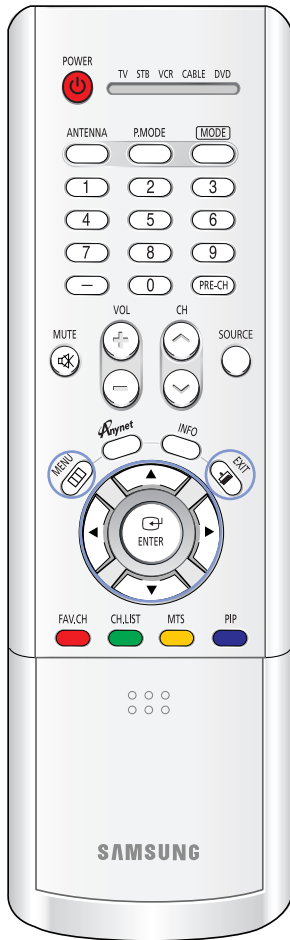

- 1 Press the MENU button. Press the ▲ or ▼ button to select "Setup", then press the ENTER button.

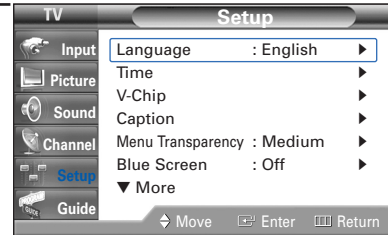

- 2 Press the ▲ or ▼ button to select "CableCARD™ Reset", then press the ENTER button.

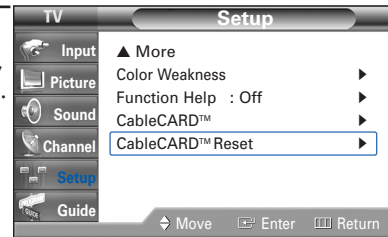

- 3 Press the ENTER button to select "Channel List Reset".

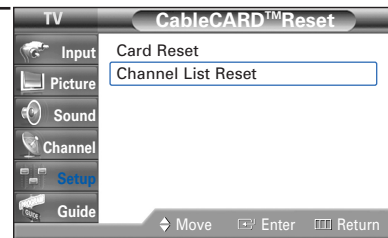

# Using the Guide

## How to Enable/Disable the Rating Controls

You can display a list of all channels or your favorite channels.



- 1 Press the MENU button. Press the ▲ or ▼ button to select "Guide", then press the ENTER button.

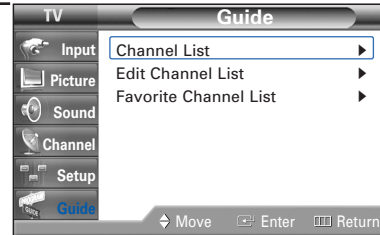

- 2 Press the ▲ or ▼ button to select "Channel List" or "Favorite Channel List", then press the ENTER button.

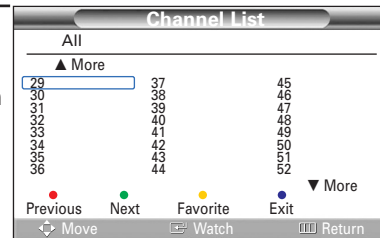

To toggle between your favorite channels or all channels, use the Yellow button.

- Red button: Press to display the previous channel list page.  
Green button: Press to display the next channel list page.  
Yellow button: Press to toggle between your favorite channels or all channels.  
Blue or EXIT button: Press to exit.

## Alternate method

Press the CH.LIST button on the remote control to display a list of channels.

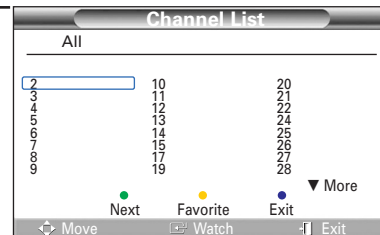

# Special Features

## Adding and Erasing Channels



1 Press the MENU button. Press the ▲ or ▼ button to select "Guide", then press the ENTER button.

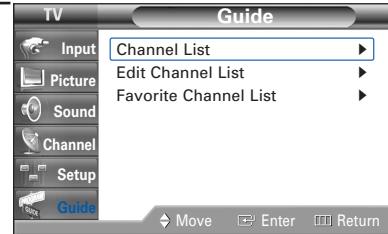

2 Press the ▲ or ▼ button to select "Edit Channel List", then press the ENTER button.

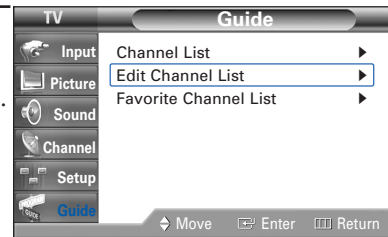

3 Press the ▲ or ▼ button to change channels you want to add or delete. Repeatedly pressing ENTER button will alternate between "Add" and "Delete".

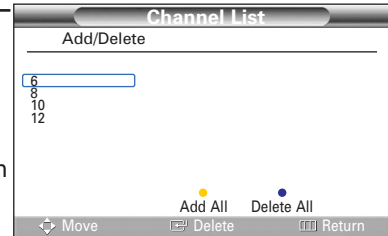

- Yellow button : Press to add all channels
- Blue button : Press to delete all channels

4 Press the MENU button to exit.

# Appendix

# Appendix

## Troubleshooting

If the TV seems to have a problem, first try this list of possible problems and solutions. If none of these troubleshooting tips apply, then call your nearest service center.

<b>Problem</b>	<b>Possible Solution</b>
Poor picture quality.	Try another channel. Adjust the antenna. Check all wire connections.
Poor sound quality.	Try another channel. Adjust the antenna. Make sure the MUTE button is off.
No picture or sound.	Try another channel. Press the SOURCE button. Make sure the TV is plugged in. Check the antenna connections.
No color, wrong colors or tints.	Make sure the program is broadcasted in color. Adjust the picture settings.
Picture rolls vertically.	Adjust the antenna. Check all wire connections. If you are using a VCR, check the tracking.
The TV operates erratically.	Unplug the TV for 30 seconds, then try operating it again.
Your remote control does not operate your TV.	Press the MODE button to put your remote control into TV mode. Make sure the remote has batteries.
The TV won't switch on.	Make sure the wall outlet is working. Make sure the TV is plugged in. Make sure the remote has batteries.
Digital broadcasting screen problem.	Please check the digital signal strength and input antenna.

- The display panel used for the DLP TV is composed of many tiny pixels. These pixels may occasionally appear on the screen.

## Cleaning and Maintaining Your TV

With proper care, your TV will give you many years of service. Please follow these guidelines to get the maximum performance from your TV.

### Placement

- Do not put the TV near extremely hot, cold, humid or dusty places.
- Do not place the TV near appliances with electric motors that create magnetic fields, such as vacuum cleaners.
- Keep the ventilation openings clear; do not place the TV on a soft surface, such as cloth or paper.
- Place the TV in a vertical position only.

### Liquids

- Do not handle liquids near or on the TV. Liquids that spill into it can cause serious damage.

### Cabinet

- Never open the cabinet or touch the parts inside.
- Wipe your TV with a clean, dry cloth. Never use water, cleaning fluids, wax, or chemicals.
- Do not put heavy objects on top of the cabinet.
- This DLP TV projects the image onto a large screen by applying an optical system. If you place the TV set face down, it might cause a problem because dirt, or some other contaminant may become attached to the inside of the TV set.

### Temperature

- If your TV is suddenly moved from a cold to a warm place, unplug the power cord, and allow at least two hours for moisture that may have formed inside the unit to dry completely.

## Using Your TV in Another Country

If you plan to take your TV with you to a foreign country, please be aware of the different television systems that are in use around the world. A TV designed for one system may not work properly with another system due to differences in the TV channel frequencies.

## Specifications

Model	HLP4667W	HLP5067W	HLP5667W	HLP6167W
Voltage	AC 120V	AC 120V	AC 120V	AC 120V
Frequency of Operation	60Hz	60Hz	60Hz	60Hz
Power Consumption	230 watts	230 watts	230 watts	230 watts
Dimension (W x D x H)	43.07 x 13.35 x 32.05 inches 1094 x 339 x 814 mm	46.54 x 14.13 x 34.25 inches 1182 x 359 x 870 mm	52.36 x 15.59 x 37.89 inches 1330 x 396 x 962.5 mm	56.93 x 18.27 x 41.65 inches 1446 x 464 x 1058 mm
Weight	32.5 Kg / 71.65 lbs	36 Kg / 79.37 lbs	42.5 Kg / 93.70 lbs	49 Kg / 108.02 lbs

**SAMSUNG**

DLPTV

**1-800-SAMSUNG (1-800-726-7864)**

**Samsung Electronics America  
Service Division**

400 Valley Road, Suite 201  
Mount Arlington, NJ 07856  
[www.samsungusa.com](http://www.samsungusa.com)

**Samsung Electronics Canada Inc.  
Samsung Customer Care**

7037 Financial Drive  
Mississauga, Ontario  
L5N 6R3  
[www.samsung.ca](http://www.samsung.ca)